

Miele

Reliable cleaning performance each and every day
The PLW 8505 undercounter lab washer

Miele Professional. Immer Besser.





Consistently reliable

How we guarantee good results

Robust and dependable, the new PLW 8505 lab washer offers durability, convincing cleaning results and reliability for your lab. The modern design and simple user interface makes it easy to operate in the hustle and bustle of daily life in the laboratory or classroom. For smooth operation and thorough cleaning results - day in and day out, the PLW 8505 is unsurpassed.



Convenient and flexible loading and unloading

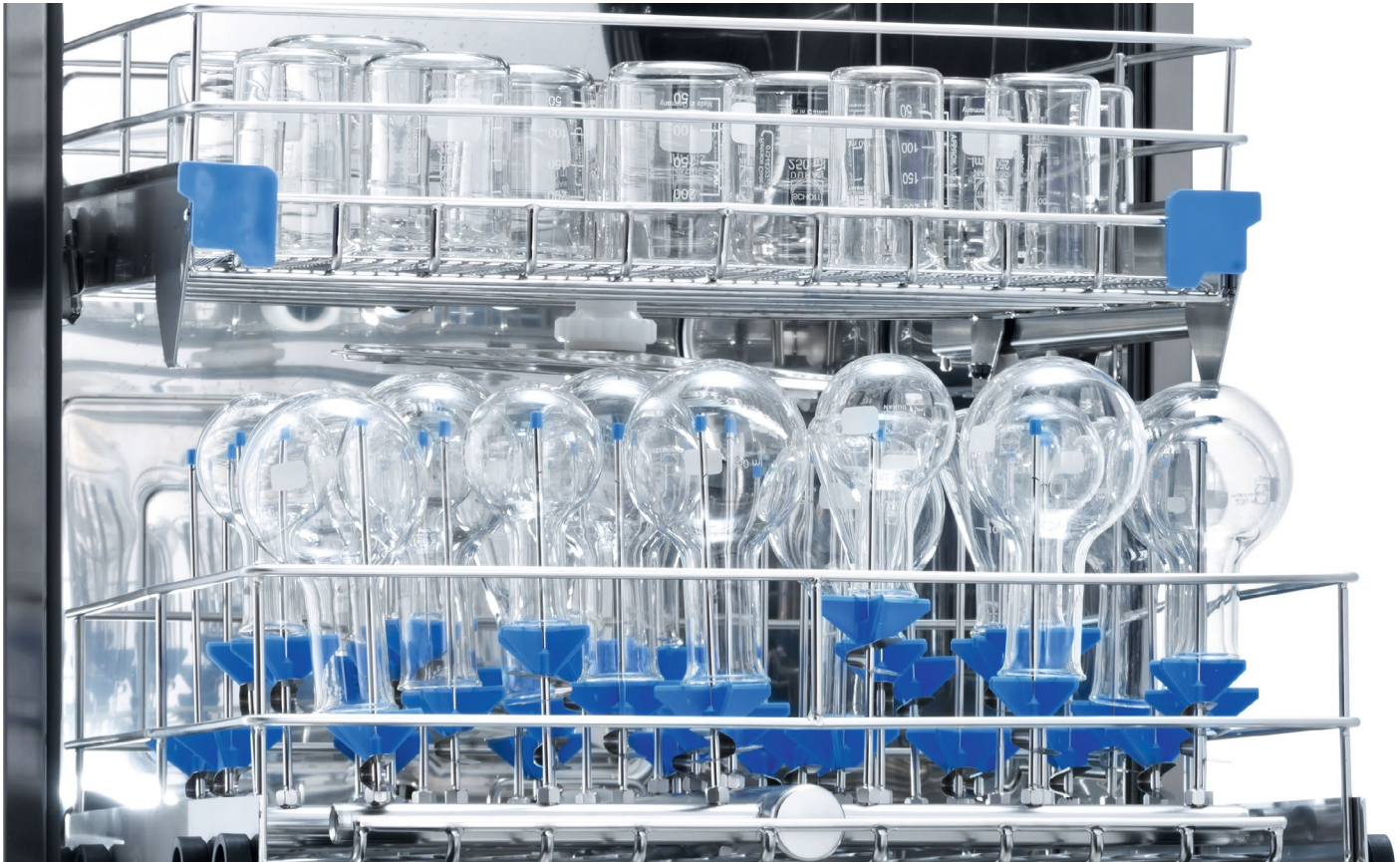

The flexibility of the chamber design makes the new PLW 8505 lab washer ideal for laboratory glassware washing needs of classroom laboratories in schools as well as water treatment plants and offers an excellent solution for any lab currently washing by hand.

The sturdy drop down door features a glass window which allows observation of the wash chamber when in operation and is easy to keep clean and shiny.

Two rotating spray arms made from stainless steel ensure thorough coverage and cleaning items both from above and below. The convenient removal of spray arms also makes for simple cleaning and maintenance if needed.

There are multiple basket set ups that can be used in this labwasher. Two level injection, two level for glasswares, funnels and beakers, a mixture of lower level injection and upper glasswares or low level injection only. All baskets must be ordered separately.

Overview of further product benefits

PLW 8505



Intelligent controls

- Controls with flush, uninterrupted touch glass screen
- All information visible at a glance with 3.5" display
- Programs which cover most basic cleaning requirements
- Simple and effective cleaning



Hygienic chamber

- Chamber, spray arms and filters are made from high-grade stainless steel (DIN 1.4404/AISI 316L)
- Two independent levels for high wash performance
- Simple cleaning and maintenance with easy to remove spray arms



Full-glass door

- Enables visual observation of wash cycle
- Integrated chamber lighting
- Automatic door lock



Versatile loading system

- Lower and upper injector baskets
- Lower and upper beaker baskets
- Easily removable optional upper basket sits on telescopic runners which allow loads to be pulled clear of the casing

The undercounter lab washer

PLW 8505



PLW 8505 undercounter lab washer

Labwasher Height x Width x Depth [mm(in)]	850 (33 7/16) x 600 (23 5/8) x 630 (24 13/16)
Usable wash cabinet HxWxD [mm(in)]	650 (25 9/16) x 535 (21 1/16) x 495 (19 1/2)
Usable chamber volume [L(cu.ft)]	151 (5.33)
Load concept	Rack system with max. 2 levels
Programs	9 program positions
Program selection	Touch on Glass
Load capacity	Two levels: up to 75 injectors

Features

- All-glass bottom-hinged door
- Electric heating
- Hot air drying
- Steam condenser
- 2 integrated dispenser pumps
- Water connections for hot, cold and demineralized water
- Electrical connection AC 115V, 60 Hz

Accessories

PLW 8505

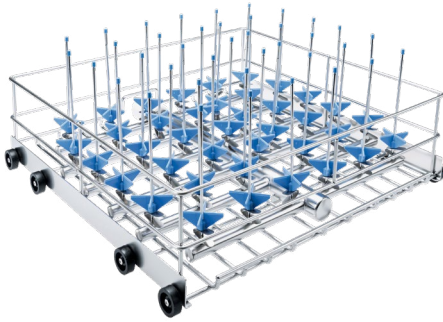

Lower basket APLW 095

- Lower basket with 39 injectors for the cleaning of narrow-necked glassware, such as flasks.
- Vertical clearance with upper basket: approx. 5.9 - 6.5" (150 - 165 mm)
- Vertical clearance without upper basket: approx. 17.32 - 18.11" (440 - 460 mm)
- Must be ordered with separately

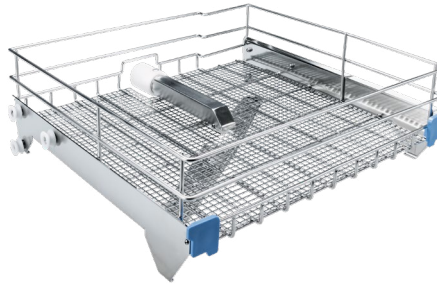

Upper basket APLW 096

- Upper basket for the cleaning of wide-necked glassware, such as beakers, funnels, etc.
- Loading space: 19.09 x 17.72" (485 x 450 mm)
- Vertical clearance approx. 8.66" (220 mm)
- Must be ordered separately

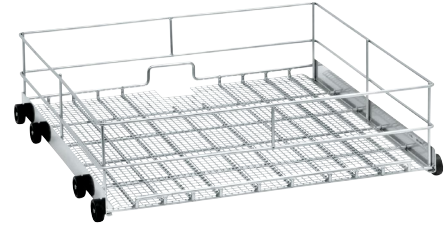

Lower basket APLW 097

- Lower basket for loading various inserts for wide-neck laboratory glassware.
- Useable surface: 490 x 470 mm
- Vertical clearance with upper basket: 180 mm (7 3/32 in)
- Vertical clearance without upper basket: 460 mm (18 1/8 in)
- Suitable for use with upper basket APLW 096 and APLW 098
- Must be ordered separately

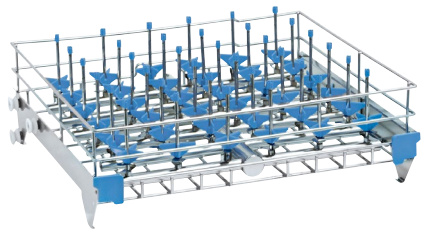

Upper basket APLW 098

- Upper basket with 36 connections for injector nozzles.
- Injector nozzles are not included with the machine
- Vertical clearance: 160 mm (6 5/16 in)
- Suitable for use with lower basket APLW 095
- Must be ordered separately



Injectors APLW 052 and APLW 052/1

- For lower basket APLW 095 and upper basket APLW 098
- Height: 6.89" (175 mm)
- Diameter: 0.16" (4 mm)
- Diameter tip: 0.20" (5 mm)
- Packaging: APLW 052/1 set of 39 injectors
- Must be ordered separately

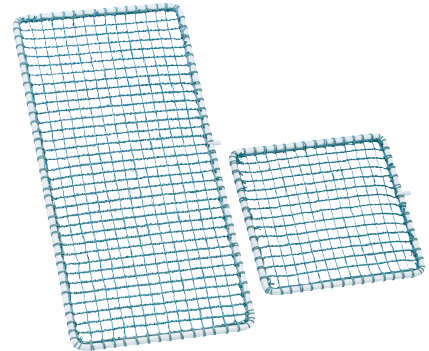

A 2 and A 3 cover net

- Plastic-coated metal frame with plastic netting
- Can be placed on top of the beakers to prevent them from moving around
- A 2: 8.50 x 17.95" (216 x 456 mm)
- A 3: 8.11 x 8.11" (206 x 206 mm)

Suggested Configurations

Convertible modular configurations offer more flexibility

EXAMPLE SET UP 1

Two levels: injections + beakers

- APLW 096 Upper basket
- APLW 095 Lower basket
- APLW 052/1 Set of injectors

EXAMPLE SET UP 2

Two levels: glasswares, beakers

- APLW 096 Upper basket
- APLW 097 Lower basket

For one Level: use lower basket only

EXAMPLE SET UP 3









Two levels: injections only

- APLW 098 Upper basket
- APLW 095 Lower basket
- 2 x APLW 052/1 Set of injectors (Upper and Lower)

For one Level: use lower basket only

Program structure

PLW 8505

Block		Wash	Wash	Wash	Wash	Wash	Wash	Wash	Wash	Wash	Wash	Drying	
Function		Prewash 1	Prewash 2	Main wash 1	Main wash 2	Neutralization 1 Interim rinse 1	Neutralization 2	Interim rinse 2	Interim rinse 3	Interim rinse 4	Final rinse 1	Final rinse 2	Drying
Program	Button												
Short				HW DOS 1 122°F (50°C) 3 Min		HW DOS 3 2 Min						DI 140°F (60°C) 1 Min	
Standard		CW 2 Min		HW DOS 1 140°F (60°C) 3 Min		HW DOS 3 3 Min						DI 140°F (60°C) 1 Min	
Intensive		CW 2 Min		HW DOS 1 140°F (60°C) 3 Min		HW DOS 3 2 Min		HW 1 Min				DI 140°F (60°C) 1 Min	
Analytic		CW 2 Min		HW DOS 1 149°F (65°C) 3 Min		HW DOS 3 1 Min		DI 1 Min				DI 140°F (60°C) 1 Min	
Plastic				HW DOS 1 131°F (55°C) 3 Min		HW DOS 3 2 Min		HW 1 Min				DI 140°F (60°C) 1 Min	
Micro- biology				DI DOS 1 194°F (90°C) 3 Min		DI DOS 3 1 Min		HW 1 Min				DI 167°F (75°C) 1 Min	
Prewash		CW 5 Min											
Customer specific 1)		CW 2 Min		HW DOS 1 122°F (50°C) 3 Min		HW DOS 3 1 Min						DI 140°F (60°C) 1 Min	
Customer specific 2)		CW 2 Min		HW DOS 1 149°F (65°C) 3 Min		HW DOS 3 1 Min		DI 1 Min				DI 140°F (60°C) 1 Min	

CW = Cold water

HW = Hot water

DI = Deionized water

Min = Holding time in minutes

DOS 1 = Detergent

DOS 3 = Neutralizer

) Customizable programs with pre-set values to be adjusted

Laboratory Glassware Washer

PLW 8505

Description	Standard	Metric
ELECTRICAL		
Voltage	115V/1PH+N+GR / 60Hz	115V/1PH+N+GR / 60Hz
Power supply	1.6 kW/ 15A	1.6 kW / 15A
Fuse rating	1 x 20A	1 x 20A
Cable and min.section	3 x AWG 12	3 x AWG 12
COLD WATER		
Connection	¾" male	DN 20
Max flow rate	3.2 gpm	12 lt/min
Min flow pressure	14.5 PSI g	100 kPa
Max pressure	116 PSI g	800 kPa
Max temperature	59°F	15°C
Max hardness	70 ppm CaCO3	7°f
Max conductivity/ph	n.a./7...8 pH	n.a./7...8 pH
WARM WATER		
Connection	¾" male	DN 20
Max flow rate	3.2 gpm	12 lt/min
Min flow pressure	14.5 PSI g	100 kPa
Max pressure	116 PSI g	800 kPa
Max temperature	140°F	60°C
Max hardness	70 ppm CaCO3	7°f
Max conductivity/ph	n.a./7...8 pH	n.a./7...8 pH
DEMI WATER		
Connection	¾" male	DN 20
Max flow rate	3.2 gpm	12 lt/min
Min flow pressure	14.5 PSI g	100 kPa
Max pressure	116 PSI g	200 kPa
Max temperature	140°F	60°C
Max hardness	15 ppm CaCO3	1.5°f
Max conductivity/ph	30 µs/cm/5...8 pH	30 µs/cm/5...8 pH
MAIN DRAIN		
Connection	½" 15DN	Ø 22 mm Hose L=2 m (78.7")
Peak flow rate	3.5 gpm	13 lt/min
Max height	31.5"	0.80 m
Max temperature	200°F	93°C
PRINTER CONNECTION		
Type	RS232	
ENVIRONMENT		
Temperature	+41...+104°F	+5...+40°C
Relative humidity	20...90% no condensing	20...90% no condensing
Max altitude of operation		2000 m SLM
Eq. noise pr. Lev. (Leq)	<70 dB (A)	<70 dB (A)
UNIT DIMENSIONS		
Overall Unit Dimensions	H 33.5" (850 mm) x W 23.6" (600 mm) x D 24.8" (630 mm)	
Shipping dimensions (incl. pallet)	H 40" (1010 mm) x W 31" (786 mm) x D 29" (740 mm)	
WEIGHTS		
Total Net	143 lb	65 daN (kg)
Total Gross	160 lb	73 daN (kg)
Max on working	264 lb	120 daN (kg)
Floor load	356 lb/ft²	150 daN/m² (kg/m²)
Foot support area	2.8 in²	18 cmq
HEAT EMISSIONS		
Max. from frames	1126 BTU	330 W
Max. from trolley (122°F)	1194 BTU	350 W
Overvoltage category (according to IEC EN 60664 rule)		II
UL mark	c UL us listed	
Certifications	CAN/CSA-C22.2 No. 61010-1-04 CAN/CSA-C22.2 No. 61010-2-040 UL, Std. No. 61010-1 (2nd Edition) IEC 61010-2-040:2006	

Cleaning Agents



Recommended cleaning agents for the Miele PLW 8505 lab washer are ProCare Lab 10AP alkaline liquid cleaning agent and ProCare Lab 30C acidic neutralizer. ProCare Lab 10MA mildly alkaline cleaning agent is a less aggressive, lower alkaline alternate to the ProCare Lab 10AP for less intensive wash applications.



Valid in USA



recommended by



- **ProCare Lab 10 MA**
- Alkaline detergent
- Liquid
- Container size 10 l



- **ProCare Lab 10 AP**
- Alkaline detergent
- Liquid
- Container sizes 5 l, 10 l



- **ProCare Lab 10 AT**
- Alkaline detergent
- Liquid
- Container size 5 l



- **ProCare Lab 10 AO***
- Alkaline detergent
- Liquid
- Container size 5 l



- **ProCare Lab 11 AP**
- Alkaline detergent
- Powder
- Container size 10 kg



- **ProCare Lab 30 C**
- Acidic neutralizing agent based on citric acid
- Liquid
- Container sizes 5 l, 10 l



- **ProCare Lab 30P**
- Acidic neutralizing agent based on phosphoric acid
- Liquid
- Container sizes 5 l



- **ProCare Universal 61**
- Coarse special salt
- Container size 6 kg



- **Canister key**
- Simplifies the opening of firmly tightened safety caps

*Note: When using detergents with active chlorine, increased wear of organic materials such as plastics and elastomers in the lab washer is to be expected. A temperature of 75°C should therefore not be exceeded in main wash cycles when using detergents containing higher concentrations of chlorine. In order to prevent such wear and tear, Miele recommends that machines be serviced annually or after 1000 operating hours. A failure to perform regular maintenance may invalidate guarantee and warranty claims. Please contact Miele Service or request an offer for a maintenance contract.

Note: Additional detergents available - please contact your Miele representative for more info.



Properties

Product	Container size	Properties	Ingredients	pH range
Main wash				
● ProCare Lab 10 MA	10 l	Liquid, alkaline Free from: Tensides and oxidative agents	Alkali hydroxide Phosphates Silicates	11.6-11.8 ²
● ProCare Lab 10 AP	5 l, 10 l	Liquid, alkaline Free from: Tensides, Phosphates and oxidative agents	Alkali hydroxide Polycarboxylates	12.5-12.7 ²
● ProCare Lab 10 AT	5 l	Liquid, alkaline contains tensides Free from: Phosphates, silicates and oxidative agents	Alkali hydroxide Polycarboxylates Tensides	12.2-12.5 ²
● ProCare Lab 10 AO*	5 l	Liquid, alkaline Oxidative Free from: Tensides	Alkali hydroxide Phosphates Chlorine bleach	11.8-12.1 ²
● ProCare Lab 11 AP	10 kg	Powder, alkaline Oxidative Free from: Phosphates,	Oxygen bleach Tensides	11.5-11.7 ¹
Neutralisation				
● ProCare Lab 30 C	5 l, 10 l	Liquid Acidic (based on citric acid) Free from: Tensides and phosphates	Citric acid	2.9 -2.5 ³
● ProCare Lab 30 P	5 l	Liquid Acidic (based on phosphoric acid) Free from: Tensides	Phosphoric acid	2.2-1.9 ⁴
Reactivating				
● ProCare Universal 61	6 kg	Coarse special salt for reactivation of built-in water softener		

¹ pH value (determined using fully demineralised water at 20°C) 2 to 4 g/l

² pH value (determined using fully demineralised water at 20°C) 2 to 4 g/l

³ pH value (determined using fully demineralised water at 20°C) 1 to 4 g/l

⁴ pH value (determined using fully demineralised water at 20°C) 1 to 3 g/l



Valid in Canada



- **ProCare Lab 10 MA**
- Mildly alkaline detergent
- Liquid
- Container size 5 l
- Art.No. 10265670



- **ProCare Lab 10 AP**
- Alkaline detergent
- Liquid
- Container sizes 5 l, 10 l



- **ProCare Lab 11 MA**
- Alkaline detergent
- Liquid
- Container size 10 kg



- **ProCare Lab 11 AP**
- Alkaline detergent
- Powder
- Container size 10 kg



- **ProCare Lab 30 C**
- Acidic neutralizing agent based on citric acid
- Liquid
- Container sizes 5 l, 10 l



- **ProCare Lab 30 P**
- Acidic neutralizing agent based on phosphoric acid
- Liquid
- Container sizes 5 l, 12 kg



- **ProCare Universal 61**
- Coarse special salt
- Container size 6 kg



- **Canister key**
- Simplifies the opening of firmly tightened safety caps

Note: When using detergents with active chlorine, increased wear of organic materials such as plastics and elastomers in the lab washer is to be expected. A temperature of 75°C should therefore not be exceeded in main wash cycles when using detergents containing higher concentrations of chlorine. In order to prevent such wear and tear, Miele recommends that machines be serviced annually or after 1000 operating hours. A failure to perform regular maintenance may invalidate guarantee and warranty claims. Please contact Miele Service or request an offer for a maintenance contract.



Properties

Product	Container size	Properties	Ingredients	pH range
Main wash				
● ProCare Lab 10 MA	5 l	Liquid, mildly alkaline Free from: Tensides and oxidative agents	Alkali hydroxide Phosphates Silicates	11.6-11.8 ²
● ProCare Lab 10 AP	5 l, 10 l	Liquid, alkaline Free from: Tensides, Phosphates and oxidative agents	Alkali hydroxide Polycarboxylates	12.5-12.7 ²
● ProCare Lab 11 MA	10 kg	Powder, mildly alkaline Foam-retardant action Free from: Oxidative agents	Phosphates Silicates Tensides	11.7-11.9 ¹
● ProCare Lab 11 AP	10 kg	Powder, alkaline Oxidative Free from: Phosphates,	Oxygen bleach Tensides	11.5-11.7 ¹
Neutralisation				
● ProCare Lab 30 C	5 l, 10 l	Liquid Acidic (based on citric acid) Free from: Tensides and phosphates	Citric acid	2.9 -2.5 ³
● ProCare Lab 30 P	5 l, 12 kg	Liquid Acidic (based on phosphoric acid) Free from: Tensides	Phosphoric acid	2.2-1.9 ⁴
Reactivating				
● ProCare Universal 61	6 kg	Coarse special salt for reactivation of built-in water softener		

¹ pH value (determined using fully demineralised water at 20°C) 2 to 4 g/l

² pH value (determined using fully demineralised water at 20°C) 2 to 4 g/l

³ pH value (determined using fully demineralised water at 20°C) 1 to 4 g/l

⁴ pH value (determined using fully demineralised water at 20°C) 1 to 3 g/l

Laboratory Glassware Washer

PLW 8505 (62850501USA)

Dimensions:

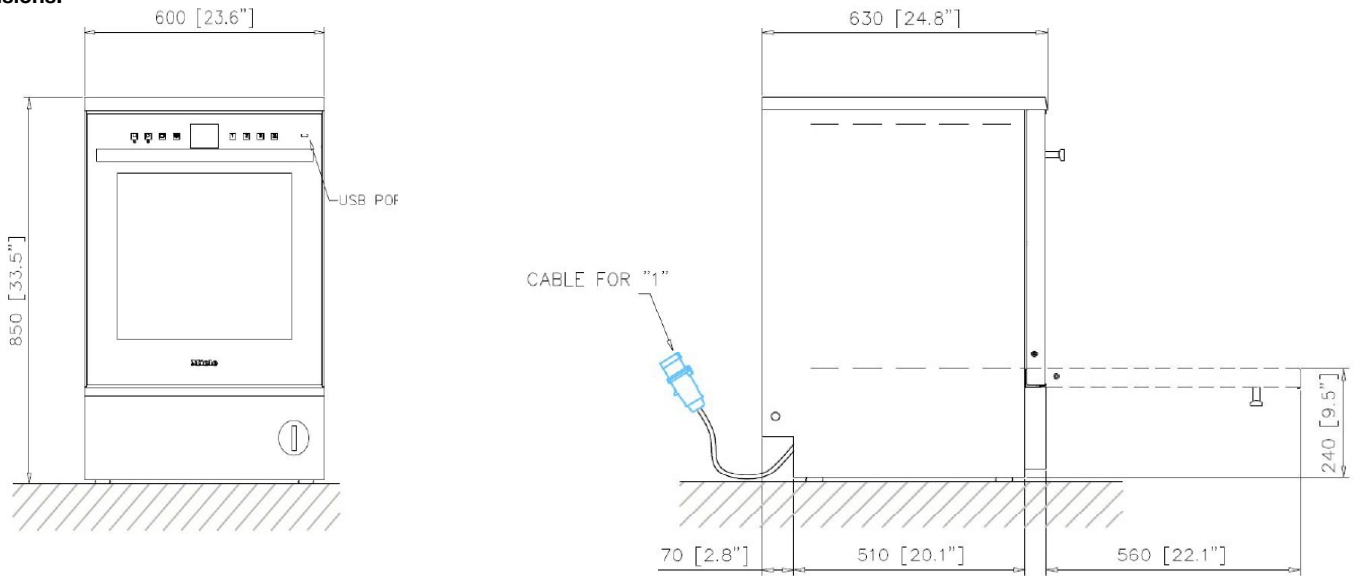

Shipping dimensions:

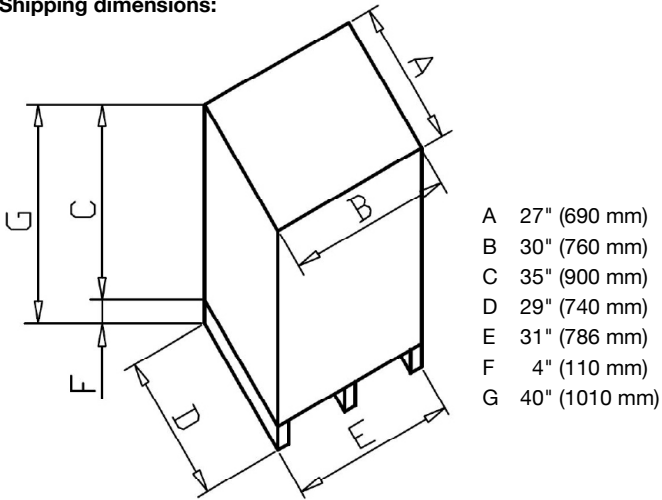

Connections:

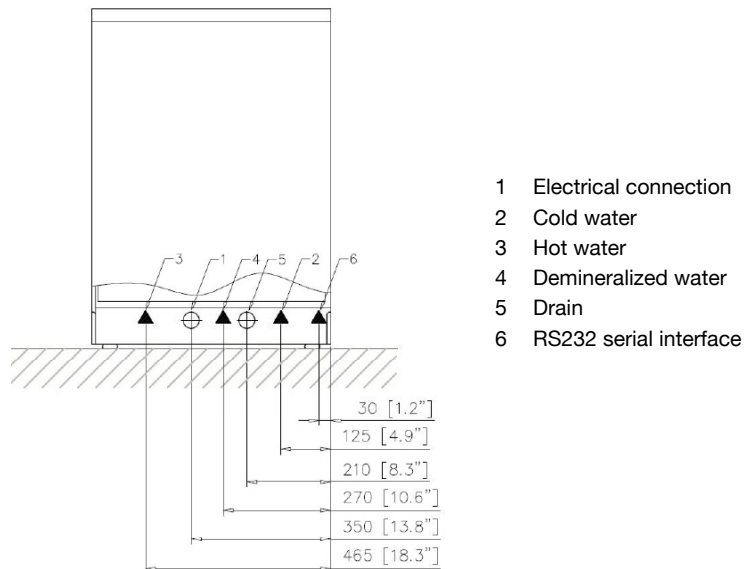



Miele Inc.
9 Independence Way
Princeton, NJ 08540

Toll Free: 800-991-9380
Fax: 609-419-4241

proinfo@mieleusa.com
www.mieleusa.com/professional



Miele Limited
161 Four Valley Drive
Vaughan, ON, L4K 4V8

Toll Free: 888-325-3957

professional@miele.ca
www.mieleprofessional.ca



since 1899

Immer Besser

Since 1899, Miele – a family-run company – has subscribed to a clear corporate philosophy condensed into the two words 'Immer besser' (Forever better). This overarching claim is the foundation of Miele's proverbial quality and sustainability, and the power of innovation of a brand 'Made in Germany'. A brand promise which gives commercial users the certainty of having chosen the right product.

Award-winning

Uncompromising product reliability and service dependability is the reason why customers have repeatedly voted Miele the best and most trustworthy brand. Coveted awards such as the MX Award, the iF and reddot Design Awards and the German Sustainability Prize confirm the distinguished position Miele enjoys with respect to design, quality management and the sparing use of resources.

Proficient

Miele Professional has been developing and manufacturing a broad range of high-quality laundry machines, dishwashers, washers, washer-disinfectors and sterilizers for decades. Carefully selected accessories, comprehensive advisory services, and a Miele service operation ensure that machines perform to perfection and offer the ultimate in capacity and efficiency.

Miele Professional on the web

- For detailed information on technical data, features and accessories
- Brochures on all product groups and applications available as downloads