

Miele

Top-class safety, cleanliness and material compatibility.
Laboratory glassware washers.

Miele Professional. Immer Besser.



A systematic approach from Miele Professional

A clear decision in favor of Miele



In developing reprocessing solutions for laboratory glassware, Miele Professional has always placed its focus on close cooperation with the experts in industry, with research laboratories and with highly reputable glassware manufacturers. The result of this cooperation based on trust and innovation are machines and processes which convince discerning users all along the line.

Quality

Reproducible analyses require quality - quality in terms of laboratory glassware and its reprocessing. Miele's proverbial standards of quality can be relied on at all times: Sophisticated design and high-quality materials underline the first-class reputation of Miele Professional in laboratories. And this is equalled by the quality of service which has won Miele numerous awards over the years.

Performance

Laboratory glassware washers from Miele Professional have a proven ability to stand up to the stresses and strains of everyday laboratory life. Their insatiable appetite for work, a wide range of accessories and practical processes ensures perfect results and a high throughput capacity each time round, even when reprocessing special loads. Valuable laboratory glassware is ready for re-use again within next to no time.

Efficiency

Profit daily from excellent efficiency: Machines from Miele Professional are thorough and fast, affording top-rate protection to materials in the process. Thanks to their high quality, they also require little maintenance and are highly durable, safeguarding your investments in many respects. The efficient use of water and chemicals also equates to low running costs.





Miele Professional is a decision in favour of top performance, quality and efficiency. High-quality machines which reliably meet the expectations of the discerning, day in and day out, underline the trust placed by commercial users in Miele: 97% of all clients* would buy from Miele again next time round.

Dependability

For four generations, Miele has carried a special responsibility as a family-run company towards its customers, its business partners and its employees as well as for its products, processes and natural resources.

- Product development with a clear focus on quality, durability and sustainability
- Innovations 'Made in Germany' which have set their stamp on the industry
- Award-winning ergonomics, functionality and product design
- Entire systems from a single supplier
- Lower operating costs over entire product life cycle (Total Cost of Ownership)
- Highly commended after-sales service offering blanket coverage and a fast response

Sustainability

What does sustainability mean to us? It means protecting people and the environment and doing business responsibly, for generations to come. Specifically, we offer and ensure energy efficiency and resource conservation with our products and production processes.

Every lab should benefit from using sustainable equipment, not only in getting the required cleaning results but also in reducing the Total Ownership Cost. At Miele Professional we are here to support you in specifying the suitable lab glassware washers based on the individual project's requirements. Choices range from a wide selection of glassware washers with different dimensions and features, flexible accessories and suitable cleaning agents plus ACT certified equipment and service excellence. The ACT label provides transparency that allows us to learn how to reduce the environmental impact of life science.

55 Laboratory
YEARS Technology

Competent and innovative

Miele

recommended by



DURAN
WHEATON
KIMBLE

- Intensive development work and close cooperation
- Trend-setting process development and product specifications



ACT.

The Environmental
Impact Factor Label

visit www.mygreenlab.org



Product benefits

PG 8583, PG 8593, PG 8583 CD lab washers



Greater capacity

- High capacity (e.g. up to 260 injector nozzles in combination with the modules for pipettes and laboratory glassware), achieved through optimised chamber dimensions and a completely redesigned range of load carriers, saves time, storage space and costs.
- Rear basket docking enables full use of space in load carriers. Laboratory glassware turnaround is increased and work is speeded up at peak hours.

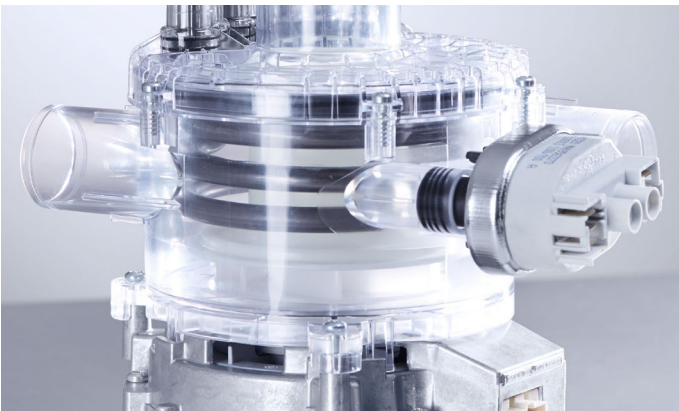

Greater purity

- Excellent cleaning performance.
- Variable-speed pump for perfect spray pressure in all program phases.
- Laser technology is used to weld the chamber sections to give a perfectly smooth, crevice-free finish for the ultimate in hygiene.
- No more heater elements in the wash chamber.
- Multi-stage filtration system is highly efficient in removing particulate soil from water in circulation.
- Spray pressure and spray arm monitoring detects any loss in pressure as well as load items preventing spray arm rotation.
- Conductivity monitoring ensures required rinsing results.



Greater flexibility

- A modular basket concept offers maximum flexibility and intuitive operation as modules can be used in different combinations and can easily be reconfigured.
- Wide range of combination options guarantees flexibility in catering for different loads.
- Reduction in number of load carriers needed saves both on investments and storage space.
- In addition to a broad selection of standard programs, client-specific cycles ensure that reprocessing suits the type of soil and the type and quantity of laboratory glassware.

Overview of further product benefits

PG 8583, PG 8593, PG 8583 CD laboratory glassware washers



Design and user interface

The modern design and the intuitive user interface make for the incredibly simple use of laboratory glassware washers.

- The control panel is the central design element and represents an intelligent combination of door handle and control panel. It consists of a single, flush stainless-steel surface with embedded 'touch-on-steel' controls.
- Inclined control panel for improved legibility.
- 3-line text display and intuitive user interface for hassle-free operation.
- Programs catering for all types of glassware and soils and vacant program slots for user-specific programs.
- Freely assignable direct-access buttons and individually selectable program names for fast access to routine tasks.
- Flush, smooth control panel and handle surfaces for simple wipe cleaning.



Ergonomics

An easily accessible salt container in the door and the AutoClose functions simplify the work of those operating these machines.

- The patented door salt container has a capacity of approx. 2 kg. Replenishing the salt no longer requires bending or stooping as the job can be performed standing upright. Similarly, there is no longer any need to remove heavy baskets and load carriers to access the salt container.
- AutoClose: Slight contact between the door and the machine is sufficient to automatically close the door. As a result, only a minimum of effort is required to reliably close and lock the door.

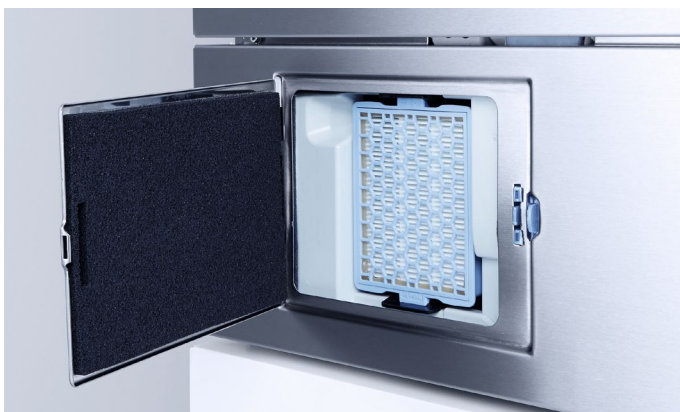

Highly efficient drying

Depending on the model, the laboratory glassware washers feature DryPlus hot-air drying or EcoDry to assist drying by releasing steam.

- EcoDry: The door of the PG 8583 opens automatically at the end of a program once the temperature in the chamber drops below 70°C. This releases hot, moisture-laden air, allowing the load to dry and cool down faster.
- DryPlus hot-air drying on the PG 8593/PG 8583 CD represents an ideal solution when dealing with intricate and narrow-lumened laboratory glassware and equipment. An upstream Class H13/H14 HEPA filter ensures the reliable removal of particles from the air taken in for drying. The filter is easily accessible for servicing via a hatch in the machine toe-kick panel (PG 8593) or in the side unit (PG 8583 CD).



Hygienic chamber

A completely redesigned chamber on the laboratory glassware washers enables high standards of hygiene and purity for analytical experiments.

- Laser technology is used to weld the chamber sections to give a perfectly smooth, crevice-free finish offering no nooks or crannies where blood or soil can accumulate.
- The removal of heater elements from the chamber removes a further potential source of a build-up of contamination and eliminates the risk of damage to plastic items.
- Greater space in the chamber facilitates a higher capacity per cycle (e.g. 128 laboratory vials or 98 pipettes together with other laboratory glassware).



Rear basket docking system

The relocation of the docking system for upper and lower baskets and load carriers to the rear of the chamber guarantees a more streamlined water and air circuit and improves the use of resources.

- Shorter circulation paths help minimize pressure losses and reductions in water temperature.
- Automatically self-sealing valves when not in use ensure uniformly high spray pressure.
- Use of same docking system to supply load carriers with water and hot air for internal drying.



Optimized spray arms

The spray arm design consistently improves on progress made on previous model series and ensures the ultimate in reprocessing reliability.

- Different nozzle forms ensure the forceful removal of persistent soil and the uniform wetting of wash loads.
- Full spray jet coverage thanks to arrangement of nozzles on spray arms.
- Lower water consumption per cycle without any trade-off in terms of cleaning performance.



Safety through constant checks

The laboratory glassware washers feature spray pressure and spray arm monitoring and some models also monitor water conductivity. These advanced sensors make a considerable contribution towards ensuring the reliability of reprocessing.

- Blockages caused by protruding load items are immediately detected
- Spray pressure losses as a result, for example, of excessive foaming is reliably detected.
- Deviations from the selected conductivity level in the final rinse water are reliably detected. Range 0 $\mu\text{S}/\text{cm}$ - 1 mS/cm
- Thanks to integrated sensors, deviations from the program parameters are immediately recognized, allowing rapid intervention on the part of users.

Labwasher overview

PG 8583, PG 8593, PG 8583 CD



Lab washers (left to right)	PG 8583	PG 8593	PG 8583 CD
Labwasher Height x Width x Depth [mm(in)]	835 (32 7/8) x 600 (23 5/8) x 600 (23 5/8)	835 (32 7/8) x 600 (23 5/8) x 600 (23 5/8)	835 (32 7/8) x 900 (35 7/16) x 700 (27 9/16)
Usable wash cabinet HxWxD ¹ [mm(in)]	520 (20 1/2) x 530 (20 7/8) x 520 (20 1/2)	520 (20 1/2) x 530 (20 7/8) x 520 (20 1/2)	520 (20 1/2) x 530 (20 7/8) x 520 (20 1/2)
Usable chamber volume [L(cu.ft)]	145 (5.12)	145 (5.12)	145 (5.12)
Capacity			
Lab vials	128	128	128
Pipettes	98	98	98
Mixed load of laboratory glassware and pipettes	130	130	130
Drying	EcoDry	DryPlus	DryPlus
Integrated dispenser pump	2	1	2
Drawer for supply canisters (3 x 5 l or 2 x 10 l)	–	–	•
Electrical connection 3 AC 208 V, 60 Hz	•	•	•
Total rated load [kW]	6.2	6.2	6.2
Standard Liquid Dispensing version			
USA	10714830	10250030	10262730
Canada	62 8583 04CDN	62 8593 01CDN	62 8583 50 CDN
Alternate Powder Dispensing version			
USA	10250020	–	–
OIL version / oil seals			
USA	10254330	–	10262740
Canada	62 8583 71CDN	–	–

Programs; Cycle Times, Consumption

	Main wash					Drying	
	Cycle time	CW	HW	DI	Energy	Cycle time	Energy
	[mins.]	[l]	[l]	[l]	[kWh]	[mins.]	[kWh]
PG 8583							
Universal	41	4.5	31.5	18.5	2.1	2	-
Standard	34	5.0	14.0	18.5	1.7	1	-
Intensive	43	4.5	23.5	27.5	2.0	2	-
Inorganica	33	5.0	24.0	27.5	1.9	1	-
Organica	34	-	37.0	18.5	2.0	2	-
Injector Plus	45	6.0	42.0	24.0	2.0	2	-
Pipettes	48	7.5	37.5	45.0	1.9	1	-
Plastics	40	36.0	-	18.5	1.7	-	-
Quick wash	23	-	19.0	9.5	1.0	-	-
Oil program	36	-	47.0	18.5	1.9	2	-
Special 93°C-10'	67	11.9	29.6	14.0	3.8	2	-
De-min. rinse	6	-	-	10.0	0.01	-	-
Rinsing	4	10.0	-	-	0.01	-	-
PG 8593 / 8583 CD							
Universal	41	4.5	31.5	18.5	1.8	37	0.7
Standard	34	5.0	14.0	18.5	1.7	37	0.7
Intensive	43	4.5	23.5	27.5	2.0	37	0.7
Inorganica	33	5.0	24.0	27.5	1.9	37	0.7
Organica	34	-	37.0	18.5	2.0	37	0.7
Injector Plus	45	6.0	42.0	24.0	2.0	37	0.7
Pipettes	48	7.5	37.5	45.0	1.9	47	0.6
Plastics	40	36.0	-	18.5	1.7	52	0.7
Quick wash	23	-	19.0	9.5	1.0	37	0.7
Oil program	36	-	47.0	18.5	1.9	37	0.7
Special 93°C-10'	67	11.9	29.6	14.0	3.8	79	1.4
Demin. rinse	6	-	-	10.0	0.01	-	-
Rinsing	4	10.0	-	-	0.01	-	-
Drying	-	-	-	-	-	40	0.7

Electrical connection 2AC 208/240V; 3AC 208/240V, 60 Hz, 6.2kW (heating: 5.4 kW, connection to cold water (15°C), hot water (65°C) and demineralized water (15°C))

Overview of upper and lower baskets and load carriers

for PG 8583, PG 8593 and PG 8583 CD



A 100 upper basket for modules

- Upper basket with two docking pipes
- For the connection of up to two injector modules
- Automatically self-sealing docking valves
- H 141, W 528, D 525 mm
- Loading dimensions H 235, W 485, D 435 mm
- Mat. No. 9862320

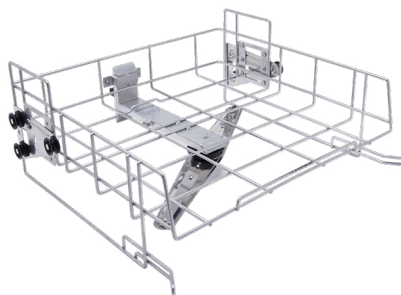

A 101 upper basket/open front

- Open front
- For various inserts
- Height-adjustable
- Built-in spray arm
- H 206, W 528, D 527 mm
- Loading dimensions H 160 +/- 30, W 475, D 443 mm
- Mat. No. 9862340

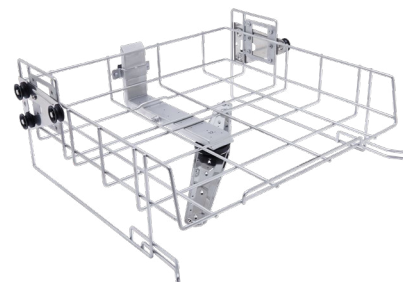

A 102 upper basket/open front

- Open front
- For various inserts
- Height-adjustable
- Built-in spray arm
- H 206, W 528, D 527 mm
- Loading dimensions H 205 +/- 30, W 475, D 443 mm
- Mat. No. 9862360

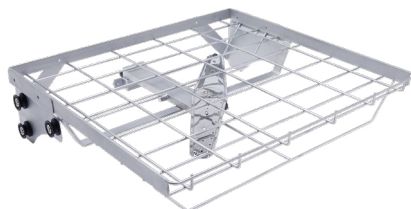

A 103 upper basket/open front

- Open front
- For various inserts
- Built-in spray arm
- Particularly suitable for the reprocessing of shallow loads in combination with A 202
- H 133, W 528, D 528 mm
- Loading dimensions H 95, W 505, D 472 mm
- Mat. No. 9862370

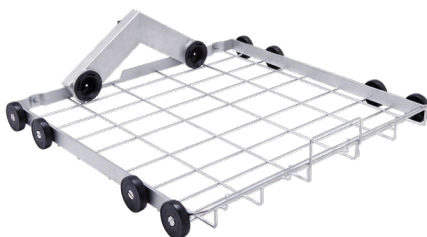

A 150 lower basket for modules

- Lower basket with two docking pipes
- For the connection of up to two injector modules
- Automatically self-sealing docking valves
- H 154, W 529, D 546 mm
- Loading dimensions H 235, (with A 100 upper basket) W 490, D 435 mm
- Mat. No. 9862400



A 151 lower basket/open front

- For various inserts
- H 88, W 529, D 110 mm
- Loading dimensions
 - H with A 100: 235 mm
 - H with A 101: 275 +/- 40 mm
 - H with A 102: 230 +/- 30 mm
 - H with A 103: 305 mm
 - H without upper basket: 495 mm
 - W 490, D 489 mm
- Mat. No. 9862410

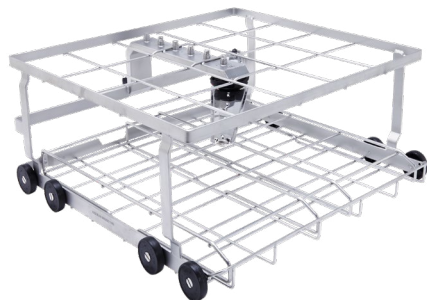

A 202 wash cart

- For inserts on 2 levels
- Built-in spray arm
- Loading dimensions, lower level:
 - H 95, W 519, D 485 mm or H 135, W 494, D 500 mm (with/without rack inserts)
- Loading dimensions, upper level: H 135, W 516, D 462
- 6 additional LuerLock connections
- H 223, W 529, D 542 mm
- Mat. No. 9863070



E 802 nozzle

- Applies to laboratory glassware washer with powder dispensing
- For use with injector modules to rinse out powder residue from door dispenser
- H 187, W 30, D 15 mm
- Mat. No 9863070



Innovative load carrier system

Load carriers and inserts offering improved efficiency

In the interests of the safety and retaining the value of laboratory glassware and equipment, Miele Professional offers a wide range of accessories, consisting of upper and lower baskets, load carriers and inserts for a variety of glassware types. The load carrier system has undergone further optimization in order to make loading even simpler. Thanks to SimpleLoad, loading was never simpler!

SIMPLELOAD

Great efficiency and versatility

The SimpleLoad system utilises the available space in the chamber to a higher degree, allowing more laboratory glassware and equipment and other load items to be washed in each cycle. Another benefit accrues from the redesigned water and air circuit: Wash liquor and drying air is fed along a shorter and streamlined circuit and with minimal pressure losses on the way to the spray arms and injector nozzles. Optimum pressure conditions are also created by the automatically self-sealing docking valves when not occupied. The modular nature of the load carriers represents a further product benefit, facilitating future extensions.

SimpleLoad – Fast loading and highly efficient use of chamber space. The loading system for cleaning laboratory glassware.

Miele reinvents loading: with SimpleLoad

SIMPLELOAD

- Injector system for all common injector modules and a large number of further load carriers
- Optimum use of available vertical clearance
- Particularly fast and simple arrangement of load
- Thorough internal cleaning of glassware of all shapes and sizes
- Secure hold and exceptional material protection during wash cycle

SimpleLoad means efficiency and a systematic approach to convenience:

- Injector nozzles (3 diameters, 6 lengths)
- Plastic holders and support frames
- Injector modules (8, 18 or 32 injectors)
- Support frames (for 8, 18 or 32 injector positions)
- Available for PG8504, PG8583, PG8593, PG8583CD and PLW86 Series



Even if a nozzle tip rests against the base of a glass, the injectors still guarantee thorough cleaning. The support frame surrounds the injectors in the module or basket, preventing lateral movement without wasting valuable height.



The support frame provides additional hold. When required, it is placed on top of the injector module, providing a secure hold to even large items of laboratory glassware in a vertical and protected position.

Injector modules for laboratory glassware

For use with A 100 upper basket and A 150 lower basket

2x4 Configuration



A 300/3 module 2x4

- For laboratory glassware, e.g. Erlenmeyer flasks, round flasks, laboratory bottles, measuring flasks and measuring cylinders (250 - 1,000 ml)
- 4x A 840 injector nozzles, 4x A 841 injector nozzles
- H 228, W 208, D 479 mm
- Mat. No. 11116900

A 300/2 module 2x4 (w/o nozzles)

- For laboratory glassware, e.g. Erlenmeyer flasks, round flasks, laboratory bottles, measuring flasks and measuring cylinders
- For up to 8 injector nozzles (particularly suitable for \varnothing 6 mm, e.g. A 840 or A 841, other diameters possible depending on application)
- H 73, W 133, D 475 mm
- Mat. No. 11056770



A 840 injector nozzle \varnothing 6x130 mm

- Also come in sets of 5, 10, 20
- Mat.No. 11056100



A 841 injector nozzle \varnothing 6 x 210 mm

- Also come in sets of 5, 10, 20
- Mat.No. 11056190



A 860 support frame 2x4

- For improved protection and centering of load items
- For use with A 300/3 und A 300/2 modules
 - Mat. No. 11056800

Injector modules for laboratory glassware

For use with A 100 upper basket and A 150 lower basket

3x6 Configuration



A 301/5 module 3x6

- For laboratory glassware, e.g. Erlenmeyer flasks, round flasks, laboratory bottles, measuring flasks and measuring cylinders (50 - 250 ml)
- 9x A 842 injector nozzles, 9x A 843 injector nozzles
- H 203, W 229, D 493 mm
- Mat. No. 11116950

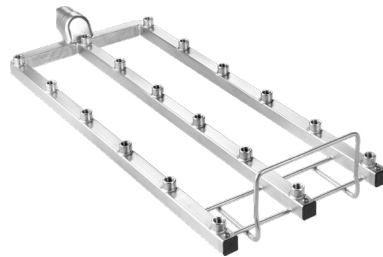

A 301/4 module 3x6 (w/o nozzles)

- For laboratory glassware, e.g. Erlenmeyer flasks, round flasks, laboratory bottles, measuring flasks and measuring cylinders
- For up to 18 injector nozzles (particularly suitable for \varnothing 4 mm, e.g. A 842 or A 843, other diameters possible depending on application)
- H 73, W 173, D 475 mm
- Mat. No. 11056780



A 842 injector nozzle \varnothing 4 x 90 mm

- Also come in sets of 5, 10, 20
- Mat.No. 11056330



A 843 injector nozzle \varnothing 4 x 185 mm

- Also come in sets of 5, 10, 20
- Mat.No. 11056440



A 861 support frame 3x6

- For improved protection and centering of load items
- For use with A 301/5 und A 301/4 modules
- Mat. No. 11056810

Injector modules for laboratory glassware

For use with A 100 upper basket and A 150 lower basket

4x8 Configuration



A 302/3 module 4x8

- For laboratory glassware, e.g. Erlenmeyer flasks, round flasks, laboratory bottles, measuring flasks and measuring cylinders (25 - 100 ml)
- 16x A 844 injector nozzles, 16x A 845 injector nozzles
- H 143, W 240, D 477 mm
- Mat. No. 11116960

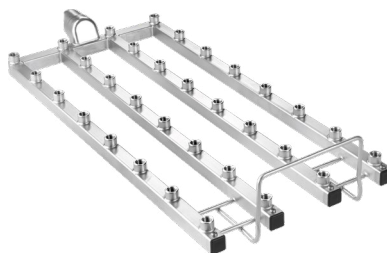

A 302/2 module 4x8 (w/o nozzles)

- For laboratory glassware, e.g. Erlenmeyer flasks, round flasks, laboratory bottles, measuring flasks and measuring cylinders
- For up to 32 injector nozzles (particularly suitable for \varnothing 2.5 mm, e.g. A 844 or A 845, other diameters possible depending on application)
- H 73, W 195, D 475 mm
- Mat. No. 11056790



A 844 injector nozzle \varnothing 2.5 x 80 mm

- Also come in sets of 5, 10, 20
- Mat.No. 11056600



A 845 injector nozzle \varnothing 2.5 x 125 mm

- Also come in sets of 5, 10, 20
- Mat.No. 11056670

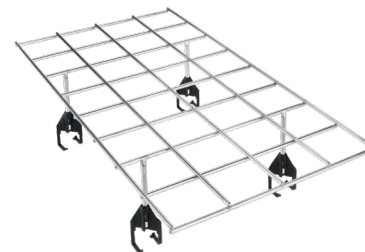

A 862 support frame 4x8

- For improved protection and centering of load items
- For use with A 302/3 und A 302/2 modules
- Mat No. 11056820

Compatibility with entire product range

Simple Load components



Laboratory glassware washers

Modules

Nozzles

Holder rack

Current model series



PG 8583	•	•	•
PG 8593	•	•	•
PG 8583 CD	•	•	•
PG 8536	-	•	-
PG 8504	-	•	-
PLW86	-	•	-

SlimLine



PLW6111	-	-	-

Large machine series



PLW 8615	•	•	•
PLW 8616	•	•	•
PLW 8617	•	•	•

Discontinued model versions

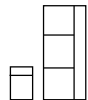

G 7825	-	•	-
G 7883	-	•	-
G 7893	-	•	-
G 7883 CD	-	•	-
PG 8527	-	•	-
PG 8535	-	•	-

Note: Modules and holding racks for standard and large-chamber units are model-specific and cannot be used on other models

Combination Options

Upper and Lower Baskets, Modules

Basket	+	Module	+	A 100 upper basket	A 101 upper basket			A 102 upper basket			A 103 upper basket
					Position			Position			
					Bottom	Centre	Top	Bottom	Centre	Top	
A 150		A 300/3 or A 300/2 with SimpleLoad nozzles		-	-	•	•	-	-	!	•
		A 301/5 or A 301/4 with SimpleLoad nozzles		•	•	•	•	•	•	•	•
		A 302/3 or A 302/2 with SimpleLoad nozzles		•	•	•	•	•	•	•	•
		A 301/4 module with SD-B nozzles		-	-	-	-	-	-	-	•
		A 303		-	-	-	-	-	-	-	-
		A 304		•	•	•	•	•	•	•	•
		A 306		-	-	-	-	-	-	-	-

Basket	+	Module	+	Loading recommendation
A 100		A 300/3 or A 300/2 with SimpleLoad nozzles		-
		A 301/5 or A 301/4 with SimpleLoad nozzles		•
		A 302/3 or A 302/2 with SimpleLoad nozzles		•
		A 301/4 module with SD-B nozzles		-
		A 303		-
		A 304		•
		A 306		-

• Recommended combination
 - Combination not recommended
 ! Combination not possible

Injector modules and load carriers for pipettes, vials and measuring cylinders

For use with A 100 upper basket and A 150 lower basket



A 303 module for pipettes

- For e.g. 98 measuring and full pipettes
- Height of retaining frame 150 mm
- H 185, W 225, D 471 mm
- Vertical clearance without upper basket: 450 mm (with A 150 lower basket)
- One each for use in A 150 lower basket
- Mat. No. 9862560

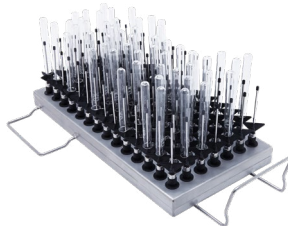

A 304 module for vials

- For 98 tubes, e.g. centrifuge tubes, vials, test tubes or autosampler tubes
- H 130, W 222, D 471 mm
- One each for A 100 upper basket or A 150 lower basket
- Mat. No. 9862570



A 306/1 module for measuring cylinders

- 4 1-2L tall measuring cylinders
- 2 1-2L short and 2 tall measuring cylinders
- Max. loading H 500mm, with swivel racks
- H 418, W 235, D 471mm
- Mat. No. 11035210

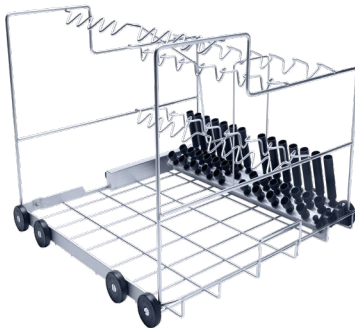

A 200 wash cart

- For 38 pipettes in 3 rows
- 1st row: 10 pipettes, max. 100 ml, Spacing 20 mm
- 2nd row: 14 pipettes, max. 25 ml, Spacing 26 mm
- 3rd row: 14 pipettes, max. 10 ml, Spacing 26 mm
- H 397, W 529, D 546 mm
- Mat. No. 9862420

Injector modules for large-volume laboratory glassware

For use with A 150 lower basket



A 313 module for bulky glassware

- For lab bottles, 2-10L
- For round flasks, 2-6L
- Erlenmeyer flasks or cylinders, 2-5L
- For use with A846-848 injectors
- H 361, W 255, D 614mm
- Mat. No. 11059970



A 846 Injector nozzle

- For Lab bottles, max. 10L and round flask, max. 6L
- Use in A 313 or A 612
- Nozzle length 127mm, with support 158mm, Ø10mm
- Mat. No. 11025590



A 847 Injector nozzle

- For Erlenmeyer flasks, max. 5L
- Use in A 313 or A 612
- Nozzle length 127mm, with support 142mm, Ø10mm
- Mat. No. 11025600



A 848 Injector nozzle

- For measuring flasks, max. 5L
- Use in A 313 or A 612
- Nozzle length 350mm, with support 142mm, Ø10mm
- Mat. No. 11025610

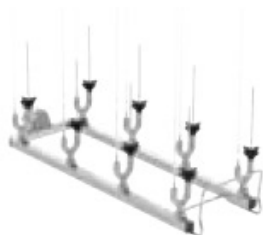

A 312 module for viscometers

- Up to 8 viscometers
- 8 x A 867 nozzles included, spacing W 118mm D 118mm
- H 395, W 164 D 475mm
- Mat. No. 11054470

Suggested Configurations

Convertible modular configurations offer more flexibility



Example set up 1

Two levels: lower injection + upper open basket

- A 101 Upper basket
- A 150 Lower basket
- 2 x AK 12/1 basket (upper)
- 2 x A 300/3 SimpleLoad module 2x4 (lower)
- For one Level: use lower injection basket only



Example set up 2

Two levels: injection only

- A 100 Upper basket
- A 150 Lower basket
- 2 x A 302/3 SimpleLoad module 4x8 (upper)
- 2 x A 301/5 SimpleLoad module 3x6 (lower)
- For one Level: use lower injection basket only



Example set up 3

Single level: Pipette Injection

- A 150 Lower basket
- A 303 module for pipettes
- A 301/5 SimpleLoad module 3x6



Example set up 4

Single level: Graduate cylinders

- A 150 Lower basket
- A 306/1 module for cylinders
- A 301/5 SimpleLoad module 3x6

Image for illustration purpose only

Accessories for reprocessing with fully demineralised water

for PG 8583, PG 8593 and PG 8583 CD



PG 8595 Aqua Purifier

- Housing unit for 2 water demineralization cartridges VE P 2000 / VE P 2800
- Compatible with PG 8583, PG 8593, PG 8583 CD
- Generally recommended quality for final rinse < 19 µS/cm
- H 835 (820), W 300, D 600 mm
- Freestanding unit, can be built under
- Outer panelling in stainless steel or white
- Condition as supplied: Empty housing unit. Cartridges and fittings must be ordered separately.
- Mat. No. 10087310



VE P 2000 water demineralization cartridge, charged

- Pressure-proof stainless-steel cartridge
- Throughflow max. 450 l/h
- Delivery capacity can be monitored with conductivity module (ConductivityMeter CM/1)
- Complete with vent and pressure relief valve
- Pressure range 0.5 – 10 bar
- Contains 12.5 l of mixed, reactivatable resin
- Connection 3/4"
- Dimensions: Ø 230 mm, H 410 mm +/- Hose connection radius (installation on either side of PG 8595 / PG 8596 possible)
- Max. supply temperature 40°C
- Mat.No. 9773410



LP 2800 demineralization cartridge, empty

- Can be charged with 19 l of single-use resin
- Pressure-proof stainless steel cartridge
- Throughflow max. 800 l/h
- Delivery capacity can be monitored with conductivity module (ConductivityMeter CM/1)
- Complete with vent and pressure relief valve
- Pressure range 0.5 – 10 bar
- Connection 3/4"
- Dimensions: Ø 230 mm, H 570 mm +/- Hose connection radius
- Max. supply temperature 40°C
- Mat.No. 9782590

E 315 disposable resin

- 20 l homogenous, mixed-bed resins for LP 2800
- Box with 2 x 10 l bags, vacuum-sealed in plastic bags
- Replacement filter bag
- Mat.No. 3830350



E 316 refill set

- Plastic barrel with lid and funnel for 30 l of disposable resin
- Mat.No. 3830360



CM/1 Conductivity Meter

- Conductivity module for water demineralization cartridges VE P 2000 and VE P 2800
- Single-line display
- 10-point measurement in 0 - 199.9 µS/cm range: 1/3/5/10/15/20/50/75/100/199.9 µS/cm
- Optical and acoustic 'change cartridge' indicator
- Optical and acoustic fault indicator
- Wall bracket
- Dimensions: H 110, W 125, D 52 mm
- Input: 110 - 240V, 50/60 Hz, 85 mA;
- Output: 9V, 400 mA, 3.6 VA
- Includes: Sensor cell with LED indicator and connection lead (length 1.0 m), 1 pressure hose 3/4" (length 1.94 m), 1 hose 3/4" (length 1.5 m)
- Mat.No. 10889920



VE P 2800 water demineralization cartridge, charged

- Pressure-proof stainless-steel cartridge
- Throughflow max. 800 l/h
- Delivery capacity can be monitored with conductivity module (ConductivityMeter CM/1)
- Complete with vent and pressure relief valve
- Pressure range 0.5 – 10 bar
- Contains 19 l of mixed, reactivatable resin
- Connection 3/4"
- Stainless-steel casing
- Dimensions: Ø 230 mm, H 570 mm +/- Hose connection radius (installation on either side of PG 8595 / PG 8596 possible)
- Max. supply temperature 40°C
- Mat. No. 9782560

Capacity in litres between cartridge reactivation cycles

GPG	5	10	15	20	25	30
µS/cm	150	300	450	600	750	900
VE P 2800	5,600	2,800	1,850	1,400	1,120	930
VE P 2000	4,000	2,000	1,330	1,000	800	660

GPG corresponds to approx. 30 µS/cm. The information provided in this chart is intended as a guide only.

Dispensing accessories

for PG 8583, PG 8593 and PG 8583 CD



PG 8596 dispenser unit

- Housing unit for process chemicals and dispenser modules
- H 835 (820), W 300, D 600 mm
- Compatible with PG 8583, PG 8593
- Freestanding unit, can be built under
- Unit with removable door
- Outer panelling in stainless steel or white
- Interior dimensions: H 690 / 380 / 285 mm (top drawer removed / lower / upper drawer), W 250 mm, D 555 / 425 mm (without / with drip tray and dispenser modules)
- Mat. No. 10087340

2 levels:

Removable telescopic drawers with drip tray liners for canisters containing process chemicals

Canister sizes:

Accommodates a total of 6 x 5 l canisters (L 245 x W 145 x H 225 mm*).

Lower drawer offers space for larger canisters:

- 2 x 10 l, 140 x 193 x 307 mm
- 2 x 10 l, 223 x 203 x 321 mm
- 2 x 10 l, 229 x 193 x 323 mm
- 2 x 10 l, 194 x 204 x 353 mm
- 1 x 20 l, 289 x 233 x 396 mm
- 1 x 25 l, 288 x 234 x 456 mm

* Only possible with DOS K 85/1 dispenser unit with short siphon



DOS K 85/1 dispenser module

- For liquid alkaline detergents and chemical disinfectants, neutralising agent
- Peristaltic pump, adjustable via machine's electronic controls
- Integrated dispenser monitoring function ensuring high level of process security
- Short siphon (200 mm) for 5 l canister, incl. level fill monitoring
- Length of connection cable: 3.00 m
- Length of suction hose: 1.80 m
- Mat. No. 10276650



DOS K 85 dispenser module

- As DOS K 85/1
- But with long siphon (300 mm) for 5 l and 10 l canisters
- Option: Conversion kit for siphon (10-30 l containers) available from Spares.
- Mat. No. 10276640

Bases

for PG 8583, PG 8593 and PG 8583 CD



UG 30-60/60-85 base

- For use on PG 8583 and PG 8593
- Stainless-steel base, bolted to machine
- H 300, W 600, D 600 mm
- Mat. No. 10087350



UG 30-90/60-85 base

- For use on PG 8583 and PG 8593 in combination with PG 8595 or PG 8596 (installation on either side of PG 8595 / PG 8596 possible)
- Stainless-steel base, bolted to machine
- H 300, W 900, D 600 mm
- Mat. No. 10087360



UG 30-90/70-85 base

- For use with PG 8583 CD
- Stainless-steel base, bolted to machine
- H 300, W 900, D 700 mm
- Mat No. 10210600



Laboratory glassware washer

PG 8536

Miele Professional has set innovative milestones for more than five decades and stands for the efficient and safe machine-based reprocessing of laboratory glassware. The PG 8536 laboratory washer excels by offering added value: greater cleaning performance, improved process security and better efficiency.

55 Laboratory
YEARS Technology

Product benefits

PG 8536



PerfectTouchControl – Simple operation and cleaning

- Controls with flush, uninterrupted touch glass screen
- Reliable operation possible even when wearing gloves
- Chemical-proof surface is flush with machine front
- Simple and effective wet-wipe disinfection

Exclusive
to Miele



PerfectPureSensor – Residue-free rinsing

- Patented conductivity monitoring system
- Detection and removal of undesirable substance from process water (e.g. dissolved salts from alkaline or acidic process chemicals)
- Individually definable limits
- Low-maintenance and precise system thanks to contact-free conductivity monitoring
- Reliable documentation and reproduction of validated reprocessing results

Exclusive
to Miele



PerfectFlowSensor – Dispensing control

- Ultrasound volumetric control for highest process security
- Precise dispensing of liquid chemicals
- Measuring system independent of viscosity and ambient temperature
- Use of particularly durable bellows-type dispenser pumps

Competent and innovative

Miele

recommended by



- Intensive development work and close cooperation
- Trend-setting process development and product specifications



**PerfectSpeedSensor –
Spray arm monitoring**

- Precise speed control for safe reprocessing results
- Monitoring of all spray arms in machine and on baskets and load carriers
- Hygienic contact-free system with sensor outside chamber
- Safe reproduction of validated reprocessing results through early detection of excessive foaming or blockages

**Exclusive
to Miele**

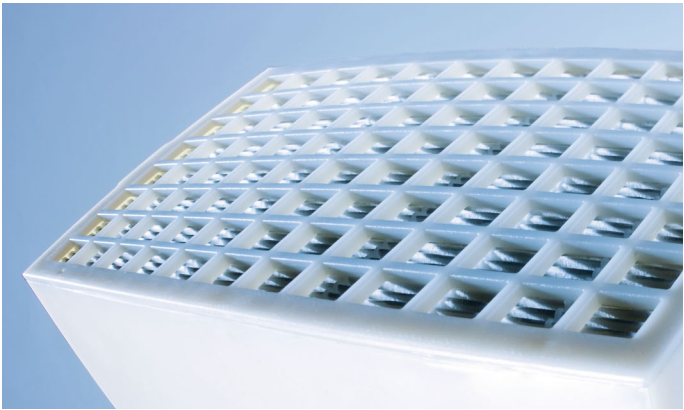

PerfectHEPA Drying

- Exceptional cleanliness, including during the drying phase, is guaranteed by PerfectHepaDrying.
- Highly temperature-resistant HEPA-grade Class 13 filters able to filter out more than 99.95% of particles.
- Upstream position at entrance to cabinet prevents unwanted particles entering with drying air
- Streamlined air flow: All parts of cabinet are reliably reached by stream of hot air

Labwasher overview

PG 8536



Lab washer	PG 8536
Labwasher Height x Width x Depth [mm(in)]	1175 (46 1/4) x 900 (35 7/16) x 700 (27 9/16)
Usable wash cabinet HxWxD ¹ [mm(in)]	520 (20 1/2) x 530 (20 7/8) x 520 (20 1/2) ¹ Depth of Lower basket
Usable chamber volume [L(cu.ft)]	145 (5.12)
Duration / VarioTD** [mins.]	41
Capacity: Lab Vials	128
Capacity: Pipettes	98
+ other laboratory glassware	•
Drying	DryPlus
Integrated dispenser pump	2
Capacity of drawer for supply canisters, 5 l	4
Electrical connection 3 AC 208 V, 60 Hz	•
Total connected load [kW]	6.6
Standard version	
USA	78331510
Canada	62 8536 35 CDN

Programs, Cycle Times, Consumption

PG 8536	Main wash				Drying
	Cycle time [min]	CW [l]	HW [l]	DI [l]	Cycle time [min]
LAB STANDARD	43	8.5	38.5	18	25
LAB UNIVERSAL	45	8.5	55	21	25
LAB INTENSIVE	53	8.5	40	48	25
LAB-PIPETTES	56	11.5	74.5	44	25
PLASTICS	48	62.5	-	20	25
ORGANICA	51	1	64	21	25
ANORGANICA	53	4	49	48	25
LAB-OIL	57	1	80.5	21	25
DES-VAR-TD	64	36.3	24.2	16	25
SPECIAL 93/10	58	22	25.5	15.5	25

Heating: 5.4 kW (3 AC 208 V, 60 Hz)

Connection to cold water (15°C), hot water (65°C), demineralized water (15°C)

Upper and lower baskets

for PG 8536



O 188/2 upper basket/open front

- Open front
- For various inserts
- Vertical clearance 165 mm
- Height adjustment range +/- 20 mm
- Built-in spray arm with magnetic tip for spray arm sensing
- H 215, W 531, D 475 mm
- Mat. No. 7333030

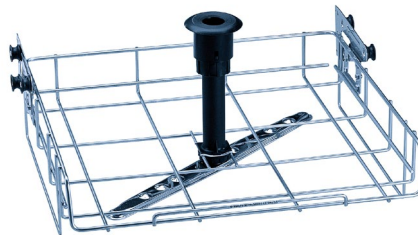
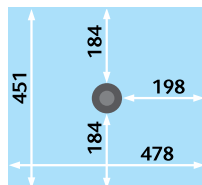

O 190/2 upper basket/open front

- As O 188/2
- Vertical clearance 215 mm
- Built-in spray arm with magnetic tip for spray arm sensing
- H 265, W 531, D 475 mm
- Mat. No. 733050

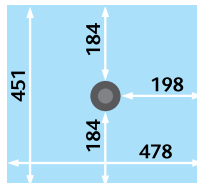

O 175 upper basket/injector unit with drying connector

- For narrow-necked laboratory glassware
- 33 injector nozzles
- Vertical clearance 170 mm*
- Connection for hot-air drying unit
- H 250, W 531, D 475 mm, H with drying connection 412 mm
- Powder dispensing not possible
- Mat. No. 3807410

Supplied as standard with:

- 33 nozzles (E 351), Ø 4 x 160 mm
- 33 clips for nozzles 4 x 160 mm (E 353)

* Clearance may be less, depending on type of laboratory glassware



O 184 upper basket/injector unit with drying connector

- For items such as centrifuge tubes, vials, test tubes for fraction collectors or autosampler tubes
- 96 injector nozzles
- Vertical clearance 170 mm
- Connection for hot-air drying unit
- H 260 (468 with drying connector), W 531, D 475 mm
- Powder dispensing not possible
- Mat. No. 3807480

Supplied as standard with:

- 96 nozzles, Ø 2.5 x 110 mm with plastic support

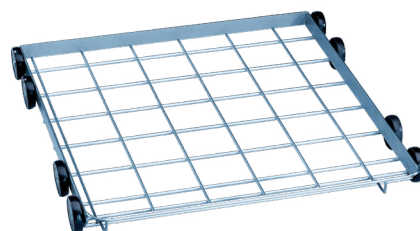

U 874/1 lower basket/open front

- Open front
- For various inserts
- Clearance heights in combination with upper basket:
 - O 175 TA approx. 230 mm +/- 20 mm
 - O 184 approx. 205 mm +/- 20 mm
 - O 187 approx. 225 mm +/- 20 mm
 - O 188/2 approx. 270 mm +/- 20 mm
 - O 190/2 approx. 220 mm +/- 20 mm
- Mat. No. 6442940

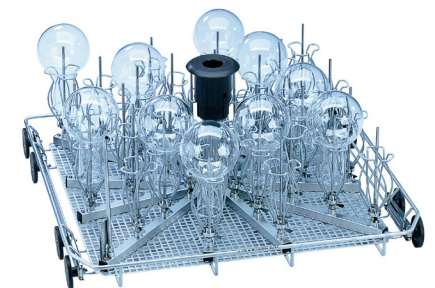

U 175/1 lower basket/injector unit

- For narrow-necked glassware
- 33 injector nozzles
- Vertical clearance approx. 170 mm
- Only in conjunction with

- O 175/O 187/O 184 upper baskets
- H 250, W 531, D 475 mm
- Mat. No. 6439170

Supplied as standard with:

- 33 nozzles (E 351), Ø 4 x 160 mm
- 33 clips for nozzles (E 353), 4 x 160 mm
- 1 irrigation nozzle

Upper and lower baskets

for PG 8536

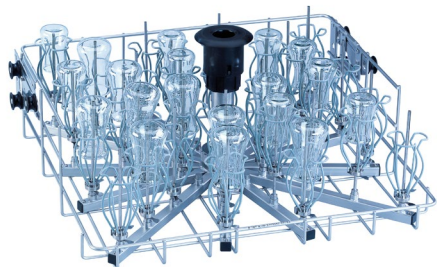

O 187 upper basket/injector unit

- For narrow-necked laboratory glassware
- 34 injector nozzles
- Vertical clearance 170 mm*
- H 250, W 531, D 475 mm
- Powder dispensing not possible

Supplied as standard with:

- 34 nozzles (E 351), Ø 4 x 160 mm
- 34 clips for nozzles 4 x 160 mm (E 353)
- Mat. No. 3881640

* Clearance may be less, depending on type of laboratory glassware

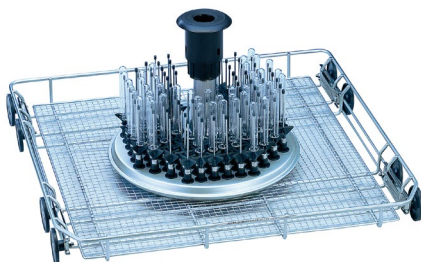

U 184/1 lower basket/injector unit

- For items such as centrifuge tubes, vials, test tubes for fraction collectors or autosampler tubes
- 96 injector nozzles
- Only in conjunction with

O 175/O 187/O 184 upper baskets

- Vertical clearance approx. 170 mm
- H 250, W 531, D 515 mm

Supplied as standard with:

- 96 nozzles 2.5 x 90 mm with plastic supports
- Mat. No. 6439180

Inserts for test tubes, funnels, beakers, wide-necked glassware

for PG 8583, PG 8593, PG 8583 CD and PG 8536



E 149 insert 1/4

- For 80 test tubes, max. 16 x 105 mm, incl. A 13 lid
- 80 compartments, 18 x 18 mm
- Mesh size on base 8 x 8 mm
- Lid available from Spares, Mat. no.: 05618390
- H 132 (152), W 200, D 320 mm
- Mat. No. 3808800

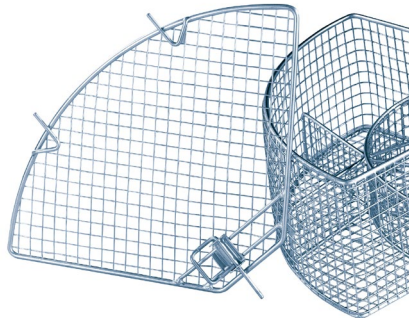

A 13 lid

- As replacement for E103, E104, E105 and E139 inserts
- Stainless steel
- 1 mm wire mesh
- 8 mm mesh gauge
- 4 mm all-round frame
- Mat. No. 3810200



E 103/1 insert 1/4

- For approx. 200 test tubes, max. 12 x 75 mm
- 6 compartments, incl. A 13 lid
- Mesh size 8 x 8 mm
- H 102 (122), W 200, D 320 mm
- Mat. No. 6907630

E 104/1 insert 1/4

- As E 103, but for test tubes, max. 12 x 105 mm, incl. A 13 lid
- Mesh size 8 x 8 mm
- H 132 (152), W 200, D 320 mm
- Mat. No. 6907640

E 105/1 insert 1/4

- As E 103, but for test tubes, max. 12 x 165 mm, incl. A 13 lid
- Mesh size 9 x 9 mm
- H 192 (212), W 200, D 320 mm
- Mat. No. 6907650

E 139/1 insert 1/4

- As E 103, but for test tubes, max. 12 x 200 mm, incl. A 13 lid
- Mesh size 9 x 9 mm
- H 223 (243), W 200, D 320 mm
- Mat. No. 6907660



AK 12/1

- For various utensils, suitable e.g. for funnels, beakers, wide-necked glassware, etc.
- Flexible handle solutions suitable for many upper and lower basket as well as load carriers
- Not for PG 8536
- H 80 (120), W 229, D 445 mm
- Mat. no. 11131690

A 14/1 lid (not illustrated)

- With 8 x 8 mm perforations
- Covers half of AK 12/1 insert
- not for use in PG 8536
- H 19, W 207, D 224 mm
- Mat. no. 11131560

Inserts for beakers, wide-necked glassware, measuring cylinders

for PG 8583, PG 8593, PG 8583 CD and PG 8536



E 106 insert 1/2 (illustrated)

- For wide-necked glassware, measuring cylinders, etc.
- 10 spring hooks, H 175 mm
- 16 spring hooks, H 105 mm, spacing approx. 60 mm
- H 186, W 220, D 445 mm
- Mat. No. 3808310

E 106/1 insert 1/2

- 26 small spring hooks, H 105 mm, spacing approx. 60 mm
- H 116, W 220, D 445 mm
- Mat. No. 3808320

E 106/2 insert 1/2

- 13 large spring hooks, H 175 mm, spacing approx. 85 mm
- H 186, W 220, D 445 mm
- Mat. No. 3808330

E 109 insert 1/2 (illustrated)

- For 21 beakers up to 250 ml
- 21 x 3 spikes
- H 155, W 230, D 460 mm
- Mat. No. 3808360

E 110 insert 1/2

- For 10 beakers, 250 ml to 600 ml
- 10 x 3 spikes
- H 175, W 230, D 460 mm
- Mat. No. 3808390

E 111 insert 1/2

- For 8 beakers, 600 to 1,000 ml
- 8 x 3 spikes
- H 205, W 230, D 460 mm
- Mat. No. 3808420

E 144 insert 1/2

- For 18 beakers up to 250 ml
- 18 x 3 spikes
- H 131, W 200, D 445 mm
- Mat. No. 3808710

Inserts for Petri dishes, watch glasses, micro-titre plates, etc.

for PG 8583, PG 8593, PG 8583 CD and PG 8536



E 118 insert 1/1

- For 38 Petri half-dishes, 100 mm
- 38 holders, Height 70 mm
- Spacing approx. 26 mm
- H 120, W 460, D 445 mm
- Mat. No. 3830270



E 136 insert 1/1

- For 56 Petri half-dishes, 100 mm
- 56 holders, Height 70 mm
- Spacing approx. 26 mm
- H 145, W 485, D 445 mm
- Mat. No. 3830280



E 137 onsert 1/1 for E 136

- For 56 Petri half-dishes, 100 mm
- 56 holders, Height 70 mm
- Spacing approx. 26 mm
- H 95, W 485, D 445 mm
- Mat. No. 3830290



E 402 insert 1/2

- For 44 Petri dishes, 80-125 mm
- 23 supports, distance between supports 15 mm
- H 53, W 200, D 445 mm
- Mat. No. 3830420

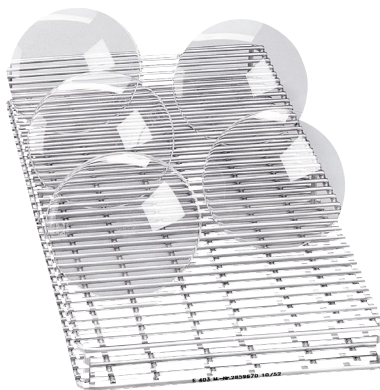

E 403 insert 1/2

- For 105 Petri dishes, 50-60 mm
- 36 supports, distance between supports 9 mm
- H 35, W 200, D 445 mm
- Mat. No. 3830430

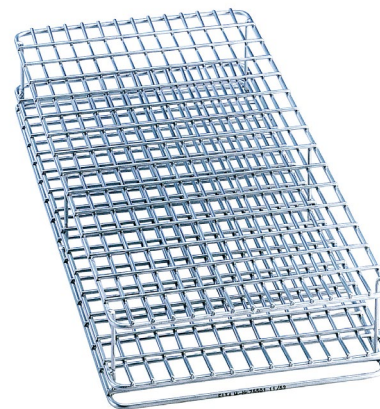

E 134 insert 1/2

- For 210 slides
- 210 compartments 26 x 11 mm
- Wire gauge 3 mm
- H 73, W 200, D 445 mm
- Mat. No. 3808600



E 494 insert 1/2

- For 5 micro-titre plates
- H 35, W 205, D 440 mm
- Mat. No. 6570920

Injector unit for pipettes

for PG 8536



E 404/1 injector unit

- For 38 pipettes in 3 rows:
 - Row 1: 10 pipettes 100 ml (length up to 550 mm), Spacing 20 mm,
 - Row 2: 14 pipettes 25 ml, Spacing 26 mm
 - Row 3: 14 pipettes 10 ml, Spacing 26 mm
- Without holder for ML/2 magnetic strip for automatic load carrier recognition/spray arm sensing
- Mat. No. 6727910



E 405/1 injector unit with drying connection

- As E 404/1
- Connection for hot-air drying unit
- With holder for ML/2 magnetic strip for automatic load carrier recognition/spray arm sensing
- Mat. No. 6727920



E 406 injector unit

- For 116 pipettes up to 450 mm
- Compartment size 16 x 16 mm
- Complete with retaining frame, height 150 mm
- Without holder for ML/2 magnetic strip for automatic load carrier recognition/spray arm sensing
- Mat. No. 3810110



E 408 injector unit with drying connection

- As E 406 but for 96 pipettes
- Connection for hot-air drying unit
- With holder for ML/2 magnetic strip for automatic load carrier recognition/spray arm sensing
- Mat. No. 3810130

Inserts for narrow-necked glassware

for PG 8536



E 355 injector unit 1/2

- For narrow-necked glassware
- 16 injector nozzles
- One half vacant for other inserts
- Mat. No. 3809560

Supplied as standard with:

- 7 x E 351 injector nozzles, Ø 4.0 x 160 mm
- 7 x E 353 clips for nozzles, 4.0 x 160 mm
- 9 x E 352 injector nozzles, Ø 6.0 x 220 mm
- 9 x E 354 clips for nozzles, 6.0 x 220 mm
- 1 x rinse nozzle for door powder dispenser



E 385 1/2 injector unit with drying connection

- As per E 355, but with connection for hot air drying unit
- 16 injector nozzles
- Holder for ML/2 magnetic strip for automatic load carrier recognition
- Mat. No. 3809930

Supplied as standard with:

- 7 x E 351 injector nozzles, Ø 4.0 x 160 mm
- 7 x E 353 clips for nozzles, 4.0 x 160 mm
- 9 x E 352 injector nozzles, Ø 6.0 x 220 mm
- 9 x E 354 clips for nozzles, 6.0 x 220 mm
- 1 x rinse nozzle for door powder dispenser



E 340 injector unit 1/2

- For narrow-necked glassware
- 19 injector nozzles
- One half vacant for other inserts
- Mat. No. 3809410

Supplied as standard with:

- 3/3/3 nozzles, Ø 4.0 x 140/160/180 mm
- 3/3/4 nozzles, Ø 6.0 x 200/220/240 mm
- 1 x rinse nozzle for door powder dispenser



E 408 injector unit with drying connection

- As E 350 but with 32 nozzles/clips
- Connection for hot-air drying unit
- Mat. No. 3810130

Supplied as standard with:

- 14 x E 351 injector nozzles, Ø 4.0 x 160 mm
- 14 x E 353 clips for nozzles, 4.0 x 160 mm
- 18 x E 352 injector nozzles, Ø 6.0 x 220 mm
- 18 x E 354 clips for nozzles, 6.0 x 220 mm
- 1 x rinse nozzle for door powder dispenser



E 329 injector unit 1/1

- For narrow-necked glassware
- 39 injector nozzles
- Mat. No. 3809340

Supplied as standard with:

- 4/5 nozzles, Ø 2.5 x 90/110 mm
- 5/5/5 nozzles, Ø 4.0 x 140/160/180 mm
- 5/5/5 nozzles, Ø 6.0 x 200/220/240 mm
- 1 x rinse nozzle for door powder dispenser



E 414 1/1 injector unit with drying connection

- As E 329, but with 37 nozzles
- Connection for hot-air drying unit
- With holder for ML/2 magnetic strip for automatic load carrier recognition/spray arm sensing
- Mat. No. 3810190

Supplied as standard with:

- 4/3 nozzles, Ø 2.5 x 90/110 mm
- 5/5/5 nozzles, Ø 4.0 x 140/160/180 mm
- 5/5/5 nozzles, Ø 6.0 x 200/220/240 mm
- 1 x rinse nozzle for door powder dispenser

Inserts for narrow-necked glassware

for PG 8536



E 350 injector unit 1/1

- For narrow-necked glassware
- 33 injector nozzles
- Mat. No. 3809880

Supplied as standard with:

- 15 x E 351 injector nozzles, Ø 4.0 x 160 mm
- 15 x E 353 clips for nozzles, 4.0 x 160 mm
- 18 x E 352 injector nozzles, Ø 6.0 x 220 mm
- 18 x E 354 clips for nozzles, 6.0 x 220 mm
- 1 x rinse nozzle for door powder dispenser

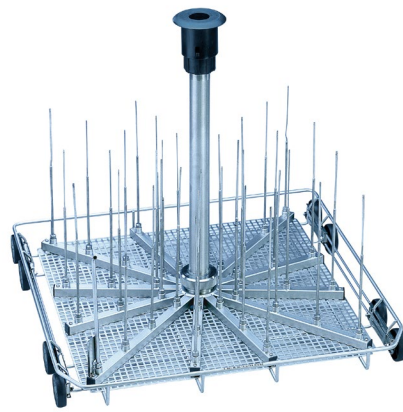

E 331 injector unit 1/1

- For butyrometers
- 39 injector nozzles
- Mat. No. 3809350

Supplied as standard with:

- 39 SD-B injector nozzles for butyrometers
- 1 x rinse nozzle for door powder dispenser

Accessories

for PG 8583, PG 8593, PG 8583 CD and PG 8536

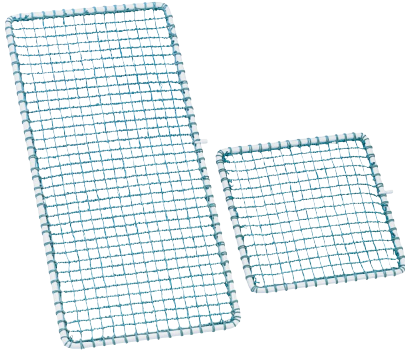

A 2 cover net 1/2 (similar to photo)

- Plastic-coated metal frame with plastic netting
- For 1/2 inserts
- 216 x 456 mm
- Mat. No. 3830460

A 3 cover net 1/4 (similar to photo)

- Plastic-coated metal frame with plastic netting
- For 1/4 inserts
- 206 x 206 mm
- Mat. No. 3830470

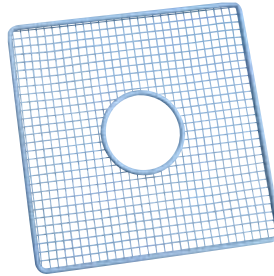

A 5 cover

- Stainless-steel frame with plastic net (material quality PA 12)
- For O and U 184, E 747, E 947
- H 8, W 280, D 280 mm
- Mat. No. 5637190

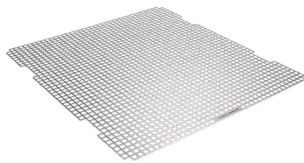

A 11/2 insert 1/1 underframe

- With 8 x 8 mm perforations
- For upper or lower basket
- Covers entire basket
- Not for use in PG 8536
- H 1, W 476, D 443 mm
- Mat. no. 11239130



A 12/2 insert 1/2 underframe

- With 8 x 8 mm perforations
- For upper or lower basket
- Covers half of basket
- Not for use in PG 8536
- H 10, W 237, D 449 mm
- Mat. no. 11238030



E319/4 surface filter

- For use in chamber
- Filters out laboratory glassware labels
- Filters out glass splinters in the event of breakage and reduces risk of injuries on removing glassware
- For use in all PG 85 undercounter lab washers
- H 39, W 455, D 513 mm
- Mat. no. 11237950

Accessories

for PG 8536



E 336 irrigation sleeve

- Plastic, with screw fitting
- For pipettes (max. length 445 mm) in injector units
- Ø 11 mm
- Length 121 mm
- Mat. No. 3809390



E 351 injector nozzle

- For injector unit
- For combination with E 353
- Ø 4 x 160 mm, screw thread
- Mat.No. 3809500

E 352 injector nozzle

- For injector unit
- For combination with E 354
- Ø 6 x 220 mm, screw thread
- Mat.No. 3809510

E 353 clip for nozzle

- For E 351 injector nozzle
- Height-adjustable
- Ø 4 x 160 mm
- Mat.No. 3809530

E 354 clip for nozzle

- For E 352 injector nozzle
- Height-adjustable
- Ø 6 x 220 mm
- Mat.No. 3809540

E 470 injector nozzle with clip

- For injector unit



Injector nozzle with plastic support

- ID 90**
- Ø 2.5 x 90 mm
- ID 110**
- Ø 2.5 x 110 mm
- ID 140**
- Ø 4 x 140 mm
- ID 160**
- Ø 4 x 160 mm
- ID 180**
- Ø 4 x 180 mm
- ID 200**
- Ø 6 x 200 mm
- ID 220**
- Ø 6 x 220 mm
- ID 240**
- Ø 6 x 240 mm



SD-B injector nozzle for butyrometers

- For E 331 load carrier
- L 240 mm incl. thread, 4 x 140 mm plus welded, compressed nozzle, 1.5 x 100 mm
- Mat. No. 3583540



E 362 blanking screw

- M 8 x 1 thread, to seal connectors on load carriers
- Mat. No. 3809630



A 838 tool set

- Serves to adjust basket heights and fit/remove injector nozzles
- Torx and open-jaw spanner and fits all common upper baskets, injector nozzles and load carriers.
- Mat. No. 11054290

Transport Trolleys, Accessories

for PG 8536



ML/2 magnetic strip

- Magnetic strip for automatic load carrier recognition
- 5 magnets, configurable, 15 combination options

Retrofittable magnetic spray arm

- For spray arm sensing function with retrofittable magnetic spray arms on PG 8535, PG 8536 on baskets/inserts without magnetic spray arms.



MC/2 Mielcar, supply and disposal trolley

- For loading lab washers and handling baskets and inserts
- 2 levels (sloping towards centre)
- Rail handle and docking plate
- Docking height H 640–885 mm, infinitely adjustable
- 4 wheels, of which 2 are lockable
- H 1003, W 600, D 805 mm (with docking plate raised D 960 mm)
- Mat. No. 10138690

For use with PG 8536 and lab washers on 30 cm plinth



MT Mieltrans trolley

- Trolley for storing and transporting basket inserts
- 4 height-adjustable levels
- Loading dimensions W 549, D 599 mm
- Height-adjustment increments 102.5 mm
- 4 lockable wheels
- H 1985, W 616, D 662 mm
- Mat. No. 3893140

Process chemicals

ProCare Lab

Miele Professional has designed a comprehensive and systematic approach to the thorough and effective reprocessing of laboratory glassware and utensils. Alongside laboratory glassware washers and tailored programs, this system also comprises process chemicals - a critical factor in cleaning. Geared meticulously to the requirements of individual program phases, specially formulated detergents and neutralising agents guarantee thorough, fast and gentle process cycles.



Quality from Miele Professional:

Process chemicals for the perfect reprocessing of laboratory glassware and equipment



ProCare Lab process chemicals are ideally suited to a multitude of applications, ensuring the trace-free removal of a wide range of soils in laboratory glassware washers. At the same time, the process takes extreme care of loads. That is why Miele Professional is recommended by leading manufacturers of laboratory glassware.

The ProCare Lab process chemicals have undergone extensive laboratory tests to ensure that they match the performance of high-performance lab washers from Miele Professional. Consequently, users profit highly from immaculate reprocessing for their analytical experiments, benefit from the value of their equipment being maintained and from fast glassware turnaround times.

A broad range of powder and liquid detergents is available to cover the various relevant applications. The packaging of the various products is color-coded in order to reduce the risk of mix-ups. Even in the hustle and bustle of laboratory life, fast and error-free reprocessing is guaranteed.



Valid in USA



recommended by



- **ProCare Lab 10 MA**
- Alkaline detergent
- Liquid
- Container size 10 l



- **ProCare Lab 10 AP**
- Alkaline detergent
- Liquid
- Container sizes 5 l, 10 l



- **ProCare Lab 10 AT**
- Alkaline detergent
- Liquid
- Container size 5 l



- **ProCare Lab 10 AO***
- Alkaline detergent
- Liquid
- Container size 5 l



- **ProCare Lab 11 AP**
- Alkaline detergent
- Powder
- Container size 10 kg



- **ProCare Lab 30 C**
- Acidic neutralizing agent based on citric acid
- Liquid
- Container sizes 5 l, 10 l



- **ProCare Lab 30P**
- Acidic neutralizing agent based on phosphoric acid
- Liquid
- Container sizes 5 l



- **ProCare Universal 61**
- Coarse special salt
- Container size 6 kg



- **Canister key**
- Simplifies the opening of firmly tightened safety caps

*Note: When using detergents with active chlorine, increased wear of organic materials such as plastics and elastomers in the lab washer is to be expected. A temperature of 75°C should therefore not be exceeded in main wash cycles when using detergents containing higher concentrations of chlorine. In order to prevent such wear and tear, Miele recommends that machines be serviced annually or after 1000 operating hours. A failure to perform regular maintenance may invalidate guarantee and warranty claims. Please contact Miele Service or request an offer for a maintenance contract.

Note: Additional detergents available - please contact your Miele representative for more info.



Properties

Product	Container size	Properties	Ingredients	pH range
Main wash				
● ProCare Lab 10 MA	10 l	Liquid, alkaline Free from: Tensides and oxidative agents	Alkali hydroxide Phosphates Silicates	11.6-11.8 ²
● ProCare Lab 10 AP	5 l, 10 l	Liquid, alkaline Free from: Tensides, Phosphates and oxidative agents	Alkali hydroxide Polycarboxylates	12.5-12.7 ²
● ProCare Lab 10 AT	5 l	Liquid, alkaline contains tensides Free from: Phosphates, silicates and oxidative agents	Alkali hydroxide Polycarboxylates Tensides	12.2-12.5 ²
● ProCare Lab 10 AO*	5 l	Liquid, alkaline Oxidative Free from: Tensides	Alkali hydroxide Phosphates Chlorine bleach	11.8-12.1 ²
● ProCare Lab 11 AP	10 kg	Powder, alkaline Oxidative Free from: Phosphates,	Oxygen bleach Tensides	11.5-11.7 ¹
Neutralisation				
● ProCare Lab 30 C	5 l, 10 l	Liquid Acidic (based on citric acid) Free from: Tensides and phosphates	Citric acid	2.9 -2.5 ³
● ProCare Lab 30 P	5 l	Liquid Acidic (based on phosphoric acid) Free from: Tensides	Phosphoric acid	2.2-1.9 ⁴
Reactivating				
● ProCare Universal 61	6 kg	Coarse special salt for reactivation of built-in water softener		

¹ pH value (determined using fully demineralised water at 20°C) 2 to 4 g/l

² pH value (determined using fully demineralised water at 20°C) 2 to 4 g/l

³ pH value (determined using fully demineralised water at 20°C) 1 to 4 g/l

⁴ pH value (determined using fully demineralised water at 20°C) 1 to 3 g/l



Valid in Canada



- **ProCare Lab 10 MA**
- Mildly alkaline detergent
- Liquid
- Container size 5 l
- Art.No. 10265670



- **ProCare Lab 10 AP**
- Alkaline detergent
- Liquid
- Container sizes 5 l, 10 l



- **ProCare Lab 11 MA**
- Alkaline detergent
- Liquid
- Container size 10 kg



- **ProCare Lab 11 AP**
- Alkaline detergent
- Powder
- Container size 10 kg



- **ProCare Lab 30 C**
- Acidic neutralizing agent based on citric acid
- Liquid
- Container sizes 5 l, 10 l



- **ProCare Lab 30P**
- Acidic neutralizing agent based on phosphoric acid
- Liquid
- Container sizes 5 l, 12 kg



- **ProCare Universal 61**
- Coarse special salt
- Container size 6 kg



- **Canister key**
- Simplifies the opening of firmly tightened safety caps

Note: When using detergents with active chlorine, increased wear of organic materials such as plastics and elastomers in the lab washer is to be expected. A temperature of 75°C should therefore not be exceeded in main wash cycles when using detergents containing higher concentrations of chlorine. In order to prevent such wear and tear, Miele recommends that machines be serviced annually or after 1000 operating hours. A failure to perform regular maintenance may invalidate guarantee and warranty claims. Please contact Miele Service or request an offer for a maintenance contract.



Properties

Product	Container size	Properties	Ingredients	pH range
Main wash				
● ProCare Lab 10 MA	5 l	Liquid, mildly alkaline Free from: Tensides and oxidative agents	Alkali hydroxide Phosphates Silicates	11.6-11.8 ²
● ProCare Lab 10 AP	5 l, 10 l	Liquid, alkaline Free from: Tensides, Phosphates and oxidative agents	Alkali hydroxide Polycarboxylates	12.5-12.7 ²
● ProCare Lab 11 MA	10 kg	Powder, mildly alkaline Foam-retardant action Free from: Oxidative agents	Phosphates Silicates Tensides	11.7-11.9 ¹
● ProCare Lab 11 AP	10 kg	Powder, alkaline Oxidative Free from: Phosphates,	Oxygen bleach Tensides	11.5-11.7 ¹
Neutralisation				
● ProCare Lab 30 C	5 l, 10 l	Liquid Acidic (based on citric acid) Free from: Tensides and phosphates	Citric acid	2.9 -2.5 ³
● ProCare Lab 30 P	5 l, 12 kg	Liquid Acidic (based on phosphoric acid) Free from: Tensides	Phosphoric acid	2.2-1.9 ⁴
Reactivating				
● ProCare Universal 61	6 kg	Coarse special salt for reactivation of built-in water softener		

¹ pH value (determined using fully demineralised water at 20°C) 2 to 4 g/l

² pH value (determined using fully demineralised water at 20°C) 2 to 4 g/l

³ pH value (determined using fully demineralised water at 20°C) 1 to 4 g/l

⁴ pH value (determined using fully demineralised water at 20°C) 1 to 3 g/l

ProCare Lab

Applications

Product	Main applications	Contamination	Material compatibility
Main wash			
● ProCare Lab 11 MA	Medical, biological and chemical laboratories	Blood, protein, food residue	Suitable for: Stainless-steel, laboratory glassware, ceramics, plastics** (PE, PP, PVDF, PTFE) Conditionally suitable for: Non-anodized aluminum and non-ferrous metals (preliminary checks required) Not suitable for: Anodised aluminum
● ProCare Lab 11 AP	Water laboratories, serological institutes, laboratories in phosphate industry	Inorganic and organic soils	Suitable for: Stainless-steel, laboratory glassware, ceramics, plastics** (PE, PP, PVDF, PTFE) Not suitable for: Light alloys and non-ferrous metals, aluminum, anodized aluminum
● ProCare Lab 10 MA	Medical, biological and chemical laboratories	Blood, protein, Nutrient residues	Suitable for: Stainless-steel, laboratory glassware, ceramics, plastics** (PE, PP, PVDF, PTFE) Conditionally suitable for: Non-anodized aluminum and non-ferrous metals (preliminary checks required) Not suitable for: Anodized aluminum
● ProCare Lab 10 AP	Medical, biological, micro-biological and chemical laboratories, water laboratories, phosphate industry, laboratories in food processing, cosmetics, pharmaceutical, mineral oil and other industries	Stubborn or dried-on residues	Suitable for: Stainless-steel, laboratory glassware, ceramics, plastics** (PE, PP, PVDF, PTFE) Not suitable for: Light alloys and non-ferrous metals, aluminum, anodized aluminum
Neutralisation			
● ProCare Lab 30 C	Medical, biological, micro-biological and chemical laboratories, water laboratories, phosphate industry, laboratories in food processing, cosmetics, pharmaceutical, mineral oil and other industries	Residues soluble in acids	Suitable for: Stainless steel, laboratory glassware, ceramics, plastics*** (PE, PP, PVDF, PTFE); additionally suitable for the neutralisation of non-anodized aluminum Not suitable for: Alloys and non-ferrous metals, chrome- and nickel-plated parts, anodized aluminium; not suitable for acidic pre-washing of non-anodized aluminium
● ProCare Lab 30 P	Medical, biological, micro-biological and chemical laboratories, laboratories in the food, cosmetics, pharmaceutical, mineral oil and other industries	Removes limescale and other soils soluble in acids	Suitable for: Stainless-steel, laboratory glassware, ceramics, plastics*** (PE, PP, PVDF, PTFE) Not suitable for: Light alloys and non-ferrous metals, chrome- and nickel-plated parts, anodized aluminium, aluminium
Reactivating			
● ProCare Lab Universal 61	ProCare Universal 61 prevents scaling and protects loads		

*Note: When using detergents with active chlorine, increased wear of organic materials such as plastics and elastomers in the lab washer is to be expected. A temperature of 75°C should therefore not be exceeded in main wash cycles when using detergents containing higher concentrations of chlorine. In order to prevent such wear and tear, Miele recommends that machines be serviced annually or after 1000 operating hours. A failure to perform regular maintenance may invalidate guarantee and warranty claims. Please contact Miele Service or request an offer for a maintenance contract.

** Plastics suitable for alkaline machine-based wash according to manufacturer.

*** Plastics suitable for acidic machine-based wash according to manufacturer



Miele
ProCare
Lab 10 AT
1L (0,26 gal) e

Miele
ProCare
Lab 10 AO
1L (0,26 gal) e

Miele
ProCare
Lab 10 AT
1L (0,26 gal) e

Miele
ProCare
Lab 11 MA
10 kg (22,0 lbs) e

Miele
ProCare
Lab 10 AO
10L (2,6 gal) e



Miele

Service Excellence

Support is always available to you.
Maintenance and service contracts

Miele Professional is synonymous with exceptional quality – not least when it comes to service. First service visits result in around 90% first-time fixes.



Comprehensive service from the very start

Even before a machine is installed, Miele's sales force is available to provide in-depth advice. Experienced experts assist in selecting the most suitable machines and configurations to suit individual needs.

Miele Service Contracts

Preventative Maintenance Plan

- Annual maintenance based on specific Miele service plan
- Preventative exchange of defined parts subject to wear and tear included

Protection Plan: US only

- Thorough testing of machine functions during scheduled service
- Charges for on-site labour and materials included

Terms and Conditions apply.
Travel charges are not included.

Full Protection Plan

- Annual maintenance based on specific Miele service plan
- Inspection of the machine functions
- Preventative exchange of defined parts subject to wear and tear included
- Charges for on-site labour and material included

Terms and Conditions apply.
Travel charges are not included.

Machine qualification IQ / OQ

- Installation Qualification
- Operation Qualification

Service to meet professional expectations

Highly qualified service technicians support customers with the delivery and commissioning of machines and perform routine checks during use. This prevents downtimes and helps to optimize operating parameters. Regular checks and maintenance prolongs the life expectancy of the machines.

- Quality service through network of technicians
- 90% of service calls result in first-time fixes
- Reliable spares service, key functional parts available for up to 15 years after series production ceases.

Customized service contracts and inspections

Miele Professional offers laboratories of all sizes tailored annual service contracts. During the terms of these contracts, Miele service technicians regularly inspect the condition of machines, depending on the type of contract. Scheduled inspection and maintenance appointments prevent breakdowns, increase the life expectancy of machines and contribute towards safeguarding investments.

**Miele Inc.**

9 Independence Way
Princeton, NJ 08540

Toll Free: 800-991-9380

Fax: 609-419-4241

proinfo@mieleusa.com

www.mieleusa.com/professional

**Miele Limited**

161 Four Valley Drive
Vaughan, ON, L4K 4V8

Toll Free: 888-325-3957

professional@miele.ca

www.mieleprofessional.ca



since 1899

Forever Better

Since 1899, Miele – a family run company – has subscribed to a clear corporate philosophy condensed into the two words “Forever better.” This far-reaching claim is the bedrock of Miele’s proverbial quality and sustainability and the power of innovation of a brand “Made in Germany.” A brand promise which gives commercial users the certainty of having chosen the right product.

Award-winning

Uncompromising product reliability and service dependability is the reason why customers have repeatedly voted Miele the best and most trustworthy brand. Coveted awards such as the MX Award, the iF and reddot Design Awards and the German Sustainability Prize confirm the distinguished position Miele enjoys with respect to design, quality management and the sparing use of resources.

Proficient

Miele Professional has been developing and manufacturing a broad range of high quality laundry machines, dishwashers, washer-disinfectors and sterilizers for decades. Carefully selected accessories, comprehensive advisory services and a fast-acting Miele service department ensures that machines perform to satisfaction and offer the ultimate in performance and efficiency.

Miele Professional on the web

- For detailed information on technical data, features and accessories
- Brochures on all product groups and applications available as downloads
- Detailed information, instructions and product presentations on Miele Professional's YouTube channel