

















Operating and Installation Instructions Refrigerators



To prevent accidents and machine damage, you **must** read these instructions before installation or use.

Contents

IMPORTANT SAFETY INSTRUCTIONS	5
Sustainability and environmental protection	13
Caring for the environment	13
How to save energy	14
Overview	15
Guide to the appliance	15
Status display.....	16
Settings mode 	17
Vacation mode 	17
Lock function  / 	17
Switching off the refrigeration appliance 	17
Sabbath mode 	17
Information on Sabbath mode i	17
Time before door alarm  is triggered.....	17
Miele@home 	17
Keypad tone  / 	18
Alarms and audible signals  / 	18
Display brightness 	18
Temperature unit °C/°F	18
Demo mode 	18
Factory default settings 	18
Information about the refrigeration appliance i	18
Safety	19
Door alarm	19
Networking.....	19
Appliance functions	20
SuperCool 	20
Adjusting the interior fittings	20
Adjusting the divider rods in the top built-under cooling drawer	20
Removing and inserting built-under cooling drawers.....	20
Optional accessories	21
Commissioning	22
Before using for the first time.....	22
Connecting the appliance.....	22
Switching on the appliance.....	22
Switching off the appliance	22
Turning off the upper drawer separately.....	22
Switching off for longer periods of time	22
Requirements for networking	23
Setting up Miele@home for the first time	23

Operation	24
Setting the temperature	24
Temperature range.....	24
Temperature display	24
Storing food in the fridge zone	25
Different storage zones.....	25
Food which is not suitable for storage in the fridge zone	26
Storing packaged food	26
Storing food in the fruit and vegetable drawer (VeggieBox)	26
Customizing settings	29
Cleaning and care	33
Cleaning agents	33
Preparing the refrigeration appliance for cleaning.....	33
Cleaning the interior of the appliance	33
Cleaning accessories by hand or in the dishwasher	34
Cleaning the door seal	34
Cleaning the ventilation gaps	34
After cleaning	34
Automatic defrosting	35
Frequently asked questions	36
Causes of noises	42
Customer Service	44
Contact in the event of a fault	44
Appliance warranty and product registration	44
Installation	45
Installation site	45
Climate range	46
Ventilation.....	46
Side-by-Side installation.....	46
Weight of the cabinet door	47
Installation dimensions	48
Niche/Side view.....	48
Connections	49
Building in the appliance	50
To install the refrigeration appliance, you will need the following tools:	50
Preparing the refrigeration appliance.....	50
Positioning the refrigeration appliance.....	51
Aligning the refrigeration appliance.....	52
Securing the refrigeration appliance in the niche.....	53
Installing cabinet doors	54
Electrical connection	58

Contents

Declaration of conformity	60
Copyrights and licenses	61

IMPORTANT SAFETY INSTRUCTIONS

This refrigeration appliance complies with current safety requirements. Inappropriate use can, however, lead to personal injury and material damage.

Please read the operating and installation instructions carefully before using the refrigeration appliance for the first time. They contain important information on installation, safety, use, and maintenance. This will prevent both personal injury and damage to the refrigeration appliance.

Miele expressly and strongly advises that you read and follow the instructions in the chapter on installing the refrigeration appliance as well as in the "IMPORTANT SAFETY INSTRUCTIONS".

Miele cannot be held liable for injury or damage caused by non-compliance with these instructions.

Keep these instructions in a safe place and pass them on to any future owner.

Appropriate use

- ▶ This appliance is intended for use in domestic households and similar residential environments such as
 - staff kitchen areas in shops, offices and other working environments
 - farm houses and by clients in hotels, motels and other residential type environments
 - bed and breakfast type environments
 - catering and similar non-retail applications.

This appliance is not intended for use outdoors, in damp environments or in places exposed to rain.

- ▶ The refrigeration appliance is intended exclusively for domestic use for cooling and storing food and drinks.

The refrigeration appliance is not suitable for freezing food.

The refrigeration appliance is suitable for integrated under-counter installation.

Any other use is at the owner's risk and could be dangerous.

IMPORTANT SAFETY INSTRUCTIONS

▶ This refrigeration appliance is not suitable for storing and keeping cool medicines, blood plasma, laboratory preparations, or other similar substances or products that are subject to the Medical Device Directive. Incorrect use of the refrigeration appliance for such purposes may cause deterioration of the items stored. The refrigeration appliance is also not suitable for use in areas where there is a risk of explosion.

Miele cannot be held liable for damage resulting from incorrect or improper use or operation.

▶ This refrigeration appliance may only be used by people (including children) with reduced physical, sensory, or mental capabilities or lack of experience and knowledge if they are supervised while using it.

Safety with children

▶ Children should be supervised in the vicinity of the appliance.

▶ Children may only use the appliance even without supervision if they have been shown how to use it in a safe manner, and if they are able to recognize and understand the potential risks of improper use.

▶ Children must not clean or service the appliance unless they are under supervision.

▶ To reduce the risk of injury, do not allow children to play in, on or near the appliance.

▶ Ensure that any packing material is disposed of safely and kept out of the reach of children. DANGER of suffocation!

Technical safety

▶ The coolant circuit has been checked for leaks. The refrigeration appliance complies with statutory and regulatory requirements.



If the cooling circuit is damaged, refrigerant and oil can escape and ignite.

▶ Warning: fire hazard/flammable materials. This symbol is on the compressor and indicates flammable materials. Do not remove this sticker.

IMPORTANT SAFETY INSTRUCTIONS

The refrigerant inside the appliance (details on the data plate) is environmentally friendly but flammable.

The use of this refrigerant does, however, sometimes lead to a slight increase in the noise level of the appliance. In addition to the noise of the compressor, you might be able to hear the refrigerant flowing around the cooling circuit. Unfortunately, this cannot be avoided, but it does not affect the performance of the refrigeration appliance.

When transporting and installing the refrigeration appliance, ensure that no parts of the cooling circuit are damaged. Splashes of refrigerant can damage the eyes and leaking refrigerant can ignite.

In the event of damage:

- Avoid open flames or anything which creates a spark.
- Disconnect the refrigeration appliance from the power supply.
- Ventilate the room where the refrigeration appliance is located for several minutes.
- Contact Miele Service.

▶ The more refrigerant there is in a refrigeration appliance, the larger the room it should be installed in. In the event of a leakage, if the appliance is in a small room, there is the danger of a combustible gas/air mixture building up. For every 8 g of refrigerant, at least 3.3 ft (1 m)³ of room space is required. The amount of refrigerant in the refrigeration appliance is stated on the data plate inside the appliance.

▶ If the ventilation openings are covered or blocked, a combustible gas/air mixture can form if the cooling circuit is damaged. It is essential to observe the required ventilation openings. The ventilation openings must never be obstructed.

▶ To avoid the risk of damage to the appliance, make sure that the connection data (fuse rating, frequency and voltage) on the data plate corresponds to the household supply.

Check that this is the case before connecting the appliance. Consult a qualified electrician if in any doubt.

▶ The electrical safety of the appliance can only be guaranteed when correctly grounded. It is essential that this standard safety requirement is met. If in any doubt please have the electrical installation tested by a qualified electrician.

IMPORTANT SAFETY INSTRUCTIONS

▶ Temporary or permanent operation on an autonomous power supply system or a power supply system that is not synchronized with the grid power supply (e.g., island networks, back-up systems) is possible. A prerequisite for operation is that the power supply system complies with national and local codes.

The function and operation of the protective measures provided in the domestic electrical installation and in this Miele product must also be maintained in isolated operation or in operation that is not synchronized with the grid power supply, or these measures must be replaced by equivalent measures in the installation.

▶ If the power cord supplied is damaged, it must only be replaced by an original part to prevent a hazard for the user. Miele can only guarantee the safety of the appliance when original Miele parts are used. For safety reasons, this replacement should only be carried out by a qualified specialist or Miele Service.

▶ Do not connect the appliance to the electrical supply with a power bar or extension cord. These are a fire hazard and do not guarantee the required safety of the appliance.

▶ If moisture gets into electrical components or into the power cord, it could cause a short circuit. Therefore, do not operate the machine in areas where there may be moisture or splashing water (e.g., garages, laundry rooms).

▶ This appliance must not be installed and operated in mobile installations (e.g. on a ship).

▶ Do not use a damaged appliance. It could be dangerous. Check the appliance for visible signs of damage.

▶ For safety reasons, this appliance may only be used after it has been built in.

▶ During installation, side-by-side heater installation, maintenance and repair work, the appliance must be disconnected from the electrical power supply. It is only completely isolated from the electricity supply when:

- the circuit breaker has been tripped, or
- the screw-type fuses on the electrical service panel have been removed or
- the power cord has been unplugged. Pull on the plug and not on the cord when removing it from the outlet.

IMPORTANT SAFETY INSTRUCTIONS

- ▶ Installation, repair, and maintenance work should only be performed by a Miele-authorized service technician. Work by unqualified persons could be dangerous and may void the warranty.
- ▶ Any manufacturer's warranty may be void if the appliance is not repaired by a Miele approved service technician.
- ▶ Faulty components should only be replaced by genuine Miele replacement parts. Miele can only guarantee the safety standards of the appliance when Miele replacement parts are used.
- ▶ This refrigeration appliance is supplied with a special bulb to cope with particular conditions (e.g., temperature, moisture, chemical resistance, abrasion resistance, and vibration). This bulb must only be used for the purpose for which it is intended. The bulb is not suitable for room lighting. Replacement bulbs may only be installed by an authorized technician or by Miele Customer Service. This refrigeration appliance contains several light sources with at least energy efficiency class G.

Proper installation

- ▶ Install the refrigeration appliance in accordance with the installation instructions.
- ▶ Always wear protective gloves when transporting and installing the refrigeration appliance.
- ▶ Two people are required to install the appliance.

Correct use

- ▶ This refrigeration appliance is designed for use within specific ambient temperatures (climate range). Do not use in ambient temperatures for which it is not designed. The climate range is stated on the data plate in the interior cabinet of the refrigeration appliance. A lower ambient temperature will cause the compressor to switch off for longer periods, meaning that the refrigeration appliance is unable to maintain the required temperature.
- ▶ **WARNING! DANGER of overheating!** Do not cover or block the air vents. This can impair the efficiency of the appliance, increase the power consumption and cause damage to the appliance.

IMPORTANT SAFETY INSTRUCTIONS

- ▶ Risk of damage due to greasy or oily foods. If the refrigeration appliance or the appliance door is used for storing food which contains fat or oil, make sure that it does not come into contact with plastic components. Any spillages of oil or fat could cause stress cracks to the plastic and cause it to break or split.
- ▶ Risk of fire and explosion due to flammable mixes of gases. Do not store any explosive materials or products containing flammable propellants (e.g., spray cans) in the refrigeration appliance. Electrical components can cause flammable mixes of gases to ignite. The spray cans in question can be identified by the contents printed on the can or by a flame symbol. Electrical components can cause escaping gases to ignite.
- ▶ **WARNING!** Risk of explosion. Do not operate any electrical equipment (e.g., an electric ice-cream maker) inside the refrigeration appliance. Risk of sparking and explosion.
- ▶ When eating stored food, there is a danger of food poisoning. Storage times will depend on several factors, including the freshness and quality of the food, as well as the temperature at which it is stored. Observe the manufacturer's "use-by" dates and storage instructions.

Accessories and parts

- ▶ Use only genuine original Miele parts. If parts or accessories from other manufacturers are used, the warranty may become invalid.

Cleaning and care

- ▶ Do not use any oil or grease on the door seals. They can cause the seals to deteriorate over time.
- ▶ Never use a steam cleaner to clean the appliance. The steam can reach the electrical components and cause a short circuit.
- ▶ Sharp edged or pointed objects will damage the evaporator, causing irreversible damage to the appliance. Do not use sharp edged or pointed objects to
 - remove frost or ice,
 - separate frozen foods or remove ice trays.
- ▶ Never place electric heaters or candles in the appliance to defrost it. These can damage the plastic parts.

IMPORTANT SAFETY INSTRUCTIONS

▶ Do not use defrosting sprays or de-icers, as they could contain substances which could damage the plastic parts or which might cause the build-up of gases and pose a danger to health.

Transport

- ▶ To avoid damage to the refrigeration appliance, always transport it upright and in its packaging.
- ▶ Risk of injury and damage. The refrigeration appliance is very heavy and must be transported by two people.

Disposal of your old appliance

▶ **DANGER!** Risk of child entrapment! Children could become trapped in the refrigeration appliance and could suffocate.

- Remove the appliance door(s).
- Remove the drawers.
- Leave the adjustable shelves in the refrigeration appliance so children cannot climb inside.
- If your old refrigeration appliance has a door lock, destroy it. This will prevent the risk of children playing accidentally locking themselves in and endangering their lives.

▶ Risk of electric shock!

- Cut the electrical plug off the power cord.
- Cut the power cord off the old appliance.

Dispose of the electrical plug and power cord separately from the old appliance.

▶ Ensure that the appliance is not stored in the vicinity of gasoline or inflammable gases and liquids during and after disposal.

▶ **WARNING!** Risk of fire due to escaping oil or refrigerant!

The refrigerant and oil inside the appliance are flammable. In high enough concentrations, escaping refrigerant or oil may ignite if they come into contact with an external heat source.

During disposal, make sure that the cooling circuit is not damaged in order to prevent refrigerant and oil escaping in an uncontrolled manner (see the data plate for details of the refrigerant).

IMPORTANT SAFETY INSTRUCTIONS

- Splashes of coolant can cause damage to the eyes. Be careful not to damage any part of the pipework while awaiting disposal, e.g. by
- puncturing the coolant channels in the evaporator,
 - kinking any pipework,
 - scratching the surface coating.

Symbol on the compressor (depending on model)

This information is only relevant for recycling. There is no risk during normal operation.



- The oil in the compressor can be fatal if swallowed or if it penetrates the airways.

Symbol on the rear of the appliance (depending on model)

This label or a similar one is only relevant for recycling. Do not remove the label.



- This information refers to the foamed-in panels in the door and/or the housing.

Sustainability and environmental protection

Caring for the environment

Disposal of the packing material

The cardboard box and packing materials protect the appliance during shipping. They have been designed to be biodegradable and recyclable.

Ensure that any plastic wrappings, bags, etc. are disposed of safely and kept out of the reach of children. Danger of suffocation!

Disposing of your old appliance

Electrical and electronic appliances contain many valuable materials. They also contain certain materials, compounds, and components which were essential for their correct functioning and safety. These could be hazardous to your health and to the environment if disposed of with household waste or if handled incorrectly. Please do not, therefore, dispose of your old appliance with household waste.



Take care not to damage your refrigerator before or during disposal in an authorized, environmentally-friendly manner.

This is to ensure that refrigerant in the cooling circuit and oil in the compressor is contained, and will not leak into the environment.

Instead, please make use of officially designated collection and disposal locations to dispose of and recycle electrical and electronic appliances in your local community, with your dealer, or with Miele, free of charge. By law, you are solely responsible for deleting any personal data from the appliance prior to disposal. You are legally obliged to remove any old batteries which are not securely enclosed by the appliance and to remove any lamps without destroying them, where this is possible. These must be taken to a suitable collection point where they can be handed in free of charge. Please ensure that your old appliance poses no risk to children while being stored for disposal.

Sustainability and environmental protection

How to save energy ...

- Installation site** The refrigeration appliance has to cool more often at higher ambient temperatures and consumes more energy in the process. Therefore, you should:
- Install the refrigeration appliance in a well-ventilated room.
 - Do not install the refrigeration appliance near to a heat source (heater element, range).
 - Protect the refrigeration appliance from direct sunlight.
 - Ensure an ideal ambient temperature of 68°F (20°C).
 - Clean the ventilation gaps on a regular basis to remove any dust.
- Temperature setting** The colder the temperature, the higher the energy consumption. The following settings are recommended:
- 39 to 41°F (4 to 5°C) in the refrigerator section.
- Use** Energy consumption is increased by heat input and impeded air circulation. Therefore:
- Only open the appliance door/appliance doors when necessary and for as short a time as possible. Arrange the food in such a way that makes it easy to find in the appliance.
 - Always close the appliance door/appliance doors properly after opening it.
 - Allow hot food and drinks to cool down before placing them in the refrigeration appliance.
 - Store food well packaged or covered.
 - Do not overfill the compartments to allow air to circulate.
 - Keep drawers and shelves arranged as they were when the appliance was delivered.
 - Place frozen food in the refrigerator section to defrost.

Guide to the appliance

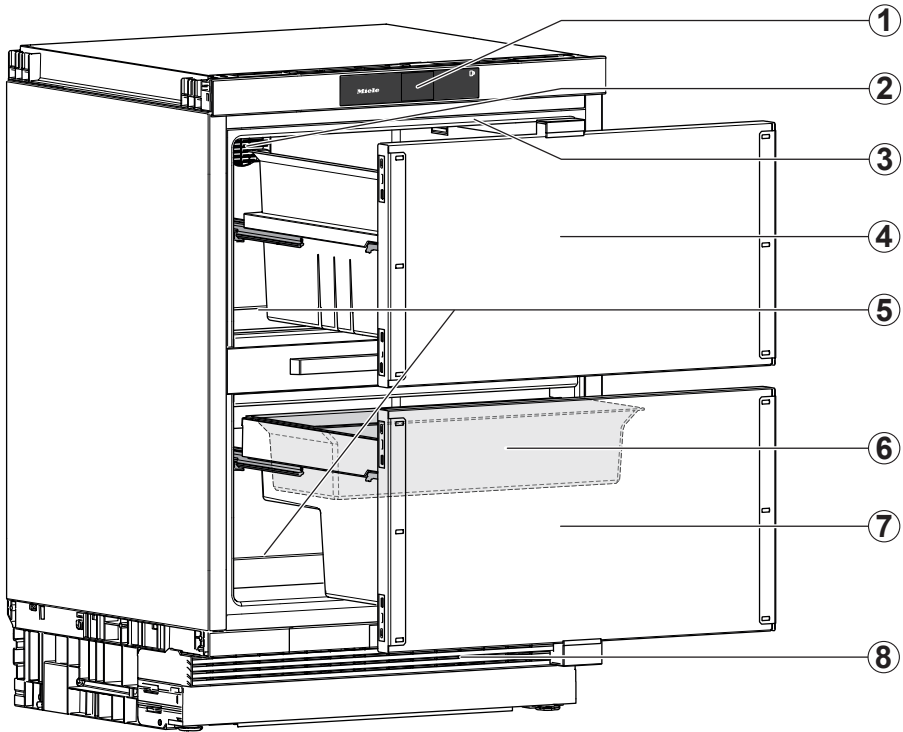



- ① Display
- ② Fan
- ③ Interior lighting (SmartLight):
The interior lighting adapts to the lighting conditions in the room.
- ④ Top built-under cooling drawer with adjustable divider rods
- ⑤ Condensate channel and condensate drain hole:
Precipitated condensate runs off and evaporates automatically.
- ⑥ Fruit and vegetable drawer (VeggieBox)
- ⑦ Bottom built-under cooling drawer with VeggieBox
- ⑧ Ventilation grille

Overview

Status display

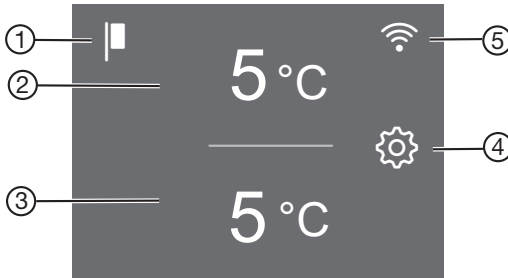
The display can be scratched by pointed or sharp objects, e.g., pens.
Only touch the display with your fingertips.
It is possible that the display will not react to finger contact if your fingers are cold.



- ① Demo-mode display
(only visible when the Demo-mode function has been switched on)
- ② Temperature display for the upper drawer and sensor button for setting the temperature
- ③ Temperature display for the lower drawer and sensor button for setting the temperature
- ④ Settings mode sensor control 
for adjusting various settings in Settings mode
- ⑤ Display for Miele@home connection status
(only visible when the Miele@home function has been set up)

Operating the refrigeration appliance via the display

- Touch the area/symbol you want on the status display.
- Swipe left or right across the display until the value/symbol you want is shown in the middle.
- Tap the option you want on the display to confirm.
The selected value/symbol will light up orange (except for a few exceptions).
- To leave the Settings level, tap  or *OK*.

Settings mode

Vacation mode

The Vacation mode function is useful when you go on holiday and, for example, you do not wish to switch off the fridge zone completely or do not need a high degree of cooling.

When Vacation mode is switched on, the fridge zone is regulated to a temperature of 60°F (15°C), thus remaining in operation while saving energy.

Food which does not spoil quickly can be stored in the refrigeration appliance for some time at this moderate fridge zone temperature. Energy consumption is lower than in normal operation. This also prevents the build-up of odors and bacteria which can occur if the fridge zone is switched off and the appliance door is closed.

Lock function /

When the lock function is switched on, it protects the refrigeration appliance from being switched off or adjusted unintentionally by unauthorized persons, e.g., children.

If you just want to quickly adjust the temperature, for example, you can deactivate the lock function temporarily.

Switching off the refrigeration appliance

See “Commissioning – Switching off the refrigeration appliance”.

Sabbath mode

The refrigeration appliance offers a Sabbath mode for the purposes of religious observance (see “Customizing settings”).

When Sabbath mode  is switched on, the following are deactivated temporarily:

- the interior lighting when the appliance door is opened
- all audible and visual signals
- the display
- an active Wi-Fi connection

All other functions switched on previously remain activated.

When Sabbath mode  is switched on, you cannot make any settings on your refrigeration appliance.

Information on Sabbath mode

You can call up the Sabbath mode version here.

Time before door alarm is triggered

You can set the time before the appliance door alarm is triggered here.

Miele@home

Your wine refrigerator is equipped with an integrated Wi-Fi module.

Networking is deactivated at the factory.

Here you can set up the Miele@home function for the first time, deactivate and activate the Wi-Fi, or reset the network configuration (see “Customizing settings”).

To use this feature, you will need:

- a Wi-Fi network
- the Miele app
- a Miele user account You can create a user account via the Miele app.

Overview

The Miele app will guide you as you connect your wine refrigerator to your home Wi-Fi network.

Once your wine refrigerator is connected to your Wi-Fi network, you can use the app to carry out the following activities, for example:

- Call up information on the operating status of your wine refrigerator
- Change the settings on your wine refrigerator

Connecting your wine refrigerator to your Wi-Fi network will increase energy consumption, even when the wine refrigerator is switched off.

Keypad tone /

You can switch the keypad tone on or off here (see “Customizing settings”).

Alarms and audible signals /

You can change the volume of the alarms and audible signals (e.g., in the event of a door alarm or a fault message) here. Alternatively, you can switch the alarms and audible signals off completely if you find them annoying (see “Customizing settings”).

Display brightness

You can adjust the display brightness to the lighting conditions in the room here.

Temperature unit °C/°F

You can set the required temperature unit (°Celsius or °Fahrenheit) here.

Demo mode

You can switch off demo mode here if it has been switched on as a default setting ( will appear on the display).

Demo mode allows the refrigeration appliance to be presented in the showroom without the cooling system being turned on. Do not activate this setting for domestic use.

Factory default settings

You can reset the refrigeration appliance’s settings to the default settings here.

Tip: Reset the refrigeration appliance’s settings to the default settings when disposing of your refrigeration appliance, selling it, or putting a used refrigeration appliance into operation. Depending on the model, this will reset the network configuration so that your personal data is deleted from the refrigeration appliance. It will also ensure that a previous owner is no longer able to access the refrigeration appliance.

Information about the refrigeration appliance

You can call up the model number and serial number of your refrigeration appliance here.

Keep this appliance data to hand; you will need it:

- for integrating the refrigeration appliance into your Wi-Fi network
- when reporting an appliance fault to Miele Service
- when retrieving information from the EPREL database

Safety

Door alarm

The refrigeration appliance is supplied with a door alarm to avoid increased energy consumption and food becoming warm if the door is left open.

If the appliance door is left open for a longer period of time,  will light up yellow in the temperature display. An alarm will also sound and the interior lighting will flash.

The amount of time before the door alarm is triggered can be changed (see “Customizing settings – Changing the time before the door alarm is triggered”).

The audible signal for the door alarm can be switched off (see “Customizing settings – Changing the volume of the alarms and buzzers”).

The alarm will stop and  will go out on the display as soon as the appliance door is closed.

Turning the door alarm off early

■ Tap .

The alarm will stop,  will go out, and the interior lighting will light up constantly.

If the appliance door is not closed, the door alarm will sound again after a short time.

Networking

Your refrigeration appliance is equipped with an integrated Wi-Fi module. The Wi-Fi module makes it possible to connect to your home network and to use the Miele app on a mobile device.

Once your refrigeration appliance has been connected via Wi-Fi, the connection is automatically re-established every time it is switched on.

Make sure that your Wi-Fi network signal is strong enough in the place where you intend to install your refrigeration appliance.

Connecting your refrigeration appliance to your Wi-Fi network will increase energy consumption, even when the appliance is switched off.

Smart Extras via the Miele app*

Networking via the Miele app gives you access to numerous Smart Extras, including:

- Access status information.
- Use additional helpful functions.
- Keep your refrigeration appliance up to date with the latest Miele developments via software updates.

You can find more detailed information about Smart Extras on the Miele website, in the Apple App Store®, or in the Google Play Store™.

*This is a separate digital offer from Miele & Cie. KG. The range of functions can vary depending on the model and the country. Acceptance of the General Terms and Conditions and Privacy Policy for Miele digital products and services in the Miele app required. Miele reserves the right to change or discontinue the digital offers at any time.

Overview

Appliance functions

SuperCool ❄️

When switched on, the SuperCool function ❄️ can be used to rapidly reduce the temperature in the **fridge zone** to its lowest setting (depending on the ambient temperature). The refrigeration appliance will work at full power and lower the temperature. Select this function for the rapid chilling of large amounts of fresh food or drink.

When the SuperCool function ❄️ is switched on, the appliance may make more noise than usual.

The SuperCool function ❄️ should be switched on **4 hours before** placing food or drinks in the fridge zone.

The SuperCool function ❄️ will switch itself off automatically after approx. 18 hours. The refrigeration appliance will then run at normal power again.

Tip: To save energy, you can switch off the SuperCool function ❄️ yourself once food and drinks are sufficiently chilled.

Adjusting the interior fittings

⚠️ Risk of damage due to heavy loads.

Loading food which is too heavy can damage the built-under drawer fridge.

Do not exceed the maximum load size of 44 lb (20 kg) in the top drawer and 32 lb (14.5 kg) in the bottom drawer.

Adjusting the divider rods in the top built-under cooling drawer

You can adjust the divider rods in the center of the unit to divide the built-under cooling drawer into compartments of various sizes.

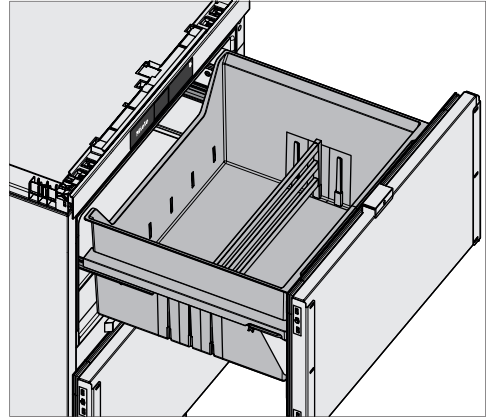

- Holding the divider rods on the right and left, pull them carefully up and off to remove them.
- You can bring the divider rods forward or move them back.

Removing and inserting built-under cooling drawers

The built-under cooling drawers can be removed for cleaning purposes.

- Pull the empty built-under cooling drawer out as far as it will go.

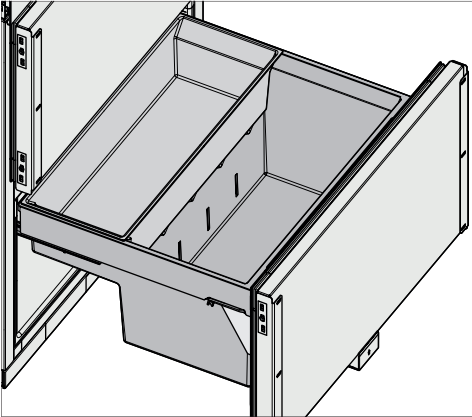

- Take hold of the sides of the built-under cooling drawer and pull it up at the front and back.
- Lift the front of the built-under cooling drawer slightly and pull it toward you at an angle to remove it.
- To insert the built-under cooling drawer, push it in and back at a slight angle and lower it until you hear it click into place.

Optional accessories

A range of useful Miele accessories and care products are available for your appliance.

Products specially tailored to your refrigeration appliance – such as appliance care products and accessories – are available from the Miele online store, Miele Service, or your Miele dealer.

You can access the Miele online store via the following QR code:



Commissioning

Before using for the first time

- Remove all packaging material and protective film.
- Clean the inside of the appliance and the accessories (see “Cleaning and care”).

Connecting the appliance

- Connect the refrigeration appliance to the electricity supply as described in “Electrical connection”.

Miele will then appear on the appliance display, followed by .

Switching on the appliance

- Open the appliance door.
- Tap  on the display.



The refrigeration appliance will start to cool and the interior lighting will come on when the appliance door is opened.

The refrigeration appliance will adjust to the preset temperature.

To enable the temperature to get sufficiently cold inside the refrigeration appliance, allow the appliance to run for a few hours. Do not place food in the refrigeration appliance until it has reached the preset temperature.

Switching off the appliance

You can only switch the entire refrigeration appliance off in Settings mode .

- Tap .
- Swipe left or right until  is shown in the middle.
- Tap .



The cooling and interior lighting are switched off.

 will appear in the display.

Please note: The refrigeration appliance is not disconnected from the power supply when it is switched off.

Turning off the upper drawer separately

The upper drawer can be switched off without having to switch off the lower drawer. This is useful, e.g., while of vacation.



- Touch the temperature display for the upper drawer.
- Swipe right until  is shown in the middle.
- Tap .

The temperature display for the upper drawer will go out.  will appear in the display.

The upper drawer will be turned off.

The temperature display for the lower drawer remains lit up.

Switching the upper drawer back on again separately

- Tap  in the temperature display for the upper drawer.
- Tap .

The upper drawer switches back on.

Switching off for longer periods of time

If, during a long absence, the refrigeration appliance is switched off but not cleaned and the door is left shut, there is a danger of bacteria building up inside the appliance.

It is essential to clean the refrigeration appliance before a long period of absence.

If the refrigeration appliance is not going to be used for a longer period of time, observe the following:

- Turn the appliance off.
- Unplug the appliance's electrical plug or switch off the breaker.
- Clean the refrigeration appliance and leave the door open to air the appliance and avoid odors building up inside.

Requirements for networking

Note the following requirements for networking:



1. A home network is available at the installation site.
Have the Wi-Fi password ready.
2. The Miele app is available on a mobile device.
3. You have a user account in the Miele app.

Miele App

The Miele App is available to download free of charge from the Apple App Store® or from the Google Play Store™.



Setting up Miele@home for the first time

- Tap the  symbol.
- Swipe left or right until the  symbol is shown in the middle.
- Tap the  symbol.
- Tap the connection method you wish to use (app or WPS).

After you have successfully logged in, the  symbol will appear on the display.

If a connection could not be established, the  symbol will appear.

- In this case, start the process again.
- To leave the Settings level, tap the  symbol.

Operation

Setting the temperature

- Touch the temperature display on the display.
- Swipe left or right until the temperature you want is shown in the middle.
- Tap the temperature you want to confirm.

The temperature display will then change back to the current temperature in the refrigeration appliance.

The temperature in the fridge zone increases:

- the more often the appliance door is opened and the longer it is kept open
- the more food that is stored in it
- the warmer the food is that is being put into it
- the higher the ambient temperature surrounding the refrigeration appliance is. This refrigeration appliance is designed for use within specific ambient temperatures (climate range). Do not use in ambient temperatures for which it is not designed.

Temperature range

The temperature can be set separately for each built-under cooling drawer from 32 to 57°F (0 to 14°C). The built-under drawer fridge therefore has two independent temperature zones.

Temperature display

In normal operation, the temperature display shows the **current average refrigerator section temperature** inside the refrigeration appliance.

Depending on the ambient temperature and the temperature setting, it can take the appliance a few hours to reach the

temperature required and for this temperature to then be shown as a constant temperature on the display.

Switching on SuperCool ❄️

The SuperCool function ❄️ should be switched on **4 hours before** placing food or drinks in the fridge zone.

When the SuperCool function ❄️ is switched on, the appliance may make more noise than usual.

- Touch the temperature display for the fridge zone.
- Tap ❄️.
- ❄️ will light up orange.
- Tap the temperature display to leave the settings level.

Switching off SuperCool ❄️

The SuperCool function ❄️ will switch itself off automatically after approx. 18 hours. The refrigeration appliance will then run at normal power again.

Tip: To save energy, you can switch off the SuperCool function ❄️ yourself once food and drinks are sufficiently chilled.

- Touch the temperature display for the fridge zone.
- Tap ❄️.
- ❄️ no longer lights up orange.
- Tap the temperature display to leave the settings level.

Storing food in the fridge zone

 Risk of explosion due to flammable mixes of gases.

Electrical components can cause flammable mixes of gases to ignite. Do not store any explosive materials or products containing flammable propellants (e.g., spray cans) in the appliance. The spray cans in question can be identified by the contents printed on the can or by a flame symbol. Electrical components can cause escaping gases to ignite.

 Risk of damage due to greasy or oily foods.

If storing food which contains a lot of fat or oil in the refrigeration appliance or the appliance door, make sure that it does not come into contact with plastic components as this could cause stress cracks or break the plastic.

Make sure that no fat or oil leaks onto the plastic parts of the refrigeration appliance.

If there is insufficient air circulation, the cooling performance will decrease and energy consumption will increase.

To allow air to circulate efficiently, do not store the food too close together or in direct contact with the rear panel.

Different storage zones

Due to natural air circulation, there are different temperature zones in the refrigerator section.

Cold, heavy air sinks to the lowest section of the refrigeration section. Make use of the different zones when placing food in the appliance.

This is a refrigeration appliance with automatic temperature distribution (DynaCool). The refrigeration appliance switches the fan on automatically when the cooling system for the fridge zone switches on. This means that the cold is distributed evenly in the fridge zone and the difference between the various temperature zones is less pronounced. All stored food is thus cooled to approximately the same temperature.

Warmest area

The warmest area in the refrigerator section is in the top section of the door. Use this for storing butter so that it remains spreadable and cheese so that it retains its flavor.

Coldest area

The coldest area in the fridge zone is directly above the fruit and vegetable drawer and at the back of the appliance.

A temperature setting of 39°F (4°C) combined with appropriate hygiene measures delays the growth of bacteria, e.g., salmonella and listeria, which can lead to serious food poisoning.

Therefore, you should use this area to store all delicate and highly perishable food, including:

- fish, meat, poultry
- cold cuts, ready-made meals
- dishes or baked goods containing eggs or cream

Operation

- fresh dough, cake mixtures, pizza dough, or pie dough
- raw milk cheese and other raw milk products
- hummus, vegetable spreads, plant-based cream cheese substitutes
- pre-packed vegetables
- other fresh food (with a label stating it should be kept at a temperature of around 39°F (4°C))

Tip: Store food in such a way that it does not touch the rear panel of the fridge zone. Otherwise the food could freeze to the rear panel.

Food which is not suitable for storage in the fridge zone

Not all food is suitable for refrigeration at temperatures below 40°F (5°C) because it is sensitive to cold.

Foods which are sensitive to cold include:

- pineapples, avocados, bananas, pomegranates, mangoes, melons, papayas, passion fruit, citrus fruits such as lemons, oranges, mandarins, grapefruits
- fruit which is not yet ripe
- eggplant, cucumbers, potatoes, peppers, tomatoes, zucchini
- hard cheeses (e.g., Parmesan)

Tip: The adjustable temperature range up to 57°F (14°C) provides the option to store food that is sensitive to cold.

Storing packaged food

Ensure that food stored in the fridge zone is in packaging or covered properly. This will prevent food odors from affecting other food, stop food from drying out, and also prevent any cross-contam-

ination of bacteria. This is particularly important when storing meat products. Make sure that food such as raw meat and fish in particular does not come into contact with other food.

By ensuring that the temperature settings are correct and by taking appropriate hygiene measures, you can prolong the storage life of your food considerably. This prevents food waste.

Fruit and vegetables

Store fresh fruit and vegetables in their packaging in the fruit and vegetable drawer (VeggieBox). Store cut fruit and vegetables covered or wrapped in an airtight container.

Protein-rich food

Please note that foods rich in protein deteriorate faster than others. Shellfish, for example, deteriorates faster than fish, and fish deteriorates faster than meat.

Storing food in the fruit and vegetable drawer (VeggieBox)

The VeggieBox provides good storage conditions for fruit and vegetables.

Food retains its own moisture if stored at a higher humidity and so does not dry out as quickly. The temperature is approximately equivalent to the temperature in the conventional fridge zone.

Remember that the fresher the food when it is placed in the appliance, the longer it will stay fresh.

Adjusting the humidity in the VeggieBox

The humidity level in the VeggieBox depends primarily on the type and quantity of food being stored, if stored unwrapped.

If the quantity of food being stored in this drawer is small, the humidity level may be too low.

- If you are only storing a small amount of food, wrap it in airtight packaging.

Operation



Observe the following tips if you find that food you have stored does not keep well (e.g., food becomes limp or wilts after only being stored for a short time):

- Only place fresh food inside the drawer, as the initial condition of the food is crucial to maintaining freshness.
- Clean the VeggieBox before storing food in it.
- Very wet food should be dried off first.
- Do not store food which is sensitive to cold in the VeggieBox (see “Storing food in the fridge zone – Food which is not suitable for storage in the fridge zone”).
- An increased humidity level in the humidity-controlled compartment is achieved with the moisture present in the food being stored if it is stored unwrapped. The more food stored in the compartment, the higher the humidity.
- Always store cut fruit and vegetables covered or wrapped in an airtight container.
- If too much moisture collects in the compartment and the food spoils, dry the floor and place a rack or similar item in the compartment so that excess moisture can drip down.
- If the humidity is too low when you are only storing a small amount of food, wrap the food in airtight packaging.

The door alarm and other warnings are automatically disabled when the appliance is in Settings mode .

Switching on Vacation mode

When Vacation mode  is switched on, the fridge zone is regulated to a temperature of 60°F (15°C), thus remaining in operation while saving energy.

- Tap .
- Swipe left or right until  is shown in the middle.
- Tap .

When Vacation mode is switched on,  lights up orange.



- To leave this Settings level, tap .

 Health risk caused by contaminated food.

The usability and quality of food in the refrigerator section may deteriorate if the temperature remains above 37°F (4°C) for an extended period. Only ever switch on the Vacation-mode function  for a limited period.

Do not store any temperature-sensitive food which spoils easily, such as fruit, vegetables, fish, meat, and dairy products, during this time.



Switching off Vacation mode

- Tap the  symbol.
- Swipe left or right until the  symbol is shown in the middle.
- Tap the  symbol.



When Vacation mode is switched off, the  symbol will light up white.

- To leave the Settings level, tap the  symbol.

Switching on the lock function /

- Tap the  symbol.
- Swipe left or right until the  symbol is shown in the middle.
- Tap the  symbol.

When the lock function is switched on, the  symbol will light up orange.

- To leave the Settings level, tap the  symbol.
- Close the appliance door. Only then will the lock function  be active.

Deactivating the lock function / temporarily

If you want to adjust the temperature, for example, you can deactivate the lock function temporarily:





- Touch the temperature display for the temperature zone you want to adjust.
- Touch  for approx. 6 seconds.

The display switches to the temperature controls.

- Now select the required settings.

Closing the appliance door will reactivate the lock function .

Switching off the lock function / completely

- Tap the  symbol.
- Touch the  symbol for approx. 6 seconds.
- Swipe left or right until the  symbol is shown in the middle.
- Tap the  symbol.





When the lock function is switched off, the  symbol will light up white.

Customizing settings

- To leave the Settings level, tap the ↩ symbol.

Switching Sabbath mode on

When Sabbath mode  is switched on, you cannot adjust any settings.

- Tap the  symbol.
 - Swipe left or right until the  symbol is shown in the middle.
 - Tap the  symbol.
- The  symbol lights up orange.
- To leave the Settings level, tap the ↩ symbol.

If Sabbath mode  is switched on, this is indicated on the display for approx. 3 s.





The display then switches off.

Ensure that the appliance door is properly closed, as visual and audible alarms are switched off.



Switching off Sabbath mode

The Sabbath mode function  will switch off automatically after approx. 80 hours.





However, you can switch off the Sabbath mode function  early.

- Tap the blank display.
- The  symbol appears.
- Tap the  symbol.
- The  symbol lights up orange.
- Tap the  symbol again.
- When Sabbath mode is switched off, the  symbol will light up white.
- To leave this Settings level, tap ↩.

Changing the time before the door alarm is triggered

- Tap the  symbol.
- Swipe left or right until the  symbol is shown in the middle.
- Tap the  symbol.
- Swipe left or right until the time you want between 30 seconds and 3 minutes 30 seconds is shown in the middle.
- Tap the setting you want to confirm.
- To leave the Settings level, tap the ↩ symbol.





Deactivating the Wi-Fi connection

- Tap the  symbol.
- Swipe left or right until the  symbol is shown in the middle.
- Tap the  symbol.
- Tap the  symbol to deactivate the Wi-Fi connection.

The  symbol appears.

- To leave the Settings level, tap the ↩ symbol.

Activating the Wi-Fi connection







- Tap the  symbol.
- Swipe left or right until the  symbol is shown in the middle.
- Tap the  symbol.
- Tap the  symbol to activate the Wi-Fi connection.

The  symbol appears.

- To leave the Settings level, tap the ↩ symbol.

When the Wi-Fi connection is active, the  symbol will light up on the display.

Resetting the network configuration



- Tap the  symbol.
- Swipe left or right until the  symbol is shown in the middle.
- Tap the  symbol.
- Swipe right until the  symbol is shown in the middle.
- Tap the  symbol.
- Tap the  symbol.
- To leave the Settings level, tap the  symbol.

All entered settings and values for Miele@home are reset to the default settings.

The Wi-Fi connection has been deactivated. The  symbol will go out on the status display.

Reset the network configuration if you are disposing of or selling your refrigeration appliance, or if you are putting a used refrigeration appliance into operation. All personal data is removed from the refrigeration appliance. This will also ensure that a previous owner is no longer able to access the refrigeration appliance.

Switching off the keypad tone

- Tap the  symbol.
- Swipe left or right until the  symbol is shown in the middle.
- Tap the  symbol.

When the keypad tone is switched off, the  symbol will light up white.

- To leave the Settings level, tap the  symbol.

Switching on the keypad tone

- Tap the  symbol.



- Swipe left or right until the  symbol is shown in the middle.

- Tap the  symbol.

When the keypad tone is switched on, the  symbol will light up orange.

- To leave the Settings level, tap the  symbol.

Changing the volume of the alarms and audible signals



- Tap the  symbol.
- Swipe left or right until the  symbol is shown in the middle.
- Tap the  symbol.
- Select the volume you want by swiping the segment bar to the left or right (level 1–7).
- If you want to switch the alarms and audible signals off completely, swipe to the left until the segment bar goes out completely.
- Confirm the setting you want by tapping the segment bar.

When the alarms and audible signals are switched off, the  symbol will light up white.

When the alarms and audible signals are switched on, the  symbol will light up orange.

- To leave the Settings level, tap the  symbol.

Changing the display brightness

- Tap the  symbol.
- Swipe left or right until the  symbol is shown in the middle.
- Tap the  symbol.
- Select the brightness you want by swiping the segment bar to the left or right (level 1–7).

Customizing settings

- Confirm the setting you want by tapping the segment bar.
- To leave the Settings level, tap the ↩ symbol.



Changing the temperature unit °C/°F

- Tap the ⚙ symbol.
- Swipe left or right until °C or °F is shown in the middle.
- Tap °C or °F to change the temperature unit.

°C or °F will appear on the display.



- To leave the Settings level, tap the ↩ symbol.

Switching off demo mode

- Tap the ⏻ symbol.
- Tap the ⚙ symbol.
- Swipe left or right until the  symbol is shown in the middle.
- Tap the  symbol.

After demo mode  has been switched off, the refrigeration appliance shuts down and must be switched on again.

Resetting the settings to their factory default settings

- Tap the ⚙ symbol.
- Swipe left or right until the  symbol is shown in the middle.
- Tap the  symbol.

The  symbol appears.

- Tap the  symbol.

The refrigeration appliance shuts down and must be switched on again.

The data plate located inside the interior cabinet of the refrigeration appliance must not be removed. The data plate contains information which is required in the event of a fault.

Do not let water get into the electronic or the lighting.

 Risk of damage due to moisture penetration.

The steam from a steam cleaner can damage plastic and electrical components.

Do not use a steam cleaner to clean the refrigeration appliance.

Cleaning water must not get into the drain hole.

Cleaning agents

Cleaning and care products used in the interior cabinet of the refrigeration appliance must be food safe.

To avoid damaging the surfaces of your appliance, **do not** use the following:





- cleaning agents containing soda, ammonia, acids, or chloride
- cleaning agents containing limescale remover
- abrasive cleaning agents, such as scouring powder, scouring liquid, or pumice stones
- cleaning agents containing solvents
- stainless steel cleaners
- dishwasher cleaning agents
- oven sprays
- glass cleaners
- hard, abrasive sponges and brushes, such as pot scrubbers

- eraser sponges
- sharp metal scrapers

We recommend using a clean sponge, lukewarm water with a little liquid dish soap to clean the surfaces of the appliance.

Preparing the refrigeration appliance for cleaning

Tip: Switch Cleaning mode  on. The cooling system in the refrigerator section is switched off, but the interior lighting remains switched on.

- Tap .
- Swipe left or right until  is shown in the middle.
- Tap .
- To leave this Settings level, tap .

If Cleaning mode  is switched on, this will be indicated on the status display.

- Take any food out of the appliance and store it in a cool place.
- Take out any removable accessories for cleaning (see “Removing, dismantling, and cleaning accessories”).

Cleaning the interior of the appliance

Clean the appliance regularly, or at least once a month.

If soiling is left on for any length of time, it may become impossible to remove under certain circumstances. Surfaces may become discolored or damaged.

It is therefore best to remove any soiling immediately.

Cleaning and care

- Clean the **interior** with a clean sponge, lukewarm water, and a little liquid dish soap.
- After cleaning, wipe with clean water and dry with a cleaning cloth.
- Clean the condensate channel and drain hole using a cotton swab or similar item.
- Leave the door open to air the refrigeration appliance sufficiently for a short while and to prevent odor build-up.

Cleaning accessories by hand or in the dishwasher

The following components must be cleaned **by hand** only:

- the stainless-steel trim
- the protective strips at the back of the adjustable shelves
- adjustable shelf with printing
- the fruit and vegetable drawer (VeggieBox)
- all drawers and compartment lids (these vary depending on model)

The following components are **dishwasher-safe**:

 Risk of damage due to high dishwasher temperatures.

Parts of the refrigeration appliance may become unusable, e.g., deform, if they are washed in the dishwasher at more than 130°F (55°C).

For dishwasher-safe components, always select dishwasher programs with a maximum temperature of 130°F (55°C).

Contact with natural dyes from carrots, tomatoes, and ketchup, etc., may discolor the plastic parts in the dishwasher. This discoloration does not affect the stability of the parts.

- the holder for the carbon filter (available as an optional accessory)

Cleaning the door seal

 Risk of damage as a result of incorrect cleaning.

If you treat the door seal with oils or grease, it can become porous.

Do not use any oils or grease on the door seal.



- The door seals should be cleaned regularly with clean water, and then wiped dry with a soft cloth.

Cleaning the ventilation gaps

A build-up of dust will increase the energy consumption of the appliance.

- The ventilation gaps should be cleaned on a regular basis with a brush or vacuum cleaner (you could use a Miele Vacuum Cleaner dust brush, for example).

After cleaning

- Switch the Cleaning mode function off again by tapping  on the status display.
- Tap  again.

When Cleaning mode is switched off, the  symbol will light up white.

The refrigeration appliance will start cooling again.

- Place all shelves and accessories back in the appliance.

- Switch on the Automatic Super-Cool ❄️ function for a while so that the temperature inside the refrigeration appliance will drop quickly.
- Place food in the refrigeration appliance as soon as it reaches the required coldness.
- Close the appliance door(s).

Automatic defrosting

This refrigeration appliance defrosts automatically.

Frequently asked questions

Many malfunctions and faults can be easily remedied. You can save time and money in many cases, as you do not need to contact Miele Service.

More information to help you rectify faults yourself can be found at <https://www.mieleusa.com/support/customer-assistance>.



To prevent cold from escaping, open the appliance doors as little as possible until the fault has been corrected.





Problem	Possible cause and solution
The refrigeration appliance is not cooling.	The refrigeration appliance has not been turned on. ■ Turn the refrigeration appliance on.
	The electrical plug is not inserted in the socket correctly or the plug connector is not inserted into the socket at the back of the machine correctly. ■ Insert the electrical plug into the socket and the plug connector into the machine socket.
	The circuit breaker has tripped. There could be a fault with the refrigeration appliance, the household electrical wiring, or another appliance. ■ Contact a qualified electrician or Miele Service.
The compressor runs continuously.	This is not a fault. To save energy, the compressor runs at a lower speed when less cooling is required. This increases the compressor run time.
The compressor is switching on more frequently and for longer periods of time; the temperature in the refrigeration appliance is too low.	The ventilation openings are obstructed or dusty. ■ Do not block the ventilation openings. ■ Clean the ventilation openings on a regular basis to remove any dust.
	The appliance door has been opened too frequently. A large amount of fresh food has been placed in the appliance. ■ Only open the appliance door when necessary and for as short a time as possible. After a while, the temperature will return to normal by itself.
	The appliance door is not properly closed. ■ Close the appliance door.

Frequently asked questions











Problem	Possible cause and solution
	<p>After a while, the temperature will return to normal by itself.</p>
	<p>The ambient temperature is too high. The higher the ambient temperature, the longer the compressor runs.</p> <ul style="list-style-type: none"> ■ See the information in “Installation – Installation site”.
	<p>The refrigeration appliance was not properly installed in the niche.</p> <ul style="list-style-type: none"> ■ Install the refrigeration appliance in the niche as described in the installation instructions.
	<p>The temperature setting in the refrigeration appliance is too low.</p> <ul style="list-style-type: none"> ■ Correct the temperature setting.
	<p>The SuperCool ❄️ function is still switched on.</p> <ul style="list-style-type: none"> ■ Switch off the SuperCool function ❄️ earlier yourself to save energy.
<p>The temperature in the refrigeration appliance is too high. The frozen food (depending on the model) could defrost.</p>	<p>This is not a fault. The temperature setting is too high.</p> <ul style="list-style-type: none"> ■ Correct the temperature setting. ■ Check the temperature again after 24 hours.
	<p>The ambient temperature is too low for this refrigeration appliance. If the ambient temperature is too low, the compressor will run less frequently. The temperature in the refrigeration appliance rises.</p> <ul style="list-style-type: none"> ■ See the information in “Installation – Installation site”. ■ Increase the ambient temperature.
<p>Ice or condensation has built up inside the refrigeration appliance. The appliance door may not close correctly.</p>	<p>The door seal has come out of its groove.</p> <ul style="list-style-type: none"> ■ Check that the door seal is correctly positioned in the groove.
	<p>The door seal is damaged.</p> <ul style="list-style-type: none"> ■ Check whether the door seal is damaged.
<p>The door seal is damaged or needs to be replaced.</p>	<p>No tools are required to change the door seal.</p> <ul style="list-style-type: none"> ■ Change the door seal. A replacement is available from Technical Service.

Frequently asked questions













Other problems

Problem	Possible cause and solution
An alarm does not sound even though the appliance door has been open for a long time.	<p>This is not a fault. The alarm has been switched off in Settings mode. If you want to switch the audible alarm back on again:</p> <ul style="list-style-type: none"> ■ Tap . ■ Swipe left or right until  is shown in the middle. ■ Tap . ■ Select the volume you want by swiping the segment bar to the right. ■ Confirm the setting you want by tapping the segment bar. <p>When the alarms and audible signals are switched on,  orange will appear.</p>
The pull-out will not extend fully.	<p>The telescopic runners are blocked.</p> <ul style="list-style-type: none"> ■ Pull firmly on the pull-out once so that it comes all the way out. <p>This will unblock the runners and the pull-out will push all the way back in again.</p>





Messages in the display

Message	Possible cause and solution
<p> lights up on the status display, the refrigeration appliance does not get cold even though the controls and the interior lighting are working.</p>	<p>Demo mode has been activated.</p> <ul style="list-style-type: none"> ■ Tap . ■ Tap . ■ Swipe left or right until  is shown in the middle. ■ Tap . <p>After Demo mode  has been switched off, the refrigeration appliance shuts down and must be switched on again.</p>
<p> is lit up on the display and the appliance cannot be used.</p>	<p>The Cleaning mode function is still switched on.</p> <ul style="list-style-type: none"> ■ Switch the Cleaning mode function off again by tapping on  on the status display. ■ Tap  again. <p>When Cleaning mode is switched off, the  symbol will light up white.</p> <p>The refrigeration appliance will start cooling again.</p>



Frequently asked questions

Message	Possible cause and solution
<p>Nothing is visible on the display. The display is completely blank.</p>	<p>Sabbath mode  is switched on: the interior lighting is switched off and the refrigeration appliance is cooling.</p> <ul style="list-style-type: none"> ■ Tap the blank display. <p> will appear on the display.</p> <ul style="list-style-type: none"> ■ Tap . <p> will light up orange.</p> <ul style="list-style-type: none"> ■ Tap  again. <p>When Sabbath mode is switched off,  will light up white.</p>
<p> is lit up on the display and the appliance cannot be used.</p>	<p>The safety lock function has been activated.</p> <ul style="list-style-type: none"> ■ Unlock the refrigeration appliance temporarily or switch the safety lock function off completely (see “Selecting additional settings – Deactivating the safety lock function / temporarily/switching off completely”).
<p> will light up yellow on the display, an alarm will also sound, and the interior lighting will flash.</p>	<p>The door alarm has been activated.</p> <ul style="list-style-type: none"> ■ Tap . <p>The alarm will stop,  will go out, and the interior lighting will light up again constantly.</p>







Frequently asked questions

Message	Possible cause and solution
<p> lights up red on the display and a fault code F with numbers may appear. An alarm is also sounding.</p>	<p>A fault has occurred.</p> <ul style="list-style-type: none"> ■ Tap  on the display to switch the alarm off. ■ Contact Miele Service. <p>To report the fault, you need the fault code and also the model number and serial number of your refrigeration appliance. You can access this information on the display:</p> <ul style="list-style-type: none"> ■ To do this, touch  on the display. <p>The appliance data required will be shown on the display.</p> <p>Confirm with  to exit the information display and the fault code will be shown again on the display.</p> <p>The refrigeration appliance can be switched off directly from the fault message display.</p> <hr/> <p>There is an appliance fault: This display always has priority over any settings which have just been selected.</p> <p>An appliance fault has priority over any current door and/or temperature alarms displayed.</p>

Interior lighting

Problem	Possible cause and solution
<p> Risk of electric shock due to exposed, live electrical components.</p> <p>When removing the lighting cover, there is a risk of coming into contact with live electrical components.</p> <p>Do not remove the lighting cover. The LED lighting may only be repaired or replaced by Customer Service.</p>	
<p> Risk of injury from LED lighting.</p> <p>This lighting corresponds to risk group RG 2. If the cover is defective, there is a risk of eye injury.</p> <p>If the lighting cover is defective, do not look from a close range directly into the lighting with optical instruments (e.g., magnifying glass or similar).</p>	

Frequently asked questions

Problem	Possible cause and solution
<p>The interior lighting is not working.</p>	<p>The refrigeration appliance has not been turned on.</p> <ul style="list-style-type: none"> ■ Turn the refrigeration appliance on.
	<p>Sabbath mode  is switched on: the display is dark and the refrigeration appliance is cooling.</p> <ul style="list-style-type: none"> ■ Tap on the black display. <p> will appear on the display.</p> <ul style="list-style-type: none"> ■ Tap . <p> lights up orange.</p> <ul style="list-style-type: none"> ■ Tap on the  symbol in Settings mode . <p>When Sabbath mode is switched off, the  symbol will light up white.</p>
	<p>To avoid overheating, the interior lighting switches itself off automatically after approximately 15 minutes if the appliance door is left open. If this is not the cause, there is a fault.</p> <ul style="list-style-type: none"> ■ Contact Miele Customer Service.
<p>The interior lighting is pulsating.</p>	<p>This is not a fault. The door alarm has been activated.</p>

Frequently asked questions

Causes of noises

The refrigeration appliance is producing various noises during operation. If the cooling performance is low, the refrigeration appliance will conserve energy but operate for longer. The volume will be lower. Food will be chilled faster if the cooling performance is high. The volume will be higher.

Normal noises	What is causing them?
Hissing	Refrigerant is being injected into the cooling circuit.
Bubbling, gurgling, splashing	Refrigerant is circulating through the pipes.
Humming	The refrigeration appliance is cooling.
Clicking	The thermostat is switching the compressor on or off.
Humming, whirring	The fan is running. Automatic door opening is opening or closing the appliance door.
Cracking	Materials are expanding inside the refrigeration appliance.
Rattling	Valves or flaps are active.
Buzzing (refrigeration appliances with water container)	Water is being pumped out of the water container.
Slurping (refrigeration appliances with soft-close mechanism)	The appliance door with soft-close mechanism is being opened or closed.

Please bear in mind that a certain amount of noise is unavoidable (from the compressor and the refrigerant circulating through the cooling circuit).

Frequently asked questions

Noises	Cause and solution
Vibrating, rattling, clinking	The refrigeration appliance is uneven. Use a level to check and adjust the alignment of the refrigeration appliance. The refrigeration appliance is aligned by raising or lowering the adjustable feet (depending on the model) underneath it. For niches of 55 1/8" (140 cm) and more: Place the stabilizing rods supplied underneath the appliance base.
	Drawers, baskets, or shelves are jiggling or are stuck. Check all removable items and refit them correctly.
	Bottles or containers are touching each other. Separate bottles or containers slightly.
	The transport cable clips (depending on the model) are hanging loose at the back of the appliance. Remove the transport cable clips.

Customer Service

Information to help you rectify faults yourself and about Miele spare parts can be found at www.miele.com/service.

Contact in the event of a fault

In the event of a fault which you cannot remedy yourself, please contact your Miele dealer or Miele Customer Service.

You can book a Miele Customer Service call online at www.miele.com/service.

Contact information for Miele Customer Service can be found at the end of this document.

Please quote the model identifier and serial number of your appliance (SN) when contacting Miele Customer Service. Both numbers can be found on the data plate inside the refrigeration appliance or, depending on the model, in Settings mode under Information **i**.

Appliance warranty and product registration

You can register your product and/or view the manufacturer's warranty terms and conditions for Miele appliances and vacuum cleaners at www.mieleusa.com.

Installation site

 **WARNING!** Risk of damage and injury due to the refrigeration appliance tipping over.

This refrigeration appliance is very heavy and can tip forward when the door is open.

Keep the appliance door(s) closed until the refrigeration appliance has been built in. The refrigeration appliance must be secured in its building-in niche in accordance with the operating and installation instructions.

 **Fire hazard and risk of damage from appliances that give off heat.** Appliances that give off heat can catch fire and set fire to the refrigeration appliance.

The power cord must not come into contact with heat sources.

This refrigeration appliance must not be installed underneath a cooktop.

 **Fire hazard and risk of damage from open flames.** Open flames can set fire to the refrigeration appliance.

Keep open flames (such as a candle) away from the refrigeration appliance.

 **Risk of damage caused by appliances discharging vapors.**

Installing appliances that discharge vapors behind the refrigeration appliance will put it at risk of damage.

Do not install appliances that discharge air or vapors behind the refrigeration appliance. Provide a separate air guide or install a partition wall between the appliances.

This appliance should be installed in a dry, well-ventilated room.

 **Risk of damage due to high humidity.**

In environments with high humidity, condensation can build up on external refrigeration appliance panels.

This condensation can cause corrosion on external appliance panels.

Install the refrigeration appliance in a dry and/or air-conditioned room with sufficient ventilation.

After installation please make sure that the appliance door(s) closes (close) properly and the refrigeration appliance is installed in accordance with these installation instructions.

The specified ventilation opening specifications must be observed.

When deciding on the installation site, please bear in mind that your refrigeration appliance will use more energy if installed near to a heater, a range, or another appliance that gives off heat.

Avoid direct sunlight.

The higher the ambient temperature, the longer the compressor runs and the higher the energy consumption is.

When installing the refrigeration appliance, please note the following:

- The electrical outlet must be easily accessible in an emergency and not concealed behind the appliance.
- The electrical plug and power cord must not touch the rear of the refrigeration appliance as they could be damaged by vibrations from the appliance.
- Do not plug in other appliances behind the refrigeration appliance.
- When installing the refrigeration appliance, make sure that the power cord does not get trapped or damaged.

Installation

- Do not position or operate power bars, distributor strips, or other electronic devices (such as halogen transformers) at the rear of the appliance.
- The floor at the installation site must be horizontal and level and must be as high as the surrounding floor.

Climate range

This refrigeration appliance is designed for use within specific ambient temperatures (climate range). Do not use in ambient temperatures for which it is not designed.

A lower ambient temperature leads to the compressor switching off for longer periods. This can cause the internal temperature in the refrigeration appliance to rise with the risk of food deteriorating and going off.

The climate range is stated on the data plate in the interior cabinet of the refrigeration appliance.

Climate range	Ambient temperature
SN	50 to 90°F (10 to 32°C)
N	61 to 90°F (16 to 32°C)
ST	61 to 100°F (16 to 38°C)
T	61 to 109°F (16 to 43°C)
SN-ST	50 to 100°F (10 to 38°C)
SN-T	50 to 109°F (10 to 43°C)

Ventilation

Ventilation takes place through a ventilation grille in the base of the refrigeration appliance.

 Fire hazard and risk of damage due to inadequate ventilation.

If the refrigeration appliance is not ventilated sufficiently, the compressor will run more frequently and for longer periods. This causes increased energy consumption and an increased compressor operating temperature, which can result in damage to the refrigeration appliance.

Please ensure that there is adequate ventilation around the refrigeration appliance.

It is essential to observe the required ventilation openings.

The ventilation openings must never be obstructed.

Clean the ventilation areas regularly to remove dust and dirt.

Side-by-Side installation

 Risk of damage due to condensation on external appliance panels.

In environments with high humidity, condensation can build up on external appliance panels, which can cause corrosion.

Do not place different refrigeration appliances directly next to or on top of one other.

Your refrigerator must not be installed as part of a “side-by-side” installation because it is not equipped with built-in heating units in the side panels.

This refrigeration appliance can, however, be Side-by-Side with certain models that are equipped with integrated heating in their side panel, as long as they are installed in separate building-in niches.

Please contact your dealer for specific information about which combinations will work with your machine.

Weight of the cabinet door

 Risk of damage from cabinet doors that are too heavy.

Installing a cabinet door which is heavier than the maximum permitted weight could damage the built-under drawer fridge. This damage can affect various factors, such as operation of the appliance.

Before installing cabinet doors, check that the weight of the door does not exceed the maximum permitted weight.

The maximum permissible weight of the cabinet door is 11 lb (5 kg).

Installation

Installation dimensions

Niche/Side view

The refrigeration appliance will function correctly if the specified ventilation openings are kept clear.

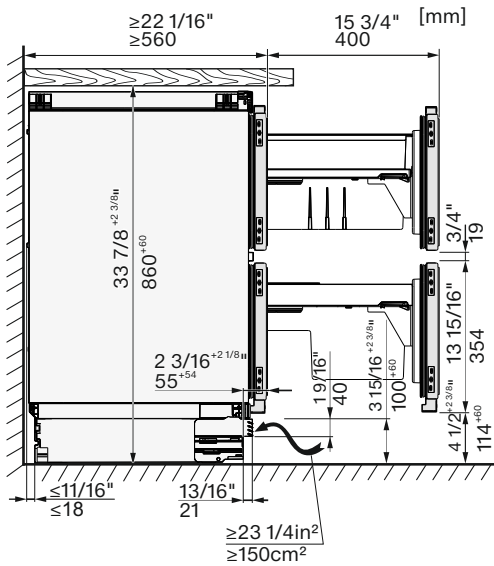
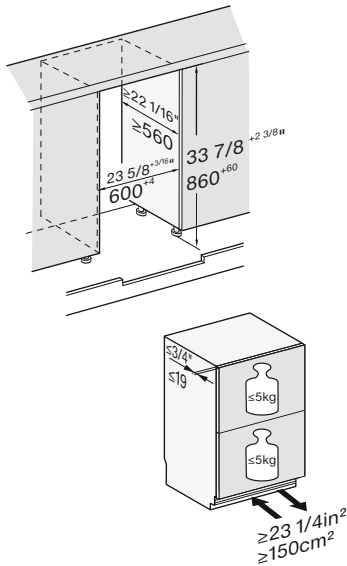

Example

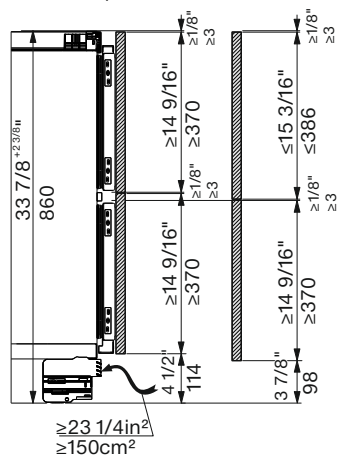

Connections

[mm]

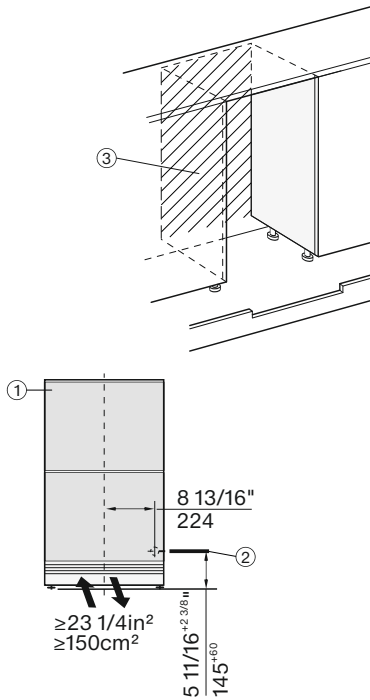

- ① Front view
- ② Power cord, length = 86" (2,200 mm)
- ③ No connections permitted in the rear panel

Installation

Building in the appliance

To install the refrigeration appliance, you will need the following tools:

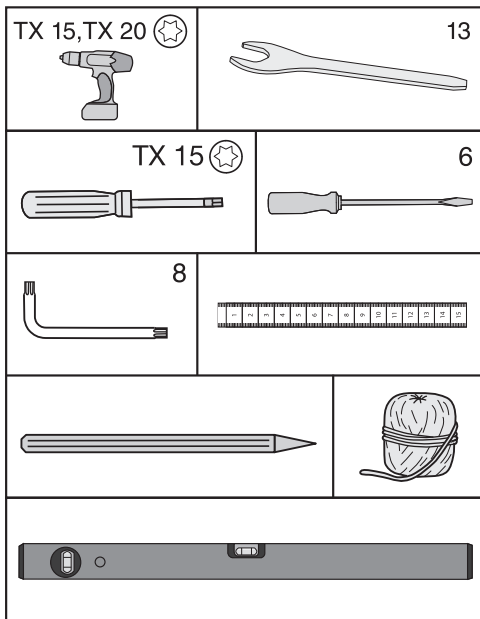

Tip: Store the enclosed metal rod in a safe place. It is required for adjusting the rear appliance feet.

Preparing the refrigeration appliance

- Position the refrigeration appliance directly in front of the niche.
- Take hold of the toe-kick facing from the side and pull it forward and off.

You can choose to secure your refrigeration appliance in one of two different ways:

1. Secured at the top
This method is suitable for securing the appliance underneath a plastic countertop, e.g., laminate. The countertop must be suitable for screwing fixing brackets to.

With the adjustable feet fully extended, the refrigeration appliance should fit fairly tightly between the floor and the countertop.

2. Secured at the side
This method is suitable for securing the appliance underneath a solid countertop, e.g., granite. The cabinet side walls to the right and left of the refrigeration appliance must be suitable for screwing fixing brackets to. With the adjustable feet fully extended, the refrigeration appliance should sit lower than the countertop.

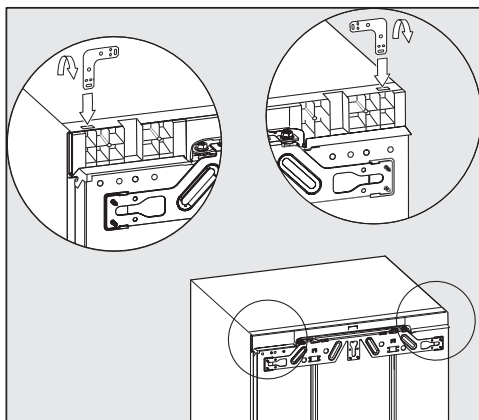

1. Secured at the top
 - Install the bracket in the slot in the top of the appliance.
 - Bend the bracket at the perforated position.

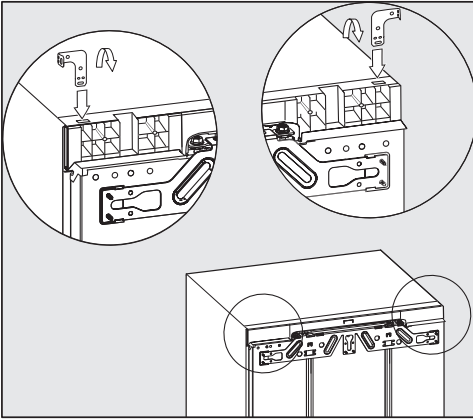

2. Secured at the side

Both ends of the bracket must be bent.

- Install the bracket in the slot in the top of the appliance.
- Bend the bracket at the perforated position.
- Remove the bracket from the slot and insert the straight end of the bracket.
- Now bend this end of the bracket at the perforated position.

Positioning the refrigeration appliance

⚠ Risk of damaging the power cord. When pushing the refrigeration appliance into its niche, the power cord can get trapped and damaged. Carefully push the refrigeration appliance into the niche.

⚠ Risk of damaging the floor. Moving the refrigeration appliance can cause damage to the floor. Move the refrigeration appliance carefully on floors that are sensitive to scratching.

⚠ Risk of damaging the adjustable feet.

The adjustable feet can break off. The adjustable feet should be almost fully screwed in when you push the refrigeration appliance into the niche.

Tip: Before pushing the appliance into the niche, loosen the two rear feet by half a turn. After pushing it into the niche, the feet will be easier to adjust from the front (see “Aligning the refrigeration appliance”).

- Lay the power cord so that the refrigeration appliance can be connected easily once installed.

Tip: Tie a piece of string to the electrical plug to “lengthen” the power cord; this will help you to push the appliance into position.

Then pull the power cord through the cabinet by the other end of the string.

If the refrigeration appliance is pushed too far into the niche, the appliance door may not close properly once the cabinet doors have been installed. This can cause ice to build up and condensation to accumulate, and cause the appliance to malfunction. These issues can all lead to increased energy consumption.

Push the refrigeration appliance into the niche, making sure a gap of **1 5/8" (42 mm)** is maintained all around between the appliance casing and the front of the cabinet side walls.

- Push the refrigeration appliance into the niche until the front edges of the hinges at the top and bottom are flush with the front edge of the cabinet side wall.

Installation

This ensures a gap of **1 5/8" (42 mm)** to the front edges of the cabinet side walls all the way round.

On **cabinets with door fittings (e.g., knobs, raised seals)**, the dimension of these must be taken into account to ensure that there is a gap of **1 5/8" (42 mm)** all round.

- Pull the refrigeration appliance forward by the appropriate dimension.
- Check again to make sure there is a gap of **1 5/8" (42 mm)** to the front edges of the door fittings all the way round.

Tip: If possible, remove the door fittings and push the refrigeration appliance into the niche until all fixing brackets at the top and bottom are touching the front edge of the cabinet side wall.

Aligning the refrigeration appliance

When securing the refrigeration appliance in the niche at the top, it should fit fairly tightly between the floor and the countertop.

- Adjust the front and rear feet in turn to fit the niche height and make sure the refrigeration appliance is correctly aligned.

Proceed as follows:

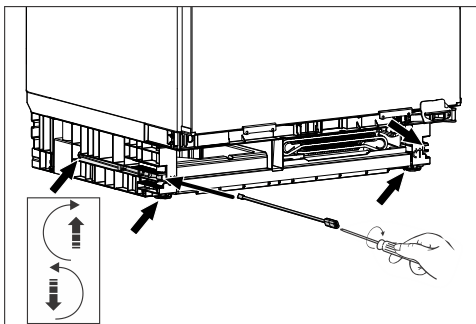

- Adjust both rear feet with appropriate screws at the front right and left in the base using the rod supplied and a flat-head screwdriver.
- Unscrew the two front feet alternately with the rear ones. The maximum adjustment range is 2 3/8" (6 cm).

Tip: As soon as the adjustable feet have been unscrewed slightly, you can adjust them with a screwdriver at the bottom of the foot.

The foam ① attached to the ventilation grille ensures the airflow is separated to prevent malfunctioning of the appliance.

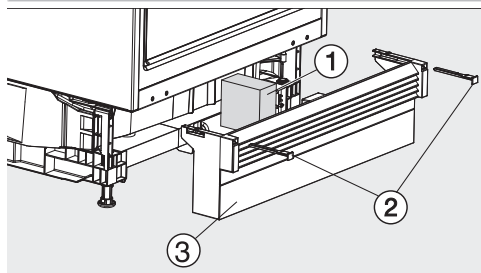

- Move the toe-kick facing and ventilation grille ③ into position, but do not fix it in place yet.

Without a continuous toe-kick facing:

- Pull the toe-kick facing ③ forward until the ventilation slots are in alignment with the adjacent cabinet toe-kick facings.

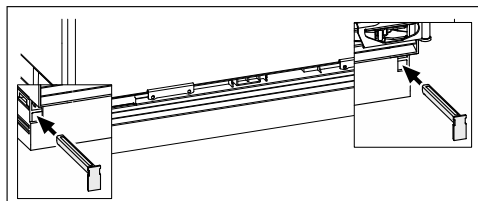

- Hold the toe-kick facing securely and screw it into place on the right and left using the bolts supplied ②.

With the toe-kick facing attached, the rear feet can only be adjusted when the toe-kick facing is fully inserted. Otherwise, the rod is not long enough.

With a continuous toe-kick facing:

- Push the plinth panel with the ventilation grille ③ right up against the refrigeration appliance, and attach it to the right and left using the bolts ②.

If a continuous toe-kick facing is to be installed, a suitable ventilation gap will need to be cut into it for the refrigeration appliance's ventilation grille.

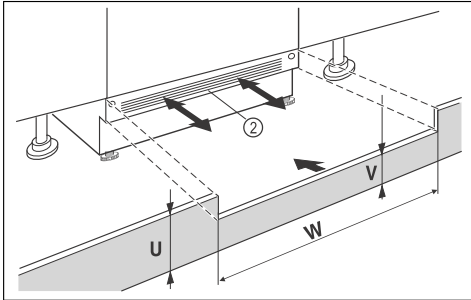

- Trim the toe-kick facing (U) to the correct height.
- Adjust the height (V) along the niche width (W) underneath the appliance toe-kick facing ②.

Securing the refrigeration appliance in the niche

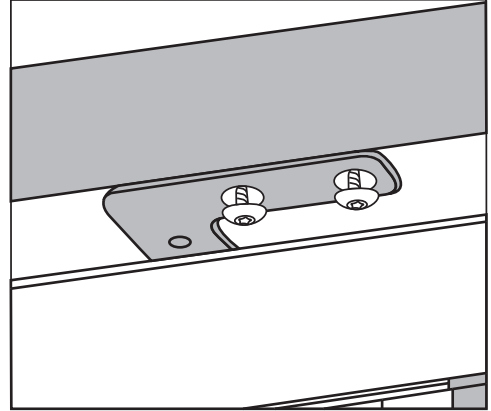

1. Secured at the top

- Screw the refrigeration appliance in place underneath the countertop with two screws in each case.

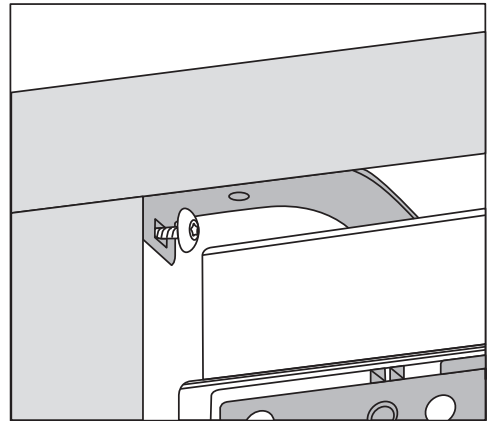

2. Secured at the side

- Screw the refrigeration appliance into the niche on the right and left with one screw in each case.

Installation

Installing cabinet doors

If installed in a run of units, make sure that the top edge of the top cabinet door is at the same height as the cabinet doors of adjoining units.

The cabinet doors must be mounted free of tension.

The next section provides instructions for installing cabinet doors with a cabinet front that is at least $5/8''-3/4''$ (16–19 mm) thick.

Ensure that the toe-kick facing is re-installed correctly.

- Install the handles on both cabinet doors first, as it is impossible to do this afterwards.
- So that the built-under cooling drawers will pull out evenly, be sure to install the handles centrally.

Installing the top cabinet door

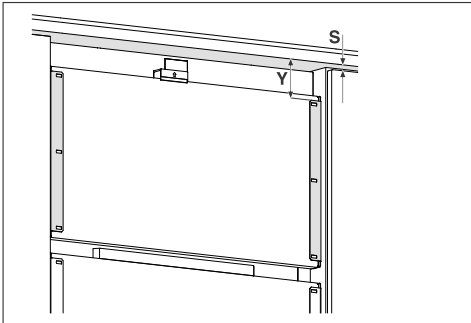

- Determine the dimension **Y** from the lower edge of the cabinet front to the fixing bracket.
- Determine the dimension **S** from the lower edge of the cabinet front to the upper edge of the cabinet door.

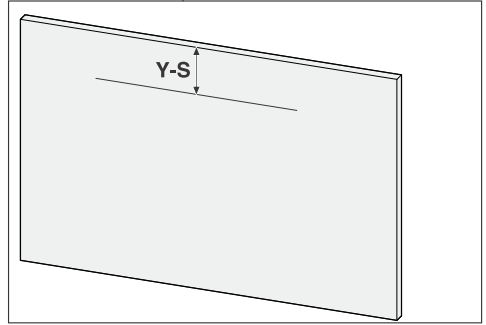

- Transfer the dimension **Y-S** to the cabinet door.

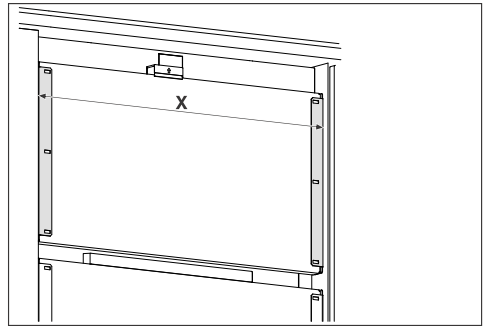

- Determine the distance **X** between the outer edges of the fixing brackets.

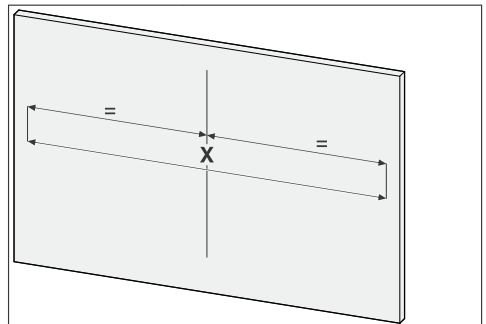

- Transfer dimension **X** to the cabinet door.

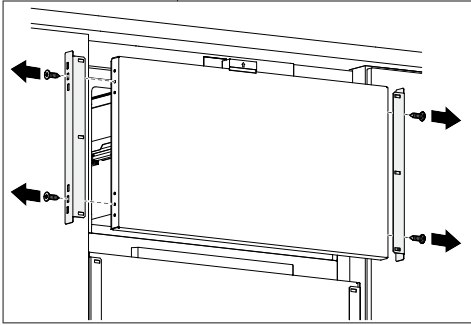

- Remove the two fixing brackets.

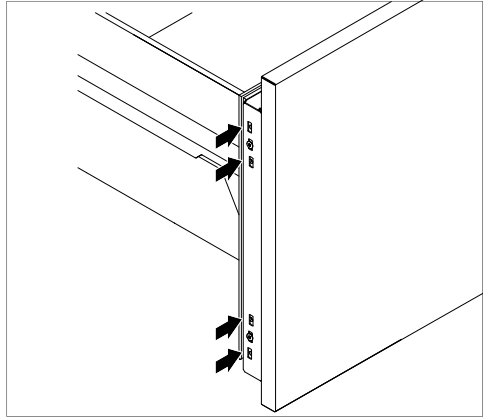

- You can use the different screw positions to align the cabinet door by moving the screws to the top or bottom position.

The top cabinet door is fitted.

Installing the bottom cabinet door

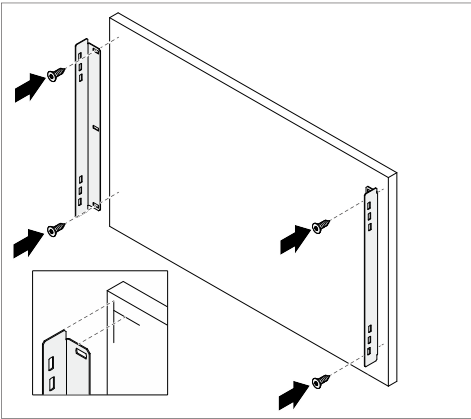

- Fit the fixing brackets to the cabinet door.

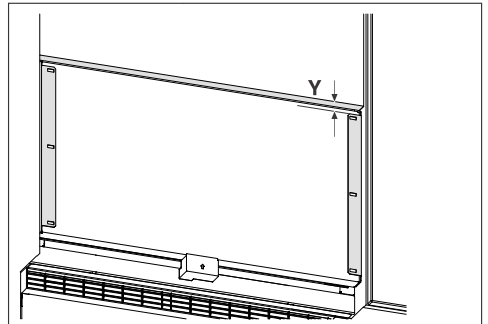

- Determine the dimension Y from the bottom edge of the cabinet door to the fixing bracket.

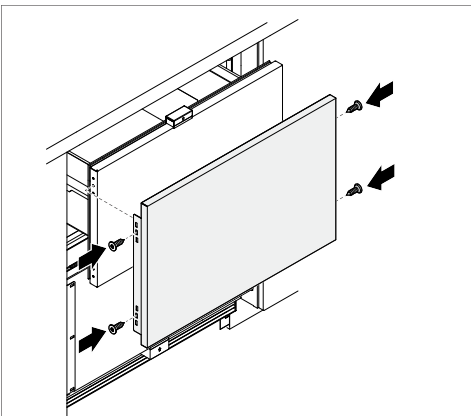

- Attach the cabinet door to the top built-under cooling drawer.

Installation

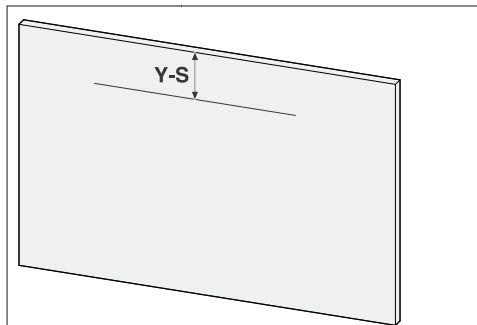

- Transfer the dimension **Y-S** to the cabinet door.

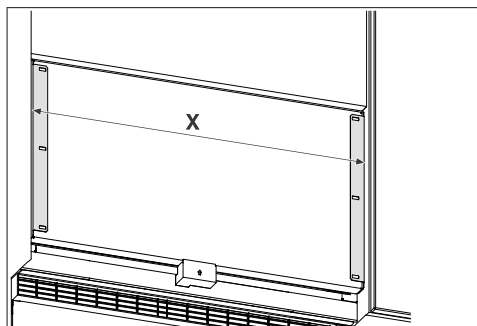

- Determine the distance **X** between the outer edges of the fixing brackets.

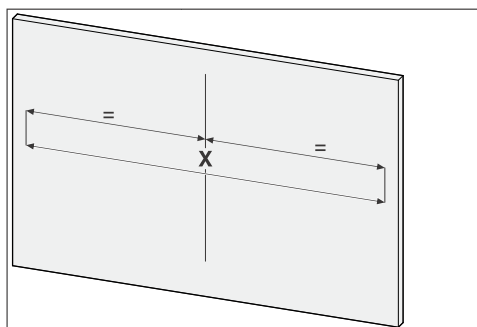

- Transfer dimension **X** to the cabinet door.

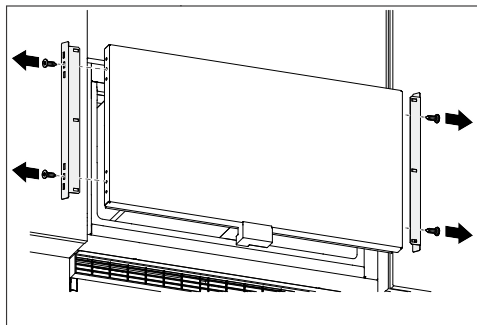

- Remove the two fixing brackets.

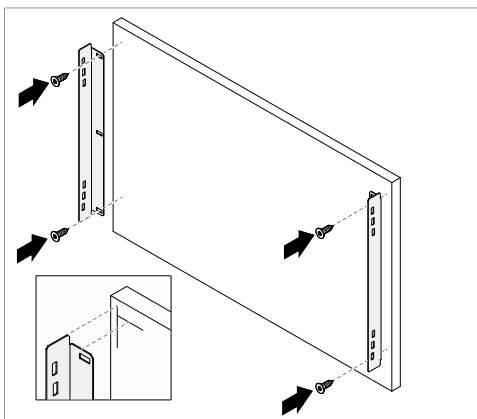

- Fit the fixing brackets to the cabinet door.

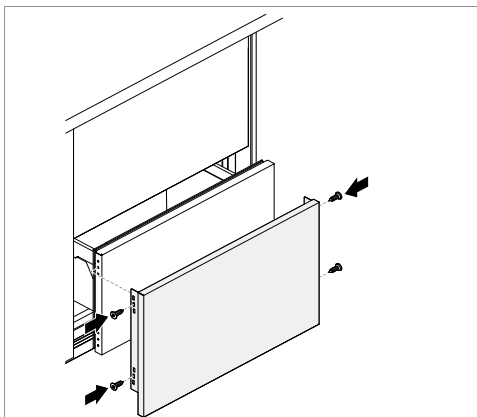

- Attach the cabinet door to the bottom built-under cooling drawer.

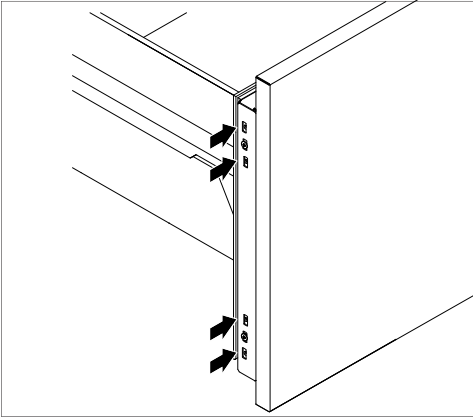

- You can use the different screw positions to align the cabinet door by moving the screws to the top or bottom position.

The bottom cabinet door is fitted.

Installation

Electrical connection



Risk of electric shock!

The appliance must only be switched on when it has been installed in accordance with the installation instructions.

Ground the appliance.

The appliance must not be grounded via a gas pipe.

If in doubt, have a suitably qualified and experienced electrician check that the installation complies with relevant regulations.

Do not install a fuse into neutral current or grounding electrical circuit.

Do not use extension cords or ungrounded (two prong) adapters.

Do not use a frayed or damaged power cord.



Risk of electric shock!

For protection against electric shock, this appliance is equipped with a pole-free plug which is protected against reverse polarity. The electrical outlet must be properly grounded.

Do not remove the round grounding connector pin from the plug.

Use only a grounded plug adapter.

Wait for 1 hour after installation before plugging the appliance into the power supply. This allows coolant and refrigerator oil to settle in accordance with regulations.

Ensure that the voltage of the power supply corresponds with the connection voltage of the appliance. A power supply of 110–120 V, 60 Hz and 10–16 Amp, which is protected by a power switch or a fuse, is required to operate the appliance.

The manufacturer recommends operating the appliance on a dedicated circuit to avoid overloading the electrical circuit.

All relevant legal electrical, fire, and building regulations must be observed when installing the electrical outlet and/or the appliance.

In certain countries, appliances are required to be connected to the electrical supply via a wall-mounted ON/OFF switch.

To avoid the risk of fire, electric shock, or other injuries, the appliance must be installed and connected by a suitably qualified electrician in accordance with all relevant local and national regulations and standards, including fire prevention.

The socket must not be concealed behind the appliance and must be easily accessible so that the appliance can be quickly disconnected from the electrical supply in case of an emergency.

If the outlet is no longer accessible after installation, an additional means of disconnection must be provided for all poles. Suitable means of disconnection include switches with an all-pole disconnect device with a contact opening of at least 1/8" (3 mm). These can be circuit breakers, fuses, and relays.

The plug and power cord must not come into contact with the back of the appliance as vibrations can cause damage to these components. This could result in a short circuit.

Do not plug other appliances into electrical outlet behind this appliance.

Temporary or permanent operation on an autonomous power supply system or a power supply system that is not synchronized with the grid power supply (e.g., island networks, back-up systems) is possible. A prerequisite for operation is that the power supply system complies with the specifications of EN 50160 or an equivalent standard. The function and operation of the protective measures provided in the domestic electrical installation and in this Miele product must also be maintained in isolated operation or in operation that is not synchronized with the grid power supply, or these measures must be replaced by equivalent measures in the installation.

If the power cord needs to be replaced, this must be performed by a qualified technician.

Connecting the appliance

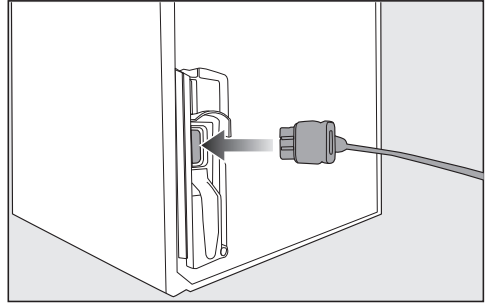

- Insert the electrical plug into the back of the refrigeration appliance.

Make sure that the electrical plug has clicked into position correctly.

- Insert the electrical plug of the refrigeration appliance into the socket.

The refrigeration appliance is now connected to the electricity supply.

Declaration of conformity

Frequency range	2.412 GHz – 2.462 GHz
-----------------	--------------------------

Maximum transmitting power	< 100 mW
----------------------------	----------

Copyrights and licenses

For the purpose of operating and controlling the communication module, Miele uses proprietary or third-party software that is not covered by open source licensing terms. This software/these software components are protected by copyright. The copyrights held by Miele and third parties must be respected.

In addition, the integrated communication module contains software components which are distributed under open source licensing terms. You can access these open source components along with the associated copyright notices, copies of the valid licensing terms, and any additional information locally via IP using a web browser ([http\[s\]://<ip address>/Licenses](http[s]://<ip address>/Licenses)). The liability and warranty arrangements for the open source licenses displayed in this location only apply in relation to the respective rights holders.

Please have the model and serial number
of your appliance available when
contacting Customer Service.

U.S.A.

Miele, Inc.

National Headquarters

9 Independence Way
Princeton, NJ 08540
www.mieleusa.com

Customer Support

Phone: 888-99-MIELE (64353)
info@mieleusa.com

International Headquarters

Miele & Cie. KG
Carl-Miele-Straße 29
33332 Gütersloh
Germany

Canada

Importer
Miele Limited

Headquarters and Miele Centre

161 Four Valley Drive
Vaughan, ON L4K 4V8
www.miele.ca

Customer Care Centre

Phone: 1-800-565-6435
905-532-2272
contact@miele-support.ca

