

Operating Instructions Laboratory Glassware Washer

ExpertLine
PLW 8683 CD





To prevent accidents and machine damage, read these instructions **before** installation or use.

en-US, CA









Guide to the manual	6
Applicable symbols	6
Symbols and conventions used in this document.....	7
Definition of terms	7
IMPORTANT SAFETY INSTRUCTIONS	8
Symbols on the machine	12
Machine description	13
Machine overview Machine with stainless steel door.....	13
Machine overview Machine with glass door.....	14
Control panel.....	15
Buttons on the control panel	16
Appropriate use	17
General description.....	17
How it works	17
Intended use	17
Intended user group.....	18
Installation requirements	18
Contraindications	18
Foreseeable misuse	19
User profiles	20
Daily operators.....	20
Administration	20
Operating	21
Operation via control panel.....	21
Display screens.....	21
Switching on.....	22
Switching off	23
Standby/Off.....	23
Touch display.....	23
Selecting the language	25
System messages i	26
Fault messages !	26
Help button	27
Networking (📶 or L).....	27
Commissioning	28
Opening and closing the door	33
Comfort Door Lock.....	33
Opening the door.....	33
Close the door.....	33
Opening the door using the emergency release	34
Water hardness	35
Water softening	35
Setting the water hardness.....	35
Reactivation salt	38
Filling the container for reactivation salt	38
Salt refill indicator.....	41
Canceling machine lock due to lack of salt.....	42
Load carriers	43
Mobile units, baskets, modules and inserts.....	43

Contents

Height-adjustable upper baskets	44
Wash pressure measurement	46
Application technology	47
Arranging the wash items.....	47
Preparing the wash items.....	48
Checks before starting a program.....	49
After reprocessing	50
Process validation.....	50
Laboratory glassware	50
Chemical processes and technology	51
Adding and dispensing process chemicals	54
Process chemicals	54
Process chemicals.....	54
Neutralizing agent.....	55
Rinse aid.....	55
Dispensing systems	56
Color coding on the suction lances	56
Replacing the media canister	56
Setting the dispensing concentration	58
Operation	59
Selecting a program	59
Program information	59
Starting a program	60
Selecting and deselecting additional functions	60
Starting a program immediately	60
Starting the program using a timer	60
Program cycle display	62
End of the program.....	63
Acknowledging the end of the program	63
Displaying program information	63
Batch control.....	63
Interrupting a program.....	65
Canceling a program	66
Program canceled due to a fault.....	66
 Machine functions.....	68
Filter interval.....	69
Dispensing systems	70
Filling dispensing paths	70
Rinsing dispensing paths.....	71
AutoClose	72
Documentation	73
 Settings.....	74
Display brightness.....	74
Volume	75
Welcome tone.....	75
Lighting.....	76
Process documentation.....	77
Logging process data	77
Communication modules.....	78

Maintenance measures	79
Maintenance	79
Routine checks	79
Cleaning the filters in the wash cabinet	80
Checking and cleaning the spray arms	81
Cleaning the machine	83
Checking the load carriers	84
Filter change	85
Replacing the coarse filter	85
Replacing the HEPA filter	86
Process validation	87
Troubleshooting	89
Technical faults and messages	89
Maintenance and testing	89
Dispensing/dispensing systems	90
Insufficient salt/water softener	91
Filters	91
Cancel with fault code	92
Door	93
Unsatisfactory cleaning and corrosion	94
Spray arm monitoring/conductivity/wash pressure	96
Noises	97
Frequently asked questions	98
Cleaning the drain pump and non-return valve	98
Cleaning the filters in the water inlet	99
After sales service	100
Contacting Miele Service	100
Installation	101
Setup and alignment	101
Hose holder	102
Lid	103
Built-under a continuous countertop	104
Electromagnetic compatibility (EMC)	105
Electrical connection	106
Additional equipotential bonding	106
Plumbing	107
Connecting the water supply	107
Non-pressurized (gravity feed) DI water connection 1.3 - 8.7 psi (8.5 - 60 kPa)	108
Connecting the water drain	109
Program chart	110
General program information	110
Programs for specific soiling	111
Programs for specific wash items	111
Additional programs	112
Technical details	113
Caring for the environment	115
Disposal of packaging material	115

Applicable symbols

Symbol	Legend
	For warnings and safety notes; see “IMPORTANT SAFETY INSTRUCTIONS”
	Mandatory sign; see “IMPORTANT SAFETY INSTRUCTIONS”
	Observe the operating instructions
	MET symbol
	EMC symbol of the VDE
	Do not dispose of electrical machines in household waste; they need to be disposed of separately, see “Disposal of your old machine”
	Manufacturer

Symbols and conventions used in this document

Warnings

 Warnings contain information related to safety. This alerts you to the potential danger of injury to people or damage to property. Read the warnings carefully and follow the instructions and directions.

Notes

Notes contain information that is particularly important to follow.

Additional information and comments

Additional information and comments are contained in a simple frame.

Operating steps

Operating steps are indicated by a black square bullet point.

Example:

■ Select an option.

Display

Display text is indicated by a particular font.

Example:

Save.

Definition of terms

Machine

In these operating instructions, this device is referred to as "the machine".

Wash items

The term "wash items" is used wherever the items to be reprocessed are not defined in any further detail.

Load carriers

Unless otherwise specified, all components and parts for holding wash items are referred to as load carriers, e.g., mobile units, baskets, modules, inserts, injector nozzles, etc.

Process chemicals

All media dispensed during a program sequence are generally referred to as process chemicals, e.g., cleaning agents.

Wash water

The term "wash water" refers to water or to a mixture of water and process chemicals.

Cycle

Machine-based cleaning and reprocessing procedures are generally referred to as cycles.

IMPORTANT SAFETY INSTRUCTIONS

This machine complies with all statutory safety requirements. However, inappropriate use can lead to personal injury and material damage.

Read these instructions carefully before using the machine for the first time to avoid the risk of accidents and damage to the machine. Keep these instructions in a safe place where they are accessible to users at all times.

Proper use

► Use of this machine is only approved for the applications stated in the operating instructions. Conversions, modifications, and any other use are not permitted and could be dangerous.

The cleaning and disinfection processes are only designed for laboratory glassware which are designated as reprocessible by the manufacturer. The information provided by the manufacturer of the wash items must be observed.

► Observe the IMPORTANT SAFETY INSTRUCTIONS provided by the wash item manufacturers and their instructions on how to handle the wash items correctly.

► This machine is intended for indoor use in a stationary location only.

Risk of injury

Please pay attention to the following notes to avoid injury.

► The cleaning machine should only be commissioned, repaired, and maintained by Miele Service or a qualified specialist authorized by the manufacturer of the machine. A Miele service contract is recommended to ensure full compliance with the normative and regulatory provisions. Incorrect repairs can cause considerable danger to users.

► Do not install the machine in an area where there is any risk of explosion or of freezing conditions.

► In order to reduce the risk of water damage, the area around the machine should be limited to furniture and fittings that are designed for use in commercial environments.

► Some metal parts pose a risk of injury/being cut. Wear cut-resistant protective gloves when transporting and setting up the machine.

► The machine must not be installed in the immediate vicinity of room doors. When the wash cabinet door is open, it could block the room doors, locking people in or out. If the wash cabinet door also protrudes into the walkway, it poses a tripping hazard and could block possible escape routes.

► If the machine is installed under a countertop, it must be installed under a continuous countertop which is firmly secured to adjacent units to achieve the necessary stability.

► The electrical safety of the machine can only be guaranteed when correctly grounded. It is essential that this standard safety requirement is observed and regularly tested. If in any doubt, please have the electrical installation inspected by a qualified electrician.

► A damaged or leaking machine can pose a threat to your safety. Always switch off a damaged or leaking machine immediately and contact Miele Service.

IMPORTANT SAFETY INSTRUCTIONS

- ▶ Label machines which have been taken out of operation and lock them to prevent them being switched on again without authorization. The machine may only be put back into operation once it has been successfully repaired by Miele Service or by an appropriately qualified specialist.
- ▶ Personnel operating the machine should be trained regularly. Untrained personnel must not be allowed access to the machine or its controls.
- ▶ Only use process chemicals which have been approved by their manufacturer for the relevant application. The manufacturer of the process chemicals is liable for any negative influences on the material of the wash items and the machine.
- ▶ Use caution when handling process chemicals. These may contain irritant, corrosive or toxic ingredients. Please observe the process chemical manufacturer's safety instructions and safety data sheets. Wear protective gloves and goggles.
- ▶ The machine is designed for operation with water and recommended additive process chemicals only. Organic solvents and flammable liquid agents must not be used as this could cause an explosion, damage rubber or plastic components in the machine and cause liquids to leak out of it.
- ▶ The water in the wash cabinet is NOT safe to drink!
- ▶ Do not lift the machine by protruding parts such as the control panel or the opened service flap as these could be damaged or torn off.
- ▶ Do not sit or lean on the opened door. This could cause the machine to tip and get damaged or cause injury.
- ▶ Be careful when sorting wash items with sharp, pointed ends. Position them in the machine so that you will not hurt yourself or create a danger for others.
- ▶ Broken glass can result in serious injury during loading or unloading. Broken glass items must not be processed in the machine.
- ▶ When operating the machine, beware of the high temperatures involved. If you bypass the electrical lock to open the door, there is a risk of scalding or chemical burns.
- ▶ Should personnel accidentally come into contact with toxic vapors or process chemicals, follow the emergency instructions given in the manufacturer's safety data sheets.
- ▶ If a program is interrupted or canceled, the inside of the wash cabinet may be contaminated in various ways depending on the application, e.g., with pathogenic bacteria, toxic or carcinogenic substances, etc. Appropriate protective measures must be taken when opening the wash cabinet door, e.g., the use of gloves.
- ▶ Load carriers and wash items must be allowed to cool down before removal. Empty any remaining water into the wash cabinet or an on-site utility sink before removing items.
- ▶ Never clean the machine with a water hose or a pressure washer.
- ▶ The machine must be disconnected from the electrical supply before any maintenance or repair work is carried out.

IMPORTANT SAFETY INSTRUCTIONS

▶ Depending on the properties of the flooring and footwear worn on it, liquids can cause a slipping hazard. Keep the floor dry where possible and take care to clean up any liquid spills straight away. Take the necessary precautions when cleaning up hazardous substances and hot liquids.

Quality assurance

The following points should be observed to assist in maintaining quality standards when processing laboratory glassware and avoid damage to the loads being cleaned.

▶ If it is necessary to interrupt a program, as an exception only, this should only be done by authorized personnel.

▶ It is the responsibility of the operator to demonstrably ensure re-processing standards in routine operation. Process results should be inspected and documented on a regular basis.

▶ For thermal disinfection, use temperatures and temperature holding times to achieve the required infection prophylaxis in accordance with current health and safety regulations.

▶ Make sure items being washed are suitable for machine reprocessing and are in good condition. Plastic items must be thermally stable. Nickel plated items and aluminum items can be machine processed using special procedures only.

Items containing iron, and soiling containing residual rust must not be placed in the cabinet.

▶ Under certain circumstances, process chemicals can result in damage to the machine. The recommendations issued by manufacturers of process chemicals must be followed.

Contact the machine manufacturer in the event of damage and any suspicion of material incompatibility.

▶ Abrasive substances must not be placed in the machine as they could cause damage to the mechanical components of the water supply. Any residues of abrasive substances on items to be washed must be removed without trace before reprocessing in the machine.

▶ Cleaning detergents containing chlorine can damage the elastomers of the machine.

If the use of process chemicals containing chlorine is required, a maximum temperature of 167°F (75°C) in the “Cleaning” program phases is recommended (see program chart).

In machines equipped with special oil-resistant elastomers (from the factory) for oil and grease applications, cleaning detergents containing chlorine may not be used!

▶ Pre-treatments with cleaning agents can create foam, as can certain types of soiling and process chemicals. Foam can have an adverse effect on the cleaning result.

▶ Processes must be set up such that foam cannot escape from the wash cabinet. It would hinder the correct functioning of the machine.

▶ The process used must be monitored on a regular basis by the supervisor to check foaming levels.

▶ To avoid the risk of damage to the machine and its accessories caused by process chemicals, soiling, and any reaction between the two, please read the notes in “Chemical processes and technology”.

IMPORTANT SAFETY INSTRUCTIONS

- ▶ Even when a process chemical, e.g., cleaning agent, is recommended by the manufacturers of the process chemical, the machine manufacturer takes no responsibility for the effect of such process chemicals on the wash items.
Please note that changes in product formulation, storage conditions, etc., which are not announced by manufacturers of process chemicals may impair the quality of cleaning results.
- ▶ When using process chemicals, always consult the instructions issued by individual manufacturers. Process chemicals must only be used for the purpose they are designed for by the manufacturer to avoid any material damage or the occurrence of very strong chemical reactions, such as an oxyhydrogen explosion.
- ▶ Always follow the relevant manufacturer's instructions on storage and disposal of process chemicals and their containers.
- ▶ In critical applications where very stringent requirements have to be met, it is strongly recommended that all the relevant factors for the process, such as cleaning agents, water quality, etc., are discussed with Miele.
- ▶ If the cleaning result is subject to particularly stringent requirements, e.g., in chemical analysis, regular quality control should be carried out by the operator to ensure that required standards of cleanliness are being achieved.
- ▶ Load carriers which hold the wash items must be used only as intended.
The interior of lumened wash items must be thoroughly flushed through with wash water.
- ▶ Secure small and light items with cover nets or place in a mesh tray for small items, so that they do not block the spray arms.
- ▶ Empty any containers or utensils before loading them.
- ▶ The amount of residual solvents and acids on items going into the cabinet should be minimal.
There should be no more than a trace of any solvents with a flash point of below 70°F (21°C).
- ▶ Chloride solutions, in particular hydrochloric acid, must not be placed in the cabinet.
- ▶ Ensure that solutions or steam containing chlorides or hydrochloric acid do not come into contact with the stainless steel outer casing of the machine in order to avoid any damage through corrosion.
- ▶ After any plumbing work, the water pipework to the machine will need to be primed. If this is not done, components can be damaged.
- ▶ The gaps between a built-in machine and adjacent cabinetry must not be filled with silicone sealant as this could compromise the ventilation to the circulation pump.
- ▶ Please follow the advice on installation in these operating instructions and the installation plan.

Children in the vicinity

- ▶ Children must be supervised in the vicinity of the machine. Do not allow children to play with the machine. They could get locked inside it.
- ▶ Children must not use the machine.

IMPORTANT SAFETY INSTRUCTIONS

► Keep children away from process chemicals. These can cause burning in the mouth, nose and throat if swallowed, or inhibit breathing. Keep children away from the machine when the door is open. There could still be residual process chemical in the cabinet. Observe the safety data sheets for the process chemical and seek medical advice immediately if a child has swallowed chemical agent or got it in the eyes.

Using components and accessories

- It is strongly recommended to use only original spare parts and accessories from the manufacturer, which are suitable for the application they are required for. Model designations are available from Miele.
- Only use original load carriers from the machine manufacturer. Using load carriers made by other manufacturers or making modifications to original accessories can result in an unsatisfactory cleaning and disinfection result.

Symbols on the machine

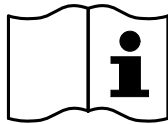

Attention:
Observe the operating instructions!

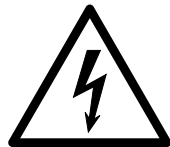

Attention:
Danger of electric shock!



Warning: Hot surfaces:
It can be very hot inside the wash chamber when the door is opened!



Risk of being cut:
Wear cut-resistant protective gloves when transporting and setting up the machine!

Disposal of your old machine

► Please note that the machine may have contamination from blood, bodily fluids, pathogenic germs, facultative pathogenic germs, genetically modified material, toxic or carcinogenic materials, heavy metals etc. in it and must be decontaminated before disposal. For environmental and safety reasons, ensure the machine is completely drained of any residual water, chemical residues and process chemicals. Observe safety regulations and wear safety goggles and gloves. Make the door lock inoperable, so that children cannot accidentally lock themselves in the machine. Then make appropriate arrangements for its safe disposal.

SAVE THESE INSTRUCTIONS

Machine overview

Machine with stainless steel door

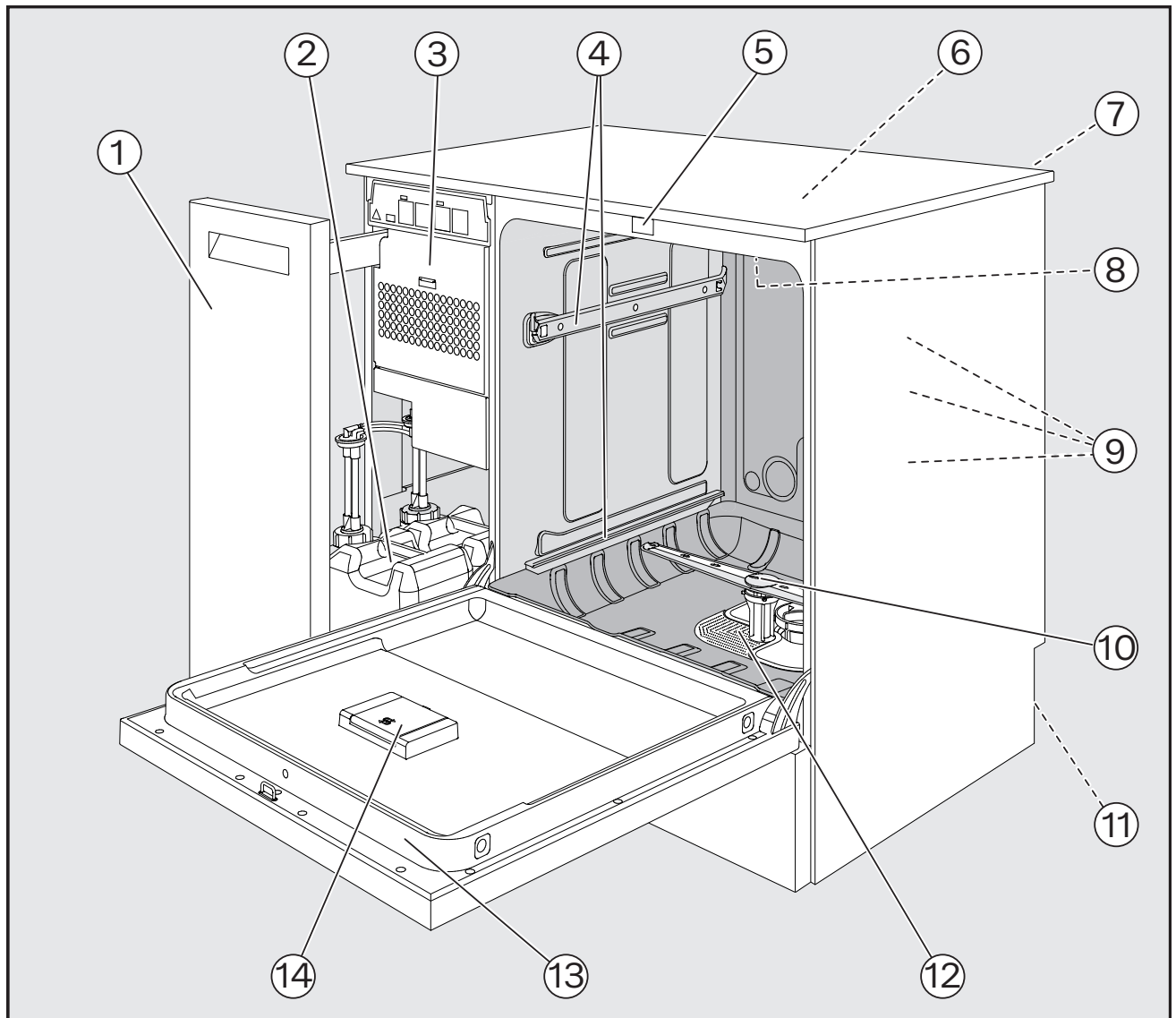

- | | |
|--|--|
| ① Side unit | ⑧ Top machine spray arm |
| ② Canister for process chemicals | ⑨ Water connections for baskets and mobile units |
| ③ Drying unit | ⑩ Lower machine spray arm |
| ④ Rails for baskets and mobile units | ⑪ Rear: |
| ⑤ Door lock | – electrical and water connections |
| ⑥ Test point for performance tests (top, front right; may be visible with lid removed) | – suction lance/s for external containers, canisters |
| ⑦ Module slot for XKM communication module | ⑫ Filter combination |
| | ⑬ Data plate |
| | ⑭ Container for reactivation salt |

Machine description

Machine overview



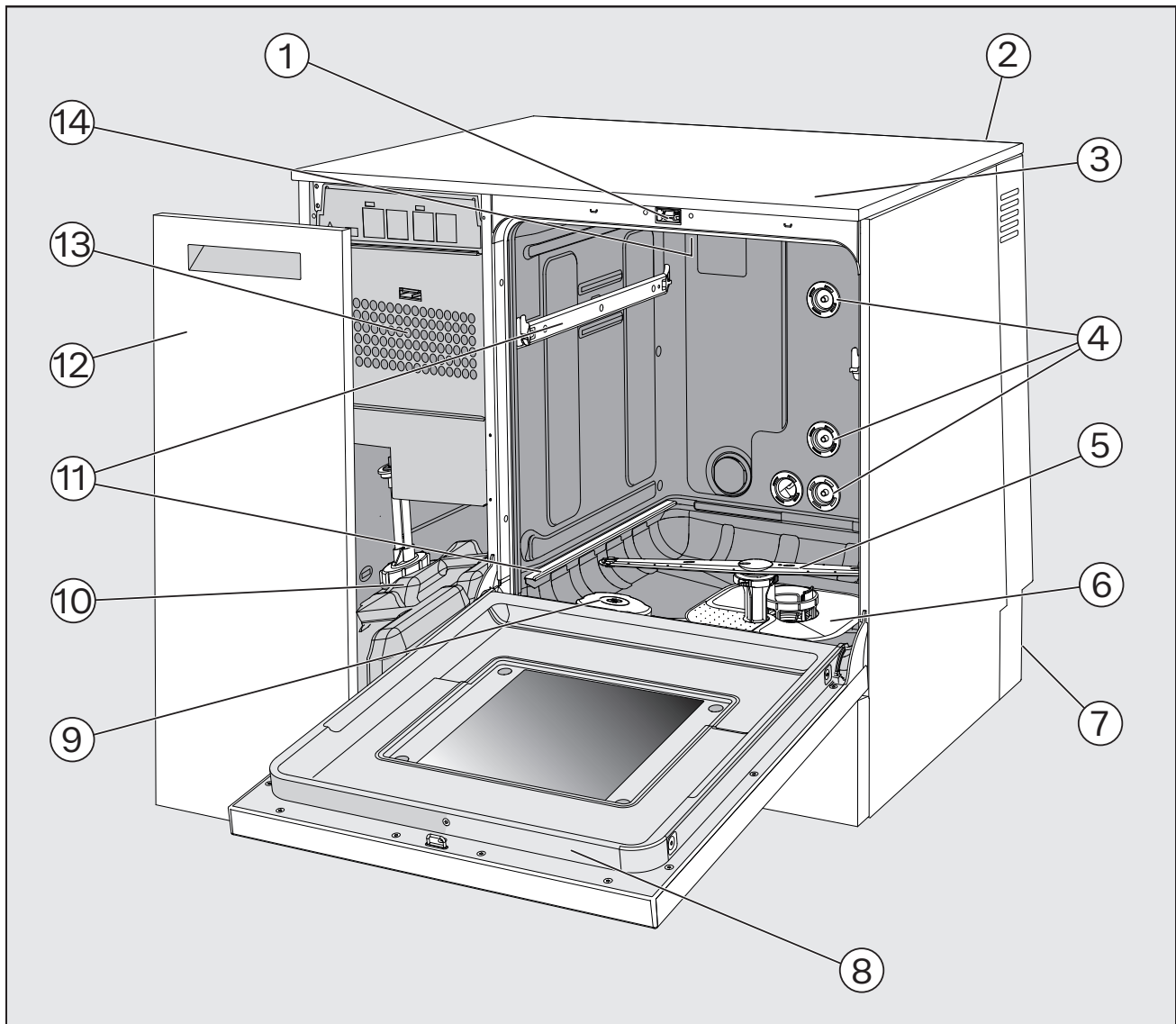

Machine with glass door

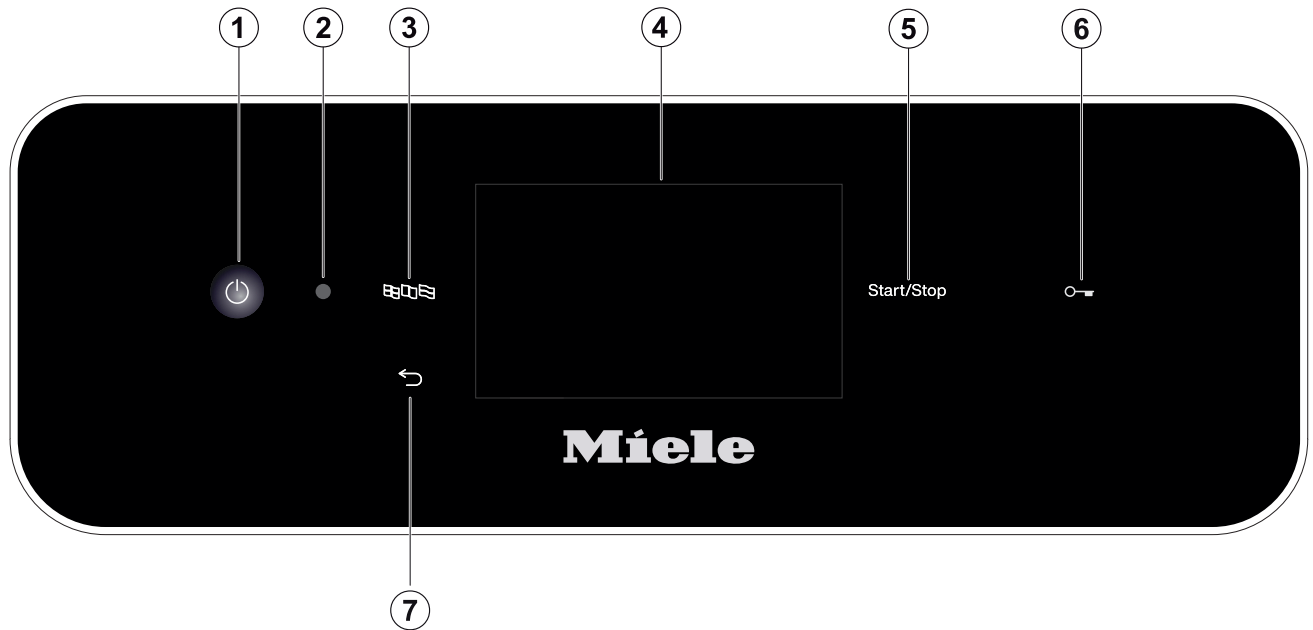

- | | |
|--|--------------------------------------|
| ① Door lock | ⑧ Data plate |
| ② Module slot for XKM communication module | ⑨ Container for reactivation salt |
| ③ Test point for performance tests (top, front right; may be visible with lid removed) | ⑩ Canister for process chemicals |
| ④ Water connections for baskets and mobile units | ⑪ Rails for baskets and mobile units |
| ⑤ Lower machine spray arm | ⑫ Side unit |
| ⑥ Filter combination | ⑬ Drying unit |
| ⑦ Rear: | ⑭ Top machine spray arm |
| – electrical and water connections | |
| – suction lance/s for external containers, canisters | |

Control panel







- ①  On/Off switch
Switching the machine on and off
- ② Service interface
Testing and transmission point for Miele Service
- ③  button (language selection)
For selecting the display language
- ④ Touch display
For displaying and selecting control elements
- ⑤ *Start/Stop* button
For starting or canceling a program
- ⑥  button (door lock)
Opening (unlocking) or closing (locking) the door
- ⑦  button (cancel or back)
For canceling a process in the user interface (not for canceling programs)

Machine description

Buttons on the control panel

Most of the buttons on the control panel are backlit with LED bulbs (light-emitting diodes). These have the following meaning during operation.

Button	LED	Status
	ON	The display language can be changed.
	ON	A process on the display can be canceled.
	OFF	The display shows the top menu level.
		A program is running. One or more system messages must be acknowledged.
<i>Start/Stop</i>	ON	A program is running.
	Pulsing	Display ON: - A program has been selected, but has not yet started. Display OFF: - The machine is in Standby mode.
	FLASHES RED	A fault has occurred (see  "Frequently asked questions").
	OFF	A program has finished.
 button	ON	The door is closed (locked) and a program has been selected but not yet started.
		A program is running.
		A program has finished and the door is closed (locked).

General description

The machine is designed for use in laboratories, e.g., chemical and biological laboratories in universities, research institutes and industry, as well as laboratory-type applications in the industrial sector, for the reprocessing of laboratory glassware, utensils, and similarly categorized components and parts.

How it works

The machine is designed for the machine reprocessing of laboratory glassware and similarly categorized components and parts.

Integrated process monitoring ensures standardization and reproducibility. The machine also helps to increase work efficiency, occupational health, and safety, as well as preserving the value of the wash items.

The use of suitable load carriers (baskets, modules, inserts, etc.) is important to ensure adequate cleaning and protection of the wash items.

Intended use

This machine is specifically designed for use in laboratories, laboratory research labs and other laboratory applications in the industrial sector, and has the necessary cleaning programs.

The machine is used to reprocess reprocessable laboratory glassware, laboratory utensils, and similarly categorized components and parts using water-based media, for example:

- vessels such as beakers, flasks, cylinders, and test tubes
- measuring vessels such as measuring cylinders, volumetric flasks, and pipettes
- dishes such as petri dishes and watch glasses
- plates such as slides and sequencing plates
- small items such as lids, magnetic stirring rods, releasing tools, and stoppers
- other items such as boxes, plastic flasks and containers, metal parts, pipe and hose pieces, and funnels

Reprocessing encompasses the cleaning, rinsing, thermal disinfection (where necessary), and drying of the laboratory glassware, utensils, and components listed above.

Reprocessing is carried out in conjunction with:

- process chemicals which are tailored to the result of the reprocessing
- load carriers which are tailored to the wash items

Direct washing of blood contaminants is not allowed in this machine.

Observe the information issued by the manufacturer of the wash items.

For additional areas of application or additional programs, please contact Miele Service.

Appropriate use

Intended user group

This machine is designed exclusively for industrial purposes.

All persons using the machine must fulfil the following requirements:

- They must have sufficient expertise in how to reprocess the wash items.
- They must be instructed in how to use the machine by Miele Service, by a customer service team specially trained and authorized by the manufacturer, or by a person who has already received instruction.

Installation requirements

Installation site

The machine is intended for installation in laboratories and laboratory-like rooms.

The unit must be installed in rooms that comply with the following environmental conditions:

- Draught-free and dry
- The installation room must be equipped with suitable room ventilation
- Massive (observe floor load-bearing capacity) and level surface
- No direct sunlight

The machine must only be connected in conjunction with a residual current device.

Conditions of use

Operation (according to UL 61010-1, CSA C22.2 No. 61010-1):

- Ambient temperature: 40 °F to 104 °F (5 °C to 40 °C)
- Relative humidity: max. 80 % for temperatures up to 88 °F (31 °C) linear decrease to 50 % for temperatures up to 104 °F (40 °C)
- Relative humidity: min. 10 %

Altitude above sea level (according to UL 61010-1, CSA C22.2 No. 61010-1) Up to 2.000 m

Background noise level N/A

Contraindications

The machine must not be used for reprocessing any products other than those specified. It must not be used for wash items that have not been approved for machine reprocessing by the manufacturer.

Machines must not be used for the reprocessing of any medical instruments. This includes, but is not limited to, instruments designated for final patient use without further processing.

Any deviation from this directive must be reported immediately to Miele's Medical Product Officer.

Furthermore, reprocessing must not be performed on products for which special, deviating cleaning or reprocessing is intended, e.g., medical devices.

The reprocessing of single-use material is not permitted unless the manufacturer of the single-use material prescribes machine reprocessing prior to single use.

Foreseeable misuse

Improper use can be caused by incorrect loading, unsuitable wash items, e.g., medical devices, or unsuitable (process) chemicals.



Failure of the operator to comply with routine checks and regular service intervals.

Failure to observe the specified installation requirements.

Daily operators

For day-to-day use, operators must be instructed on the basic functions and how to load the machine and must also be trained regularly.

They must have a basic knowledge of machine reprocessing of laboratory glassware and utensils.

Day-to-day work is carried out using the user level and in the  Machine functions and  Settings menus. The menus are freely accessible to all users.

Administration

More advanced tasks, e.g., interrupting or canceling a program, require more detailed knowledge about the machine reprocessing of laboratory glassware and utensils.

Alterations to the reprocessing procedure or adaptations to the machine, components, accessories used, or on-site conditions require additional specific knowledge of the machine.

Validation processes assume specialized knowledge of the machine reprocessing of laboratory glassware and utensils, of the processes involved, and of applicable standards and legislation.

The  Extended settings menu incorporates all administrative processes and settings. This is protected by a PIN code.

Operation via control panel



The machine is usually operated via the control panel, which has an integrated touch display and various buttons (sensor controls).

The buttons are backlit with LEDs and are only displayed in context, i.e., if they can be operated in conjunction with the display. Otherwise, they are not visible and cannot be selected.

The touch display and sensor controls react to touch.

The control panel with sensor controls and the touch display can be scratched by pointed or sharp objects, e.g., pens.

Only touch the control panel with your fingers or special pens for touch displays which have rubber tips (touch pens).

Every touch on the sensor controls is confirmed by a keypad tone. You can adjust the volume of the keypad tone or switch it off on the display; see ▶ Settings ▶ Volume.

Display screens

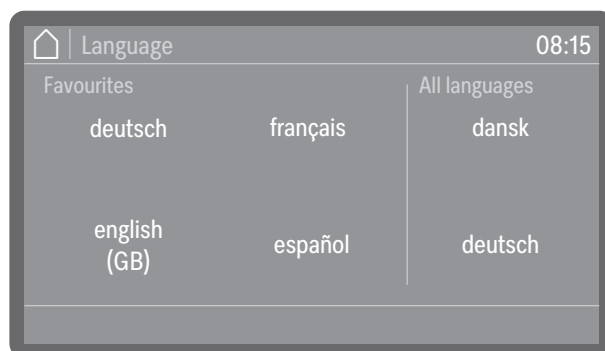

All display screens shown in these instructions are examples and may differ from the actual display screens.

Switching on

The machine must be connected to the electrical supply.



- Press the  On/Off switch until the Miele logo appears on the display.

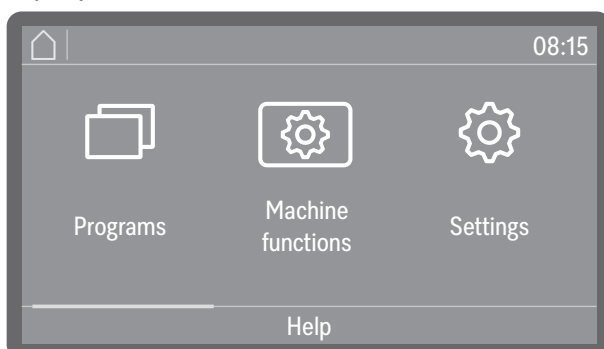

As soon as the machine is ready for operation, the display changes and shows the menu selection.

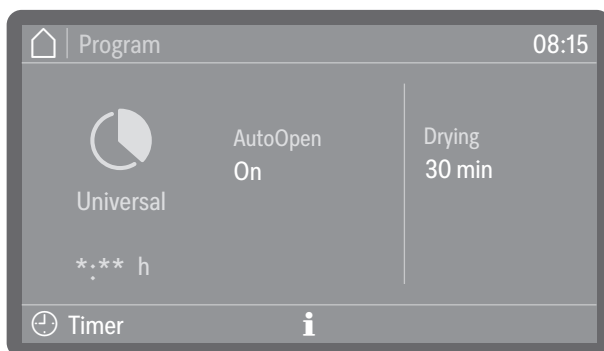

(*:** Program runtime varies depending on configuration)

If the Memory function is activated, the most recently started program is displayed.

Tip: The Memory function can be activated or deactivated at  Extended settings  Program options  Memory.

If the machine is being used for the first time, or if the factory default settings have been reinstated, some basic parameters, e.g., language, date, time, etc., must first be set.

Switching off

- Press the  On/Off switch for a few seconds.

The machine then goes into Standby mode for approx. 1 minute before it switches off completely.

Standby/Off

If the machine has not been used for approx. 10 minutes, it can be set to Standby mode or switched off automatically.

Standby

In Standby mode, the machine remains switched on and the *Start/Stop* button pulses. The machine can be reactivated by pressing the *Start/Stop* button, touching the display, or opening the door.

Off

After automatic switch-off, the machine is switched off and can be switched on again by pressing the  On/Off switch.

Touch display

Home button

As soon as you have opened a menu or the program selection, the home button  is activated in the top left of the display. This will take you back to the menu selection at any time.

Scroll bar

The colored scroll bar appears in the lower part of the display if there are more selection options available than can be displayed.

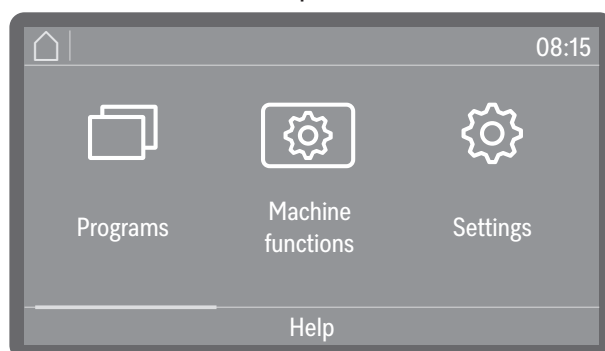

You can scroll to the right or the left by swiping your finger across the screen. To do this, place a finger on the touch display and swipe it in the direction you want.

Operating

Inputs on the display

In these operating instructions, the descriptions for operating the menus are shown as follows:

Input path

The input path describes the sequence to follow to access the menu level in question. The listed menu options have to be selected individually on the touch display.

It is not always necessary to follow the complete path. For example, if you have already opened one of the upper levels of the input path, you can continue to follow the path from this level.

Example:



Example 2:

▶ Machine functions ▶ Filter interval ▶ Filter combination

Display and options

All setting options from the menus are presented as a list with a short explanation. Preselected options are highlighted in color. The further procedure is then described.

Example:

■ Select a filter.

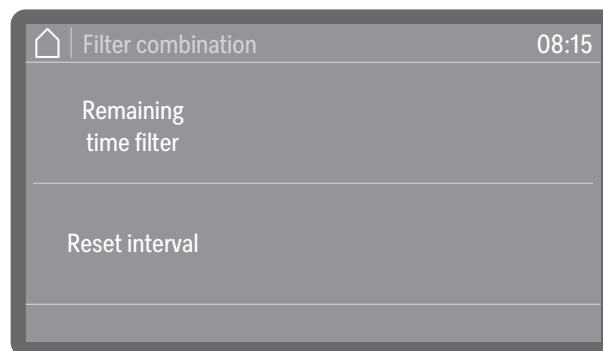

- Remaining filter cycles or Remaining time filter (depending on the type of filter selected)

Displays the remaining program sequences (cycles) or operating hours until the next maintenance (cleaning or replacement)

- Reset interval

Resets the counters for the filter cycles

The intervals must only be reset once the filters have been cleaned or replaced.

■ Select an option.

Setting numerical values

Numerical values can be entered in 2 different ways.

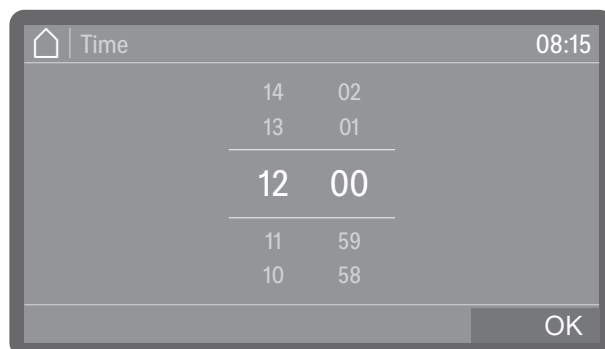

Firstly, you can place a finger on the numbers highlighted in color and change them by swiping up or down.

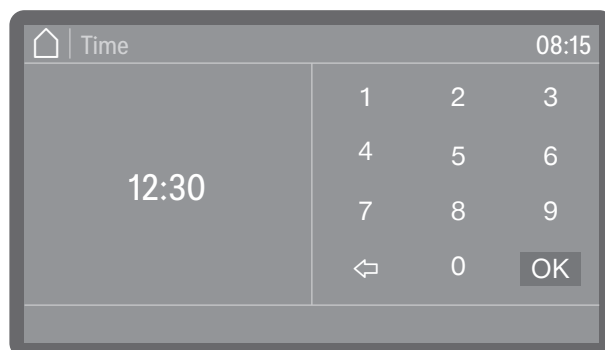

Secondly, you can call up a numerical keypad by briefly tapping the numbers highlighted in color and then entering the numbers directly.

Depending on the context, numbers entered directly may be rounded up or down. If, for example, it is only possible to enter values in increments of 10 (10, 20, 30, etc.), the value is rounded down to 10 when you enter 12, and rounded up to 20 when you enter 15.

Selecting the language

You can change the display language at any time.

- Press the language selection button  next to the display.

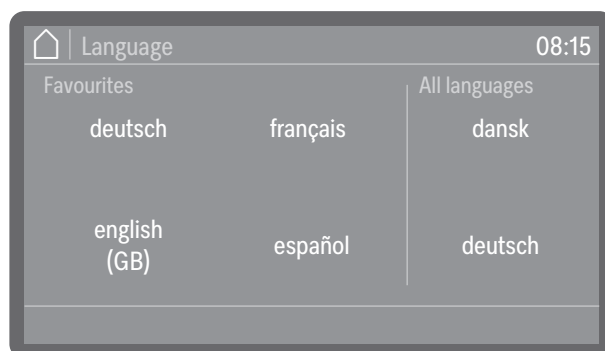

- Scroll to the language you want and select it by tapping on it.

The order of the languages in the display is variable. The more often a program is started in the selected language, the further forward the language moves in the sequence. The 4 most frequently selected languages are shown on the display as Favourites.

System messages **i**

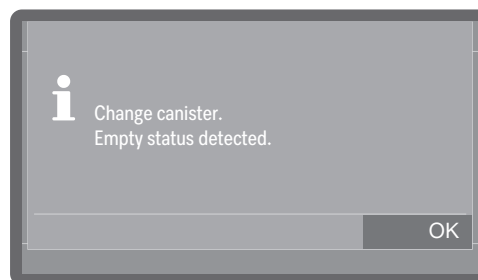
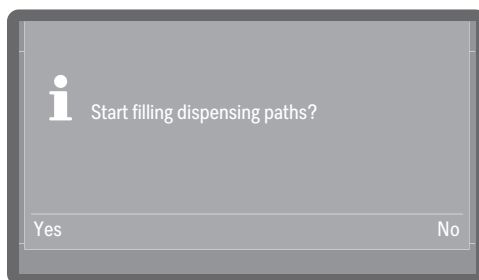

System messages are indicated by the information symbol **i**. These give information about current processes and the status of the machine. If there is more than one system message, they are shown one after the other and – depending on the message – must be processed or acknowledged individually.

Fault messages **!**



In the event of a fault, a warning symbol **!** appears on the display and the *Start/Stop* button flashes red in rapid succession. If audible signals are activated, a warning tone will also sound. Warning messages must be acknowledged by tapping the warning symbol. Troubleshooting assistance can be found in  "Frequently asked questions".

Help button

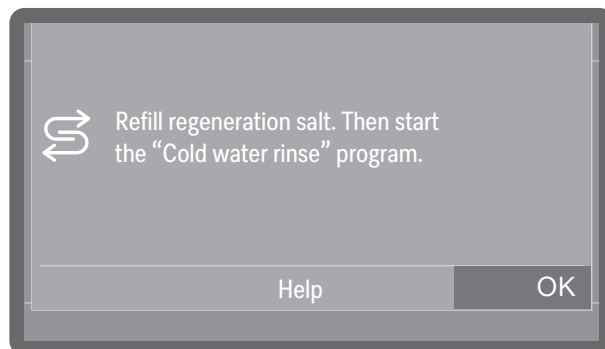

If the Help button appears at the bottom of the display, you can display assistance for operation or troubleshooting. If required, tap the Help button and allow the machine to guide you through the process step by step.

Networking (📶 or L)

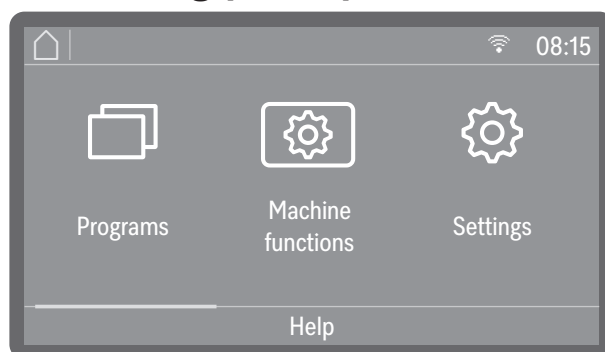



If the machine has been networked, a symbol for the available interface is shown at the top of the display. 📶 stands for a Wi-Fi connection, L for a wired LAN connection. If the machine cannot establish a Wi-Fi connection with the router, the symbol will be shown with a cross through it ✖.

Tip: The interface is set up at ▶ ⚙️ Extended settings ▶ Network.



Commissioning

Installation and connection

Before commissioning, the machine must be securely installed, and the water inlet, drain hoses, and the power cord correctly connected. Follow the instructions in  “Installation”,  “Water connection”, and  “Electrical connection” as well as the instructions in the installation plan for the laboratory glasswasher.

Process

The commissioning process requires a set period of time which cannot be interrupted.

Once commissioning is complete, you can change all settings made during commissioning via the menu ▶  Extended settings. The only exceptions are the language selection, which is made using the language selection button  on the control panel, and the selection of the water connections, which can only be reset by Miele Service.

Switching on

- Press the  button.

Selecting the language

Commissioning starts with the selection of the display language.

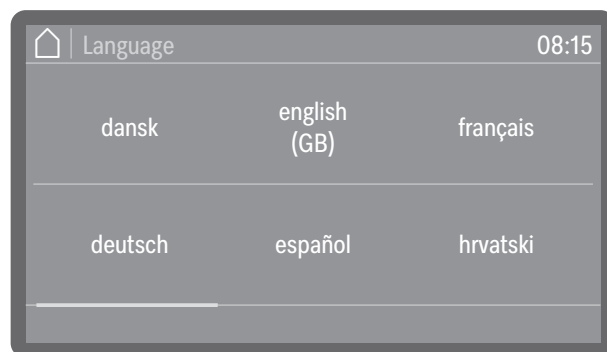

- Scroll to the language you want and select it by tapping on it.

Wi-Fi setup

You have to select whether you want to integrate the machine into a Wi-Fi network during commissioning or whether you want to integrate it at a later time or not at all.

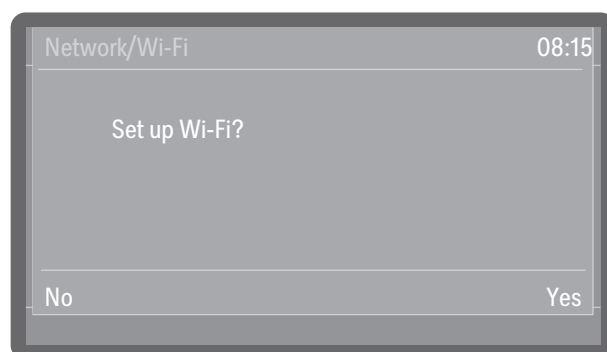

- Select Yes to integrate the machine into an existing Wi-Fi network on site.
To do this, follow the instructions in ▶  Extended settings ▶ Wi-Fi / LAN ▶ Set up Wi-Fi.
- Select No if you want to integrate the machine into a Wi-Fi network at a later time or not at all.

Setting the date

Set today's date.

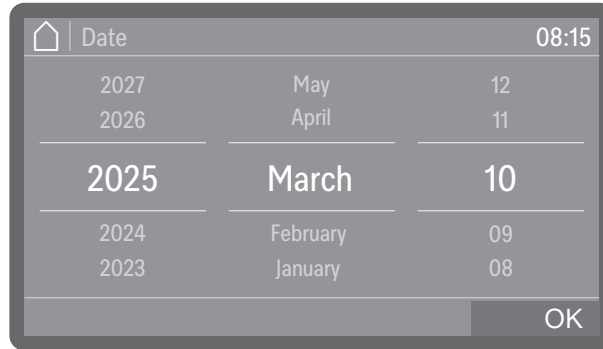

- Set the date in the order of year, month, and day. The order is predefined.
- Press OK to save the setting.

Tip: You can customize the display format after commissioning at
 ▶ Extended settings ▶ Date/Time ▶ Date ▶ Date format.

Setting the time of day

Set the current time of day. The input format is predefined.

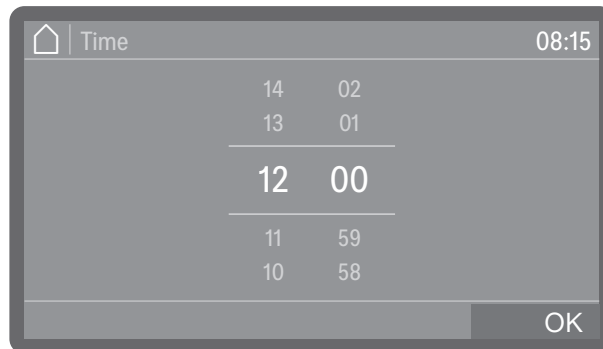

- Set the time of day and confirm your selection with the OK button.

Tip: You can customize the display format after commissioning at
 ▶ Extended settings ▶ Date/Time ▶ Time ▶ Clock format.

Setting the temperature unit

The temperature can be shown on the display in °C (degrees Celsius) or °F (degrees Fahrenheit).

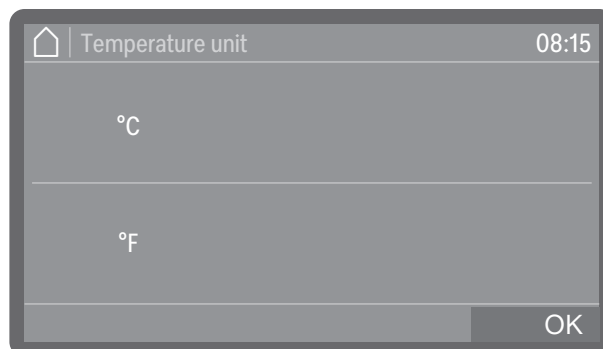

- °C

Temperature display in Celsius.

- °F

Temperature display in Fahrenheit.

- Select the desired temperature unit.
- Press OK to save the setting.

Commissioning

Setting the water hardness

You can find out the degree of hardness of the tap water from your local water supplier.

As an alternative, you may also determine the approximate water hardness by using the test strip included with the machine. To do this, follow the instructions in  “Determining the degree of hardness”.

With varying water hardness, always set the highest level. If the water hardness fluctuates between, for instance, 8.3 and 17.7 gpg (8 and 17°dH), the water hardness must be set to 17.7 gpg (17°dH).

Water hardness setting values can be found in the table in  “Settings table”.

- Select the Water hardness menu option.

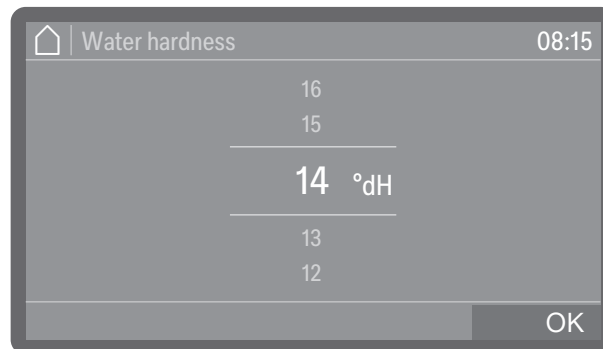

- Set the water hardness.
- Press OK to save the setting.

It is useful to know your water hardness so that you can provide the service technician with this information in the event of any subsequent service calls. Therefore, document the water hardness.

Selecting water connections

All available water connections are activated in the control system at the factory. Individual water connections can be subsequently deactivated, e.g., if no connection options are available for them.

Following commissioning, the water connections can be reinstated by Miele Service.

- Select one of the available water connections, for example:

- Hot water

hot water connection

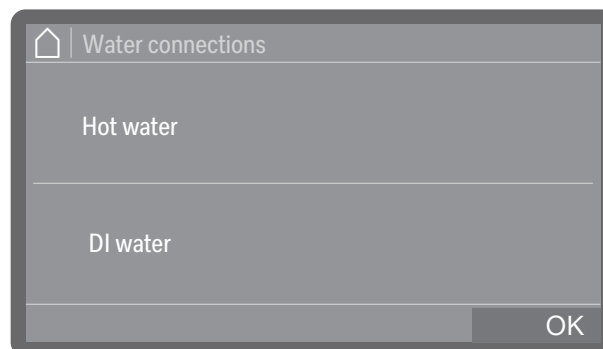

You can select and deselect the water connections by tapping them. Activated water connections are highlighted in color.

- Select OK to confirm your choice.

Checking water connections

Next, you can select whether you want to check the previously activated water connections. A check is carried out as to whether sufficient water can flow in.

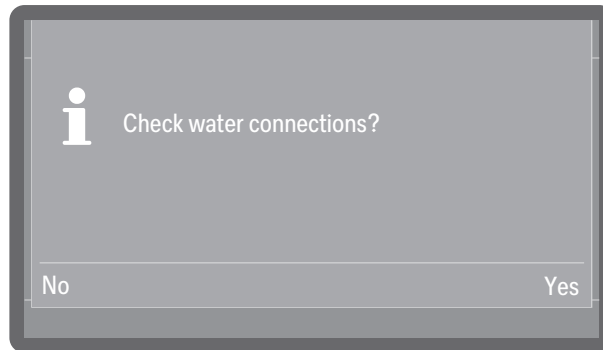

- Yes

Starts the check. Before starting, make sure that the water connections are open.

- No

Skips the check of the water connection.

■ Select an option.

Configuring dispensing hoses

In the next step, you have to select whether you want to configure the dispensing hoses present during commissioning or at a later time. The configuration includes activating or deactivating individual dispensing hoses and setting the dispensing concentration.

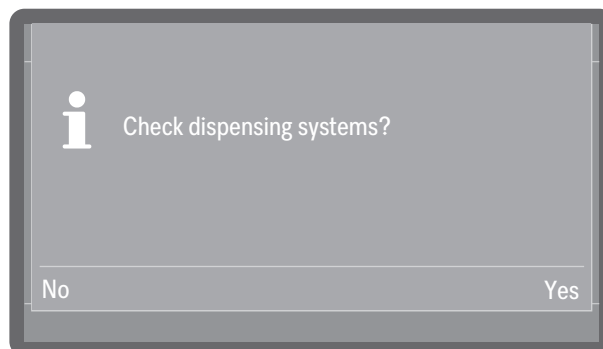

- Yes

Starts the configuration of the dispensing hoses. Follow the instructions in the display.

- No

Skips the configuration of the dispensing hoses. The settings then correspond to the factory default settings.

■ Select an option.

Tip: Additional information and setting options can be found at

►  Extended settings ► Maintenance/Service ► Dispensing system.

Filling and checking dispensing hoses

Before filling the dispensing paths, make sure that the canisters are full and that the suction lances are screwed securely to the canisters and that they cannot suck in air.

Commissioning

When a dispensing hose is used for the first time, it must first be filled with the dispensing medium so that no air is dispensed. You have to select whether you want to fill the dispensing hoses during commissioning or at a later time.

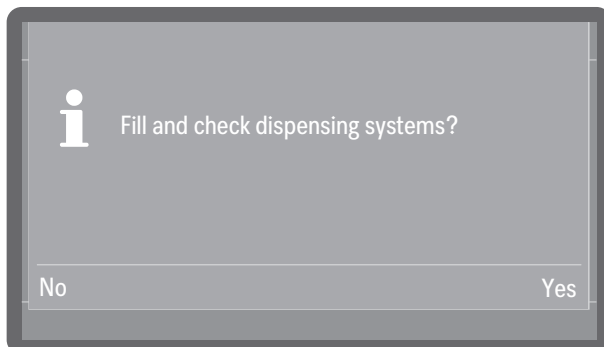

- Yes

Select the dispensing hoses one after the other and start the filling process.

- No

Skips the filling of the dispensing hoses, but this must then be carried out at a later time.

■ Select an option.

Tip: Additional information and setting options can be found at
▶  Extended settings ▶ Maintenance/Service ▶ Dispensing system.

Commissioning completed

Your machine has been successfully commissioned once you see the following message:

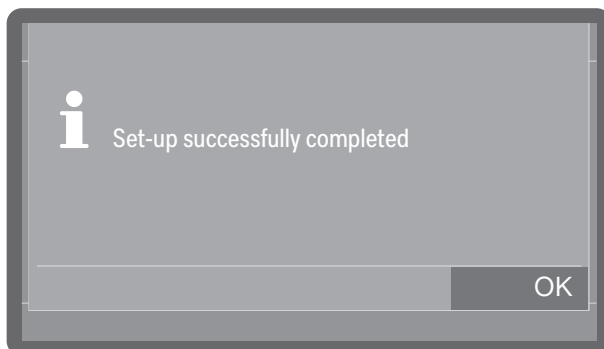

■ Confirm the message with OK.

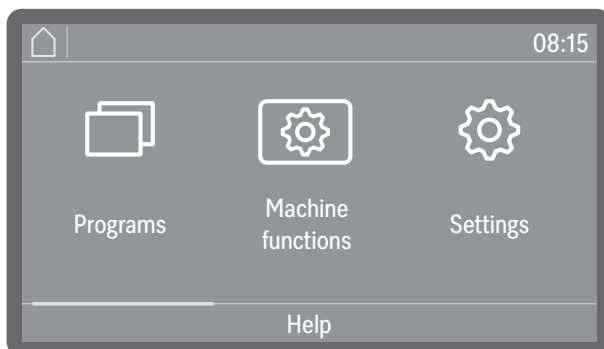

The machine is now ready for use.

Comfort Door Lock

The door of the wash cabinet is equipped with a Comfort Door Locking Mechanism. When the door is closed, the Comfort Door Locking Mechanism automatically pulls the door into the closed position and thus ensures it is sealed. The door is locked electronically.

Opening the door

A door that has been locked electronically can be opened under the following circumstances:

- The machine is connected to the power supply and the ⏻ On/Off switch is lit up.
- The symbol for the ➡ door button is lit up.
- To open the door, press the ➡ door button.

The comfort door lock opens the door slightly.



- Open the door. The control panel serves as a door handle. Grasp the handle underneath the control panel and lower the door to open it.

The temperature in the wash cabinet may be higher after a program cycle. If the temperature exceeds 140 °F (60 °C), a message is shown on the display when you press the ➡ door button: Hot wash cabinet: Risk of injury, take care when opening the door..

- Confirm the message by pressing OK.

Close the door.

- Make sure that no objects or wash items protrude into the closing area of the door.

⚠ Risk of injury caused by crushing.
Do not put your hand inside the door as it is closing. Risk of crushing.

- Raise the door upward until the catch engages.

If the AutoClose function is activated, the door is then pulled into the end position.

Tip: For more information on the AutoClose function; see ▶  Machine functions ▶ AutoClose.

Opening and closing the door

Opening the door using the emergency release

⚠ Danger of scalding, burning, and chemical burns!
If the emergency release is operated during a program sequence, hot water and process chemicals can escape.
Only open the door using the emergency release when strictly necessary.

The emergency release mechanism is located on the right beside the door lock in the gap between the door and the lid of the machine or the countertop.

There should be 3/8" (1 cm) between the right edge of the tool and the right edge of the display.

- Press against the door to release the emergency release mechanism.

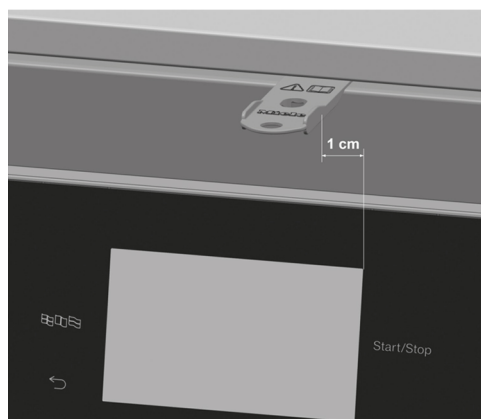

- Insert the tool from the accessory pack horizontally into the gap between the door and the lid or countertop.
- Press the tool against the release mechanism until you hear the door open. Continue to press the tool against the release mechanism and fully open the door.

If the machine is switched on, the following message is shown on the display when the emergency release is triggered:

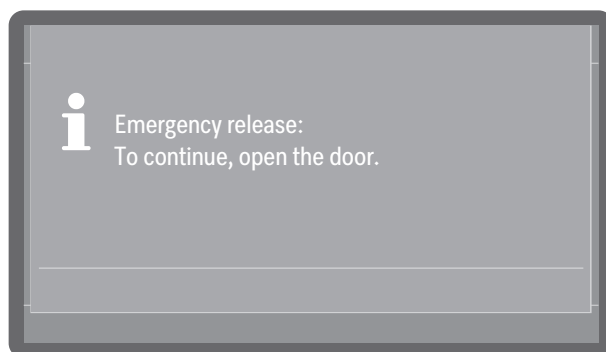

The message is acknowledged when the door is closed.

Water softening

In order to achieve excellent cleaning results, the machine requires a supply of soft water with a low calcium content. Hard tap water results in the build-up of calcium deposits on the wash items and on the wash cabinet walls.

Tap water with a water hardness of 4.2 gpg (0.7 mmol/L (4°dH)) or more must be softened. This occurs automatically while a program is running in the built-in water softener.

The water softener must be set to the exact hardness of the tap water.

If the water hardness is greater than 50 gpg (9.0 mmol/L (50°dH)), the water must be softened before water intake.

For this purpose, the water connections on site must be equipped with appropriate water softening systems that provide the required minimum flow pressures for the water connections; see  "Technical data".

Determine the water hardness of the pre-softened water and set the value on the display.

Determining the degree of hardness

Setting the water hardness

You can find out the degree of hardness of the tap water from your local water supplier.

As an alternative, you may also determine the approximate water hardness by using the test strip included with the machine.

- Take a water sample at the nearest water connection.

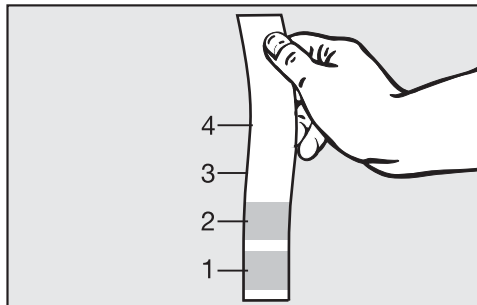

- Dip the test strip into the water for approx. 1 second. The zones of the test strip must be fully immersed.
- Remove the test strip from the water and shake the excess water off the test strip.

After approx. 1 minute, and based on the coloration, you will be able to read the water hardness.

Water hardness

Test strip	Water hardness	Settings on the display
4 green zones	< 3.1 gpg (0.5 mmol/l (3°dH))	3°dH or lower
1 red zone	> 4.273 gpg (0.7-1.2 mmol/l (4–7°dH))	7°dH
2 red zones	> 7.3–14.6 gpg (1.2-2.5 mmol/l (7–14°dH))	14°dH
3 red zones	> 14.6-21.9 gpg (2.5-3.7 mmol/l (14–21°dH))	21°dH
4 red zones	> 21.9 gpg (3.7 mmol/l (21°dH))	*)

*) Contact your local water supplier, inquire about the degree of hardness, and set this on the display.

Setting the degree of hardness

With varying water hardness, always set the highest level. If the water hardness fluctuates between, for instance, 8.3 and 17.7 gpg (8 and 17°dH), the water hardness must be set to 17.7 gpg (17°dH).

Water hardness setting values can be found in  “Settings table”.

The menu is saved under the following input path.

 Extended settings

Water hardness

- Select the Water hardness menu option.

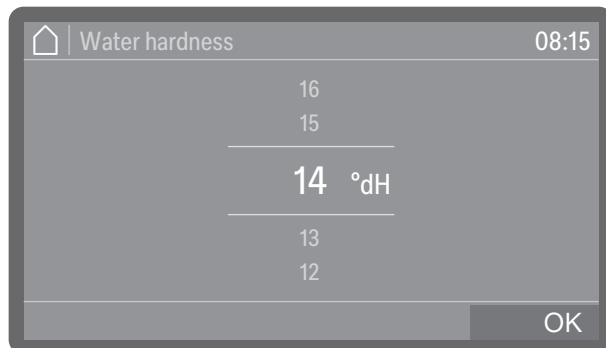

- Set the water hardness.
- Press OK to save the setting.

Settings table

Water hardness can be set between 0 and 50 gpg (0–50°dH).
The water hardness is preset to 14 gpg (14°dH) at the factory.

gr/gal	ppm CaCO ₃	mmol/l	Display	gr/gal	ppm CaCO ₃	mmol/l	Display
0	0	0	0	26	470	4.7	26
1	20	0.2	1	27	490	4.9	27
2	40	0.4	2	28	500	5.0	28
3	50	0.5	3	29	520	5.2	29
4	70	0.7	4	30	540	5.4	30
5	90	0.9	5	31	560	5.6	31
6	110	1.1	6	32	580	5.8	32
7	130	1.3	7	33	590	5.9	33
8	140	1.4	8	34	610	6.1	34
9	160	1.6	9	35	630	6.3	35
10	180	1.8	10	36	650	6.5	36
11	200	2.0	11	37	670	6.7	37
12	220	2.2	12	38	680	6.8	38
13	230	2.3	13	39	700	7.0	39
14	250	2.5	14*)	40	720	7.2	40
15	270	2.7	15	41	740	7.4	41
16	290	2.9	16	42	760	7.6	42
17	310	3.1	17	43	770	7.7	43
18	320	3.2	18	44	790	7.9	44
19	340	3.4	19	45	810	8.1	45
20	360	3.6	20	46	830	8.3	46
21	380	3.8	21	47	850	8.5	47
22	400	4.0	22	48	860	8.6	48
23	410	4.1	23	49	880	8.8	49
24	430	4.3	24	50	900	9.0	50
25	450	4.5	25				

*) Factory default setting

Water hardness

Reactivation salt

The water softener must be reactivated at regular intervals. Special reactivation salt is required for this. Reactivation is carried out automatically during a program sequence.

If the water hardness is consistently less than 4.2 gpg (0.7 mmol/l (4°dH)), salt is not required for the water softener. However, the water hardness level must still be set; see  "Setting the water hardness".

Filling the container for reactivation salt

Only use special, coarse-grained reactivation salt or pure evaporated salt with a grain size of approx. 1/16"-3/16" (1–4 mm). Never use other salts, e.g., table salt, cattle salt, or de-icing salt. Other salts may contain insoluble additives which can impair the functioning of the water softener.

 Inadvertently filling the salt container with cleaning agent will always cause serious damage to the water softener.

Before filling the salt container, make sure that you have picked up the right packet of reactivation salt.

Machine with steel door

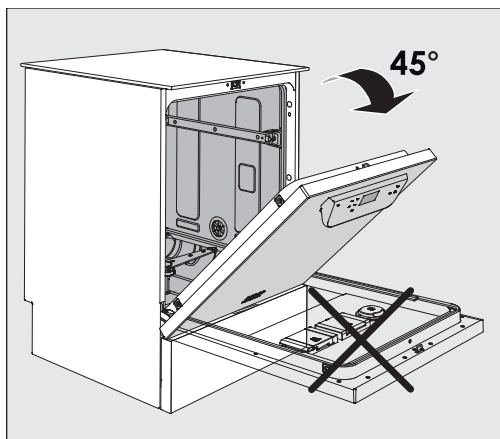

- Open the door to an angle of around 45°. This ensures that the salt flows into the container more easily.

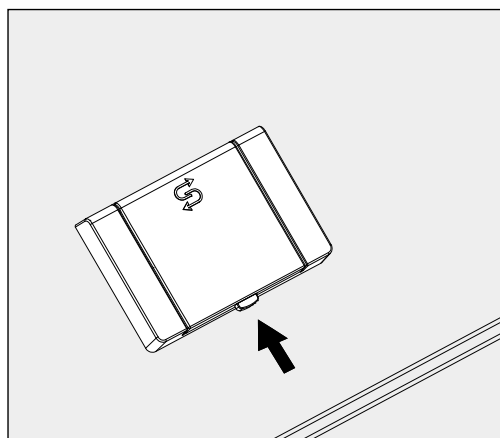

- Press the yellow locking button on the salt container . The flap will spring open.
- Open the funnel.

The container takes approx. 3-4.4 lb (1.4–2 kg) of salt, depending on the type of salt and the remaining fill level.

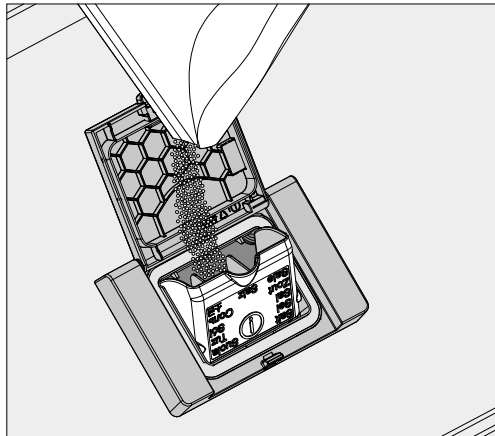

⚠ Never fill the container with water.
The container could overflow when filled with salt.

- Add salt into the container until the funnel is full but still closes easily. Do not add any more than 4.4 lb (2 kg) of salt.

As the salt container is being filled, displaced water (brine) may run out.

- Clean any excess salt from around the opening of the container, focusing especially on the container's seal. Do not use running water to rinse away salt residues as this can cause the container to overflow.
- Close the container. Make sure that the container is closed tightly so that no wash water can enter the container.

⚠ Do not force the container shut if it has been overfilled.
If an overfilled salt container is forced shut, this may damage the container.
Remove excess salt before closing the container.

- Run the Cold water rinse program after refilling salt.

This will ensure that any traces of salt and brine are dissolved, diluted, and rinsed away.

Excess salt and brine which has overflowed cause corrosion damage if they are not rinsed away.

Water hardness

Machine with glass door The salt container cap is located at the bottom of the wash cabinet next to the spray arm.

- Open the door.
- Remove the load carrier.

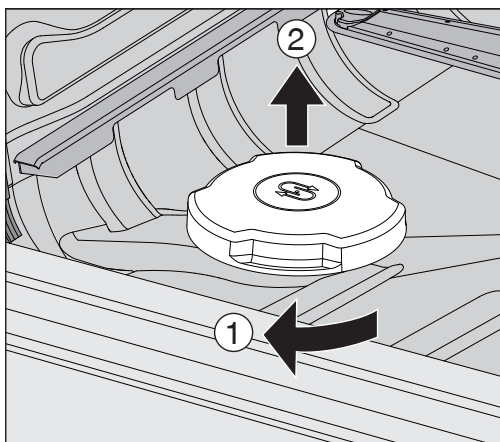

- Turn the salt container cap in the direction of the arrow ① as far as it will go and pull the cap upward ②.

Before filling the salt container for the first time, you must fill it with approx. 2.0 L of water to enable the salt to dissolve. Once the machine has been commissioned, there is always sufficient water in the container.

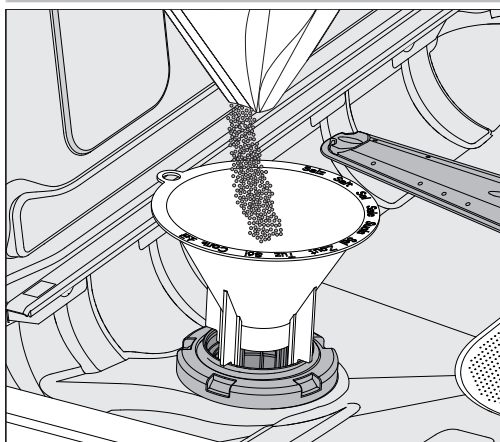

- Place the salt funnel on the refilling opening.

The container takes approx. 3-4.4 lb (1.4–2 kg) of salt, depending on the type of salt and the remaining fill level.

- Add the salt. Do not add any more than 4.4 lb (2 kg) of salt.

As the salt container is being filled, displaced water (brine) may run out.

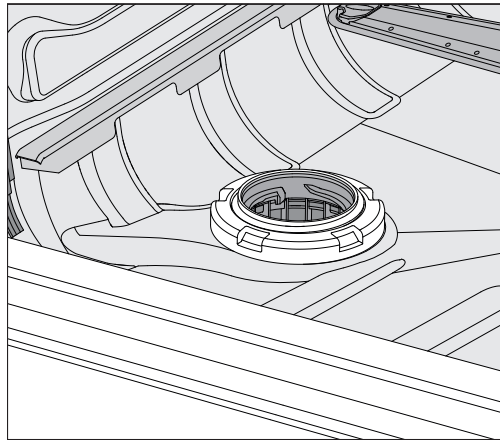

- Clean any excess salt from around the opening of the container, focusing especially on the container's seal. Do not use running water to rinse away salt residues as this can cause the container to overflow.
- Close the container. Make sure that the container is closed tightly so that no wash water can enter the container.

⚠ Do not force the container shut if it has been overfilled. If an overfilled salt container is forced shut, this may damage the container.
Remove excess salt before closing the container.

- Run the Cold water rinse program after refilling salt.

This will ensure that any traces of salt and brine are dissolved, diluted, and rinsed away.

Excess salt and brine which has overflowed cause corrosion damage if they are not rinsed away.

Salt refill indicator

If the fill level in the salt container is low and reactivation is carried out, the following message appears on the display:

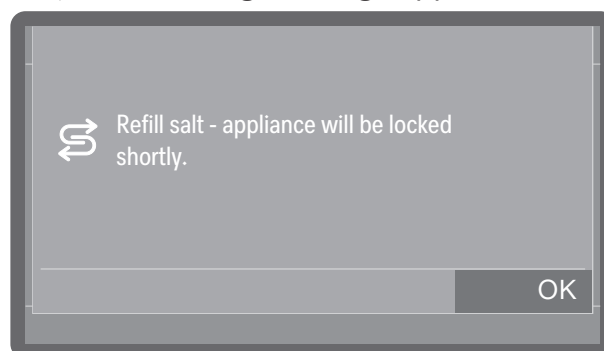



- Confirm the message with OK.
- Top up the reactivation salt; see  "Filling the container for reactivation salt".

If the message is being displayed for the first time, additional program cycles may be possible depending on the set water hardness. If no salt is added, the message is displayed again at the end of every program.

Water hardness

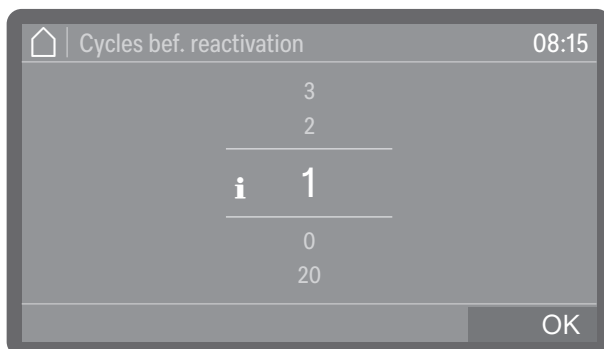
Reactivation notification



You can set how many program cycles in advance you want to be notified of the upcoming reactivation; see ▶  Extended settings ▶ Maintenance/Service ▶ Note reactivation.

Canceling machine lock due to lack of salt

If the salt in the water softener has been used up, a fault appears on the display and the machine is locked to prevent further use.



- Acknowledge the fault by tapping the warning symbol.

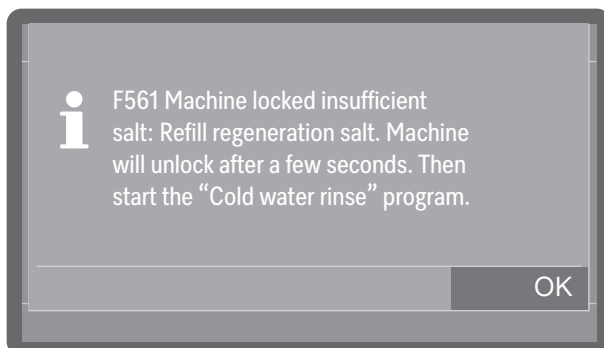

- Follow the instructions on the display and top up the reactivation salt; see  “Filling the container for reactivation salt”.

The machine lock is lifted automatically with a certain delay once salt has been added.

Mobile units, baskets, modules and inserts

This machine can be equipped with an upper basket and lower basket or a mobile unit which can be equipped with different inserts and modules or exchanged for special accessories depending on the wash items to be washed.

Select load carriers and other accessories which are appropriate for the application.

Information on the individual areas of application can be found on the following pages, as well as in the operating instructions for the load carriers (if available).

Miele offers suitable load carriers for all areas of application defined in  "Appropriate use", such as mobile units, baskets, modules, inserts, and special rinse fittings. Contact Miele for more information.

Water supply

Load carriers with spray arms or other irrigation connectors are equipped with one or several connectors for the water supply at the rear. When these are slid into the machine, the connections couple automatically with the water supply docking points in the rear panel of the cabinet. The load carriers are held in position by the wash cabinet door when it is closed.

Unused docking points in the rear panel of the wash cabinet are closed mechanically.

Mobile units and baskets from older series

The use of mobile units and baskets from older series is only possible in this machine following consultation with Miele. In particular, mobile units and baskets with water supply pipes for spray arms and injector manifolds must be converted to the modified water connections. The conversion is carried out by Miele Service and is only possible on selected models.

 The connectors for the water supply to the mobile units and baskets must be installed by Miele Service. Assembly errors can cause damage to the machine when using the mobile units and baskets.

Following conversion, the mobile units and baskets can no longer be used in machines from older series.

Height-adjustable upper baskets

Height-adjustable upper baskets can be adjusted between 3 positions with 1" (3 cm) between each position to accommodate wash items of different heights.

To adjust the height, the brackets with rollers on the side of the upper basket and the water connector at the back of the basket have to be moved. The roller brackets are each secured to the upper basket by 2 screws. The water connector consists of the following components:

- a stainless steel plate with 2 openings
- a plastic connector
- 6 screws

Only adjust upper baskets horizontally. The baskets are not designed for tilting (one side up, one side down). Adjusting the height alters the vertical clearance of the upper and lower baskets.

Setting the upper position

- Remove the upper basket by pulling it out until a resistance is felt and lifting it off the runners.
- Unscrew the roller brackets and the water connector.

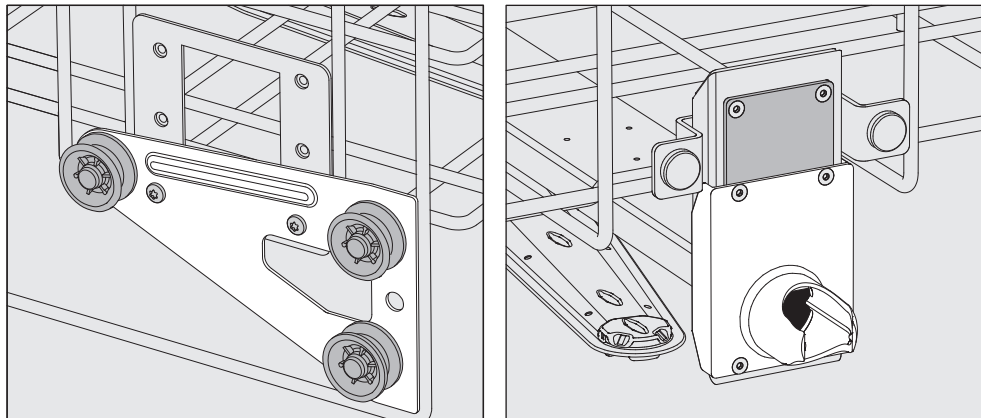

- Move the roller brackets on both sides to the lower position and secure them firmly.
- Place the stainless steel plate over the openings in the water inlet pipe so that the top opening is covered. Screw the stainless steel plate to the top with 2 screws. Insert the connector into the lower opening of the stainless steel plate so that the middle opening is covered. Screw the connector on with 4 screws.

Setting the middle position

- Remove the upper basket by pulling it out until a resistance is felt and lifting it off the runners.
- Unscrew the roller brackets and the water connector.

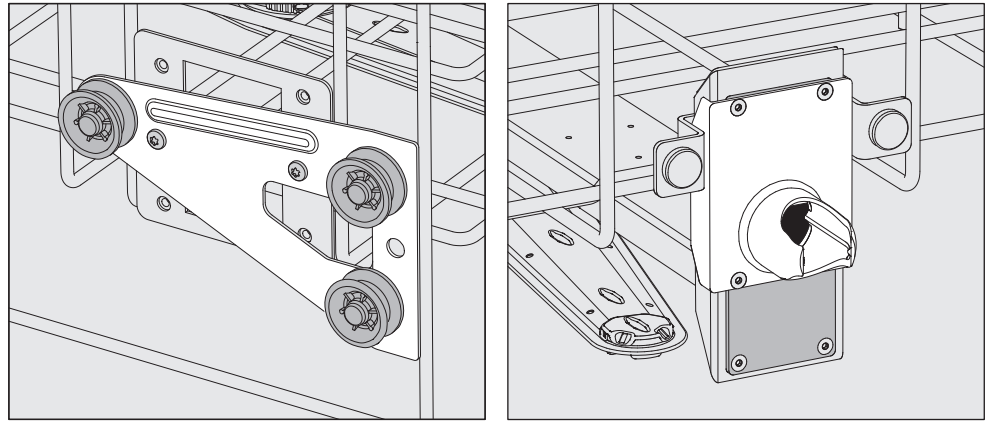

- Move the roller brackets on both sides to the middle position and secure them firmly.
- Place the stainless steel plate over the openings in the water inlet pipe so that one of the outer openings is covered. Screw the stainless steel plate to the top or bottom with 2 screws. Insert the connector into the middle opening of the stainless steel plate so that the outer opening is covered. Screw the connector on with 4 screws.

Setting the lower position

- Remove the upper basket by pulling it out until a resistance is felt and lifting it off the runners.
- Unscrew the roller brackets and the water connector.

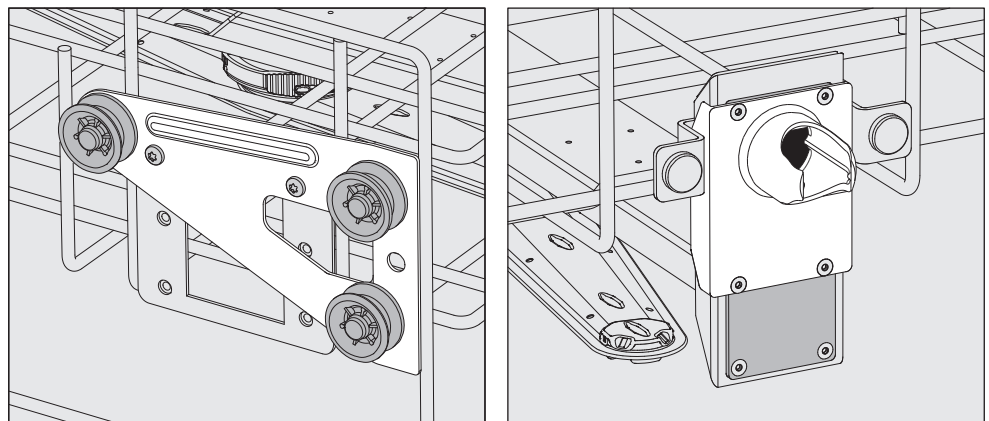

- Move the roller brackets on both sides to the top position and secure them firmly.
- Place the stainless steel plate over the openings in the water inlet pipe so that the lower opening is covered. Screw the stainless steel plate to the bottom with 2 screws. Insert the connector into the upper opening of the stainless steel plate so that the middle opening is covered. Screw the connector on with 4 screws.

Then check:

- Put the upper basket back on the rails and push it in carefully to check that the water connector is positioned correctly.

Load carriers

Wash pressure measurement

The wash pressure can be measured if required on all load carriers with spray arms, injector manifolds, or other wash connections, e.g., during performance tests.

Test point for measuring wash pressure

On load carriers with spray arms and additional injector manifolds or other wash connections, there is a connection on the injector manifold or a wash connection for wash pressure measurement. The exact location is described in the respective operating instructions for the load carriers.

On load carriers with spray arms but without other wash connections, the test point for measuring the wash pressure can be found in the water inlet pipe for the spray arms. The test point is labeled with a ⚠ warning symbol and closed with a blanking plug.

⚠ All test points labeled with a warning symbol ⚠ are intended exclusively for wash pressure measurement.
Do not connect any wash items or irrigation connectors to the test points.

Perform measurement

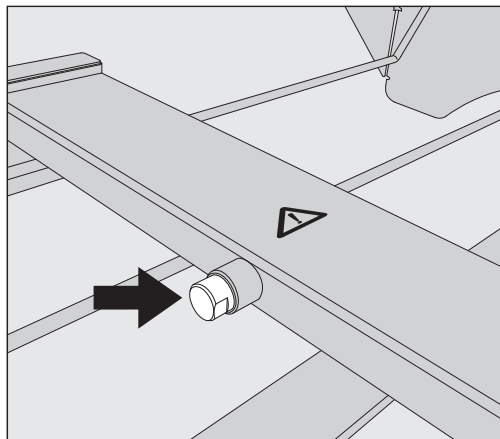

- To measure the wash pressure, replace the blanking plug with a Luer Lock adapter.

Suitable Luer Lock adapters, such as the E 447, are available from Miele.

- Carry out the measurement.
- Close the test point again with the blanking plug after the measurement.

Arranging the wash items

⚠ Contaminated wash items pose a health risk.

Contaminated wash items can result in various hazards to health, which can lead to infections, poisoning, injuries, and more depending on the type of contamination.

When working with contaminated wash items, ensure that all necessary measures are taken to protect personnel.

Wear protective gloves and use suitable aids.

⚠ Only wash items which have been designated by their manufacturer as suitable for machine reprocessing may be processed. The manufacturer's specific reprocessing instructions must be observed.

Used disposable items must not be reprocessed.

- Special load carriers or irrigation connectors such as nozzles, irrigation sleeves, or adapters may be required for appropriate internal cleaning, depending on the wash items.
- Arrange the wash items so that wash water can access all surfaces. This ensures that they get properly cleaned.
- Do not place wash items inside other items where they may be concealed, as this will hamper cleaning.
- Do not place wash items so close together that cleaning is hampered.
- The interior of lumened wash items must be thoroughly flushed through with wash water. Special load carriers or rinse fittings are required for this, depending on the wash items.
- Ensure that wash items with long, narrow, hollow sections can be flushed through properly before placing them in or connecting them to a rinse fitting.
- Lumened instruments should be inverted and placed in the correct load carriers to ensure that wash water can flow in and out of them unrestricted.
- Deep-sided wash items should be placed at an angle to make sure the wash water runs off them freely.
- Tall, narrow, hollow items should be placed in the center of the baskets or mobile units. This ensures better water coverage.
- Take apart any wash items which can be dismantled according to the manufacturer's instructions and reprocess the individual parts separately from each other.
- Lightweight wash items should be secured with cover nets to prevent them from spinning around in the wash cabinet and blocking the spray arms.
- Only reprocess small items and micro components in special inserts, mesh trays with lids, or filters.
- The spray arms must not be blocked by wash items which are too tall or which hang down in their path.

Application technology

- Broken glass and ceramics can result in serious injury when loading or unloading. Damaged glass or ceramic wash items must not be reprocessed in the machine.
- Nickel and chrome-plated wash items and items made of aluminum are not generally suitable for machine reprocessing. Special process conditions are required for these wash items.
- For wash items made entirely or partly of plastic, observe the maximum temperature resistance and select the program accordingly or adjust the temperature of the program.

Suitable load carriers and rinse fittings as well as other accessories are available from Miele.

Preparing the wash items

 Danger of explosion due to flammable gases.
Flammable solvents with a flash point below 70°F (21°C) outgas and can generate a flammable mix of gases.
Only place wash items into the wash cabinet that are wetted with traces of solvents at most.
Start a reprocessing program immediately after loading.

 Material damage due to solvents.
Solvents can damage the elastomers and plastics of the machine and lead to leaks.
Only place wash items into the wash cabinet that are wetted with traces of solvents at most.
Start a reprocessing program immediately after loading.

 Material damage due to corrosion.
Chloride solutions, particularly hydrochloric acid, and ferrous materials that can rust or corrode cause corrosion on the stainless steel of the machine and the load carrier.
Do not introduce any chloride solutions into the wash cabinet.
Do not introduce any ferrous materials that can rust or corrode into the wash cabinet.

 Risk of infection and risk of environmental damage.
Microbiological material, pathogens, facultative pathogens, and genetically modified material can cause infections or environmental damage.
Observe the laws, standards, and guidelines for handling biohazardous substances.

- Follow the wash item manufacturer's instructions regarding pre-cleaning and pre-treatment.
- Empty all wash items before loading into the machine and pay particular attention to relevant regulations.
- Pour blood residues out of vessels and scoop out blood clots.
- Disassemble the wash items according to the instructions of the wash item manufacturer.

- Open available faucets and valves or remove them according to the manufacturer's instructions and place the individual parts in suitable basket for small parts.
- Remove all stoppers, corks, labels, sealing wax residue, etc.
- If necessary, rinse the wash items briefly with water so that larger quantities of soiling are not introduced into the wash cabinet.
- Rinse wash items which have been in contact with solvents, chloride solutions, or hydrochloric acid thoroughly with water and drain well before placing them in the wash cabinet. Start a reprocessing program immediately after placing in the wash cabinet.
- Remove water-insoluble residues such as paint, adhesives, and polymer compounds using appropriate solvents.
- Scoop nutrient media (agar) out of petri dishes.
- Place small parts and micro components in suitable basket for small parts to secure them.
- Remove any aids which are difficult to get rid of and contaminate the wash items in addition to the original soiling. These include grease, paper labels, and other labels.
- Assess whether the wash items must be sterilized before reprocessing if they are contaminated with:
 - microbiological material
 - pathogens
 - facultative pathogens
 - genetically modified material

Checks before starting a program

Carry out a visual check before starting every program:

- Are the wash items correctly loaded and connected for cleaning?
- Was the recommended loading template followed?
- Can the lumen/narrow sections of hollow wash items be accessed by the wash water?
- Are the spray arms clean and do they rotate freely?
- Is the filter combination clean and securely installed?
Remove any coarse soiling and clean the filter combination if necessary.
- Are the removable modules, nozzles, irrigation sleeves, and other irrigation connectors securely connected?
- Are the load carriers with spray arms or nozzles, irrigation sleeves, and other irrigation connectors correctly connected to the water supply?
- Are all process chemical containers sufficiently filled?

After reprocessing

Tests

The following must be checked at the end of every program:

- Carry out a visual check of the wash items for the cleaning results.
- Are all lumened wash items still attached to the appropriate nozzles?

The reprocessing results may be impaired if the wash items have been turned over or detached from the irrigation connectors or have tipped over during reprocessing.

Assess whether reprocessing needs to be repeated.

- Are the lumens of hollow wash items free from obstructions?
- Are the nozzles and connections securely held in position in the load carriers?
- If the machine is equipped with a drying unit, carry out a visual check of the wash items for the drying results.

Process validation

As a rule, it is the responsibility of the user to ensure that items cleaned in the machine meet the required standards.

Laboratory glassware

Wash items with wide necks

Wash items with wide necks, such as glass beakers, wide-neck Erlenmeyer flasks, and petri dishes, or cylindrical items such as test tubes, can be cleaned and rinsed inside and out using rotating spray arms. To do this, the wash items are positioned in appropriate inserts and placed in a basket or mobile unit with a spray arm.

Wash items with narrow necks

Mobile injector units or special injector modules are required for wash items with narrow necks, e.g., narrow-necked Erlenmeyer flasks, round flasks, measuring flasks, etc.

Reprocessing pipettes requires specially adapted mobile injector units or injector modules.

Suitable load carriers and rinse fittings as well as other accessories are available from Miele.

When loading please note:

- Place petri dishes or similar items in the appropriate insert with the soiled side facing downward.
- Position inserts for test tubes in the center on the load carriers to leave the corners of the load carriers free.
- Use a cover net to prevent breakages if necessary.
- Place pipettes with the pointed end facing downward.

Chemical processes and technology

In this section, you will find a description of the causes of common chemical reactions which can occur between different types of soiling, process chemicals, and the components of the machine, along with their remedies as necessary.



This section is intended as a guide. If unforeseen interactions occur during reprocessing or if you have any queries on this subject, please seek advice from Miele.

General information	
Problem	Solution
<p>If elastomers (hoses and seals) and plastics in the machine are damaged, for example by swelling, shrinking, hardening, or brittleness of materials, tears, and cracks, components will not function correctly and this generally leads to leaks.</p>	<ul style="list-style-type: none"> - Determine and remedy the causes of the damage. <p>See information regarding “Associated process chemicals”, “Soiling”, and “Reaction between process chemicals and soiling” in this section.</p>
<p>A heavy build-up of foam during the program sequence will impair the cleaning and rinsing effect on the wash items. Foam escaping from the wash cabinet can cause damage to the machine.</p> <p>When foam develops, the cleaning process is not standardized or validated in principle.</p>	<ul style="list-style-type: none"> - Determine and remedy the causes of the foam. - Check the process used regularly to monitor foaming levels. <p>See information regarding “Associated process chemicals”, “Soiling”, and “Reaction between process chemicals and soiling” in this section.</p>
<p>Corrosion to stainless steel in the wash cabinet and to accessories can give them a different appearance:</p> <ul style="list-style-type: none"> - rust (red marks/discoloration) - black stains/discoloration - white stains/discoloration (etched surface) <p>Corrosive pitting can lead to the machine not being water-tight. Depending on the application, corrosion can affect cleaning and rinsing results (laboratory analysis) or cause corrosion to (stainless steel) wash items.</p>	<ul style="list-style-type: none"> - Determine and remedy the causes of corrosion. <p>See information regarding “Associated process chemicals”, “Soiling”, and “Reaction between process chemicals and soiling” in this section.</p>

Chemical processes and technology

Associated process chemicals	
Problem	Solution
The ingredients in process chemicals have a significant impact on the longevity and functionality (throughput) of dispensing hoses.	<ul style="list-style-type: none"> - Follow the process chemical manufacturer's instructions and recommendations. - Carry out a regular visual check of the dispensing hose (suction lances, hoses, canisters, etc.) for any damage. - Regularly check the flow rate of the dispensing hose. - Ensure that the regular cycle of maintenance is observed. - Please contact Miele for advice.
Process chemicals can damage elastomers and plastics in the machine and accessories.	<ul style="list-style-type: none"> - Follow the process chemical manufacturer's instructions and recommendations. - Carry out a regular visual check of any accessible elastomers and plastics for damage.
Hydrogen peroxide can release large amounts of oxygen.	<ul style="list-style-type: none"> - Only use validated processes. - The wash temperature must be lower than 158°F (70°C) when using hydrogen peroxide. - Please contact Miele for advice.
<p>The following process chemicals can cause large amounts of foam to build up:</p> <ul style="list-style-type: none"> - cleaning agents and rinsing agents containing surfactants <p>Foam can occur:</p> <ul style="list-style-type: none"> - in the program phase in which the process chemical is dispensed - in the following program block if it has been spilt - in the following program with rinsing agent if it has been spilt 	<ul style="list-style-type: none"> - The process parameters in the wash program, such as dispensing temperature, dosage concentration, etc., must be set to ensure the whole process is foam-free or very low-foaming. - Please observe the process chemical manufacturer's instructions.
<p>De-foaming agents, especially silicone-based ones, can cause the following:</p> <ul style="list-style-type: none"> - a build-up of deposits in the wash cabinet - a build-up of deposits on the wash items - damage to elastomers and plastics in the machine - damage to certain plastics (e.g., polycarbonate and plexiglass) in the wash items 	<ul style="list-style-type: none"> - De-foaming agents should be used as an exception only; for instance, when they are essential for the process. - The wash cabinet and accessories should be periodically cleaned without wash items and without de-foaming agent using the  Organic program. - Contact Miele for advice.

Chemical processes and technology

Soiling	
Problem	Solution
<p>The following substances can damage elastomers (hoses and seals) and plastics in the machine:</p> <ul style="list-style-type: none"> - oil, wax, aromatic and unsaturated hydrocarbons - emollients - cosmetics, hygiene and skincare products such as creams (analytical applications, filling) 	<ul style="list-style-type: none"> - Depending on usage, wipe the lower door seal on the machine periodically with a lint-free all-purpose cloth or sponge. Clean the wash cabinet and accessories without wash items using the  Organic program. - Reprocess the wash items using the  Oil program or use a special program that dispenses cleaning agents containing surfactants.
<p>The following substances can lead to a heavy build-up of foam during washing and rinsing:</p> <ul style="list-style-type: none"> - some disinfection agents, dishwashing cleaning agents, etc. - reagents for analysis, e.g., for microtiter plates - cosmetics, hygiene and skincare products such as shampoos and creams (analytical applications, filling) - active foaming agents such as surfactants 	<ul style="list-style-type: none"> - Thoroughly rinse the wash items in water beforehand. - Select a cleaning program with at least one short pre-wash in cold or hot water. - Depending on the application, use de-foaming agents that do not contain silicone oils.
<p>The following substances may cause corrosion to stainless steel in the wash cabinet and on accessories:</p> <ul style="list-style-type: none"> - hydrochloric acid - other substances containing chlorides, such as sodium chloride - concentrated sulphuric acid - chromic acid - particles of iron and shavings 	<ul style="list-style-type: none"> - Thoroughly rinse the wash items in water beforehand. - Put the drip-dry wash items into the load carriers and start a reprocessing program as soon as possible after placing in the wash cabinet.

Reaction between process chemicals and soiling	
Problem	Solution
<p>Natural oils and fats can be emulsified with alkaline process chemicals. This can lead to a heavy build-up of foam.</p>	<ul style="list-style-type: none"> - Use the  Oil program. - This special program dispenses emulsifiers (pH neutral) in the pre-wash. - Depending on the application, use de-foaming agents that do not contain silicone oils.
<p>Soiling containing high protein levels, such as blood, can cause a heavy build-up of foam when processed with alkaline process chemicals.</p>	<ul style="list-style-type: none"> - Select a cleaning program with at least one short pre-wash in cold water.
<p>Non-precious metals such as aluminum, magnesium, and zinc can release hydrogen when processed with very acidic or alkaline process chemicals (oxyhydrogen reaction).</p>	<ul style="list-style-type: none"> - Please observe the process chemical manufacturer's instructions.

Adding and dispensing process chemicals

Process chemicals

⚠ Unsuitable process chemicals pose a health risk.
Using unsuitable process chemicals will generally cause an unsatisfactory wash result and can pose a health risk or cause damage to property.
Only use process chemicals designed specifically for use in laboratory glassware washers and follow the manufacturer's instructions on how to use them.
Please follow any instructions relating to non-toxic residues.

⚠ Process chemicals pose a health risk.
Some process chemicals may be corrosive and irritant.
Observe the relevant safety codes and safety data sheets issued by the process chemical manufacturers when handling process chemicals.
Take all protective measures required by the process chemical manufacturer, e.g., wear protective goggles and protective gloves.

Highly viscous (thick) process chemicals can affect the dispensing monitoring and lead to inaccurate data. In this instance, please contact Miele Service for advice.

Contact Miele for information about suitable process chemicals.

The safety data sheets for the process chemicals must be easily accessible during operation of the machine.

Process chemicals The machine is only designed for use with liquid cleaning agents. The liquid cleaning agent is dispensed from an external canister via a suction lance.

For environmental reasons it is important to always consider the following factors when selecting a cleaning agent:

- How alkaline does the cleaning agent need to be for the cleaning application involved?
- Are protein-removing enzymes required and is the program sequence suitable for this?
- Are surfactants required for proper dispersion and emulsification?
- Is a cleaning agent containing active chlorine required or can a cleaning agent without active chlorine be used?

⚠ Cleaning agents containing chlorine can damage the plastics and elastomers inside the machine.
If the use of cleaning agents containing chlorine is required, a maximum temperature of 167°F (75°C) is recommended in the program blocks involving the dispensing of cleaning agents (📖 "Program overview").
Cleaning agents containing chlorine must not be used in machines supplied (at the factory) with special oil-resistant elastomers for oil and fat applications.

Adding and dispensing process chemicals

For cleaning specific types of soiling, and for information on the optimum cleaning agents and additives to use for liquid dispensing, Please contact Miele Service.

Neutralizing agent

Neutralizing agent is dispensed via an internal dispensing hose.

Neutralizing agent (pH setting: acidic) neutralizes residues of alkaline cleaning agents on the surface of the wash items.

In the Inorganic program, neutralizing agent is also dispensed for acidic pre-cleaning.

Rinse aid

Rinse aid is necessary to ensure water does not cling and leave marks on wash items, and to help wash items dry faster after reprocessing.

The dispensing of rinse aid is deactivated at the factory.
To activate it, please contact Miele Service.

Rinse aid dispensing should be activated if DI water is not being used in the Final rinse program section.

 Residues of rinse aid remain on the surface of wash items after they have dried.
It is important to check the suitability of the rinse aid being used on the wash items.

Adding and dispensing process chemicals

Dispensing systems

The machine is designed for dispensing the following process chemicals:

- Cleaning agent
Liquid cleaning agents are dispensed via an internal dispensing hose.
- Neutralizing agent
Dispensing is carried out using a suction lance from a canister.
- Rinse aid
Rinse aid is dispensed via an internal dispensing hose.

Dispensing systems in the door are exempt from monitoring.

Color coding on the suction lances

Liquid process chemicals from external canisters are dispensed via suction lances. Color coding can be helpful for correct dispensing.

Miele uses and recommends the following:

- Blue: For cleaning agents
- Red: For neutralizing agents
- Green: For chemical disinfection agents or an additional second cleaning agent
- White: For acidic process chemicals
- Yellow: For free choice

Replacing the media canister

 Damage caused by using unsuitable cleaning agents. Using unsuitable cleaning agents, such as a cleaning agent for a domestic dishwasher, will mean that the reprocessing result is not as expected. Only use cleaning agents that are suitable for cleaning machines.

Only replace empty canisters with canisters containing the appropriate process chemicals. The reprocessing results are sometimes significantly impaired by dispensing the wrong process chemicals in the program blocks. In addition, mixing different process chemicals in the dispensing hose can lead to unexpected chemical reactions. Pay attention to the color coding on the suction lances.

When the fill level in the canister is low, you are reminded to change the canister; see the example for cleaning agent here:

Adding and dispensing process chemicals

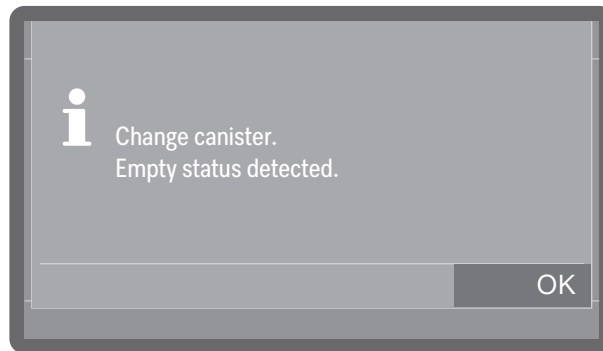

- Press OK to confirm the message.

Once the supply has been used up, the machine is locked to prevent further use.

The lock is lifted some time after the canister has been replaced.

- Open the side unit.
- Remove the canister and place it on a robust and easy-to-clean surface, e.g., the wash cabinet door.
- Take the lid off the canister and remove the suction lance.
- Place the suction lance on a robust and easy-to-clean surface, e.g., the wash cabinet door.
- Replace the empty canister with a full one.

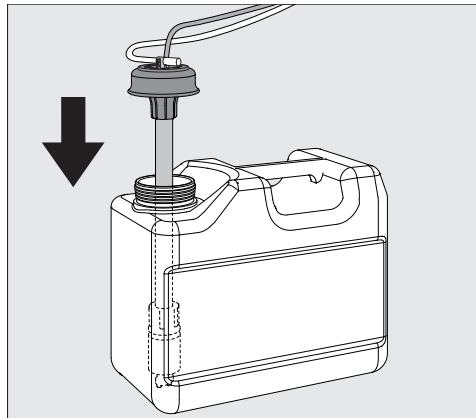

- Push the suction lance into the opening of the canister and secure the lid.
- Feed the suction lance into the canister until it reaches the bottom.
- Wipe up any spilled process chemical thoroughly.
- Put the canister back in the side unit.
- Close the side unit. Ensure that the dispensing hoses and cables are not kinked or trapped.

When replacing the canisters, air can get into the dispensing hose and lead to inaccurate dispensing. For this reason, we recommend that you refill the dispensing hose after changing the canister.

Adding and dispensing process chemicals

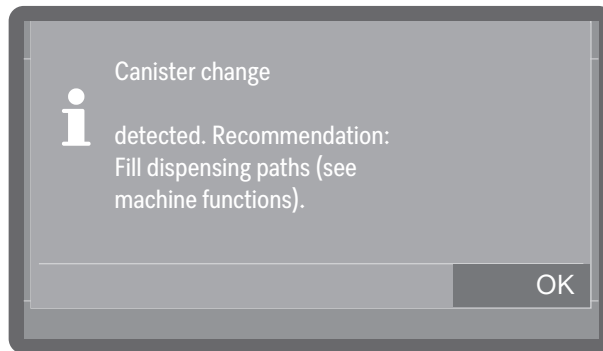

- Confirm the message with OK.
- To fill the dispensing hose, select the corresponding dispensing hose at ▶  Machine functions ▶ Dispensing paths ▶ Fill dispensing paths and start the process. The hose is filled automatically.

Setting the dispensing concentration

The dispensing concentration is set at ▶  Extended settings ▶ Maintenance/Service ▶ Dispensing system.

Neutralizing agent If spots appear on wash items after reprocessing:

- Decrease the amount dispensed.

If clouding or smearing appears on wash items after reprocessing:

- Increase the amount dispensed.

Rinse aid

If spots appear on wash items after reprocessing:

- Increase the amount dispensed.

If clouding or smearing appears on wash items after reprocessing:

- Decrease the amount dispensed.

Selecting a program

Always select the correct program depending on the application, type of wash items and type of soiling.

- You can find a list of all programs along with application descriptions in  “Program overview”.
- All released programs are available for selection.
- The order of the programs can be changed as required.

Tip: To release or block programs; see

▶  Extended settings ▶ Program options ▶ Release programs.

Tip: To change the order of the programs; see ▶  Extended settings

▶ Program options ▶ Set Favorites.

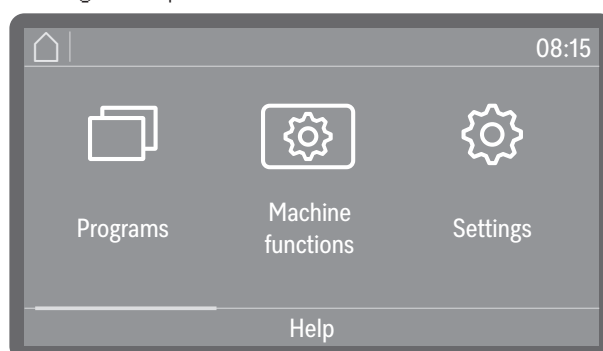

- Tap  Programs and select a program from the list; see  “Program overview”.

As soon as you have selected a program, the *Start/Stop* button starts to flash.

Use the  Cancel button to return to the program selection screen before the program starts, e.g., to select a different program. This is no longer possible once the program has started.

Program information

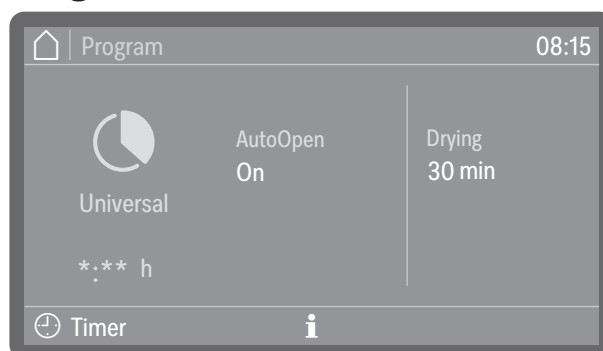

(*:* Program runtime varies depending on configuration)

In the program display, you can use the information symbol  to call up information about the program or, while a program is running, information about the current wash block.

Starting a program

Selecting and des- electing additional functions

Before starting the program, you can activate or deactivate the additional functions that are displayed to the right of the program name by tapping them.

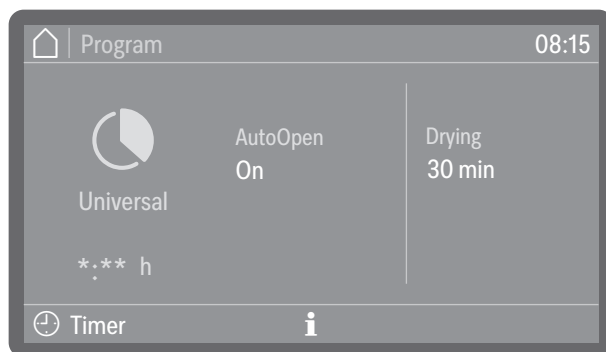

(*:** Program runtime varies depending on configuration)

Activated functions are highlighted in color. The type and number of additional functions vary depending on the program and machine features.

AutoOpen

AutoOpen is an additional assisted drying function. At the end of the program, the door opens slightly to allow residual moisture to escape from the wash cabinet more quickly.

The door is opened as soon as the temperature in the wash cabinet has dropped below a certain value. Before the door is opened, a corresponding message is shown on the display and an audible signal sounds if audible signals are activated.

Drying

If the drying time (► Drying time 2) is set as changeable (► Time changeable?: Yes) in the program settings, the drying time set can be altered. If the drying time is set as not changeable (► Time changeable?: No), the preset time applies; see ► Extended settings ► Program options ► Configure programs ► Drying ► Drying time 2 ► Time changeable?.

When the drying function is activated, the program runtime is extended.

Starting a program immediately

- Press the *Start/Stop* button (the LED of the *Start/Stop* button will light up).

Once a program has been started, it can no longer be changed. You can interrupt a program that is in progress; see “Interrupting a program”, or end it prematurely by canceling it; see “Canceling a program”.

Starting the pro- gram using a timer

The start of a program can be delayed; for example, to benefit from economy rates of electricity at night. You can set a start time at which the program should start (*Start at*) or a finish time by which the program should end at the latest (*Finish at*). The times depend on the set time of day.

Tip: To set the time of day; see ► Extended settings ► Date/Time ► Time.

Setting the timer

- Select a program.

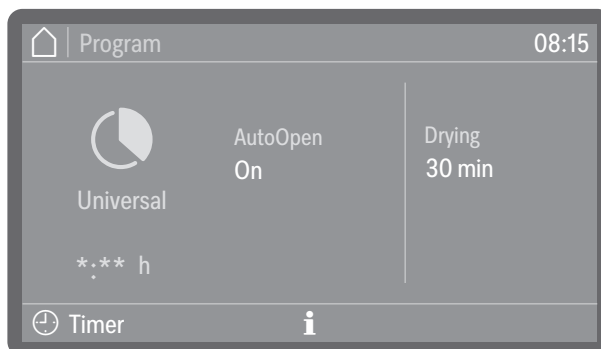

(*:** Program runtime varies depending on configuration)

- Tap Timer.

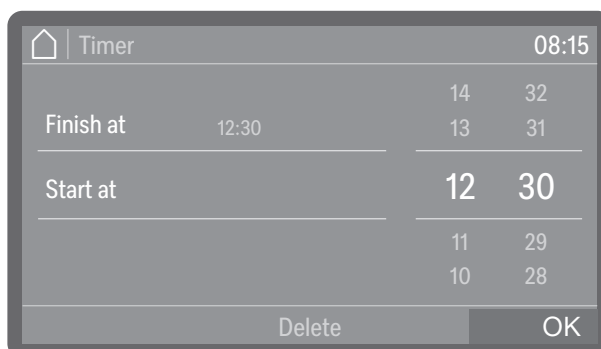

- Select the start time (Start at) or finish time (Finish at).
- Set the time.
Selecting Delete allows you to delete the entries.
- Press OK to confirm your entries.

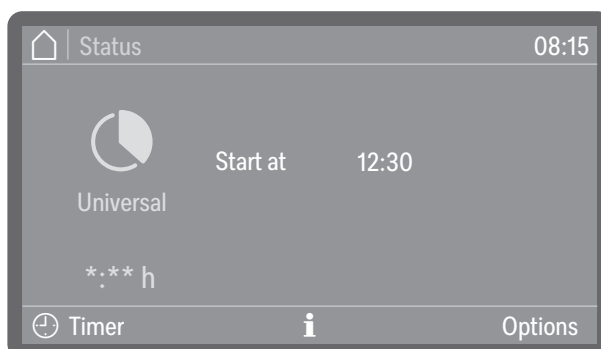

(*:** Program runtime varies depending on configuration)

This activates the timer. Depending on the program, you can add or remove additional functions for the next program cycle via Options; see “Selecting and deselecting additional functions”. Some time after the last input, the machine switches to Standby mode until the program starts.

Changing the timer

- Tap Timer.
- Re-enter the start or finish time.

Operation

Deleting the timer ■ Press the *Start/Stop* button.

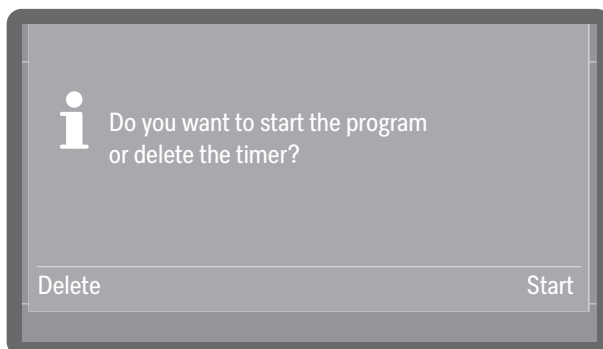

You will then be asked whether you want to start the program immediately (Start) or whether you want to delete the timer (Delete).

■ Select an option.

Tip: Alternatively, you can switch off the machine by pressing the  On/Off switch, which automatically deactivates the timer.

Program cycle display

Once a program has started, the display shows the program name, the name of the current wash phase, and the time left until the program is finished.

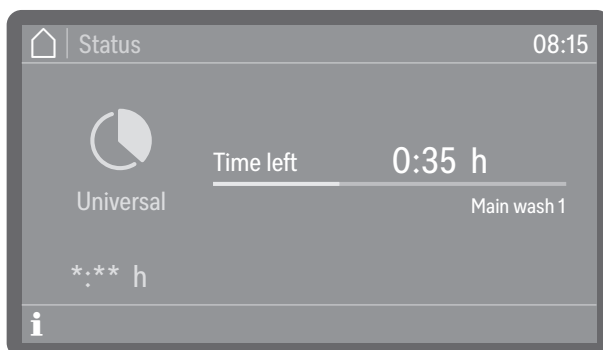

(*:** Program runtime varies depending on configuration)

During the program sequence, program information can be called up by tapping the information symbol .

Only the parameters that are set for the wash block that is currently in progress are shown, for example:

- Temperature as actual value and setpoint if a temperature has been specified for the wash block
- Activation time as actual value and setpoint if an activation time has been set
- A₀ value as actual value and setpoint, for wash blocks with thermal disinfection and activated A₀ value control
- Cycle number
- Conductivity as limit value, if conductivity is monitored in the wash block, and as actual value, if conductivity is also measured (equipment variant)
- Drying as setpoint and actual value (equipment variant)

End of the program

After a program has ended normally, the LED of the *Start/Stop* button will go out and the following will appear on the display:

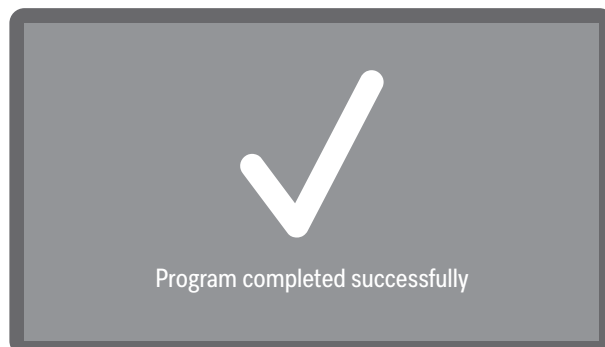

The door button starts to light up to indicate that the door can be opened.

In addition, an audible signal sounds for approx. 3 seconds and is repeated 3 times every 30 seconds.

Tip: The audible signal settings can be found at **▶ Settings ▶ Volume ▶ Buzzer tones**.

Acknowledging the end of the program

■ Tap the display to acknowledge the end of the program.

If system messages are pending at this time, these are then output, e.g., if a lack of salt or process chemicals has been detected or a notification regarding when the next maintenance is due. Every message needs to be acknowledged individually by pressing **OK**.

Displaying program information

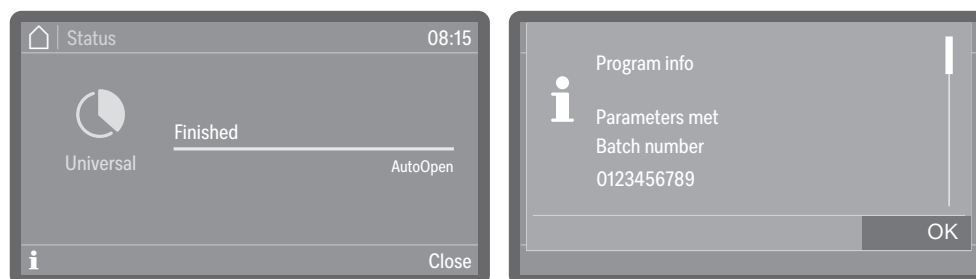

At the end of the program, tap the information symbol **i** to call up program information, for example:

- Parameters met
- Cycle number
- Conductivity, if conductivity is monitored (equipment variant)
- Spray arm speed as OK or Not OK if monitoring is active
- Wash pressure as OK or Not OK if monitoring is active

If **▶ Batch control** is activated, the cycle must first be documented on the display before the program information can be displayed.

Batch control

If you carry out batch controls, you can document the results in the batch protocols of the machine. For this purpose, the function must be activated and a user ID must be set up for each authorized operator; see **▶ Settings ▶ Extended settings ▶ Program options ▶ Batch control**.

Operation

If batch control is activated on the machine, the cleaning results of the completed program must first be documented before the next program can be started.

Carrying out batch control

- Acknowledge the end of the program.
- Tap on the information symbol **i** and check whether the displayed parameters are as expected.
- Open the door, remove the wash items, and carry out all the necessary checks to verify the cleaning results, e.g., visual checks.
- Close the door and document the result on the display.

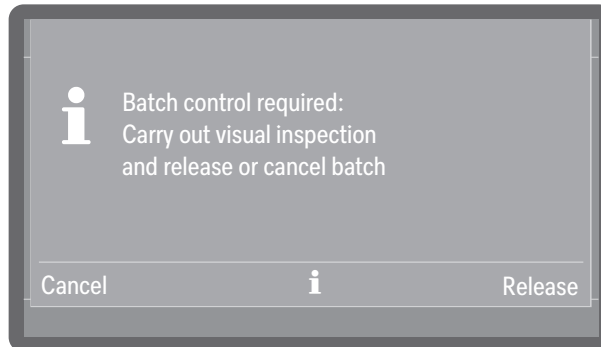

- Release

The cleaning results meet expectations.

- Cancel

The cleaning results are inadequate.

Do not continue to use wash items from canceled cycles.
The wash items must either be reprocessed or disposed of.

- Select one of the options.

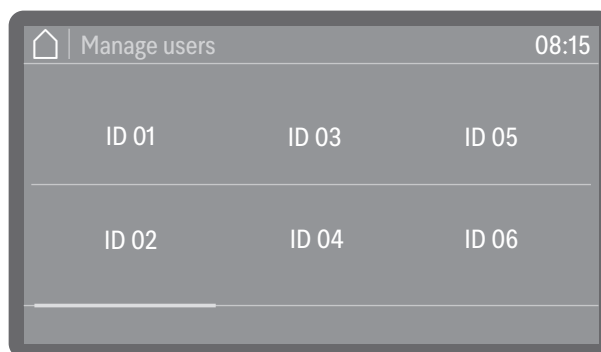

- Select your user ID.

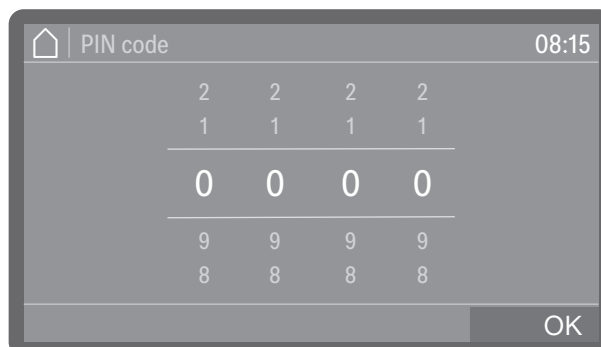

- Enter your personal PIN code; see  "PIN code".

If the PIN code is repeatedly entered incorrectly, the process will be canceled and the result will not be documented. Instead, the failed result documentation will be recorded in the batch protocol.

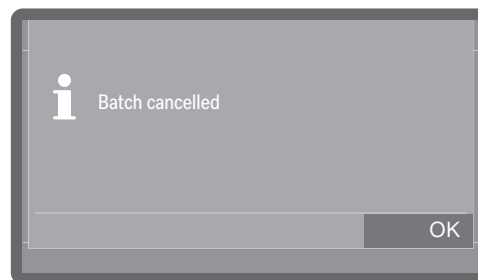
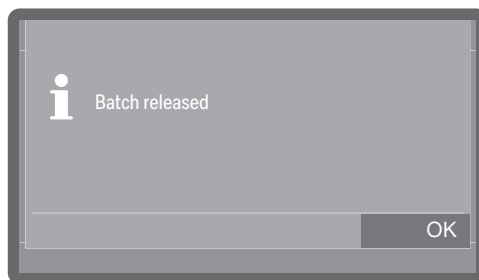

- Press OK to confirm the result of the batch control.

The cleaning results will be documented in the batch protocol together with the user ID.

Personal PIN codes must not be shared.

The PIN code identifies the owner of the user ID at the machine. If the personal PIN code becomes public knowledge, it is no longer possible to trace which operator used the user ID for the documentation.

Interrupting a program

A program that is in progress may only be interrupted if strictly necessary, e.g., if the wash items are moving significantly. To interrupt the program, the door of the wash cabinet must be opened.

Tip: The option to interrupt a program must be enabled; see ▶ Extended settings ▶ Program options ▶ Program interruption.

- To open the door, press the door button.

If the door lock is activated, you must first enter the PIN code to unlock the door; see ▶ Extended settings ▶ Program options ▶ Door lock code. If the lock is deactivated, you can open the door without entering a code. If you cancel the process, do not enter a PIN code, or enter an incorrect PIN code, the program will continue without interruption.

- Enter the door lock code.

If the temperature in the wash cabinet exceeds 140 °F (60 °C), a message is shown on the display:

Hot wash cabinet: Risk of injury, take care when opening the door.

- Acknowledge the message by pressing the door button again.

The door is then unlocked and the comfort door lock opens the door slightly.

- Rearrange the wash items so that they are stable.
- Close the door to continue the program.

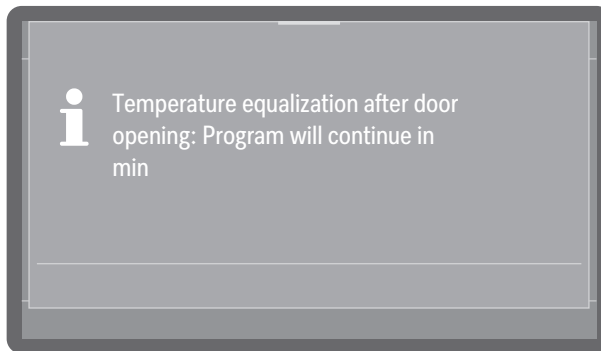

If the temperature inside the wash cabinet is more than 140°F (60°C) at this point, the pressure is equalized first. Then the program continues.

Canceling a program

If a program is canceled, the wash items in the machine must be re-processed again.

 Danger of scalding, burning, and chemical burns due to hot wash items, wash water, or escaping vapors. The wash items and the wash cabinet may be very hot. Hot wash water or steam may also escape. Be careful when opening the door. Open the door slowly and do not stand in the rising vapors.

Program canceled due to a fault

The program stops and a fault message appears on the display.

- Take appropriate steps to resolve the fault, depending on its cause; see  "Frequently asked questions".

Canceling a program manually



A program that is in progress may only be canceled if strictly necessary, e.g., if the wash items are moving significantly.

- Press the *Start/Stop* button.

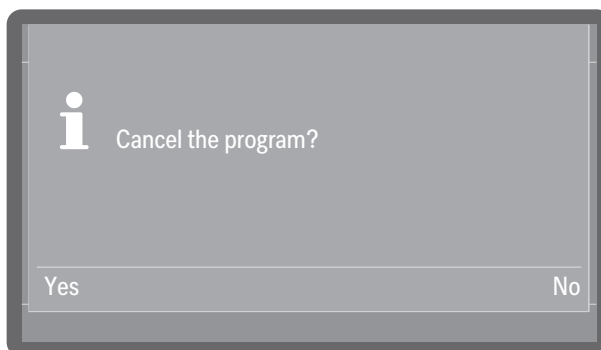
The following will appear on the display:



- Select Yes to cancel the program.

Tip: A PIN code may still need to be entered. To enter the PIN code; see  "Entering the PIN code". To set up the PIN code lock; see  Extended settings ▶ Program options ▶ Door lock code.

The program will only be canceled when Yes is confirmed. If no button is pressed for several seconds, or if the process is canceled using the ↵ button, the display will revert to the program sequence display.

The following message will appear on the display:

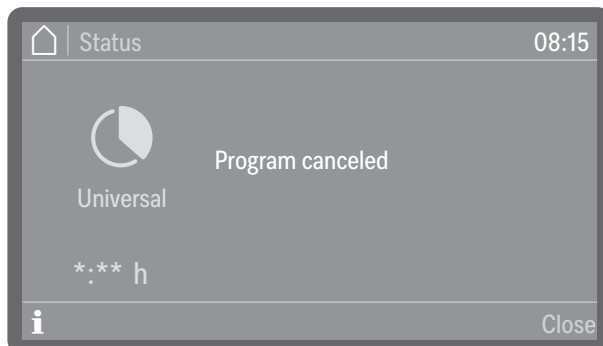

The door must be opened to acknowledge the message. Open the door a little.

Restarting the program ■ Restart the program or select a new program.

Menu structure

The  Machine functions menu includes relevant functions to support daily routine tasks.

The factory settings are indicated by a tick ✓. A description of how to configure settings is provided after the overview.

Machine functions

Filter interval

Filter combination *)

Coarse filter

HEPA filter

Dispensing paths

Fill dispensing paths

Rinse dispensing paths

AutoClose

Off

On ✓

Documentation

Last report

Selected reports

*) Visible if the interval is activated; see  Extended settings ▶ Maintenance/Service ▶ Filter maintenance.

Filter interval

The machine is equipped with several filters and a filter system, subsequently referred to as filters, which require regular maintenance. Reusable filters must be cleaned and disposable filters replaced.

For more information on cleaning or replacing the filters; see  “Maintenance”. Reusable filters used in load carriers have their own operating instructions and cleaning instructions.

You can use the following menu to display the remaining time left or cycles of the filters and reset the counter after a filter has been changed or cleaned.

The menu is saved under the following input path.

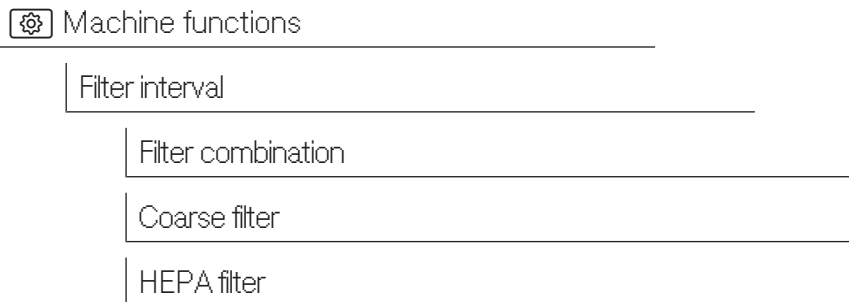

■ Select a filter.

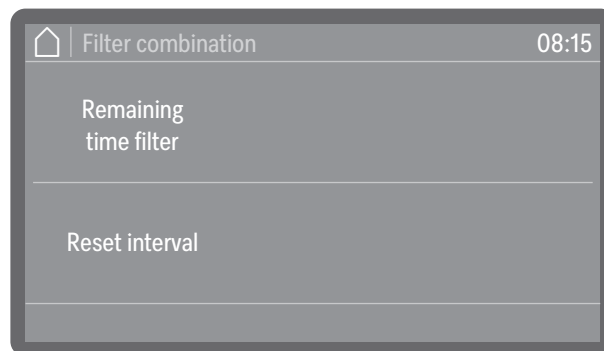

- Remaining filter cycles or Remaining time filter (depending on the type of filter selected)

Displays the remaining program sequences (cycles) or operating hours until the next maintenance (cleaning or replacement)

- Reset interval

Resets the counters for the filter cycles

 The intervals must only be reset once the filters have been cleaned or replaced.

■ Select an option.

Dispensing systems

The dispensing systems for liquid media can only dispense reliably if the dispensing system has been purged of air and contains no deposits.

Filling dispensing paths

The dispensing hoses need to be topped up in the following situations:

- If the dispensing hose is being used for the first time.
- If air has been sucked in or the system has been drained.
- If canisters for liquid media have been changed or refilled.

Before filling the dispensing paths, make sure that the canisters are full and that the suction lances are screwed securely to the canisters and that they cannot suck in air.

The menu is saved under the following input path.

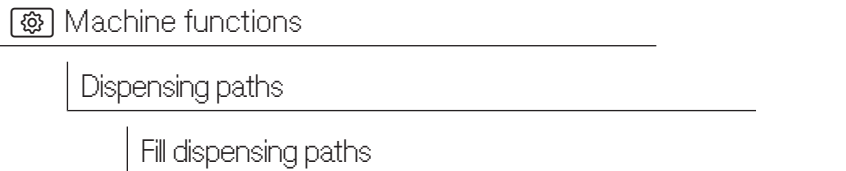

- Select the Fill dispensing paths menu option.
- Select the dispensing hose that you want to fill.

You will then be asked if you want to start the filling process:

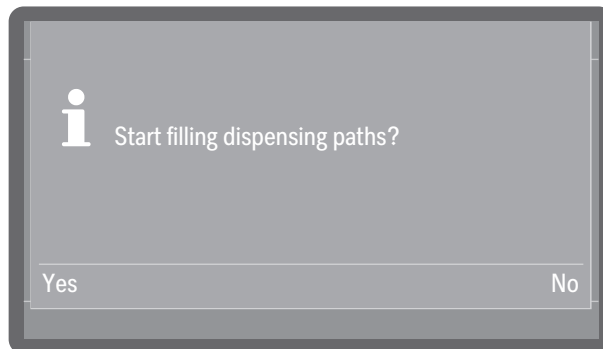

- Yes

Starts the process. The dispensing hose is filled automatically. The message `Fill dispensing paths completed` is displayed following successful completion. If filling is interrupted prematurely, the process must be repeated.

- No

Cancels the process without filling the dispensing hose.

- Select an option.

Rinsing dispensing paths

A dispensing hose must be rinsed in the following situations:

- If a dispensing hose was accidentally filled with the wrong medium.
- If deposits have formed in the dispensing paths or in the canisters which could completely or partially clog the systems. Deposits can form, for example, after long periods of downtime or when the canisters are refilled instead of being replaced.
- Fill a clean container, e.g., a bucket, with clear, clean water.

 **Damage to the dispensing hose.**
 Small foreign objects in the water, such as sand, lint, or similar, can be sucked in by the dispensing hose and may clog or damage it. Make sure that there are no foreign objects in the water.

The menu is saved under the following input path.

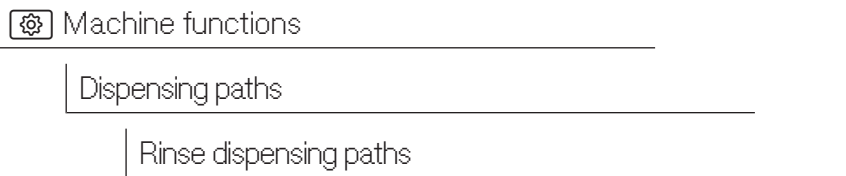

- Select the Rinse dispensing paths menu option.
- Select the dispensing hose that you want to rinse.

The message **Place the suction lance in a bucket with water.** is then displayed.

- Place the suction lance in the container filled with water. The lower end of the suction lance with the suction opening must be thoroughly rinsed.
- Secure the suction lance so that it cannot tip over or fall out of the container.
- Confirm the message with **OK**.

You will then be asked if you want to start the process:

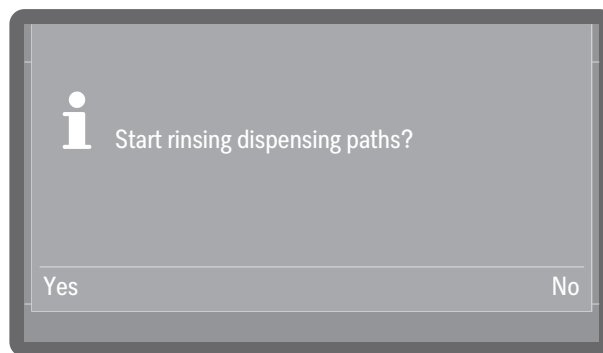

- Yes
 Starts the process. The dispensing hose is rinsed automatically. The message **Rinse dispensing paths completed** is displayed following successful completion. If rinsing is interrupted prematurely, the process must be repeated.
- No
 Cancels the process without rinsing the dispensing hose.
- Select an option.

AutoClose

This can be used to determine whether the door should be drawn into the final closed position by the automatic door lock immediately after closing or whether it should remain slightly open.

In its final closed position, the door is mechanically locked and can be unlocked and opened again by pressing the door button .

The menu is saved under the following input path.

 Machine functions

AutoClose

- Select the AutoClose menu option.

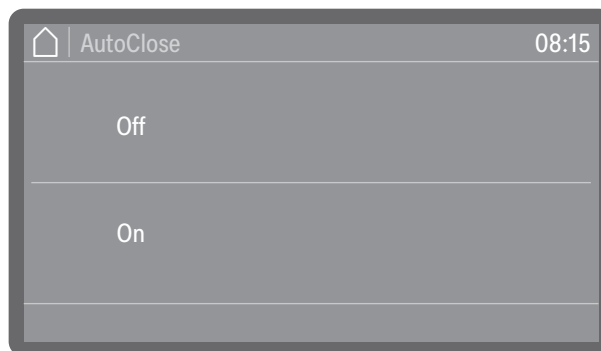

- On

AutoClose is activated for all programs. The door is drawn into the final closed position and locked immediately after closing.

- Off

AutoClose is deactivated for all programs. The door hooks into the door latch and can be pulled open again without pressing the  button.

- Select an option.

Documentation

Internally stored protocols can be output retrospectively from the machine. To do this, the machine must be connected to a network or to a printer; see ► Wi-Fi / LAN.

The menu is saved under the following input path.

 Machine functions

Documentation

- Select the Documentation menu option.

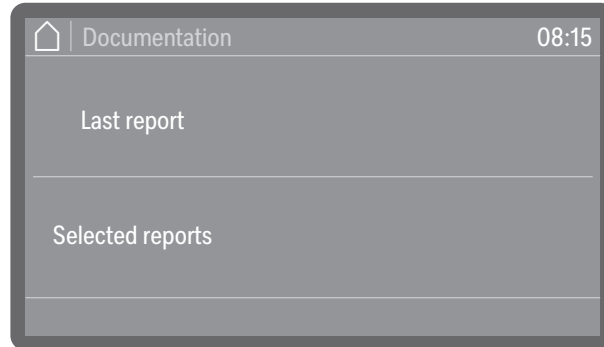

- Last report

The last batch protocol is output again.

- Selected reports

You can select individual protocols from the last protocols and have them displayed.

- Select an option.

Menu structure

Basic parameters for machine control are stored in the  Settings menu.

The factory settings are indicated by a tick ✓. A description of how to configure settings is provided after the overview.

 Settings

Display brightness

Volume

Buzzer tones

Keypad tone

Welcome melody

Off

On ✓

Lighting *)

Off

On

Automatic ✓

*) Available for machines with glass door

Display brightness

You can also set the brightness of the display.

The menu is saved under the following input path.

 Settings

Display brightness

- Select the Display brightness menu option.



- Adjust the brightness of the display and press *OK* to save the setting.

Volume

An acoustic signal transmitter is integrated in the control panel, which can provide acoustic feedback in the following situations:

- Keypad tone when operating the buttons
- Buzzer tones at the end of the program or for system messages (notifications)

The menu is saved under the following input path.

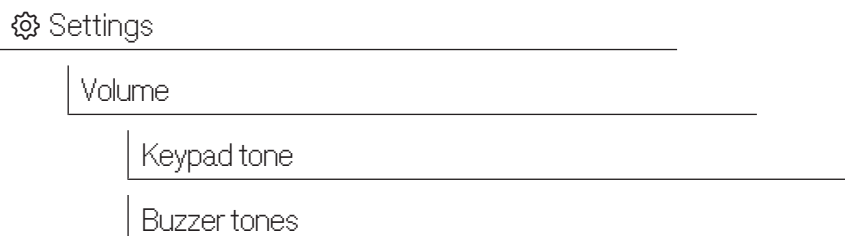

- Select the Volume menu option.
- Select either Keypad tone or Buzzer tones. The volume is set in the same way for both options.

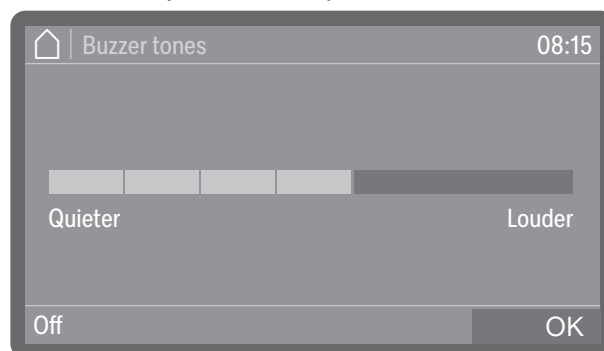

- Set the volume.
If you select Off, the sound can be switched off entirely. You can switch it on again if required by selecting On (displayed instead of Off).
- Press *OK* to save the setting.

Welcome tone

There is a brief melody when the machine is switched on and off. You can use this option to switch this melody off and back on again.

The menu is saved under the following input path.



- Select the Welcome melody menu option.

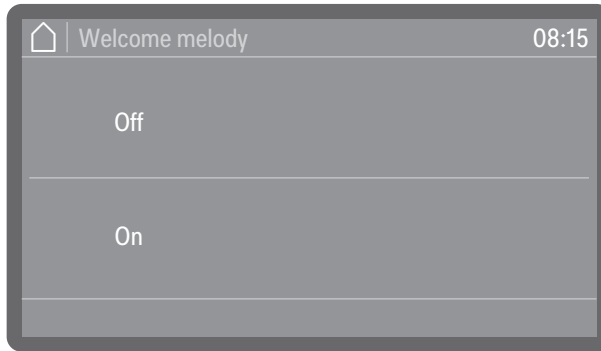

- Off
The melody is switched off.
 - On
A welcome melody is played when the machine is switched on.
- Select an option.

Lighting

Available for machines with glass door.

Machines with glass doors are equipped with chamber lighting that allows the reprocessing procedure to be monitored. The lighting can be switched on and off as required.

The menu is saved under the following input path.

Settings

Lighting

- Select the Lighting menu option.

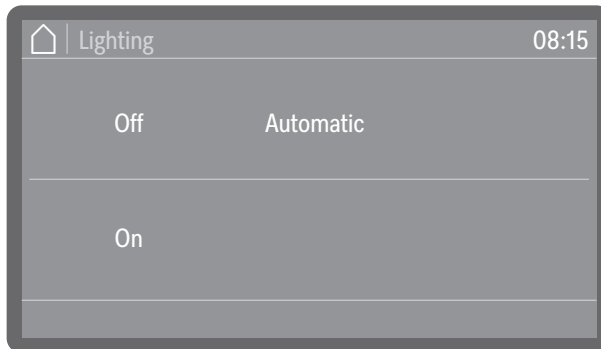

- Off
The chamber lighting is switched off permanently.
 - On
During a program, the chamber lighting remains permanently switched on.
 - Automatic
When the door is opened, the chamber lighting switches on and remains switched on for some time after the door is closed. During a program sequence, the lighting is switched off and is only reactivated at the end of the program or in the event of a fault.
- Select an option.

Logging process data

Reprocessing procedures are documented per cycle. Required and actual values are always recorded.

During the program cycles, the following data is logged, among other things:

- Machine model and serial number
- Date
- Program
- Start time
- Cycle number
- Wash blocks
- Dispensing hose with dispensing temperature and target dispensing amount if necessary
- Setpoints for temperature and activation time
- Minimum and maximum temperatures during the activation time
- Wash pressure measuring results
- Fault messages
- End of the program time
- System messages, e.g., refill salt

Memory

Up to 20 batch protocols are stored in an internal power failure safe memory within the machine. In the event of network or printer problems, for example, these can be subsequently recalled. If the memory is full, the oldest protocol is overwritten.

In addition, raw data from the last program cycle is stored to create a graphical display of the process data. This data can be converted into graphical representations using external apps or other documentation software systems. It is not possible to create graphical representations on the display or on a directly connected printer. Power-failure-safe storage of graphical information is not available.

Adding cycle numbers

Miele Service can add subsequent cycle numbers, e.g., in the event of software updates or if the machine controls are replaced.

Communication modules

The machine is equipped with an integrated Wi-Fi module. In addition, the machine has a module slot on the back of the machine, which can be equipped with a Miele XKM communication module to set up wired interfaces.

The interface can be used to permanently archive batch protocols using documentation software, apps, or a report printer. In addition, further digital offers are available if you are connected to the Miele cloud.

Please contact Miele for further information on software, the Miele cloud and suitable printers.

Only use terminal devices (PC, printers, etc.) compliant with IEC/EN 62368.

Depending on the equipment variant, the machine is either equipped with a communication module at the factory or a module can be retrofitted at any time. The communication modules are available from Miele as an accessory. The modules have their own instructions.

Only specialists are permitted to configure the interface; see ▶  Extended settings ▶ Networking ▶ Wi-Fi / LAN.

Maintenance

The machine should be serviced **every 1000 hours of operation, or at least once every 12 months**, by Miele Service or a suitably qualified specialist.

Maintenance covers the following points and functional checks:

- replacement of wear parts
- electrical safety check compliant with national rules and regulations (e.g., IEC 60364-4-41 or the local regulations)
- door mechanism and door seal
- any screw connections and connectors inside the wash cabinet
- water inlet and drainage
- Internal dispensing hoses
- spray arms
- filter combination
- sump including drain pump and non-return valve
- all mobile units, baskets, modules, and inserts
- Steam condenser
- wash mechanism/wash pressure
- Drying unit
- visual inspection and functional check of components
- a thermo-electric check (optional on request)
- leak test on seals
- safety testing of all relevant measuring systems
- safety features

Optionally available (equipment variant from the factory):

- Conductivity meter

External documentation software and computer networks are not tested by Miele Service.

Routine checks

Before the start of each working day, the supervisor must conduct a series of routine checks.

The following items must be checked:

- Filters in wash cabinet
- Machine spray arms and spray arms of load carriers
- Wash cabinet and door seal
- Dispensing hoses
- Load carriers, e.g., baskets, modules, and inserts, as well as any irrigation connectors that may be present

Maintenance measures

Cleaning the filters in the wash cabinet

⚠ Risk of damage due to blocked waterways.
If the filters are not inserted, dirt particles will end up in the machine water circuit. The dirt particles may block the nozzles and valves.
Only start a program if the filters are inserted.
Check that the filters are positioned correctly when you reinsert them after cleaning.

The filters in the floor of the wash cabinet prevent coarse soiling from coming into contact with the circulation system. Filters can become blocked by soiling, so they need to be checked every day and cleaned as necessary.

It is possible to set a cleaning interval for the filters in the wash cabinet in the controls; see ⚙ Extended settings ▶ Filter maintenance.
The cleaning interval is not a substitute for the daily routine check of the filters in the wash cabinet!

Removing and cleaning filters

⚠ Danger of injury from sharp and pointed objects.
There is a danger of injury from sharp or pointed objects (e.g., glass shards or needles) retained in the filters. Small glass shards in particular are not always immediately visible in the filter.
Therefore, take extra care when removing and cleaning the filters.

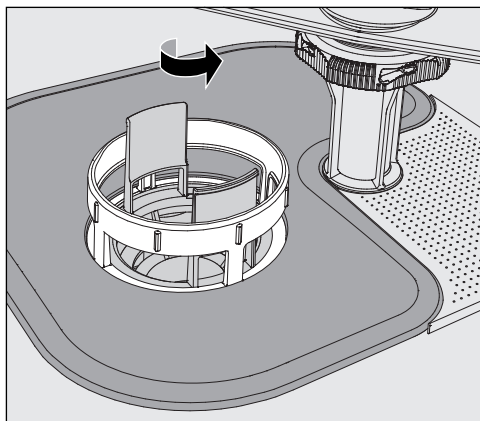

- Loosen the microfine filter by turning it in the direction of the arrow and remove it together with the coarse filter.

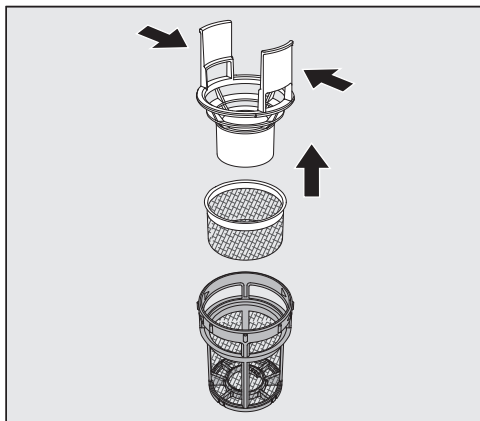

- Press the catches towards each other and pull the coarse filter upward to remove it.

- Remove the fine filter which sits loosely between the coarse filter and the microfine filter.

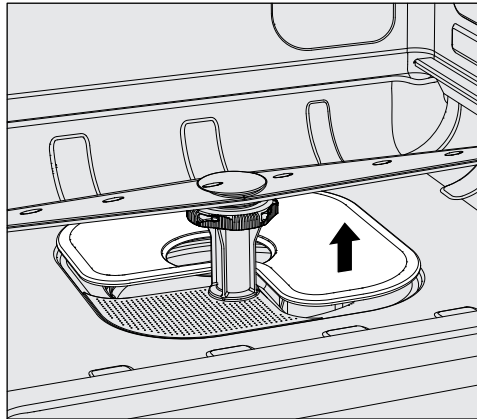

- Remove the flat filter last.
- Clean the filters.
- Re-insert the filter combination in the reverse order.
 - The flat filter must lie flat in the base of the wash cabinet.
 - The coarse filter must securely click into place in the microfine filter.
 - The microfine filter is screwed in tight as far as it will go.

Checking and cleaning the spray arms

The spray arm nozzles can become blocked, especially if the filters are not inserted correctly in the wash cabinet. This can cause coarse particles of soiling to get into the wash water circulation.

The spray arms must be visually checked daily for any soiling.

- To do this, remove the mobile unit or the baskets.
- Visually check the spray arms for soiling and blocked nozzles.
- Also check that the spray arms can turn easily.

**⚠ Immobile or blocked spray arms must not be used again.
In this case, contact Miele Service.**

Cleaning the spray arms

To clean the machine, the spray arms of the machine, mobile units, and baskets must be dismantled as follows:

- Remove the mobile unit or the baskets from the machine.

The upper machine spray arm is attached with a plug connection.

- Pull the upper machine spray arm downward.

The lower machine spray arm and the spray arms of the load carriers are fastened with bayonet catches.

Maintenance measures

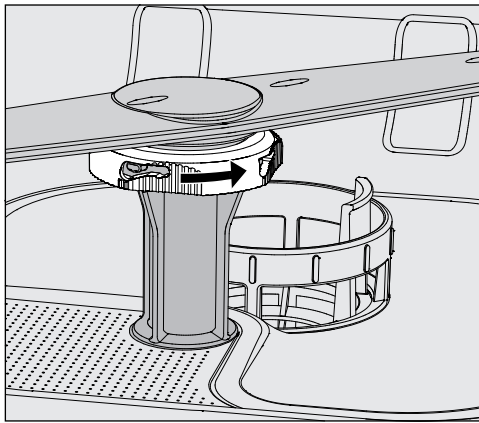

- Loosen the knurled bayonet catches by turning them as far as they will go in the direction of the arrow.
- You can then pull the spray arms up or down.

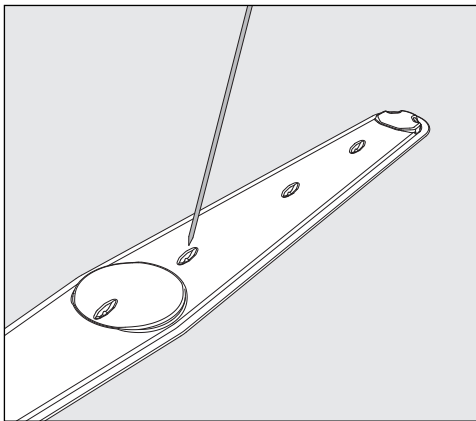

- Use a pointed object to push particles into the spray arm.
- Rinse the spray arm thoroughly under running water.

⚠ Do not allow any magnetic objects or wash items to attach to the magnets on the spray arms.
Any metallic objects on the magnets can cause a false reading of spray-arm rotation.
Remove all metal objects from the magnets.

- Check the spray arm bearings for visible signs of wear.

Visible wear on the bearings can adversely affect the long-term functioning of the spray arms.
In this case, contact Miele Service.

- Replace the spray arms after cleaning.
- Make sure the spray arms can rotate easily after they have been installed.

The spray arms of the load carriers are each labeled with a number that is also embossed on the water inlet pipes in the bayonet catch area, e.g., 03. When installing, make sure that the numbers on the spray arms match the numbers on the water inlet pipes.

Cleaning the machine

⚠ Never clean the machine with a water hose or a pressure washer.

⚠ Do not use cleaning agents containing ammonia or thinners on stainless steel surfaces!

These agents can damage the surface material.

For surface disinfection, use a cleaning agent recommended and listed by the manufacturer, e.g., an alcohol-based agent with a maximum alcohol content of 70%.

Cleaning the control panel

⚠ Do not use any abrasive materials or all-purpose cleaners to clean the control panel.

Due to their chemical composition, these can cause considerable damage to the glass and plastic surfaces and to the onset control buttons.

- Clean the control panel with a damp all-purpose cloth and liquid dish soap or with a non-abrasive stainless steel cleaner.
- You can also use commercially available glass or plastic cleaners to clean the display and the plastic underside.

Cleaning the door and the door seal

- Wipe the door seals regularly with a damp cloth to remove any soiling and stains.
Seals which are no longer tight or which have suffered damage must be replaced with new ones by Miele Service.
- Remove any soiling from the door sides and hinges.
- Regularly clean the groove in the base panel under the door with a damp cloth.

Cleaning the wash cabinet

The wash cabinet is generally self-cleaning. However, should a build-up of deposits occur in the cabinet, please contact Miele Service for advice.

Cleaning the machine front

- Clean the stainless steel surface with a damp cleaning cloth and liquid dish soap or a non-abrasive stainless steel cleaning agent.

Preventing re-soiling

- To help prevent re-soiling of stainless steel surfaces (fingerprints, etc.), a suitable stainless steel care product can be used after cleaning.

Maintenance measures

Checking the load carriers

Load carriers must be checked daily to make sure they are functioning correctly.

The following points need to be checked:

- If the load carriers have rollers, are the rollers in good condition, and are they securely attached to the load carrier?
- Are the water connectors present and undamaged?
- Are height-adjustable water connectors adjusted to the correct height and securely fixed?
- Are all nozzles, irrigation sleeves, and hose adapters securely attached to the load carrier?
- Are all injector nozzles, irrigation sleeves, and hose adapters clear so that wash water can flow through unhindered?
- Are all caps and fasteners securely attached to the irrigation sleeves?
- Are end caps present and securely located for all modules and injector manifolds?
- Are the caps in the water connectors of load carriers in the modular system working properly?

Where applicable:

- Do the spray arms rotate freely?
- Are the spray arm nozzles free of any blockages? See  “Cleaning the spray arms”.
- Do the magnets integrated into the spray arms have any metallic objects sticking to them?

Filter change

The air filters for the machine's internal drying unit have a limited service life. For this reason, the filters must be replaced regularly.

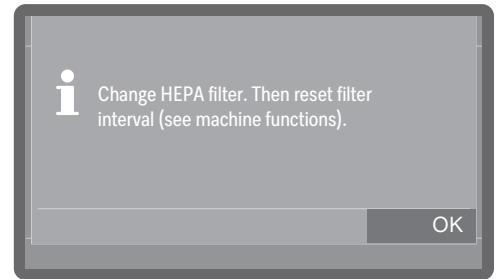
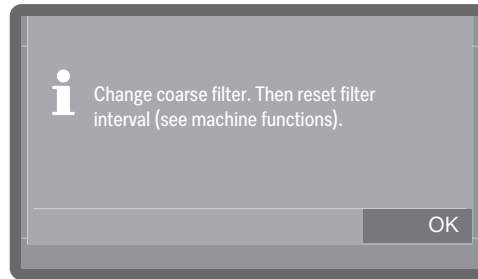

- Confirm the message by pressing OK.
- Open the drawer of the side unit.

Replacing the coarse filter

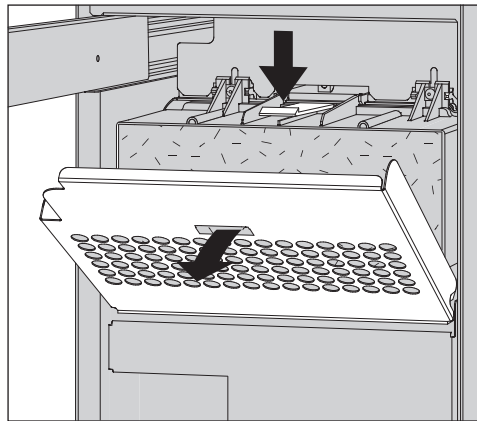

- Loosen the filter grille and fold it downward. Alternatively, you can also remove the grille.

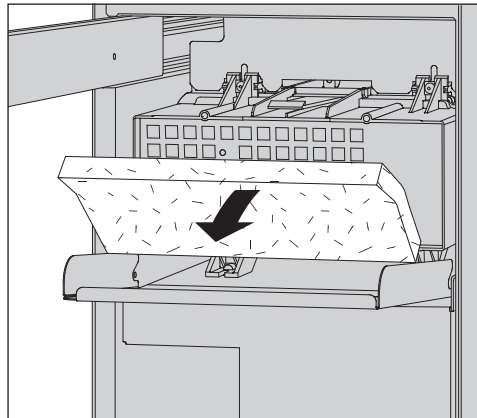

- Replace the coarse filter. The soft filter side must face forward.
- Reinsert the filter grille and close the drawer in the side unit.

Whenever the filter is replaced, the operating hours counter must be reset. To do this, select the filter at ▶  Machine functions ▶ Filter interval and reset the counter using the Reset interval option.

Maintenance measures

Replacing the HEPA filter

If possible, the HEPA filter should be replaced during maintenance by Miele Service. If you need to change the filter yourself, proceed as follows:

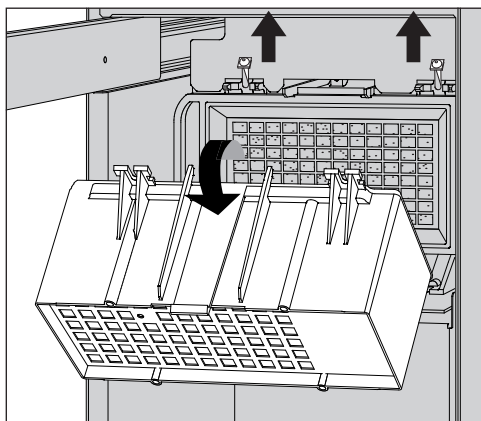

- Open the drawer in the side unit and remove the filter grille and the coarse filter; see  “Replacing the coarse filter”.

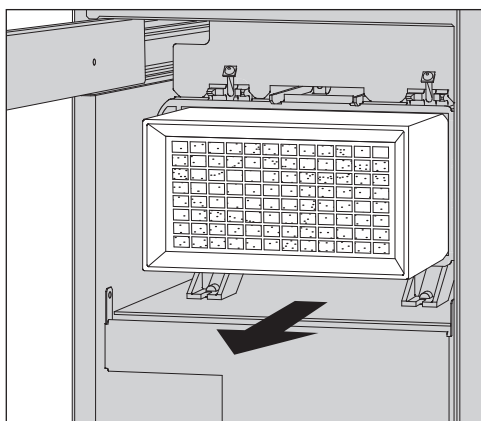

- Detach the coarse filter housing by unscrewing the retaining screws and pushing them upward.
- Remove the coarse filter housing.



- Remove the HEPA filter from its holder and insert a new one.
- Reinsert the coarse filter housing and tighten the retaining screws.
- Reinsert the coarse filter and the filter grille and close the drawer in the side unit.

Whenever the filter is replaced, the operating hours counter must be reset. To do this, select the filter at  Machine functions  Filter interval and reset the counter using the Reset interval option.

Process validation

Processing performance can be regularly confirmed by the user if required.

Test point for measuring sensors

The sensor test point for validation is located at the front right on the top of the machine, covered by the lid or the countertop. To reach the access point, the lid of the machine must be removed or the machine must be pulled out from under the countertop.

- Open the door.

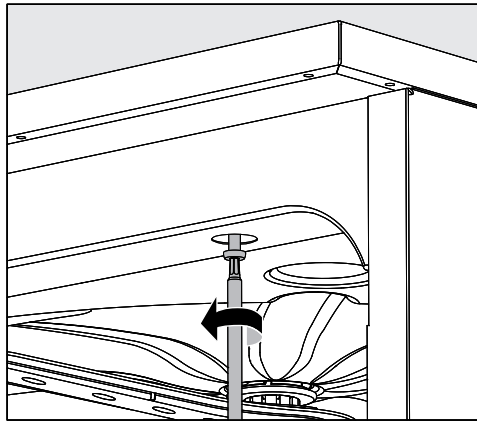

- Remove the protective caps and unscrew the fixing screws.
- Then remove the locking screws on the back of the machine from the **lid** and lift the **lid** to remove it.

Or

- Pull the machine out by approx. 15 cm from under the **countertop** until the sensor test point on the top is freely accessible.

Test programs

Various programs are available for monitoring the cleaning performance in the course of routine checks. The test programs are not separate reprocessing programs. Rather, they are additional functions that can be activated prior to starting any reprocessing program.

The test programs interrupt the program cycle automatically at specified points. The interruption is indicated by an audible signal tone and message on the display. Miele Service can set the duration of the interruption to between 10 seconds and approx. 42 minutes. During this time period, measurements can be made or the door can be opened to obtain a sample.

To prevent cooling of the wash cabinet, do not keep the door open too long.

The program cycle continues automatically after the time has elapsed. If the door has been opened, the program cannot start resume until the door has been closed again.

If a measurement or sample is not needed, you can resume the program sooner by pressing the *Start/Stop* button.

In addition, the door can be opened at any time during the drying phase to check the dryness of the wash load. In this way, you can determine the optimal drying time.

Maintenance measures

The following test programs can be selected:

- Laboratory

The program cycle is stopped in each wash block immediately before the wash water is drained away.

- Validation

The program cycle is interrupted at the following points:

- Before the wash water is drained away in the final wash block.
- After the interim rinse before the wash water is drained away.
- After water intake and before draining in the final rinse block.

Activating the test program

Test programs are only valid for one program cycle. To carry further tests, a test program must be selected again beforehand in each time.

The menu is saved under the following input path.

⚙️ Extended settings

Program options

Test program

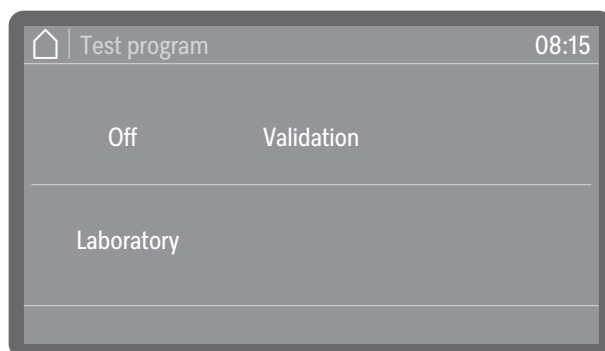

- Off

The menu is closed without a program being selected.

- Laboratory

Activates the Laboratory test program.

- Validation

Activates the Validation test program.

■ Select an option.

You can now start the performance test.

■ To do this, select a program from the program list and start it.

During the program sequence, the information Test program is shown on the display.

If you want to deactivate the test program again before the performance test, you have to call up the menu again and select the Off option.



If you interrupt or cancel the running program during a performance test before an automatic measuring point has been reached, the test program is deactivated immediately.

The following guide should help you to find the reason for a fault and to correct it. However, please note the following:

 Danger due to unauthorized repairs.
Unauthorized repairs can expose the user to considerable risk.
Repairs may only be carried out by Miele Service or a suitably qualified specialist.

To avoid unnecessary service visits, check that the fault has not been caused by incorrect operation when a fault message first appears.

Technical faults and messages

Problem	Possible cause and solution
The display is dark and all backlit buttons are out.	The machine is not switched on. ■ Switch the machine on using the  On/Off switch.
	A breaker is faulty or has tripped. ■ Refer to the minimum breaker rating on the data plate. ■ Reset the breaker switch. ■ If the breaker trips again, call Miele Service.
	The machine is not plugged in. ■ Insert the electrical plug.
The machine has switched itself off.	This is not a fault. The Standby/Off function switches the machine off automatically after a preset waiting time to save energy. ■ Switch the machine on using the  .
The display is dark and the <i>Start/Stop</i> button is pulsing.	This is not a fault. The machine is ready for use. ■ Press the <i>Start/Stop</i> button to reactivate the machine.
Power outage during operation	If a temporary power outage occurs during a program sequence, the program is canceled.
A program has ended, but the machine has not rinsed.	This is not a fault. The Demo mode for simulating processes and program sequences on the display is activated. ■ Deactivate Demo mode; see ► Demo Mode.

Maintenance and testing

Problem	Possible cause and solution
Next service due on: or in hours	This is not a fault. Miele Service has recommended a date for the next service visit. ■ Arrange an appointment with Miele Service or have the maintenance carried out by a suitably qualified specialist.
Next qualification due on: or in hours	This is not a fault. Miele Service has recommended a date for the next qualification. ■ Arrange an appointment with Miele Service or have the qualification carried out by a suitably qualified specialist.

Troubleshooting

Problem	Possible cause and solution
Next electrical safety test due on: or in hours	<p>This is not a fault. Miele Service has provided a recommended date for the next electrical safety test.</p> <ul style="list-style-type: none"> ■ Arrange an appointment with Miele Service or have the electrical safety test carried out by a suitably qualified specialist.

Dispensing/dispensing systems

⚠ Caution when handling process chemicals!
For all process chemicals, the process chemical manufacturer's safety instructions as given on their safety data sheets must be observed.





Problem	Possible cause and solution
Change canister	<p>During a program sequence, a low fill level was measured in a canister for liquid process chemicals.</p> <ul style="list-style-type: none"> ■ Replace the empty canister with a full one.
Fill dispensing paths	<p>This is not a fault. A dispensing hose is currently being filled automatically Wait until the process is complete.</p>
Fill dispensing paths cancelled	<p>Filling of the dispensing hose was canceled because an insufficient flow rate was identified. A dispensing hose may be kinked or the suction lance blocked.</p> <ul style="list-style-type: none"> ■ Check the dispensing hose for kinks and leaks. Position it so that it cannot become kinked. ■ Check the suction opening of the suction lance for blockages and remove them as necessary. ■ Start the process again. <hr/> <p>Contact Miele Service if there are leaks in the dispensing hose or a fault with the suction lance.</p>

Highly viscous (thick) process chemicals can affect the dispensing monitoring and lead to inaccurate data. In this instance, please contact Miele Service for advice.

Insufficient salt/water softener

Problem	Possible cause and solution
Refill salt - appliance will be locked shortly.	The salt supply in the water softener has been used up. Re-activation is no longer possible. The machine will be locked for further use with the next reactivation. <ul style="list-style-type: none"> ■ Refill with reactivation salt.
F561 Machine locked insufficient salt: Refill regeneration salt. Machine will unlock after a few seconds. Then start the "Cold water rinse" program.	The water softener cannot reactivate because there is insufficient salt. The machine is locked for further use. <ul style="list-style-type: none"> ■ Refill with reactivation salt. <p>The machine is unlocked a short while after the salt container has been refilled. Reactivation will occur automatically during the next program sequence.</p>
Close salt container lid	The salt container is not closed properly. Salt residues are preventing it from closing. <ul style="list-style-type: none"> ■ Remove all salt residues from the edge of the salt refilling opening, the lid, and the seal. Do not use running water to rinse away salt residues as this can cause the container to overflow. ■ Close the container properly.
	Machine with steel door: The salt container flap has sprung open during a program. <div style="border: 1px solid black; padding: 5px; margin: 5px 0;"> <p> When the door is opened, hot steam, and process chemicals can escape!</p> </div> <ul style="list-style-type: none"> ■ Open the door and close the container flap.

Filters



Problem	Possible cause and solution
Clean filter combination. Then reset filter interval (see machine functions).	The filter combination needs cleaning. <ul style="list-style-type: none"> ■ Remove the filter combination and clean it; see  "Cleaning the filters in the wash cabinet". ■ After cleaning, reset the maintenance interval for the filter combination; see ▶  Machine functions ▶ Filter interval ▶ Filter combination ▶ Reset interval.
Change coarse filter. Then reset filter interval (see machine functions).	The maximum permissible operating hours for the coarse filter have been reached. <ul style="list-style-type: none"> ■ Replace the coarse filter with a new one. ■ Then reset the operating hours counter for the coarse filter; see ▶  Machine functions ▶ Filter interval ▶ Coarse filter ▶ Reset interval.
Change HEPA filter. Then reset filter interval (see machine functions).	The maximum permissible operating hours for the HEPA filter have been reached. <ul style="list-style-type: none"> ■ Replace the HEPA filter with a new one. ■ Then reset the operating hours counter for the HEPA filter; see ▶  Machine functions ▶ Filter interval ▶ HEPA filter ▶ Reset interval.

Troubleshooting

Cancel with fault code

If a program is canceled and a fault code appears, e.g., Fxxx (where xxx represents a number), there could be a serious technical fault.

In the event of a program being canceled and a fault code being shown:



- Follow the instructions in the display.
- Switch the machine off using the  On/Off switch.
- Wait approximately 10 seconds before switching the machine on again with the  On/Off switch.
- Start the previously selected program again.

If the same fault message appears again:



- Make a note of the fault message.
- Switch the machine off using the  On/Off switch.
- Contact Miele Service.

Please also read the notes regarding the following fault codes.

Problem	Possible cause and solution
F427, F428, F527, F528, F635, F636 Conductivity	The measured conductivity does not meet the requirements. Possible causes: – Carry-over of conductive substances during the reprocessing procedure ■ Check the reprocessing procedure. – Empty or faulty water softener or demineralization systems ■ Check external water softener or demineralization systems. ■ If necessary, reactivate the systems. – Work on the on-site water supply ■ Contact a qualified plumber. – Swapped water connections ■ Observe the markings on the water connections (see  “Connecting the water inlet”).
F433, F438 Door blockage	Objects in the closing area of the door or outside in front of the door prevent the door from being opened or closed automatically. ■ Remove all objects in front of the door of the machine, e.g., mobile units or boxes. ■ Open the door and remove all objects that protrude into the closing area of the door. For example, sort the wash items so that they do not protrude into the door area and remove all objects that protrude into the door area from the outside, e.g., hanging all-purpose cloths. ■ Switch the machine off and then back on again.
F434, F444, F446 Door lock	Slamming the door can result in problems with the comfort door lock. ■ Open and close the door.

Problem	Possible cause and solution
<p>F460, F461, F462 Spray arm blockage</p>	<p>The set spin speed has not been reached.</p> <ul style="list-style-type: none"> – Wash items are blocking the spray arm ■ Arrange the wash items so that the spray arms can turn easily and start the program again. <hr/> <ul style="list-style-type: none"> – The spray arm is clogged ■ Clean the spray arm. ■ Check whether the filters in the wash cabinet are clean and correctly inserted. ■ Restart the program. <hr/> <ul style="list-style-type: none"> – Wash pressure is too low due to a heavy build-up of foam ■ Follow the instructions regarding foam build-up; see  “Chemical processes and technology”. ■ Start the Cold water rinse program to clean the wash cabinet. ■ Then reprocess the wash items again.
<p>F511, F512, F513 Dispenser pump</p>	<p>Technical defect in one of the dispenser pumps.</p> <ul style="list-style-type: none"> ■ Contact Miele Service.
<p>F518, F519, F520 Dispensing hose</p>	<p>Fault detected in the dispensing hose.</p> <div style="border: 1px solid gray; padding: 5px; margin: 5px 0;"> <p> Exercise caution when handling process chemicals. For all process chemicals, the manufacturer’s safety notes as given on their safety data sheets must be observed.</p> </div> <ul style="list-style-type: none"> ■ Check the fill levels of the canisters and replace empty ones with full ones. ■ Check the suction apertures of the suction lances and remove any deposits. ■ Check the connections between the dispensing hoses and the suction lances, the machine, etc. ■ Remove any kinks from the dispensing hoses and check the hoses for leaks. Position the dispensing hoses so that they cannot kink. ■ Vent the dispensing hoses. <hr/> <p>If you identify any leaks in the dispensing hoses or defects on the suction lances, contact Miele Service.</p>

Door

Problem	Possible cause and solution
<p>Hot wash cabinet: Risk of injury, take care when opening the door.</p>	<p>When the  door button is pressed, the temperature in the wash cabinet is over 60°C.</p> <div style="border: 1px solid gray; padding: 5px; margin: 5px 0;"> <p> When the door is opened, hot steam, and process chemicals can escape!</p> </div> <ul style="list-style-type: none"> ■ Open the door only when strictly necessary.

Troubleshooting

Problem	Possible cause and solution
Anti-trap guard: To continue, open the door.	The door was closed before the door lock catch was fully retracted. <ul style="list-style-type: none"> ■ Open the door. ■ The door lock catch must be fully retracted before you close the door again.
Emergency release: To continue, open the door.	The door was opened using the emergency release. <ul style="list-style-type: none"> ■ Follow the instructions for emergency release; see  "Opening the door using the emergency release".



Unsatisfactory cleaning and corrosion

Problem	Possible cause and solution
There are white deposits on the wash load.	The water softener is set too low. <ul style="list-style-type: none"> ■ Set the water softener to the correct water hardness.
	There is no salt in the salt reservoir. <ul style="list-style-type: none"> ■ Refill with reactivation salt.
	The quality of the water for the final rinse was insufficient. <ul style="list-style-type: none"> ■ Use water with a low conductivity value ■ If the machine is connected to a water softening cartridge, check it and replace as necessary.
	The water from the DI water connection is not sufficiently demineralized. <ul style="list-style-type: none"> ■ Check the external demineralization system. If necessary, replace the demineralization cartridge with a new one.
The wash items are flecked.	The rinse aid container is empty. <ul style="list-style-type: none"> ■ Refill the container.
	The rinse aid concentration is set too low. <ul style="list-style-type: none"> ■ Contact Miele Service and have the dispensing concentration reset.
The cleaning results are unsatisfactory.	Load carriers were not suitable for the wash items. <ul style="list-style-type: none"> ■ Select load carriers which are suitable for the task.
	The load carriers were loaded incorrectly or overloaded. <ul style="list-style-type: none"> ■ Arrange the wash items correctly according to the information in the operating instructions. ■ Avoid overloading the load carriers.
	The reprocessing program was not suitable for the soiling. <ul style="list-style-type: none"> ■ Select a suitable program. <p>Or</p> <ul style="list-style-type: none"> ■ Adjust the program parameters to suit the task.
	Soiling has been left to dry on the wash items for too long. <ul style="list-style-type: none"> ■ Soiling should not be left on the wash items for more than 6 hours before machine reprocessing.
	A spray arm is blocked.

Problem	Possible cause and solution
	<p>■ Ensure the spray arms are not obstructed when arranging the wash items.</p> <p>The nozzles of the spray arms are clogged. ■ Check the nozzles and clean them as necessary.</p> <p>The filters in the wash cabinet are soiled or not inserted correctly. ■ Check the filters and clean them if necessary.</p> <p>Load carriers were not correctly mounted on the water connection. ■ Check the adapter.</p>
Items made of glass are showing signs of corrosion.	<p>The items are not suitable for machine reprocessing. ■ Only use items which are declared by their manufacturer as suitable for machine reprocessing.</p> <p>Neutralization has not taken place during the program. ■ Check the level in the reservoir and vent the dispensing system if necessary.</p> <p>The wash temperature was too high. ■ Select a different program. or ■ Reduce the wash temperature.</p> <p>The process chemicals used were too alkaline. ■ Use a milder process chemical. or ■ Reduce the concentration of process chemicals.</p>
Stainless steel items are showing signs of corrosion.	<p>The stainless steel is of insufficient quality for machine reprocessing. ■ Only use stainless steel items made of high quality stainless steel and follow the instructions of the manufacturer regarding machine reprocessing.</p> <p>The chloride content in the water is too high. ■ Have a water analysis check carried out. Connection to an external water processing unit and the use of demineralized water may be necessary.</p> <p>Neutralization has not taken place during the program. ■ Check the level in the supply container and vent the dispensing system if necessary.</p> <p>Rust or superficial rust has built up in the wash cabinet, e.g. due to an excessively high iron content in the water or rust on other wash load items. ■ Check the installation. ■ Discard any rusty items.</p>

Troubleshooting

Spray arm monitoring/conductivity/wash pressure

Problem	Possible cause and solution
Upper spray arm: Blockage detected or Middle spray arm: Blockage detected or Lower spray arm: Blockage detected	<p>The set spin speed has not been reached.</p> <ul style="list-style-type: none"> – Wash items are blocking the spray arm ■ Arrange the wash items so that the spray arms can turn easily and start the program again. <hr/> <p>– The spray arm is clogged</p> <ul style="list-style-type: none"> ■ Clean the spray arm. ■ Check whether the filters in the wash cabinet are clean and correctly inserted. ■ Restart the program. <hr/> <p>– Wash pressure is too low due to a heavy build-up of foam</p> <ul style="list-style-type: none"> ■ Follow the instructions regarding foam build-up; see  “Chemical processes and technology”. ■ Start the Cold water rinse program to clean the wash cabinet. ■ Then reprocess the wash items again.
Conductivity block repetition:	<p>This is not a fault. The measured conductivity in the running wash block was too high. The wash block is repeated. Possible causes:</p> <ul style="list-style-type: none"> – Carry-over of conductive substances during the reprocessing procedure ■ Check the reprocessing procedure. <hr/> <p>– Empty or faulty water softener or demineralization systems</p> <ul style="list-style-type: none"> ■ Check external water softener or demineralization systems. ■ If necessary, reactivate the systems. <hr/> <p>– Work on the on-site water supply</p> <ul style="list-style-type: none"> ■ Contact a qualified plumber. <hr/> <p>– Swapped water connections</p> <ul style="list-style-type: none"> ■ Observe the markings on the water connections (see  “Connecting the water inlet”).

Noises

Problem	Possible cause and solution
There is a knocking noise in the wash cabinet.	<p>One or more spray arms are knocking against the wash load.</p> <ul style="list-style-type: none"> ■ Cancel the program. To do this, follow the instructions in “Canceling a program.” ■ Arrange the wash load so it cannot obstruct the spray arms. ■ Make sure the spray arms are not obstructed. ■ Start the program again.
There is a rattling noise in the wash cabinet.	<p>Items are not properly secured in the wash cabinet.</p> <ul style="list-style-type: none"> ■ Cancel the program. To do this, follow the instructions in “Canceling a program.” ■ Rearrange the load so that items are secure. ■ Start the program again.
Knocking noises in the water line.	<p>This may be caused by the on-site installation or the cross-section of the water line being too small. This does not affect the function of the machine.</p> <ul style="list-style-type: none"> ■ Contact a qualified plumber.

Frequently asked questions

Cleaning the drain pump and non-return valve

If water was not pumped away at the end of a program, there may be a foreign object in the drain pump or blocking the non-return valve.

- Remove the filter combination from the wash cabinet; see  “Cleaning the filters in the wash cabinet”.

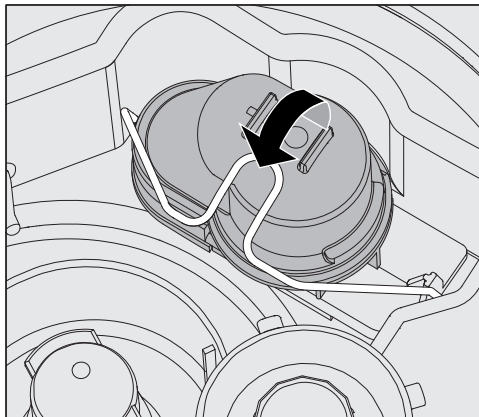

- Open the locking clamp.
- Lift out the non-return valve and rinse well under running water.
- Make sure that the vent on the outside of the non-return valve is not blocked (this vent is only visible after the non-return valve has been taken out). If it is blocked, use a pointed object to release the blockage.

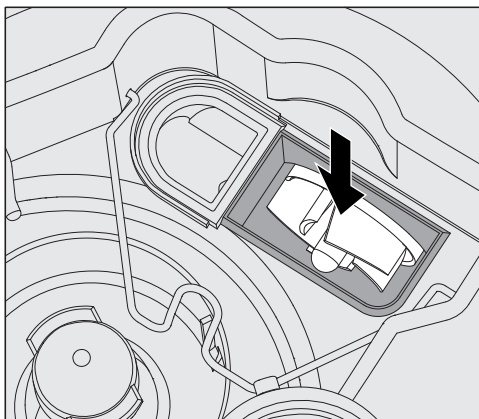

The drain pump impeller is situated under the non-return valve.

- Check the impeller for foreign objects and remove them if necessary before reinstalling the non-return valve.
- Carefully replace the non-return valve and secure it with the locking clamp.

Cleaning the filters in the water inlet

Filters are incorporated into the water inlet connection on the hose to protect the water inlet valve. If these filters get dirty they must be cleaned as otherwise too little water will flow into the wash cabinet.

⚠ The plastic housing on the water inlet valve contains an electrical component. It must not be dipped in water.

To clean the filter

- Disconnect the machine from the power supply (switch the machine off, unplug the electrical plug, or disconnect or disable the breaker).
- Close the faucet.
- Unscrew the water intake valve.

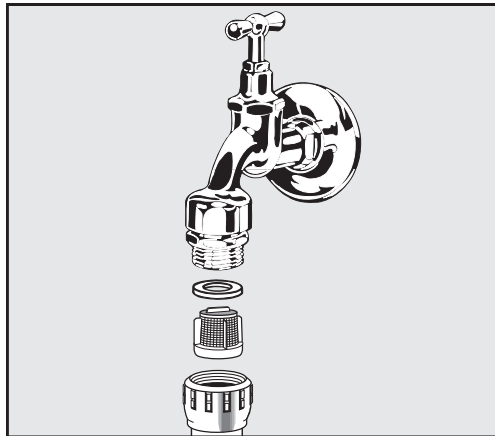

- Take the seal ring out of the screw connection.
- Pull the filter out using combination or needle-nose pliers.
- Clean the filter or replace it if necessary.
- Replace the filter and seal, making sure they are sitting correctly.
- Screw the water intake valve onto the faucet. Ensure that the screw thread goes on straight and not cross-threaded.
- Open the faucet. If water leaks out, the screw connection may not be connected securely or it may have been screwed on at an angle. Unscrew and reconnect the water intake valve correctly.

Retrofitting the large-surface filter

If the water contains a high level of insoluble components, a large-surface filter can be installed between the faucet and the water inlet hose.

The large-surface filter is available from Miele Service.

Contacting Miele Service

 Repairs should only be carried out by Miele Service or an authorized technician.
Unauthorized repairs can expose the user to considerable risk.

To avoid unnecessary customer service visits, you should check whether this fault can be remedied yourself using the instructions in  “Frequently asked questions” the first time a fault message occurs.

If, having followed the advice in the operating instructions, you are still unable to resolve a fault, contact Miele Service.

The contact details can be found on the back of these  operating instructions or on the Miele homepage, e.g., at www.miele.com/professional.

If possible, please have the following information ready when contacting us:

- model and serial number of the machine

This information can be found on the data plate. The position of the data plates is described in the machine overview or can be called up via the display at ▶  Extended settings ▶ Data plate.

- the fault message and the fault number from the display
- the software versions of the machine components

This information can be found on the display at ▶  Extended settings ▶ Software version.

Setup and alignment

Further information can be found in the installation plan. The installation plan is available online.

 Unauthorized access poses a risk.

Settings in the machine, e.g., parameters for dispensing process chemicals, may be changed as a result of unauthorized access via the machine display.

Set up the machine in a room with restricted access. Only give the PIN code to people you trust.

 Risk of injury from metal parts.

Some metal parts pose a risk of injury/being cut.

Wear cut-resistant protective gloves when transporting and setting up the machine.

 Risk of injury when lifting the machine.

Due to their heavy weight, the machines must not be lifted by a single person.

If possible, always have 2 or more people lift the machines. Follow the instructions on occupational safety, e.g., ensure an ergonomic posture when lifting.

Use suitable aids such as pallet trucks or hand trucks for longer transport distances.

 Material damage during transport with pallet trucks, hand trucks, or other transport aids.

Pallet trucks, hand trucks, or other transport aids can dent components in the base of the machine and damage them.

When transporting the machine using pallet truck, hand truck, or other transport aids, the machine must be in its original packaging or placed on a stable, continuous support.

When transporting the machine using a hand truck, do not lift it from the front as this could damage the control panel or the door.

 Material damage during transport or installation.

Do not lift, pull, or push the machine by protruding parts, such as the control panel, the open door, drawers (if present), components on the back of the machine, hoses, or cables, as these could be damaged or torn off.

To lift, pull, or push the machine, hold it by the housing if possible.

Installation

Installation variants

The machine is suitable for the following installation variants:

- Freestanding.
- Slot-in:

The machine should be placed next to other machines, furniture, or in a niche. The niche must be at least 35 7/16" (900 mm) wide and 23 5/8" (598 mm) deep.

- Built-under:

The machine should be placed under a continuous countertop or sink drain. The installation space must be at least 35 7/16" (900 mm) wide, 23 5/8" (598 mm) deep, and 32 5/16" (820 mm) high.

Freestanding machines or machines positioned in a niche must be equipped with machine lids.

Lids with a depth of 23 5/8" (603 mm) or with a depth of 27 1/2" (700 mm) with additional side wall extension are available from Miele.

Leveling out uneven floors

The machine must be stable and horizontal.

Any unevenness in the floor level can be compensated for by adjusting the 2 front adjustable feet. The feet can be adjusted by up to 5/16" (8 mm).

With the feet screwed in, the machine can be rolled forward or backward on rollers mounted underneath. To do this, the front of the machine must be raised slightly.

Hose holder

The supplied hose holders can be used to lay the power cord and the hoses for supply and waste water in a way that saves space.

The hose holder prevents hoses from kinking or crushing when installing the machine in tight recesses.

The power cord and hoses can be laid either on the left or the right, depending on the connection situation.

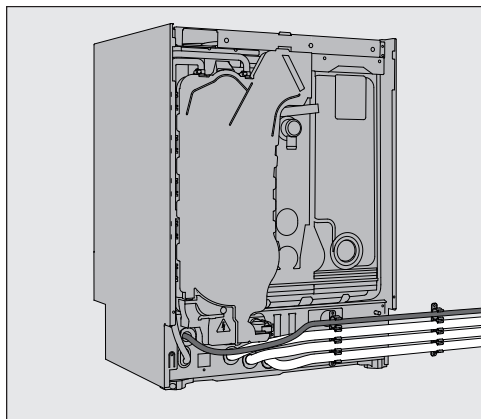

Lid

The lids must be screwed to the machine. The side with the screw threads on the underside belongs at the front; the side with the brackets for the locking screws protruding downward at the rear.

Installation instructions are included with lids that can be purchased separately.

- Place the lid on the machine. The lid must lie flush.
- Tighten the two securing screws on the back of the machine.
- Open the door.

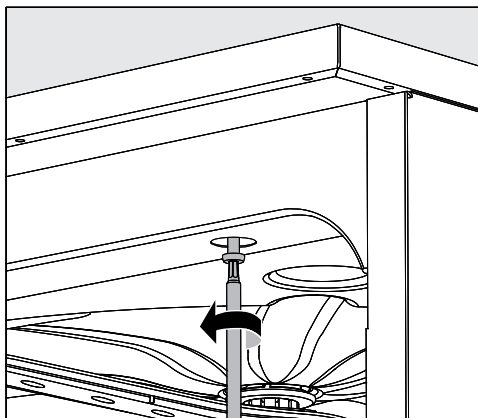

- Remove the cover caps on the left and right and tighten the retaining screws. Then reinstall the cover caps.

Installation

Built-under a continuous countertop

⚠ Damage caused by condensation.

When the machine is in operation, vapors escape which can condense on the cabinetry and fittings in the immediate vicinity.

In order to reduce the risk of water damage, the area around the machine should be limited to cabinetry and fittings that are designed for use in commercial environments.

Steam condenser

To avoid steam damage to the countertop, the protective foil supplied (self adhesive 10 x 23" / 25 x 58 cm) must be applied underneath the countertop in the area of the steam condenser.

Securing to the countertop

To improve stability, the machine must be secured to the countertop after it has been aligned.

- Open the door.

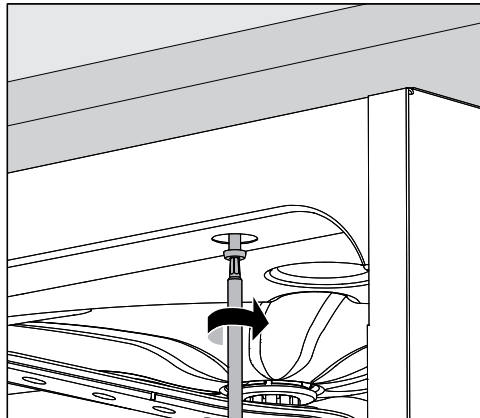

- Remove the cover caps on the left and right. Screw the machine to the continuous countertop through the holes in the front trim. Then reinstall the cover caps.

Please contact Miele Service to secure it at the sides to adjacent cabinetry.

Priming the circulation pump

⚠ The gaps between a built-in machine and adjacent cabinetry must not be sealed, e.g., with silicone sealant, as this could compromise the ventilation of the circulation pump.

Vapor barrier for countertops

The vapor barrier supplied protects the countertop from damage caused by steam when the door is opened. It must be positioned underneath the countertop above the machine door.

Electromagnetic compatibility (EMC)

The machine has been tested for electromagnetic compatibility (EMC) in accordance with EN 61236-1 class B and is suitable for operation in commercial environments, such as laboratories and other similar environments which are connected to the domestic power supply.

The machine's high frequency (HF) energy emissions are very low and are therefore unlikely to interfere with other electronic machines in the vicinity.

Flooring at the installation site must be wood, concrete, or tiled. Synthetic flooring must be able to withstand a relative humidity level of at least 30% to minimize the risk of electrostatic discharges.

The quality of the power supply should comply with that found in a typical commercial or hospital environment. Check that the power supply voltage is within a range of $\pm 10\%$ of its nominal value.

Electrical connection

⚠ All electrical connection work must be carried out by a qualified electrician in accordance with local and national safety regulations.

- The electrical installation must be carried out in accordance with IEC 60364-4-41 or the local regulations.
- The connection to the power supply must comply with national regulations. The power outlet must be accessible after the machine has been installed. An electrical safety test must be carried out after installation and after any maintenance work.
- If the machine is hard-wired to the power supply or connected via an outlet, a power switch capable of disconnecting the machine at all poles must be installed. This power switch must be designed to operate at the rated current, have a contact gap of at least 1/8" mm (3 mm), and also be lockable in the off position. The power switch must be accessible after the machine has been installed.
- If necessary, equipotential bonding must be carried out.
- The rated loads are specified on the data plate and in the circuit diagram.
- For added safety, the machine should be protected by a type A residual current device with a trip current of 30 mA. The installation of the residual current device must be carried out on site by the supervisor.
- The power supply cord may only be replaced by an original spare part from the manufacturer.

Further information on the electrical connection can be found in the installation plan. The installation plan is available online.

The machine must only be operated with the voltage, frequency, and fuse rating shown on the **data plate**.

This machine **can be converted to a different type of power supply** in accordance with the conversion diagram and circuit diagram.

The **data plates** are attached to the machine. The positions are described in the machine overview.

The **circuit diagram** is available online.

Additional equipotential bonding

There is a screw connection point marked \Downarrow at the back of the machine, to which additional equipotential bonding can be connected if required.

Connecting the water supply

 Water from the chamber is not suitable for drinking!

- The machine must be connected to the water supply in strict accordance with local regulations.
- The water used must at least comply with local and national codes for drinking water quality. If the water supply has a high iron content, there is a danger of corrosion occurring on wash items made of stainless steel and on the machine itself. If the chloride content of the water exceeds 100 mg/l, the risk of corrosion to wash items made of stainless steel in the machine will be further increased.
- In certain regions (e.g., mountainous areas), the water composition may cause precipitates to form, requiring the use of softened water in the steam condenser.
- The machine complies with the applicable standards for the protection of drinking water.
- The machine is equipped as standard for connection to cold water (blue marking) and hot water (red marking) up to max. 149°F (65°C). Connect the water inlet hoses to the supply valves for cold and hot water.
- If no hot water supply is available, the **red** coded inlet hose for the hot water connection must also be connected to the cold water supply.
- The steam condenser is supplied with water via the cold water connection.
- The **minimum flow pressure** for the cold water connection is 14.5 psi (100 kPa) pressure, for the hot water connection 5.8 psi (40 kPa) pressure, and for the DI water connection 4.4 psi (30 kPa) pressure.
- The **recommended water connection pressure** is ≥ 29 psi (200 kPa) for the cold and hot water connections and ≥ 29 psi (200 kPa) for the DI water connection in order to avoid excessively long water intake times.
- The **maximum permissible static water pressure** is 145 psi (1,000 kPa).
- If water pressure is not within the specified range, please contact Miele Service for advice.
- Shut-off valves with a $\frac{3}{4}$ inch male garden hose thread must be provided on site for the connection. The valves must be easily accessible to allow the water inlet to be turned off when not in use.
- The water inlet hoses are 5' 7" (1.7 m) long pressure hoses, DN 10, with $\frac{3}{4}$ inch female thread. The filters in the screw threads must not be removed.

Plumbing

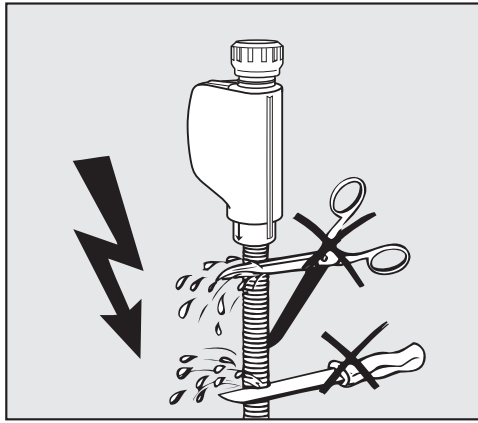

⚠ Risk of electric shock from voltage.

There are electrical components in the water inlet hoses.

Do not shorten or otherwise damage the water inlet hoses supplied with the machine.

Further information can be found in the installation plan. The installation plan is available online.

In line with national provisions relating to the protection of drinking water, non-return valves must be installed between the water connection and the water inlet hose on all water inlet hoses present. The connection for DI water is excluded.

Retrofitting the large-surface filter

If the water contains a high level of insoluble components, a large-surface filter can be installed between the faucet and the water inlet hose.

The large-surface filter is available from Miele Service.

DI water connection for 4.4-145 psi (30-1,000 kPa) – pressure-proof (optional)

The machine is optionally supplied for a pressurized system operating between 4.4-145 psi (30-1,000 kPa). At a water pressure (water connection pressure) below 29 psi (200 kPa), the water intake time extends automatically.

- Connect the pressure-tested, green-marked DI water inlet hose with the $\frac{3}{4}$ " threaded union to the on-site ball valve for DI water.

DI water inlet for 8.5-60 kPa – unpressurized

For connection to 8.5-60 kPa, the machine must be equipped with a feed pump for DI water. Installation is carried out by Miele Service or a suitably qualified specialist.

With an unpressurized DI water container, the outlet nozzle must be at least level with the top edge of the machine; see I-Plan.

Non-pressurized (gravity feed) DI water connection 1.3 - 8.7 psi (8.5 - 60 kPa)

If DI water is supplied from a DI water reservoir with gravity feed or low pressure, an optional DI water booster pump supplied by Miele is required.

The pressure for gravity feed or low pressure ranges between 1.3 - 8.7 psi (8.5 - 60 kPa). The external DI water booster requires an external power supply with 120V. For further details refer to install diagram. The installation must only be carried out by Miele Service.

DI water ring line The machine can be connected to a ring line system for DI water. For this purpose, the machine must be technically adapted and the controls reset by Miele Service.

Please contact Miele Service for further information.

Connecting the water drain

- The machine drainage system is equipped with a non-return valve, which prevents dirty water from flowing back into the machine via the drain hose.
- The machine drainage hose should be connected to a separate on-site drainage system for the machine only. If a separate connection is not available, it is recommended to connect the hose to a dual-chamber siphon.

⚠ As standard, the drain water of the machine will reach temperatures greater than 158°F (70°C).
At this temperature, drain water can damage the drain system.
In order to reduce the drainage temperature Miele offers an optional drain water cool-down kit.







- The on-site connection must be 12" and 3.3' (0.3 m and 1.0 m) in height, **measured from the lower edge of the machine**. If the connection is lower than 12" (0.3 m), the drain hose must be laid with a bend in it and be at least 12" (0.3 m) high.
- The drainage system must be able to accommodate a minimum drainage flow of 16 L/min.
- The drain hose is approx. 4.7' (1.4 m) long and flexible with an internal diameter of 7/8" (22 mm). Hose clips for the connection are included.
- The drain hose must not be shortened.
- The drain hose can be extended using a connecting piece to attach a further length of hose up to 13' (4.0 m). The drainage length must not be longer than 13' (4.0 m).
- The drain noise can be significantly reduced if the drain hose is laid with a bend in it with a minimum height of 1.9' (0.6 m) and a maximum height of 3.3' (1.0 m), measured from the lower edge of the machine.

Further information can be found in the installation plan. The installation plan is available online.





Program chart

To adjust the program parameters; see ▶  Extended settings ▶ Program options ▶ Configure programs.



General program information

Program	Area of application
 Quick Wash	Very short program for very lightly soiled wash items and very low final rinse requirements: <ul style="list-style-type: none"> - to remove water-soluble soiling - suitable to a limited extent for organic soiling - not suitable for denatured residues such as protein - not suitable for inorganic, acid-soluble residues such as metallic salts
 Standard	Short program for lightly soiled wash items and low rinse requirements: <ul style="list-style-type: none"> - to remove water-soluble soiling - suitable to a limited extent for organic soiling - not suitable for denatured residues such as protein - not suitable for inorganic, acid-soluble residues such as metallic salts
 Standard Eco	Program with reduced energy and water consumption. Use as described for the  Standard program.
 Universal	Program for lightly soiled to moderately soiled wash items and moderate rinse requirements: <ul style="list-style-type: none"> - to remove water-soluble soiling - to remove organic soiling - to remove denatured residues such as protein - suitable to a limited extent for inorganic, acid-soluble residues, such as metallic salts
 Intensive	Program for moderately soiled to heavily soiled wash items and moderate to high rinse requirements: <ul style="list-style-type: none"> - to remove water-soluble soiling - to remove organic soiling - to remove denatured residues such as protein - suitable to a limited extent for inorganic, acid-soluble residues, such as metallic salts
 Injector Plus	Program with increased wash pressure and increased water levels for the following basket combinations: <ul style="list-style-type: none"> - upper basket with one spray arm and lower basket with 2 injector modules - upper and lower baskets with a total of 4 injector modules Use as described for the Universal program.

Programs for specific soiling









Program	Area of application
 Inorganic	Program for lightly soiled to moderately soiled wash items and moderate to high rinse requirements: - to remove inorganic, acid-soluble residues such as metallic salts
 Organic	Program for moderately soiled to heavily soiled wash items and moderate rinse requirements: - for removing concentrated organic residues, e.g., fats, waxes, and stubborn dried-on or thermally adhered organic residues - not suitable for inorganic, acid-soluble residues such as metallic salts
 Agar	Program to remove agar residues and for moderate final rise requirements.
 Oil	Program for heavily soiled wash items and moderate rinse requirements: - to remove oil stains (e.g., synthetic oils, lubricants, fuels, and some natural oils), fats, and some waxes - not suitable for inorganic, acid-soluble residues such as metallic salts - liquid cleaning agent required - hot water and DI water connection recommended - Additional process chemicals (e.g., emulsifier) and additional dispensing hose recommended

Programs for specific wash items

Program	Area of application
 Plastics	Program for lightly soiled to moderately soiled wash items and moderate rinse requirements: - for temperature-sensitive laboratory equipment, e.g., plastic bottles - temperature resistance up to minimum 130°F (55°C) required
 Pipettes	Program for lightly soiled to moderately soiled pipettes and moderate to high rinse requirements: - for measuring and volumetric pipettes - Special load carriers for reprocessing pipettes required
 Vials	Program for lightly soiled to moderately soiled small wash items, e.g., vials, centrifuge tubes, and test tubes, with moderate to high final rinse requirements: - Special load carriers for reprocessing vials, etc. required

Program chart

Additional programs

Program	Area of application
 Pasteurize	Program for pasteurizing food, e.g., flavor profiles of drinks. The program must be adapted to the individual pasteurization parameters (temperature and holding time) for the product to be pasteurized and the load of the wash cabinet. The default settings of the program are 158°F (70°C) (temperature) and 30 min (holding time).
 Hygiene 93/10	Program for cleaning and thermal disinfection at 199°F (93°C) with 10 minutes' temperature holding time. The wash water is not pumped away until after disinfection is complete.
 Cold water rinse	Program for rinsing the wash cabinet, for rinsing overflowing brine after refilling reactivation salt or for rinsing heavily soiled wash items, e.g., for pre-rinsing soiling, residual disinfectant, or to prevent items drying out and to prevent incrustation before running a full program. Cold water is used for rinsing, holding time: 2 min
 DI water rinse	Program for rinsing the wash cabinet and for rinsing wash items with DI water, holding time: 2 min.
 Drying	Available for machines with active drying. Program for drying wash items.
 Drain	For draining wash water, e.g., after a program cancelation.
Service programs for Miele Service	
 Service cycle	Do not use for reprocessing wash items! Service program to be performed by Miele Service or a suitably qualified specialist. Special process chemicals are required for the program.
 IQOQ Test	Do not use for reprocessing wash items! Program for carrying out IQOQ tests.

Technical details

	Metric	Imperial
Height With machine lid Without machine lid	835 mm (adjustable + 8 mm) 820 mm (adjustable + 8 mm)	32 7/8" (adjustable + 5/16") 32 5/16" (adjustable + 5/16")
Width	898 mm	35 3/8"
Depth With glass door + control panel With steel door + control panel With door open	603 mm + 41 mm 598 mm + 41 mm 1.200 mm	23 3/4" + 1 5/8" 23 9/16" + 1 5/8" 47 1/4"
Wash cabinet dimensions: Height Width Depth of upper basket/lower basket	520 mm 530 mm 474 mm/520 mm	20 9/16" 21 1/8" 20 3/8"/20 9/16"
Weight of machine (net): With glass door With steel door	104 kg 98 kg	229 lbs 216 lbs
Max. load capacity of open door	37 kg	81.6 lbs
Maximum load weight Upper basket + lower basket/mobile unit Mobile unit/lower basket (without upper basket)	8 kg + 16 kg 24 kg	17.6 lbs + 35.3 lbs 53 lbs
Voltage, rated load, fuse rating	See data plate	See data plate
Power cord	Approx. 1.8 m	Approx. 5' 9"
Water connection temperature: Cold water Hot water DI water (optional)	Max. 20°C Max. 65°C Max. 65°C	Max. 68°F Max. 149°F Max. 149°F
Static water pressure	1,000 kPa overpressure	145 psi
Minimum water connection flow pressure: Cold water Hot water DI water (optional)	100 kPa pressure 40 kPa pressure 30 kPa pressure	14.5 psi pressure 5.8 psi pressure 4.4 psi pressure
Recommended water connection pressure: Cold water Hot water DI water (optional)	≥ 200 kPa pressure ≥ 200 kPa pressure ≥ 200 kPa pressure	≥ 29 psi pressure ≥ 29 psi pressure ≥ 29 psi pressure
DI water connection without pressure (optional)	8,5–60 kPa	1.2–8.7 psi pressure
Water inlet hose	Approx. 1.7 m	Approx. 5' 7"
Drain hose	Approx. 1.4 m	Approx. 4.7'
Delivery head	Min. 0.3 m, max. 1.0 m	Min. 12", max. 3.3'
Drainage length	Max. 4.0 m	Max. 13'

Technical details

Operation (according to UL 61010-1, CSA C22.2 No. 61010-1): Ambient temperature Relative humidity maximum linear decrease to Relative humidity minimum	5°C to 40°C 80% for temperatures up to 31°C 50% for temperatures up to 40°C 10%	40°F up to 140°F 80% for temperatures up to 88°F 50% for temperatures up to 104°F 10%
Storage and transportation conditions: Ambient temperature Relative humidity Air pressure	-20°C to 60°C 10% to 85% 500 hPa to 1060 hPa	-4°F to 140°F 10% to 85% 7.25 psi to 15.37 psi
Altitude above sea level (according to UL 61010-1, CSA C22.2 No. 61010-1)	Up to 2.000 m *)	Up to 6,561 ft *)
Protection category (according to IEC 60529)	IP20	IP20
Degree of soiling (according to UL 61010-1, CSA C22.2 No. 61010-1)	2	2
Overvoltage category (according to IEC 60664)	II	II
Sound emission values in dB (A), sound pressure level LpA during cleaning and drying phases	< 70	< 70
Wi-Fi standard	802.11 b/g/n	
WiFi frequency band	2,400-2,483.5 MHz	
Maximum WiFi transmission power	< 100 mW	
VDE radio suppression, EMC equipment class (according to EN 61236-1)	B FCC part 15	
MET electrical safety	UL 61010-1, CSA C22.2 No. 61010-1, UL 61010-2-040, CSA-C22.2 No. 61010-2-040	
Manufacturer's address	Miele & Cie. KG, Carl-Miele-Strasse 29, 33332 Gütersloh, Germany	

* If installation site is above 1.500 m, the boiling point of the wash water will be lower. In this case, the disinfecting temperature and the holding time might need to be adjusted.

Disposal of packaging material

The packaging is designed to protect the machine against transportation damage. The packaging materials used are selected from materials which are environmentally friendly for disposal and should be recycled.

Ensure that any plastic wrappings, bags, etc. are disposed of safely and kept out of the reach of children. Danger of suffocation!

Disposing of your old machine

Electrical and electronic appliances contain many valuable materials. They also contain certain materials, compounds, and components which were essential for their correct functioning and safety. These could be hazardous to your health and to the environment if disposed of with household waste or if handled incorrectly. Please do not, therefore, dispose of your old appliance with household waste.

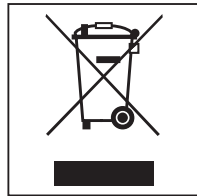

Instead, please make use of officially designated collection and disposal points to dispose of and recycle electrical and electronic appliances in your local community. By law, you are solely responsible for deleting any personal data from the appliance prior to disposal. You are legally obliged to remove any old batteries which are not securely enclosed by the appliance and to remove any lamps without destroying them, where this is possible. These must be taken to a suitable collection point where they can be handed in free of charge. Please ensure that your old machine poses no risk to children while being stored for disposal.



Please have the model and serial number
of your machine available when
contacting Technical Service.

U.S.A.
Miele, Inc.

National Headquarters

9 Independence Way
Princeton, NJ 08540
Phone: 800-991-9380
www.mieleusa.com/professional
prosales@mieleusa.com

Technical Service & Support

Phone: 800-991-9380
proservice@mieleusa.com

Canada
Importer
Miele Limited

Professional Division

161 Four Valley Drive
Vaughan, ON L4K 4V8
Phone: 1-888-325-3957
www.mieleprofessional.ca
professional@miele.ca

Miele Professional Technical Service

Phone: 1-888-325-3957
serviceprofessional@miele.ca



Manufacturer: Miele & Cie. KG
Carl-Miele-Straße 29, 33332 Gütersloh, Germany