



Operating and installation instructions Induction hobs



To avoid the risk of accidents or damage to the appliance it is **essential** to read these instructions before it is installed and used for the first time.

Contents

Warning and Safety instructions	5
Caring for the environment	14
Guide to the appliance	15
Your hob	15
Cooking area data	16
Accessories supplied	17
Controls	18
Touch display	18
Symbols	20
Before using for the first time	21
Cleaning the hob for the first time	21
Switching on the hob for the first time	21
Miele@home	22
Con@ctivity	24
How it works	26
Noises	27
Power Management	28
Pans	29
Tips on saving energy	31
Setting ranges	32
Operation	33
Using the appliance	33
Selecting a menu option	34
Displaying the pull-down menu	34
Scrolling	34
Exiting a menu level	34
Changing a setting in a list	34
Pan recognition	34
Positioning cookware	35
Switching on the hob	37
Setting the power level	37
Switching off a cooking zone/the hob	37
Residual heat indicator	38
TempControl 	39
Setting the power level – extended setting range	42
PowerFlex Plus cooking area	42
Booster function	43
Assistant 	45

Timer	48
Minute minder	48
Auto switch off.....	49
Additional functions	50
Stop & Go	50
Recall.....	50
Wipe protection.....	51
Demo mode	51
Displaying hob data.....	51
Safety features	52
System lock.....	52
Safety switch-off	53
Overheating protection.....	53
Settings 	54
Note for test institutes	56
Cleaning and care	57
Safety notes on cleaning and care	57
Unsuitable cleaning agents.....	58
Problem solving guide	59
Messages in the display.....	59
Unexpected behaviour.....	60
Unsatisfactory results.....	62
General problems or technical faults	63
Optional accessories	64
After sales service	65
Contact in the event of a fault	65
Warranty	65
Installation	66
Safety instructions for installation	66
Safety distances	67
Installation notes – surface-mounted.....	71
Installation dimensions – Surface-mounted.....	72
Installation dimensions – KM 7999 FR.....	72
Installation dimensions – KM 7999 FL.....	73
Surface-mounted installation	74
Installation notes – flush-fit.....	75
Installation dimensions – Flush-fit	76
Installation dimensions – KM 7999 FL.....	76
Flush-fit installation.....	77

Contents

Electrical connection	78
Product data sheets	80
EU Conformity declaration.....	81
UK Conformity declaration	82

Warning and Safety instructions

This hob complies with all relevant local and national safety requirements. Inappropriate use can, however, lead to personal injury and material damage.

Read the operating and installation instructions carefully before using the hob. They contain important information on safety, installation, use and maintenance. This prevents both personal injury and damage to the hob.

In accordance with standard IEC 60335-1, Miele expressly and strongly advises that you read and follow the instructions in the chapter on installing the hob as well as the safety instructions and warnings.

Miele cannot be held liable for injury or damage caused by non-compliance with these instructions.

Keep these instructions in a safe place and pass them on to any future owner.

Warning and Safety instructions

Correct application

- ▶ This hob is intended for domestic use and use in other similar environments.
- ▶ This hob is not intended for outdoor use.
- ▶ It is intended for domestic use only to cook food and keep it warm. Any other use is not supported by the manufacturer and could be dangerous.
- ▶ This hob is not intended for use by people with reduced physical, sensory or mental capabilities or lack of experience and knowledge, unless they have been given supervision and instruction concerning its use by a person responsible for their safety. They may only use the hob unsupervised if they have been shown how to use it in a safe way. They must be able to recognise and understand the dangers of misuse.

Safety with children

- ▶ Children under 8 years of age must be kept away from the hob unless they are constantly supervised.
- ▶ Children over 8 years of age may use the hob without supervision if its operation has been clearly explained to them and they are able to use it safely. Children must be able to understand and recognise the possible dangers caused by incorrect operation.
- ▶ Children must not be allowed to clean the hob unsupervised.
- ▶ Please supervise children in the vicinity of the hob and do not let them play with it.
- ▶ The hob gets hot when in use and remains hot for a while after being switched off. Keep children well away from the hob until it has cooled down and there is no danger of burning.
- ▶ Danger of burning. Do not store anything which might arouse a child's interest in storage areas above or behind the hob. Otherwise they could be tempted to climb onto the hob.
- ▶ Risk of burning and scalding. Place pots and pans on the cooking zone in such a way that children cannot pull them down and burn themselves.
- ▶ Danger of suffocation! Whilst playing, children may become entangled in packaging material (such as plastic wrapping) or pull it over their head with the risk of suffocation. Keep packaging material away from children.
- ▶ Activate the system lock to ensure that children cannot switch on the hob inadvertently.

Warning and Safety instructions

Technical safety

▶ Unauthorised installation, maintenance and repairs can cause considerable danger for the user. Installation, maintenance and repairs must only be carried out by a Miele authorised technician.

▶ Damage to the hob can compromise your safety. Check the hob for visible signs of damage. Do not use the hob if it is damaged.

▶ Temporary or permanent operation on an autonomous power supply system or a power supply system that is not synchronised with the mains power supply (e.g. island networks, back-up systems) is possible. A prerequisite for operation is that the power supply system complies with the specifications of EN 50160 or an equivalent standard.

The function and operation of the protective measures provided in the domestic electrical installation and in this Miele product must also be maintained in isolated operation or in operation that is not synchronised with the mains power supply, or these measures must be replaced by equivalent measures in the installation. As described, for example, in the current version of BS OHSAS 18001–2 ISO 45001.

▶ The electrical safety of this hob can only be guaranteed when correctly earthed. It is essential that this standard safety requirement is met. If in any doubt please have the electrical installation tested by a qualified electrician.

▶ To avoid the risk of damage to the hob, make sure that the connection data on the data plate (voltage and frequency) match the mains electricity supply before connecting it to the mains. Consult a qualified electrician if in doubt.

▶ Do not connect the hob to the mains electrical supply by a multi-socket adapter or extension lead. These are a fire hazard and do not guarantee the required safety of the appliance.

▶ For safety reasons, this hob may only be used after it has been built in.

▶ This hob must not be used in a non-stationary location (e.g. on a ship).

▶ Never open the casing of the hob.

Touching or tampering with electrical connections or components and mechanical parts is highly dangerous to the user and can cause operational faults.

Warning and Safety instructions

- ▶ While the hob is under warranty, repairs should only be undertaken by a Miele authorised service technician. Otherwise the warranty is invalidated.
- ▶ Miele can only guarantee the safety of the appliance when genuine original Miele replacement parts are used. Faulty components must only be replaced by Miele spare parts.
- ▶ The hob is not intended for use with an external timer switch or a remote control system.
- ▶ The hob must be connected to the electricity supply by a qualified electrician (see “Installation – Electrical connection”).
- ▶ If the mains connection cable is damaged, it must be replaced with a special mains connection cable by a qualified electrician (see “Electrical connection” in the “Installation” chapter).

Warning and Safety instructions

- ▶ The hob must be disconnected from the mains electricity supply during installation, maintenance and repair work. Ensure that power is not supplied to the appliance until after it has been installed or until any maintenance or repair work has been carried out.
- ▶ Danger of electric shock. Do not use the hob if it is faulty, or if the ceramic surface is cracked, chipped or damaged in any way. Switch it off immediately. Disconnect the hob from the mains electricity supply. Contact Miele Service.
- ▶ If the hob is installed behind a cabinet door, do not close the door while the hob is in use. Heat and moisture can build up behind the closed door. This can result in damage to the hob, the housing unit and the floor. Do not close the door until the residual heat indicators go out.

Correct use

- ▶ The hob gets hot when in use and remains hot for a while after being switched off. There is a danger of burning until the residual heat indicators go out.
- ▶ Oil and fat can overheat and catch fire. Do not leave the hob unattended when cooking with oil and fat. If it does ignite do not attempt to put the flames out with water.
Disconnect the hob from the mains and use a suitable fire blanket, saucepan lid, damp towel or similar to smother the flames.
- ▶ Do not leave the hob unattended whilst it is being used. It should be continually monitored whilst boiling and flash frying.
- ▶ Flames could set the grease filters of a cooker hood on fire. Do not flambé under a cooker hood.
- ▶ Spray canisters, aerosols and other inflammable substances can ignite when heated. Therefore do not store such items or substances in a drawer under the hob. Cutlery inserts must be heat-resistant.
- ▶ Do not heat an empty pan.
- ▶ Do not heat up food in closed containers e.g. tins or sealed jars on the hob, as pressure can build up in the container, causing it to explode.
- ▶ Do not cover the hob, e.g. with a hob cover, a cloth or protective foil. The material could catch fire, shatter or melt if the hob is switched on by mistake or if residual heat is still present.
- ▶ When the appliance is switched on either deliberately or by mistake, or when there is residual heat present, there is the risk of metal items placed on the hob heating up. Other materials can melt or catch fire. Damp pan lids might adhere to the ceramic surface and be difficult to dislodge. Do not use the hob as a resting place for anything. Switch the hob off after use.
- ▶ You could burn yourself on the hot hob. Protect your hands with heat-resistant pot holders or gloves when handling hot pots and pans. Do not let them get wet or damp, as this causes heat to transfer through the material more quickly with the risk of scalding or burning yourself.
- ▶ When using an electrical appliance, e.g. a hand-held food blender, near the hob, ensure that the cable of the electrical appliance cannot come into contact with the hot hob. The insulation on the cable could become damaged.

Warning and Safety instructions

- ▶ Grains of salt, sugar and sand (e.g. from cleaning vegetables) can cause scratches if they get under pan bases. Make sure that the ceramic surface is clean before placing pans on it.
- ▶ Even a light object can cause damage in certain circumstances. Do not drop anything on the ceramic surface.
- ▶ Hot items placed down on the touch display can damage the electronic unit underneath. Never place hot cookware in the area of the touch display.
- ▶ Do not allow solid or liquid sugar, or pieces of plastic or aluminium foil to get onto the hob when it is hot, as they can damage the ceramic surface when it cools down. If this should occur, switch off the appliance and scrape off all the sugar, plastic or aluminium residues whilst still hot, using a shielded scraper blade suitable for use on glass. Wear oven gloves when doing this. Allow the ceramic surface to cool down and then clean it with a suitable ceramic hob cleaning agent.
- ▶ Acidic food such as vinegar, jams or lemon juice can cause discolouration to the ceramic surface. Remove acidic residues immediately.
- ▶ Pans which boil dry can cause damage to the ceramic glass. Do not leave the hob unattended whilst it is being used.
- ▶ Only use pots and pans with smooth bases. Rough bases will scratch the ceramic glass.
- ▶ Lift pans into position on the hob. Sliding them into place can cause scuffs and scratches.
- ▶ Because induction heating works so quickly, the base of the pan could, under certain circumstances, heat up to the temperature at which oil or fat self-ignites within a very short time. Never leave the hob unattended during use!
- ▶ Never use the Booster function to heat oil or fat. Heat oil or fat for a maximum of 1 minute using the *Manual 1–9* function.
- ▶ For people fitted with a heart pacemaker: Please note that the area immediately surrounding the hob is electromagnetically charged. It is very unlikely to affect a pacemaker. However, if in any doubt, consult the manufacturer of the pacemaker or your doctor.
- ▶ To prevent damage to items which are susceptible to electromagnetic fields, e.g. credit cards, digital storage devices, pocket calculators, etc, do not leave them in the immediate vicinity of the hob.

Warning and Safety instructions

- ▶ Metal utensils stored in a drawer under the hob can become hot if the appliance is used intensively for a long time.
- ▶ The hob is fitted with a cooling fan. If a drawer is fitted directly underneath the hob, ensure that there is sufficient space between the drawer and its contents and the underside of the hob in order to ensure sufficient ventilation for the hob.
- ▶ If a drawer is fitted directly underneath the hob, do not store any pointed or small items, paper, serviettes, etc. in the drawer. They could get in through the ventilation slots or be sucked into the casing by the fan and damage the fan or impair cooling.
- ▶ The induction generators could be damaged or even destroyed if you use an induction adapter plate for cookware. Do not use induction adapter plates.

Cleaning and care

- ▶ Do not use a steam cleaning appliance to clean this hob. The steam could reach electrical components and cause a short circuit.
- ▶ If the hob is built in over a pyrolytic oven, the hob should not be used whilst the pyrolytic process is being carried out, as this could trigger the overheating protection mechanism on the hob (see relevant section).

Caring for the environment

Disposing of the packaging material

The packaging material is used for handling and protects the appliance from transport damage. The packaging material used is selected from materials which are environmentally friendly for disposal and can generally be recycled.

Recycling the packaging material reduces the use of raw materials. Use material-specific collection points for valuable materials and take advantage of return options. Your Miele dealer will take the packaging material away.

Disposing of your old appliance

Electrical and electronic appliances contain many valuable materials. They also contain certain materials, compounds and components which were essential for their correct functioning and safety. These could be hazardous to human health and to the environment if disposed of with household waste or if handled incorrectly. Please do not, therefore, dispose of your old appliance with household waste.



Instead, please make use of officially designated collection and disposal points to dispose of and recycle electrical and electronic appliances in your local community, with your dealer or with Miele, free of charge. By law, you are solely responsible for deleting any personal data from the old appliance prior to disposal. You are legally obliged to remove any old batteries which are not securely enclosed by the appliance and to remove any lamps without destroying them, where this is possible. These must be taken to a suitable collection point where they can be handed in free of charge. Please ensure that your old appliance poses no risk to children while being stored for disposal.

Your hob

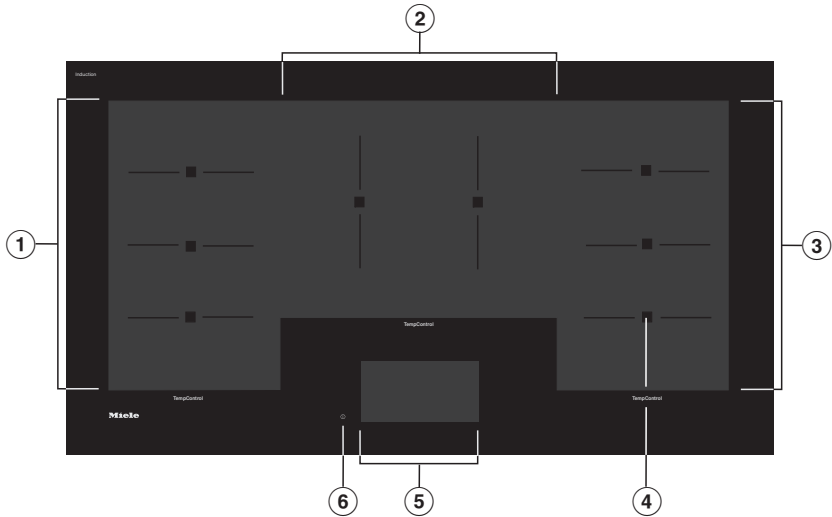

- ① PowerFlex Plus cooking area with TempControl
- ② PowerFlex Plus cooking area with TempControl
- ③ PowerFlex Plus cooking area with TempControl
- ④ Sensors for TempControl
- ⑤ Touch display
- ⑥ Hob On/Off sensor control

Guide to the appliance

Cooking area data

Cooking area	Size in mm ¹	Max. rating in watts for 230 V ²	
①	382 x 226	Normal Booster	2800 3600
②	286 x 365	Normal Booster	2800 3600
③	382 x 226	Normal Booster	2800 3600
		Total	10,800

¹ The given range corresponds to the maximum base surface of the cookware that may be used.

² The power given may vary depending on the size and material of the cookware used.

Accessories supplied

The accessories supplied with your appliance as well as a range of optional ones are available to order from Miele (see “Optional accessories”).

WiFi stick XKS 3170 W

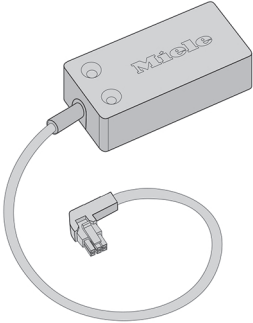

Controls

Touch display

 Risk of damage by sharp or pointed objects, and by hot cookware.
The touch display can be scratched by pointed or sharp objects, e.g. pens. Placing hot cookware over the touch display can damage the electronic unit underneath.
Only touch the display with your fingers.
Do not place items over the touch display.
Do not place hot cookware over the touch display.

The touch display is split into 3 areas.

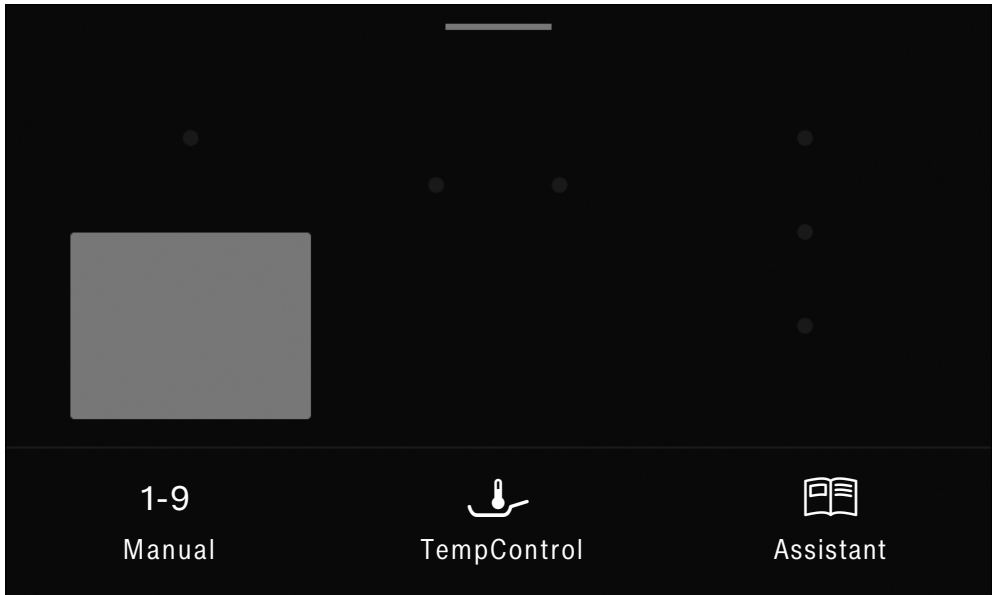

Top

At the top of the touch display there is an orange line where you can open the pull-down menu. The pull-down menu enables you to make settings while cooking.

The menu path appears on the left of the header. The individual menu options are separated by a vertical line.

If you touch a menu name in the header, the display will switch to that menu.

Middle

The cooking areas are situated in the middle. Active cooking zones are highlighted in grey and indicate the programme running time if a cooking process has been started. Depending on the cooking mode, the selected temperature or power level will also be displayed. The selected cooking zone is highlighted orange.



Footer

The footer contains the symbols for the main menu. Select the cooking mode here.





Controls

Symbols

Main menu



Symbol	Meaning
1-9 Manual	Manual cooking – power level selection
 TempControl	Sensor-assisted frying – temperature selection
 Assistant	Assistance function for cooking selected food and recipes

Pull-down menu

Symbol	Meaning
	Wipe protection
i	This symbol indicates that there is additional information and advice about using the appliance.
II/▶	Stop & Go
	Minute minder
	System lock
	Settings

Other symbols

Further symbols appear depending on the function selected.

Symbol	Meaning
	Auto switch off
	This will take you back to the previous menu or to the main menu.

Cleaning the hob for the first time

- Remove any protective wrapping and stickers.
- Do not remove stickers carrying safety or installation information or the data plate.

This makes it easier to perform servicing and repair work.

- Before using for the first time, clean the hob with a damp cloth only and then wipe dry.

Switching on the hob for the first time

Set the language

- Select the language you want.
- Confirm with OK.

Using the hob for the first time

The metal components have a protective coating which may give off a slight smell when heated up for the first time. The induction coils may also give off a slight smell for the first few hours of operation. This smell will be less noticeable with each subsequent use before dissipating completely.

The smell and any vapours given off do not indicate a faulty connection or appliance and they are not hazardous to health.

Please note that the heating up time on induction hobs is very much shorter than on conventional hobs.

Before using for the first time

Miele@home

Requirements:

- Home WiFi network
- The WiFi stick supplied with your appliance must be fitted.

Once the WiFi stick has been fitted, the hob can be connected to the home WiFi network.

If your Miele cooker hood is also connected to the home WiFi network, you can control the cooker hood automatically with the Con@ctivity function. Further information can be found in the operating and installation instructions for your cooker hood.

Make sure that the signal of your WiFi network is sufficiently strong in the place where your hob is installed.

There are a number of ways of connecting your hob to your WiFi network.

The hob requires max. 2 W in networked standby.

Availability of the WiFi connection

The WiFi connection shares a frequency range with other appliances (including microwave ovens and remote control toys). This can give rise to sporadic or even complete connection failures. Therefore, the availability of featured functions cannot be guaranteed.

Miele@home availability

The ability to use the Miele app depends on the availability of the Miele@home service in your country.

The Miele@home service is not available in every country.

For information about availability, please visit www.miele.com.

Miele App

The Miele App is available to download free of charge from the Apple App Store® or from the Google Play Store™.



After installing the Miele app on a mobile device, you can do the following:

- Call up information on the operating status of your hob
- Call up information on the programme sequence of your hob
- Set up a Miele@home network with other WiFi-enabled Miele appliances

Before using for the first time

Setting up Miele@home

Connecting via the app

The Miele@mobile app can be used to connect to your network.

- Install the Miele@mobile app on your mobile device.

To connect, you will need:

1. Your WiFi network password
2. The password for your hob

The password for your hob consists of the last 9 digits of the serial number. You can find the serial number in the Settings  under Software version (see “Additional functions – Displaying hob data”).

- Switch the hob on.
- Mobile device: start the Miele@mobile app.
- Hob: select Settings .
- Hob: touch Miele@home | Activate | Sign on via App.
- Mobile device: follow the user navigation in the app.

The touch display shows the message Connection successfully established.

Connecting via WPS

Prerequisite: you must have a WPS (WiFi protected setup) compatible router.

- Switch the hob on.
- Hob: touch Miele@home | Activate | Sign on via WPS.
- WiFi router: activate the WPS function on your WiFi router.

Hob: the touch display shows the message Connection successfully established.

Tip: If your WiFi router does not support WPS, please connect via the Miele@mobile app.



- Mobile device: follow the user navigation in the app.

Cancelling the process

- Touch Deactivate.

Resetting settings

It is not necessary to reset when replacing the wireless stick or the router.

- Switch the hob on.
- Call up the settings menu  (see “Settings ”).
- Touch Miele@home | Reset.

The touch display shows the message Network settings reset.

Reset the settings if you are disposing of your hob, selling it or putting a used hob into operation. This is the only way to ensure that all personal data has been removed and the previous owner will no longer be able to access the hob.

Before using for the first time

Con@ctivity

Con@ctivity is the direct communication system between your hob and a Miele cooker hood. Con@ctivity enables the cooker hood to operate automatically depending on the operating status of a hob.

Further information can be found in the operating and installation instructions for your cooker hood.

The hob requires max. 2 W in networked standby.

Availability of the WiFi connection

The WiFi connection shares a frequency range with other appliances (including microwave ovens and remote control toys). This can give rise to sporadic or even complete connection failures. Therefore, the availability of featured functions cannot be guaranteed.

Setting up Con@ctivity

You can set up Con@ctivity between the hob and cooker hood using your home WiFi network or a direct WiFi connection.

Con@ctivity via the home WiFi network (Con@ctivity 3.0)

Requirements:

- Home WiFi network
- The WiFi stick supplied with your appliance must be fitted
- WiFi-enabled Miele cooker hood

- Connect the cooker hood and the hob to your home WiFi network (see “Before using for the first time – Miele@home”).

The Con@ctivity function will be activated automatically.

You can find the necessary information on connecting the cooker hood in the associated operating and installation instructions.



Before using for the first time

Con@ctivity via a direct WiFi connection (Con@ctivity 3.0)

Requirements:

- The WiFi stick supplied with your appliance must be fitted
- WiFi-enabled Miele cooker hood

You can find the necessary information on connecting the cooker hood in the associated operating and installation instructions.

- Switch the hob on.
- Call up the settings menu  (see “Settings ”).
- Touch Miele@home | Activate | Con@ctivity.

The touch display shows the message Connection successfully established.

When successfully connected, **2** and **3** will light up constantly on the cooker hood.

- Quit connection mode on the cooker hood by pressing the run-on  button.

Con@ctivity is now activated.



With a direct WiFi connection, it is not possible to connect the hob and the cooker hood to a home network. If this is desired later, the direct WiFi connection between the hob and the cooker hood must first be disconnected (see “Resetting settings” and “Disconnecting the WiFi” in the operating and installation instructions for the cooker hood).

Cancelling the process

- Touch Deactivate.

Resetting settings

It is not necessary to reset when replacing the wireless stick or the router.

- Switch the hob on.
- Call up the settings menu  (see “Settings ”).
- Touch Miele@home | Reset.

The touch display shows the message Network settings reset.

Reset the settings if you are disposing of your hob, selling it or putting a used hob into operation. This is the only way to ensure that all personal data has been removed and the previous owner will no longer be able to access the hob.

How it works

Induction coils are located under the ceramic surface. These coils create a magnetic field that reacts directly with the base of the cookware and heats it up. The ceramic surface itself is heated up indirectly by the heat given off by the cookware.

The position, size and shape of the cookware are recognised automatically by the induction hob.

An induction cooking zone only works when cookware with a magnetic base is placed on it (see “Cookware”).



Risk of burning due to hot items. When the appliance is switched on either deliberately or by mistake, or when there is residual heat present, there is the risk of metal items placed on the hob heating up.

Do not use the appliance as a resting place for anything.

After use, switch the hob off with the ① sensor control.

Cooking areas

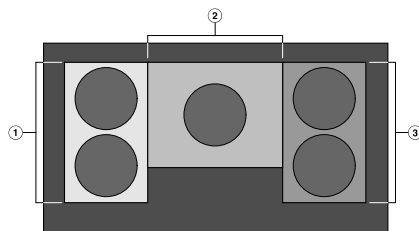

- ① PowerFlex Plus cooking area with TempControl
- ② PowerFlex Plus cooking area with TempControl
- ③ PowerFlex Plus cooking area with TempControl

The hob has 3 cooking areas. The entire hob surface, including all cooking areas, can be divided into individual cooking zones.

You can use a maximum of 5 items of cookware at the same time: 2 items on the left, 2 items on the right and 1 item on the central cooking area.

If 2 items of cookware are used on the left or right cooking areas, a display for each item is shown on the touch display.

If necessary, cookware can cover several cooking areas at the same time.

For more information on cooking areas and combination options, see “Operation – Positioning cookware”.

Noises

The following noises can occur in the cookware, depending on what it is made of and how it has been constructed:

Buzzing on the higher power levels. This will decrease or cease altogether when the power level is reduced.

If the cookware is made of layers of different materials (e.g. in a sandwiched base), it might emit a crackling sound.

You might hear a clicking sound from the electronic switches, especially at lower power levels.

A whirring sound, when the cooling fan comes on. This switches on to protect the electronic module when the hob is being used intensively. The fan may continue to run after the appliance has been switched off.

How it works

Power Management

The hob has a maximum total permitted power consumption which cannot be exceeded for safety reasons.

If you are using 2 items of cookware on the left or right cooking area at the same time, the power level will be regulated so that the total power output is not exceeded.

Example:

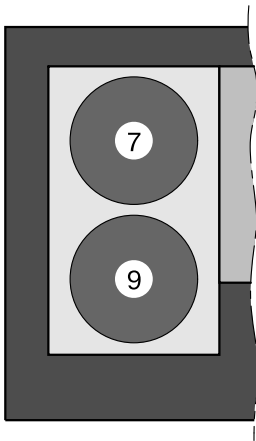

if power level 9 is selected for the front left cookware, the maximum available power output available for the rear left cookware will be power level 7.

A total power output of 10,800 W is set at the factory. The total power output can be reduced to 7200 W (see “Settings – Settings overview”).

Reducing the total power output to 7200 W has the following effect:

- A high power level cannot be selected for very large cookware.
- If you are using 2 items of cookware on the left or right cooking area at the same time, only the Manual 1–9 function can be used.

Suitable cookware

- Stainless steel cookware with a magnetic base
- Enamelled steel cookware
- Cast iron

Please be aware that the properties of the cookware base can affect the evenness with which the food heats up (e.g. when making pancakes). The base of the pan must be able to distribute the heat evenly. Cookware with a base made from multilayer material (sandwich or encapsulated base) is ideal in this case.

The pan base material and the positions of the pans on the hob affect the power of the induction coils. This can affect the cooking behaviour.

Unsuitable pans.

- stainless steel pans without a magnetic base
- aluminium or copper pans
- glass, ceramic or earthenware pots and pans

Testing pans

To test whether a pan is induction-compatible, hold a magnet to the base of the pan. If the magnet sticks, the pan is generally suitable.

No cookware/unsuitable cookware display

- - - flashes on the touch display if:
 - A cooking zone has been switched on without cookware in place, or if the cookware is unsuitable (non-magnetic base)
 - The diameter of the base of the cookware is too small
 - The cookware is taken off the cooking zone when it is switched on
 - The cookware is not positioned correctly

If no cookware or unsuitable cookware is placed on the cooking zone, the cooking zone will switch off automatically after 1 minute.

Using the cooking zone

- Place a suitable item of cookware on the cooking zone within 1 minute.
 - - - goes out. The cooking process continues with the previously selected settings.
- If you are using a different item of cookware and/or food, modify the settings.

Not using the cooking zone

- Switch the cooking zone off.

Pans

Tips

- Use only cookware with smooth bases. Rough bases can scratch the ceramic glass.
- Always lift cookware to move it. This will help prevent scratching. If any scratches do appear as a result of cookware being pushed around, this will not affect the function of the hob. These scratches are normal signs of use and are not grounds for making a complaint.
- Please note that the cookware diameter quoted by manufacturers often refers to the maximum diameter or diameter of the top rim. The diameter of the base (generally smaller) is more important.

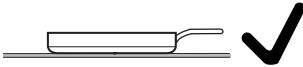

- Where possible, use cookware with vertically straight sides. If an item of cookware has angular sides, induction also acts on the sides of the item of cookware. The sides of the item of cookware may discolour or the coating may peel off.

Tips on saving energy

- Cook in covered pots and pans if possible. This prevents heat escaping unnecessarily.
- Cook with as little water as possible.
- When you have brought the pan to the boil, switch to a lower power level as soon as possible.
- Use a pressure cooker to reduce cooking durations.

Setting ranges

The hob is programmed with 9 power levels at the factory. If you wish to fine-tune a setting, you can extend the power level range to 17 power levels (see “Settings”).

	Setting range	
	Factory setting (9 power levels)	Extended setting (17 power levels)
Melting butter Melting chocolate Dissolving gelatine	1–2	1–2
Warming up small quantities of liquid Keeping warm food which sticks easily Cooking rice or porridge Defrosting vegetables frozen in a block	2–4	2–3
Warming up liquid and semi-solid food Steaming fruit Simmering potatoes (cookware with lids)	4–6	3–5
Making omelettes or lightly fried eggs Gently frying meat patties Steaming fish and vegetables Cooking dumplings and dried pulses Defrosting and reheating frozen food Thickening sauces, e.g. Hollandaise	5–7	4–7
Gently frying fish, escalopes, sausages, fried eggs, pancakes (without overheating the fat)	6–8	6–7
Cooking potato fritters, pancakes, etc.	7–8	7–8
Frying, e.g. chips	9	8–9
Boiling large quantities of water Bringing to the boil Searing large quantities of meat	9–Booster	8–Booster

These settings should only be taken as a guide. The power of the induction coils will vary depending on the size and material of the cookware. For this reason, the power levels may need to be adjusted slightly to suit your cookware. As you use the hob, you will get to know which settings suit your cookware best. When using new cookware that you are not familiar with, set the power to one level below the one specified.

Using the appliance

This ceramic hob is equipped with an electronic On/Off ① sensor which reacts to finger contact. For safety reasons, in order to switch the appliance on, the On/Off ① sensor needs to be touched for a little longer than the other sensors.

Only the printed On/Off ① symbol is visible when the hob is switched off. The touch display lights up when you switch the hob on.

You operate the hob via the touch display by touching the menu option you want.

Each time you touch the display, an audible signal sounds.

Each time you touch a possible option, the relevant characters (word and/or symbol) light up **orange**.

Fields for confirming an operating step are highlighted in **green** (e.g. OK).

 Malfunction due to a dirty and/or covered touch display.

If the touch display is dirty or covered, this could cause it to fail to react, to activate a function or even to issue a fault message (see “Safety features – Safety switch-off”). Placing hot cookware over the touch display can damage the electronic unit underneath.

Keep the touch display clean.

Do not place items over the touch display.

Do not place hot cookware over the touch display.

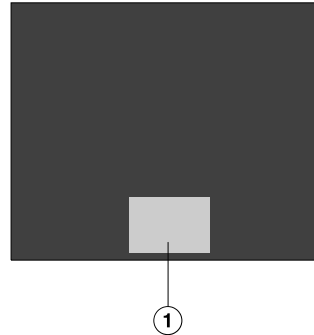

① Touch display area

Operation

Selecting a menu option

- Touch the field or value you want in the display.

Displaying the pull-down menu

- Touch the orange line along the upper edge of the touch display.
- Select the function you want.
- To close the pull-down menu, drag it back up to the top or touch an area of the display located outside of the menu window.

Scrolling

You can scroll left or right.

- Swipe across the screen. To do this, place your finger on the touch display and swipe it in the direction you want.

The bar at the bottom shows you where you are in the current menu.

Exiting a menu level

- Touch the ↩ symbol or touch the menu path in front of the last symbol I.

Entries made before this which have not been confirmed with OK will not be saved.

Changing a setting in a list

The current setting is highlighted in orange.

- Touch the desired setting.

The setting is now saved. This will take you back to the previous menu.

Pan recognition

Permanent pan recognition is activated as standard (see “Settings”). When the hob is switched on and you place an item of cookware on a cooking area, the relevant display appears automatically on the touch display.

If pan recognition is deactivated, you have to touch the area that corresponds with the position of the cookware on the touch display to switch the area on.

Positioning cookware

- Position cookware as illustrated on the cooking area figures. As a result:
 - Even heat distribution is assured.
 - The TempControl sensor detects suitable cookware.

⚠ Risk of fire from overheating. Overheating can occur if a sensor is unable to function correctly. Position the cookware centrally over a sensor.

Minimum cookware size

Depending on the function and cooking area, your cookware must have the following minimum base diameter:

Cooking area	Manual	TempControl
Left/right	11 cm	13 cm
Middle	11 cm	16 cm

Left and right cooking areas

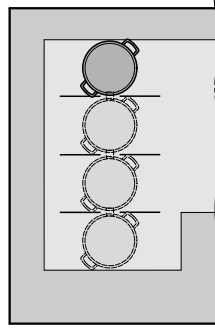

Cookware with a base diameter smaller than 13 cm.

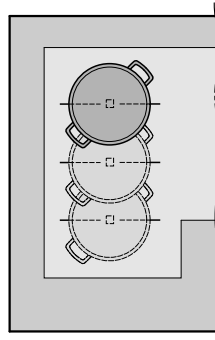

Cookware with a base diameter larger than 13 cm.

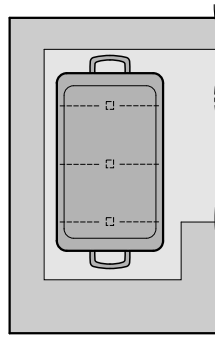

Larger cookware

Operation

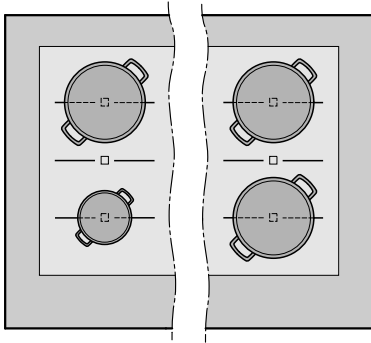

2 items of cookware

Middle cooking area

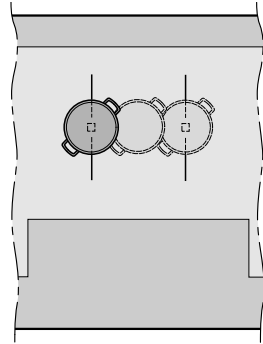

Cookware with a base diameter smaller than 16 cm.

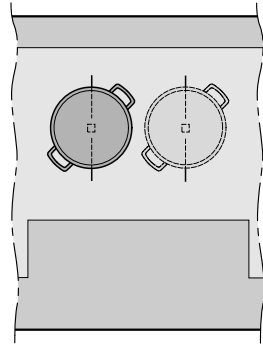

Cookware with a base diameter larger than 16 cm.

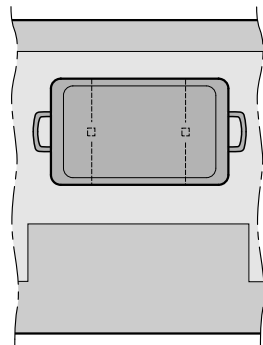

Cookware with a base diameter larger than 25 cm.

 Risk of fire with overheated food. Unattended food can overheat and catch alight. Do not leave the hob unattended whilst it is being used.

Please note that the heating up time on induction hobs is very much shorter than on conventional hobs.

Switching on the hob

- Touch the  sensor.

The touch display switches on.

If no further entry is made, the hob will switch itself off after 1 minute for safety reasons.

Setting the power level

- Place the cookware in the required position on the hob.
- Select Manual 1–9.
- Touch the required power level or swipe across the bar.

The selected power level, the settings range and the running time will be displayed.

The running time indicates how long the cooking zone has been in use for.

If you swipe across the running time display, it will be reset to 0.

Changing the power level

If you are cooking with several items of cookware at the same time and the display you want is not orange, you will have to select the display first.

- Touch the display of the desired cookware.
- Set the power level you want.

Switching off a cooking zone/ the hob

Switching off a cooking zone

- Touch and hold the cooking zone on the touch display until the zone switches off.

or

- Touch the cooking zone on the touch display.
- Set the power level to 0.

or

- Touch the cooking zone on the touch display.
- Touch the  symbol.

Switching the hob off

- To switch off the hob and all the cooking zones, touch the  sensor.

Operation

Residual heat indicator

If the cooking zone is still hot, the hob's residual heat indicator  will light up after it has been switched off.

The residual heat indicator remains on until the cooking zone is cool enough to touch.



Risk of burning due to hot ceramic surface.

The ceramic surface will be hot after use.

Do not touch the ceramic surface while the residual heat indicators are on.

TempControl

TempControl monitors and controls the temperature during frying:

- The fat cannot overheat.
- The power levels do not need to be adjusted manually.
- It is not necessary to turn the food being fried frequently.

Position the cookware centrally over the sensor.

TempControl is not suitable for deep fat frying and boiling.
Use this function for normal frying only.

Notes on use

- The temperature can be set between 140 and 230 °C.
- The cookware must be dry when it is placed on the hob.
- Do not use oil if it is already hot, discoloured or cloudy, or oil that contains particles of food.
- Only place food in the cookware when the audible signal has sounded. If any irregularity is detected, the appliance might not continue to heat up.
- Do not add any more oil once the pre-heating phase has started.
- Do not move the cookware to a different position after the pre-heating phase has started.

Operation

Activating TempControl

- Place the cookware in the required position on the hob.
- Place the required amount of oil or fat in the cookware.
- Select TempControl .
- Set the temperature.

An audible signal will sound when the set temperature is reached. The running time will start automatically.

- Place the food to be fried in the cookware.
- Switch the cooking zone off after use.

Changing the temperature

If you are cooking with several items of cookware at the same time and the display you want is not orange, you will have to select the display first.

- Touch the display of the desired cookware.
- Set the temperature.

TempControl cooking chart

Only food which doesn't have an assistance programme is listed. For a complete list of the assistance programmes, see "Operation – Assistant".

The temperatures given in the charts are guidelines only. We recommend selecting the lower temperature initially. You can cook for longer if necessary. The count-on timer only begins when the set temperature is reached.

Food	🌡️ [°C]
Frozen meat, e.g. Cordon bleu	150–170
Frozen spring rolls	
Frozen fish fingers	
Whole fish	
Kebabs	
Vegetables in butter (mushrooms, garlic)	
Schupfnudeln (potato noodles) in butter	
Potato pancakes	180–200
Meat loaf	
Tortilla	
Langos (Hungarian flatbread)	
Popcorn	
Frozen stir-fried dishes	
Dry-roasting seeds	
Caramel	200–220
Sliced meat	
Cooking with a wok	
Searing meat for stews (e.g. goulash)	200–220
Searing large quantities of meat	

🌡️ Temperature

Operation

Setting the power level – extended setting range

- Touch the numerical display in between two power levels.

The selected power level, the settings range and the running time will be displayed.

Example:

If you touch the numerical display between power levels 7 and 8, power level 7.5 will be selected.

The running time indicates how long the cooking zone has been in use for.

PowerFlex Plus cooking area

In a PowerFlex Plus cooking area, all induction coils (see “Induction – How it works”) are permanently combined. If pan recognition is activated (see “Settings ☞”), the cooking zones are automatically selected based on the size of the cookware placed on the hob. You can also select the cooking zones manually and change the shape and/or size.

Position the cookware centrally on the PowerFlex Plus cooking area.

Setting/changing cooking zones manually

- Touch a square area on the hob’s touch display.

The selected area is highlighted orange.

- Move your finger across the touch display to increase or decrease the size of the selected area.

You cannot change the shape or size of an activated cooking zone.

Booster function

When the Booster function is activated, the power is boosted so that large quantities can be heated up quickly, e.g. when boiling water for cooking pasta. The boost in power is active for a maximum of 15 minutes.

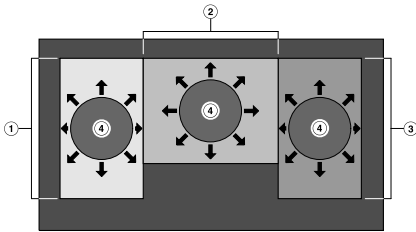

- ① PowerFlex Plus cooking area with TempControl
- ② PowerFlex Plus cooking area with TempControl
- ③ PowerFlex Plus cooking area with TempControl
- ④ Cookware with Booster function

The Booster function can be used on a maximum of 3 items of cookware at the same time:

- Once on the left side of the hob
- Once in the centre
- Once on the right side of the hob

If you activate the Booster function, the cooking area will automatically revert to power level 9 at the end of the booster time.

While the Booster is in operation, some of the power is taken away from the other induction coils. If another item of cookware is in use on the same side of the hob, it will be affected as follows:

- The power level is reduced.
- High power levels cannot be set.

The Booster and TempControl functions cannot be used together on the same side of the hob.

The Power Management settings (see “Induction – Power management”) affect the Booster function.

Operation

Activating the Booster

- Place the cookware in the required position on the hob.
- Select Manual 1–9.
- Touch the B symbol.

B, the settings range and the running time will be displayed.

The running time indicates how long the cooking zone has been in use for.

Deactivating the Booster

- Touch the ↶ symbol.
- or
- Set another power level.

Assistant

Your hob offers over 20 assistance programmes to help you cook dishes and food.

- Place the cookware on the cooking area you want to use.
- Select Assistant .
- Select the dish/food you want.

Information about the food or dish you have selected will appear on the touch display.

- Select Start.

An audible signal will sound when the set temperature is reached. The running time will start automatically. No more audible signals will sound.

The recipe suggests cooking durations.

Tip: You can set the cooking duration as a minute minder or an automatic switch-off time (see “Timer”) for the cooking zone.

- Follow the “Information” instructions.
- Switch the cooking zone off after use.

Accessing the Information display

You can access information regarding a current cooking process.

- Touch the  symbol in the cooking zone display.
- Touch Start to close the display.

Operation



Overview of assistance programmes

The cooking durations given in the charts are guidelines only. We recommend selecting the shorter duration initially. You can cook for longer if necessary. The count-on timer only begins when the set temperature is reached.

Food	🌡️ [°C]	⌚ [min]
Side dishes		
Fried potatoes	180–200	15–25 ¹
Croutons	200	4–6
Fish		
Plain fish fillet	180–200	5–15
Breaded fish fillet	180–200	5–15
Prawns	180–200	2–4
Snap cuisine		
French toast	180–200	6–10
Curry	200–210	10–20 ²
Croque monsieur	180–200	6–10
Stir-fried dishes	200	3–10
Eggs		
Omelette	160–180	3–6
Fried egg	160–180	5–10
Scrambled egg	160	2–6
Meat		
Bolognese sauce	180–220	30–90 ³
Meat patties	160–180	10–20
Pan fried chicken breast	180–220	10–20
Escalopes	180–200	5–10
Steak rare, 3 cm thick	200	5–7
Steak medium, 3 cm thick	200	6–10
Steak well done, 3 cm thick	160	15–25
Sausages	180	5–15

Operation

Bacon	160–180	8–11
Lamb chops	180–220	5–10
Pork chops	180–200	6–10
Sweets		
Pancakes	160–180	4–8
Crêpes	200	2–3

 Temperature,  Duration

¹ The indicated frying time refers to parboiled potatoes.

If the potatoes have not been parboiled and have been cut into cubes or slices, the frying time will be 15–35 minutes.

² After frying the ingredients, add the liquid and bring to the boil.

The cooking duration refers to the time after the liquid has been brought to the boil.

³ After frying the ingredients, add the remaining ingredients and bring to the boil.

The cooking duration refers to the time after the remaining ingredients have been brought to the boil.

Timer

The hob has to be switched on if you want to use the timer.

The timer can be used for the following 2 functions:

- For setting the minute minder
- For automatically switching off the heat for an item of cookware

You can use the functions simultaneously.

A duration of between 1 minute (0:00:01) and 9 hours 59 minutes and 59 seconds (9:59:59) can be set.

Minute minder



Setting the minute minder

- Open the pull-down menu.
- Select .
- 0:00:00 (hours:minutes:seconds) will appear on the touch display.
- Touch 0 (hours) or 00 (minutes or seconds).
- Set the time you want using the - or + sensor controls.
- Touch OK to confirm.

Changing the minute minder duration

- Select .
- Touch the value you wish to change.
- Set the time you want using the - or + sensor controls.
- Touch OK to confirm.

Deleting the minute minder duration

- Select .
- Select .
- Touch OK to confirm.

Auto switch off

You can set a time after which a cooking zone will switch off automatically. This function can be used for all cooking zones at the same time.

If the time programmed is longer than the maximum operating time allowed, the cooking zone will be switched off by the safety switch-off function (see "Safety features – Safety switch-off").

Setting the switch-off time

- Select a power level or temperature for the cooking zone you require.

- Select .



00:00:00 (hours:minutes:seconds) will appear on the touch display.

- Touch 0 (hours) or 00 (minutes or seconds).
- Set the time you want using the - or + sensor controls.
- Touch OK to confirm.
- If you want to set another cooking zone to switch off automatically, follow the same steps as described above.

Changing the switch-off time

- Select .
- Touch the value you wish to change.
- Set the time you want using the - or + sensor controls.
- Touch OK to confirm.

Deleting the switch-off time

- Select .
- Select .
- Touch OK to confirm.

The running time will no longer be visible once you have deleted the time.

Additional functions

Stop & Go

This function can only be used if the Manual 1–9 function is being used for all cookware. When Stop & Go is activated, all power levels are reduced to 1. The power levels and the timer settings cannot be altered; the hob can only be switched off. The minute minder time, switch-off times and Booster durations are all halted.

When the function is deactivated, the hob switches back to the power level that was set last and the times continue.

Activating/Deactivating

If the function is not deactivated within 30 minutes, the hob will switch off.

- Open the pull-down menu.
- Touch the **II/▶** symbol for approx. 1 second.

Recall

If the hob is switched off by mistake during use, this function can be used to reset all settings. For this to work, the hob must be switched on again within 10 seconds of being switched off.

- Switch the hob on again.
- Select **Yes**.

Wipe protection

The hob touch display can be locked for 20 seconds in order, for example, to remove soiling. The  sensor control is not locked.

Activating

- Open the pull-down menu.
- Touch the  symbol.

The time counts down under the  symbol.



Deactivating

- Open the pull-down menu.
- Touch the  symbol.

Demo mode



This function enables the hob to be demonstrated in showrooms without heating up.

Activating

- Call up the settings menu  (see “Settings ”).
- Touch Demo mode | On.

DEMO appears in the centre of the touch display.



Deactivating

- Call up the settings menu  (see “Settings ”).
- Touch Demo mode | Off.

DEMO disappears from the touch display.

Displaying hob data

The model designation, serial number and software version of the hob can be displayed.

- Call up the settings menu  (see “Settings ”).
- Touch Software version.

The hob data is shown on the touch display.

Safety features

System lock

Your hob is equipped with a system lock to prevent it being switched on by mistake. The system lock can only be activated when the cooking zones are all switched off.

Activating/deactivating the system lock

- Switch the hob on.
- Open the pull-down menu.
- Touch the  symbol for 3 seconds.

Safety switch-off

Touch display is covered

Your hob will turn off automatically if the touch display remains covered for longer than 10 seconds, for example, by finger contact, food boiling over or by an object such as an oven glove or tea towel. The touch display indicates the fault message F6716 and an audible signal sounds.

Remove the object and/or clean the hob and press OK; the hob will then be ready to use again.

Excessive operating time

The safety shut-off is triggered automatically if a zone is heated for an unusually long period of time. This time depends on the power level selected. If it has been exceeded, the heat switches off and the residual heat indicator appears. A power level can be selected in the usual way.

Power level*	Maximum operating time [h]
1/1.	9
2/2.	8
3/3.	7
4/4.	6
5/5.	5
6/6.	4
7/7.	3
8/8.	2
9	1

* The power levels with a dot after the number are only available if the power level range has been extended (see "Setting ranges").

Overheating protection

If the base of the cookware overheats, the power level is automatically reduced. The display does not alter. The power level resumes a normal level once the cookware has cooled down.

Settings

You can use the Settings  menu to customise the hob to suit your requirements.

Calling up Settings

Settings cannot be changed while a cooking process is in progress.

- Switch the hob on.
- Open the pull-down menu.
- Select Settings .

Changing Settings

- Select the menu option you want.

The current setting is highlighted orange.

- Select the option you want.
- Touch OK to confirm.

If you wish to leave a menu option without making a change, touch Settings.

Settings overview

Menu option	Available settings
Display brightness	1–5
Language 	.../deutsch/english/...
Permanent pan recognition	On*
	Off
Recall function	On*
	Off
Buzzer tones	On*
	Off
Power Management	10,800 W*
	7200 W
Power settings	without intermediate levels (1, 2, 3 etc.)*
	with intermediate levels (1, 1.5, 2, 2.5, 3 etc.)
Duration	On*
	Off
Assistant	On*
	Off
Factory default settings	Yes
	No
Software version	
Miele@home	See “Before using for the first time – Setting up Miele@home and Setting up Con@ctivity”
Demo mode	On
	Off*

* Factory setting

Note for test institutes

Test food acc. to EN 60350-2

9 power levels are programmed at the factory.

For testing in accordance with the above standard, programme the hob to the extended power level setting.

Safety notes on cleaning and care

 Risk of burns due to hot surfaces.

All parts of the hob may be hot after use.

Switch the hob off.

Allow the hob to cool down before cleaning it.

All surfaces could be discoloured or damaged if unsuitable cleaning agents are used or if residues from suitable cleaning agents are heated on the hob. All surfaces are susceptible to scratching.

Allow the surfaces to cool down before cleaning the hob.

Remove all cleaning agent residues immediately.

Never use abrasive sponges or cleaning agents.

- ▶ Do not use a steam cleaner to clean the hob.
- ▶ Do not use pointed objects for cleaning.

Cleaning and care

When to clean

- Clean the hob after every use.

Removing light soiling

- Clean the entire ceramic surface of the hob with a damp, soft cloth and a solution of water and a little washing-up liquid. Please follow the cleaning agent manufacturer's instructions.

Removing stubborn soiling

- Remove any coarse soiling with a damp cloth and more stubborn soiling with a scraper suitable for use on glass.
- Clean the glass ceramic surface with the Miele ceramic and stainless steel cleaner (see "Optional accessories – Cleaning and care products") or with a proprietary ceramic glass cleaner. Please follow the cleaning agent manufacturer's instructions.

Finishing the cleaning process

- Remove all cleaning agent residues with a damp cleaning cloth.
- Dry the ceramic surface of the hob after cleaning.

Unsuitable cleaning agents

To avoid damaging the surfaces of the appliance, do not use:

- Cleaning agents containing soda, alkalines, ammonia, acids or chlorides
- Stain and rust removers
- Abrasive cleaning agents, e.g. powder cleaners and cream cleaners
- Cleaning agents containing solvents
- Dishwasher cleaning agents
- Grill and oven sprays
- Hard, abrasive brushes
- Eraser stain remover blocks
- Sponges

Many malfunctions and faults that can occur in daily operation can be easily remedied. You can save time and money in many cases, as you do not need to call the Miele Customer Service Department.

Information to help you rectify faults yourself can be found at www.miele.com/service.



The following tables are designed to help you to find the cause of a malfunction or a fault and to resolve it.

Messages in the display

Problem	Cause and remedy
The touch display indicates F6713 or F6771 and the hob switches off automatically.	<p>Empty cookware has been heated.</p> <ul style="list-style-type: none"> ■ Touch OK. ■ Wait until the residual heat indicator  goes out (see “Operation – Residual heat indicator”). ■ Make sure that you have placed ingredients in the cookware.
The touch display indicates F6734 and the hob switches off automatically.	<p>The cookware is incorrectly positioned.</p> <ul style="list-style-type: none"> ■ Position the cookware correctly (see “Operation – Positioning cookware”). ■ Touch OK.
The touch display indicates F6716 and the hob switches off automatically.	<p>The touch display is covered, e.g. by finger contact, food boiling over or an object.</p> <ul style="list-style-type: none"> ■ Clean off any soiling and/or remove the object (see “Safety features – Safety switch-off”). ■ Touch OK.
The touch display indicates F6704 and the hob switches off automatically.	<p>The vents used to cool the hob are blocked.</p> <ul style="list-style-type: none"> ■ Remove anything that may be blocking the vents. ■ Touch OK.
A message not listed in this table is appearing in the display.	<p>There is an electronic module fault.</p> <ul style="list-style-type: none"> ■ Disconnect the power supply to the hob for approx. 1 minute. ■ If the problem persists after the power supply has been restored, please contact the Customer Service Department.

Problem solving guide

Unexpected behaviour

Problem	Cause and remedy
- - - flashes in a display.	There is no cookware on the cooking area, or the cookware is unsuitable. ■ Use suitable cookware (see “Induction – Cookware”).
	The cookware is not positioned correctly. ■ Re-position the cookware.
	Metal objects such as cutlery are on the cooking area. ■ Remove any obstruction.
The touch display is not reacting.	Your fingertips are covered. ■ Touch the display with bare fingers only.
	Wipe protection  has been activated. ■ Deactivate wipe protection (see “Additional functions – Wipe protection  ”).
	You touched the display whilst holding an item of cookware. ■ Only touch the display when both of your hands are free.
	The touch display is dirty. ■ Remove any soiling.
The symbols react when an adjacent area is touched.	Water or liquid has accumulated on the touch display. ■ Dry the touch display.
The power level is reduced automatically or cannot be increased.	2 items of cookware are being used on one cooking area at the same time (see “Induction – Power management”).
A zone switches itself off automatically.	It has been operated for too long. ■ Switch a power level back on again (see “Safety switch off” in the “Safety features” chapter).
An area is not working in the usual way on the power level selected.	The overheating protection mechanism has been activated. ■ If the base of the cookware overheats, the power level is automatically reduced. The display does not alter. The power level resumes a normal level once the cookware has cooled down.

Problem solving guide

Problem	Cause and remedy
A zone or the whole hob switches off automatically.	The overheating protection mechanism has been activated. ■ See “Overheating protection” in the “Safety features” chapter.

Problem solving guide

Unsatisfactory results

Problem	Cause and remedy
The heating-up time is unusually long.	The pan is not positioned correctly. ■ Reposition the pan (see “Operation”, “Positioning cookware”).
	The base of the pan or the ceramic surface is dirty. ■ Remove any soiling.
	You added water, oil or food during the heating-up phase. ■ Do not add anything during the heating-up phase.
In comparable cooking and frying processes there are slight differences in cooking durations and browning.	This is not a fault. The pan base material and the positions of the pans on the hob affect the power of the induction coils. This in turn affects the cooking behaviour.

General problems or technical faults

Problem	Cause and remedy
<p>The hob cannot be switched on.</p>	<p>There is no power to the hob.</p> <ul style="list-style-type: none"> ■ Check whether the circuit breaker has tripped. Contact a qualified electrician or the Miele Customer Service Department (for the minimum fuse rating, see data plate). <p>There may be a technical fault.</p> <ul style="list-style-type: none"> ■ Disconnect the hob from the electricity supply for approx. 1 minute. To do this: <ul style="list-style-type: none"> – Trip the relevant mains fuse or screw the fine-wire fuse out completely, or – Switch off at the residual current device ■ If the hob will still not turn on after resetting the trip switch in the fuse box or the residual current device, contact a qualified electrician or the Miele Customer Service Department.
<p>The cooking area does not heat up.</p>	<p>The cooking area is still hot from a previous cooking process. It will heat up once the cooking area has cooled down sufficiently.</p>
<p>A smell and vapours are given off when the new appliance is being used.</p>	<p>The metal components have a protective coating. When the appliance is used for the first time, this causes a smell and possibly also vapour. The material from which the induction coils are made also gives off a smell in the first few hours of operation. With each subsequent use, the odour is reduced until it disappears completely. The smell and any vapours given off do not indicate a faulty connection or appliance and they are not hazardous to health.</p>
<p>An operating noise can be heard after the appliance has been switched off.</p>	<p>The cooling fan runs until the hob has cooled down and then switches off automatically.</p>

Optional accessories

Miele offer a comprehensive range of useful accessories as well as cleaning and conditioning products for your Miele appliances.

These products can be ordered through the Miele Webshop.

They can also be ordered from Miele (see end of this booklet for contact details) or from your Miele dealer.

Cookware

Miele offers a wide range of cookware. These have all been optimised for Miele appliances in terms of functionality and dimensions. Detailed information is provided on the Miele website.

Cleaning and care products

Ceramic and stainless steel hob cleaner 250 ml



Removes heavy soiling, limescale deposits and aluminium residues

Microfibre cloth

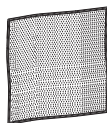

Removes finger marks and light soiling

Information to help you rectify faults yourself and about Miele spare parts can be found at www.miele.com/service.

Contact in the event of a fault

In the event of any faults which you cannot remedy yourself, please contact your Miele dealer or the Miele Customer Service Department.

You can book a Miele Customer Service Department call-out online at www.miele.com/service.

Contact information for the Miele Customer Service Department can be found at the end of this document.

Please quote the model identifier and serial number of your appliance (Fabr./SN/ Nr.) when contacting the Miele Customer Service Department. This information can be found on the data plate.

Please note that telephone calls may be monitored and recorded for training purposes and that a call-out charge will be applied to service visits where the problem could have been resolved as described in this booklet.

Warranty

For information on the appliance warranty specific to your country please contact Miele. See back cover for address.

In the UK, your appliance warranty is valid for 2 years from the date of purchase. However, you must activate your cover by calling 0330 160 6640 or registering online at www.miele.co.uk.

Installation

Safety instructions for installation

 Risk of damage from incorrect connection.
Incorrect installation can cause damage to the hob.
The hob must only be installed by a qualified person.

 Risk of electric shock from mains voltage.
Incorrect connection to the mains supply may result in an electric shock.
The hob must be connected to the electrical supply by a qualified electrician only.

 Damage from falling objects.
Take care not to damage the hob when fitting wall units or a cooker hood above it.
Fit the wall units and the cooker hood before the hob.

- ▶ The veneer or laminate coatings of worktops (or adjacent kitchen units) must be treated with 100 °C heat-resistant adhesive which will not dissolve or distort. Any backmoulds must be of heat-resistant material.
- ▶ The hob must not be installed over a fridge, fridge-freezer, freezer, dishwasher, washing machine, washer-dryer or tumble dryer.
- ▶ After installation, ensure that nothing can come into contact with the connection cable and that it is without hindrance.
- ▶ The electrical cable may not come into contact with any moving kitchen component (e.g. a drawer) or be subject to mechanical obstruction which could damage it.
- ▶ Observe the safety clearances listed on the following pages carefully.

Safety distances

Safety distance above the hob

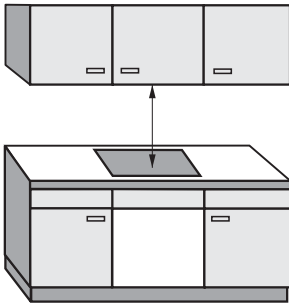

The safety distance specified by the manufacturer of the cooker hood must be maintained between the hob and the cooker hood above it.

If combustible objects are installed above the hob (e.g., cabinets, utensil rail, etc.), a minimum safety distance of 500 mm must be maintained.

When two or more appliances which have different safety distances are installed together below a cooker hood, you should observe the greatest specified safety distance.

Minimum safety distance underneath the hob

To ensure sufficient ventilation to the hob, a minimum safety distance must be left between the underside of the hob and any oven, intermediate shelf or drawer.

The minimum safety distance between the underside¹ of the hob and

- Upper edge of oven: ≥ 25 mm
- Upper edge of intermediate shelf: ≥ 25 mm
- Upper edge of drawer: ≥ 5 mm
- Base of drawer: ≥ 75 mm

¹ The underside is the outside of the hob casing. Other items that are attached lower down, such as connection boxes and shims, do not count as the lowest point and are not relevant when calculating the minimum safety distance.

Installation

Intermediate shelf

It is not necessary to fit an intermediate shelf underneath the hob, but one may be fitted if you wish.

Side view

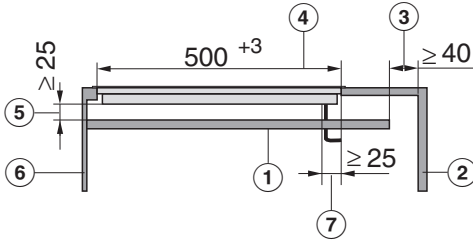

- ① Intermediate shelf
- ② Rear wall
- ③ Minimum safety distance between the rear edge of the intermediate shelf and the rear wall to ensure sufficient ventilation to the hob
- ④ Worktop cut-out
- ⑤ Minimum safety distance between the bottom of the hob and the top of the intermediate shelf to ensure sufficient ventilation to the hob
- ⑥ Front
- ⑦ Cut-out for routing the power cable
Minimum safety distance between the rear edge of the worktop cut-out and the edge of the cut-out

View from above

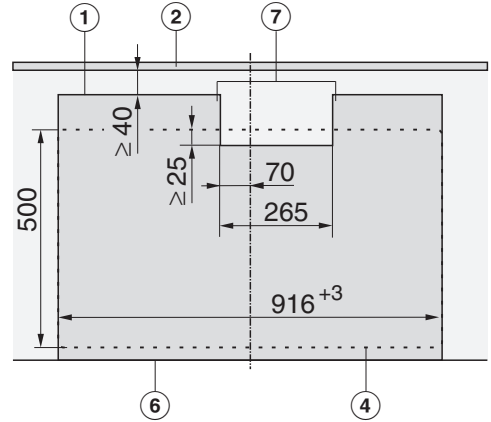

- ① Intermediate shelf
- ② Rear wall
- ④ Worktop cut-out
- ⑥ Front
- ⑦ Cut-out for routing the power cable
Minimum safety distance between the rear edge of the worktop cut-out and the edge of the cut-out

Safety distances to the sides and back of the appliance

It is advisable to install the hob with plenty of space either side of it.

The minimum distance ① shown below must be maintained between the back of the hob and a tall unit or wall.

The minimum distance ②, ③ shown below must be maintained between a tall unit or a wall to the left or right of the hob with a minimum distance of 200 mm on the opposite side.

① Minimum distance between the **back** of the worktop cut-out and the rear edge of the worktop:

50 mm

② Minimum distance between the worktop cut-out and a wall or tall unit to the **right** of it:

50 mm.

③ Minimum distance between the worktop cut-out and a wall or tall unit to the **left** of it:

50 mm.

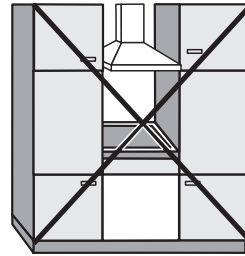

Not allowed

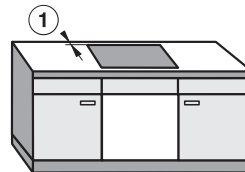

Highly recommended

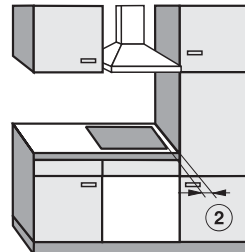

Not recommended

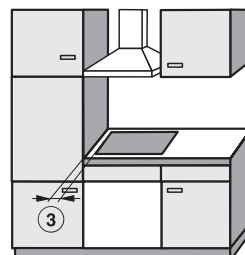

Not recommended

Installation

Safety distance to niche cladding

If niche cladding is installed, a minimum safety distance must be maintained between the worktop cut-out and the cladding, since high temperatures can alter or damage these materials.

If the niche cladding is made from a combustible material (e.g. wood), a minimum safety distance ⑤ of 50 mm must be maintained between the worktop cut-out and the cladding.

If the niche cladding is made from a non-combustible material (e.g. metal, natural stone, ceramic tiles), the minimum safety distance ⑤ between the worktop cut-out and the cladding will be 50 mm minus the thickness of the cladding.

Example: 15 mm thick niche cladding

$50 \text{ mm} - 15 \text{ mm} = \text{minimum safety distance of } 35 \text{ mm}$

Flush-fit installation

Surface-mounted installation

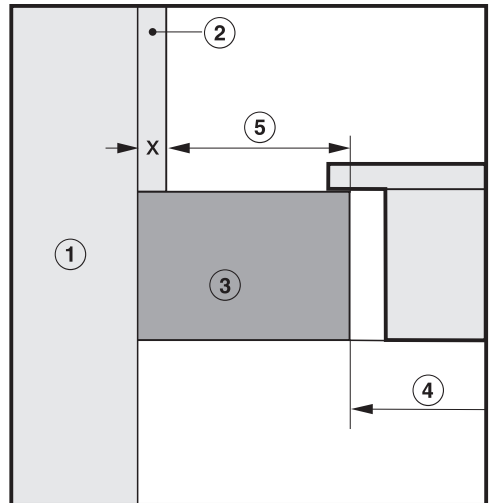
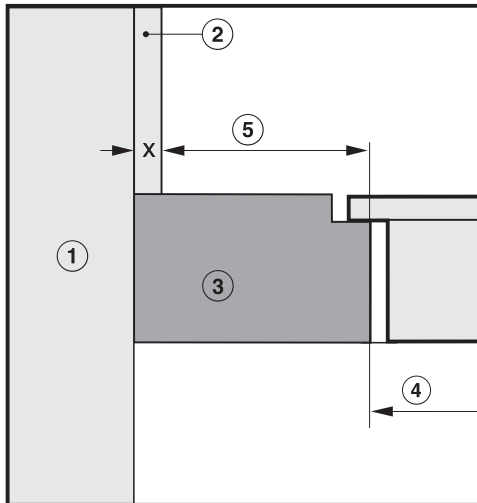

- ① Masonry
- ② Niche cladding dimension x = thickness of the niche cladding material
- ③ Worktop
- ④ Worktop cut-out
- ⑤ Minimum safety distance to
combustible materials 50 mm
non-combustible materials $50 \text{ mm} - \text{dimension } x$

Installation notes – surface-mounted

Seal between the hob and the worktop

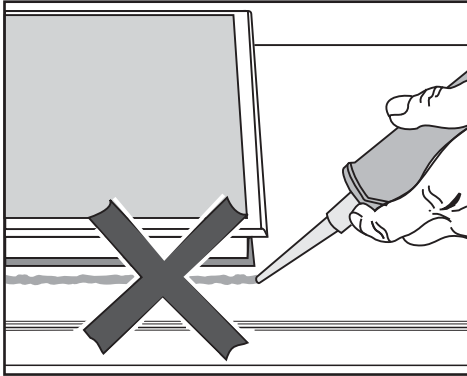

 Damage caused by incorrect installation.

Using sealant under the hob could result in damage to the hob and the worktop if the hob ever needs to be removed for servicing.

Do not use sealant between the hob and the worktop.

The sealing strip under the edge of the hob provides a sufficient seal for the worktop.

Tiled worktops

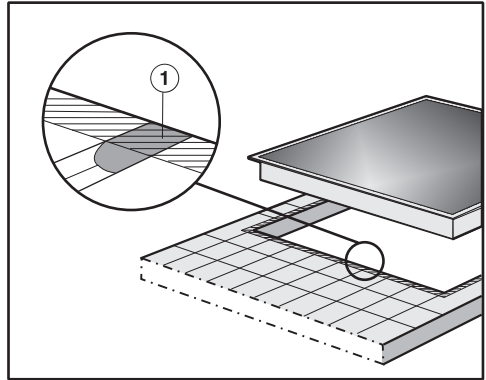

Grout lines ① and the hatched area underneath the hob frame must be smooth and even. If they are not the hob will not sit flush with the worktop and the sealing strip underneath the hob will not provide a good seal between the hob and the worktop.

Sealing strip

Dismantling the hob for service purposes may damage the sealing strip underneath the edge of the hob.

Always replace the sealing strip before reinstalling the hob.

Installation

Installation dimensions – Surface-mounted

All dimensions are given in mm.

Installation dimensions – KM 7999 FR

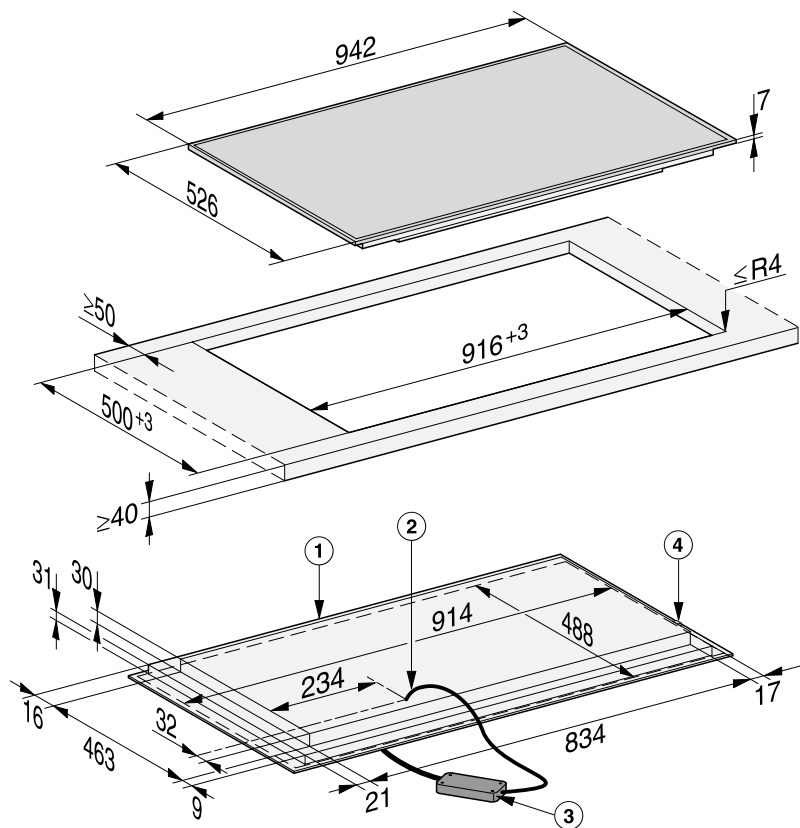

- ① Front
- ② Connection cable, L = 1070 mm
- ③ Mains connection box with mains connection cable
Mains connection cable and mains connection box L = 680 mm
- ④ WiFi stick connection

Installation dimensions – KM 7999 FL

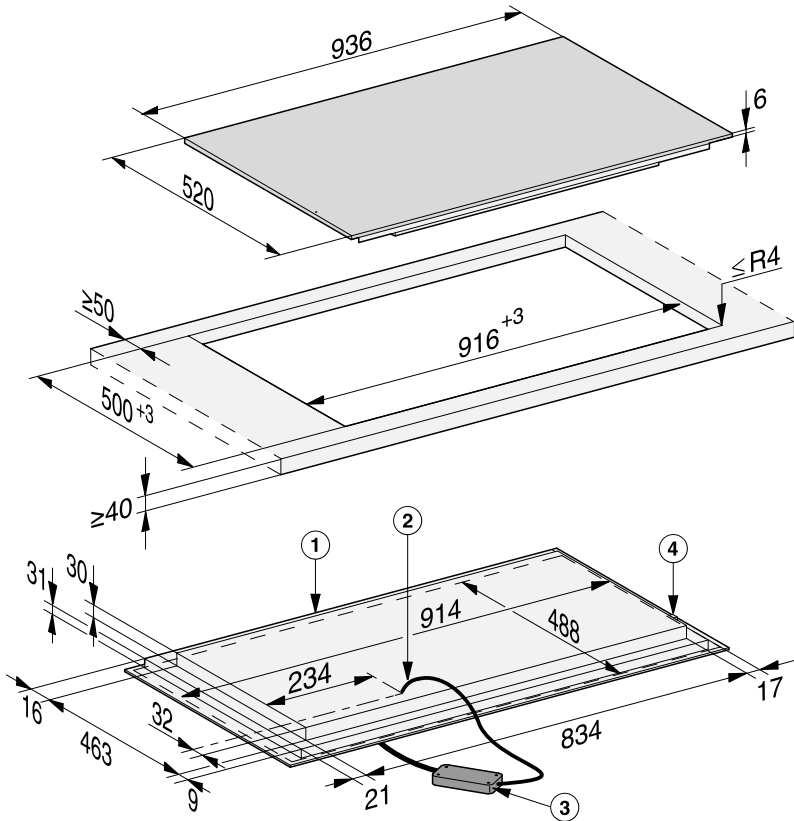

- ① Front
- ② Connection cable, L = 1070 mm
- ③ Mains connection box with mains connection cable
Mains connection cable and mains connection box L = 680 mm
- ④ WiFi stick connection

Installation

Surface-mounted installation

- Create the worktop cut-out. Remember to maintain the minimum safety distances (see “Installation – Safety distances”).
- Seal any cut surfaces on **wooden worktops** with a special varnish, silicone sealant or resin to prevent the wood from swelling as a result of moisture ingress. The sealant must be heat-resistant.

Make sure that the sealant does not come into contact with the top of the worktop.

- Stick the supplied sealing strip under the edge of the hob. Do not apply the sealing strip under tension.
- Feed the mains connection cable down through the cut-out in the hob.
- Place the hob centrally in the cut-out. When doing this, make sure that the seal of the appliance sits flush with the worktop on all sides. This is important to ensure an effective seal all round.

Do not use any additional sealant (e.g. silicone) on the hob.

If the seal does not sit flush with the worktop in the corners, the corner radius ($\leq R4$) can be carefully cut to fit using a jigsaw.

- Connect the hob to the power supply.
- Check that the hob works.

Installation notes – flush-fit

A flush-fit hob is suitable only for installation in natural stone (granite, marble), solid wood and tiled worktops. Certain models are also suitable for building into glass worktops – these are marked with an appropriate note in “Installation – Installation dimensions – flush-fit”. When using a worktop made from any other material, please check first with the worktop manufacturer that it is suitable for installing a flush-fit hob.

The internal width of the base unit underneath the appliance must be at least as wide as the inner worktop cut-out (see “Installation – Installation dimensions – flush fit”), so that the hob is easily accessible from underneath after installation and the casing can be removed for maintenance. If the underside of the hob is not freely accessible after installation, any sealant used must be removed to enable the hob to be lifted out of the cut-out should this be necessary.

Natural stone worktops

The hob is set directly in the cut-out.

Solid wood worktops, tiled worktops, glass worktops

The hob is secured inside the cut-out with wooden battens. The battens must be provided on site, and are not supplied with the appliance.

Sealing strip

Dismantling the hob for service purposes may damage the sealing strip underneath the edge of the hob.

Always replace the sealing strip before reinstalling the hob.

Installation

Installation dimensions – Flush-fit

All dimensions are given in mm.

Installation dimensions – KM 7999 FL

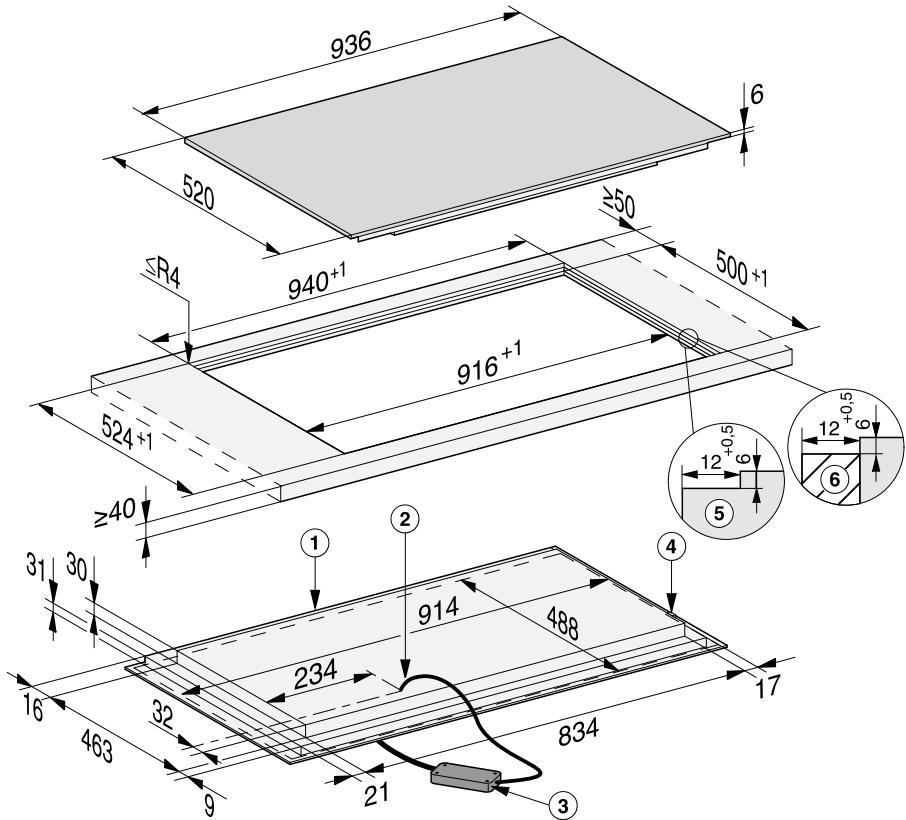

- ① Front
- ② Connection cable, L = 1070 mm
- ③ Mains connection box with mains connection cable
Mains connection cable and mains connection box L = 680 mm
- ④ Stepped cut-out, natural stone worktop
- ⑤ Wooden batten 12 mm (not supplied)
- ⑥ WiFi stick connection

Flush-fit installation

- Create the worktop cut-out. Remember to maintain the minimum safety distances (see "Safety distances").
- Solid wood, tiled and glass worktops: Fix a wooden frame 6 mm below the top edge of the worktop (see building-in diagram for "Flush-fit installation").
- Stick the supplied sealing strip under the edge of the hob. Do not apply the sealing strip under tension.
- Feed the mains connection cable for the hob down through the worktop cut-out.
- Centre the hob in the cut-out.

The gap between the ceramic glass surface and the worktop must be at least 2 mm wide. This is required so that the hob can be sealed.

- Connect the hob to the power supply.
- Check that the hob works.
- Seal the gap between the hob and worktop with a silicone sealant that is heat-resistant to at least 160 °C.

 **Damage from unsuitable sealant.**
Unsuitable sealant can damage natural stone.
For natural stone worktops and natural stone tiles, only use silicone sealant that is specially formulated for natural stone. Follow the manufacturer's instructions.

Installation

Electrical connection

 Risk of damage from incorrect connection.

Unauthorised installation, maintenance and repairs can cause considerable danger for the user.

Miele cannot be held liable for damage or injury caused by unauthorised installation, maintenance or repair work, or by an inadequate or faulty on-site earthing system (e.g. electric shock).

This hob must be connected to the electrical supply by a qualified electrician.

The electrician must be familiar with and comply with the national regulations and any additional regulations of the local electricity provider (e.g. BS 7671 in the UK).

After installation, ensure that all electrical components are shielded and cannot be accessed by users.

Total power rating

See data plate

Connection data

The connection data is quoted on the data plate. Please ensure these match the household mains supply.

Please see wiring diagrams for connection. (N.B. This appliance is supplied single phase only in the UK / AUS / NZ).

Residual current device

For extra safety, it is advisable to protect the appliance with a suitable residual current device (RCD) with a trip range of 30 mA.

WARNING

THIS APPLIANCE MUST BE EARTHED

Disconnecting devices

It must be possible to disconnect the hob from the mains at all poles using disconnecting devices. A contact distance of at least 3 mm must be observed in the switched-off state. The disconnecting devices are overcurrent protection devices and residual current protection devices.

Disconnecting from the mains

The hob connection should be easily accessible at all times to allow customer service and repair work to be carried out.

Some connection methods are not permitted in all installation locations. Ensure compliance with national regulations and any additional regulations issued by the local electricity provider.

Wiring diagram

220-240 V ~

Yellow/Green — 
Gelb/Grün, Jaune/Vert

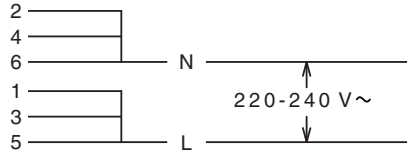

380-415 V 3N~

Yellow/Green — 
Gelb/Grün, Jaune/Vert

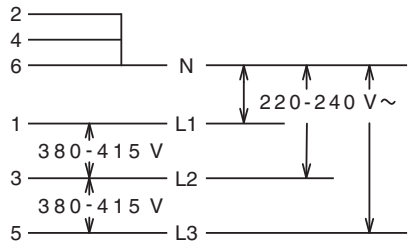

Product data sheets

The following data sheets apply to the models described in this operating instruction manual.

Information for domestic electric hobs

In acc. with regulation (EU) No. 66/2014

MIELE	
Model name/identifier	KM 7999
Number of cooking zones and/or areas	
For circular cooking zones: diameter of useful surface area/cooking zone For non-circular cooking zones or areas: length and width of useful surface area per electric cooking zone or area	1. = 2. = 3. = 4. = 5. = 6. =
Energy consumption per cooking zone or area calculated per kg ($EC_{\text{electric cooking}}$)	1. = 189,0 Wh/kg 2. = 191,7 Wh/kg 3. = 191,9 Wh/kg
Energy consumption for the hob calculated per kg ($EC_{\text{electric hob}}$)	190,9 Wh/kg

EU Conformity declaration

Miele hereby declares that this ceramic induction hob complies with Directive 2014/53/EU.

The complete text of the EU declaration of conformity is available from one of the following internet addresses:

- Products, Download from www.miele.ie
- For service, information, operating instructions etc: go to <https://miele.co.uk/manuals> and enter the name of the product or the serial number

Frequency band of the WiFi module	2.4000 GHz – 2.4835 GHz
-----------------------------------	-------------------------

Maximum transmitting power of the WiFi module	< 100 mW
---	----------

UK Conformity declaration

Miele hereby declares that this ceramic induction hob complies with UK Radio Equipment Regulations 2017, as amended.

The complete text of the UK declaration of conformity is available from one of the following internet addresses:

- Products, Download from www.miele.co.uk
- For service, information, operating instructions etc: go to <https://miele.co.uk/manuals> and enter the name of the product or the serial number

Frequency band of the WiFi module 2.4000 GHz – 2.4835 GHz

Maximum transmitting power of the WiFi module < 100 mW

This **Statement of Compliance** confirms this Miele product fully complies with the **Product Security and Telecommunications Infrastructure (Security Requirements for Relevant Connectable Products) Regulations 2023**.

- 1) Household Appliance – *Induction hobs KM 7999*
- 2) Manufactured by: Miele & Cie KG,
Carl Miele Street 29, 33332 Gutersloh Germany
Imported by and contact point: Miele Company Ltd, Fairacres, Marcham Road, Abingdon, Oxon, OX14 1TW Great Britain
- 3) The defined support period at the time of first supply is 10 years
- 4) To report vulnerabilities and cybersecurity issues please contact: psirt@miele.com
- 5) Signature 
Name: **Paul Wright**
Company Position: **Head of Technical Management**
Date of signature: **19th March 2024**
Place of signature: **Abingdon, Oxfordshire**

United Kingdom

Miele Co. Ltd., Fairacres, Marcham Road, Abingdon, Oxon, OX14 1TW
Tel: 0330 160 6600, Internet: www.miele.co.uk, E-mail: info@miele.co.uk

Australia

Miele Australia Pty. Ltd.
ACN 005 635 398
ABN 96 005 635 398
Level 4, 141 Camberwell Road
Hawthorn East, VIC 3123
Tel: 1300 464 353
E-mail: info@miele.com.au
Internet: www.miele.com.au

China Mainland

Miele Electrical Appliances Co., Ltd.
1-3 Floor, No. 82 Shi Men Yi Road
Jing' an District
200040 Shanghai, PRC
Tel: +86 21 6157 3500
Fax: +86 21 6157 3511
E-mail: info@miele.cn
Internet: www.miele.cn

Hong Kong, China

Miele (Hong Kong) Ltd.
41/F - 4101, Manhattan Place
23 Wang Tai Road
Kowloon Bay, Hong Kong
Tel: (852) 2610 1025
Fax: (852) 3579 1404
E-mail:
customerservices@miele.com.hk
Website: www.miele.hk

India

Miele India Pvt. Ltd.
1st Floor, Copia Corporate Suites,
Commercial Plot 9, Mathura Road,
Jasola, New Delhi - 110025
E-mail: customercare@miele.in
Website: www.miele.in

Ireland

Miele Ireland Ltd.
2024 Bianconi Avenue
Citywest Business Campus
Dublin 24
Tel: (01) 461 07 10
Fax: (01) 461 07 97
E-mail: info@miele.ie
Internet: www.miele.ie

Malaysia

Miele Sdn Bhd
Suite 12-2, Level 12
Menara Sapura Kencana
Petroleum
Solaris Dutamas No. 1
Jalan Dutamas 1
50480 Kuala Lumpur, Malaysia
Phone: +603-6209-0288
Fax: +603-6205-3768

New Zealand

Miele New Zealand Limited
IRD 98 463 631
8 College Hill
Freemans Bay, Auckland 1011
Tel: 0800 464 353
E-mail: customercare@miele.co.nz
Internet: www.miele.co.nz

Singapore

Miele Pte. Ltd.
29 Media Circle
#11-04 ALICE@Mediapolis
Singapore 138565
Tel: +65 6735 1191
Fax: +65 6735 1161
E-mail: info@miele.com.sg
Internet: www.miele.sg

South Africa

Miele (Pty) Ltd.
63 Peter Place, Bryanston 2194
P.O. Box 69434, Bryanston 2021
Tel: (011) 875 9000
Fax: (011) 875 9035
E-mail: info@miele.co.za
Internet: www.miele.co.za

Thailand

Miele Appliances Ltd.
BHIRAJ TOWER at EmQuartier
43rd Floor Unit 4301-4303
689 Sukhumvit Road
North Klongton Sub-District
Vadhana District
Bangkok 10110, Thailand

United Arab Emirates

Miele Appliances Ltd.
Showroom 1, Eiffel 1 Building
Sheikh Zayed Road, Umm Al Sheif
P.O. Box 114782 - Dubai
Tel. +971 4 3044 999
Fax. +971 4 3418 852
800-MIELE (64353)
E-mail: info@miele.ae
Website: www.miele.ae

Manufacturer: Miele & Cie. KG, Carl-Miele-Straße 29, 33332 Gütersloh, Germany

KM 7999 FR, KM 7999 FL

en-GB

M.-Nr. 11 345 792 / 00