

## Operating and installation instructions Downdraft extractor

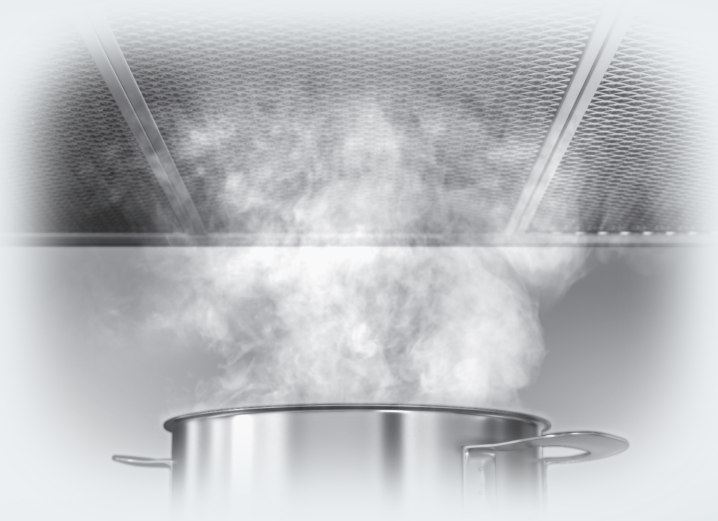

To prevent the risk of accidents or damage to the appliance, it is **es-  
sential** to read these instructions before it is installed and used for the  
first time.

# Contents

---

<b>Warnings and safety notes</b> .....	<b>4</b>
<b>Sustainability and environmental protection</b> .....	<b>11</b>
<b>Familiarisation</b> .....	<b>12</b>
Cooker hood overview .....	12
Components .....	13
Grease filters and panel .....	13
Charcoal filter .....	13
Hob lighting .....	13
Ambient lighting .....	14
Functions .....	14
Fan power levels .....	14
Run-on function .....	14
Reduced extraction height .....	15
Operating hours counter .....	15
Networking .....	15
Adaptive Con@ctivity .....	16
Power management .....	16
<b>Commissioning</b> .....	<b>17</b>
Selecting extraction mode or recirculation mode .....	17
Networking .....	18
Requirements for networking .....	18
Performing Scan & Connect .....	18
Signing off WiFi and remote control .....	18
Setting up Con@ctivity .....	19
Activating Con@ctivity 3.0 via the home WiFi network .....	19
Activating Con@ctivity 3.0 via a direct WiFi connection .....	19
Signing on the remote control .....	20
Signing off the remote control .....	20
<b>Operation</b> .....	<b>21</b>
Switching on the fan .....	21
Selecting the power level .....	21
Selecting the run-on time .....	21
Switching the fan off .....	21
Run-on in Plug&Play operation .....	21
Switching on the hob lighting .....	22
Dimming the hob lighting .....	22
Switching the hob lighting off .....	22
Switching the ambient lighting on/off .....	22
Switching ambient mode on/off .....	22
Retracting the deflector plate .....	23
Cooking with Con@ctivity .....	23

Deactivating Con@ctivity temporarily .....	24
<b>Adjusting settings</b> .....	<b>25</b>
Intervals for the grease filter operating hours counter .....	25
Intervals for the charcoal filter operating hours counter .....	25
Activating/deactivating power management .....	26
Reducing the extraction height .....	27
<b>Energy saving tips</b> .....	<b>28</b>
<b>Cleaning and care</b> .....	<b>29</b>
Housing.....	29
Grease filters and panel for edge extraction .....	29
Removing the panel.....	31
Cleaning the drip tray.....	31
Inserting the panel.....	32
Resetting the grease filter operating hours counter .....	32
Replacing the grease filters .....	32
Charcoal filters.....	33
Resetting the charcoal filter operating hours counter .....	33
Disposing of charcoal filters.....	33
Reactivatable charcoal filters.....	33
<b>Customer Service Department</b> .....	<b>34</b>
Contact in the event of a fault .....	34
Position of the data plate .....	34
Warranty .....	34
Copyright and licences .....	34
<b>Installation</b> .....	<b>35</b>
Before installation .....	35
Installation materials.....	35
Appliance dimensions.....	36
Installation dimensions .....	37
Sealing the gaps .....	43
Installation examples .....	44
Connection for air extraction .....	45
Non-return flap.....	45
Electrical connection .....	46
<b>Technical data</b> .....	<b>47</b>
Optional accessories for recirculation mode.....	47
EU Conformity declaration.....	47
UK Conformity declaration .....	47

## Warnings and safety notes

---

This cooker hood complies with all relevant local and national safety requirements. Inappropriate use can, however, lead to personal injury and material damage.

Read the operating and installation instructions carefully before using the cooker hood. They contain important information on its safety, installation, use and maintenance. This prevents both personal injury and damage to the cooker hood.

In accordance with standard IEC 60335-1, Miele expressly and strongly advises that you read and follow the instructions in the chapter on installing the appliance as well as the safety instructions and warnings.

Miele cannot be held liable for injury or damage caused by non-compliance with these instructions.

Keep these instructions in a safe place and pass them on to any future owner.

### Correct application

- ▶ The cooker hood is not intended for outdoor use.
- ▶ It must only be used as a domestic appliance to extract vapours and remove odours from cooking. Any other usage is not supported by the manufacturer and could be dangerous.
- ▶ The cooker hood can only be used by people with reduced physical, sensory or mental capabilities, or lack of experience and knowledge, if they are supervised whilst using it, or have been shown how to use it in a safe way and recognise and understand the consequences of incorrect operation.

### Safety with children

- ▶ Children under 8 years of age must be kept away from the cooker hood unless they are constantly supervised.
- ▶ Children aged 8 and older may only use the cooker hood without supervision if they have been shown how to use it and are able to do so in a safe manner. Children must be able to understand and recognise the possible dangers caused by incorrect operation.
- ▶ Children must not be allowed to clean or maintain the cooker hood unsupervised.

- ▶ Please supervise children in the vicinity of the cooker hood and do not let them play with it.
- ▶ Danger of suffocation! Whilst playing, children may become entangled in packaging material (such as plastic wrapping) or pull it over their head with the risk of suffocation. Keep packaging material away from children.

### Technical safety

- ▶ Unauthorised installation, maintenance and repairs can pose a considerable risk to the user. Installation, maintenance and repairs must only be carried out by a Miele authorised technician.
- ▶ A damaged appliance can be dangerous. Check it for visible signs of damage. Do not use a damaged appliance.
- ▶ The electrical safety of this appliance can only be guaranteed when correctly earthed. It is essential that this standard safety requirement is met. If in any doubt please have the electrical installation tested by a qualified electrician.
- ▶ Temporary or permanent operation on an autonomous power supply system or a power supply system that is not synchronised with the mains power supply (e.g. island networks, back-up systems) is possible. A prerequisite for operation is that the power supply system complies with the specifications of EN 50160 or an equivalent standard.

The function and operation of the protective measures provided in the domestic electrical installation and in this Miele product must also be maintained in isolated operation or in operation that is not synchronised with the mains power supply, or these measures must be replaced by equivalent measures in the installation. As described, for example, in the current version of BS OHSAS 18001–2 ISO 45001.

- ▶ The connection data (voltage and frequency) on the data plate of the cooker hood must match the mains electricity supply in order to avoid the risk of damage to the cooker hood. Compare this before connecting the appliance to the mains. Consult a qualified electrician if in any doubt.
- ▶ Do not connect the appliance to the mains electricity supply by a multi-socket unit or an extension lead. These are a fire hazard and do not guarantee the required safety of the appliance.

## Warnings and safety notes

---

- ▶ For safety reasons, this appliance may only be used after it has been built in.
  - ▶ The cooker hood must not be used in a non-stationary location (e.g. on a ship).
  - ▶ Touching electrical components and tampering with electrical and mechanical parts is highly dangerous to the user and can cause operational faults.
- Only open the housing as described in the instructions given in the installation sheet and in the Cleaning and care section of this booklet. Under no circumstances should any other parts of the housing be opened.
- ▶ The manufacturer's warranty will be invalidated if the appliance is not repaired by a Miele authorised technician.
  - ▶ If the electrical connection cable is faulty it must only be replaced by a Miele authorised technician to protect the user from danger.
  - ▶ The lamps are a built-in component of the lighting. Replacement lamps may only be fitted by a Miele authorised technician or by the Miele Customer Service Department.
  - ▶ During installation, maintenance and repair work, the appliance must be disconnected from the mains electricity supply.

## Warnings and safety notes

Using at the same time as another heating appliance that depends on the air from the room

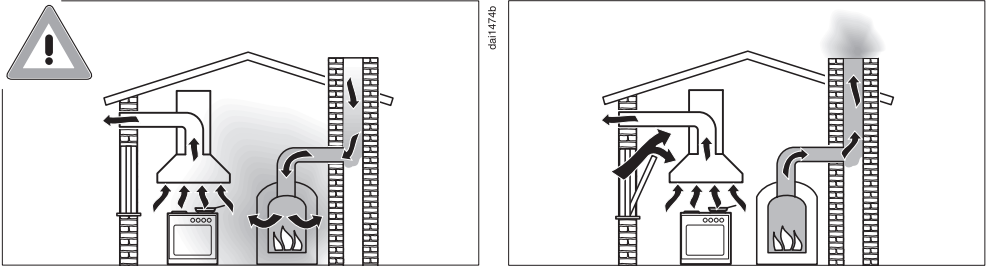

### ⚠ Danger of toxic fumes!

Great care should be taken when using the cooker hood in the same room or the same area of the house at the same time as another heating appliance that depends on the air from the room. Such heating appliances draw in air from the room and duct exhaust gases out through a chimney or extraction ducting. They include gas, oil, wood and coal-fired boilers and heaters, continuous flow or other water heaters, gas hobs and ovens.

The cooker hood draws in air from the kitchen and from neighbouring rooms. This applies to the following modes of operation:

- Extraction mode
- Recirculation mode with a recirculation box installed outside the room.

If there is insufficient air, negative pressure will occur. The heating appliance may be starved of oxygen. This impairs combustion. Harmful gases could be drawn from the chimney or extraction ducting back into the room.

Risk of death!

## Warnings and safety notes

---

In order to ensure safe operation and to prevent gases given off by the heating appliance from being drawn back into the room when the cooker hood and the heater are both operated simultaneously, an underpressure in the room of 0.04 mbar (4 Pa) is the maximum permissible.

Sufficient ventilation can be maintained by air inlets which cannot be blocked, e.g. in windows, doors and outside wall vents. The cross-section of the inlet openings must enable sufficient ventilation. A ventilation brick alone is not generally sufficient to ensure safe ventilation.

The overall ventilation condition of the dwelling must be taken into account. If in any doubt, ask a competent building regulations inspector or qualified gas fitter (if appropriate).

If the cooker hood is being operated in recirculation mode, whereby the air is redirected into the room in which it is installed, the above restrictions do not apply.

### Correct use

▶ Risk of crushing! Do not reach into the travel area of the extractor as it moves up or down.

▶ Open flames are a fire hazard.

The use of an open flame under the cooker hood is not permitted. To avoid the danger of fire, do not flambé or grill over an open flame.

When switched on, the cooker hood could draw flames into the filter. Fat deposits could ignite, presenting a fire hazard.

▶ Always switch the cooker hood on when a cooking zone is in use, otherwise condensation may collect in the hood, which could cause corrosion.

▶ Overheated oil and fat can ignite, causing fire damage to the cooker hood.

When cooking with oil or fat, chip pans and deep fat fryers, etc, do not leave the pans unattended. Similarly, never leave an open grill unattended when grilling.

▶ Do not use the cooker hood without the filters in place. This way you will avoid the risk of grease and dirt getting into the appliance and hindering its smooth operation.

▶ The cooker hood can get very hot during cooking due to heat rising from the hob.

Do not touch the housing or the grease filters until the cooker hood has cooled down.

### Proper installation

▶ To determine whether a cooker hood may be operated above your cooking appliance, please refer to the information provided by the appliance's manufacturer.

▶ The downdraft extractor must not be installed next to solid fuel stoves.

▶ The cooker hood must not be operated in combination with a gas hob.

▶ The distances given in "Installation" must be observed when fitting the downdraft extractor.

▶ Components can have sharp edges which may cause injury. Wear gloves to protect your hands from being cut.

▶ Exhaust ducting must be of non-inflammable material. Suitable material is available from Miele specialist dealers or the Miele Spares Dept.

▶ The appliance must not be connected to a chimney or flue which is in use. Neither should it be connected to ducting which ventilates rooms with fireplaces.

▶ If exhaust air is to be extracted into a chimney or ventilation duct no longer used for other purposes, seek professional advice.

### Cleaning and care

▶ There is a risk of fire if the cooker hood is not cleaned as described in these operating instructions.

▶ Do not use a steam cleaning appliance to clean this appliance. The steam could reach electrical components and cause a short circuit.

## Warnings and safety notes

---

### Accessories and spare parts

- ▶ Only use genuine original Miele accessories and spare parts with this appliance. Using accessories or spare parts from other manufacturers will invalidate the warranty and Miele cannot accept liability.
- ▶ Miele can only guarantee the safety of the appliance when genuine original Miele replacement parts are used. Faulty components must only be replaced by Miele spare parts.
- ▶ Miele will guarantee to supply functional spare parts for a minimum of 10 years and up to 15 years following the discontinuation of your vapour extraction unit.

## Disposing of the packaging material

The packaging material is used for handling and protects the appliance from transport damage. The packaging material used is selected from materials which are environmentally friendly for disposal and can generally be recycled.

Recycling the packaging material reduces the use of raw materials. Use material-specific collection points for valuable materials and take advantage of return options. Your Miele dealer will take the packaging material away.

## Disposing of your old appliance

Electrical and electronic appliances contain many valuable materials. They also contain certain materials, compounds and components which were essential for their correct functioning and safety. These could be hazardous to human health and to the environment if disposed of with household waste or if handled incorrectly. Please do not, therefore, dispose of your old appliance with household waste.



Instead, please make use of officially designated collection and disposal points to dispose of and recycle electrical and electronic appliances in your local community, with your dealer or with Miele, free of charge. By law, you are solely responsible for deleting any personal data from the old appliance prior to disposal. You are legally obliged to remove any old batteries which are not securely enclosed by the appliance and to remove any lamps without destroying them, where this is possible. These must be taken to a suitable collection point where they can be handed in free of charge. Please ensure that your old appliance poses no risk to children while being stored for disposal.

# Familiarisation

## Cooker hood overview

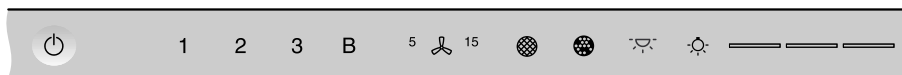
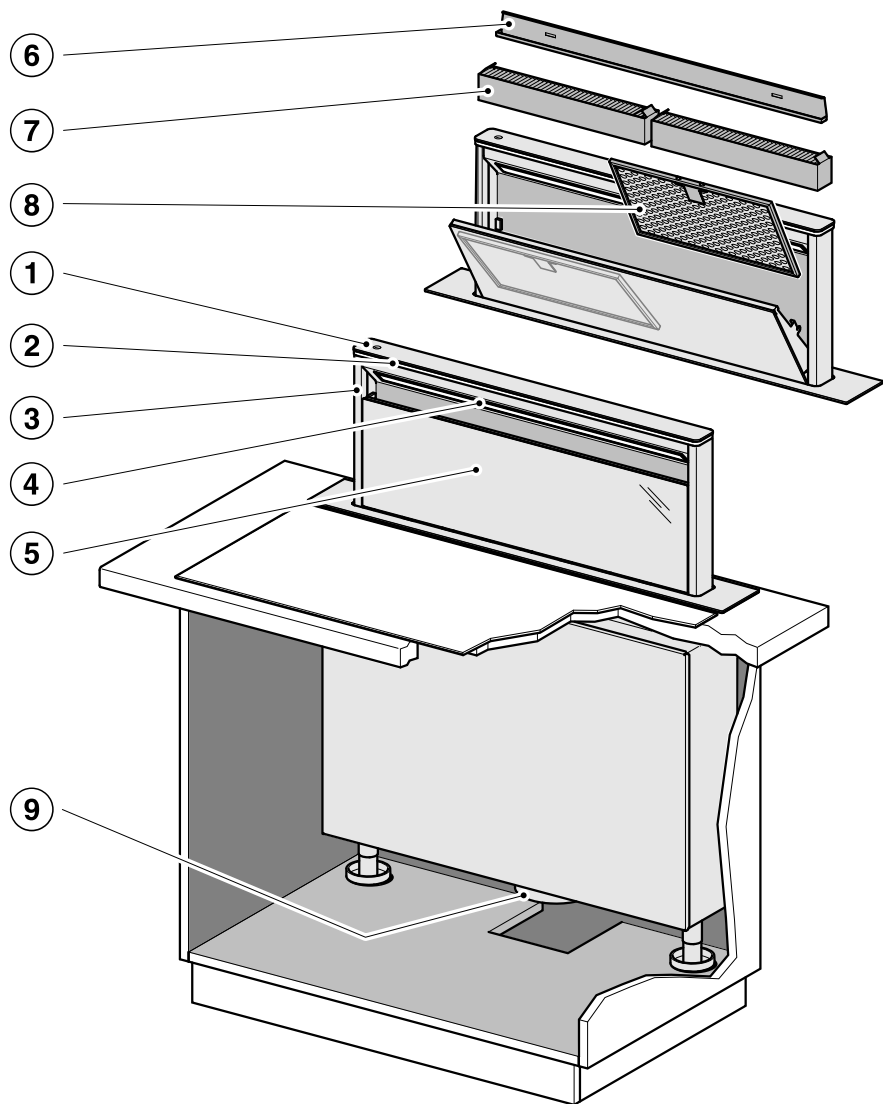

10

11

12

13

14

15

16

17

- ① Control elements
- ② Ambient lighting
- ③ Retractable deflector plate
- ④ Hob lighting
- ⑤ Edge extraction panel
- ⑥ Drip tray
- ⑦ Charcoal filter  
Single-use or reactivatable charcoal filters (accessories available for recirculation mode)
- ⑧ Grease filters
- ⑨ Exhaust duct
- ⑩ Sensor control for switching the cooker hood on and off
- ⑪ Sensor controls for switching the fan on and off and for setting the fan power level
- ⑫ Sensor control for the run-on function
- ⑬ Sensor control for the grease filter operating hours counter
- ⑭ Sensor control for the charcoal filter operating hours counter
- ⑮ Sensor control for switching the ambient lighting on and off
- ⑯ Sensor control for switching the lighting on and off and for dimming the lighting
- ⑰ Sensor controls for selecting and displaying lighting levels

## Components

### Grease filters and panel

The edge extraction panel and the reusable metal grease filters in the appliance remove solid particles (grease, dust, etc.) from the kitchen vapours, preventing soiling of the cooker hood.



Risk of fire

Oversaturated grease filters are a fire hazard.

Clean the grease filters at regular intervals.

Heavily soiled grease filters hinder the extraction power and will lead to increased levels of soiling in the cooker hood and in the kitchen.

### Charcoal filter

With recirculation mode and Plug & Play recirculation mode, 2 charcoal filters must be fitted in addition to the grease filters. These are designed to absorb cooking odours.

The charcoal filters are available as optional accessories. There are charcoal filters available that need to be replaced at the end of their operating time and others that can be reactivated.

### Hob lighting

The hob lighting can be switched on and off and dimmed independently of the fan.

# Familiarisation

---

## Ambient lighting

The ambient lighting provides atmospheric lighting.

You can switch on the ambient lighting at any time while the cooker hood is in use.

## Ambient mode

If you use the ambient lighting without switching on the fan and the hob lighting, the deflector plate extends approx. 2 cm into the ambient position.

## Functions

### Extraction mode

The cooking vapours are drawn in by the cooker hood. The air is then passed via the edge extraction panel through the grease filters, cleaned and then directed outside.

### Recirculation mode

(with conversion kit and charcoal filter as optional accessories)

The air is drawn in via the edge extraction panel and cleaned first by the grease filters and then by charcoal filters. The air is then circulated back into the kitchen.

For recirculation operation, we recommend that the air is fed into the kitchen through a duct with an outlet, e.g. in the plinth panel.

### Recirculation mode Plug&Play

If the installation space is not sufficient for an air duct, the air can also be guided into the plinth under the kitchen furniture in Plug&Play operation. Please follow the instructions in "Installation".

## Kitchen ventilation

Ensure that the kitchen is well ventilated when operating the cooker hood.

In extraction mode, the efficiency of the cooker hood is improved by the incoming air.

In recirculation mode, the moisture produced during cooking remains in the kitchen. Ventilation helps to dissipate moisture.

## Fan power levels

Select power levels **1** to **3** for light to heavy cooking vapours, odours or heat.

Increase the power level as the level of vapours, odours or heat increases.

For short periods of cooking food with intensive vapours, odours or heat, e.g. when searing meat, select Booster level **B<sub>1</sub>** or **B<sub>2</sub>**. The fan will automatically switch back from the Booster levels after a few minutes.

## Run-on function

The run-on function enables the cooker hood to continue running for a pre-determined time before switching itself off automatically.

This helps to remove any lingering vapours and odours from the air after cooking. It also reduces the risk of residues accumulating in the cooker hood and any resultant odours.

## Reduced extraction height

If you select a reduced extraction height in the settings, the deflector plate will only extend approx. 10 cm when the fan or hob lighting is switched on.

- If you use pans or low pots or cook with pots that have a side steam outlet in the lid, the reduced suction height optimises extraction.
- When installed in a cooking island, the reduced extraction height also allows an unrestricted view of the hob from the rear.

## Operating hours counter

The number of hours that the cooker hood has been used for is stored in memory.

When the grease filter symbol  lights up, the grease filters must be cleaned.

When the charcoal filter symbol  lights up, the charcoal filter must be replaced or reactivated (if suitable for re-activating).

You can set the operating hours counter intervals to suit the type of cooking you do.

Deactivate the operating hours counter for the charcoal filter if you are operating the cooker hood in extraction mode.

## Networking

Your cooker hood is equipped with an integrated WiFi module. The WiFi module makes it possible to connect to your home network and to use the Miele app on a mobile device.

Once your cooker hood has been connected via WiFi, the connection is automatically re-established every time it is switched on.

Make sure that your WiFi network signal is strong enough in the place where you intend to install your cooker hood. Connecting your cooker hood to your WiFi network will increase energy consumption, even when the cooker hood is switched off.

## Smart Extras via the Miele app\*

Networking via the Miele app gives you access to numerous Smart Extras, including:

- Access status information.
- Use additional helpful functions.
- Keep your cooker hood up to date with the latest Miele developments via software updates.

You can find more detailed information about Smart Extras on the Miele website, in the Apple App Store® or in the Google Play Store™.

\*This is a separate digital offer from Miele & Cie. KG. The range of functions can vary depending on the model and the country. Acceptance of the Terms and Conditions and Privacy Policy for Miele digital products & services in the Miele app required. Miele reserves the right to change or discontinue the digital offer at any time.

# Familiarisation

---

## Adaptive Con@ctivity

With the Con@ctivity function, the cooker hood is automatically controlled in conjunction with the hob. The cooker hood and Miele hob must be connected to the home WiFi network or have a direct WiFi connection.

The cooker hood can also be operated manually at any time during automatic operation.

If you regularly select a higher power level, for example, automatic operation will adapt to your behaviour (Miele Con@ctivity Plus).

## Power management

The cooker hood is fitted with a power management system. Power management helps to save energy. It ensures that the fan power level is reduced automatically and that the lighting is switched off.

- The second Booster level switches back to the first Booster level after 2 minutes (even if power management is deactivated).

The first Booster level switches back to level **3** after 5 minutes.

- From fan power levels 3, 2 or 1, the power will be reduced by one level after 2 hours and then in 30-minute stages until the fan finally switches off.
- The hob lighting will switch off automatically after 12 hours.





## Selecting extraction mode or recirculation mode

The cooker hood is suitable for both extraction mode and recirculation mode. The power of the fan is adapted to suit the selected operating mode. The cooker hood is delivered set up for recirculation mode. It has to be reset for extraction mode.

To reset it for extraction mode, the operating hours counter for the charcoal filter(s) has to be deactivated.

- With the deflector plate retracted, touch the On/Off switch .

All symbols light up with reduced brightness.

- Press and hold the run-on option control  until the grease filter  and charcoal filter  symbols light up.
- Touch the charcoal filter symbol .

The charcoal filter symbol  and one of the fan power levels will flash.

- Touch **B**.
- Confirm your choice by touching the charcoal filter control .

All the indicator lights will go out.

Extraction mode has now been set.



If you do not confirm your selection within 4 minutes, the cooker hood will automatically revert to the original setting.

## Activating/deactivating Plug & Play



- Touch the On/Off switch .

All symbols light up with reduced brightness.

- Press and hold the run-on control .

After a few seconds, the grease filter  and charcoal filter  symbols light up, and after a further 7 seconds the **1** fan power level indicator lights up.

- Then touch the following controls in turn:

- The **1** control
- The lighting control  and
- The lighting control  again

When Plug & Play is deactivated, the indicators **1** and **3** will flash.

When Plug & Play is activated, the indicators **1** and **3** will light up constantly.

- To activate, touch **B**.

The **1** and **3** indicators light up constantly.

- Touch **1** to deactivate.

The **1** and **3** indicators flash.

- Confirm the setting with the run-on control .

All the lights will go out.

# Commissioning

## Networking

### Requirements for networking

Note the following requirements for networking:

1. A home network is available at the installation site.  
Have the WiFi password ready.
2. The Miele app is available on a mobile device.
3. You have a user account in the Miele app.

### Performing Scan & Connect

- Scan the QR code.

If you have installed the Miele app and have a user account, you will be taken directly to the networking steps.

If you have not yet installed the Miele app, you will be taken to the Apple App Store® or the Google Play Store™.

- Install the Miele app and set up a user account.
- Scan the QR code again.

The Miele app will guide you through the setup process.





### Signing off WiFi and remote control

To set up a new WiFi connection or a connection with a remote control, the existing connections must be disconnected first.

The sign-off process will always sign off the WiFi and a connected remote control at the same time.

- With the deflector plate retracted, touch the On/Off switch (⏻).

All symbols light up with reduced brightness.

- Press and hold the run-on control <sup>5</sup>  until the grease filter  and charcoal filter  symbols light up.

- Touch **1**.

If a WiFi connection exists, **2** and **3** will light up constantly.

If a remote control is signed on, **B** will also light up.

- Touch **1**.

**2** will light up constantly, **3** will flash.

After a few seconds, **2** and **3** will flash. The connection has now been disconnected.

- Quit signing-off mode on the cooker hood by touching the run-on control <sup>5</sup> .
- Also sign off the remote control. See the operating instructions supplied with the remote control for information on how to do this.

All connections have been disconnected. You can establish a new connection.

0155496 DAHXXX-qr-v02

## Setting up Con@ctivity

### Activating Con@ctivity 3.0 via the home WiFi network

Requirements:

- Home WiFi network
- WiFi-enabled Miele hob

- Connect the cooker hood and hob to the home WiFi network (see “Networking”).

The Con@ctivity function will be activated automatically.

### Activating Con@ctivity 3.0 via a direct WiFi connection



Rather than connecting to the home network, you can establish a direct connection between the hob and the cooker hood.

Requirements:

- WiFi-enabled Miele hob

- With the deflector plate retracted, touch the On/Off switch .

All symbols light up with reduced brightness.

- Press and hold the run-on control  until the grease filter  and charcoal filter  symbols light up.
- Touch **3**.

**2** will light up constantly, **3** will flash.

The cooker hood will be ready for connection for the next 10 minutes.

- Start the WiFi connection on the hob. For further details, see the hob operating instructions.

When successfully connected, **2** and **3** will light up constantly.

- Confirm the setting with the run-on control .

If it is not possible to connect, **2** and **3** flash or the process is cancelled.

- Disconnect the connection to the cooker hood (see “Signing off WiFi”) **and** to the hob.
- Repeat the process.

With a direct WiFi connection, it is not possible to connect the hob and the cooker hood to a home network. This means that, for example, the appliance then cannot be operated via the Miele app. Should a connection to the home network be required at a later date, the direct WiFi connection between the hob and the cooker hood must be disconnected first (see “Signing out of WiFi”).

# Commissioning



---

## Signing on the remote control

Miele DARC 7 is an optional accessory

- With the deflector plate retracted, touch the On/Off switch  on the cooker hood.

All symbols light up with reduced brightness.

- Press and hold the run-on control <sup>5</sup> until the grease filter  and charcoal filter  symbols light up.

- Touch **B**.

**2** will light up constantly, **3** will flash.

- Start the sign-on process on the remote control. For further details, see the remote control operating instructions.

When successfully signed on, **2** and **3** will light up constantly.

- Confirm the setting with the run-on control <sup>5</sup>.

## Signing off the remote control

- For information about the sign-off process, see “Commissioning – Signing off WiFi and remote control”.

## Risk of crushing!

Do not reach into the motion range of the deflector plate as it moves up or down.

## Switching on the fan

- With the deflector plate retracted, touch the On/Off switch .

All symbols light up with reduced brightness.

- Switch the fan on by touching one of the controls from **1** to **B**.

The deflector plate extends.

The fan switches to the desired level.

## Selecting the power level

- Select the power level required by touching a control from **1** to **B**.
- If you touch the **B** control, the first Booster level is activated.

The **B**• symbol lights up.

- If you touch the **B** control again, the second Booster level is activated.

The **B**•• symbol lights up.





## Switching back the Booster levels

The second Booster level switches back to the first Booster level after 2 minutes.

The first Booster level switches back to level **3** after 5 minutes.

## Selecting the run-on time

- After you have finished cooking, touch the run-on control  with the fan still switched on:

- Once: the fan will switch itself off after 5 minutes (**5**  lights up).
- Twice: the fan will switch itself off after 15 minutes ( **15** lights up).
- If you touch the run-on control  again, the fan will remain on ( will go out).

## Switching the fan off

- Touch the control for the active power level.

The fan switches off.

If the hob lighting is also switched off, the deflector plate retracts after 1 minute.

## Run-on in Plug&Play operation

If you switch off the fan in Plug&Play mode, it will run on at level **1**.

Run-on ensures that the plinth is ventilated after cooking.

Depending on the last active fan level, run-on lasts between 2 and 30 minutes.

You can switch off the fan immediately during run-on by pressing **1** or the On/Off switch .

This function is independent of the run-on function .

# Operation

---

## Switching on the hob lighting

- Touch the On/Off switch .

All symbols light up with reduced brightness.

- Touch the lighting control  briefly.

The deflector plate extends.

The lighting will switch on at maximum brightness. All 3 bars next to the lighting control  light up.

## Dimming the hob lighting

- With the lighting switched on, press and hold the lighting control .

The brightness will gradually dim until you release the control.

- Press and hold the lighting control  again.

The brightness will gradually increase until you release the control.

- Alternatively, you can select 3 brightness levels by touching the bars next to the lighting control .

## Switching the hob lighting off

- Touch the lighting control .

The hob lighting will switch off.



If the fan is also switched off, the deflector plate retracts after 1 minute.

## Switching the ambient lighting on/off

You can switch on the ambient lighting at any time while the cooker hood is in use.

- Press the  control to switch the ambient lighting on and off.

## Switching ambient mode on/off

- With the deflector plate retracted, touch the On/Off switch .
- Press the control for the ambient lighting .

The deflector plate extends approx. 2 cm into the ambient position. The ambient lighting switches on.

- Press the  control to switch the ambient lighting off.

- If you switch on the fan or the hob lighting in ambient mode, the deflector plate extends.
- If you switch off the ambient lighting, fan and hob lighting when the deflector plate is extended and switched on, the deflector plate moves to the ambient position.

## Retracting the deflector plate

- Touch the On/Off switch (⏻).

The fan, hob lighting and the ambient lighting are switched off.

All symbols go out.

The deflector plate retracts.

If the fan and lighting are switched off, the deflector plate retracts automatically after 1 minute.

## Cooking with Con@ctivity

If the Con@ctivity function is activated, the cooker hood is automatically controlled in conjunction with the hob.

- Switch a cooking zone on at the desired power level.

The deflector plate extends.

The hob lighting will come on.

After a few seconds the fan will come on, first at power level **2**, then it will switch immediately to power level **1**.

The cooker hood selects the required fan power level automatically during cooking. The power level selected by the cooker hood depends on the number of cooking zones being used and their power levels.

As changing the power level on the hob does not increase or decrease the cooking vapours straight away, the cooker hood reacts with a delay.

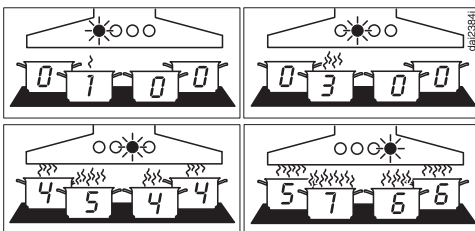

Examples for power levels **1** to **8**

- Switch off all cooking zones after cooking.

To clean the kitchen air of any remaining vapours and odours, the cooker hood fan will reduce its power level in stages over the next few minutes and will then switch itself off.

After another 30 seconds, the hob lighting switches off.

1 minute later, the deflector plate retracts.

## Frying with Con@ctivity

- For example, you switch on a cooking zone at the highest power level to heat cookware for frying. You reduce the power level after approx. 10 seconds to 4 minutes (60 seconds to 5 minutes for a HiLight hob).

The cooker hood recognises a frying process.

The cooker hood switches itself on and when the hob power level has been reduced, the cooker hood switches to fan power level **3** and remains at that level for approx. 5 minutes.

After that, the cooker hood power level is determined automatically by the Con@ctivity function.

You can select another power level manually before then.

# Operation

---

## Deactivating Con@ctivity temporarily

- Con@ctivity is temporarily deactivated if you:
  - Select a different fan power level, or
  - Switch off the cooker hood, or
  - Select the run-on function .
- The cooker hood returns to Con@ctivity if
  - You do not operate the cooker hood for approx. 5 minutes, or
  - The fan level you have selected corresponds to the power level selected by Con@ctivity, or
  - The cooker hood fan and the hob have been switched off for at least 30 seconds. Con@ctivity is reactivated the next time the hob is switched on.

## Deactivating Con@ctivity for the entire cooking process

- Switch the fan on **before** the hob.

Con@ctivity is deactivated until the cooker hood is switched off.

If the cooker hood and the hob have been switched off for at least 30 seconds after cooking, Con@ctivity is reactivated the next time the hob is switched on.

## Intervals for the grease filter operating hours counter



The factory default setting is a cleaning interval of 30 hours.

- Select a shorter interval of 20 hours if you fry food regularly.
- A shorter cleaning interval is also recommended if you only cook occasionally. This is to prevent grease hardening on the filter(s) and making cleaning more difficult.
- Select a longer interval of 40 or 50 hours if you use very little fat for cooking.

## Changing the intervals for the grease filter operating hours counter

- Touch the On/Off switch .

All symbols light up with reduced brightness.

- Press and hold the run-on control  until the grease filter  and charcoal filter  symbols light up.

- Touch the grease filter symbol .

The grease filter symbol  and one of the fan power level indicators will flash.

Fan power level indicators **1** to **B** show the time set:

- 1**..... 20 hours
- 2**..... 30 hours
- 3**..... 40 hours
- Indicator **B**..... 50 hours

- Touch the relevant control to select the duration required.
- Confirm your choice by touching the grease filter control . If you do not confirm your selection within 4 minutes, the cooker hood will automatically revert to the original setting.

## Intervals for the charcoal filter operating hours counter



The factory default setting is an interval of 180 hours.

- If you frequently cook dishes with strong odours, we recommend shortening the interval to 120 hours.
- If you rarely cook dishes with strong odours, you can extend the interval to 240 hours.

## Altering or deactivating the charcoal filter operating hours counter intervals

- Touch the On/Off switch .

All symbols light up with reduced brightness.

- Press and hold the run-on control  until the grease filter  and charcoal filter  symbols light up.

- Touch the charcoal filter symbol .

The charcoal filter symbol  and one of the fan power levels will flash.

Fan power level indicators **1** to **B** show the interval set:

- 1**..... 120 hours
- 2**..... 180 hours
- 3**..... 240 hours
- Indicator **B**..... deactivated

- Touch the relevant control to select the interval required.
- Confirm your choice by touching the charcoal filter control . If you do not confirm your selection within 4 minutes, the cooker hood will automatically revert to the original setting.

# Adjusting settings



## Activating/deactivating power management

Keep in mind that deactivating this function may increase energy consumption.



- Touch the On/Off switch .

All symbols light up with reduced brightness.

- Press and hold the run-on control .

After a few seconds, the grease filter  and charcoal filter  symbols light up, and after a further 7 seconds **1** lights up.

- Then touch the following controls in turn:

- The lighting control 
- The **1** control and then
- The lighting control  again

When power management is activated, **1** and **B** light up constantly.

When it is deactivated, **1** and **B** flash.

- To deactivate power management, touch **1**.

**1** and **B** will flash.

- To activate, touch **B**.

**1** and **B** will light up constantly.

- Confirm the setting with the run-on control .

All the lights will go out.

If you do not confirm your choice of setting within 4 minutes, the cooker hood will revert to the old setting.

## Deactivating/activating the sensor control buzzer



When a function is selected with the sensor controls, a short buzzer will sound for confirmation.

The buzzer can be deactivated.

- Touch the On/Off switch .

All symbols light up with reduced brightness.

- Press and hold the run-on control .

After a few seconds, the grease filter  and charcoal filter  symbols light up, and after a further 7 seconds **1** lights up.

- Touch **1** three times.

If the buzzer is activated, **2** and **3** light up constantly.

If it is deactivated, **2** and **3** flash.

- Touch **1** to deactivate the buzzer.

**2** and **3** will flash.

- To activate, touch **B**.

**2** and **3** will light up constantly.

- Confirm the setting with the run-on control .

All the lights will go out.

If you do not confirm your choice of setting within 4 minutes, the cooker hood will revert to the old setting.

## Reducing the extraction height

- With the deflector plate retracted, touch the On/Off switch .

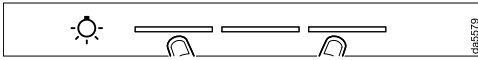

- At the same time, touch the first and third bar next to the lighting control twice .

The deflector plate extends to the reduced height of approx. 10 cm.

- Switch on the fan or the hob lighting.

When switching off, the deflector plate first extends to the maximum height and then retracts again.

The deflector plate extends again to the reduced height when it is switched on again.

- To switch back to the maximum extension height, touch the first and third bar next to the lighting control  twice again when the deflector plate is retracted.

## Energy saving tips

This cooker hood operates very efficiently and economically. The following will help you to save even more energy when using it:

- Ensure that there is sufficient ventilation in the kitchen when cooking. In extraction mode, if there is insufficient air flow the cooker hood cannot operate efficiently and this causes increased operating noise levels.
- Always cook with the lowest possible setting. This produces fewer cooking vapours, so you can use a lower cooker hood power level and therefore benefit from reduced energy consumption.

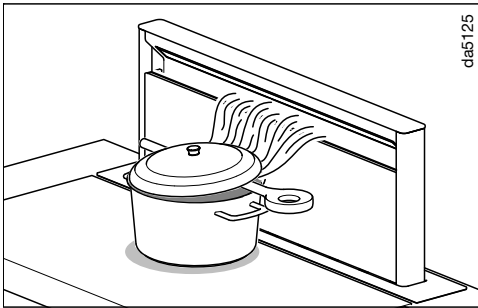

- If strong cooking vapours are produced during cooking, place the cookware as close as possible to the cooker hood.

Cook in covered pots and pans if possible. This prevents heat escaping unnecessarily.

If you are cooking with open pots, put a lid on at an angle. For example, place a cooking spoon between the pot and the lid. The deflection of the cooking vapours in the direction of the extractor ensures optimum extraction.

- Clean or change the filters at regular intervals. Heavily soiled filters reduce performance, increase the risk of fire and are unhygienic.
- Use the Con@ctivity function. The cooker hood will switch on and off automatically at the optimum power level for the cooking you are doing, which ensures low energy consumption.
- If you are operating the cooker hood manually, please note the following:
  - Check the power level selected on the cooker hood. A low power level is usually sufficient. Only use the Booster setting when necessary.
  - When a large volume of cooking vapours are being produced, switch to a high power level in good time. This is more efficient than operating the cooker hood for longer to try to capture cooking vapours which have already been distributed throughout the kitchen.
  - Make sure that you switch the cooker hood off after use. If cooking vapours and odours still need to be removed from the kitchen air after cooking, use the run-on function. The fan will switch off automatically after the selected run-on time.

## Housing

### General information

Unsuitable cleaning agents can damage the surfaces and control elements.

Do not use any cleaning agents containing soda, acid, chloride or solvent.

Do not use any abrasive cleaning agents, e.g. powder cleaners or cream cleaners and abrasive sponges, as well as pot scourers or sponges which have been used previously with abrasive cleaning agents.

 Moisture in the cooker hood can cause damage.

Make sure that water does not get into the cooker hood.

- All external surfaces and control elements can be cleaned using hot water with a small amount of washing-up liquid applied with a well wrung-out soft sponge or cloth.
- After cleaning, wipe the surfaces dry using a soft cloth.

### Important for appliances with glass surfaces

- Glass surfaces can be cleaned using a proprietary non-abrasive cleaning agent designed specifically for use on glass.

## Grease filters and panel for edge extraction

 Fire hazard

Oversaturated grease filters are a fire hazard.

Clean the grease filters at regular intervals.

The edge extraction panel and the reusable metal grease filters in the appliance remove solid particles (grease, dust, etc.) from the kitchen vapours, preventing soiling of the cooker hood.

The grease filters and the panel must be cleaned at regular intervals.

Heavily soiled grease filters hinder air extraction and will lead to increased levels of soiling in the cooker hood and in the kitchen.

### Cleaning interval



The edge extraction panel should be cleaned regularly (at least every 3 - 4 weeks) to avoid a build-up of grease.

The operating hours counter will illuminate the grease filter symbol  to remind you to clean the edge extraction panel and the grease filters regularly.

# Cleaning and care

## Removing the panel and grease filters

### Opening the panel

- With the deflector plate retracted, touch the On/Off switch .
- Touch the lighting control  briefly.

The deflector plate extends.



#### Risk of crushing

If you switch off the fan and the lighting when the deflector plate is extended, the deflector plate will automatically retract after 1 minute. Risk of injury. Risk of damage to the opened panel.

To prevent the deflector plate from retracting, leave the lighting switched on.

The panel is held in place by magnets.

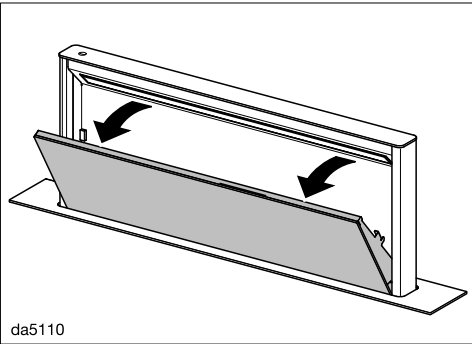

- Pull the top of the panel forwards and swing it open.

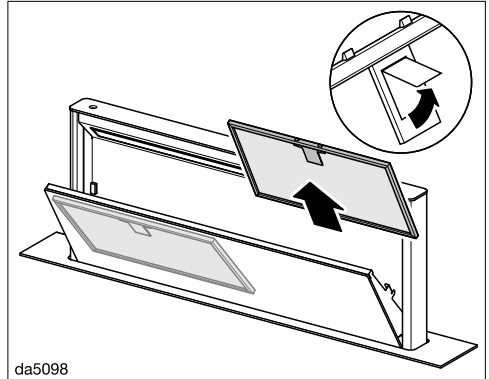

- Open the grease filter retainer catch and remove them.

### Cleaning the grease filters by hand

- Clean the filters with a soft nylon brush in a mild solution of hot water and a small amount of washing-up liquid. Do not use “neat” washing up liquid.

### Unsuitable cleaning agents

Unsuitable cleaning agents can cause damage to the surface of the filters if used regularly.

Do not use:

- cleaning agents containing descaling agents
- powder cleaners, cream cleaners
- aggressive multi-purpose cleaning agents or spray cleaners for grease
- oven sprays

## Cleaning the grease filters in the dishwasher

 Risk of damage due to excessively high temperatures in the dishwasher.

Excessively high temperatures may cause the grease filters to become unusable, if they become deformed, for example.

Select a programme that does not exceed the recommended temperature. Also follow the information provided in the operating instructions for the dishwasher.

- Place the grease filters upright or at a slight angle in the lower basket. Ensure the spray arm is not obstructed.
- Use a standard household cleaning detergent.
- Select a programme with a maximum wash temperature of 65 °C.

Depending on the detergent used, the internal filter surfaces may become discoloured. This will not affect the functioning of the grease filters in any way.

- After cleaning, leave the filters to dry on an absorbent surface before replacing them.

## Removing the panel

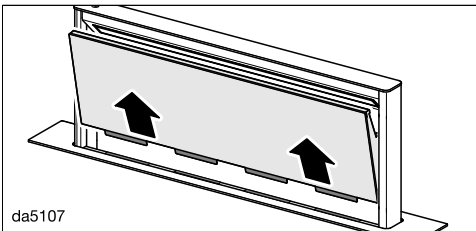

- Pull the opened panel up and out to remove it and place it on a soft surface.

## Cleaning the panel

- Follow the instructions under “Housing”.

The panel is not suitable for cleaning in a dishwasher.

- When removing the panel and filters for cleaning, also clean off any residues of oil or fat from the now accessible parts of the casing to prevent the risk of these catching fire.

## Cleaning the drip tray

Condensate collects in the drip tray underneath the grease filters. The drip tray can be removed for cleaning.

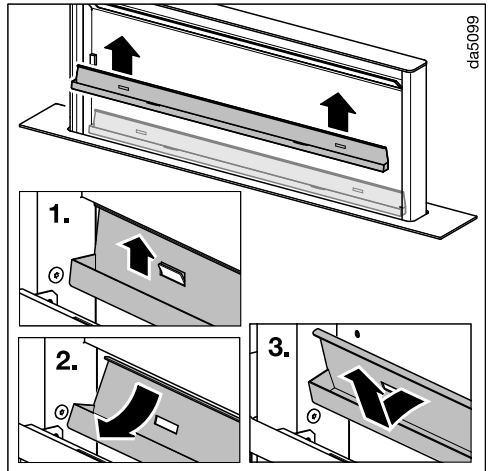

- Carefully pull the drip tray up and out of the holders. Pour away any condensate that has collected in it and then clean the tray with a damp cleaning cloth.

## Cleaning and care

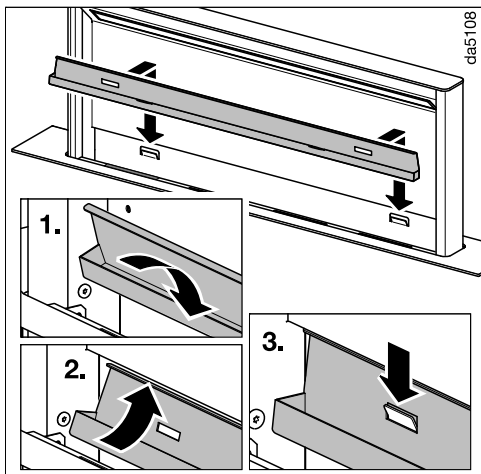

- Hook the drip tray back into the holders after cleaning.

### Inserting the panel

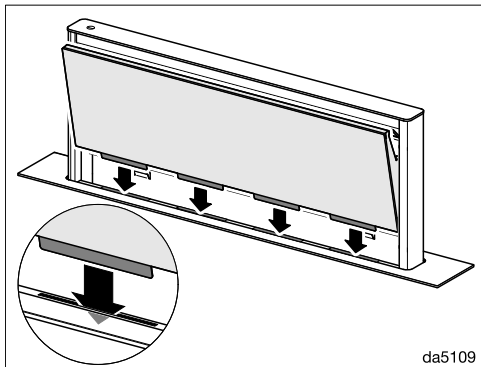

- Insert the panel into the slots on the deflector plate.

- Refit the grease filters, making sure that the latch faces outwards.

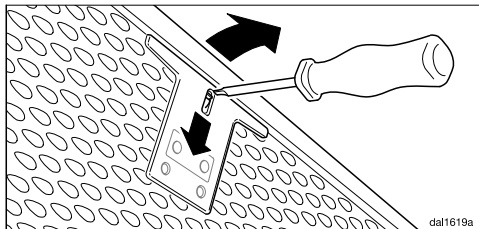

- If a grease filter is inadvertently fitted upside down, insert a small screwdriver blade into the slit to disengage the clip.
- Swing the panel closed until the magnets hold it in place.

### Resetting the grease filter operating hours counter

After cleaning, the operating hours counter needs to be reset.

- With the fan switched on, press the grease filter control  for approx. 3 seconds, until only **1** is flashing.

The grease filter symbol  goes out.

### Replacing the grease filters

Regular usage and cleaning can cause the filter surfaces to become worn.

If you identify any damage, replace the grease filters.

Grease filters are available to order via the Miele Customer Service Department (see end of these operating instructions for contact details) or from your Miele dealer.

## Charcoal filters

With recirculation mode, two charcoal filters must be fitted in addition to the grease filters. These are designed to absorb cooking odours.

Charcoal filters are available to order via the Miele Webshop, the Miele Spare Parts Department (see end of this booklet for contact details) or from your Miele dealer.

The type of charcoal filter required is listed under “Technical data” at the back of this booklet.

### Fitting/replacing charcoal filters

- Remove the panel and remove the drip tray as previously described.
- Take the charcoal filters out of their packaging.

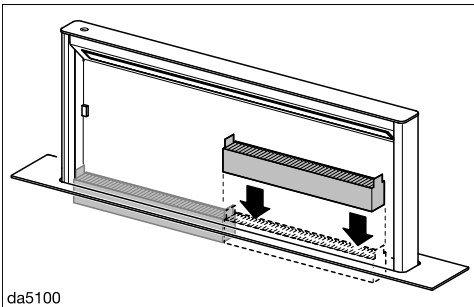

da5100

- Insert the charcoal filters into the deflector plate. Make sure the tabs are facing up.
- Refit the drip tray and the panel.

### When to change the charcoal filters

Replace the charcoal filters when they no longer absorb kitchen odours effectively, and at least every 6 months.

The operating hours counter will remind you to replace the charcoal filters by lighting up the charcoal filter symbol .

### Resetting the charcoal filter operating hours counter

After changing the charcoal filters, the operating hours counter needs to be reset.

- With the fan switched on, press the charcoal filter control  for approx. 3 seconds, until only **1** is flashing.

The charcoal filter symbol  will go out.

### Disposing of charcoal filters

- Used charcoal filters can be disposed of with normal household waste.

### Reactivatable charcoal filters

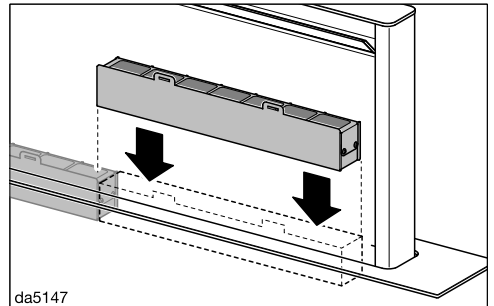

da5147

Reactivatable charcoal filters are available for this cooker hood. They can be used several times after being reactivated in the oven.

Please follow the operating instructions supplied with the filters.

# Customer Service Department

---

Information to help you rectify faults yourself and about Miele spare parts can be found at [www.miele.com/service](http://www.miele.com/service).

## Contact in the event of a fault

In the event of any faults which you cannot remedy yourself, please contact your Miele dealer or the Miele Customer Service Department.

You can book a Miele Customer Service Department call-out online at [www.miele.com/service](http://www.miele.com/service).

Contact information for the Miele Customer Service Department can be found at the end of this document.

Please quote the model identifier and serial number of your appliance (Fabr./SN/Nr.) when contacting the Miele Customer Service Department. This information can be found on the data plate.

Please note that telephone calls may be monitored and recorded for training purposes and that a call-out charge will be applied to service visits where the problem could have been resolved as described in this booklet.

## Position of the data plate

The data plate can be found on the front of the housing.

## Warranty

For information on the appliance warranty specific to your country please contact Miele. See back cover for address.

In the UK, your appliance warranty is valid for 2 years from the date of purchase. However, you must activate your cover by calling 0330 160 6640 or registering online at [www.miele.co.uk](http://www.miele.co.uk).

## Copyright and licences

For the purpose of operating and controlling the communication module, Miele uses proprietary or third-party software that is not covered by open source licensing terms. This software/ these software components are protected by copyright. The copyrights held by Miele and third parties must be respected.

Furthermore, the communication module integrated in the appliance contains software components which are distributed under open source licence conditions. You can access these open source components along with the associated copyright notices, copies of the valid licensing terms, and any additional information locally via IP using a web browser ([http\[s\]://<IP address>/Licenses](http[s]://<IP address>/Licenses)). The liability and warranty arrangements for the open source licences displayed in this location only apply in relation to the respective rights holders.

## Before installation

 Before installation, it is important to read the information given on the following pages as well as the “Warning and Safety instructions” at the beginning of this booklet.

## Installation materials



08005672

**6 screws, M4 x 8 mm**



011056271

**8 screws, 4 x 15 mm**

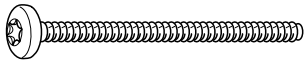

11597030

**2 screws, M4 x 100 mm**

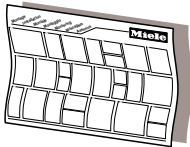

dha3mle

## Installation plan

See the installation plan for details on the individual steps involved in the installation of this appliance.

# Installation

## Appliance dimensions

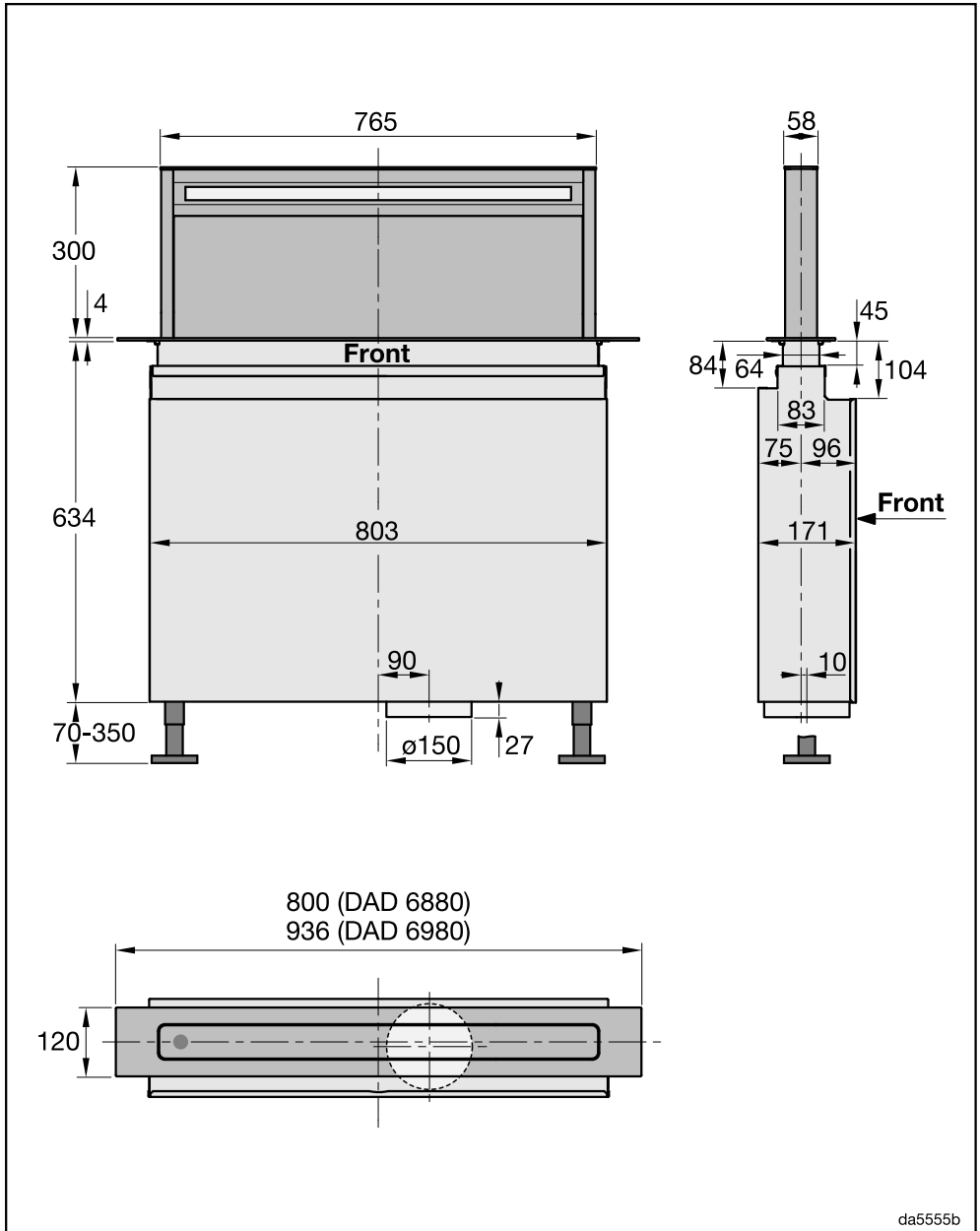

da5555b

## Installation dimensions



Risk of heat damage.

The heat from a gas hob can damage the cooker hood.

The cooker hood must not be operated in combination with a gas hob.

If you are planning to install an oven/cooker in front of the cooker hood, the appropriate installation advice and dimensions regarding cool air circulation must be observed.

The installation location must remain accessible. It must also be possible to access and dismantle the cooker hood from the front in the event of servicing.

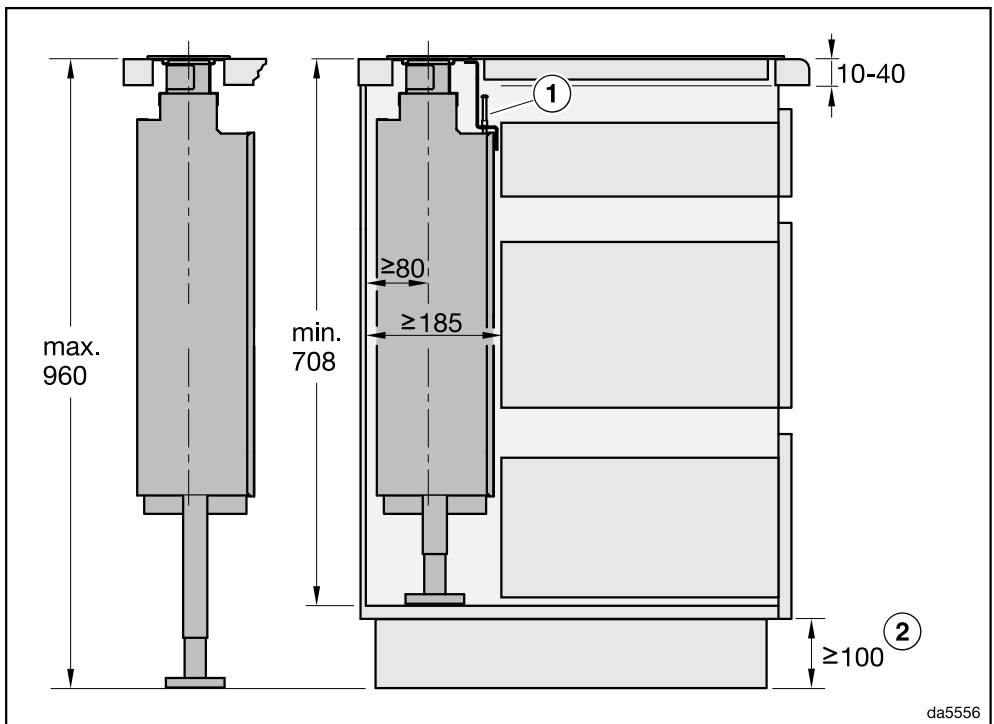

da5556

- ① If you install the cooker hood and the hob flush-fit against each other in the same cut-out, you must use the enclosed angle trim.
- ② The minimum dimension is required if flat ducting is laid under the cabinets or the DUU 600 recirculation box is used.

# Installation

DAD 6880: Installation of the cooker hood and the hob in separate cut-outs

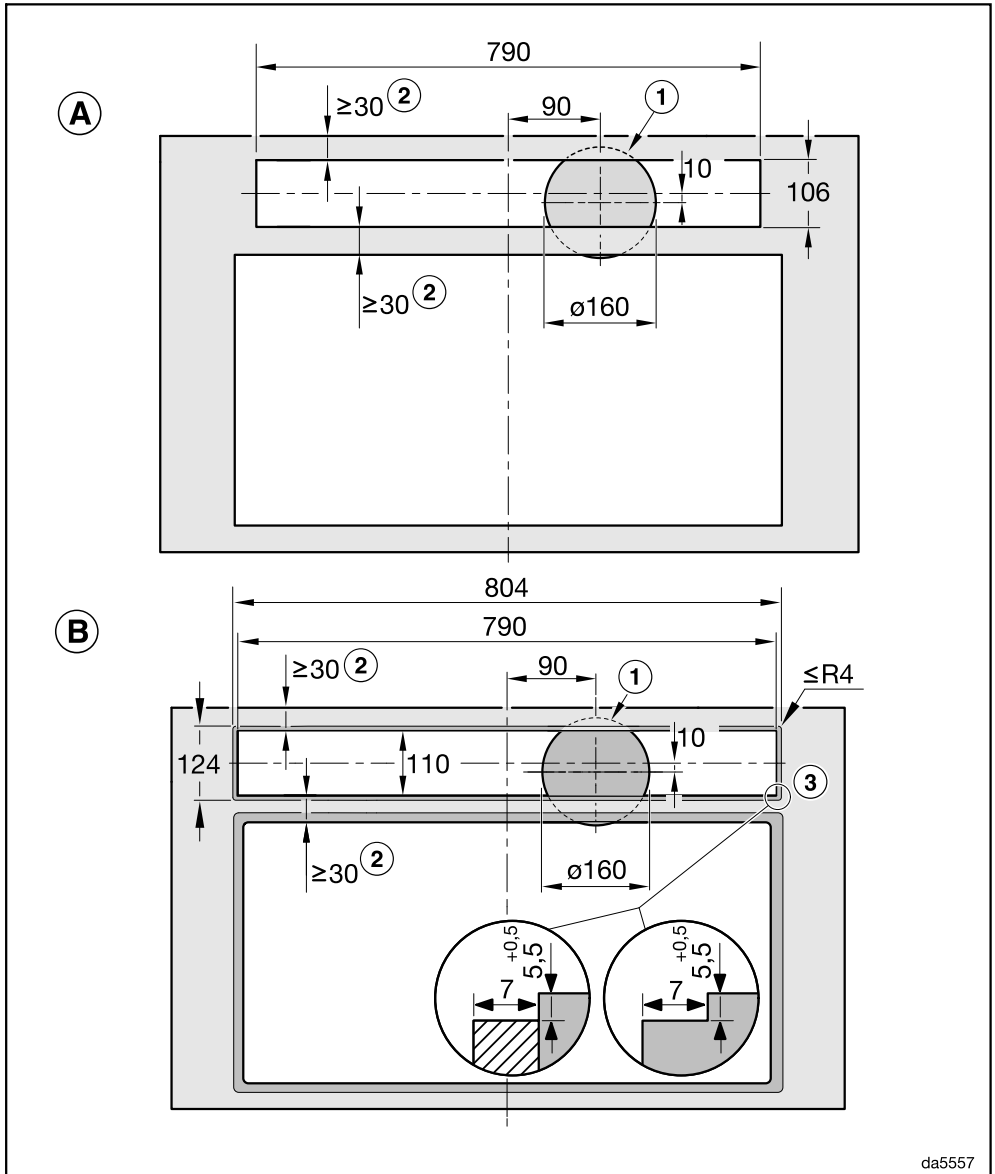

da5557

- Ⓐ Surface-mounted installation
- Ⓑ Flush-fit installation

DAD 6880: side-by-side installation of the cooker hood and the hob in the same cut-out

Example: combination with KM 8684 FL or KM 8685 FL

Surface-mounted installation

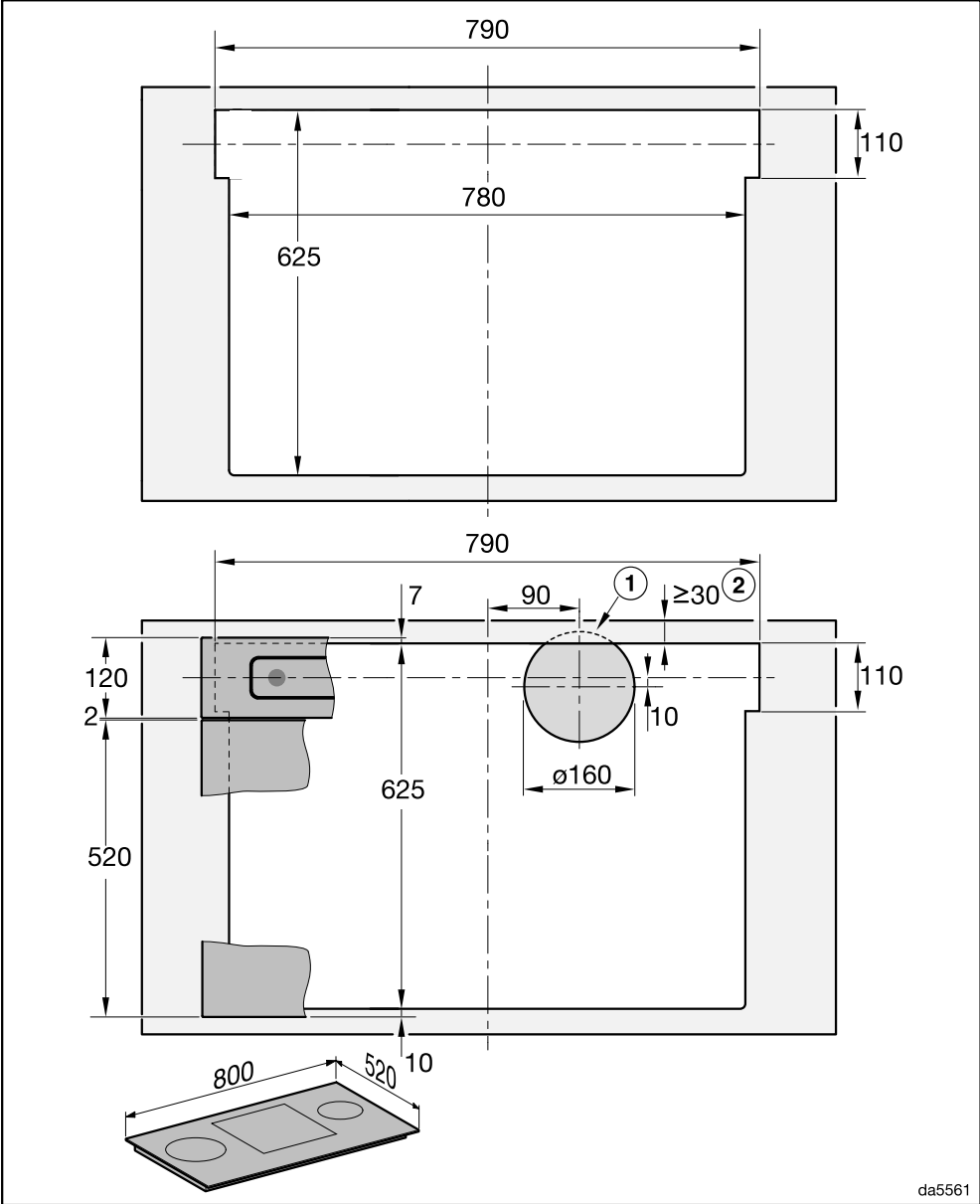

# Installation

DAD 6880: side-by-side installation of the cooker hood and the hob in the same cut-out

Example: combination with KM 8684 FL or KM 8685 FL

Flush-fit installation

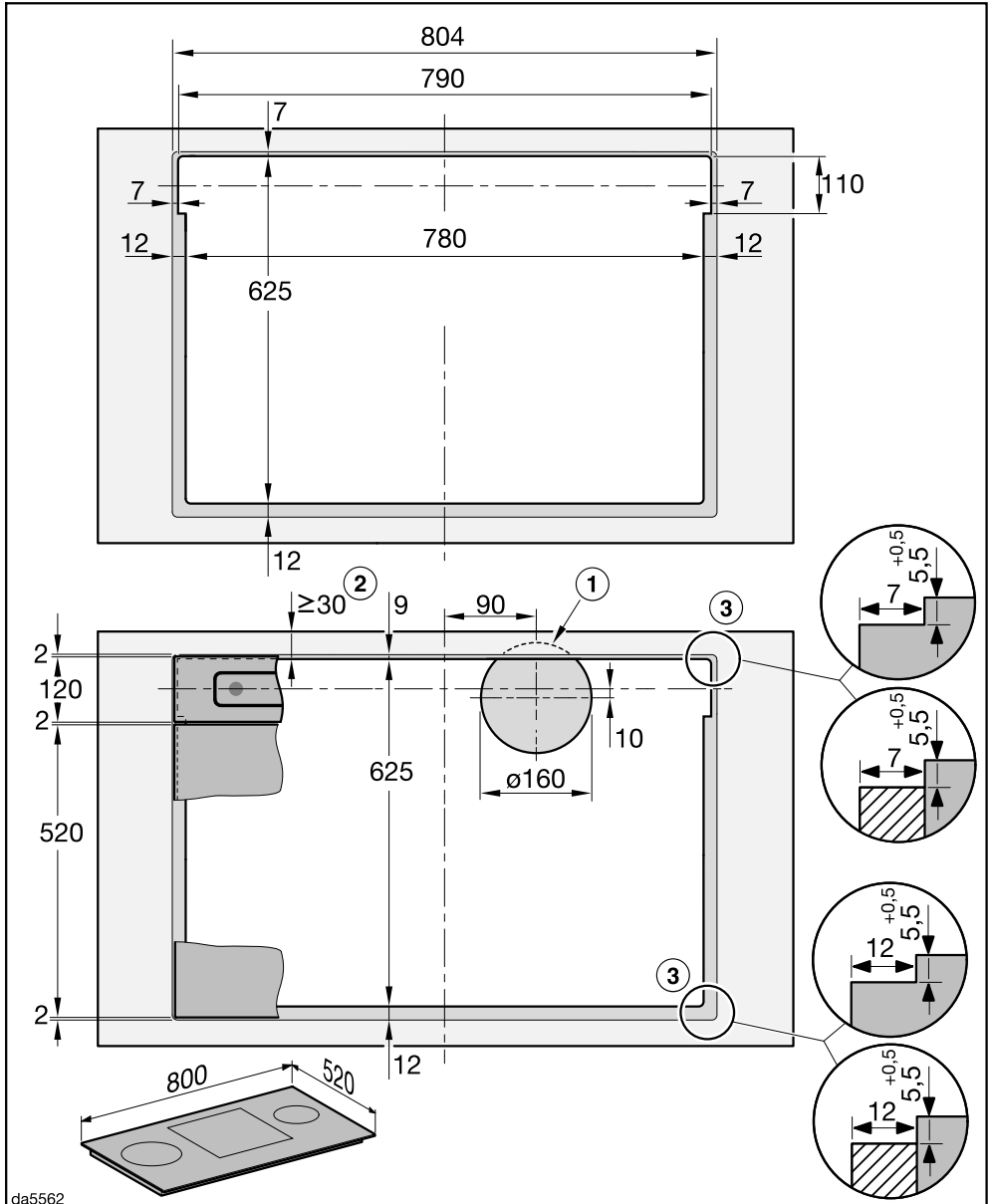

da5562





- ① Cut-out for vent ducting  $\varnothing$  150 mm in unit floor
- ② Ensure that the worktop is sufficiently stable.
- ③ Stepped cut-out for flush-fit installation in a worktop
  - Note the different milling widths for the hob and the cooker hood.
  - Instead of a stepped cut-out, a wooden frame (not included in scope of delivery) that has been moved downwards by 5.5 mm can be installed as an alternative.
  - To prevent the milling behind the glass panel from showing through, colour the milling in black.

See also the operating and installation instructions for the hob for more information.

## Sealing the gaps



Damage from unsuitable sealant.

Unsuitable sealant can damage natural stone.

For natural stone worktops and natural stone tiles, only use silicone sealant that is specially formulated for natural stone. Follow the manufacturer's instructions.

- Use a silicone sealant that is heat-resistant to at least 160 °C to seal the gap between the downdraft extractor and worktop (flush-fit installation) or between the downdraft extractor and hob (side-by-side installation).

# Installation

## Installation examples

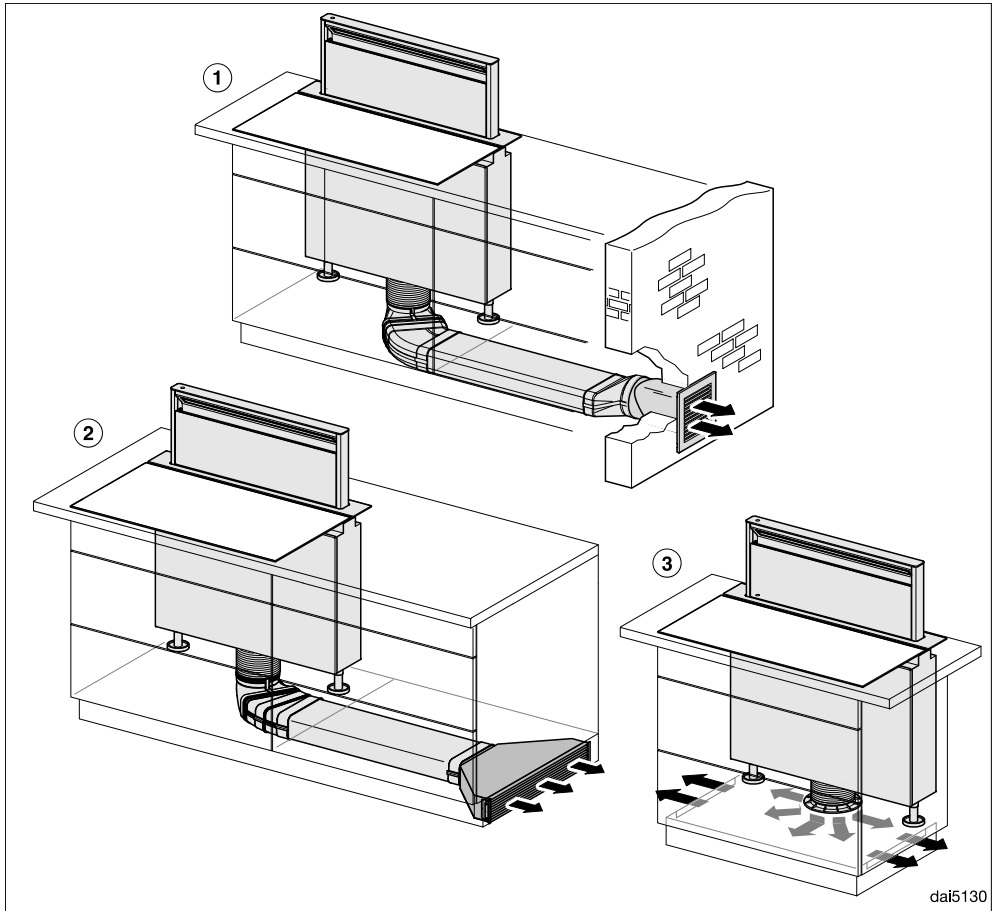

- ① Extraction mode with flat ducting and DMK 150-1 wall box
- ② Recirculation mode with flat ducting and DUU 600 recirculation box
- ③ Plug&Play operation with DUP 150 conversion kit  
During Plug&Play operation, ensure sufficient ventilation of the plinth area, e.g. through gaps in the plinth panel.  
The cross-section of the openings must be at least  $425 \text{ cm}^2$  in total.  
If the floor meets the ground or is exposed to outside air, the heat transfer coefficient of the floor must not exceed  $0.5 \text{ W}/(\text{m}^2 \text{ K})$ .  
The electronic module for vapour extraction must be switched to Plug&Play operation, see “Before using for the first time” – “Setting up Plug&Play”.

## Connection for air extraction

Only use smooth pipes or flexible exhaust ducting made from approved non-flammable materials for exhaust ducting.

To achieve the most efficient air throughput with the lowest noise levels, please note the following:

- The diameter of the exhaust ducting must not be smaller than the cross-section of the exhaust duct (see “Appliance dimensions”). This applies in particular when using flat ducting.
- The exhaust ducting should be as short and straight as possible.
- Only use wide radius bends.
- The exhaust ducting must not be kinked or compressed.
- All connections must be strong and airtight.
- If the exhaust ducting has flaps, these must be opened whenever the cooker hood is switched on.

Any constriction of the air throughput will reduce extraction performance and increase operating noise.

## Flue

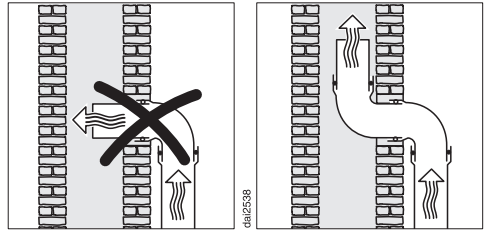

If the exhaust air is to be ducted into a flue, the ducting must be directed in the flow direction of the flue.

If the flue is used by several ventilation units, the cross-section of the flue must be large enough.

## Non-return flap

- Use a non-return flap in the exhaust system.

A non-return flap ensures that when the cooker hood is not in operation, the duct is closed to prevent unwanted exchange of room air and outside air.

If the exhaust is ducted through an outside wall, a Miele wall vent or roof vent (available as an optional accessory) is recommended. Both of these have a built-in non-return flap.

Miele shall not accept warranty claims for any functional defects or damage caused by inadequate exhaust ducting.

# Installation

---

## Electrical connection

The cooker hood is supplied with a mains cable with moulded plug ready for connection to a suitable earthed socket.

If the socket is not easily accessible or a fixed connection is envisaged, ensure that a suitable means of disconnection is provided on the installation side for each pole.

 Risk of fire from overheating. Connecting the cooker hood to multi-socket adapters or extension cables can overload the cables. For safety reasons, do not use an extension cable or multi-socket adapter.

The electrical system must comply with local and national safety regulations (BS 7671 in the UK).

For safety reasons, we recommend using a type  residual current device (RCD) in the relevant electrical installation for connecting the cooker hood.

If the mains connection cable is damaged, it must only be replaced with a specific mains connection cable of the same type (available from the Miele Customer Service Department). For safety reasons, such replacement may only be carried out by a qualified specialist or the Miele Customer Service Department.

These operating instructions and the data plate indicate the nominal power consumption and the appropriate fuse rating. Compare this information with the data of the on-site electrical connection.

If in any doubt, consult a qualified electrician.

Temporary or permanent operation on an autonomous power supply system or a power supply system that is not synchronised with the mains power supply (e.g. island networks, back-up systems) is possible. A prerequisite for operation is that the power supply system complies with the specifications of EN 50160 or an equivalent standard. The function and operation of the protective measures provided in the domestic electrical installation and in this Miele product must also be maintained in isolated operation or in operation that is not synchronised with the mains power supply, or these measures must be replaced by equivalent measures in the installation. As described, for example, in the current version of VDE-AR-E 2510-2.

## Technical data

Fan motor	180 W
Deflector plate motor	60 W
Hob lighting	12 W
Ambient lighting	8 W
Total rated load	260 W
Mains voltage, frequency	AC 230 V, 50 Hz
Fuse rating	10 A
Length of mains connection cable	1.5 m
Weight	34 kg

### WiFi module

Frequency band	2.400–2.4835 GHz
Maximum transmission power	< 100 mW

### Optional accessories for recirculation mode

Charcoal filter set DKF 30-P or DKF 30-R (reactivatable). The sets contain 2 charcoal filters.

You need the DUP 150 installation kit for Plug&Play operation. The kit contains a socket, a hose and the DKF 30-P charcoal filter set.

### EU Conformity declaration

Miele hereby declares that this downdraft extractor complies with Directive 2014/53/EU.

The complete text of the EU declaration of conformity is available from one of the following internet addresses:

- Products, Download from [www.miele.ie](http://www.miele.ie)
- For service, information, operating instructions etc: go to <https://miele.co.uk/manuals> and enter the name of the product or the serial number

### UK Conformity declaration

Miele hereby declares that this downdraft extractor complies with UK Radio Equipment Regulations 2017, as amended.

The complete text of the UK declaration of conformity is available from one of the following internet addresses:

- Products, Download from [www.miele.co.uk](http://www.miele.co.uk)

# Technical data

---

- For service, information, operating instructions etc: go to <https://miele.co.uk/manuals> and enter the name of the product or the serial number

This **Statement of Compliance** confirms this Miele product fully complies with the **Product Security and Telecommunications Infrastructure (Security Requirements for Relevant Connectable Products) Regulations 2023**.

- 1) Household Appliance – *Cooker Hood DAD 6880, DAD 6980*
- 2) Manufactured by: Miele & Cie KG,  
Carl Miele Street 29, 33332 Gutersloh Germany  
Imported by and contact point: Miele Company Ltd, Fairacres, Marcham Road,  
Abingdon, Oxon, OX14 ITW Great Britain
- 3) The defined support period at the time of first supply is 10 years
- 4) To report vulnerabilities and cybersecurity issues please contact: [psirt@miele.com](mailto:psirt@miele.com)

5) Signature   
Name: **Paul Wright**  
Company Position: **Head of Technical Management**  
Date of signature: **19th March 2024**  
Place of signature: **Abingdon, Oxfordshire**

## Note for test institutes

Energy efficiency must be calculated using extraction mode. The cooker hood is set up ex-works for recirculation mode. To re-set it for extraction mode the operating hours counter for the charcoal filter(s) has to be deactivated (see “Before using for the first time”).

## Data sheet for household cooker hoods

In acc. with delegated regulation (EU) No. 65/2014 and regulation (EU) No. 66/2014

<b>MIELE</b>	
<b>Model name/identifier</b>	DAD 6880 Levantar Ambient
Annual Energy Consumption ( $AEC_{hood}$ )	41,1 kWh/year
Energy efficiency class	A
Energy efficiency index ( $EEl_{hood}$ )	49,6
Fluid Dynamic Efficiency ( $FDE_{hood}$ )	33,4
Fluid Dynamic Efficiency class	
A (most efficient) to G (least efficient)	A
Lighting Efficiency ( $LE_{hood}$ )	33,0 lx/W
Lighting Efficiency class	
A (most efficient) to G (least efficient)	A
Grease Filtering Efficiency	85,1%
Grease Filtering Efficiency class	
A (most efficient) to G (least efficient)	B
Airflow at best efficiency point	307,1 m <sup>3</sup> /h
Air flow (min. speed)	209 m <sup>3</sup> /h
Air flow (max. speed)	453 m <sup>3</sup> /h
Air flow (intensive or boost setting)	655 m <sup>3</sup> /h
Max. air flow ( $Q_{max}$ )	655,0 m <sup>3</sup> /h
Air pressure at best efficiency point	434 Pa
Airborne acoustical A-weighted sound power emissions (min. speed)	43 dB
Airborne acoustical A-weighted sound power emissions (max. speed)	62 dB
Airborne acoustical A-weighted sound power emissions (intensive or boost setting)	71 dB
Electrical power input at best efficiency point	110,8 W
Power consumption in standby mode ( $P_s$ )	0,29 W
Nominal power of lighting system	12,0 W
Average illumination of the lighting system on the cooking surface	400 lx
Time increase factor	0,8

# Technical data

## Data sheet for household cooker hoods

In acc. with delegated regulation (EU) No. 65/2014 and regulation (EU) No. 66/2014

<b>MIELE</b>	
<b>Model name/identifier</b>	DAD 6980 Levantar Ambient
Annual Energy Consumption ( $AEC_{hood}$ )	41,1 kWh/year
Energy efficiency class	A
Energy efficiency index ( $EEL_{hood}$ )	49,6
Fluid Dynamic Efficiency ( $FDE_{hood}$ )	33,4
Fluid Dynamic Efficiency class	
A (most efficient) to G (least efficient)	A
Lighting Efficiency ( $LE_{hood}$ )	33,0 lx/W
Lighting Efficiency class	
A (most efficient) to G (least efficient)	A
Grease Filtering Efficiency	85,1%
Grease Filtering Efficiency class	
A (most efficient) to G (least efficient)	B
Airflow at best efficiency point	307,1 m <sup>3</sup> /h
Air flow (min. speed)	209 m <sup>3</sup> /h
Air flow (max. speed)	453 m <sup>3</sup> /h
Air flow (intensive or boost setting)	655 m <sup>3</sup> /h
Max. air flow ( $Q_{max}$ )	655,0 m <sup>3</sup> /h
Air pressure at best efficiency point	434 Pa
Airborne acoustical A-weighted sound power emissions (min. speed)	43 dB
Airborne acoustical A-weighted sound power emissions (max. speed)	62 dB
Airborne acoustical A-weighted sound power emissions (intensive or boost setting)	71 dB
Electrical power input at best efficiency point	110,8 W
Power consumption in standby mode ( $P_s$ )	0,29 W
Nominal power of lighting system	12,0 W
Average illumination of the lighting system on the cooking surface	400 lx
Time increase factor	0,8

## United Kingdom

Miele Co. Ltd., Fairacres, Marcham Road, Abingdon, Oxon, OX14 1TW  
Tel: 0330 160 6600, Internet: [www.miele.co.uk](http://www.miele.co.uk), E-mail: [info@miele.co.uk](mailto:info@miele.co.uk)

### Australia

Miele Australia Pty. Ltd.  
ACN 005 635 398  
ABN 96 005 635 398  
Level 4, 141 Camberwell Road  
Hawthorn East, VIC 3123  
Tel: 1300 464 353  
E-mail: [info@miele.com.au](mailto:info@miele.com.au)  
Internet: [www.miele.com.au](http://www.miele.com.au)

### China Mainland

Miele Electrical Appliances Co. Ltd.  
No. 82, Shimenyi Road, JingAn District  
Shanghai, China, P.R.C  
Post Code: 200040  
Phone: +86 21 6157 3500  
Fax: +86 21 6157 3511  
E-mail: [info@miele.cn](mailto:info@miele.cn)  
Internet: [www.miele.cn](http://www.miele.cn)

### Hong Kong, China

Miele (Hong Kong) Ltd.  
41/F - 4101, Manhattan Place  
23 Wang Tai Road  
Kowloon Bay, Hong Kong  
Tel: (852) 2610 1025  
Fax: (852) 3579 1404  
E-mail:  
[customerservices@miele.com.hk](mailto:customerservices@miele.com.hk)  
Website: [www.miele.hk](http://www.miele.hk)

### India

Miele India Pvt. Ltd.  
1st Floor, Copia Corporate Suites,  
Commercial Plot 9, Mathura Road,  
Jasola, New Delhi - 110025  
E-mail: [customercare@miele.in](mailto:customercare@miele.in)  
Website: [www.miele.in](http://www.miele.in)

### Ireland

Miele Ireland Ltd.  
2024 Bianconi Avenue  
Citywest Business Campus  
Dublin 24  
Tel: (01) 461 07 10  
Fax: (01) 461 07 97  
E-mail: [info@miele.ie](mailto:info@miele.ie)  
Internet: [www.miele.ie](http://www.miele.ie)

### Malaysia

Miele Sdn Bhd  
Suite 12-2, Level 12  
Menara Sapura Kencana  
Petroleum  
Solaris Dutamas No. 1  
Jalan Dutamas 1  
50480 Kuala Lumpur, Malaysia  
Phone: +603-6209-0288  
Fax: +603-6205-3768

### New Zealand

Miele New Zealand Limited  
IRD 98 463 631  
8 College Hill  
Freemans Bay, Auckland 1011  
Tel: 0800 464 353  
E-mail: [customercare@miele.co.nz](mailto:customercare@miele.co.nz)  
Internet: [www.miele.co.nz](http://www.miele.co.nz)

### Singapore

Miele Pte. Ltd.  
29 Media Circle  
#11-04 ALICE@Mediapolis  
Singapore 138565  
Tel: +65 6735 1191  
Fax: +65 6735 1161  
E-mail: [info@miele.com.sg](mailto:info@miele.com.sg)  
Internet: [www.miele.sg](http://www.miele.sg)

### South Africa

Miele (Pty) Ltd.  
63 Peter Place, Bryanston 2194  
P.O. Box 69434, Bryanston 2021  
Tel: (011) 875 9000  
Fax: (011) 875 9035  
E-mail: [info@miele.co.za](mailto:info@miele.co.za)  
Internet: [www.miele.co.za](http://www.miele.co.za)

### Thailand

Miele Appliances Ltd.  
BHIRAJ TOWER at EmQuartier  
43rd Floor Unit 4301-4303  
689 Sukhumvit Road  
North Klongton Sub-District  
Vadhana District  
Bangkok 10110, Thailand

### United Arab Emirates

Miele Appliances Ltd.  
Showroom 1, Eiffel 1 Building  
Sheikh Zayed Road, Umm Al Sheif  
P.O. Box 114782 - Dubai  
Tel. +971 4 3044 999  
Fax. +971 4 3418 852  
800-MIELE (64353)  
E-mail: [info@miele.ae](mailto:info@miele.ae)  
Website: [www.miele.ae](http://www.miele.ae)

**Manufacturer:** Miele & Cie. KG, Carl-Miele-Straße 29, 33332 Gütersloh, Germany

DAD 6880, DAD 6980

en-GB

M.-Nr. 12 815 850 / 00