

Operating Instructions Commercial Dishwasher PG 8056 -1



To prevent accidents and machine damage, you absolutely **must** read these instructions before installation or use.

en-US

Contents

Guide to the manual	5
Proper use	6
IMPORTANT SAFETY INSTRUCTIONS	7
Symbols attached to the commercial dishwasher	11
Disposal of the commercial dishwasher	11
Product description	12
Machine overview.....	12
Control panel.....	13
User profiles	14
User groups.....	14
Daily operators	14
Experienced operators	14
Operation tips	15
Display functions.....	15
Menus.....	16
Symbols in the display	18
Commissioning	19
Opening and closing the door	23
Opening the door	23
Closing the door.....	23
Filling the salt container	24
Reactivating.....	24
Setting the water hardness level	25
Salt refill reminder.....	27
Appliance lockdown due to low salt	27
Adding rinse aid	30
Rinse aid.....	30
Rinse aid indicator.....	30
Application technology	32
Preparing the load	32
Upper basket.....	34
Adjusting the upper basket	35
Lower basket.....	37
Use of plastic trays.....	39
Operation	41
Adding detergent.....	41
Tips for the Rapid program	42
Dispenser module	43
Turning on the dishwasher	47
Selecting a program	47
Starting a program	49
At the end of the program	50
Turning off the dishwasher	50
Unloading the dishwasher.....	50
Interrupting a program.....	51

Cancelling a program	52
Additional functions	53
Delay Start.....	53
Program chart	54
Settings ▾	58
Menu structure	59
Delay Start.....	60
Setting the language ▾	61
Venting DOS modules	62
Setting the date	63
Date format.....	63
Setting the date	63
Setting the time of day	64
Setting the time	64
Display.....	65
Clock format.....	65
Adjusting the volume.....	66
Keypad	66
Buzzer.....	66
Setting the volume	67
Additional settings	68
Accessing the “Additional settings” menu	68
Menu structure	70
Code.....	72
Release.....	72
Changing the PIN code	72
Log book	74
Temperature unit.....	75
Moving a program	76
Additional functions.....	77
Resetting	77
Increased amount of water.....	78
Interim rinse.....	78
DOS dispensing systems	79
Temperature / Time	82
Program access.....	85
Water hardness	86
Display view	86
Display.....	87
Contrast.....	87
Brightness	87
Switch off after	88
Factory default setting.....	89
Software version.....	90
Cleaning and care	91
Maintenance.....	91
Cleaning the control panel	92
Cleaning the front of the dishwasher	92

Contents

Cleaning the wash cabinet	92
Cleaning the door and the door seal	93
Cleaning the filters in the wash cabinet	93
Cleaning the spray arms.....	95
Frequently asked questions	97
Faults with water intake or drainage.....	97
Unusual behavior of the dishwasher	100
Noises.....	101
Poor cleaning results	102
Frequently asked questions	104
Cleaning the water intake filter	104
Cleaning the drain pump and non-return valve.....	105
After sales service	107
Installation instructions	108
Caring for the environment	109
Installation	110
Installation	110
Undercounter installation	110
Leveling and securing the dishwasher	111
Moving the dishwasher	112
Electrical connection	113
Peak-load negotiation	114
Plumbing	115
Connecting the water supply	115
Connection to the drainage system	117
Technical details	118

Warnings

 Warnings important for safety are highlighted like this. Warnings alert you to potential injury and damage. Read the warnings carefully and follow the instructions and directions.

Notes

Notes contain information that is particularly important to follow. They are highlighted by a thickly framed box.

Additional information and comments

Additional information and comments are contained in a narrow frame.

Operating steps

Instructions on how to operate the Commercial Dishwasher are identified by specially marked operating steps. They explain the procedure step by step.

Operating steps are identified by a black square.

Example:

- Open the door of the Commercial Dishwasher.

Display

Information that is shown in the Commercial Dishwasher display appears in a special font similar to the display text.

Example:

Select *Delay start* and confirm your choice with the *OK* button.

Proper use

This Commercial Dishwasher complies with all current local and national safety requirements. Inappropriate use can, however, lead to personal injury and material damage.

Read the operating instructions carefully before using the Commercial Dishwasher for the first time. They contain important information on the safety, use, and maintenance of the machine. You will prevent the risk of accidents and damage to the Commercial Dishwasher. Keep these operating instructions in a safe place and pass them on to any future user.

- ▶ With its short program running times and powerful cleaning performance, this Miele commercial dishwasher is intended for commercial use in commercial environments.
 - commercial environments
- ▶ This machine is designed exclusively for use as a “dishwasher” for cleaning wash items as described in these instructions. Any other use, conversions, and modifications are not permitted and could be dangerous.

Miele cannot be held liable for damage resulting from incorrect or improper use or operation.
- ▶ This dishwasher is intended for stationary, indoor use only.
- ▶ The special inserts are to be used for their specific purpose only.
- ▶ This dishwasher is not suitable for cleaning medical products.
- ▶ Persons which lack physical, sensory or mental abilities or experience with the machine should not use it without supervision or instruction by a responsible person.

IMPORTANT SAFETY INSTRUCTIONS

Proper installation

- ▶ Do not install the machine in an area where a danger of explosion or of freezing temperatures may be present.
- ▶ To ensure the stability of undercounter dishwashers, these units may only be installed beneath a continuous countertop that is bolted to adjacent cabinetry.
- ▶ In order to reduce the risk of damage from condensation, the furniture in the area around the dishwasher should be designed for commercial use.

Technical safety

- ▶ Installation and repair work should be performed by a qualified and trained service technician in accordance with local and national safety regulations. Work by unqualified persons could be dangerous and may void the warranty.
- ▶ This dishwasher must only be operated by appropriately trained personnel. They must be instructed and trained regularly.
- ▶ Before using the dishwasher, check it for any externally visible damage. Do not use a damaged dishwasher. This could be dangerous.
- ▶ In the event of a damaged or leaking dishwasher, switch off at the power supply immediately and call Miele Technical Service, a Miele dealer, or a suitably qualified service technician.
- ▶ Faulty components may only be replaced by genuine Miele original parts. Only when these parts are fitted can Miele guarantee the safety standards of the appliance.
- ▶ The electrical safety of this dishwasher can only be guaranteed when correctly grounded. If in any doubt, please have the electrical installation tested by a qualified electrician. Miele cannot be held liable for the consequences of an inadequate grounding system (e.g., electric shock).
- ▶ Be sure to follow the installation instructions in this manual and in the installation diagram.
- ▶ Ensure that the connection data on the data plate (voltage, frequency, and fuse rating) match those of your electrical supply.
- ▶ **WARNING - Fire hazard!** Do not cover or crush the plug of the appliance. Ensure that the cabinet opening for the dishwasher provides ample space for the plug and cord. Installing the dishwasher in a tight space may crimp the power cord or put pressure on it. See "Electrical connection".
- ▶ Do not use an extension cord to connect this machine to electricity. Extension cords do not guarantee the required safety of the machine (e.g., danger of overheating).

IMPORTANT SAFETY INSTRUCTIONS

- ▶ Do not open the casing of the dishwasher. Any contact with live connections or tampering with the electrical or mechanical components of the dishwasher will endanger your safety and may lead to machine malfunctions.
- ▶ The dishwasher must not be used if the wire is damaged. A damaged wire may only be replaced by a suitable wire of the same type. For safety reasons, such replacement may only be carried out by Miele Technical Service or a qualified service technician.
- ▶ Before servicing the appliance, disconnect it from the power supply.
- ▶ The plastic housing of the water connection contains electrical components. It must not be dipped in water.
- ▶ There are live wires in the water intake hose. Do not shorten the water intake hose, even if it is too long.
- ▶ The built-in Waterproof system offers reliable protection against water damage if the following conditions are met:
 - Installation has been carried out correctly.
 - The dishwasher is properly maintained and parts are replaced in case of noticeable damage.
 - The faucets have been turned off during longer absences (for example, vacation).

The Waterproof system will work even when the dishwasher is switched off. However, the dishwasher must remain connected to the electricity supply.

IMPORTANT SAFETY INSTRUCTIONS

Correct use

- ▶ This commercial dishwasher is designed for operation with water and detergents suitable for use in commercial or residential dishwashers only. Organic solvents and flammable liquid agents must not be used.
This could cause an explosion, property damage due to the destruction of rubber or plastic, and the resulting leakage of liquids.
- ▶ Do not sit, stand, or lean on the opened door. This could tip or damage the dishwasher.
- ▶ After any plumbing work, the water pipework to the dishwasher will need to be vented. If this is not done, components can be damaged.
- ▶ Please be aware that the dishwasher may be operating at high temperatures. When the door is opened there is a risk of burning or scalding. Wash items, baskets, and inserts must be allowed to cool down before they are unloaded. Any water remaining in containers could still be very hot. Empty them into the wash cabinet before taking them out.
- ▶ The water in the wash cabinet is NOT safe to drink!
- ▶ The pretreatment of items (for example with dishwashing liquid and other detergents), but also some types of soiling and some detergents, can cause a build-up of foam in the wash cabinet. Foam can have an adverse effect on the cleaning result.
- ▶ Foam escaping from the wash chamber can cause damage to the dishwasher. If foam escapes, the program must be canceled immediately and the dishwasher must be disconnected from the mains electrical supply.
- ▶ When using detergents and specialized products, it is essential that the manufacturer's instructions are followed. Detergents must only be used for the purpose they are designed for by the manufacturer to avoid any material damage or the occurrence of strong chemical reactions (e.g., oxyhydrogen explosion).
- ▶ Do not inhale or ingest powder detergent. Dishwasher detergents contain irritant or corrosive ingredients which can cause burning in the nose, mouth and throat if swallowed, or inhibit breathing. Seek medical attention immediately if detergent has been swallowed or inhaled.
- ▶ Miele cannot be held liable for any effect chemical detergents may have on the material of the items being cleaned. Observe the detergent manufacturer's instructions with regard to storage conditions, use, and dosage.
- ▶ To avoid material damage and corrosion, do not allow any acids or solutions containing chloride to get into the wash cabinet. Similarly avoid any materials with a corrosive effect.

IMPORTANT SAFETY INSTRUCTIONS

- ▶ Do not wash items soiled with ash, sand, wax, lubricating grease, or paint in the dishwasher. These materials will cause damage to the dishwasher.
- ▶ Do not clean the dishwasher or its near vicinity with a hose or a pressure washer.
- ▶ Ensure that the outer casing of the machine does not come into contact with solutions or steam containing acid to avoid any corrosion damage.
- ▶ Be careful when sorting items with sharp pointed ends and positioning them in the dishwasher so that you do not hurt yourself or create a danger for others. Cutlery should be placed in baskets in such a way that no injuries can occur.
- ▶ Remove any coarse food deposits from the items being cleaned before loading them in the dishwasher.

Children in the vicinity

- ▶ Children should be supervised in the vicinity of the dishwasher. Never allow children to play with the dishwasher. There is a danger that children might shut themselves in the dishwasher.
- ▶ Children must not be allowed to operate this dishwasher.
- ▶ Keep children away from process chemicals. These contain ingredients which can cause burning in the mouth or throat, or inhibit breathing. Keep children away from the dishwasher when the door is open. There could still be residual process chemicals in the dishwasher. Seek medical advice immediately if a child has swallowed or inhaled any process chemicals.

Accessories

- ▶ Only use genuine Miele original spare parts and accessories with this dishwasher. Miele will provide you with the article designations of the accessories.
- ▶ Only use Miele baskets and inserts with this dishwasher. Using baskets and inserts made by other manufacturers, or making modifications to Miele accessories can cause unsatisfactory cleaning results, for which Miele cannot be held liable. Any resultant damage would not be covered by the guarantee.

IMPORTANT SAFETY INSTRUCTIONS

Symbols attached to the commercial dishwasher

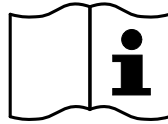

Attention:
Observe the operating instructions!



Attention:
Danger of electric shock!



Warning: Hot surfaces:
It can be very hot inside the wash chamber
when the door is opened!



Risk of being cut:
Wear cut-resistant protective gloves when
transporting and setting up the machine!

Disposal of the commercial dishwasher

- ▶ For safety and environmental reasons, dispose of all process chemicals according to the manufacturer's instructions and to safety regulations. Safety goggles and protective gloves should be worn.
- ▶ Remove or disable the door lock prior to disposal of the dishwasher, so that children cannot become trapped inside (see "Caring for the environment").

Miele cannot be held liable for damage caused by failure to comply with these safety instructions and warnings.

Product description



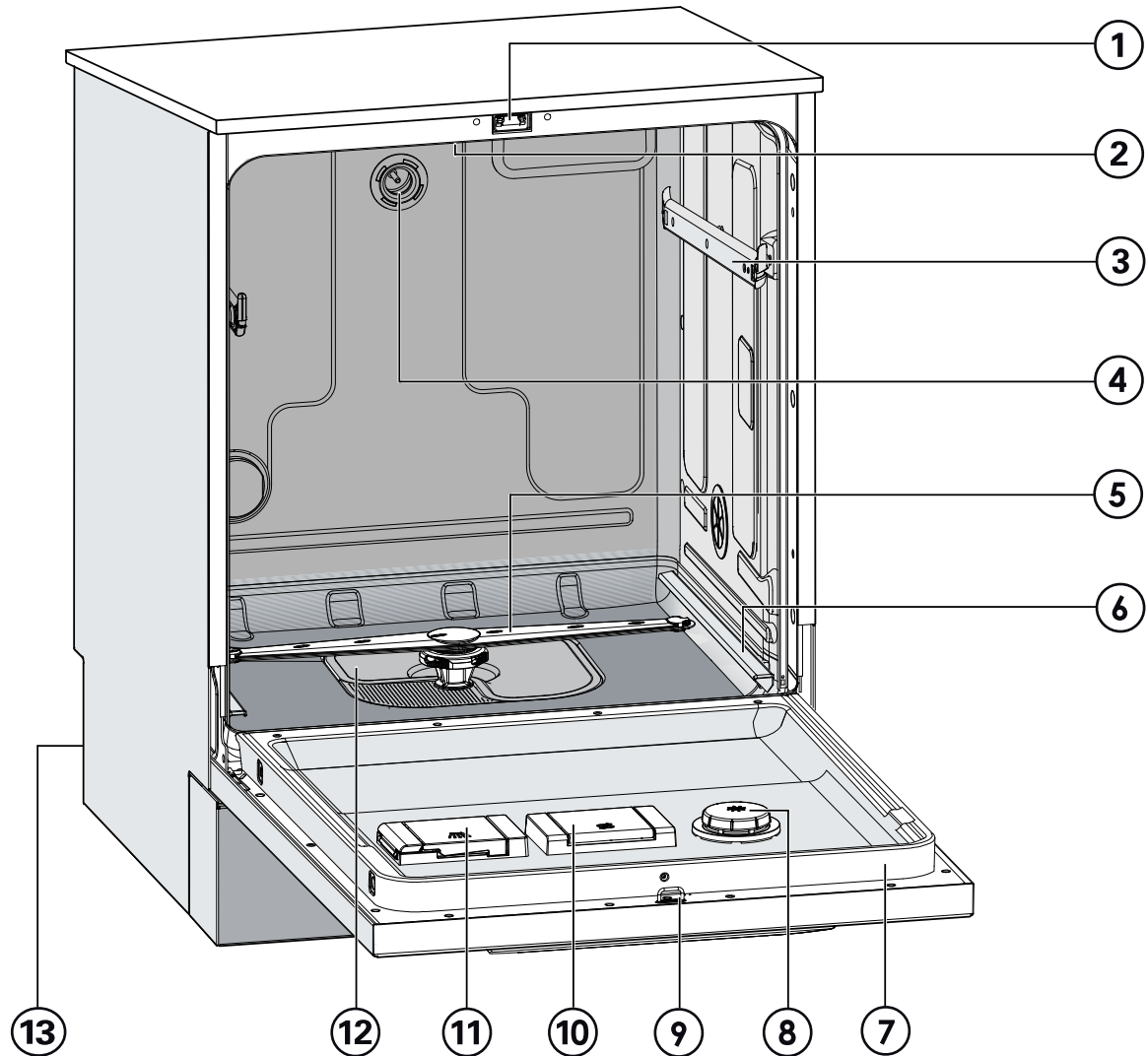



Machine overview

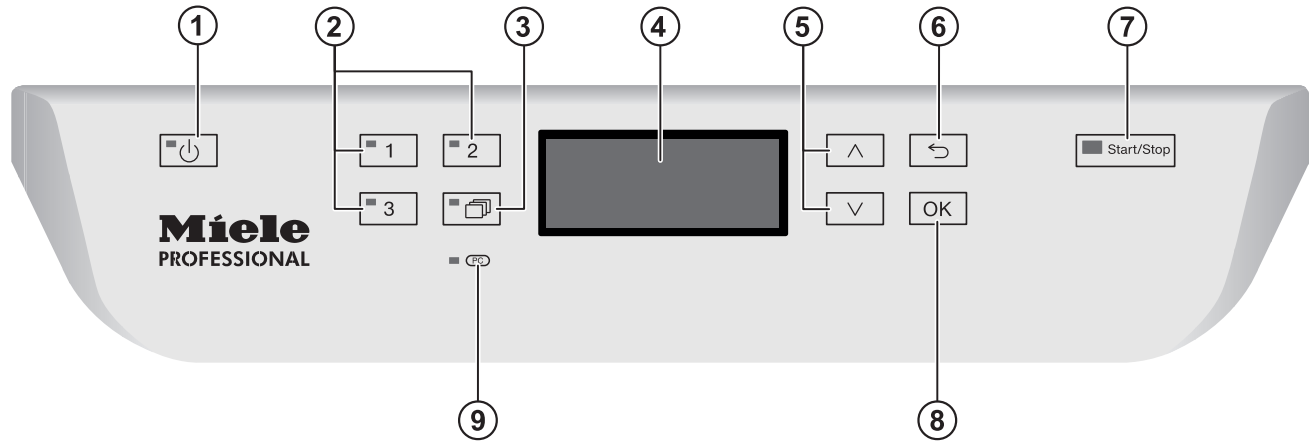

- ① Door lock
- ② Upper spray arm (not visible)
- ③ Upper basket runner
- ④ Connection for upper basket spray arm
- ⑤ Lower spray arm
- ⑥ Lower basket runner
- ⑦ Data plate
- ⑧ Rinse aid container
- ⑨ Door lock barrel
- ⑩ Container for reactivation salt
- ⑪ Dispenser for powder detergent
- ⑫ Filter combination
- ⑬ Back:
 - Connection for dispenser modules
 - External dispenser pump for liquid detergent (DOS1)
 - External dispenser pump for rinse aid (DOS4)

Control panel



- ①  (On/Off) Button
Turns the dishwasher on and off
- ② Buttons 1 - 3 (program selection buttons)
Shortcut buttons for storing favorite programs
- ③  button (additional programs)
For selecting additional programs
- ④ Display
User interface
- ⑤  and  button (arrow buttons)
Navigation in user interface
- ⑥  button (cancel or back)
Cancels a process in the user interface
(not for canceling programs)
- ⑦ *Start/Stop* button
Starts or cancels a program
- ⑧ *OK* button (confirmation)
Selects options or confirms entries in the user interface
- ⑨ Optical interface 
Testing and transmission point for Miele service technicians

User profiles

User groups

Users can be divided into two groups:

- Daily operators
- Experienced operators

Access to “Additional settings” can be blocked to general, daily operators by using a code (see “Additional settings, Code”).

Daily operators

Operators must be instructed in operating and loading the Commercial Dishwasher and trained regularly to guarantee safe daily use.

Experienced operators

Experienced operators can additionally block access to programs, modify temperature and holding times within program cycles, and alter water levels.

Display functions

The display is not a touch screen.

The following functions can be selected or set with the display:

- The program
- The delay start time
- The settings

The following appears in the display while a program is running:

- The program name
- The program stage / target temperature / actual temperature
- The estimated time left for the program to run
- Any relevant fault messages and information

Menu operation

This dishwasher is operated exclusively via buttons on the control panel. Arranged to the side of the display, the buttons (button fields) are printed on the stainless steel control panel. They are operated by pressing gently.



Menu operation is via the keypad to the right of the display.

- ^ button
For navigating upwards by row within a menu, or increasing the value highlighted.
- ↶ button (Cancel or back)
For ending a menu early. Any changes to settings are not saved and the display reverts to the previous menu.
- v button
For navigating downwards by row within a menu, or decreasing the value highlighted.
- OK button
For confirming a selection or for saving input. The display moves to the next menu or, when entering values, to the next input position. The procedure for entering the values is described in the respective chapter.

Operation tips

Menus

The Commercial Dishwasher's user interface is divided into different menus. These menus are displayed in a 3-line display on the control panel.

Example:



The name of the menu and a maximum of two menu options are shown. The currently selected option is highlighted.

Single selection



Use the \wedge and \vee arrow buttons to navigate through the menu. The highlighted option is selected by pressing the *OK* button. The option which is selected will have a check \checkmark next to it. The other options are automatically deselected.

Press the *OK* button to progress to the next menu, or to the next input position when entering values. The procedure for entering values is described in the respective chapter. Press the \leftarrow button to revert to the previous menu without saving the entry.

Multiple selection

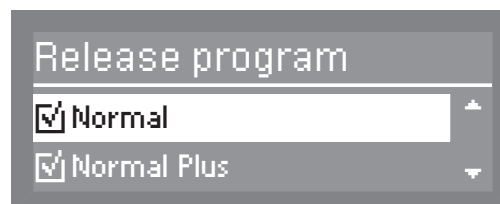

Use the \wedge and \vee arrow buttons to navigate through the menu. Several options can be selected in succession within the menu using the *OK* button. Once selected, an option will have a check \checkmark beside it.

To save your selection, select *Accept* and confirm with the *OK* button.

System messages The **i** symbol denotes system messages. These give information about current processes and the status of the Commercial Dishwasher. System messages are displayed individually at the end of the program. If there are a number of system messages, subsequent messages can be displayed by pressing the *OK* button. System messages can also be displayed during the program cycle by pressing the *OK* button.

Example:

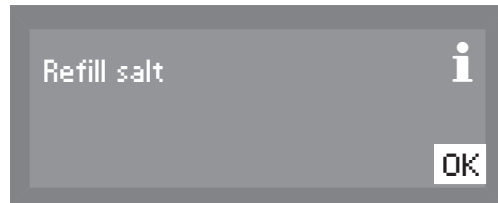

Automatic switch-off

The Commercial Dishwasher has an automatic switch-off function. The Commercial Dishwasher switches itself off automatically after the time set. The display and all other LEDs are switched off. To switch the Commercial Dishwasher back on, press the On/Off  button.

The automatic switch-off function can be deactivated (see “Additional settings, Switch off after”). The display will then remain switched on in idle mode.

Operation tips

Symbols in the display

Navigation arrows  If a menu contains more than two options, two navigation arrows are shown beside the options. The arrow buttons \wedge and \vee can be used to scroll through the options.

Dotted line ----- If a menu contains more than two options, the end of the option list is marked by a dotted line. The last entry appears above the line, the first entry below it.

Tick \checkmark If there are several options available, the current setting is marked with a tick \checkmark .

Example:



System messages **i** The **i** symbol denotes system messages. If OK appears in the bottom right of the display, the system message must be confirmed using the OK button. If OK does not appear in the display, after a few seconds the display skips to the next level up.

Fault messages  In the event of a fault, a warning triangle is shown in place of the **i** symbol. See "Frequently asked questions" for more information.

During commissioning, the following settings must be carried out. You will be asked to program settings one after the other automatically, and currently selected values will have a check ✓ beside them. The commissioning process requires a set period of time which cannot be interrupted.

The Commercial Dishwasher will guide you automatically through the steps required.

Reactivation is carried out during the first program following commissioning.

If the first program after commissioning is not completed and the Commercial Dishwasher is then switched off, the initial commissioning process must be carried out again.

The following options (with the exception of “Plumbing connections”) can be altered subsequently by selecting the “Settings 🚩” menu and “Additional settings”.

Switching on the machine

The dishwasher must be connected to the electrical supply.

Close the door
(door must be completely closed for commissioning).

- Press the ⏻ button until the button's LED lights up.

Setting the language

The commissioning process automatically begins at the language setting screen, where you will be prompted to set the display language.



- Use the ^ and v arrow buttons to select the desired language and confirm your choice with the OK button.

Commissioning

Setting the temperature unit

The display will then change to the screen for setting the temperature unit.

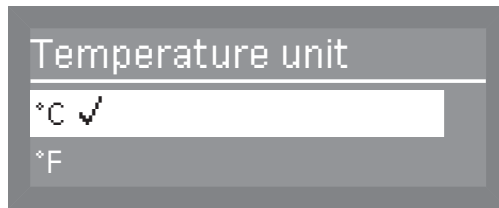

- Use the \wedge and \vee arrow buttons to select the desired temperature unit and confirm your choice with the *OK* button.

Setting the date format

The display will then change to the screen for setting the date format.



- Use the \wedge and \vee arrow buttons to select the desired date format and confirm your choice with the *OK* button.

Setting the date

The display will then change to the screen for setting the date.



- Use the arrow buttons \wedge (higher) and \vee (lower) to set the day, month, and year, and confirm each entry with the *OK* button.

Setting the clock format

The display will change to the screen for setting the clock format.

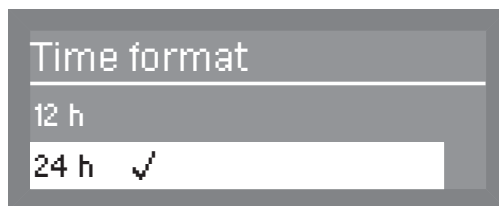

- Use the \wedge and \vee arrow buttons to select the desired format, and confirm your choice with the *OK* button.

Setting the time

The display will change to the screen for setting the time of day.



- Use the arrow buttons \wedge (higher) and \vee (lower) to set the hours and minutes, and confirm each entry with the *OK* button.

If you have selected 12 h for the clock format, “am” (in the morning) or “pm” (in the afternoon) will appear beside the time.

Setting the water hardness level

The display changes to the screen for setting the water hardness.

The dishwasher must be programmed to match exactly the hardness of your water.

- Your local water supplier can tell you the water hardness level in your area.
- Where the water hardness fluctuates (e.g. 8-18 gpg/8-17°dH), always program the dishwasher to the higher value (in this example, 18 gpg/17°dH).

It is useful to know your water hardness so that you can provide the service technician with this information in the event of any service calls.

- Enter the water hardness below:

_____gr/gal

The water hardness factory setting is programmed at 20 gpg (19°dH)

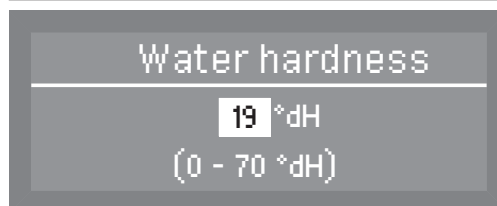

- Use the arrow buttons \wedge (higher) and \vee (lower) to set the water hardness required and confirm your entry by pressing the *OK* button.

See “Filling the container for reactivation salt” for more information about setting the water hardness level.

Commissioning

Water connections

The display will then change to the screen for setting the water connection.

This setting can be disabled if it is not possible to connect the dishwasher to all available water connections.

If individual water connections are disabled, they can only be enabled again by Miele Service.



- Use the \wedge and \vee arrow buttons to select the water connections which are not in use, and confirm your choice with the *OK* button.

The checkmark \checkmark will be removed from the box \square and the water connection is then disabled.

- Select *Accept* to save your choice, and confirm your setting with the *OK* button.

Commissioning completed

Commissioning is successfully completed and the following message will appear in the display.

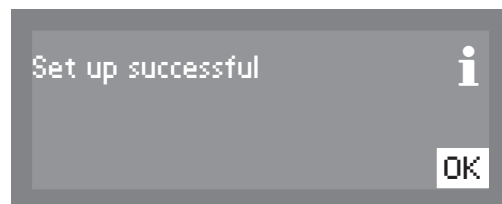

- Press the *OK* button.

The dishwasher is now ready for use.



The start screen is displayed for 3 seconds.

Then the first shortcut button program will appear in the display.

Opening the door

The control panel also serves as a door handle.

- Grasp the handle underneath the control panel and lower the door to open.

If the door is opened during operation all functions are automatically interrupted (see “Operation, Interrupting a program”).

A program which is already running should only be interrupted if strictly necessary, e.g. if the wash load is moving about significantly.

Closing the door

- Push the baskets in.
- Raise the door upwards until the catch engages.

Filling the salt container

Reactivating

In order to achieve excellent cleaning results, the Commercial Dishwasher needs to operate with soft water. Hard water results in the build-up of calcium deposits on wash items and on the wash cabinet walls.

Domestic water with a water hardness of 4 gpg (4°dH) must therefore be softened. This occurs automatically in the integrated water softener.

The water softener must be set to the exact hardness of the domestic water.

Your local water authority can give you information about the exact water hardness in your area.

It is useful to know your water hardness so that you can provide the service technician with this information in the event of any subsequent service calls. For this reason, please record the hardness level of your domestic water here:

_____ gpg or °dH

The water softener must also be reactivated at regular intervals. Special reactivation salt is required for this.

 **Damage to the water softener from detergent.**
Dishwasher detergent will damage the softener assembly.
Do not fill the container for reactivation salt with dishwasher detergent (including liquid detergent).

 **Damage caused by using unsuitable salts.**
Some types of salt may contain insoluble components which can cause the water softener to malfunction.
Use only special, coarse-grained reactivation salt or other pure kitchen salt.
Suitable products are available from Miele Professional.

If the hardness of your water is constantly less than 4 gpg (= 4°dH), no salt is required for the water softener.
However, you will still need to set the water hardness.

Setting the water hardness level

The water softener can be set to between 0 and 73 gpg (0 - 70 °dH German scale).

- Select the Additional settings menu.
- Select Water hardness and confirm your choice with the *OK* button.

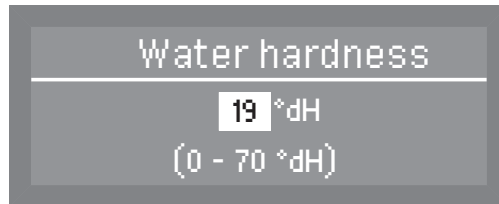

The factory default setting for the water softener is a hardness of 20 gpg (19°dH German scale).

Please observe the table below when setting the hardness level.

If the water hardness fluctuates, e.g. between 8 and 18 gpg (8 and 17 °dH German scale), always be sure to set the dishwasher to the higher value, 18 gpg (17 °dH German scale) in this example.

- Use the arrow buttons \wedge (higher) and \vee (lower) to set the required water hardness level, and confirm your entry with the *OK* button.

Filling the salt container

Settings table

gr/gal	ppm CaCO ₃	mmol/l	Display
0	0	0	0
1	20	0.2	1
2	40	0.4	2
3	50	0.5	3
4	70	0.7	4
5	90	0.9	5
6	110	1.1	6
7	130	1.3	7
8	140	1.4	8
9	160	1.6	9
10	180	1.8	10
11	200	2.0	11
12	220	2.2	12
13	230	2.3	13
14	250	2.5	14
15	270	2.7	15
16	290	2.9	16
17	310	3.1	17
18	320	3.2	18
19	340	3.4	19 *)
20	360	3.6	20
21	380	3.8	21
22	400	4.0	22
23	410	4.1	23
24	430	4.3	24
25	450	4.5	25
26	470	4.7	26
27	490	4.9	27
28	500	5.0	28
29	520	5.2	29
30	540	5.4	30
31	560	5.6	31
32	580	5.8	32
33	590	5.9	33
34	610	6.1	34
35	630	6.3	35

gr/gal	ppm CaCO ₃	mmol/l	Display
36	650	6.5	36
37	670	6.7	37
38	680	6.8	38
39	700	7.0	39
40	720	7.2	40
41	740	7.4	41
42	760	7.6	42
43	770	7.7	43
44	790	7.9	44
45	810	8.1	45
46	830	8.3	46
47	850	8.5	47
48	860	8.6	48
49	880	8.8	49
50	900	9.0	50
51	920	9.2	51
52	940	9.4	52
53	950	9.5	53
54	970	9.7	54
55	990	9.9	55
56	1000	10.0	56
57	1020	10.2	57
58	1040	10.4	58
59	1060	10.6	59
60	1070	10.7	60
61	1090	10.9	61
62	1110	11.1	62
63	1130	11.3	63
64	1150	11.5	64
65	1160	11.6	65
66	1180	11.8	66
67	1200	12.0	67
68	1220	12.2	68
69	1240	12.4	69
70	1250	12.5	70

*) Factory default setting

Salt refill reminder

- At the end of a program, fill the salt compartment with salt whenever the message appears in the display.
- Acknowledge the message with the *OK* button.

If no salt is added, the **i** symbol indicating low salt will appear beside the program name on the right.

The low salt message will appear again at the end of each program.

Refill reminders can be displayed during the program cycle by pressing the *OK* button.

If there are no additional refill reminders, the **i** symbol in the display will go out after a few seconds once the salt has been refilled.

The salt refill reminder is deactivated if the dishwasher is set to a water hardness of 0 - 0.7 mmol/l (0 - 4 °dH German scale).

Appliance lockdown due to low salt

If the low salt reminder is ignored for several program cycles and the salt is not refilled, the appliance will be locked to prevent further use until more salt is added.

The following message will appear in the display shortly before this happens:

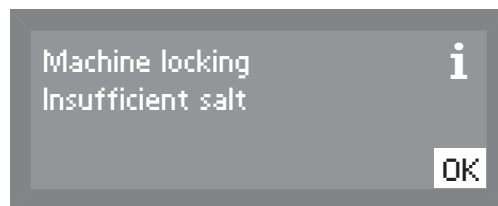

Depending on the selected program and the water hardness setting, only a few more program cycles will be possible.

If additional program cycles are run without the salt being refilled, the dishwasher will be locked to prevent operation.

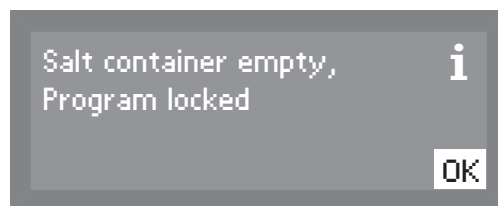

When reactivation salt is added, the appliance will automatically unlock after a few seconds.

Filling the salt container

Filling the container for reactivation salt

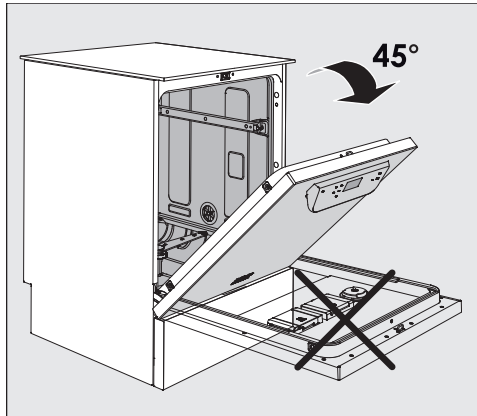

- When filling the salt container, **only open the door halfway** to ensure that all the salt gets into the container.

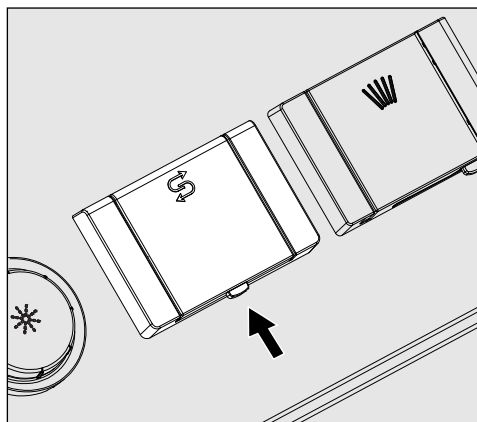

- Press the button on the lid of the salt container in the direction of the arrow. The flap will spring open.
- Open the funnel.

Do not pour any water into the salt container!

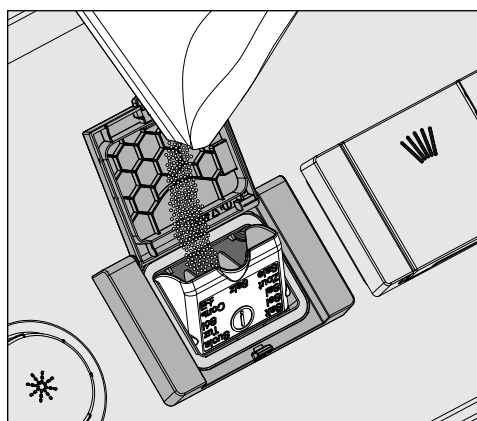

- Add salt into the container until the funnel is full but still closes easily. The salt container will take approx. 4.4 lb (2 kg) of salt on the first fill depending on the degree of coarseness. Subsequent refills may take less salt, as there may still be salt remaining in the container.

Filling the salt container

Do not add more than 4.4 lb (2 kg) of salt.

If there is water present in the container, it may be forced out by the added salt.

- Clean any excess salt from around the container opening and the seal surrounding it, and then close the flap.
- To avoid corrosion in the wash cabinet, run the Rinse program (without any wash items in the dishwasher) immediately after refilling the salt container. This will dilute and rinse away any remaining traces of salt.

Adding rinse aid

Rinse aid

Rinse aid is necessary to ensure water does not cling and leave marks on cookware before the drying phase and helps cookware dry faster after it has been washed.

Rinse aid can be poured into the reservoir in the door or can be dispensed via an external dispensing DOS module (Optional accessory - see "DOS module").

⚠ Only fill the rinse aid reservoir with rinse aid. Do not fill it with detergent (including liquid detergent). This will seriously damage the reservoir.

Suitable products are available from Miele Professional.

Conversion to the external DOS module must be carried out only by Miele Service or by an authorized dealer.

In the Glasses program, the final rinse is carried out without rinse aid.

Rinse aid indicator

- Refill the rinse aid at the end of a program whenever the message appears in the display.

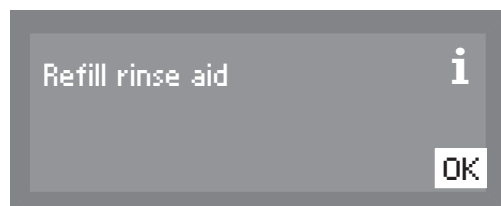

- Acknowledge the message with the OK button.

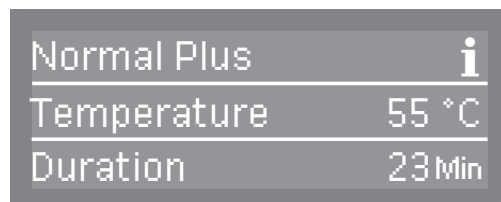

If rinse aid is not added, the **i** symbol indicating low rinse aid will appear beside the program name on the right.

The refill reminder will be displayed again at the end of every subsequent program.

Refill reminders can be displayed during the program cycle by pressing the **OK** button.

If there are no additional refill reminders, the **i** symbol in the display will go out a few seconds after the rinse aid has been refilled.

Adding rinse aid

- Open the door **fully**.

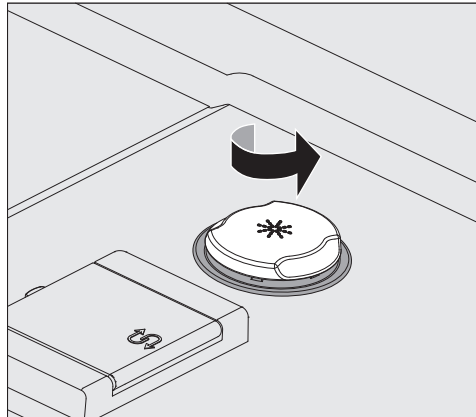

- Unscrew the lid of the rinse aid container.

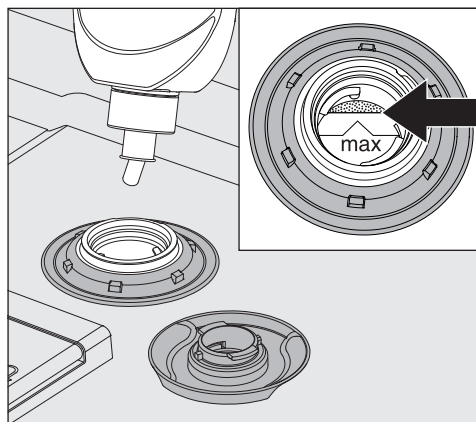

- Add rinse aid only until it is up to the maximum mark on the edge of the funnel on the container.

The rinse aid container holds approx. 10 oz. (300 ml).

- Screw the lid of the rinse aid container back on tightly so that water cannot get into the container during the wash cycle.
- Run the “Cold” program to rinse away any spilled rinse aid. This prevents over-foaming occurring during the next program.

You can adjust the dispensing quantity of the rinse aid for best results (see “Additional settings, Additional functions”).

Preparing the load

Remove coarse food residues from the dishware.

There is no need to rinse items under running water!

Tips

⚠ Ensure that no acid or solvent residues, especially hydrochloric acid or chlorides, get inside the machine.

⚠ Do not wash items soiled with ash, sand, wax, grease or paint in the dishwasher.

These substances will damage the dishwasher.

Load the dishware and utensils into their appropriate places in the baskets, but be sure to observe the following instructions:

- Load the dishware so that water can access all surfaces. This ensures that the items will be properly cleaned.
- Load plates symmetrically in the upper and lower baskets with the concave surfaces facing the center of the basket (as shown on the following pages).
- Do not place dishes or cutlery inside other pieces. They will cover one another.
- Make sure that all items are securely positioned.
- Hollow items such as cups, glasses and pans, etc. should be placed upside down in the baskets.
- Tall and narrow hollow items should be placed in the center of the basket if possible to ensure better water coverage.
- Concave items such as mugs or bowls should be placed at an angle so that the water can run off.
- The spray arms must not be blocked by items which are too tall or hang through the baskets. If in doubt, test for free movement by manually rotating the spray arms.
- Small items can fall through the holders in the baskets. Small items should therefore be placed in the cutlery basket.

Items not suitable for dishwashers:

- Wooden cutlery and cookware or items with wooden parts: these may discolor and fade. The glue used in these items is not dishwasher-proof and wooden handles may come loose after being washed in a dishwasher.
- Craft items, antiques, valuable vases and decorative glassware: such items are not suitable for dishwashers.
- Plastic items which are not heat resistant: the high temperatures in the dishwasher may cause them to melt or lose shape.
- Copper, brass, tin and aluminum items: these may discolor or become matt.
- Colors painted over a glaze: these may fade after a number of washes.
- Delicate glassware and glassware containing lead crystal: clouding may occur over time.

We recommend

- When purchasing new cookware and cutlery, make sure they are dishwasher-proof.
- Clouding may occur on glasses after frequent washing. If delicate glassware is washed in the dishwasher ensure that only a special glass-care program with very low temperatures (see program chart) is selected and that suitable detergent is used. This will reduce the risk of clouding.

Please note:

Silver and aluminum which has been in contact with foods containing sulfur can discolor.

⚠ Aluminum components (e.g. grease filters) must not be cleaned with caustic alkaline commercial or industrial cleaning agents. These may damage the material, or in extreme cases, there is a risk of a severe explosive chemical reaction (such as an explosive oxyhydrogen gas reaction).

Upper basket

Use the upper basket for small, lightweight and delicate items such as cups, saucers, glasses, dessert bowls etc. Light, heat resistant plastic items can also be loaded in the upper basket.

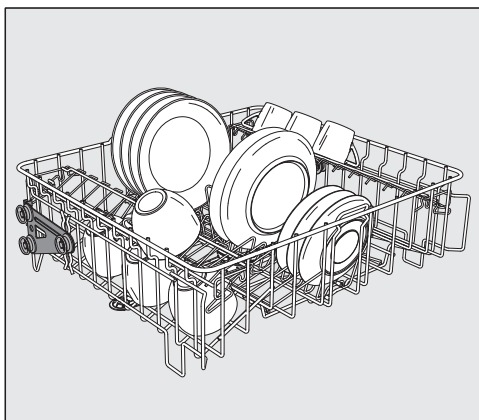

O 891 upper basket

With insert E 810 for e.g. 20 cups, 33 saucers or 17 dessert plates.

Cup rack

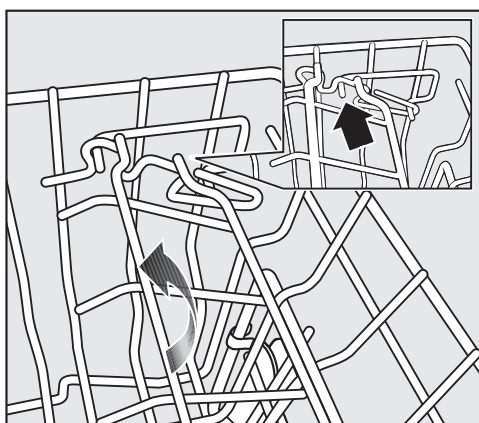

The cup rack can be set at two different widths so that it can also accommodate large cups.

- Pull the cup rack upwards and click it back into position at the required width.

Adjusting the upper basket

In order to obtain more space for taller items in the lower or upper basket, the upper basket can be adjusted between two vertical positions that are approx. 2" (5 cm) apart.

- Pull the upper basket out.

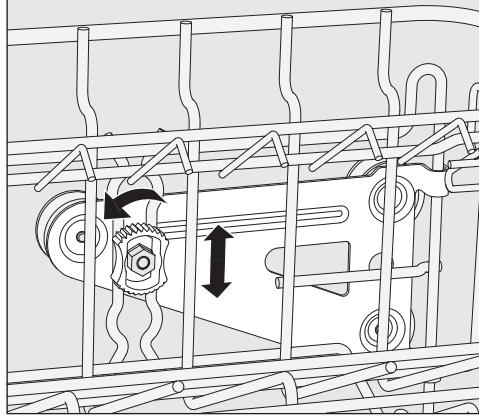

- Unscrew the lock nuts on both sides.
- Lift or lower the basket into the desired position.
- Tighten the lock nuts again.

⚠ The upper basket must be level in both positions.
If the basket is not level, the water connection will be blocked.

⚠ When changing the height of the upper basket, always adjust the water connection accordingly before pushing the upper basket back in.

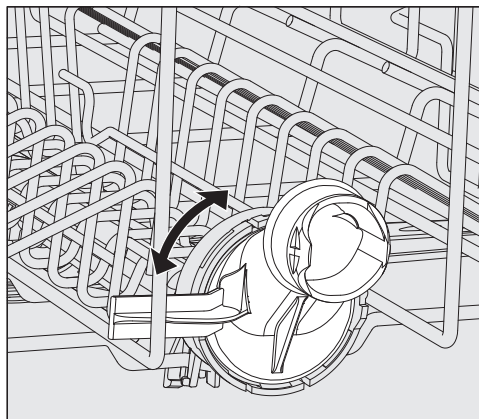

- Turn the upper basket water connection to the upper or lower position.
The water connection must click audibly into place.

Application technology

Depending on the position of the upper basket, the following plate dimensions can be accommodated:

Example with O 891 Upper Basket:

Upper basket position	Upper basket plate Ø	Lower basket plate Ø
Top	Max. 5 1/8" (15 cm)	13" (33 cm)*
Bottom	Max. 7 7/8" (20 cm)	9 3/4" (25 cm)

* The E 816 Plate Insert is required in the lower basket.

Lower basket

Use the lower basket for larger and heavier items such as plates, serving platters, saucepans, bowls, etc.

Always place thin, delicate glassware in the lower basket using a suitable insert or basket.

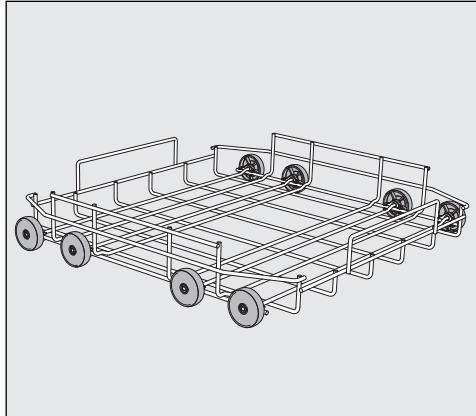

U 890 lower basket carrier

For plastic trays, various inserts and cutlery baskets.

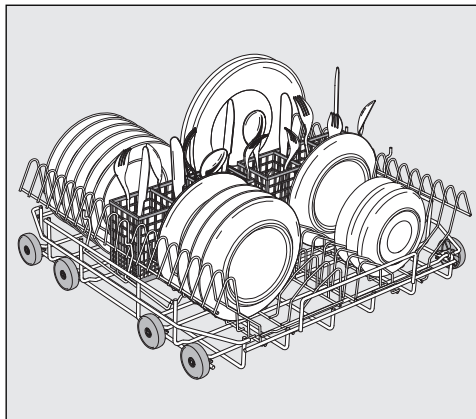

U 890 lower basket with 2 x E 816 inserts and 2 x E 165 cutlery baskets

16 plates with $\text{Ø } 9 \frac{3}{4}$ " (25 cm) and various cutlery items can be loaded. Without the cutlery baskets, 19 plates with $\text{Ø } 9 \frac{3}{4}$ " (25 cm) can be loaded into the E 816 inserts.

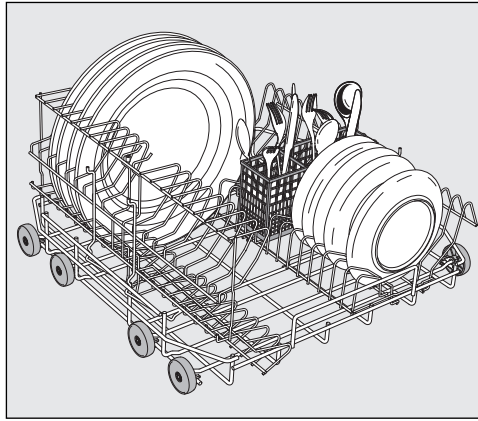

U 890 lower basket with an E 816 insert rotated 90°

With the E 165 cutlery baskets, 16 plates with Ø 13" (33 cm) and various cutlery items can be loaded. Without the cutlery basket, 19 plates with Ø 13" (33 cm) can be loaded into the rotated E 816 insert.

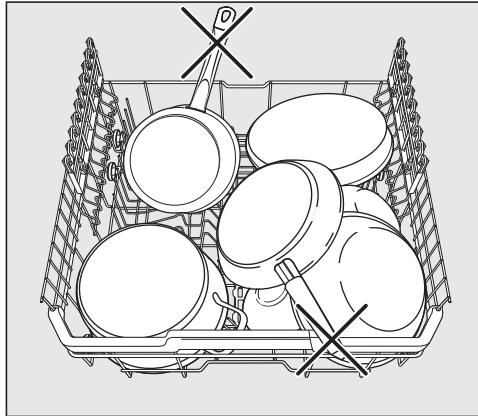

Use of plastic trays

The U 890 Lower Basket Carrier can be loaded with plastic trays measuring 19 3/4" x 19 3/4" (500 x 500 mm).

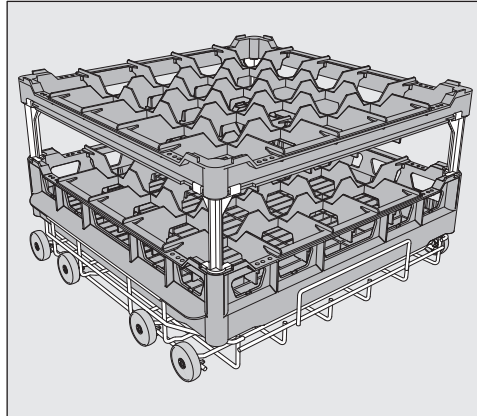

The special O 885 Upper Basket Carrier is required for loading plastic trays in the upper basket (max. height for wash items is 5 1/8" (130 mm)).

The special U 876 Lower Basket Carrier is required for loading taller wash items in the lower basket.

Which basket combination to use will depend on the type, shape, and size of the wash items.

For further information on baskets, please contact your Miele dealer or Miele Technical Service.

Examples: (lower baskets)

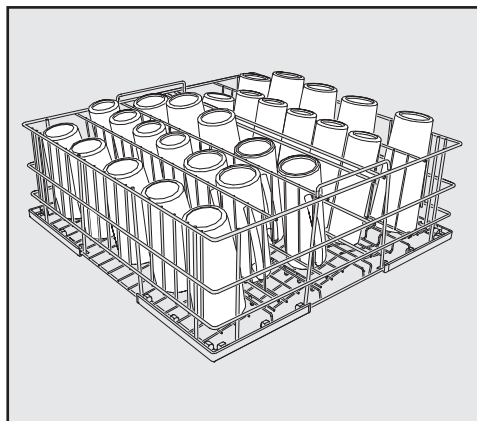

U 525 5-Row Wire Basket

The wire basket can be used for glasses with a maximum diameter of 3 1/8" (8 cm).

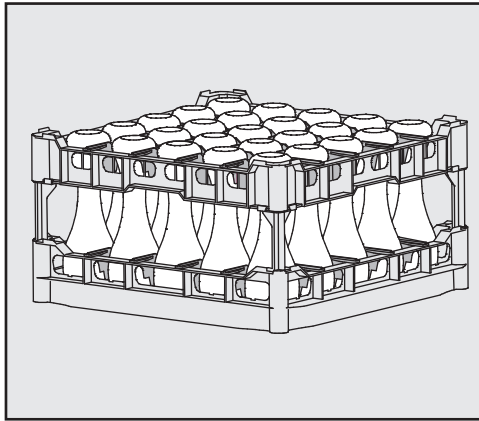

U 534–U 537 Plastic Trays with compartments for different glass heights

In this example, the plastic tray is connected to the top frame by long extenders.

(For assembly in U 876 Lower Basket Carrier only)

Assembling a plastic tray

The height of the tray can be altered by fitting a top frame ① to the base basket ④ with long ② or short ③ extenders.

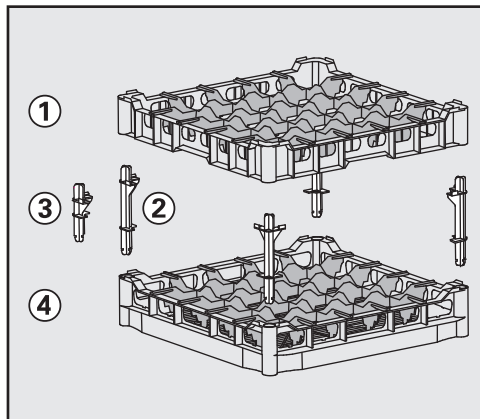

- Push all four extenders into the base basket ④.
- Press the top frame ① securely onto the extenders.

Adding detergent

Use only detergents suitable for commercial dishwashers.
Suitable products are available from Miele Professional.

The detergent can be dispensed in powder form via the powder detergent dispenser or in liquid form via the DOS module (optional accessory - see “DOS module”).

Tabs can be used in all programs except for “Rapid”.
Only use tabs that are quick dissolving. Suitable tabs are available from Miele Professional.

Powder detergent

Only use powder detergent or tabs in the door dispenser compartment.

Add powder detergent or tabs to the detergent dispenser in the door before every wash program (except Rapid, Rinse, Reactivation and Drain). Follow the tips on the next page.

- Add the appropriate amount of detergent to the dispenser according to the degree of soiling of the items to be washed (observe the quantities given in the “Program chart”).

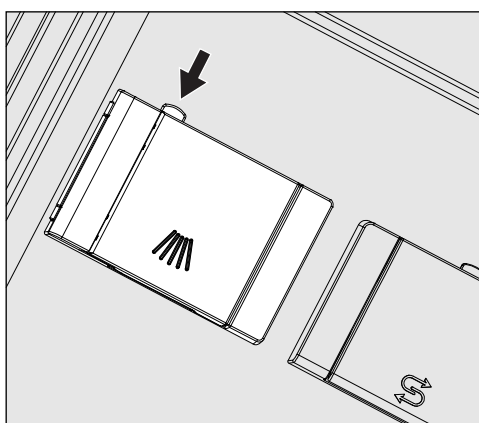

- Press the opening catch on the dispenser in the direction of the arrow. The flap will spring open to the left.

The flap will always be open at the end of a program.

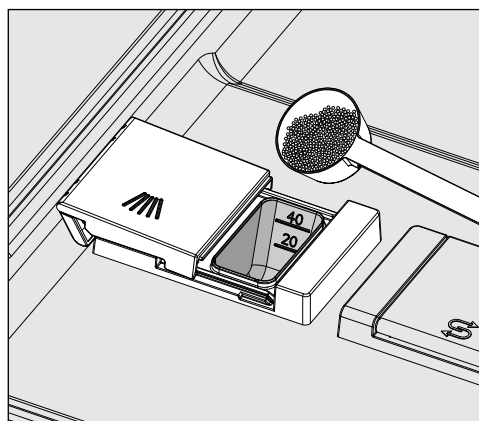

- Add the required amount of powder detergent and close the flap.

Operation

Detergent quantity

- Always follow the recommendations of the detergent manufacturer.

There are markings to help you add the right amount of detergent: 20 and 40. The marks indicate a level of approx. 20 or 40 ml (0.7 oz or 1.3 oz) when the door is open in the horizontal position. They also indicate the approx. amount in grams (depending on the manufacturer and the coarseness of the powder).

The compartment holds a maximum of 60 ml (2 oz).

Tips for the Rapid program

With the Rapid program, the final rinse water is not pumped out at the end of the program in order to achieve short program durations in continuous use.

Detergent cannot be rinsed out of the dispenser during the short program time.

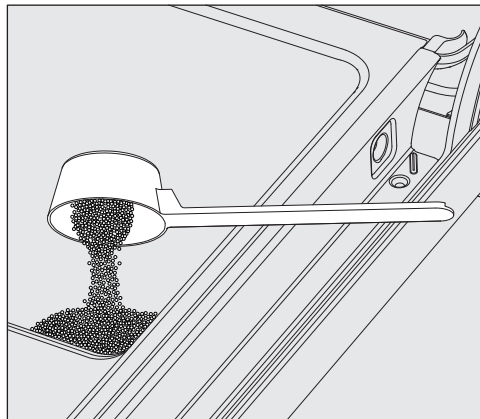

- If liquid detergent is not being dispensed, dispense powder detergent directly onto the inside of the door.

To avoid corrosion or discoloration, the wash program must be started immediately after dispensing detergent directly onto the inside of the door.

Dispenser module

In addition to the internal dispensing systems, up to two additional external dispensing systems (dispenser modules) can be connected for dispensing liquid process chemicals.

Suitable products are available from Miele Professional.

For more information on Miele dispenser modules, please contact your Miele dealer or Miele Technical Service.

Labeling of the suction wands

Liquid process chemicals from external containers are dispensed by suction wands. Color coding the suction wands can be helpful for correct dispensing.

Specific types of soiling may require different combinations of detergents and additives. Miele Technical Service will be able to advise you.

Connecting dispenser modules

The dispenser module comes with a separate installation manual.

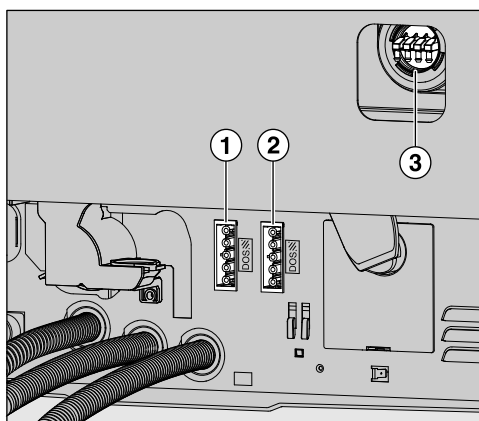

- ① Power supply connection for DOS 1, detergent.
- ② Power supply connection for DOS 4, rinse aid.
- ③ Connections for dispensing hoses.

⚠ Before fitting the dispenser module, compare the connection data (voltage and frequency) on the data plate with that on the data plate of your machine. If the data does not match, the module could sustain damage. If in any doubt, consult a qualified electrician.

- Connect the module to the machine's power supply.
- To connect the dispensing hose, release the hose clip on a free connector and remove the safety cap.
- Push the dispensing hose onto the connector and secure it with a hose clip.

Unused connectors must be blanked off with safety caps to prevent the leakage of wash water.

Operation

Setting the dispensing concentration Refilling or changing containers

For information about setting the dispensing concentration, see “Additional settings/Additional functions/Dispensing systems”.

The dispensing module is equipped with a level monitoring indicator which shows a message in the display when the level drops below the minimum.

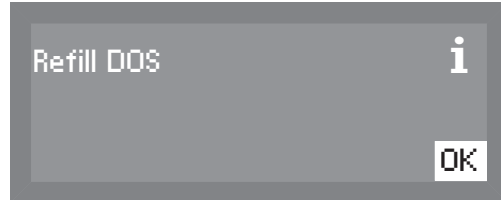

- As soon as the message appears in the display, refill or replace the container with a full one containing the appropriate process chemical at the end of the programme.
- Confirm the message shown with the *OK* button.

Replace the container in good time to prevent the dispensing system being emptied completely.
Vent an empty dispensing system before starting the next programme.

- Place the container on the open dishwasher door or on a surface which is easy to clean.
- Take the lid off the canister and remove the siphon. Place the siphon on the open dishwasher door.
- Fill or replace the container, fit the siphon and secure the lid. Observe the colour coding.

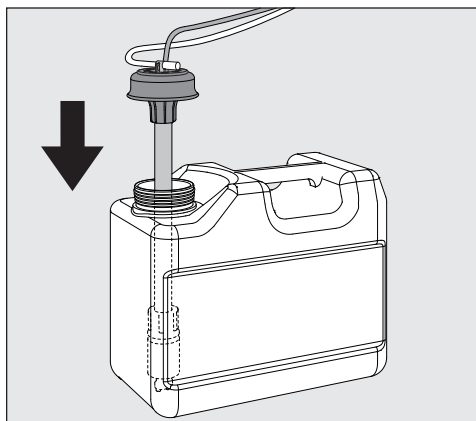

- Feed the siphon into the canister until it reaches the bottom.
- Wipe up any spilled process chemical thoroughly.
- Place the container on the floor beside the commercial dishwasher or in an adjacent cabinet. The container must be at the same level as the machine and not be placed on top of or above the machine.
- The dispensing system must then be vented.

To vent the system and set the dispensing quantity, see “Additional settings, Additional functions.”

Checking consumption

Monitor the amount of process chemicals used by regularly checking the level in the container in order to detect any dispensing irregularities.



Operation

LEDs on the keypad

Light-emitting diodes that indicate the status of the dishwasher are integrated in the keypad.

Except for the *Start/Stop* button, which has a green LED during normal operation, all other LEDs light up yellow.

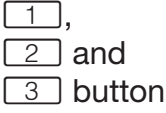
In the event of a fault the *Start/Stop* button flashes red.

Button	LED	Status
 (On/Off) Button	ON	The dishwasher is on.
	FLASHES	The dishwasher has entered standby mode after the preset time.
	OFF	The dishwasher is off.
 buttons (program shortcut buttons)	ON	The lit program has been selected. At the end of the program, the LED will remain lit until a different program is selected.
	OFF	The program is not selected, or program settings are being configured.
 button (additional programs)	ON	A program was selected from the program list. At the end of the program, the LED will remain lit until a different program is selected.
	OFF	No program has been selected from the list, or program settings are being configured.
<i>Start/Stop</i> button	ON	A program is running.
	FLASHES GREEN	A program has been selected, but has not yet started.
	FLASHES RED	A fault has occurred.
	OFF	A program has finished.

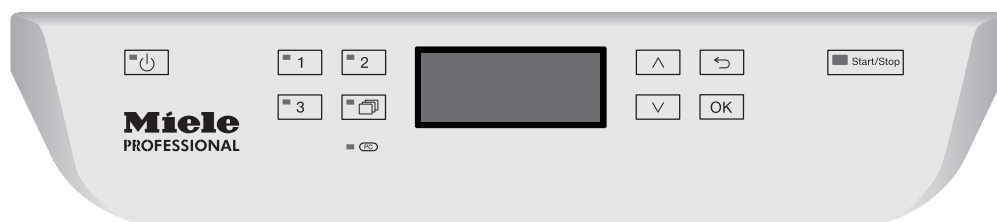

Turning on the dishwasher

- Open the water valve if it is closed.
- Press the  button until the button's LED lights up.
- Close the door.

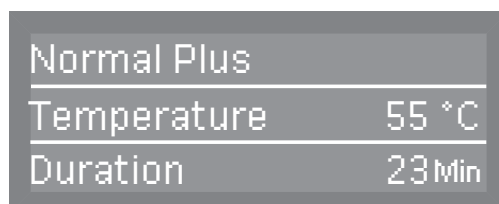

Once the dishwasher is ready for operation, the display changes to show the previously selected program, e.g.:



Selecting a program

Choose your program according to the type of load and how dirty it is.

Shortcut buttons

The most frequently used programs can be selected using the shortcut buttons ,  and . Programs can be assigned to these buttons as desired (see “Additional settings”).

In the factory default setting, the first three programs from the program chart (see “Program chart”) are assigned to the shortcut buttons.

- Select a program using the shortcut buttons.

The LED for the shortcut button will light up and the LED for the *Start/Stop* button will flash.

Operation

Program list

Programs that cannot be selected using the shortcut buttons can be selected from the program list.

- Press the  button.

The following selection menu appears in the display

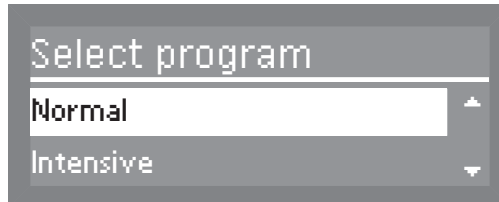

- Select the desired program using the \wedge and \vee buttons, and confirm your choice with the *OK* button.

The selected program will be shown in the display, e.g.:

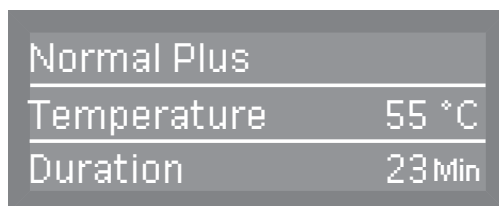

The LED for the  button will light up and the LED for the *Start/Stop* button will flash.

Delay Start can be selected by pressing the *OK* button (see "Additional functions").

Starting a program

- Press the *Start/Stop* button (the LED for the *Start/Stop* button will light up).

Once it has been started, a program can no longer be changed. A running program can either be interrupted (see “Interrupting a program”) or cancelled (see “Canceling a program”).

Program cycle display

After the start of a program, the wash phase and, for 10 seconds, Program running are shown in the display.

During the program cycle, the arrow buttons \wedge and \vee can be used to switch between the wash phase, the set temperature, and the actual temperature in the second line of the display.

The time remaining is shown in the third line of the display.

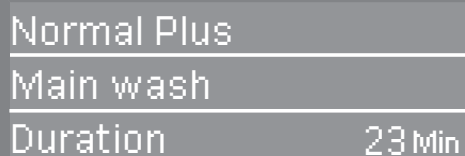

Normal Plus
Main wash
Duration 23 Min

At the end of the program

When a program ends normally, the LED for the *Start/Stop* button will go out. The message *Program finished* will appear in the bottom line of the display.

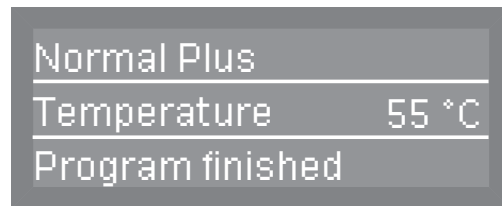

In addition, a buzzer will also sound for approx. 3 seconds (factory default setting). To adjust the buzzer volume, see “Settings, Volume”.

To completely finish the program the door must be opened fully with the dishwasher still switched on.

If the Switch-off function is enabled, the dishwasher switches itself off after a short period of time.
Press the  button to switch the dishwasher on again.

Turning off the dishwasher

- Press the  button until the button's LED goes out.

Unloading the dishwasher

Dishes tend to break and chip more easily when they are hot. Allow the dishes to cool until they are cool enough to handle before unloading them.

The dishes will cool much faster if you open the door when the program has ended.

First unload the lower basket, then the upper basket. This will prevent water drops from the upper basket falling onto the dishes in the lower basket.

Interrupting a program

A program which is already running should only be interrupted if strictly necessary, e.g. if the wash load is moving significantly.

⚠ Caution! The wash load and the interior of the dishwasher may be hot.
Danger of scalding and burning.

- Open the door.

The following message appears in the display:



- Rearrange the items so that they are stable.
- Close the door.

The program will continue from the point at which it was interrupted.

The display will automatically revert to the program cycle.

labelling Cancellling a program

Only cancel a program that has already started if it is absolutely necessary, e.g. if you want to change the program.

In the event of a fault, the program will be cancelled automatically.

 Caution! The wash load and the interior of the dishwasher may be hot.
Danger of scalding and burning.

- Press the *Start/Stop* button.

The following will appear in the display:

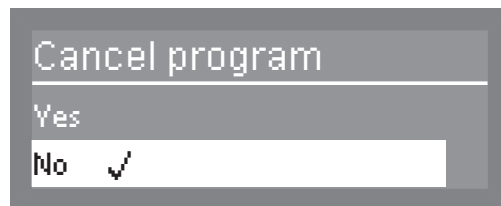

- Select *Yes* and confirm your choice with the *OK* button.

The program is only cancelled when *Yes* is confirmed.
If confirmation does not occur within 20 seconds after the *Start/Stop* button has been pressed, the display will revert to the program cycle.

The following message appears in the display:

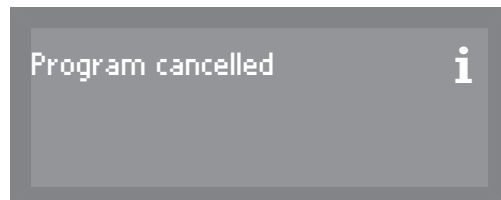

If you change the program and the detergent dispenser flap has already opened, add more detergent as needed.

Delay Start

You can schedule the start time of a program in advance. The start time can be delayed by 1 minute to 24 hours.

The Delay Start function must be enabled in the Settings menu (see “Settings ▾, Delay Start”).

If Delay Start is disabled, the function will not appear in the “Additional functions” screen.



When using the Delay Start function together with powder detergent, make sure that the detergent dispenser is dry before adding the detergent. Wipe dry with a cloth if necessary.

If the compartment is wet, detergent can clump up and stick to the dispenser, which may prevent the detergent from being fully dispensed.

Setting the start time

- Turn the dishwasher on using the  button.
- Select the desired program (see “Operation, Selecting a program”). The LED for the *Start/Stop* button will flash.
- Press the *OK* button.



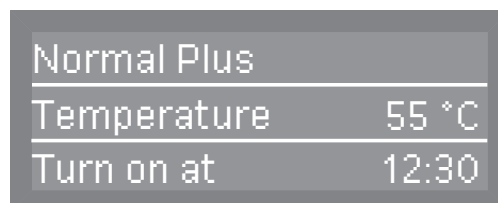

- Use the arrow buttons  (higher) and  (lower) to set the hours and minutes, and confirm each entry using the *OK* button.
- After entering the start time, press the *Start/Stop* button.



The selected program, along with the temperature and start time, will then be displayed.

To cancel the entered Delay Start setting before the program starts, turn the dishwasher off using the  button.

Program chart

Program	Application	Powder detergent (if liquid cleaning agent is not dispensed)
		The following dosages are based on Miele detergents. Please follow manufacturer's instructions on dosage
Rapid	"Quick wash" for washing consecutive lightly soiled loads with fresh traces of easily removable food residue.	1.5 - 2 tbsp. placed on the inside of the door
Normal plus	For more soiled items.	1.5 - 2 tbsp. or 1 tab in the detergent dispenser
Sanitize	For items that must be hygienically cleaned.	1.5 - 2 tbsp. or 1 tab in the detergent dispenser
Normal ⁽¹⁾	Program for regular use to completely wash a full load of normally soiled dishes.	1.5 - 2 tbsp. or 1 tab in the detergent dispenser
Intensive	For heavily soiled items.	1.5 - 2 tbsp. or 1 tab in the detergent dispenser
 China & Crystal	Special glassware program	1.5 - 2 tbsp. or 1 tab in the detergent dispenser
 Glasses	Special program for beer glasses. The glasses will not dry from the heat they emit once the program has ended and may need to be dried by hand.	1.5 - 2 tbsp. or 1 tab in the detergent dispenser
Utensils	Special program for cutlery.	1.5 - 2 tbsp. or 1 tab in the detergent dispenser

⁽¹⁾ This program is used for energy labeling purposes.

Program chart

Program cycle					
1. Pre-wash	2. Pre-wash	3. Main wash (1) / (2)	4. Interim rinse	5. Interim rinse	6. Final rinse (1) / (2)
		X 131°F (55°C) 30 s		(X)	X *) 131°F (55°C) 30 s
X		X 131°F (55°C) 2 min	X	(X)	X 140°F (60°C) 1 min
X		X 140°F (60°C) 3 min	X	(X)	X 158°F (70°C) 10 min
X		X 131°F (55°C) 1 min		(X)	X 140°F (60°C) 1 min
X	X	X 149°F (65°C) 3 min	X	(X)	X 140°F (60°C) 1 min
		X 122°F (50°C) 1 min	X	(X)	X 122°F (50°C) 1 min
		X 122°F (50°C) 1 min	X	(X)	X - (3) 1 min
	X	X 140°F (60°C) 2 min	X	(X)	X 131°F (55°C) 1 min

***) Important note for the “” program.**

With the “Rapid” program, water from the final rinse is not pumped away at the end of the program. It is used for the main wash cycle in the next “Rapid” program.

If the water temperature drops below 104°F (40°C), or if another program is started, this water will be automatically pumped away when the next program starts.

X = Stages included in the program

(X) = Optional stages that can also be selected (see “Additional settings, Additional functions”)

(1) Temperature range of 86 - 158°F (30 - 70°C) (see “Additional settings, Additional functions”).

(2) Holding time range of 0 - 10 minutes (see “Additional settings, Additional functions”).

The holding time range in the “Rapid” program is 0 - 300 seconds.

(3) Runs with cold water and without rinse aid.

Program chart

Program	Application	Powder detergent (if liquid cleaning agent is not dispensed)
		The following dosages are based on Miele detergents. Please follow manufacturer's instructions on dosage
Plastics	Special program for plastic items and other lightweight loads.	1.5 - 2 tbsp. or 1 tab in the detergent dispenser
Economy	Energy-saving program offering the most efficient combined energy and water consumption for normally soiled dishware.	1.5 - 2 tbsp. or 1 tab in the detergent dispenser
 Reactivation	Manual reactivation. This can be run to prevent the need to run a reactivation program during busy periods.	
Rinse	Used for rinsing heavily soiled items and to prevent food remains from drying on the items. Also used for flushing salt residue out of the cabinet after refilling the salt container.	
Drain	For pumping away the rinse water when, for example, the water for the "Rapid" program needs to be replenished or the program has been cancelled.	

Program chart

Program cycle					
1. Pre-wash	2. Pre-wash	3. Main wash (1) / (2)	4. Interim rinse	5. Interim rinse	6. Final rinse (1) / (2)
X		X 122°F (50°C) 5 min	X	(X)	X 140°F (60°C) 1 min
		X 115°F (46°C) 10 min	X	(X)	X 122°F (50°C) 2 min
Reactivation cycle			X		
	X				

X = Stages included in the program



(X) = Optional stages that can also be selected (see "Additional settings, Additional functions")

(1) Temperature range 86 - 158°F (30 - 70°C) (see "Additional settings, Additional functions").

(2) Holding time range 0 - 10 minutes (see "Additional settings, Additional functions").

Accessing the “Settings ” menu

You can access the system settings menu as follows:

- Turn the dishwasher off.
- Press and hold the  button and, at the same time, turn the dishwasher on using the  button.

The display will then show the following options, for example:



- Select the Settings  option and open the corresponding menu by pressing the *OK* button.

Options in the Settings menu

- Delay start
Enable or disable Delay Start (see “Delay Start”)
- Language 
Select the system language (see “Setting the language”)
- DOS priming (Option is only visible if a DOS module is activated)
Vent dispensing system (see “DOS venting”)
- Date
Set the date and date format (see “Setting the date”)
- Time of day
Set the time and clock format (see “Time of day”)
- Volume
Set the volume of the keypad and buzzer (see “Buzzer tones”)

Menu structure

The factory defaults for the menu structure are shown.

Menu	1. Submenu	2. Submenu
1. Delay start	No <input checked="" type="checkbox"/> Yes	
2. Language 	German <input checked="" type="checkbox"/> English (GB) etc.....	
3. PrimingDOS	DOS 1 DOS 4	
4. Date	Date format Set	DD:MM:YY <input checked="" type="checkbox"/> MM:DD:YY
5. Time of day	Set Display Time format	Set the time Do not display <input checked="" type="checkbox"/> On On for 60 seconds 12 h 24 h <input checked="" type="checkbox"/>
6. Volume	Keypad tone Buzzer tones	Program end Warning

Delay Start

You can determine whether Delay Start appears in the “Additional functions” menu or not.

Selecting **No** will remove Delay Start from the “Additional functions” menu as an operation option.

To enable the delayed start of a program, **Yes** must be selected so that Delay Start can be displayed and selected in the “Additional functions” menu.

For information on setting the start time, please see “Additional functions, Delay Start”.

- Select the Settings  menu.
- Select Delay start and confirm your selection with the **OK** button.

The following settings options are available:





- No
Delay Start is disabled and therefore not visible as an additional function.
 - Yes
Delay Start is enabled.
- Select the desired option and confirm your choice with the **OK** button.

Setting the language

The language set here will be used in the display.

The flag symbol  next to the “Settings” menu and the word “Language” will help guide you if a language that you do not understand has been set.

In this case, keep selecting the menu option that is followed by a flag until the “Language” submenu appears.

- Select the Settings  menu.
- Select Language  and confirm your choice with the *OK* button.

A list containing all available system languages will appear in the display.



- Use the \wedge and \vee arrow buttons to select the desired language, and confirm your selection with the *OK* button.

Venting DOS modules

This option is only visible when a DOS module is connected.

The dispensing system for liquid agents can only dispense reliably if the system has been purged of air.

The DOS system must be vented if:

- it is being used for the first time.
- the liquid cleaning agent container has been replaced,
- the dispensing system has been sucked completely dry.

 To avoid damage to the dispensing system, make sure before venting that the detergent and rinse aid containers are adequately filled and that the dispensing siphons are screwed securely to the containers.

- Select the Settings  menu.
- Select DOS priming and confirm your choice with the *OK* button.



- Select the dispensing system to be vented using the \wedge and \vee arrow buttons and confirm your choice with the *OK* button.

The dishwasher will then begin automatically venting the selected dispensing system. Once this process is complete, Dispensing system successfully primed will appear in the display.

- Press the *OK* button to acknowledge the message.

Setting the date

- Select the Settings  menu.
- Select Date and confirm your choice with the *OK* button.

In the following menu, you can choose between:

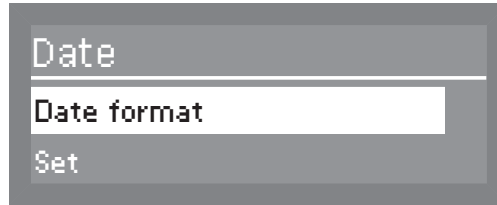

- Date format
This menu option offers two different formats for displaying the date.
- Set
This option is used to set the date in the selected format.

Date format

- Select Date format and confirm your choice with the *OK* button.

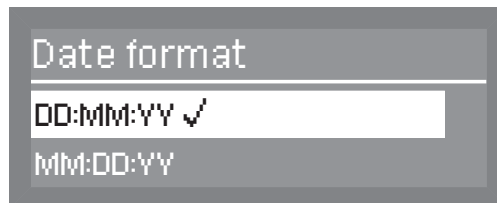

DD stands for day
MM stands for month
YY stands for year

- Select the desired date format and confirm your choice with the *OK* button.

Setting the date

- Select Set and confirm your choice with the *OK* button.



- Use the arrow buttons \wedge (higher) and \vee (lower) to set the day, month and year, and confirm each entry with the *OK* button.

After the day, month and year have been set, the display automatically reverts to the Date menu.

Setting the time of day

- Select the Settings  menu.
- Select Time of day and confirm your entry with the *OK* button.

In the following menu, you can choose between:

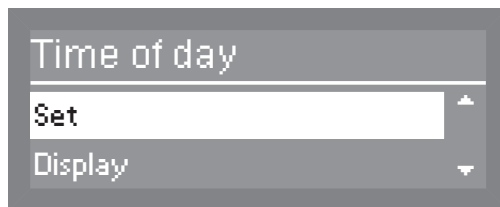

- Set
Set the time of day.
- Display
Time of day displayed when the dishwasher is idle.
- Time format
Set the clock format.

The dishwasher does not automatically adjust between summer and winter time. This must be done manually by the operator as required.

Setting the time

- Select Set and confirm your entry with the *OK* button.

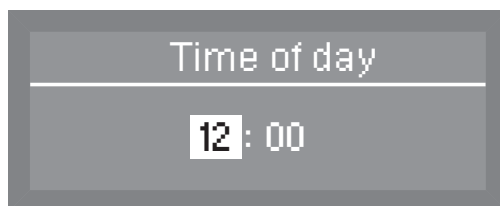

- Use the arrow buttons \wedge (higher) and \vee (lower) to set the hours and minutes, and confirm each entry with the *OK* button.

When hours and minutes have been set, the display reverts automatically to the Time of day menu.

Display

If required, the time of day can be displayed once the “Switch off after duration” has elapsed (see Additional settings, Switch off after). The LED in the  button will start to flash.

The dishwasher is ready for use when the time is visible in the display. Pressing any button will reactivate it.

- Select **Display** and confirm your entry with the **OK** button.

The following options are available:



- **Do not display**
The time of day is not displayed. The dishwasher switches off at the end of the preset waiting time.
- **On**
After the waiting time has elapsed, the time of day is displayed continuously.
- **On for 60 seconds**
The time of day is displayed for 60 seconds after the waiting time has elapsed. After 60 seconds, the commercial dishwasher switches itself off.

Select the setting you want and confirm your choice with the **OK** button.

Clock format

- Select **Time format** and confirm your entry with the **OK** button.

The following options are available for clock format in the display:

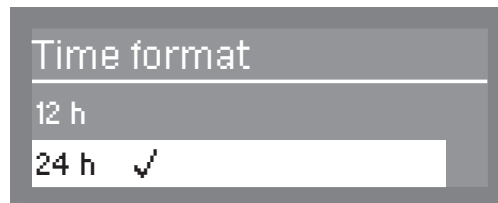

- **12 h (am / pm)**
- **24 h**
- Select the desired format and confirm your choice with the **OK** button.

Adjusting the volume

The dishwasher has audible tones that sound when buttons on the keypad are pressed, at the end of a program, and when there are system messages.

- Select the Settings  menu.
- Select Volume and confirm your choice with the *OK* button.

The following options are available:

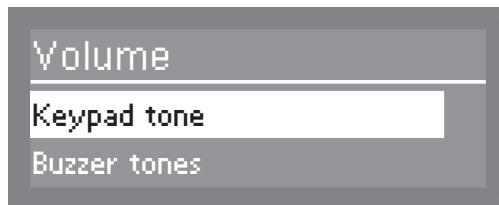

- Keypad tone
Set the volume for the keypad buttons.
- Buzzer tones
Set the volume for the program end and for messages.

Keypad

- Select Keypad tone and confirm your choice with the *OK* button.
- Set the desired volume (see “Setting the volume”) and confirm your selection with the *OK* button.

Buzzer

- Select Buzzer tones and confirm your choice with the *OK* button.

The following options are available:

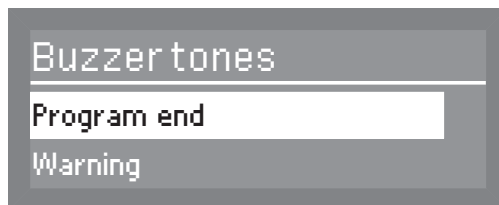

- Program end
Set the buzzer volume for the end of the program.
- Warning
Set the buzzer volume for messages.
- Select the appropriate option and confirm your choice with the *OK* button.
- Set the desired volume (see “Setting the volume”) and confirm your selection with the *OK* button.

Setting the volume

The procedure for setting the volume is always the same. The display also looks similar, e.g.:

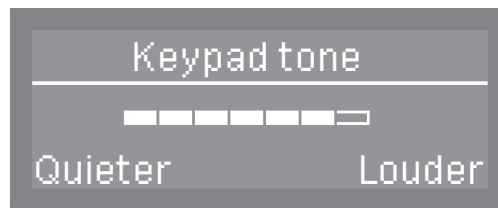

- Use the arrow buttons \wedge (louder) and \vee (softer) to set the volume.

The volume level is shown as a bar. On the lowest setting, the buzzer is turned off.

- Confirm the volume setting with the *OK* button.

If confirmation does not occur within approx. 15 seconds, the display will automatically switch to the next higher menu without saving the setting.

Additional settings

Accessing the “Additional settings” menu

To access the “Additional settings” menu:

- Turn the dishwasher off.
- Press and hold the ↵ button and, at the same time, turn the dishwasher on using the ⏻ button.

The display will then show the following options, for example:



If the ↵ button is pressed at this menu, the dishwasher will exit the additional settings and return to normal operation.

- Select **Additional settings** and open the corresponding menu by pressing the **OK** button.

This menu can be protected with a PIN code (see “Additional settings, Code”).

Options in the “Additional settings” menu

- Code
Assign a PIN code and configure settings (see “Code”)
- Log book
Display consumption levels for supplies used and operating hours (see “Log book”)
- Temperature unit
Choose a temperature unit of either °C or °F (see “Temperature unit”)
- Move program
Assign programs to the shortcut buttons (see “Move program”)
- Additional functions
Modify program parameters such as water intake, interim rinses, temperatures, and holding times, as well as detergent concentration levels for the DOS module (see “Additional functions”)
- Release program
Determine the availability of individual programs for operation (see “Program access”)
- Water hardness
Set the water hardness level (see “Water hardness” and “Water softener”)
- Display view
Switch the display between the set and actual temperatures (see “Display view”)

- Display
Adjust the contrast and brightness of the display (see “Display”)
- Switch off after
Enable or disable the automatic switch-off function (see “Switch off after”)
- Factory default
Reset all parameters to the factory default settings (see “Restoring factory default settings”)
- Software version
Display the software version (see “Software version”)

Additional settings

Menu structure

The factory defaults for the menu structure are shown.

Menu	1st submenu	2nd submenu	3rd submenu
1. Code	Release Change code	Additional settings Enter code	Yes✓ Block
2. Log book	Consumption: Water Consumpt.:Cleaning agent Consumpt.: Rinse aid Operating hours Wash programs Service interval		
3. Temperature unit	°C✓ °F		
4. Move program	1. Rapid 2. Normal plus 3. Sanitize etc.		
5. Additional functions	Reset Increased water level Interim rinse Dispensing system Temperature / Time	Yes No✓ Yes No✓ DOS 2 Rinse aid DOS 1 DOS 4 Rapid Normal plus Sanitize etc.	Active Inactive DOS priming Concentration Change name Reset Main wash Final rinse
6. Release program	All✓ Selection	<input checked="" type="checkbox"/> Rapid <input checked="" type="checkbox"/> Normal plus etc. Accept	
7. Water hardness			

Additional settings

Menu	1st submenu	2nd submenu	3rd submenu
8. Display view	Actual temperature Required temperature✓		
9. Display	Contrast Brightness	ContrastSet BrightnessSet	
10. Switch off after	Yes✓ No	Set the time	
11. Factory default	Reset	No✓ Program settings only All settings	
12. Software version	EB Id: XXXX EGL Id: XXXX EZL Id: XXXX EFU Id: XXXX		

Additional settings

Code

A PIN code can be used to prevent unauthorized access to various functions and system settings on the Commercial Dishwasher.

- Select the *Additional settings* menu.
- Select *Code* and press *OK* to open the relevant menu.
 - Release
Restrict access to the *Additional settings* menu to users with administrative rights only, or allow access to all users.
 - Change code
Set a new PIN code.

Release

- Select the *Release* option and confirm your choice with the *OK* button.
- Select *Additional settings* and confirm your choice with the *OK* button.

The following settings are available:

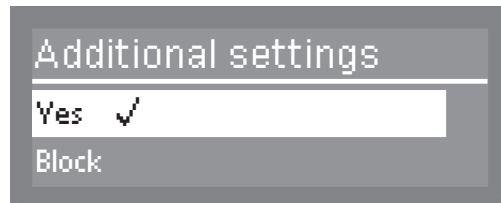

- Yes
The menu is available to all users.
- Block
Access to the menu is only possible with a PIN code.

A check ✓ indicates the current setting.

- Select the appropriate option and confirm your selection with the *OK* button.

Changing the PIN code

- Select the *Change code* option and confirm your choice with the *OK* button.
- First enter the current PIN code (see “Entering the PIN code”).
- Then enter a new PIN code.
- Save the new PIN code by confirming the last digit.

Entering the PIN code

If in the Release menu you have selected Block or if you have set the Additional settings menu up for access via a PIN code, you have to enter the PIN code.

Settings within the Additional settings menu can then only be changed by people with administrative rights.

The PIN code is set at the factory to 8 0 0 0 if access in Additional settings is blocked.

The following PIN-entry screen will appear in the display, for example:



- Use the \wedge and \vee arrow buttons to enter the numerical values, and confirm each entry with the *OK* button.

Each press of the *OK* button takes the highlighting to the next input position automatically.

Each entered digit is replaced by an asterisk (*).

The protected settings are unlocked once all digits have been correctly entered.

If an incorrect PIN code is entered, the following message will appear in the display:

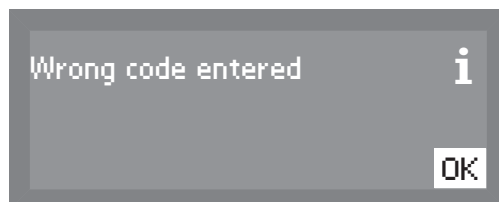

- Press the *OK* button to acknowledge the message.

The display will then revert to the input menu.

Additional settings

Log book

The dishwasher controls record the consumption levels for water, detergent and rinse aid. They also calculate the number of hours the dishwasher has been in operation, the number of programs that have been run, and the required service intervals.

- Select the Additional settings menu.
- Select Log book and open the corresponding menu by pressing the *OK* button.

The following options are available:

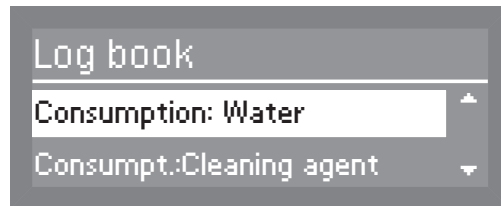

- Consumption: Water
Display the total amount of water used in liters.
 - Consumpt.:Cleaning agent
Display the total amount of detergent used in liters (only for dishwashers using a DOS module).
 - Consumpt.: Rinse aid
Display the total amount of rinse aid used in liters
 - Operating hours
Display the total number of operating hours.
 - Wash programs
Display the total number of program cycles.
 - Service interval
Display the next date for required service.
- Select the desired option and confirm your choice with the *OK* button.

A number will then be displayed.

You can switch the display to the next higher menu by pressing the *OK* button.

Temperature unit

The temperature can be displayed in degrees Celsius or degrees Fahrenheit.

- Select the Additional settings menu.
- Select Temperature unit and confirm your choice with the *OK* button.

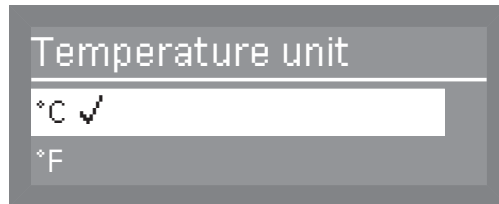

- °C
The temperature is displayed in degrees Celsius
 - °F
The temperature is displayed in degrees Fahrenheit
- Use the \wedge and \vee arrow buttons to select the desired option, and confirm your choice with the *OK* button.

Additional settings

Moving a program

You can change the order of the programs and therefore also the allocation of the shortcut buttons.

You can move the programs you use most frequently to program places 1-3. These are then automatically allocated to the shortcut buttons.

- Select the *Additional settings* menu.
- Select *Move program* and confirm the entry with the *OK* button.

Shortcut buttons Programs are displayed in their current order.

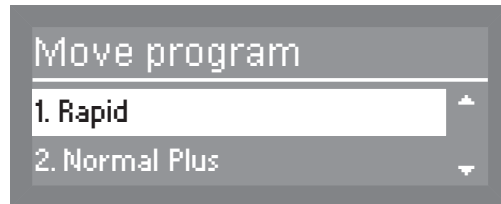

- Use the \wedge and \vee buttons to select a program from the list that you wish to move, and then confirm your choice with the *OK* button.

The program you select will be marked with a check \checkmark .

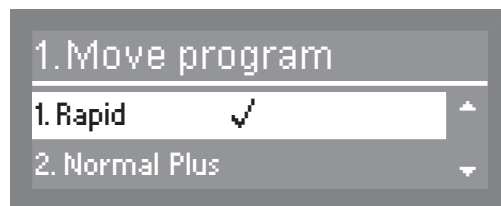

- Use the \wedge and \vee buttons to select the position you want to move it to and confirm your choice with the *OK* button.

Moving a program forwards moves the programs after it down a position.

Moving a program to the end of the list moves the programs in front of it up a position.

Additional functions

With these functions, it is possible to adjust individual parameters to adapt program cycles to particular types of soiling and optimize cleaning results.

- Select the Additional settings menu.
- Select Additional functions and open the corresponding menu by pressing the *OK* button.

In the following menu, you can choose between:

- Reset
Reset all of the parameters changed under the “Additional functions” menu to their factory defaults.
 - Increased water level
Increase the amount of water used in all wash programs.
 - Interim rinse
Include an interim rinse in all programs that support this feature (see “Program chart”).
 - Dispensing system
Vent the dispensing systems and change the name of the dispenser modules.
 - Temperature / Time
Change the temperature and holding time for the main wash and final rinse stages of a wash program.
- Select the *Reset* option and confirm your choice with the *OK* button.

Resetting



- Select the *Yes* option and confirm your choice with the *OK* button.

All parameters that have been changed under “Additional functions” will be reset to the factory default setting.

Additional settings

- Increased amount of water** ■ Select the Increased water level option and confirm your choice with the *OK* button.

The amount of water used is indicated in liters and can be increased by up to 1.5 l in 0.5-liter increments.

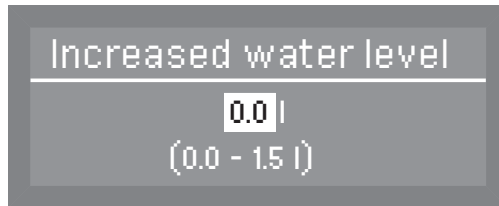

- Use the arrow buttons \wedge (higher) and \vee (lower) to select the desired amount of water, and confirm your selection with the *OK* button.

Interim rinse

- Select the Interim rinse option and confirm your choice with the *OK* button.

The following options are available:

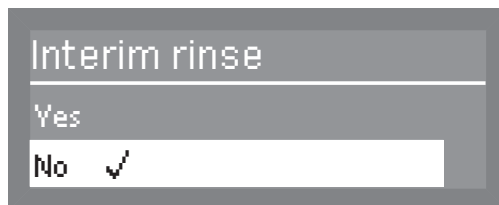

- Yes
The additional interim rinse is active.
 - No
The additional interim rinse is inactive.
- Select the desired option and confirm your selection with the *OK* button.

DOS dispensing systems

- Select the Dispensing system option and confirm your choice with the *OK* button.

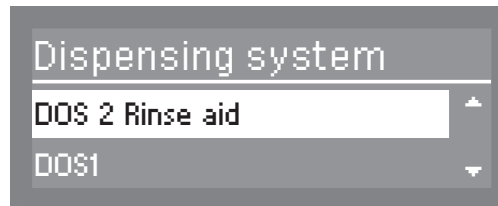

- Select the desired dispensing system and confirm your choice with the *OK* button.

The following settings are available:



- Active
The dispensing system is active.
- Inactive
The dispensing system is inactive.
- DOS priming
Venting of the dispensing system to ensure reliable dispensing.
- Concentration
The concentration of detergent and/or rinse aid can be modified as needed.
- Change name
The name of the dispensing system can be changed.

With DOS 2 Rinse aid, the only option displayed is Concentration.

The menu options DOS priming, Concentration and Change name are only visible if Active is selected.

Additional settings

DOS venting

⚠ To avoid damage to the dispensing system, make sure before venting that the detergent and rinse aid containers are adequately filled and that the dispensing siphons are screwed securely to the containers.

- Select DOS priming and confirm your selection with the *OK* button.

The dishwasher will then begin automatically venting the dispensing system.

Dispensing system DOS priming will appear in the display.

Once this process is complete, Dispensing system successfully primed will appear in the display.

- Press the *OK* button to acknowledge the message.

Setting the DOS concentration level

Please observe dispensing recommendations made by the manufacturer of the agent.

- Select Concentration and confirm your choice with the *OK* button.

Concentration levels are given as a percentage and can be set between 0.01 and 2.00%.

The concentration level set then applies to all programs.

Display for DOS1:

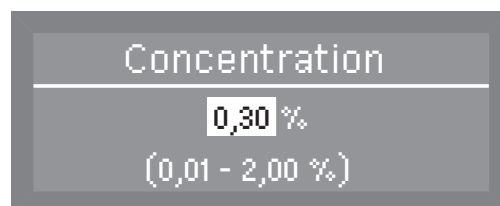

If a DOS G 60 module is connected to the dishwasher, the factory set concentration level set must be reduced by half.

Display for DOS2 rinse aid and DOS4:

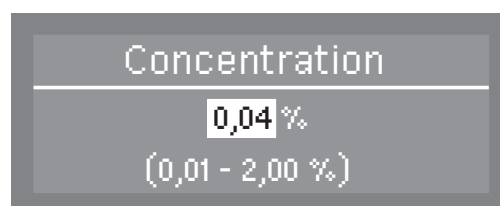

- Use the arrow buttons \wedge (higher) \vee (lower) to set the concentration level you want and confirm your choice with the *OK* button.

Changing a DOS name

- Select Change name and confirm your entry with the *OK* button.

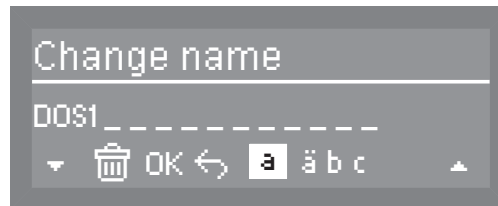

The current name is shown on the second line of the display. This can be changed using the options shown in the bottom line. DOS is a set part of the name and cannot be changed. The top line shows which option has been selected.

- Use the arrow buttons \wedge (move left) and \vee (move right) to move the cursor to the desired option.
- Confirm each option individually with the *OK* button.

The following options are available:

- Letters from A - Z;
each new word will start with a capital letter.
- Numbers from 0 - 9
- Space characters
- Use the  symbol to delete the last position in the name displayed.
- Select *OK* to save the name.
- If you do not want to save the name you have entered, press the \leftarrow symbol.

Additional settings

Temperature / Time

The temperature and holding time for the main wash and final rinse phases can be changed in some programs (see “Program chart”).

- Select Temperature / Time and confirm your choice with the *OK* button.

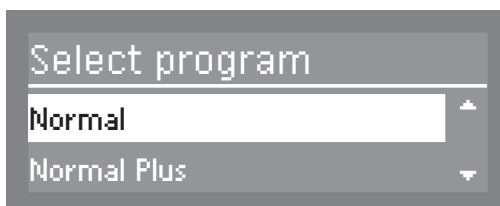

The following options are available:



- Reset
This resets any values changed in the selected program to their factory default settings.
- Main wash
Used to adjust the temperature and holding time for the main wash phase.
- Final rinse
Option to change the temperature and holding time for the final rinse phase.

Main wash / Final
rinse

The procedure for altering settings in Main wash and Final rinse is the same. The display also looks similar.

- Select the Main wash or Final rinse option and confirm your choice with the *OK* button.

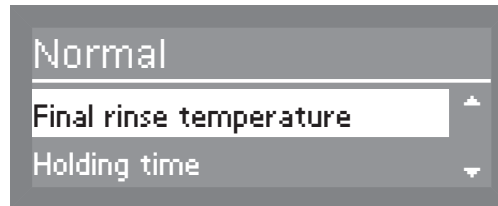

- Select the desired wash program and confirm your selection with the *OK* button.

The following settings are available:

- Temperature / Final rinse temp.
The temperature for the main wash or final rinse phase can be changed.
- Holding time
The temperature holding time can be changed.

Final rinse
temperature

- Select Temperature or Final rinse temp. and confirm your choice with the *OK* button.

The temperature for the main wash or final rinse phase can be changed between 30 and 70°C (86 to 158°F) in 1°C increments.

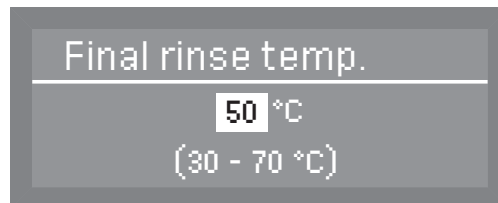

- Use the arrow buttons \wedge (higher) \vee (lower) to set the desired temperature, and confirm your selection with the *OK* button.

Additional settings

Holding time

- Select Holding time and confirm your choice with the *OK* button.

The holding time is displayed in minutes and can be changed to between 0 and 10 minutes in 1-minute increments.

In the Rapid program, the holding time is displayed in seconds and can be changed to between 0 and 300 seconds in 5-second increments.



- Use the arrow buttons \wedge (higher) \vee (lower) to set the holding time you want and confirm your choice with the *OK* button.

Program access

Individual programs can be locked so that they cannot be used. In the factory default setting, all programs are unlocked for use.

- Select the Additional settings menu.

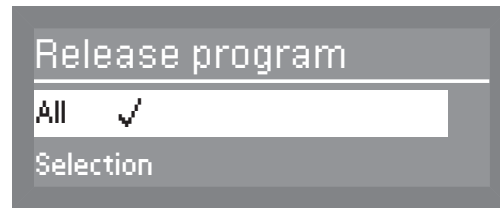

- Select Release program and press *OK* to open the corresponding menu.

The following settings are available:

- All
All programs are unlocked for use.
- Selection
Selection option for determining which individual programs are to be locked.

Locking programs to prevent use

- Select Selection and confirm your choice with the *OK* button.

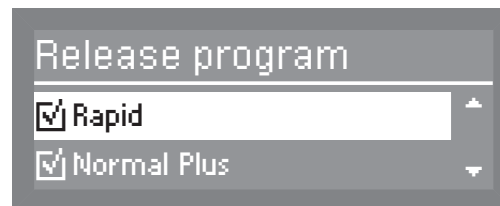

- Select the programs that you wish to block and press the *OK* button.

The checkmark ✓ will be removed from the box and the program will then be locked and unavailable for use.

- To save your selection, select *Accept* at the bottom of the program list and confirm your choice with the *OK* button.

If programs are locked for use, Selection ✓ will be selected the next time the "Program unlock" menu is accessed.

Additional settings

Water hardness

Using this menu, you can program the water softener to match the hardness of the water supplied.

Detailed information is available under “Filling the salt compartment”.

Display view

During a program, the actual or set temperature can be shown in the second line of the display.

- Select the Additional settings menu.

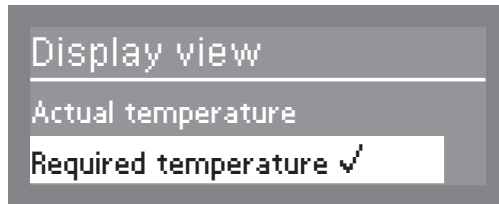

- Select Display view and open the corresponding menu by pressing the *OK* button.

The following settings are available:

- Actual temperature
Displays the actual temperature during a program (this value will vary over the course of the program).
- Required temperature
Display the set temperature for the main wash or the final rinse phase.
(The maximum value is displayed as a static value. It will change from one program stage to the next).

- Select the desired option and confirm your choice with the *OK* button.

Display

The Display menu can be used to alter the contrast and brightness of the display.

- Select the Additional settings menu.

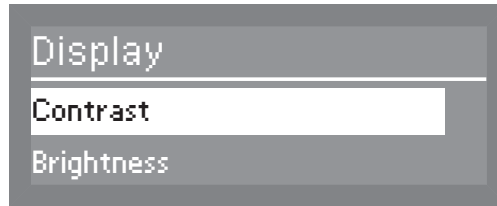

- Select Display and open the corresponding menu by pressing the *OK* button.

The following settings are available:

- Contrast
Set the contrast.
- Brightness
Set the brightness.

Contrast

- Select the Contrast and confirm your choice with the *OK* button.

The contrast range is shown as a bar in the display.



- Use the arrow buttons \wedge (higher) \vee (lower) to set the desired contrast and confirm your choice with the *OK* button.

Brightness

- Select the Brightness and confirm your choice with the *OK* button.

The brightness range is shown as a bar in the display.



- Use the arrow buttons \wedge (lighter) \vee (darker) to set the desired brightness and confirm your choice with the *OK* button.

Additional settings

Switch off after

When not in use, the Commercial Dishwasher can be switched off to save energy or be placed in standby mode by selecting an option from the Settings , Time of day, Display menu.

The clock display will be visible in standby mode.

- Select the Additional settings menu.
- Select Switch off after and open the corresponding menu by pressing the *OK* button.

The following options are available:

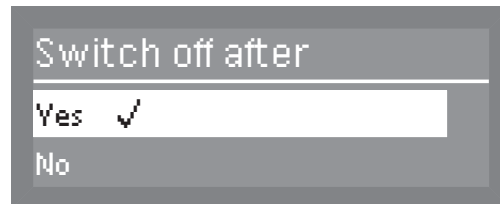

- Yes
The "Switch off after" option is active and you can specify a time period after which the machine switches off.
- No
The "Switch off after" option is not active.

Setting the "Switch-off time"

- Select the *Yes* option and confirm your choice with the *OK* button.

In the factory default setting, the switch off after time is set to 60 minutes. A time of between 5 and 60 minutes can be set in 5-minute increments.

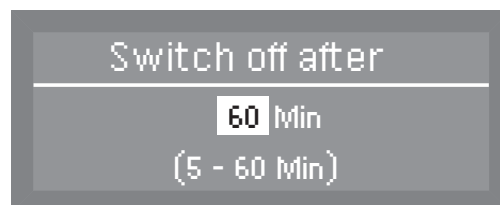

- Use the arrow buttons \wedge (higher) \vee (lower) to set the switch-off time, and confirm your entry with the *OK* button.

Factory default setting

The Factory default setting can be used to reset all changed parameters in the Commercial Dishwasher back to their factory default settings or just values that have been changed for programs.

- Select the Additional settings menu.

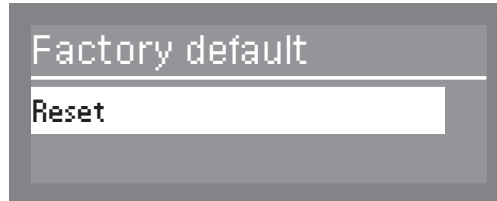

- Select Factory default and press *OK* to open the relevant menu.

The following options are available:

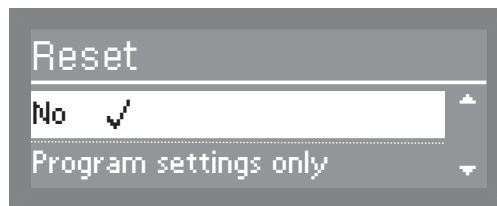

- No
Altered parameters will not be reset to their default settings.
 - Program settings only
Only settings that have been altered in programs will be reset to their factory defaults.
 - All settings
All parameters that have been altered on the Commercial Dishwasher will be reset to their factory defaults.
- Select the desired option and confirm your selection with the *OK* button.

Selecting Program settings only or All settings restarts the Commercial Dishwasher. After it has restarted, you will be prompted to re-enter basic parameters such as the language, date, time, water hardness, etc.

- Enter the parameters displayed such as language, date, time, etc.
Your selection will be saved and the last program used will appear in the display.

Additional settings

Software version

Displays the versions of the individual software components.

- Select the Additional settings menu.
- Select Software version and open the corresponding menu by pressing the OK button.



The software for the individual components is displayed. XXXX denotes the version.

- EB Id: XXXX
Software version for the control and display unit.
- EGL Id: XXXX
Software version for the control board.
- EZL Id: XXXX
Software version for the relay board.
- EFU Id: XXXX
Software version for the frequency converter.

Modifications and updates to the software may only be carried out by an authorized Miele service technician.

Maintenance

To prolong the service life of the Commercial Dishwasher, it should be serviced **at least once a year** by Miele Technical Service.

Maintenance covers the following:

- Electrical safety according to national regulations
- Door mechanism and door seal
- Any screw connections and connectors in the wash cabinet
- Water inlet and drainage
- Internal and external dispensing systems
- Spray arms
- Filter combination
- Sump including drain pump and non-return valve
- All baskets and inserts

The following operational tests will be carried out as part of the maintenance:

- A program will be run as a test run
- Seals will be tested for water tightness
- All relevant measuring systems will be safety tested, including fault displays
- Safety features

Cleaning and care

⚠ Remove any soiling from the control panel and from the front of the machine straight away.
Soiling that is left too long might become impossible to remove and could cause the external surfaces to alter or discolor.

⚠ All surfaces are susceptible to scratching.
Contact with unsuitable detergents can alter or discolor the external surfaces.

Cleaning the control panel

- Only clean the control panel with warm water and liquid dish soap, applied with a soft sponge or cloth. Then dry the control panel with a soft cloth.

⚠ Do not use abrasive detergents!
These can damage the control panel.

Cleaning the front of the dishwasher

- To clean the stainless steel front panel, use a damp cloth with either a solution of liquid dish soap and hot water or a non-abrasive cleaning agent suitable for use on stainless steel.

To keep the front panel from getting dirty again (fingerprints, etc.), a stainless steel conditioner can be used after cleaning (e.g., Neoblank, available from Miele Service).

⚠ Do not use cleaning agents containing ammonium chloride or thinners!
These agents can damage the surface material.

⚠ When cleaning, do not hose down the dishwasher or its direct vicinity, e.g. with a water hose or pressure washer.

Cleaning the wash cabinet

The wash cabinet is largely self-cleaning, provided that the correct amount of detergent is always used.

If, despite this, lime scale or grease deposits accumulate in the cabinet, these can be removed with a proprietary dishwasher cleaner (available from Miele).

Cleaning the door and the door seal

- Wipe the door seal and the area beneath the door regularly with a damp cloth to remove food deposits.
- Wipe away any spillages of food and beverages from the sides and the hinges of the dishwasher door.
- With freestanding dishwashers that have a base facing, remove spillages of food and beverages from the channel that runs below the door.

⚠ Be cautious of sharp edges when cleaning.
There is a risk of cutting yourself.

These surfaces are outside the wash cabinet. They are not accessed by water from the spray jets. As a result, mould can develop here.

Cleaning the filters in the wash cabinet

The filter combination in the base of the wash cabinet retains coarse soil from the suds solution, preventing it accessing the circulation system and causing blockages in the spray arms.

⚠ This dishwasher must not be used without all the filters in place!

The filters must be checked regularly and cleaned when necessary.

⚠ Caution!
Danger of injury on glass splinters.

Cleaning the coarse filter

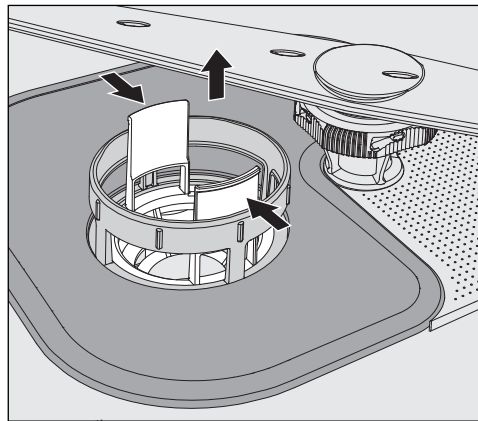

- Press the catches towards each other and remove the coarse filter.
- Rinse the filter thoroughly under running water. If necessary use a soft brush to remove soiling.
- Replace the filter making sure it engages correctly.

Cleaning and care

Cleaning the flat and micro-fine filters

- Remove the coarse filter.

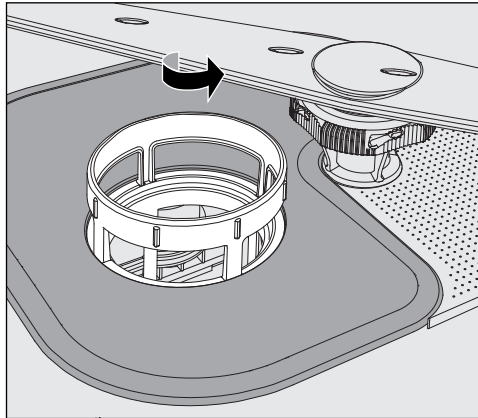

- Grasp the micro-fine filter by the upper rim and turn it in the direction of the arrow to release it. Then lift it out.

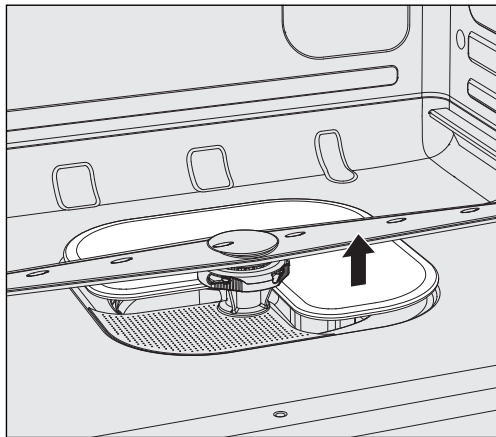

- Remove the flat filter.
- Rinse the filters thoroughly under running water. If necessary use a soft brush to remove soiling.

Replace the filter combination in the reverse order, turning the micro-fine filter to the left to re-engage it.

The flat filter must lie flat in the bottom of the wash cabinet.

The spray arms will get blocked if the filters are not replaced correctly.

Cleaning the spray arms

This Commercial Dishwasher has three different spray arms.

Particles of food can get stuck in the spray arm jets and bearings. The spray arms should therefore be checked and cleaned regularly.

- Switch the Commercial Dishwasher off.
- Pull the **upper spray arm** downwards to remove it.

The middle and bottom spray arms are secured with a bayonet fitting.

The bayonet fitting on the lower spray arm is colored yellow so that it cannot be mistaken for the fitting on the middle spray arm.

To release the bayonet fitting proceed as follows:

- Using the knurled nut, turn the **middle spray arm** to the left as far as it will go and then pull the spray arm downwards to remove it.
- Remove the lower basket.

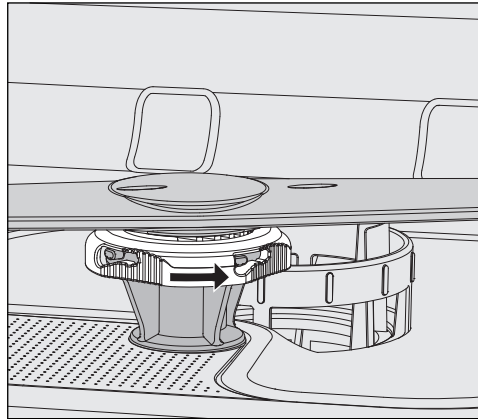

- Using the knurled nut turn the **lower spray arm** to the right as far as it will go and then pull the spray arm upwards to remove it.

Cleaning and care

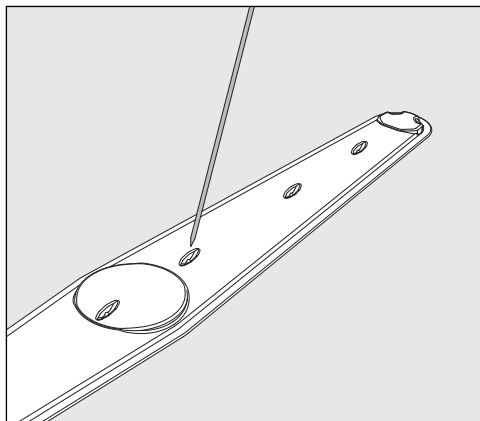

- Use a pointed object to push food particles in the jets into the spray arms.
- Rinse the spray arms thoroughly under running water.

Reinstall the spray arms and check that they rotate freely.

Make sure that the spray arm with the yellow bayonet fitting is fitted in the bottom of the wash cabinet.



Frequently asked questions

With the aid of the following guide, most minor problems can be corrected without contacting Miele. In many cases, this will save you time and money because you won't need to call Miele Technical Service.

The following guide should help you to find the reason for a malfunction or fault, and to correct it. However, please note:

 Repairs must only be carried out by Miele Technical Service, a Miele authorized service agent, or a suitably qualified technician in accordance with local and national safety regulations. Repairs by unqualified persons can cause considerable danger to users.

Faults with water intake or drainage

Problem	Possible cause and solution
The display remains dark and the “Start/Stop” light does not flash after the dishwasher was turned on using the  button.	The dishwasher is not plugged in. ■ Insert the plug.
	The circuit breaker was tripped. ■ Activate the fuse (see data plate for minimum fuse rating).
The dishwasher stops during a program.	The circuit breaker has tripped. ■ Reset the circuit breaker (see data plate for the correct fuse rating). ■ If the circuit breaker trips again, contact Miele Customer Service.
Power outage during operation	If a temporary power outage occurs during a program sequence, no measures are required. The program which was running continues without interruption. If the temperature in the wash chamber drops below the minimum value required for the program block during the power outage, the program block is repeated. In case of a power outage of ≥ 20 hours, the entire program is repeated.
One of the following fault messages is displayed:	Before remedying the fault: ■ Switch the dishwasher off with the  .
Check water intake	There is a problem with the water intake. ■ Open the faucet all the way. ■ Clean the filter in the water inlet (see “Cleaning and care”).

Frequently asked questions



Problem	Possible cause and solution
Fault 403-405	<p>If Check water intake has appeared in the display, the controls will check the water intake every 30 seconds. If no water has entered the dishwasher after three attempts, one of these fault numbers appears in the display and the program will be canceled.</p> <ul style="list-style-type: none"> ■ Open the water supply valve all the way. ■ Turn the dishwasher back on. ■ Select the desired program. ■ Press the <i>Start/Stop</i> button.
Fault 406-408	<p>Water inlet fault. One of these numbers will appear in the display if the flow pressure is too low and the program will be cancelled.</p> <ul style="list-style-type: none"> ■ The flow pressure at the water intake point is too low (see “Technical data”). Contact Miele Service for advice.
Fault 412-414	<p>Water inlet fault. One of these numbers will appear in the display if the flow pressure is too high and the program will be cancelled.</p> <ul style="list-style-type: none"> ■ The flow pressure at the water intake point is too high (see “Technical data”). Contact Miele Service for advice.
Fault 492, 504, 541	<p>Fault during program start. There may still be water in the wash cabinet.</p> <ul style="list-style-type: none"> ■ Clean the filter combination (see “Cleaning and care”). ■ Clean the non-return valve (see “Frequently asked questions”).
Fault 550	<p>The Waterproof system was activated.</p> <ul style="list-style-type: none"> ■ Close the water supply valve. ■ Contact Miele Service.
Fault 578	<p>The peak-load cut-out has lasted longer than 3 hours.</p> <ul style="list-style-type: none"> ■ Have your electrical system and your energy management system tested by a suitably qualified person.
Check drainage	<p>The water outlet is restricted. There might be water in the wash cabinet.</p> <ul style="list-style-type: none"> ■ Clean the filter combination (see “Cleaning and care”). ■ Clean the drain pump (see “Frequently asked questions”). ■ Clean the non-return valve (see “Frequently asked questions”). ■ Remove any kink or loop in the drain hose.

Frequently asked questions

Problem	Possible cause and solution
Fault XXX (XXX stands for a number)	<p>A malfunction may have occurred.</p> <p>After waiting 10 seconds:</p> <ul style="list-style-type: none">■ Turn the dishwasher back on.■ Select the desired program.■ Press the <i>Start/Stop</i> button. <p>If the fault message is displayed again, there has been a malfunction.</p> <ul style="list-style-type: none">■ Contact Miele Service.

Frequently asked questions

Unusual behavior of the dishwasher

Problem	Possible cause and solution
Program finished has appeared on the display and you cannot select or start a program.	This is not a fault. <ul style="list-style-type: none"> ■ Open and close the door. The dishwasher must remain switched on while you do this.
The dishwasher fails to react when buttons are pressed. The display and indicator lights remain dark.	The dishwasher has turned itself off after the set Switch-off time to save energy. <ul style="list-style-type: none"> ■ Press the  button to turn the dishwasher on again.
The following fault message is appears in the display: Salt container lid not closed correctly	The salt reservoir cover is not properly closed. <ul style="list-style-type: none"> ■ Close the salt reservoir cover.
The dispenser cover cannot be closed.	Detergent residue is blocking the latch. <ul style="list-style-type: none"> ■ Remove the detergent residue.
The inside of the door and/or the interior walls are wet after a program has finished.	This is not a fault. It is caused by the drying system. The moisture will dissipate after a short while.
There is still water in the wash cabinet at the end of the program. (This does not apply to the “Rapid” program.)	Before remedying the fault: <ul style="list-style-type: none"> ■ Turn the dishwasher off using the  button.
	The filter combination in the wash cabinet is clogged. <ul style="list-style-type: none"> ■ Clean the filter combination (see “Cleaning and care”).
	The drain pump or non-return valve is blocked. <ul style="list-style-type: none"> ■ Clean the drain pump or the non-return valve (see “Frequently asked questions”).
	The drain hose is kinked. <ul style="list-style-type: none"> ■ Remove the kink.
	The on-site drain trap is clogged. <ul style="list-style-type: none"> ■ Check and clean the drain trap.
Peak load cut-out	This is not a fault! Your energy management system has detected a peak-load in the energy supply. Some components in the dishwasher stop operating for the duration of the peak-load cut-out.

Noises

Problem	Possible cause and solution
There is a knocking noise in the wash cabinet.	<p>A spray arm is hitting the dishware.</p> <ul style="list-style-type: none"> ■ Interrupt the program, and rearrange the items which are obstructing the spray arm.
There is a rattling noise in the wash cabinet.	<p>Dishware is moving around in the wash cabinet.</p> <ul style="list-style-type: none"> ■ Interrupt the program and rearrange loose pieces. <p>A foreign object (e.g. a cherry pit) has become lodged in the drain pump.</p> <ul style="list-style-type: none"> ■ Remove the foreign object from the drain pump (see “Cleaning the drain pump and non-return valve”).
There is a knocking noise from the water pipe	<p>This may be caused by the installation or the diameter of the water pipe.</p> <p>However, this will not affect the dishwasher function in any way.</p> <ul style="list-style-type: none"> ■ If in doubt, contact a plumber.

Frequently asked questions

Poor cleaning results

Problem	Possible cause and solution
The dishes are not clean.	The dishes were not loaded correctly. ■ Please observe the instructions in “Loading the dishwasher”.
	The program was not suitable for the requirements. ■ Select a more suitable program (see “Program guide”).
	Not enough detergent was dispensed. ■ Increase the dosage.
	The detergent used is not suitable for the type of soiling present. ■ Switch to another detergent.
	Items are blocking the path of the spray arms. ■ Rearrange the items so that the spray arms can rotate freely.
	The filter system in the base of the wash cabinet is not clean or is not correctly fitted. This may cause the spray arm jets to get blocked. ■ Clean and/or fit the filter combination correctly. ■ Clean the spray arm jets, if necessary (see “Cleaning and care”).
	The non-return valve is open and blocked. Dirty water has flowed back into the wash chamber. ■ Clean the drain pump and the non-return valve (see “Frequently asked questions”).
	If necessary, alter the temperature and / or the holding time for the program being used. ■ Change the relevant parameters for the program. (see “Additional settings, Additional functions”)
Smearing appears on glassware and cutlery. There is a bluish sheen on the surface of glassware; film can be wiped off.	The rinse aid dosage is set too high. ■ Reduce the dosage (see “Additional settings, Additional functions, Dispensing systems”).
Dishware is not dry or cutlery and glasses are spotty.	The rinse aid dosage is set too low or the rinse aid reservoir is empty. ■ Replenish the rinse aid, increase the dosage or change the brand of rinse aid used (see “Adding rinse aid”).

Frequently asked questions

Problem	Possible cause and solution
White residue is visible on the dishware. Clouding occurs on glassware and cutlery; the deposit can be wiped off.	The rinse aid dosage is too low. ■ Increase the quantity dispensed (see “Additional settings, Additional functions, Dispensing system”).
	The salt reservoir is empty. ■ Fill the reactivation salt reservoir (see “Filling the salt reservoir”).
	The water softener is programmed to too low for the water hardness level. ■ Program the water softener assembly to the correct value (see “Additional settings, Water hardness”).
Glasses have a brownish-blue discoloration; the deposit cannot be wiped off.	Detergent deposits. ■ Switch to another detergent right away.
Glasses are dull and discolored; the deposit cannot be wiped off.	The glassware is not dishwasher-safe. The surfaces are affected. ■ Purchase glassware which is dishwasher-safe.
Tea or lipstick stains have not been completely removed.	The wash temperature of the selected program was too low. ■ Select a program with a higher wash temperature.
	The bleaching effect of the detergent is too low. ■ Switch to another detergent.
Plastic parts are discolored.	Natural dyes e.g. from carrots, tomatoes or ketchup may be the cause. The amount of detergent used or its bleaching effect was not sufficient to deal with natural dyes. ■ Use more detergent (see “Operation, Adding detergent”). Discolored plastic items will not regain their original color.
There are rust stains on the cutlery.	The “Cold” program was not run after dishwasher salt was added. Traces of salt have gotten into the wash cycle. ■ Always run the “Cold” program without a load after refilling salt.
	The affected items are not corrosion resistant. Purchase cutlery which is dishwasher-proof.

Frequently asked questions

Cleaning the water intake filter

A filter is incorporated in the screw connection of the water intake valve. The filter must be cleaned when dirty; otherwise, insufficient water will flow into the wash cabinet.

⚠ The plastic housing of the water connection contains an electrical component.
The housing must not be dipped in water.

Recommendation

If your water supply contains a large number of insoluble substances, we recommend fitting a large-area filter in the connection between the water supply valve and the water intake hose threaded union. This filter can be purchased from your Miele dealer or from Miele Service.

- To clean the filter:**
- Disconnect the dishwasher from the power supply.
Switch off at the electrical socket and withdraw the plug.
 - Close the water supply.
 - Unscrew the water intake valve.

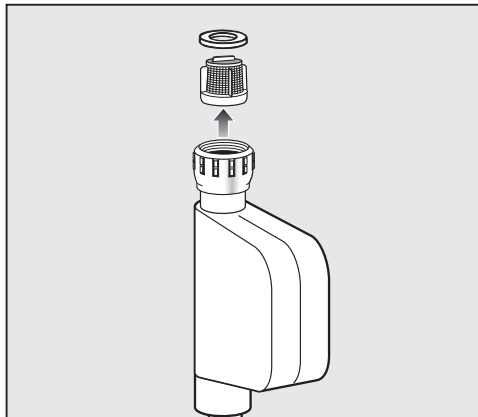

- Take the seal ring out of the screw connection.
- Withdraw the filter using pointed pliers and rinse clean under running water.
- Put the filter and seal back into place. Make sure they are fitted correctly.
- Reconnect the water intake valve to the faucet, making sure it goes on correctly and is not cross-threaded.
- Turn on the water supply.

If water leaks out, the screw connection may not be connected securely or it may have been screwed on at an angle.

- Unscrew and reconnect the water intake valve correctly.

Cleaning the drain pump and non-return valve

If water has not pumped out at the end of a program, there may be a foreign object in the drain pump or blocking the non-return valve. These are easy to remove.

- Disconnect the dishwasher from the water supply and the electrical supply (turn the dishwasher off, unplug it or disconnect or disable the fuse).
- Take the filter combination out of the wash cabinet (see “Cleaning and care”).

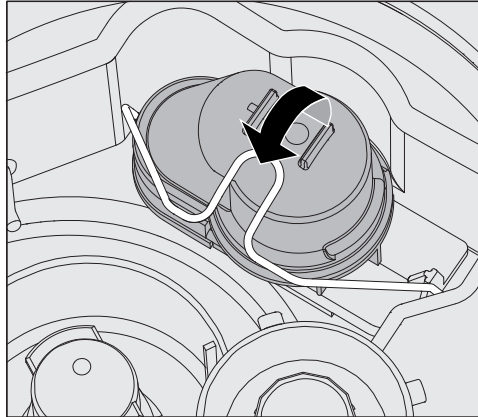

- Lift the locking clamp.
- Lift out the non-return valve and rinse well under running water.
- Make sure that the vent on the external part of the non-return valve is not blocked. (This vent is only visible when the non-return valve has been taken out of the dishwasher). If it is blocked, use a pointed object to release the blockage.

Frequently asked questions

The drain pump is situated under the non-return valve (see arrow).

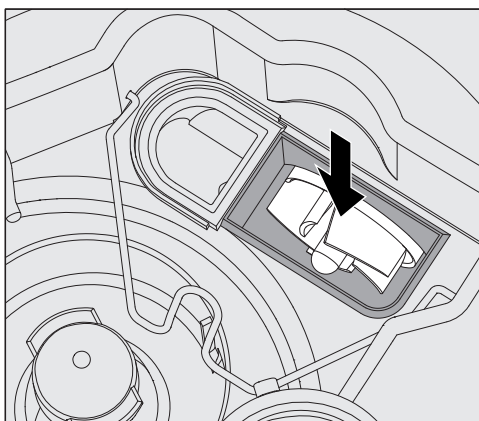

- Check the area around the drain pump for foreign objects (watch out for glass splinters which could cause injury) and remove them before replacing the non-return valve.
- Carefully replace the non-return valve and secure it with the clamp.

Technical Service

If, despite following the instructions in this manual, you are unable to rectify a problem, please contact one of the following, quoting the fault code shown in the display:

- your Miele dealer, or
- Miele Technical Service

Contact details for Miele Technical Service can be found at the back of this manual.

- When contacting Miele Technical Service, you will need the model number and 8-digit machine number of the Commercial Dishwasher.

The model number and the machine number are both shown on the data plate, located at the top of the door.

Installation instructions

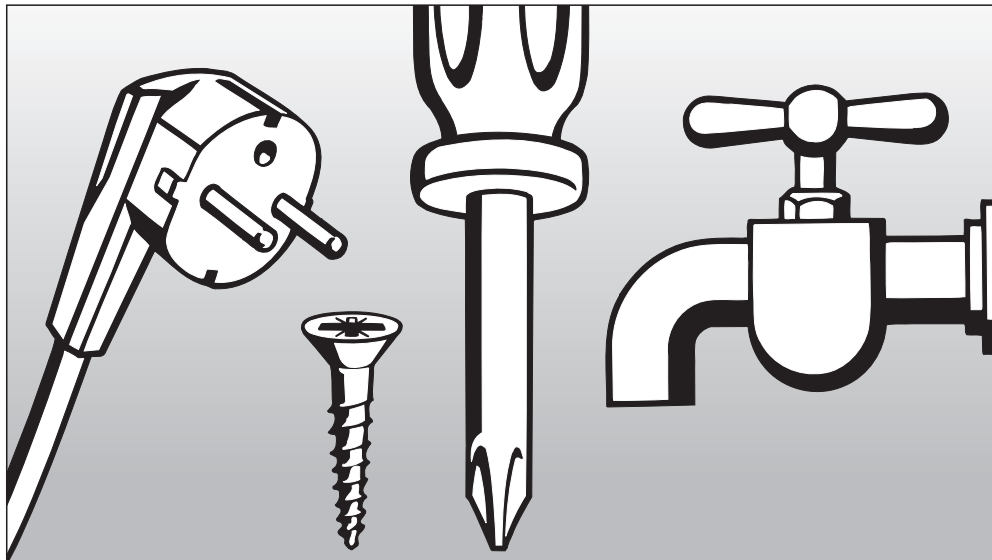

Information is subject to change. Please refer to our website to obtain the most current product specification, technical & warranty information.

To prevent accidents and machine damage, read these instructions **before** installation or use.

Disposal of the packing material

The cardboard box and packing materials protect the appliance during shipping. They have been designed to be biodegradable and recyclable.

Ensure that any plastic wrappings, bags, etc. are disposed of safely and kept out of the reach of children. Danger of suffocation!

Disposal of your old appliance

Electrical and electronic appliances contain valuable materials. They also contain certain substances, compounds and components which were essential for the proper functioning and safe use of the equipment. Handling these materials improperly by disposing of them in your household waste can be harmful to your health and the environment. Therefore, please do not dispose of your old appliance with regular household waste and follow local regulations on proper disposal.

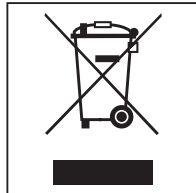

Consult with local authorities, dealers or Miele in order to dispose of and recycle electrical and electronic appliances. Miele assumes no responsibility for deleting any personal data left on the appliance being disposed. Please ensure that your old appliance is kept away from children until removal. Observe safety requirements for appliances that may tip over or pose an entrapment hazard.

Installation

Installation

⚠ In order to reduce the risk of damage from condensation, the furniture in the area around the Commercial Dishwasher should be designed for commercial use.

The Commercial Dishwasher must be installed in a secure and level position. Any unevenness in the floor level and height of the machine can be compensated for by adjusting the four feet.

If the dishwasher is to be installed next to other machines and furniture or in a recess, an installation space measuring at least 23 5/8" wide and 23 5/8" deep (60 cm wide and 60 cm deep) is required.

Undercounter installation

⚠ To ensure the stability of undercounter Commercial Dishwashers, these units may only be installed beneath a continuous countertop that is bolted to adjacent cabinetry.

If the dishwasher is to be installed beneath a continuous countertop, an installation space measuring at least 23 5/8" wide, 23 5/8" deep, and 32 1/4" high (60 cm wide, 60 cm deep, 82 cm high) is required.

When adjusting the dishwasher height, the feet must not be unscrewed by more than 2 1/4" (6 cm).

If the dishwasher is fitted with a lid, it can be removed as follows:

- Remove both securing screws on the back of the Commercial Dishwasher with a screwdriver.
- Open the door.

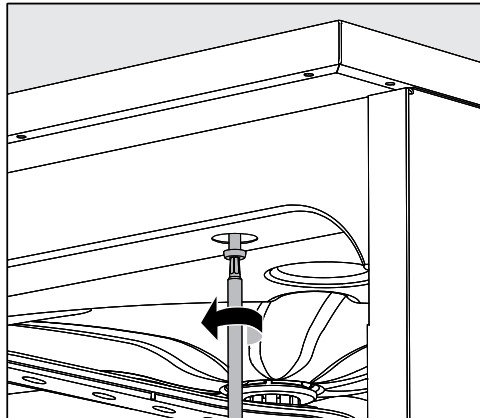

- Unscrew the left and right fastening screws with a screwdriver.
- Lift the machine lid upwards to remove.

Leveling and securing the dishwasher

To ensure stability, the dishwasher must be secured to the counter once it has been leveled.

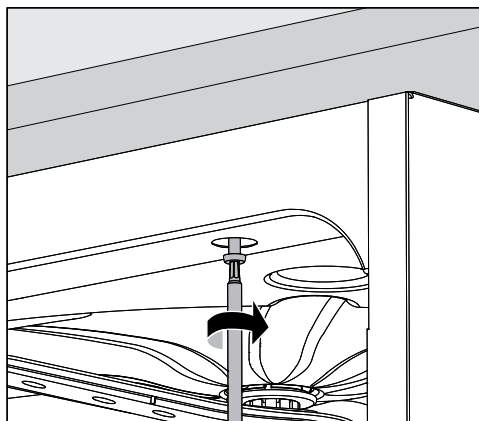

- After leveling, securely screw the dishwasher to the continuous countertop. With the door open, turn the screws into the countertop through the holes in the front trim on the left and right hand sides of the dishwasher.

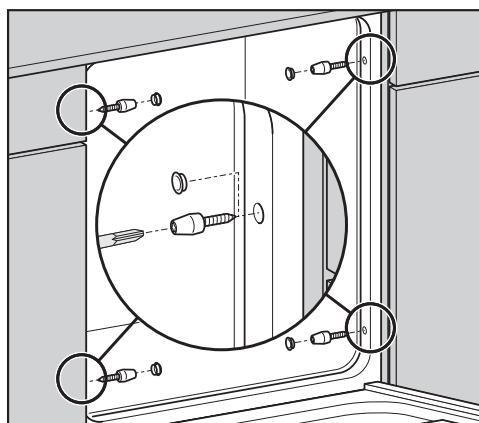

For countertops made of stainless steel or natural stone, the dishwasher must be secured to the adjacent cabinetry on the left and right hand sides using two screws per side.

Special screws (4 x 27 / Torx T20) are included in the accessories provided.

For this type of installation, holes must be drilled in the side wall in front of the door seal.

The gaps between undercounter dishwashers and adjacent cabinetry or appliances may not be filled with silicone sealant, since this could impair the ventilation of the circulation pump.

Depending on the specific undercounter installation situation, the stainless steel cover plate supplied with the dishwasher can be used to protect the underside of the countertop against damage caused by steam.

Moving the dishwasher

Before moving the dishwasher, screw in the adjustable feet fully so that they do not become damaged.

⚠ Do not use protruding parts, e.g. the control panel, to lift the dishwasher.

These parts could break off.

⚠ Only transport the dishwasher in its original packaging using a hand truck. For subsequent moves, the dishwasher must be placed on a continuous support base to avoid damage.

Electrical connection

⚠ All electrical work must be performed by a suitably qualified electrician in accordance with local and national safety codes.

- The electrical system must conform to local and national safety standards.
- The dishwasher can be plugged into an electrical outlet (the outlet must be accessible after installation). This will then make it easier to perform an electrical safety check, e.g. during repair or service work.
- If the dishwasher is permanently wired to the electricity supply, a main switch capable of disconnecting the dishwasher at all poles must be installed. This switch must have a contact gap of at least 3 mm and also be lockable in the neutral position.
- For added safety, a ground fault interrupter with a release current of 30 mA should be installed upstream of the dishwasher.
- If necessary, equipotential bonding can be carried out.
- The power cord may only be replaced by an original Miele spare part.
- For technical data, see the data plate or the accompanying wiring diagram.

The dishwasher may only be operated with the voltage, frequency, and fuse rating shown on the **data plate**.

This appliance **can be converted to a different type of power supply** in accordance with the accompanying conversion and wiring diagrams.

The **conversion diagram** and the **data plate** are supplied with and affixed to the appliance, respectively.

Grounding connection

The ground lead must be connected to the screw connection point (marked with the ground symbol \downarrow) at the back of the machine.

WARNING
THIS APPLIANCE MUST BE GROUNDED

Electrical connection

Peak-load negotiation

The Commercial Dishwasher is suitable for use in an energy management system. For this purpose, it must be technically adapted and the controls reset by Miele Technical Service.

Please contact Miele Technical Service for further information.

Peak-load management

In the event of a peak load cut-out, some components of the Commercial Dishwasher such as the heater element will be switched off for a while. The Commercial Dishwasher will remain on during this period and the current program will not be interrupted. If one of the components that is switched off is needed during the current program stage, the program cycle time will simply increase for the duration of the load cut-out.

The third line of the display will alert you to the peak load cut-out, for example:

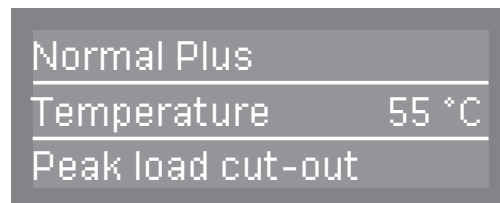

Connecting the water supply

 The water in the dishwasher is NOT safe to drink!

- The Commercial Dishwasher's connection to the water supply system must be in compliance with local codes.
- The water used must at least comply with national regulations for drinking water quality. If the water supply has a high iron content, there is a danger of corrosion occurring on items being cleaned in the Commercial Dishwasher, as well as the machine itself. If the chloride content of the water exceeds 100 mg/l, the risk of corrosion to items being cleaned in the dishwasher will be further increased.
- In certain regions (e.g., mountainous areas), the typical water composition can cause precipitates to form, which in turn requires the use of softened water for the Commercial Dishwasher.
- A device for preventing the return flow of water is not necessary, as this Commercial Dishwasher conforms to the applicable standards for the protection of drinking water.
- The water intake pressure must amount to at least 29 psi (200 kPa) overpressure. If the pressure is below 29 psi (200 kPa), the water intake time is extended automatically. The maximum permissible static pressure amounts to 145 psi (1000 kPa) (overpressure). If the water intake pressure does not lie in the 29-145 psi (200-1000 kPa) range, contact Miele Technical Service for advice.
- The Commercial Dishwasher is supplied as standard for connection to cold water (blue coded hose) **and** hot water up to 149°F (65°C) (red coded hose). Connect the intake hoses to the faucets for cold and hot water.
- If no hot water supply is available, the intake hose with the **red** marking must also be connected to the cold water supply.
- A faucet with a 3/4 inch male thread must be provided on site. The valve should be easily accessible, since the water supply should be shut off whenever the dishwasher is not in use.
- The DN 10 intake hose is approx. 5'7" (1.7 m) long, terminating in a 3/4 inch female thread. A 4' 11" (1.5 m) long flexible metal extension hose tested to 2,030 psi (14,000 kPa) is available as an optional accessory if required. On no account may the intake filter in the female thread be removed.
- Install the large-surface filter (included in the accessory pack) between the faucet and the intake hose (see "Cleaning and care, Water intake").

Plumbing

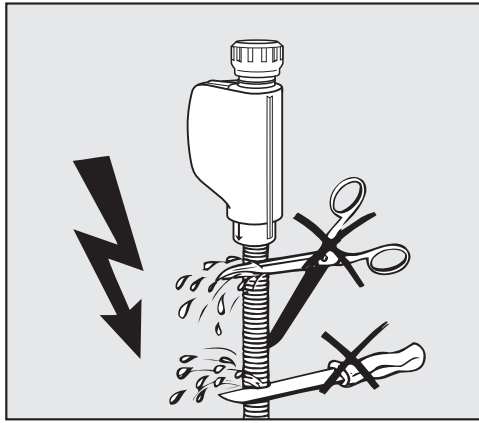

⚠ Do **NOT** shorten or otherwise damage the inlet hoses (see diagram).

Also refer to the supplied installation diagram!

Connection to the drainage system

- The dishwasher drain contains a built-in non-return valve which prevents dirty water from flowing back into the dishwasher via the drain hose.
- Ideally, the dishwasher should be connected to a **separate** on-site drainage system. If a separate connection is not available, we recommend connecting the dishwasher to a dual-chamber trap. The on-site connection must be positioned between 12" and 40" (0.3 m and 1 m) above the bottom edge of the dishwasher. If the connection is lower than the minimum height, the drain hose must be bent to maintain a height of 12" (0.3 m).
- The dishwasher is equipped with a 59" (1.5-m) long flexible drain hose (clear width of 7/8" (22 mm)). Clamps for connecting the hose are included with the dishwasher.
- Do not shorten the drain hose! The hose can be extended by a connecting piece and an additional hose. The length of the drainage line may not exceed 13' (4 m).
- The drainage system must be able to handle a discharge rate of at least 4.2 g/min (16 l/min).

⚠ Make sure that there are no kinks in the hose, and that it is not crushed or stretched.

Please also refer to the accompanying installation diagram!

Technical details

Height	32 5/16" (820 mm) adjustable + 2 1/4" (60 mm)
Height with cover	32 7/8" (835 mm) adjustable + 2 1/4" (60 mm)
Width	23 1/2" (598 mm)
Depth Depth with door open	22 13/16" (580 mm) 49 1/2" (1180 mm)
Weight (net)	154 lbs (70 kg)
Voltage, rated load, fuse rating	See data plate
Power cord	Approx. 1.7 m
Water temperature: Cold water connection Hot water connection	Max. 68°F (20°C) Max. 149°F (65°C)
Static water intake pressure	Max. 145 psi (1000 kPa) overpressure
Recommended water intake pressure: Cold and hot water connection	29 psi (200 kPa) overpressure
Minimum water intake pressure: Cold and hot water connection	5.8 psi (40 kPa) overpressure
Drain height	Min. 1' (0.3 m), max. 3' 3" 1.0 m
Drain hose length	Max. 13' 1" (4.0 m)
Ambient temperature	40 - 104°F (5°C - 40°C)
Relative humidity Maximum Linear decreasing to	80% for temperatures up to 88°F (31°C) 50% for temperatures up to 104°F (40°C)
Intake hoses	Approx. 5' 7" (1.7 m)
Drain hose	Approx. 4' 9" (1.5 m)
Noise emission values Sound power in LwA Sound pressure in LpA	Undercounter installation with wooden trim in front of base, Rapid program 59 dB (A) 47 dB (A)
Certification marks	UL 749
CE mark	Machinery Directive 2006/42/EC
Manufacturer's address	Miele & Cie. KG, Carl-Miele-Straße 29, 33332 Gütersloh, Germany

**Please have the model and serial number
of your machine available when
contacting Technical Service.**

U.S.A.

Miele, Inc.

National Headquarters

9 Independence Way
Princeton, NJ 08540
Phone: 800-991-9380
www.mieleusa.com/professional
prosales@mieleusa.com

Technical Service & Support

Phone: 800-991-9380
proservice@mieleusa.com



Miele & Cie. KG
Carl-Miele-Straße 29, 33332 Gütersloh, Germany