









Operating and installation instructions Commercial washing machine PWM 514 PWM 520

Always read the operating instructions before setting up, installing and commissioning the machine. This prevents both personal injury and damage to the machine.

en-GB

Contents

| | |
|---|-----------|
| Caring for the environment | 5 |
| Warnings and safety notes | 6 |
| Appropriate use | 7 |
| Foreseeable misuse | 8 |
| Technical safety | 9 |
| Correct use..... | 11 |
| Chlorine and component damage..... | 13 |
| Accessories | 14 |
| Disposing of your old machine | 14 |
| Description of the machine | 15 |
| Models with detergent drawer (WEK) | 15 |
| Models without detergent drawer (WEK) | 16 |
| Operation | 17 |
| Control panel..... | 17 |
| Sensor controls and touch display..... | 17 |
| Main menu | 18 |
| Examples of how to operate the machine | 18 |
| Operating a launderette machine | 20 |
| Preparing for use | 21 |
| Emptying pockets..... | 21 |
| Load capacities | 21 |
| Loading the washing machine | 22 |
| Selecting a programme | 23 |
| Selecting programme settings | 24 |
| Washing with detergent drawer | 25 |
| Adding detergent using the detergent drawer | 25 |
| Bleaching agents | 26 |
| Dyes, dye removers and descalers | 26 |
| Detergent dispensing..... | 26 |
| Detergent dispensing quantity | 26 |
| Water hardness levels..... | 26 |
| Programme start – programme end | 28 |
| Timer | 30 |
| Problem solving guide | 31 |
| Customer Service Department | 32 |
| Problem solving guide | 34 |
| Problem solving guide..... | 34 |
| The wash programme does not start | 34 |
| Insufficient wash results | 35 |
| General problems with the washing machine..... | 36 |
| Possible reasons for increased levels of foaming..... | 37 |
| Large items stretched..... | 37 |
| To continue a programme after an interruption to the power supply | 37 |
| Cleaning and care | 38 |
| Build-up of rust..... | 38 |
| Cleaning the detergent drawer, detergent compartments and siphons | 39 |

| | |
|--|-----------|
| Installation | 41 |
| Installing the washing machine | 41 |
| Securing the machine | 41 |
| General operating conditions | 41 |
| For easy maintenance..... | 42 |
| Installation on a raised plinth..... | 42 |
| Transport safety devices | 43 |
| Removing the transport safety devices | 43 |
| Plumbing..... | 44 |
| Dispensing agent connection to the liquid dispensing mixing compartment | 45 |
| Drainage..... | 46 |
| Electrical connection | 46 |
| Extras | 47 |
| Selecting extras | 47 |
| Pre-wash  | 47 |
| Pre-rinse  | 47 |
| Rinse plus  | 47 |
| Soak  | 47 |
| Intensive  | 47 |
| Water plus  | 47 |
| Rinse hold  | 47 |
| Fill stop  | 47 |
| Special features in the programme sequence | 48 |
| Spinning | 48 |
| Omitting the final spin (Rinse hold) | 48 |
| Anti-crease | 48 |
| Changing the programme sequence | 49 |
| Changing a programme | 49 |
| Altering the wash programme..... | 49 |
| Cancelling a programme..... | 49 |
| Switching on the washing machine after an interruption to the power supply..... | 49 |
| Adding or removing laundry | 50 |
| Supervisor level | 51 |
| Opening the Supervisor level..... | 51 |
| Opening the Supervisor level (self-service) | 51 |
| Code-based access | 51 |
| Changing the code | 51 |
| Closing the Settings menu..... | 51 |

Contents

| | |
|---|-----------|
| Operation/display..... | 52 |
| Language..... | 52 |
| Language menu..... | 52 |
| Set languages..... | 52 |
| Display brightness..... | 52 |
| Clock display..... | 53 |
| Date..... | 53 |
| Volume..... | 53 |
| Visibility parameters..... | 53 |
| Sort Extras..... | 53 |
| Machine off status..... | 53 |
| Delay start..... | 53 |
| Memory..... | 53 |
| Temperature unit..... | 54 |
| Weight unit..... | 54 |
| Change code..... | 54 |
| Programme selection..... | 55 |
| Controls..... | 55 |
| Programme packages..... | 56 |
| Sort programmes..... | 56 |
| Prog. colour allocation..... | 56 |
| Hygiene..... | 56 |
| Expert code..... | 56 |
| Process technology..... | 57 |
| Anti-crease..... | 57 |
| Service interval..... | 57 |
| Water inlet..... | 58 |
| Legal information..... | 58 |
| Technical data..... | 59 |
| PWM 514 machine data..... | 59 |
| Electrical connection..... | 59 |
| Installation dimensions..... | 59 |
| Weight and floor load..... | 59 |
| Emission values..... | 59 |
| Product safety..... | 59 |
| WiFi..... | 59 |
| PWM 520 machine data..... | 60 |
| Electrical connection..... | 60 |
| Installation dimensions..... | 60 |
| Weight and floor load..... | 60 |
| Emission values..... | 60 |
| Product safety..... | 60 |
| WiFi..... | 60 |
| EU declaration of conformity..... | 61 |
| UK declaration of conformity..... | 61 |
| WiFi data protection..... | 62 |
| Data protection and data security..... | 62 |
| Factory default settings for network configuration..... | 62 |
| Copyright and licences..... | 62 |

Disposal of the packaging material

The packaging is designed to protect the washing machine against transportation damage. The packaging materials used are selected from materials which are environmentally friendly for disposal and can therefore be recycled.

Recycling the packaging material reduces the use of raw materials in the manufacturing process and also reduces the amount of waste in landfill sites. Your dealer will take the packaging material away.

Disposing of your old machine

Old electrical and electronic appliances often contain valuable materials. However, they also contain harmful substances which were essential for their correct functioning and safety. These could be hazardous to human health and to the environment if disposed of with household waste or if handled incorrectly. Please do not, therefore, dispose of your old machine with household waste.

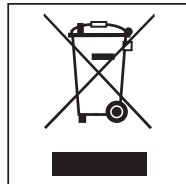

Please dispose of it at your local community waste collection/recycling centre for electrical and electronic appliances. Consult your dealer if necessary.

Please ensure that your old machine poses no risk to children while being stored for disposal.

Energy saving tips

Energy and water consumption

- To get the most out of your machine, load the **maximum** dry load size for the wash programme you are using. Energy and water consumption is most efficient when a full load is washed.

Detergent

- Do not exceed the amounts of detergent recommended by the manufacturer on the packaging.
- Reduce the amount of detergent for smaller load sizes.

When drying with a tumble dryer

Select the highest possible spin speed for the wash programme to save energy in the subsequent tumble dryer cycle.

Warnings and safety notes

This washing machine complies with all current local and national safety requirements. Inappropriate use can, however, lead to personal injury and material damage.

Read the operating instructions carefully before using the washing machine. They contain important information on safety, installation, use and maintenance. This prevents both personal injury and damage to the washing machine.

Miele expressly and strongly advises that you read and follow the instructions in the section on installing the washing machine as well as the safety notes and warnings.

Miele cannot be held liable for injury or damage caused by non-compliance with these instructions.

Keep these operating instructions in a safe place and pass them on to any future owner.

When instructing other people how to use the washing machine, they must be made aware of these safety notes and warnings.

Appropriate use

- ▶ The washing machine is only suitable for washing fabrics with a care label stating that they are suitable for machine washing. Any other applications may be dangerous. The manufacturer cannot be held liable for damage resulting from incorrect or improper use or operation of the machine.
- ▶ This washing machine must be used as described in the operating instructions and must be checked on a regular basis to make sure it is functioning correctly. Maintenance must be carried out when necessary.
- ▶ The washing machine is not suitable for outdoor use.
- ▶ Do not install the washing machine in a room where there is a risk of frost. Frozen hoses are at risk of tearing or bursting. The reliability of the electronic module may be impaired at temperatures below freezing point.
- ▶ This washing machine is intended only for use in a commercial environment.
- ▶ If the machine is used in a commercial environment it may only be operated by instructed/trained personnel. If the machine is used in a publicly accessible area, the supervisor must ensure that it can be operated safely without risk of danger.
- ▶ The washing machine must not be used in a non-stationary installation site (e.g. on a ship).
- ▶ This washing machine can only be used by people with reduced physical, sensory or mental capabilities, or lack of experience or knowledge, if they are supervised whilst using it or have been shown how to use it in a safe way and understand and recognise the consequences of incorrect operation.
- ▶ Children under the age of 8 must not be allowed near the washing machine unless they are constantly supervised.
- ▶ Children over the age of 8 may only use the washing machine without supervision if its operation has been clearly explained to them and they are able to use it safely. Children must be able to understand and recognise the possible dangers caused by incorrect operation.
- ▶ Children may not carry out cleaning or maintenance on the washing machine unsupervised.
- ▶ Always supervise any children in the vicinity of the washing machine. Never allow children to play with the washing machine.
- ▶ Disinfection programmes must not be interrupted, as this can have a limiting effect on the disinfection result. It is the operator's responsibility to ensure that the standard of disinfection in thermal as well as chemo-thermal procedures is maintained by carrying out suitable validation tests.

Warnings and safety notes

Foreseeable misuse

▶ Never use solvent-based cleaning agents, e.g. those containing benzene, in this machine. Doing so may result in damage to component parts and create toxic steam and fumes. **Risk of fire and explosion!**

▶ When washing with high temperatures, remember that the porthole glass becomes hot. Do not let children touch it during the wash process.

Danger of burning!

▶ Close the drum door after each wash cycle. This is to avoid the risk of children trying to climb into the washing machine or hide things in it, and animals getting into the machine.

▶ Do not damage, remove or bypass the safety features or control elements of this washing machine.

▶ Machines with a damaged control panel, wires or cables must not be used until they have been repaired.

▶ Water used for washing in this machine consists of suds and is not drinking water! Drain the suds into a proper drainage system.

▶ Always make sure that the drum is stationary before reaching in to remove laundry. Reaching into a moving drum is extremely dangerous.

▶ Be careful not to put your hands in the gap between door and frame when closing the drum door.

Please note: the drum door is locked automatically as soon as the washing machine starts.

▶ It is particularly important to follow the manufacturer's instructions when using a combination of cleaning agents and special application products. Products must only be used for applications approved by the manufacturer to avoid any material damage or the occurrence of strong chemical reactions.

Technical safety

- ▶ Before setting up the washing machine, check it for any externally visible damage. Do not install or use a damaged washing machine.
- ▶ The electrical safety of this washing machine can only be guaranteed when correctly earthed. It is most important that this basic safety requirement is tested and in case of any doubt the on-site wiring system should be inspected by a specialist. Miele cannot be held liable for the consequences of an inadequate earthing system.
- ▶ Unauthorised repairs could result in unforeseen dangers for the user, for which the manufacturer cannot accept liability. Repairs should only be undertaken by a Miele authorised technician, otherwise any subsequent damage will not be covered by the warranty.
- ▶ Do not make any alterations to the washing machine, unless authorised to do so by Miele.
- ▶ Disconnect the washing machine from the power supply in the event of a fault and for cleaning and maintenance. The washing machine is only electrically disconnected from the power supply when:
 - the plug of the washing machine is unplugged, or
 - the mains fuse is disconnected, or
 - the screw-in fuse has been completely removed

For more information, see “Installation – Electrical connection”.

▶ The washing machine may only be connected to the water supply using the set of hoses supplied with the machine. Old sets of hoses must not be re-used. Check the sets of hoses regularly for signs of wear. Change the sets of hoses in good time to avoid the risk of leaks and subsequent water damage.

▶ The cause of any leaks must be dealt with before the washing machine is restarted. Disconnect the washing machine immediately if any water leaks out.

▶ Steam heating malfunctions can result in high temperatures at the door, the dispenser and inside the drum (in particular at the edge of the drum). There is a risk of slight burns.

This only applies to machines with steam heating.

▶ Faulty components must only be replaced by genuine Miele spare parts. Miele can only guarantee the safety standards of the machine when Miele spare parts are used.

▶ All relevant national provisions and regulations (DGUV in Germany) relating to accident insurance are applicable to this machine. It is recommended to carry out testing in accordance with the regulatory framework described in DGUV 100-500/Chapter 2.6/Section 4. The test book required for the documentation is available from the Miele Customer Service Department.

▶ Please observe the instructions in “Installation and connection” and “Technical data”.

▶ The plug for the washing machine must always be kept accessible so that the machine can be easily disconnected from the power supply.

▶ For hard-wired machines, an all-pole means of deactivation must be provided on site.

▶ If the machine is to be hard-wired, there must be a means of disconnecting all poles from the power supply. The mains isolator must be close to the washing machine and be clearly identifiable, unobstructed and easily accessible at all times.

Warnings and safety notes

- ▶ For washing machine versions without a separate emergency off switch, there must be a central emergency off button at the place of installation.

Correct use

- ▶ The maximum load size for PW 514 is 14 kg and for PW 520 is 20 kg. The maximum recommended load sizes for individual programmes are given in the “Programme chart”.
 - ▶ Before using the washing machine for the first time, check that the transit bars have been removed (see “Installation – Removing the transit bars”). During spinning, transit bars which are still in place may result in damage to both the washing machine and adjacent furniture or machines.
 - ▶ Never try to open the drum door of the washing machine using force. The door can only be opened when a corresponding message appears in the display.
 - ▶ Do not push the suspended drum unit while the machine is running.
 - ▶ When closing the door there is a danger of crushing and shearing between the door frame and the drum opening and also at the hinges. Caution: the drum door locks automatically when the machine is started.
 - ▶ Close the stopcock if the washing machine is to be left for any length of time (e.g. while on holiday), especially if there is no floor drain (gully) in the immediate vicinity.
 - ▶ Take care to ensure that foreign objects (e.g. nails, pins, coins, paper clips) do not find their way into the machine with the laundry. Foreign objects may damage components of the machine (e.g. suds container, drum). Damaged components can damage the laundry.
 - ▶ If the correct amount of detergent is dispensed, the washing machine should not need to be descaled. If, however, you do wish to descale your washing machine, only use proprietary non-corrosive descaling agents. Special descaling agent is available from your Miele dealer or from the Miele Customer Service Department. Strictly observe the instructions for the descaler.
 - ▶ Textiles which have been pre-treated in solvent-based cleaning agents must be rinsed in clean water before being washed in the machine. Note that solvent residues may only be discharged into waste water in compliance with local legislation.
 - ▶ Never use solvent-based cleaning agents, e.g. those containing benzene, in this machine. Doing so may result in damage to component parts and create toxic steam and fumes. **Risk of fire and explosion!**
 - ▶ Do not store or use petrol, paraffin or any easily flammable substances near the washing machine. Do not use the machine lid as storage space.
- Risk of fire and explosion!**
- ▶ Do not store chemicals (liquid detergents, additives) on the machine lid. They may cause discolouration or lacquer damage. Accidentally spilled chemicals should be removed from the surface immediately with a wet cloth.
 - ▶ There is a fan outlet on the back of the machine. Under no circumstances must this be blocked. Please observe the minimum distance on the installation diagram.
 - ▶ Only use dyes, dye removers and descalers suitable for use in a washing machine. The manufacturer’s instructions on the packaging must be observed.

Warnings and safety notes

- ▶ Dye removers contain sulphur compounds which can cause damage such as corrosion. Do not use these products in this washing machine.
- ▶ Avoid contact of stainless steel surfaces with liquid cleaning and disinfecting agents which contain chlorine or sodium hypochlorite. These agents can have a corrosive effect on stainless steel. Aggressive chlorine bleach vapours can also be corrosive. Do not store open containers of these agents near the machine.
- ▶ Do not use a pressure washer or hose to clean the washing machine.

Chlorine and component damage

► Frequent use of chlorine products increases the risk of damage to components.

► The use of substances containing chlorine, such as sodium hypochlorite and chlorine bleach in powder form, can result in damage to the protective layer of stainless steel and corrosion on components. Therefore, refrain from using substances containing chlorine. Use oxygen-based bleaching agents instead.

If, however, chlorine bleaching agents are used, an anti-chlorine treatment must always be carried out. Otherwise, both the washing machine components and the laundry may suffer persistent and irreparable damage.

► Anti-chlorine treatment must be carried out immediately after chlorine bleaching agents have been used. Hydrogen peroxide as well as oxygen-based detergents and bleaching agents are suitable for anti-chlorine treatment. The suds must not be drained in between.

Treatments with thiosulphates can result in gypsum-like deposits particularly when used in combination with hard water. This gypsum can build up in the washing machine or cause incrustations on the laundry. Treatment with hydrogen peroxide is recommended over treatment with thiosulphates because hydrogen peroxide neutralises chlorine.

The exact dispensing quantities and the treatment temperatures required must be set and tested on site in accordance with the dispensing recommendations of the detergent and cleaning agent manufacturers. The laundry must also be tested to check whether it contains any active chlorine residues.

Warnings and safety notes

Accessories

▶ Accessory parts may only be fitted when expressly approved by Miele. If other parts are used, warranty, performance and/or product liability claims will be invalidated.

Disposing of your old machine

▶ Ensure that the door locks are unusable when disposing of or scrapping old washing machines. This will prevent the risk of children accidentally locking themselves in while playing and endangering their lives.

Miele cannot be held liable for damage caused by non-compliance with these safety notes and warnings.

Models with detergent drawer (WEK)

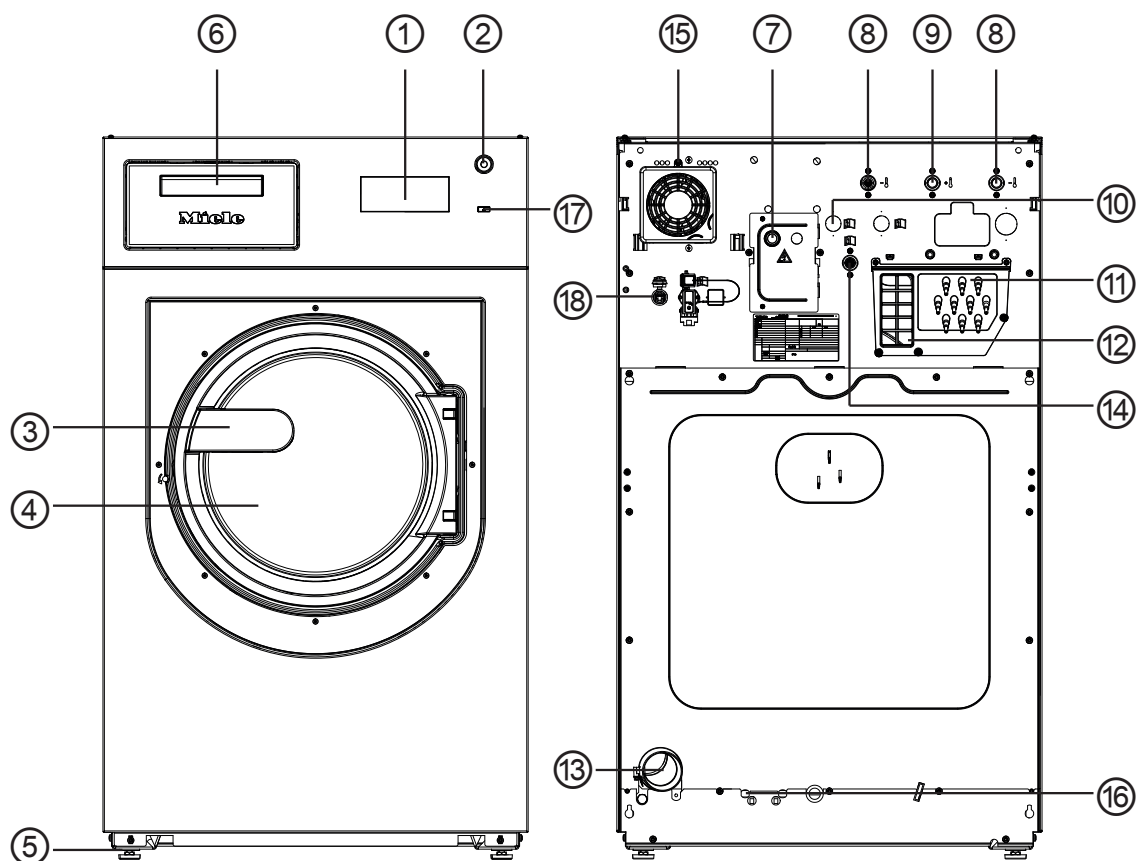

- ① **Display**
see "Control panel"
- ② **Emergency off switch**
see "Control panel"
- ③ **Door handle**
- ④ **Drum door**
- ⑤ **Four adjustable feet**
- ⑥ **Detergent drawer**
- ⑦ **Electrical connection**
- ⑧ **Cold water connection**
- ⑨ **Hot water connection**
- ⑩ **2 x hard water connection**
(optional)

- ⑪ **Connections for external dispenser pumps**
- ⑫ **Vapour extraction/free outlet Type AB**
- ⑬ **Drainage**
- ⑭ **Cold water connection for liquid dispensing**
(optional)
- ⑮ **Fan casing**
- ⑯ **Connection option for direct/indirect steam**
(depending on model)
- ⑰ **I button**
- ⑱ **Interface for communicating with external machines**

Description of the machine

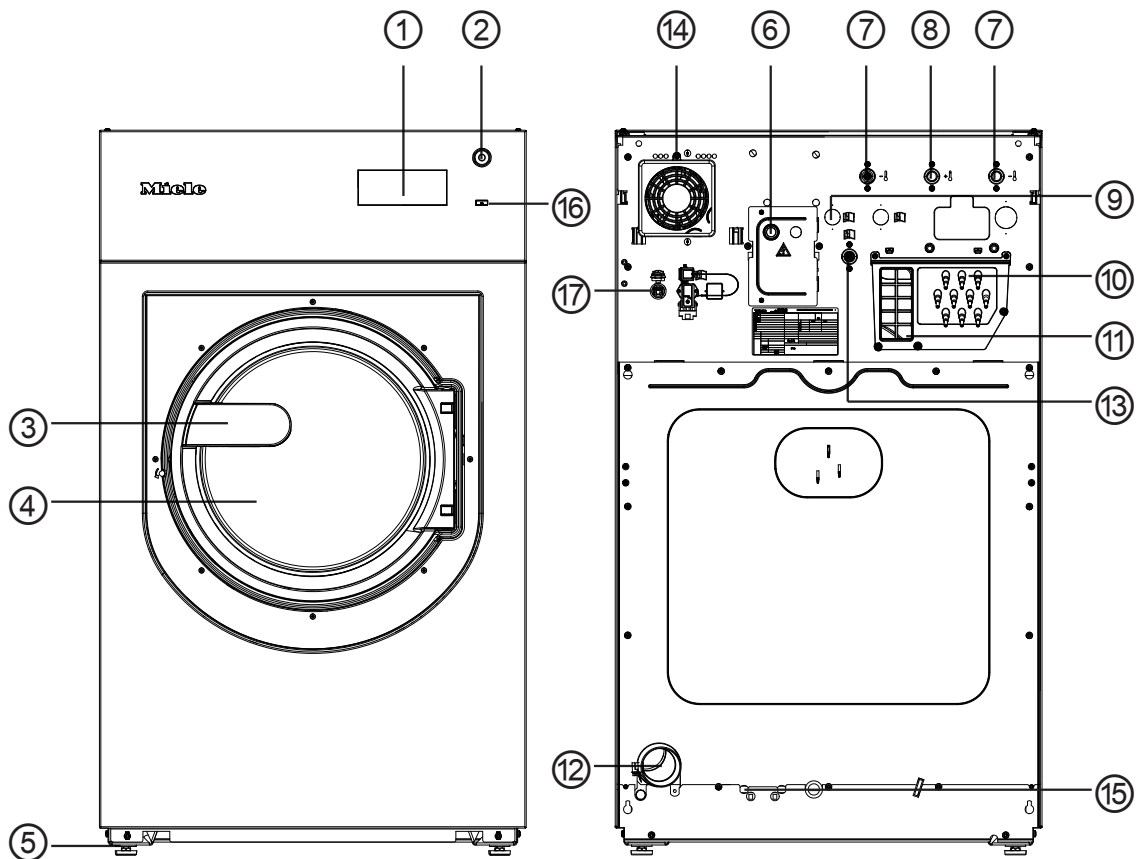

Models without detergent drawer (WEK)



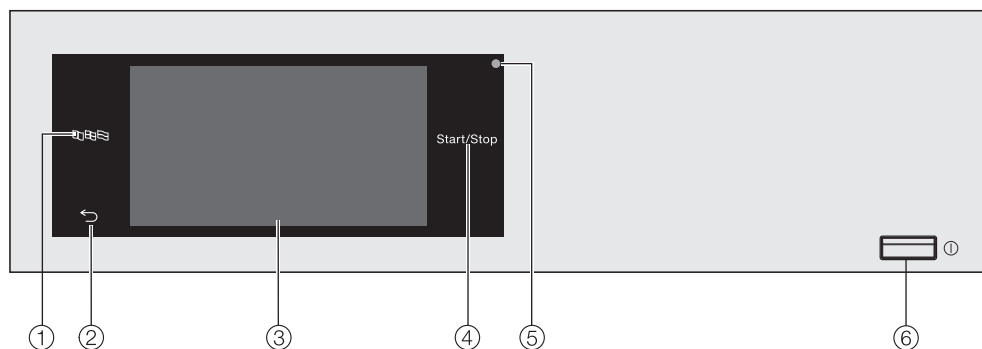

- ① **Display**
see "Control panel"
- ② **Emergency off switch**
see "Control panel"
- ③ **Door handle**
- ④ **Drum door**
- ⑤ **Four adjustable feet**
- ⑥ **Electrical connection**
- ⑦ **Cold water connection**
- ⑧ **Hot water connection**
- ⑨ **2 x hard water connection**
(optional)
- ⑩ **Connections for dispenser pumps**
- ⑪ **Vapour extraction/free outlet Type AB**
- ⑫ **Drainage**
- ⑬ **Cold water connection for liquid dispensing**
- ⑭ **Fan casing**
- ⑮ **Connection option for direct/indirect steam**
(depending on model)
- ⑯ **I button**
- ⑰ **Interface for communicating with external machines**

Control panel



- ① **Language sensor control**  For selecting the current user language. The supervisor language is displayed again at the end of the programme.
- ② **Back sensor control**  Takes you back one level in the menu.
- ③ **Touch display**
- ④ **Start/Stop sensor control** For starting the wash programme selected and cancelling a programme once it has started. The programme selected can be started as soon as the sensor control starts flashing.
- ⑤ **Optical interface** For the Customer Service Department.
- ⑥ **① button** For switching the washing machine on and off. To save energy, the washing machine will switch off automatically. It is switched off 15 minutes after the end of the programme/Anti-crease phase, or after being switched on if no further selection is made.

Sensor controls and touch display

The sensor controls ,  and *Start/Stop* and the elements in the display respond to finger tip contact. Every touch of a sensor control is confirmed with an audible keypad tone. You can adjust the volume of the keypad tone or switch it off (see “Supervisor level”).

The control field with sensor controls and the touch display can be scratched by pointed or sharp objects, e.g. pens. Only touch the control field with your fingers.

Main menu

After switching on the washing machine, the main menu will appear in the display.

You can access all the important sub-menus from the main menu.

Touch the  sensor control at any time to return to the main menu. Values set previously are not saved.

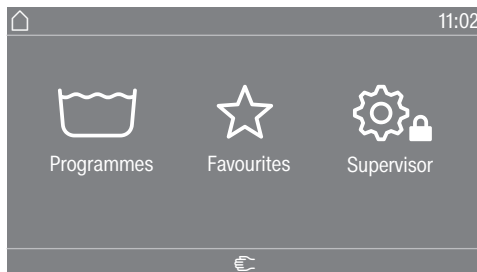

 Programmes menu In this menu, you can select the wash programmes.

 Favourites For selecting one of 12 favourite programmes which can be set up and saved by the supervisor (see “Favourite programmes” under “Supervisor level”).

 Supervisor You can alter the washing machine’s electronic module to suit changing requirements in the supervisor level (see “Supervisor level”).

Examples of how to operate the machine

Lists

Programme menu (single selection)

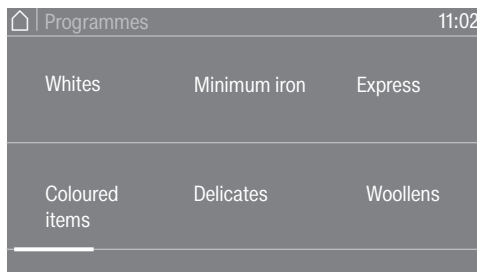

You can scroll right or left by swiping your finger across the screen. To do this, place your finger on the touch display and swipe it in the direction you want.

The orange scroll bar shows that there are further options to choose from.

Touch a programme name to select the wash programme.

The display will change to the standard menu for that programme.

Extras menu (multiple selection)

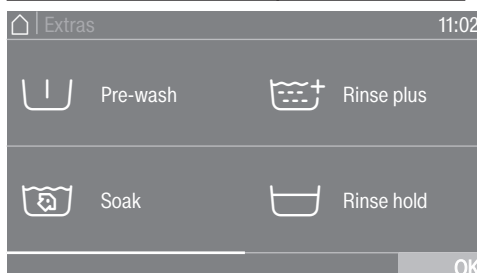

Touch one or several *Extras* to select it/them.
 Currently selected *Extras* are marked orange.
 To deselect an *Extra* simply touch the *Extra* again.
 Use the *OK* sensor control to activate all selected *Extras*.

Setting numerical values

You can set numerical values in some menus.

The following example shows how to set the time of day. The “Supervisor level” section describes how to get to this level.

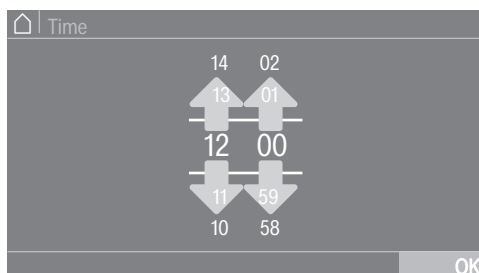

Enter the numbers by swiping up or down.

Place your finger on the number that you want to change and move your finger in the direction you want. Use the *OK* symbol to accept the set numerical value.

Tip: A numerical keypad may also appear to adjust the value for some settings.

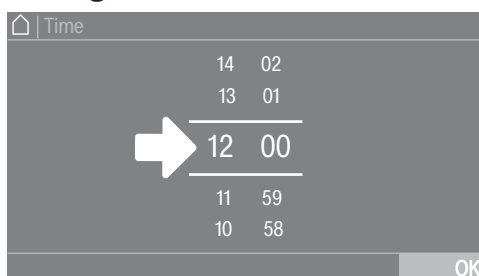

Briefly touching a number between the two lines will bring up the numerical keypad.

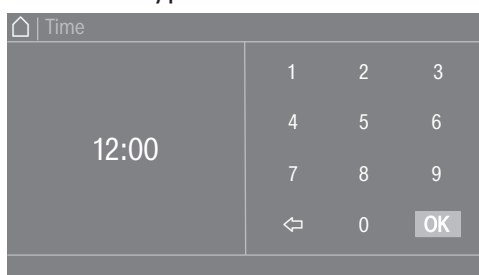

Once a valid number has been entered, the *OK* symbol will be highlighted green.

Pull-down menu

The following example describes the display for an ongoing wash programme. The “Programme start – programme end” section describes how to get to this level.

Operation



If an orange bar appears at the top of the screen in the middle of the display, you can open the pull-down menu. Touch the bar and drag it down with your finger on the display.

Exiting a menu level

- Touch the ↶ symbol to return to the previous screen.

Entries you have made before this which have not yet been confirmed with *OK* will not be saved.

Help display

With some menus, Help appears along the bottom line of the display.

- Touch the Help sensor control to display the text.
- Touch the Close sensor control to return to the previous screen.

Operating a launderette machine

The main menu will vary depending on the programming status (see “Supervisor level – Controls”).

Shortcuts are the easiest way to operate the machine. Operating staff are unable to change pre-set programmes.

Lauderette, basic

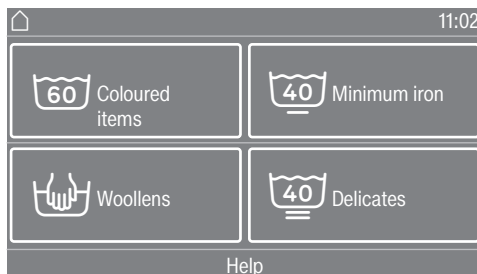

Between 4 and 12 pre-set programmes are available. These programmes cannot be changed by the user.

Laudrette Logo

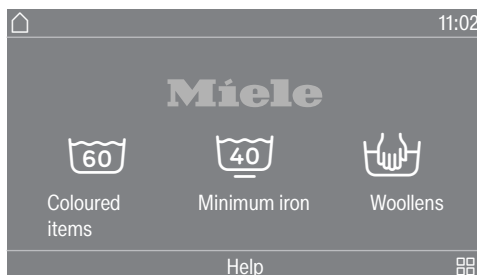

Up to 12 pre-set programmes are available. The first 3 programmes can be selected directly. The remaining programmes are selected from a list . These programmes cannot be changed by the user.

Emptying pockets

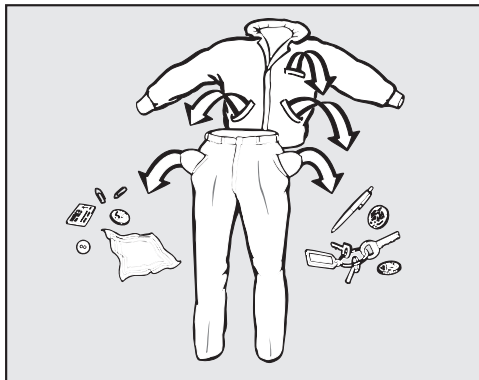

- Empty all pockets.

⚠ Damage due to foreign objects.
Nails, coins, paper clips, etc. can cause damage to garments and components inside the machine.
Check laundry before washing and remove any foreign objects.

Load capacities

(dry laundry)

| PWM 514 | PWM 520 |
|------------|------------|
| max. 14 kg | max. 20 kg |

Load capacities are given in the programme chart.

Preparing for use

Loading the washing machine

- Switch on the washing machine with the **I** button.
- Pull the door handle to open the drum door.
- Unfold the laundry and load loosely into the drum. Mixing both large and small items gives better wash results and also helps distribute the load evenly during spinning.

The most efficient use of energy and water is achieved when a full load is washed. However, do not overload as this reduces cleaning efficiency and causes creases.

Closing the drum door

- Close the drum door by pressing it until the pre-latch engages.

 Make sure that no items are caught between the drum door and the sealing ring.

The drum door engages, but does not lock yet. The drum door locks automatically as soon as the machine starts.

Switching on the washing machine

- Press the ⓘ control.

Selecting a programme

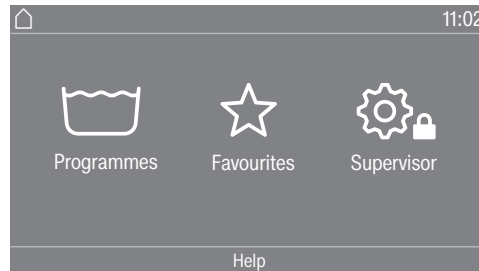

There are different ways to select a programme.

You can select a programme from the Programmes menu.

- Touch the Programmes sensor control.

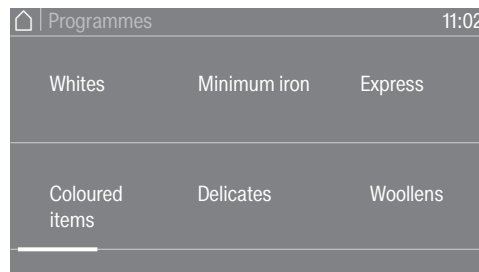

- Scroll to the right in the display until the programme you want appears.
- Touch the sensor control for that programme.

The display will change to the standard menu for that wash programme.

Alternatively, you can select a programme from the Favourites menu.

The programmes under Favourites can be changed by the supervisor (see “Supervisor level – Favourite programmes”).

- Touch the Favourites sensor control.

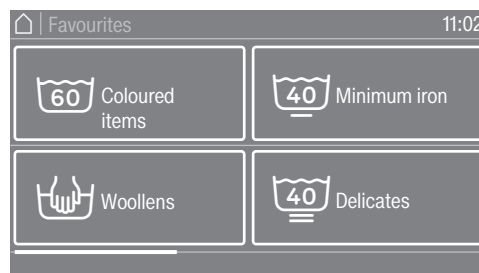

- Scroll to the right in the display until the programme you want appears.
- Touch the sensor control for that programme.

The display will change to the standard menu for that wash programme.

In the case of Favourite programmes, the majority of the programme settings are already fixed and cannot be changed.

Selecting programme settings

Selecting a load

To enable load-specific dispensing, you can specify the load for some programmes.

- Touch the **Weight** sensor control.
- Enter a valid value for the load size.

The display will change to the **Overview** menu.

Selecting a temperature

You can alter the pre-set temperature of a wash programme.

- Touch the **Temperature** sensor control.
- Select the desired temperature.

The display will change to the **Overview** menu.

Selecting a spin speed

You can alter the pre-set spin speed of a wash programme.

- Touch the **Spin speed** sensor control.
- Select the spin speed you want.

The display will change to the **Overview** menu.

Selecting Extras

You can select Extras for some wash programmes.



- Touch the **Extras** sensor control.
- Select one or more Extras.
- Confirm with the **OK** sensor control.

The display will change to the **Overview** menu.

See “Extras” for further information.

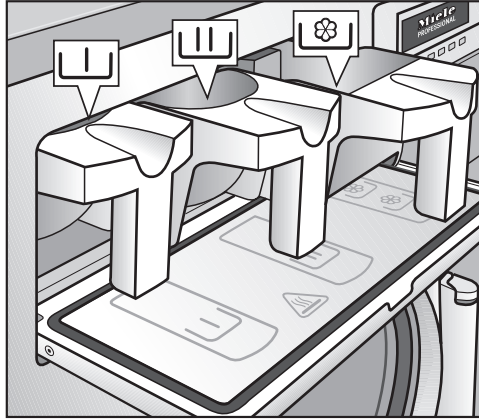
Adding detergent using the detergent drawer



- For standard wash programmes add the powder detergent for the main wash to the  drawer and if desired, add detergent for a pre-wash to the  drawer. Add fabric conditioner to the front of the  drawer.

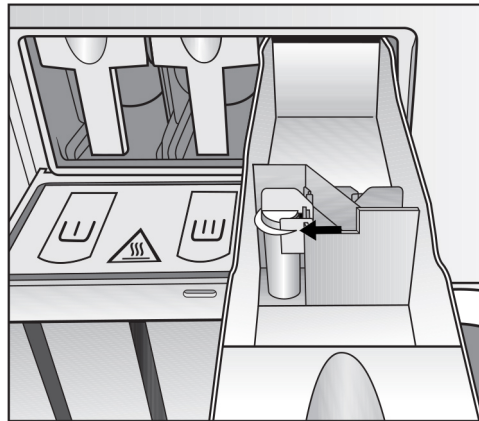

- Add any other detergent additives to the back of the  drawer (if this has been programmed).

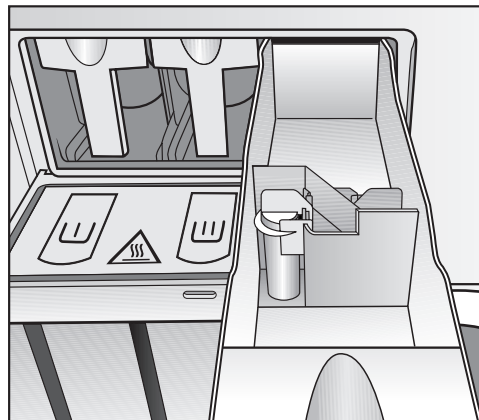

Do not fill the  drawers above the level marker with detergent additives.

Otherwise they will run straight through the siphon into the suds container.

Washing with detergent drawer

Bleaching agents

Only use bleaching agents on fabrics with the Δ symbol on the wash care label.

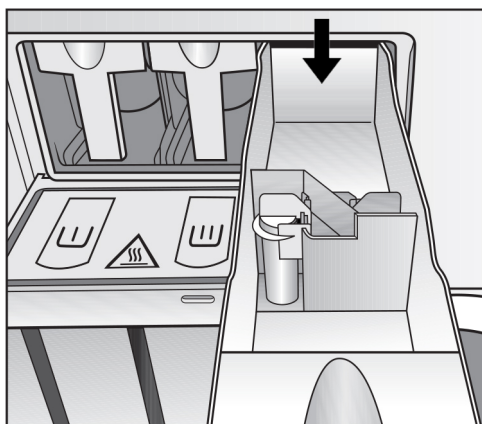

Liquid bleaching agents must only be dispensed through the designated dispenser drawer. The agent will then be dispensed automatically during the second rinse. Liquid bleaching agents should only be used on coloured items which have a wash care label stating that they are colour fast and suitable for bleaching.

 Frequent use of chlorine products increases the risk of damage to components.

Dyes, dye removers and descalers

Proprietary dyes, dye removers and descalers may only be used in this washing machine if the manufacturer expressly states that they are suitable for use in a washing machine. The manufacturer's instructions on the packaging must be observed.

Detergent dispensing

Detergent dispensing

Avoid dispensing more than the required amount as this can cause excessive foaming.

- Only use low foaming detergents.
- Dispense according to the detergent manufacturer's recommendations.

The dispensing amount will depend on:

- The amount of laundry
- The water hardness
- How dirty the laundry is

Detergent dispensing quantity

Please dispense according to water hardness levels and follow the detergent manufacturer's instructions.

Water hardness levels

| Water hardness level | Total hardness in mmol/l | German scale °dH |
|----------------------|--------------------------|------------------|
| I (soft) | 0–1.5 | 0–8.4 |
| II (medium) | 1.5–2.5 | 8.4–14 |
| III (hard) | above 2.5 | above 14 |

Washing with detergent drawer

Check with your local water supplier if you do not know the water hardness level in your area.

Programme start – programme end

Starting a programme

The programme can be started as soon as the *Start/Stop* sensor control is flashing on and off.

- Touch the *Start/Stop* sensor control.

The door will lock (🔒 symbol) and the wash programme will start.

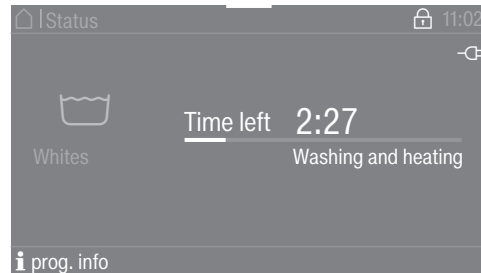

Tip: You can use the pull-down menu to display the selected temperature, spin speed and any selected Extras.

If a delay start period (⌚ Timer) has been selected, this will appear in the display at the bottom left.

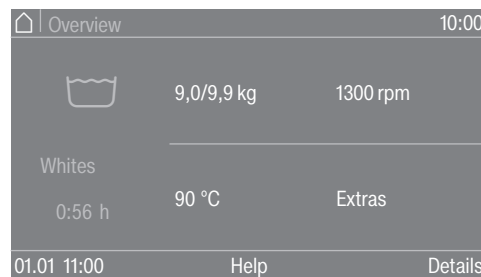

If you select the **i** prog. info selection area, all programme-related information will be displayed.



Once the delay start period has elapsed (if applied), the programme running time will appear in the display; otherwise, the running time will appear straight away. The programme sequence is also shown in the display.

Depending on the setting selected in the supervisor level or in the programme, the machine will switch to the anti-crease action cycle at the end of the programme. The door remains locked. The door can be unlocked at any time by touching the *Start/Stop* sensor control.

Unloading the drum

- Pull open the door.
- Remove the laundry.

Programme start – programme end

Items left in the drum could discolour other items in the next wash or become discoloured themselves.
Remove all items from the drum.

- Check the door seal for any foreign objects.

Tip: Leave the door slightly open to allow the drum to dry.

- Switch the washing machine off with the ⏻ control.

- If applicable, remove the used capsule from the detergent drawer.

Tip: Leave the detergent drawer slightly open to allow it to dry.



The timer can be used to select a programme start date, programme start time or programme end time. This mode is also referred to as delay start.

Setting the timer

- Touch the  timer sensor control.
- Select the Finish at, Start in or Start at option.
- Set the hours and the minutes and confirm with the *OK* sensor control.



Changing the timer

The selected delay start time period can be changed before the programme start.

- Touch the ,  or  sensor control.
- If required, change the specified time and confirm with the *OK* sensor control.

Deleting the timer

The selected delay start period can be cancelled before the programme starts.

- Touch the ,  or  sensor control.

The selected delay start period will appear in the display.

- Touch the Delete sensor control.
- Confirm with the *OK* sensor control.

The selected delay start period is deleted.

Starting the timer

- Touch the *Start/Stop* sensor control.

The door will lock and the time until the programme starts will appear in the display.

After the programme has started, the selected delay start period can only be changed or cancelled by interrupting the programme.

The programme can be started immediately at any time.

- Touch the Start immediately sensor control.

Power failure during the wash cycle

- Switch the machine off.
- Switch off at the on-site mains electricity switch.
- Close the on-site supply stopcocks for water or steam.

To remove the laundry, first the drain valve must be opened manually and then the drum door manually unlocked.

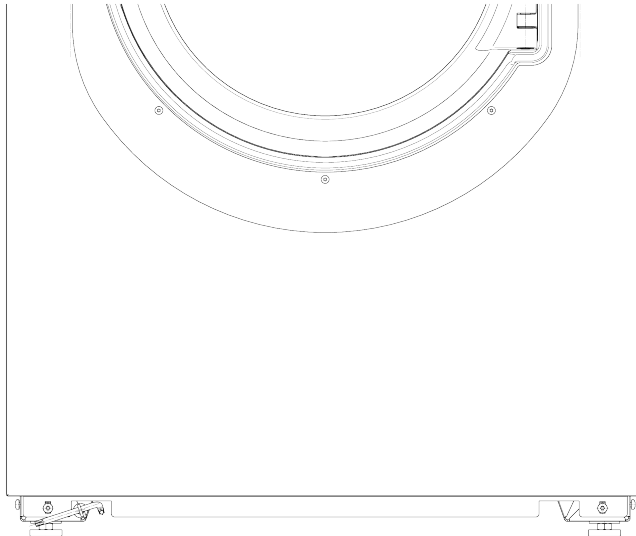

- Guide the T 40 Torx wrench for the emergency door release through the eye on the front of the machine.
- Open the drain valve by pulling the eye using the Torx wrench.
- Keep pulling the eye until the suds have drained away completely. The suds will drain away.

The emergency drain closes automatically when the Torx wrench is removed from the eye.

- Push the eye back in as far as it will go.

The drum door cannot be opened.

Opening the door in an emergency in the event of a power failure

⚠ Warning! Danger from rotating drum and danger of scalding. Before inserting the Torx wrench, make sure that the machine is disconnected from the electricity supply, the drum has stopped and there is no water in the machine.

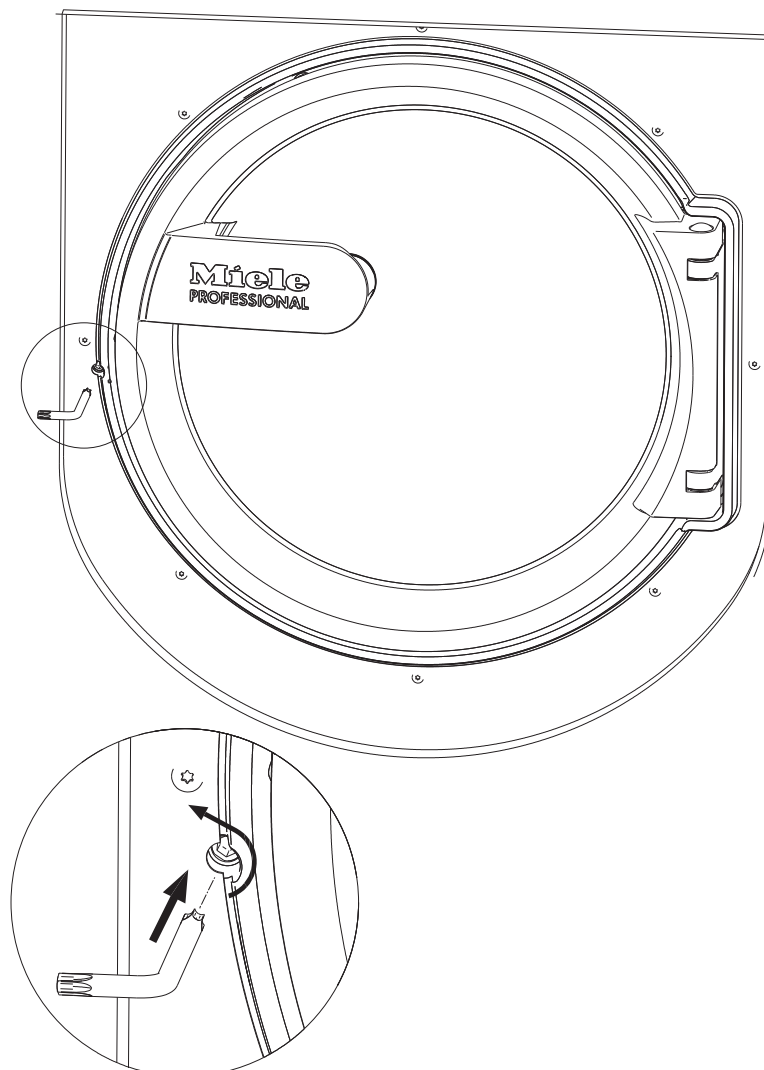

- Using a T 40 Torx wrench, turn the release element with the inner hexagon two whole revolutions **anti-clockwise (left)**.

Tip: Pushing on the door at the same time makes it easier to turn the emergency release element.

The release element is located opposite the door catch at the same height as the handle (see illustration).

The emergency release must not be turned to the right.
Danger of damage to the door lock.

The turn resistance will noticeably reduce. When the emergency release element moves freely, the door is unlocked.

Tip: It is not necessary to screw the emergency release element back in.

The door can now be opened.

Customer Service Department

In the event of a malfunction, contact the Miele Customer Service Department.

When contacting the Customer Service Department, please quote the model, serial number (SN) and material number (mat. no.) of your machine. This information can be found on the data plate. The data plate is visible in the door ring when the drum door is open, or on the back of the machine at the top:

| | | | |
|-----------------|-------------------|-----------------|--|
| Model | | | |
| SN: | / 0 0 0 0 0 0 0 0 | | |
| Art.-Nr. | | Mat -Nr. | |
| IBN | | | |

Symbol icon

Please also pass on the fault message appearing in the machine display to the Customer Service Department.

Use only original Miele spare parts. The Miele Customer Service Department will also require the model, serial number (SN) and material number (mat. no.) when ordering.

Problem solving guide

Problem solving guide

The majority of faults and problems that arise during day-to-day use can be remedied without external assistance. You can save time and money in many cases, as you do not need to call the Miele Customer Service Department.

The following tables are designed to help you to find the cause of a malfunction or a fault and to resolve it. You should, however, note the following:

 Repair work to electrical appliances should only be carried out by an authorised technician. Repairs by unqualified persons can cause considerable danger to users.

The wash programme does not start



| Problem | Cause and remedy |
|---|---|
| The display remains dark, and the <i>Start/Stop</i> sensor control does not light up or flash. | There is no power to the washing machine. <ul style="list-style-type: none">■ Check whether the washing machine is switched on.■ Check whether the washing machine is connected to the power supply.■ Check whether the fuse has tripped. |
| | The washing machine has switched off automatically to save energy. <ul style="list-style-type: none">■ Switch the washing machine back on with the  button. |
| A fault message appears in the display | A programme cannot be started while there is a fault message in the display. <ul style="list-style-type: none">■ Note the information in the display. |
| The display is blank and the <i>Start</i> button indicator is flashing slowly. | The display has switched off automatically to save energy (Standby mode). <ul style="list-style-type: none">■ Press any control. Standby is ended. |

Insufficient wash results

| Problem | Cause and remedy |
|---|---|
| Liquid detergent does not give the required result. | <p>Liquid detergents usually contain no bleaching agents. They do not remove fruit, coffee or tea stains.</p> <ul style="list-style-type: none"> ■ Use a general purpose powder detergent containing a bleaching agent. ■ Pour stain remover powder into drawer  in the dispenser compartment and liquid detergent into a dispenser ball. ■ Never put stain remover powder and liquid detergent together in the detergent drawer. |
| Grey, greasy particles cling to washed laundry. | <p>Insufficient amounts of detergent were used. The laundry was heavily soiled with grease (oils, ointments).</p> <ul style="list-style-type: none"> ■ Use more detergent or use liquid detergent with this type of soiled laundry. ■ Before washing the next load, run a 60 °C programme with liquid detergent but without a load. |
| White residues which look like powder detergent are seen on dark textiles after washing. | <p>The detergent contained compounds (zeolites) to aid water softening which are not soluble in water. These have ended up on the laundry.</p> <ul style="list-style-type: none"> ■ Try to brush off the residues with a soft brush once the laundry is dry. ■ In future, wash dark textiles using a detergent which contains no zeolites. Liquid detergents usually contain no zeolites. |
| Textiles with particularly greasy soiling are not properly clean. | <ul style="list-style-type: none"> ■ Select a programme with pre-wash. Use liquid detergent for the pre-wash. ■ Continue to use universal powder detergent for the main wash. |
| | <p>The use of heavy-duty detergent is recommended in the main wash for very heavily soiled workwear. Please seek advice from the detergent manufacturer.</p> |

Problem solving guide

General problems with the washing machine

| Problem | Cause and remedy |
|---|--|
| The washing machine vibrates during the spin cycle. | The machine feet are not level and not secured. <ul style="list-style-type: none"> ■ Level the washing machine and secure the feet. |
| Large amounts of detergent residue remain in the detergent drawer. | The water flow pressure is too low. <ul style="list-style-type: none"> ■ Clean the water inlet filters. |
| | When powder detergent is used in conjunction with water softeners it tends to become sticky. <ul style="list-style-type: none"> ■ Clean the detergent drawer and in future, add detergent first and then the water softener into the compartment. |
| Fabric conditioner is not completely dispensed or too much water remains in the  compartment. | The siphon is not correctly positioned or is clogged. <ul style="list-style-type: none"> ■ Clean the siphon (see “Cleaning and care – Cleaning the detergent drawer”). |
| The display is in a different language. | A different language has been selected in “Settings  ” “Language  . |
| The door will not open. | There is no power to the machine. <ul style="list-style-type: none"> ■ Check whether the machine is switched on. ■ Check whether the machine is connected to the power supply. ■ Check whether the main fuse or circuit breaker has tripped. |
| | Power failure <ul style="list-style-type: none"> ■ Open the drum door as described in the next section. |
| | There is still water in the drum and the machine is unable to drain. <ul style="list-style-type: none"> ■ Check whether the drainage system is blocked. Clean the drainage system as described in the next section. |
| | For safety reasons the drum door cannot be opened if the suds temperature is higher than 50 °C. |

Possible reasons for increased levels of foaming

| Problem | Cause and remedy |
|---|--|
| Excessive foaming during the wash cycle. | You are using an unsuitable detergent. ■ Only use detergent formulated for use in commercial washing machines. Domestic laundry detergent is not suitable. |
| | You are using too much detergent. ■ Dispense detergent following the instructions on the packaging and in accordance with local water hardness levels. |
| | You are using very soft water. ■ In areas with water hardness level 1, add less detergent in accordance with the detergent manufacturer's instructions. |
| | The items of laundry are only slightly soiled. ■ For lightly soiled laundry, add less detergent in accordance with the detergent manufacturer's instructions. |
| | There are residues in the laundry (e.g. from detergent). ■ Additionally, pre-rinse the laundry without setting a temperature and using detergent. |
| | The load size is too small. ■ Reduce the amount of detergent. |
| | The drum speed is too high during the wash cycle. ■ Reduce the drum speed and wash rhythm. |

Large items stretched

| Problem | Cause and remedy |
|--|---|
| Stretching of large items during spinning | Large items can get stretched during spinning. ■ This can mostly be prevented by reprogramming. Contact the Miele Customer Service Department. |

To continue a programme after an interruption to the power supply

If a running programme is interrupted, e.g. by a power cut, the programme can be continued when power is restored.

- Switch on the washing machine with the **I** button.
- Then press "START".

The programme will then continue with the next programme stage.

Cleaning and care

- Carry out cleaning and maintenance of the machine after use if possible.

Do not use a pressure washer or hose to clean the machine.

- Clean the **machine casing, control panel and plastic parts** with a mild non-abrasive cleaning agent or with a damp cloth only. Wipe dry with a soft cloth.

Scouring agents will scratch the surface.

- Clean stainless steel casing with a proprietary stainless steel cleaner.
- Remove any deposits from the door seal with a damp cloth.

Penetration of cleaning agents into electrical components.

- When disinfecting the surfaces, use a damp cloth only to clean the front and around the door lock. Do not spray any liquids.
- Clean stainless steel casing with a proprietary stainless steel cleaner.
- Remove any deposits from the door seal with a damp cloth.

Tip: Heavy deposits of dust around the fan housing should be removed with a vacuum cleaner. The fan housing is located on the back of the machine.

Build-up of rust

The drum is manufactured from rust-free stainless steel. Water or foreign objects containing ferrous substances (e.g. paper clips, metal buttons or metal swarf) which are placed in the machine with the laundry can cause a build-up of rust in the drum. Clean the drum regularly in this case and if rust occurs, remove it immediately with a proprietary stainless steel care product. Check the door seals for ferrous residues and clean thoroughly as described above. This must be carried out regularly.

Cleaning the detergent drawer, detergent compartments and siphons

- Clean the detergent drawer and the detergent compartments thoroughly with hot water as required to remove detergent residues and incrustations.
- If the machine is not going to be used for a long time, leave the flap of the detergent drawer open.
- Also clean the siphons in the compartments for cleaning agents.

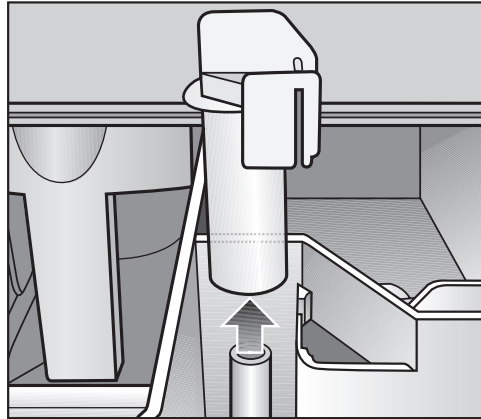

- Remove the siphon. Clean the siphon with hot water and reinsert it.

Cleaning and care

Cleaning the drip channel and siphon

- Open the flap on the detergent drawer to an angle of 45° and lift out the flap of the detergent drawer on the right side.

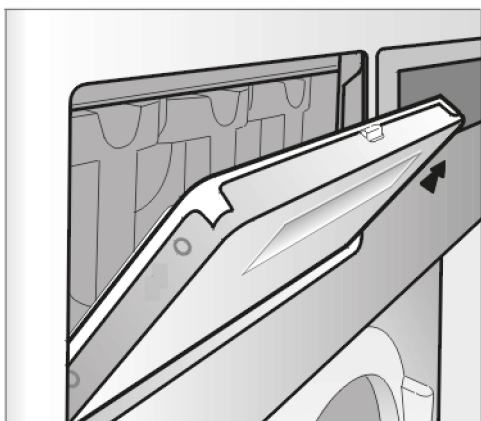

If the drip channel and associated drain connection are blocked, clean them.

- Check the vapour extraction grille on the rear of the machine for contamination from time to time and clean when necessary.

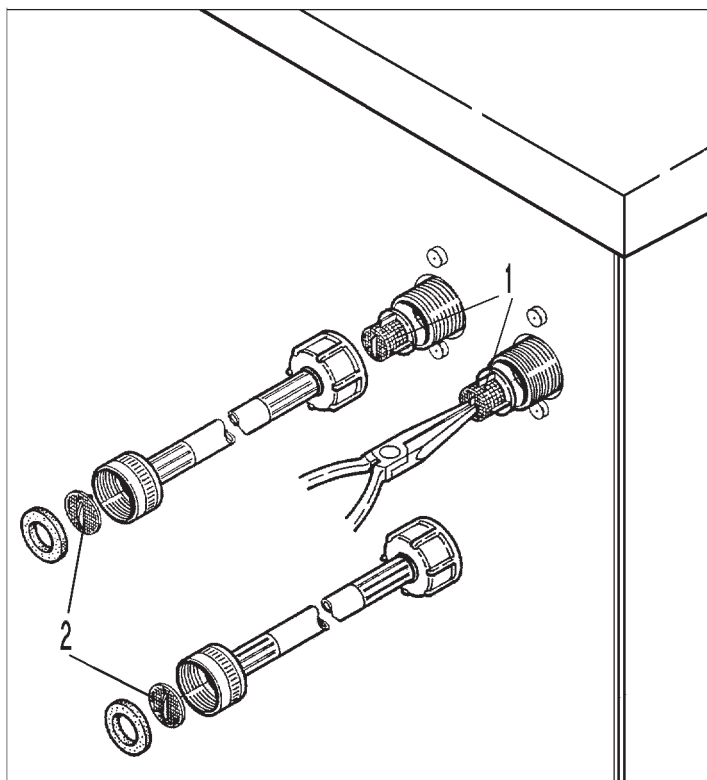

- The filters in the water intake valves (1) and the inlet hoses (2) must be checked for contamination from time to time and cleaned as necessary.

Installing the washing machine

The washing machine must be installed by Miele Customer Service Department or by an authorised dealer. Please observe the information on the installation plan.

This washing machine is only intended for items of laundry that have not been proofed with dangerous or inflammable substances.

- To avoid the risk of frost damage, the machine must not be located in rooms which may be subject to very low temperatures.
- Transport the machine on a pallet truck inside the room.

Machines with feet must not be pushed to move them. This could damage them.

- Remove the packaging carefully with a suitable tool.
- Lift the machine off the pallet using a lifting device.

Securing the machine

- The feet of the washing machine must be secured to the floor using the fixtures and fastenings supplied.

The fastenings included are for bolting the machine to a concrete floor. For other types of flooring, please purchase suitable fastening materials separately.

General operating conditions

This washing machine is intended only for use in a commercial environment and must only be operated indoors.

Ambient temperature in installation room: 0 °C to 40 °C

Relative humidity: non-condensing

Depending on the nature of the installation site, sound emissions and vibrations may occur.

Tip: Have the installation site inspected and seek the advice of a specialist in instances where increased noise may cause a nuisance.

For easy maintenance

For ease of future maintenance and servicing, the minimum dimensions and distance to the wall must be observed to enable access.

- The minimum dimensions and distance to the wall must be observed.

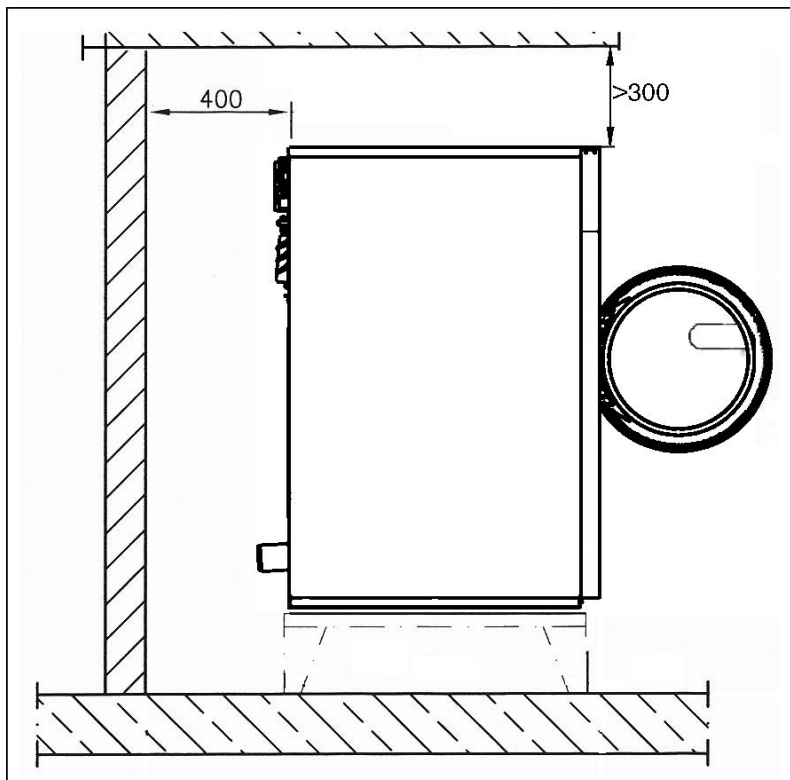

Minimum safety distance to the wall approx. 400 mm to allow for maintenance.

- Adjust the washing machine's adjustable feet until the machine is level.

The washing machine must be completely level to ensure smooth operation.

Installation on a raised plinth

When installed on a raised plinth, the machine must be secured to the plinth. When installed on a concrete base the machine must be secured to the base. The plinth must be secured to the floor.

Transport safety devices

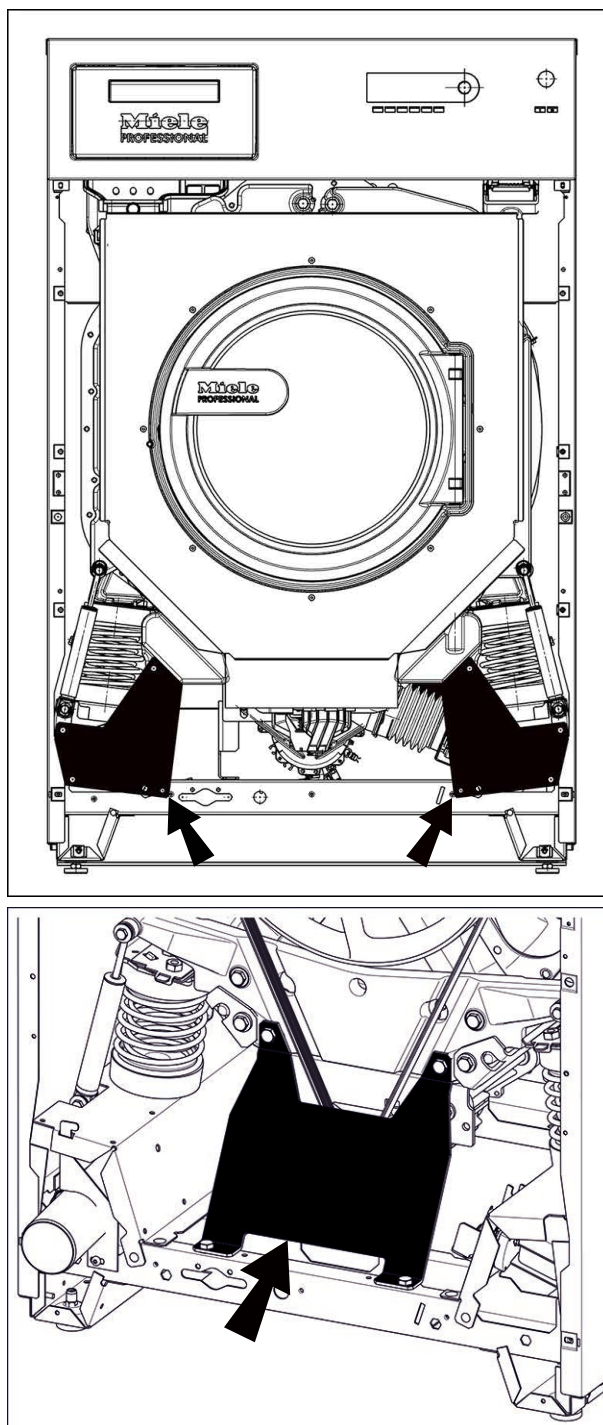

Removing the transport safety devices

The 2 transport safety devices at the front are each secured with 3 hexagon screws. The transport safety devices at the back are each secured with 4 hexagon screws. The transport safety devices must only be removed when the washing machine is in its installation site, before it is commissioned.

- Remove the front and back panel:
- Unscrew the screws at the bottom of the front panel and remove the panel.

Installation

- Unscrew the screws at the bottom of the back panel and remove the panel.
- Loosen the hexagon screws to remove the transport safety devices.

Retain the transport safety devices. They need to be refitted should the machine ever need to be moved again.

Plumbing

Water pressure (flow pressure) of a minimum 1 bar (100 kPa) / maximum 10 bar (1000 kPa) is required to guarantee problem free programme operation.

The machine must be connected to the water supply using the inlet hoses provided.

Hoses must be replaced with hoses tested for a burst pressure of at least 70 bar (7000 kPa) and for water temperatures of a minimum of 90 °C.

This also applies for associated connection fittings. Miele original replacement parts fulfil these requirements.

Tip: The hot water supply must not exceed a maximum temperature of 60 °C.

Dispensing agent connection to the liquid dispensing mixing compartment

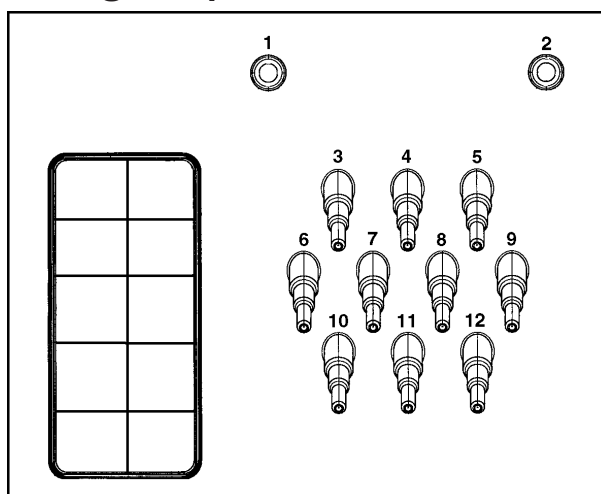

Connections **1** and **2** are provided for viscous agents. These connectors are sealed and need to be drilled open using an 8 mm drill bit.

Connections **1** and **2** can also be used for high pressure dispensing systems with water injection.

The dispensing systems must be fitted with a separate drinking water safety feature in accordance with EN 61770 and EN 1717.

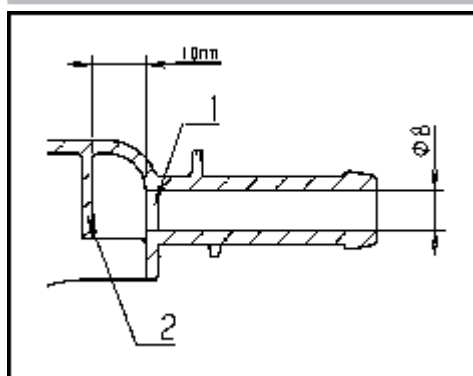

Care must be taken to drill through the first wall (1) only, as there is a deflecting wall (2) 10 mm behind it.

If the drilled out connections are no longer required, they must be resealed.

Connections **3** to **12** are provided for liquid dispensing. These connectors are sealed and must be cut to suit the diameter of the hose with a suitable hacksaw. If opened connectors are no longer required, they must be resealed.

Drainage

Drain valve **DV** on machine side DN 70, on-site socket DN 70. Flow rate temporary 200 l/min.

If the slope for drainage is extremely steep, the piping must be vented to prevent a vacuum from forming in the washing machine's drainage system.

Foam and vapour venting kit **BWS**

If excessive suds form, foam may escape from the vapour extraction. To remove the foam, an optional vapour venting kit (BWS) can be used.

Electrical connection

The electrical connection must only be carried out by a suitably qualified electrician in accordance with local and national regulations such as VDE (Germany), ÖVE (Austria) and SEV (Switzerland).

Tip: Open the machine lid. The connection points are located on the machine frame.

When installing a residual current device (RCD) it must be **Type B**.

The electrical components of this machine comply with DIN EN 60335-1, DIN EN 50571.

See data plate for voltage data.

For hard-wired machines, an all-pole means of deactivation must be provided on site. Switches with a minimum contact gap greater than 3 mm are suitable disconnectors. These include circuit breakers, fuses and contactors (VDE 0660).

The plug connector or isolator switch should be easily accessible at all times.

If the machine is disconnected from the electricity supply, the isolator must be lockable or the point of disconnection must be monitored at all times.

Observe the enclosed wiring diagram.

You can add Extras to the wash programmes.

Not all Extras can be selected with every programme. If an Extra is not listed, it is not permitted for use with the wash programme in question.

Selecting extras

- Touch the Extras sensor control.
- Select one or more of the extras available.
- Confirm with the *OK* sensor control if several extras are available.

Pre-wash

A pre-wash can be added for heavily soiled laundry. Coarse soiling is loosened and removed before the main wash.

Pre-rinse

The laundry is rinsed before the main wash to remove larger quantities of soiling, e.g. dust, sand.

Rinse plus

An extra rinse can be activated to achieve a better wash result.

Soak

For heavily soiled and stained items with protein stains. The soak duration is 10 minutes.

Intensive

For hard-wearing laundry that is very heavily soiled. Cleaning efficiency is increased through more intense mechanical action and the application of more heat energy.

Water plus

The water level in the main wash and the rinses will be increased.

Rinse hold

The laundry is not spun after the final rinse cycle and remains in the rinse water. This helps to prevent creasing if the laundry is not going to be removed from the washing machine immediately after the end of the programme.

Fill stop

Water is drained out of the machine before the last rinse and the programme stops. Laundry after-treatment agents, such as starch, can be added via the dispenser drawer.

The programme is continued with the *Start/Stop* sensor control.

Special features in the programme sequence

Spinning

Final spin speed

When a programme is selected, the maximum spin speed for this wash programme is shown in the display.

You can reduce the final spin speed.

However, you cannot select a final spin speed higher than that shown in the chart.

Rinse-spin

There is a spin cycle after the main wash and between the rinse cycles. A reduction in the final spin speed will also reduce the interim spin speed as appropriate.

Omitting the final spin (Rinse hold)

- Select the *Rinse hold* Extra and then the *Drain* programme. After the last rinse, the water will be pumped away and the Anti-crease phase will switch on.

Anti-crease

At the end of the programme, the drum continues to turn at intervals for up to 30 minutes to help prevent creasing. The washing machine can be opened at any time.

There is no anti-crease phase at the end of some programmes.

Altering the wash programme

Changing a programme

You will need to cancel the current programme before you can select a new one.

Cancelling a programme

You can cancel a wash programme at any time after it has started.

- Touch the *Start/Stop* sensor control.

The following appears in the display:

i Cancel programme?

- Select yes.

The following appears in the display:

Programme cancelled.

The washing machine pumps away the suds.

- Wait until the door unlocks.
- Pull open the door.
- Remove the laundry.

Switching on the washing machine after an interruption to the power supply

If the washing machine is switched off with the  button during a wash programme, the programme will be interrupted.

- Switch the washing machine back on with the  button.
- Note the message in the display.
- Touch the *Start/Stop* sensor control.

The programme continues.

Changing the programme sequence

Adding or removing laundry

You can add or remove laundry items during the first few minutes after the programme has started.

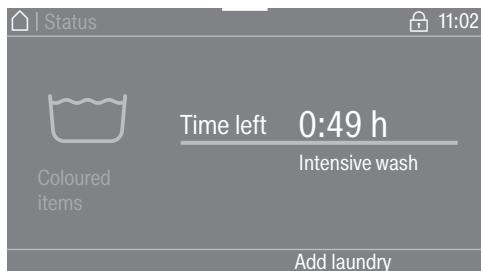

- Touch the *Add laundry* sensor control.

If the message *Add laundry* is not visible in the display then it is no longer possible to add items of laundry.

The wash programme will stop and the door will unlock.

 Risk of chemical burns from detergent.
When adding or removing laundry, your skin may come into contact with detergent, particularly if the detergent is dispensed externally. Take care when placing your hands inside the drum.
If suds have come into contact with the skin, rinse off immediately with plenty of lukewarm water.

- Pull open the door.
- Add laundry or remove individual items.
- Close the door.
- Touch the *Start/Stop* sensor control.

The wash programme will continue.

The door lock will remain activated if the temperature in the drum is above 55 °C. The door lock will not deactivate until the temperature has dropped to below 55 °C.

Opening the Supervisor level

- Switch on the washing machine.

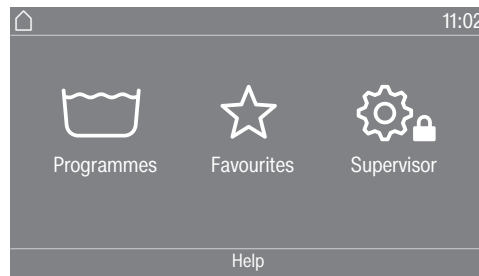

- Touch the Supervisor  sensor control.

The display will change to the Supervisor level menu.

Opening the Supervisor level (self-service)

- Switch on the washing machine and open the door.
- ① Touch the *Start/Stop* sensor control and hold it down whilst carrying out steps ②—③.
- ② Close the washing machine door.
- ③ The *Start/Stop* sensor control will now be flashing quickly; wait until it lights up constantly.
- ④ Release the *Start/Stop* sensor control when the *Start/Stop* sensor control lights up constantly.

Code-based access

The supervisor level is accessed using a code.

The code is **000** (factory default).

After entering the code, you will be in the supervisor level. The individual setting options are described in the following sections.

Changing the code

You can alter the supervisor level access code to protect the washing machine from unauthorised access.

Please inform the Miele Customer Service Department if you have forgotten your new code. The Customer Service Department will have to reset the code.

Make a note of your new code and store it in a safe place.

Closing the Settings menu

- Touch the  symbol.

The display will then go back to the previous menu level.

- Touch the  symbol.

The display will change to the main menu.

Supervisor level

Operation/display

Language

The display can be set to appear in one of several different languages. To select the permanent supervisor language you want, go to the Languages sub-menu.

When a programme is running, you can change the user language using the  sensor control.

Language menu

The display can be set to one of several different user languages. This setting allows you to determine how languages can be selected.

International

6 languages are available. The  sensor control is not active. Note the setting *Set languages*.

Language selection

The  sensor control can be used to select a language. All languages are available (factory default).

You can change the order of the first 4 languages. These slots are allocated to the most commonly used languages.

Standard language

The user language cannot be changed. The user language is the same as the supervisor language. The  sensor control is not active.

Set languages

The languages for the setting *Language* entry *International* can be changed.

6 languages can be selected. All languages are available.

If you wish to add a new language to the language menu:

- First select the language you want to replace.

All available languages are displayed.

- Select and confirm the language to replace the previous language.

The new language appears instead of the old one.

Display brightness

The brightness of the display can be altered. The setting depends on the various lighting conditions in the place of installation.

It can be set to one of 10 different levels.

| | |
|------------------------------|---|
| Clock display | <p>After selecting the clock format, you can set the time of day.</p> <p><u>Clock format</u></p> <ul style="list-style-type: none">- 24 h clock- 12 h clock- No clock <p><u>Set</u></p> <ul style="list-style-type: none">- The time can be set. |
| Date | <p>The date can be set after selecting the date format.</p> <p><u>Date format</u></p> <ul style="list-style-type: none">- DD.MM.YYYY- YYYY.MM.DD- MM.DD.YYYY <p><u>Date</u></p> <ul style="list-style-type: none">- The date can be set. |
| Volume | <p>The volume for various sounds can be changed.</p> <ul style="list-style-type: none">- Finish tone- Keypad tone- Welcome tone <p>It can be set to one of 7 different levels or switched off altogether.</p> <ul style="list-style-type: none">- Fault tone <p>The fault tone can be activated or deactivated.</p> |
| Visibility parameters | <p>Various parameters, such as the temperature, spin speed, Extras, etc., are displayed when a programme is selected. You can decide which parameters should not be displayed. These parameters can then not be edited during programme selection.</p> <p>Factory default: all parameters are visible (marked in orange)</p> |
| Sort Extras | <p>Under the setting Visibility parameters, Sort "Extras" appears in the bottom line. Touch the sensor control to change the sequence of Extras (see "Supervisor level – Arranging programmes").</p> |
| Machine off status | <p>In order to save energy, the washing machine will switch off automatically after the end of the programme or if no further selection is made. You can change this setting.</p> <p>Changing this setting leads to increased energy consumption.</p> <ul style="list-style-type: none">- No switch off- Switch off after 15 minutes (factory default)- Switch off after 20 minutes- Switch off after 30 minutes |
| Delay start | <p>The delay start (timer) display can be switched on or off.</p> <p>Factory default: On</p> |

Supervisor level

Memory

The washing machine will save the settings (temperature, spin speed and some of the options) which have been selected for a wash programme after the programme has started.

When the wash programme is chosen again, the saved settings will appear on the washing machine's display.

Factory default: Off

Temperature unit

You can select the unit for the temperature display.

Factory default: °C/Celsius

Weight unit

You can decide whether load sizes are displayed in "kg" or "lbs". You can also switch this information off altogether.

Factory default: kg

Change code

You can alter the access code to the Supervisor level.

- Enter the current code.
- Enter a new code.

Programme selection

Controls

You can select whether the washing machine is operated as a “wash-salon” (launderette) machine. Shortcuts are the easiest way to operate the machine. Operating staff are unable to change pre-set programmes.

Tip: start by configuring all necessary settings and changes to the washing machine before adjusting any of the options below.

If “WS simple” or “WS advanced” are selected, the supervisor level can no longer be opened from the display after the *Supervisor level* is closed. Please follow the instructions below if you wish to change any other settings.

Standard (factory default).

All functions and programmes can be displayed.

Launderette, basic

Up to 12 programmes are available. Go to Favourite programmes to select which programmes are to be listed.

Laundrette Logo

Up to 12 programmes are available. Go to Favourite programmes to select which programmes are to be listed.

External programme selection

Programmes are selected using a communication module, e.g. an external terminal.

Supervisor level

Programme packages

The selection of programmes can be expanded by activating single programmes from the target group programme packages.

The programmes selected from the programme packages (marked in orange) are displayed under programme selection.

Sort programmes

Programmes can be moved within the programme list and in the Favourites list.

Factory default: Off

Moving programmes

- Touch the selection area for the programme you want to move.
- Press and hold the selection area until the frame changes.
- Drag the programme to the required place.

Prog. colour allocation

You can assign a colour to a Favourite programme. In the list of Favourites, each Favourite programme is given a coloured frame, which can be adjusted.

Factory default: On

Hygiene

If a programme at a temperature below 60 °C has been used, a request to start the Maintenance wash hygiene programme appears in the display.

Factory default: Off

Expert code

A code has to be entered to cancel a disinfection programme. The code can be modified.

The code is: 0 0 0

Make a note of your new code if you ever change it.

Process technology

Anti-crease

The Anti-crease function reduces creasing after the end of the programme. At the end of the programme, the drum continues to turn at intervals for up to 30 minutes.

The washing machine door can be opened at any time.

Factory default: On

Service interval

Service information can appear in the display. You can configure whether a date or the number of operating hours is displayed.

You can select up to 3 messages with their own text.

Your message is displayed at the end of the programme and can be acknowledged with *OK*. The same message appears at the end of the next programme.

Settings

This setting allows you to determine the interval (by hours or date) at which the message appears.

- Factory default: Off

- By time

You can then select a time interval from 1–9999 hours.

- By date

You can then enter a date.

Message text

Enter your message for your planned maintenance work.

Reset display

The message appears until the display is permanently reset. The message then appears again once the next interval is reached.

Supervisor level

Water inlet

Pre-wash

You can select the water type for the pre-wash.

- Cold

Only cold water is used for the pre-wash.

- Hot

Hot water is also added for the pre-wash.

Hot water can only be added if the wash temperature is above 30 °C.

Main wash

You can select the water type for the main wash.

- Cold

Only cold water is used for the main wash.

- Hot

Hot water is also added for the main wash.

Hot water can only be added if the wash temperature is above 30 °C.

Programme running times will be longer if the washing machine is not connected for hot water; this may mean that the “Time left” display is incorrect.

First rinse

You can select the water type for the first rinse in some programmes.

- Cold (factory default)

Only cold water is used for the first rinse.

- Hot

Hot water is also added for the first rinse.

Final rinse

You can select the water type for the last rinse in some programmes.

- Cold (factory default)

Only cold water is used for the final rinse.

- Hot

Hot water is also added for the final rinse (only possible for programmes with a selected temperature of at least 60 °C).

Legal information

Open source licences

You can view information here (see WiFi data protection).

PWM 514 machine data

Electrical connection

| | |
|---------------------|----------------|
| Supply voltage | See data plate |
| Frequency | See data plate |
| Power rating | See data plate |
| Current consumption | See data plate |
| Fuse rating | See data plate |
| Heater rating | See data plate |

Installation dimensions

| | |
|--|---------|
| Casing width (without add-on components) | 795 mm |
| Casing height (without add-on components) | 1347 mm |
| Casing depth (without add-on components) | 895 mm |
| Overall machine width | 799 mm |
| Overall machine height | 1350 mm |
| Overall machine depth | 997 mm |
| Minimum width of transport opening | 900 mm |
| Minimum safety distance between wall and machine front | 1380 mm |
| Diameter of door opening | 415 mm |
| Door opening angle | 180° |

Weight and floor load

| | |
|------------------------------|-----------------------|
| Net weight | see installation plan |
| Max. floor load in operation | see installation plan |

Emission values

| | |
|--|----------------------|
| Emission sound pressure level in workplace in accordance with EN ISO 11204/11203 | < 70 dB(A) re 20 µPa |
| Sound power level, EN ISO 9614-2 | < 80 dB(A) |

Product safety

| | |
|-------------------------|---|
| Product safety standard | EN 60335-1, EN 50571, IEC 60335-1, IEC 60335-2-7, EN 50570, IEC 60335-2-11 |
|-------------------------|---|

WiFi

| | |
|---|------------------|
| Frequency range of the WiFi module | 2.400–2.4835 GHz |
| Maximum transmission power of the WiFi module | < 100 mW |

Technical data

PWM 520 machine data

Electrical connection

| | |
|---------------------|----------------|
| Supply voltage | See data plate |
| Frequency | See data plate |
| Power rating | See data plate |
| Current consumption | See data plate |
| Fuse rating | See data plate |
| Heater rating | See data plate |

Installation dimensions

| | |
|--|---------|
| Casing width (without add-on components) | 920 mm |
| Casing height (without add-on components) | 1447 mm |
| Casing depth (without add-on components) | 857 mm |
| Overall machine width | 924 mm |
| Overall machine height | 1450 mm |
| Overall machine depth | 946 mm |
| Minimum width of transport opening | 1030 mm |
| Minimum safety distance between wall and machine front | 1380 mm |
| Diameter of door opening | 415 mm |
| Door opening angle | 180° |

Weight and floor load

| | |
|------------------------------|-----------------------|
| Net weight | see installation plan |
| Max. floor load in operation | see installation plan |

Emission values

| | |
|--|----------------------|
| Emission sound pressure level in workplace in accordance with EN ISO 11204/11203 | < 70 dB(A) re 20 µPa |
| Sound power level, EN ISO 9614-2 | < 80 dB(A) |

Product safety

| | |
|-------------------------|---|
| Product safety standard | EN 60335-1, EN 50571, IEC 60335-1, IEC 60335-2-7, EN 50570, IEC 60335-2-11 |
|-------------------------|---|

WiFi

| | |
|---|------------------|
| Frequency range of the WiFi module | 2.400–2.4835 GHz |
| Maximum transmission power of the WiFi module | < 100 mW |

EU declaration of conformity

Miele hereby declares that this washing machine complies with Directive 2014/53/EU. The complete text of the EU declaration of conformity is available from one of the following Internet addresses:

- Under “Products”, “Download” at www.miele.de/professional/index.htm
- Or go to <http://www.miele.de/professional/gebrauchsanweisungen-177.htm> and enter the name of the product or the serial number

This **Statement of Compliance** confirms this Miele product fully complies with the **Product Security and Telecommunications Infrastructure (Security Requirements for Relevant Connectable Products) Regulations 2023**.

- 1) Professional Appliance – *Washing machine, commercial PW013, PW014*
- 2) Manufactured by: Miele & Cie KG,
Carl Miele Street 29, 33332 Gutersloh Germany
Imported by and contact point: Miele Company Ltd, Fairacres, Marcham Road,
Abingdon, Oxon, OX14 ITW Great Britain
- 3) The defined support period at the time of first supply is 10 years
- 4) To report vulnerabilities and cybersecurity issues please contact: psirt@miele.com
- 5) Signature 
Name: **Paul Wright**
Company Position: **Head of Technical Management**
Date of signature: **19th March 2024**
Place of signature: **Abingdon, Oxfordshire**

UK declaration of conformity

UKCA mark (UK only)

The Supply of Machinery (Safety) Regulations 2008

Data protection and data security

When you activate the networking function and connect your machine to the Internet, your machine sends the following data to the Miele Cloud:

- Machine serial number
- Machine model and technical features
- Machine status
- Information about the software status of your machine

Initially, this data cannot be assigned to a specific user and is not saved permanently. Data cannot be saved permanently or assigned to a specific user until after you have linked your machine to a user. Data transmission and processing are governed by Miele's strict security standards.

Factory default settings for network configuration

You can reset all of the settings on the communication module or your integrated WiFi module to the factory default settings. The network configuration should be reset whenever a machine is being disposed of or sold, or if a used machine is being put into operation. This is the only way to ensure that all personal data has been removed and the previous owner will no longer be able to access the machine.

Copyright and licences

For the purpose of operating and controlling the communication module, Miele uses proprietary or third-party software that is not covered by open source licensing terms. This software/these software components are protected by copyright. The copyrights held by Miele and third parties must be respected.

Furthermore, this communication module contains software components which are distributed under open source licensing terms. The open source components contained in the machine along with the corresponding copyright notices, copies of the licensing terms valid at the time and any further information can be accessed locally by IP using a web browser (*https://<IP address>/Licenses*). The liability and warranty arrangements for the open source licences displayed in this location only apply in relation to the respective rights holders.

United Kingdom

Miele Co. Ltd., Fairacres, Marcham Road
Abingdon, Oxon, OX14 1TW
Professional Sales, Tel: 0845 365 6608
E-mail: professional@miele.co.uk
Internet: www.miele.co.uk/professional

Australia

Miele Australia Pty. Ltd.
ACN 005 635 398, ABN 96 005 635 398
Level 4, 141 Camberwell Road, Hawthorn East, VIC 3123
Tel: 1300 731 411
Internet: www.miele.com.au/professional
E-mail: professional.sales@miele.com.au

China Mainland

Miele Electrical Appliances Co., Ltd.
1-3 Floor, No. 82 Shi Men Yi Road
Jing' an District, 200040 Shanghai, PRC
Tel: +86 21 6157 3500, Fax: +86 21 6157 3511
E-mail: info@miele.cn, Internet: www.miele.cn

Hong Kong, China

Miele (Hong Kong) Ltd.
41/F - 4101, Manhattan Place
23 Wang Tai Road, Kowloon Bay, Hong Kong
Tel: (852) 2610 1025, Fax: (852) 3579 1404
Email: customerservices@miele.com.hk
Website: www.miele.hk

India

Miele India Pvt. Ltd.
1st Floor, Copia Corporate Suites,
Commercial Plot 9, Mathura Road, Jasola,
New Delhi - 110025
E-mail: customercare@miele.in, Website: www.miele.in

Ireland

Miele Ireland Ltd.
2024 Bianconi Ave., Citywest Business Campus,
Dublin 24
Tel: (01) 461 07 10, Fax: (01) 461 07 97
E-Mail: info@miele.ie, Internet: www.miele.ie

Malaysia

Miele Sdn Bhd
Suite 12-2, Level 12
Menara Sapura Kencana Petroleum
Solaris Dutamas No. 1, Jalan Dutamas 1
50480 Kuala Lumpur, Malaysia
Phone: +603-6209-0288
Fax: +603-6205-3768

New Zealand

Miele New Zealand Limited
IRD 98 463 631
8 College Hill
Freemans Bay, Auckland 1011, NZ
Tel: 0800 464 353
Internet: www.miele.com.au/professional
E-mail: professional.sales@miele.com.au

Singapore

Miele Pte. Ltd.
29 Media Circle, #11-04 ALICE@Mediapolis
Singapore 138565
Tel: +65 6735 1191, Fax: +65 6735 1161
E-Mail: info@miele.com.sg
Internet: www.miele.sg

South Africa

Miele (Pty) Ltd
63 Peter Place, Bryanston 2194
P.O. Box 69434, Bryanston 2021
Tel: (011) 875 9000, Fax: (011) 875 9035
E-mail: info@miele.co.za
Internet: www.miele.co.za

United Arab Emirates

Miele Appliances Ltd.
Showroom 1, Eiffel 1 Building
Sheikh Zayed Road, Umm Al Sheif
P.O. Box 114782 - Dubai
Tel. +971 4 3044 999, Fax. +971 4 3418 852
800-MIELE (64353)
E-Mail: info@miele.ae
Website: www.miele.ae



Manufacturer: Miele & Cie. KG, Carl-Miele-Straße 29, 33332 Gütersloh, Germany