



Operating instructions Microwave oven





To avoid the risk of accidents or damage to the appliance it is **essential** to read these instructions before it is installed and used for the first time.

Contents

| | |
|---|-----------|
| Warning and Safety instructions | 5 |
| Before using for the first time | 14 |
| Installation | 15 |
| Installation dimensions | 15 |
| Electrical connection | 20 |
| Caring for the environment | 21 |
| Guide to the appliance | 22 |
| Accessories supplied | 23 |
| Control panel | 24 |
| Control elements | 25 |
| On/Off button  | 25 |
| Display | 25 |
| Sensor controls..... | 25 |
| Sensor controls above the display..... | 25 |
| Sensor controls under the display | 26 |
| Display symbols..... | 27 |
| Using the appliance | 28 |
| Selecting a menu option and changing a value or setting..... | 28 |
| Selecting an operating mode or function..... | 28 |
| Cancelling a cooking programme..... | 28 |
| Description of function | 29 |
| Modes of operation | 30 |
| Functions | 30 |
| Microwave Solo mode | 30 |
| Grilling | 30 |
| Combination mode (Microwave + Grill)..... | 30 |
| Automatic programmes | 30 |
| Suitable containers for microwave ovens | 31 |
| Material and shape..... | 31 |
| Testing containers | 33 |
| A heat-retaining cover..... | 34 |
| Before using for the first time | 35 |
| Altering the time of day | 35 |
| Settings | 36 |
| Settings overview..... | 36 |
| Changing settings..... | 37 |
| Language  | 37 |
| Time..... | 37 |
| Display..... | 37 |
| Clock format | 37 |
| Set..... | 37 |

| | |
|---|-----------|
| Volume | 37 |
| Buzzer tones | 38 |
| Keypad tone | 38 |
| Display brightness | 38 |
| Units | 38 |
| Weight | 38 |
| Keeping warm | 38 |
| Quick MW | 38 |
| Popcorn | 38 |
| Query food | 38 |
| Safety | 38 |
| System lock  | 38 |
| Sensor lock | 39 |
| Software version | 39 |
| Showroom programme | 39 |
| Demo mode | 39 |
| Factory default | 39 |
| Operation | 40 |
| Opening the door | 40 |
| Placing the dish in the oven | 40 |
| Turntable | 40 |
| Closing the door | 40 |
| Starting a programme | 40 |
| Food in oven? | 41 |
| Interrupting or restarting a programme | 41 |
| Altering settings | 41 |
| Cancelling a programme | 41 |
| At the end of a programme | 41 |
| Keeping warm | 41 |
| Programming cooking durations | 42 |
| Selecting Quick microwave | 42 |
| Changing the time and power level | 42 |
| System lock | 43 |
| Using the minute minder | 43 |
| Changing the minute minder duration | 44 |
| Deleting the minute minder duration | 44 |
| Using the minute minder plus a cooking programme | 44 |
| Operation – grilling | 45 |
| Grilling without the microwave function | 45 |
| Changing the grilling duration | 45 |
| Combining grill and microwave | 46 |
| Changing the duration | 46 |

Contents

| | |
|---|-----------|
| Gourmet plate | 48 |
| Tips for use..... | 48 |
| Searing/browning food..... | 48 |
| Examples of use:..... | 49 |
| Recipes..... | 49 |
| Operation – automatic programmes | 52 |
| Using automatic programmes..... | 52 |
| Cook  | 52 |
| Defrost..... | 53 |
| Reheat..... | 53 |
| Popcorn  | 53 |
| Recipes for automatic programmes | 54 |
| Reheat | 62 |
| Cooking | 64 |
| Defrost | 66 |
| Examples of use | 67 |
| Note for test institutes | 68 |
| Cleaning and care | 69 |
| Accessories supplied..... | 71 |
| Problem solving guide | 72 |
| Service | 74 |
| Contact in the event of a fault..... | 74 |
| Warranty..... | 74 |

Warning and Safety instructions

This microwave oven complies with current safety requirements. Inappropriate use can, however, lead to personal injury and material damage.

Read the operating instructions carefully before using the appliance. They contain important information on safety, installation, use and maintenance. This prevents both personal injury and damage to the appliance.

In accordance with standard IEC/EN 60335-1, Miele expressly and strongly advises that you read and follow the instructions in the chapter on installing the appliance as well as the safety instructions and warnings.

Miele cannot be held liable for injury or damage caused by non-compliance with these instructions.

Keep these instructions in a safe place and pass them on to any future owner.

Correct application

- ▶ This microwave oven is intended for use in the home and in similar environments, for example
 - in shops, offices and similar work settings
 - by the guests in hotels
 - in motels, bed & breakfasts and other typical home settings.This appliance is not intended for outdoor use.
- ▶ Do not use the appliance at altitudes of above 2000 m.
- ▶ The microwave oven is intended for domestic use only to cook, defrost and to reheat food. Any other use is not permitted.
- ▶ Do not use the microwave oven to store or dry items which could ignite easily. If such items were dried in the microwave oven, the moisture in the item would evaporate causing it to dry out and even self-ignite. Never use the microwave oven to store or dry items which could ignite easily.
- ▶ This microwave oven can only be used by people with reduced physical, sensory or mental capabilities or lack of experience and knowledge if they are supervised whilst using it. They may only use it unsupervised if they have been shown how to use it in a safe way. They must be able to recognise and understand the consequences of incorrect operation.

Warning and Safety instructions

- ▶ The oven compartment is fitted with a special lamp to cope with particular conditions (e.g. temperature, moisture, chemical resistance, abrasion resistance and vibration). This special lamp must only be used for the purpose for which it is intended. It is not suitable for room lighting. Replacement lamps may only be fitted by a Miele authorised technician or by the Miele Customer Service Department.
- ▶ The microwave oven contains 1 light source corresponding to energy efficiency class E.

Safety with children

- ▶ Activate the system lock to ensure that children cannot switch the microwave oven on by mistake.
- ▶ Children under eight years of age must be kept away from the appliance unless they are constantly supervised.
- ▶ Children aged eight and older may only use the microwave oven without supervision if they have been shown how to use it in a safe manner. Children must be able to recognise and understand the potential risks of improper use.
- ▶ Children must not be allowed to clean or maintain the appliance unsupervised.
- ▶ Children should be supervised in the vicinity of the microwave oven. Never allow children to play with the appliance.
- ▶ Danger of suffocation! Whilst playing, children could become entangled in packaging (such as plastic wrapping) or pull it over their head and suffocate. Keep packaging material away from children.
- ▶ Danger of burning. Children's skin is far more sensitive to high temperatures than that of adults. When grilling with or without the microwave function, the oven interior, grill element and door can get hot. Do not let children touch the microwave oven when it is in operation.
- ▶ Danger of injury! The oven door can support a maximum weight of 8 kg. Children could injure themselves on an open door. Do not let children sit on the door, lean against it or swing on it. They could injure themselves.

Technical safety

- ▶ A damaged appliance could be dangerous. Check the appliance for visible signs of damage. Do not use the appliance if it is damaged.
- ▶ If the electrical connection cable is faulty, it must only be replaced by a Miele authorised technician to protect the user from danger.
- ▶ Temporary or permanent operation on an autonomous power supply system or a power supply system that is not synchronised with the mains power supply (e.g. island networks, back-up systems) is possible. A prerequisite for operation is that the power supply system complies with the specifications of EN 50160 or an equivalent standard.

The function and operation of the protective measures provided in the domestic electrical installation and in this Miele product must also be maintained in isolated operation or in operation that is not synchronised with the mains power supply, or these measures must be replaced by equivalent measures in the installation. As described, for example, in the current version of BS OHSAS 18001–2 ISO 45001.

- ▶ Operating a damaged appliance can result in microwave leakage and present a hazard to the user. Do not use the appliance if
 - the appliance door is warped.
 - the door hinges are loose.
 - holes or cracks are visible in the casing, the door or the oven interior walls.
- ▶ Any contact with live connections or tampering with the electrical or mechanical components of the microwave oven will endanger your safety and may lead to appliance malfunctions. Do not open the appliance housing under any circumstances.
- ▶ Before connecting the appliance to the mains supply, ensure that the connection data on the data plate (voltage and frequency) match the mains electricity supply. This data must correspond in order to avoid the risk of damage to the appliance. Compare this before connecting the appliance to the mains. Consult a qualified electrician if in any doubt.
- ▶ Multi-socket adapters and extension leads do not guarantee the required safety of the appliance (fire hazard). Do not use them to connect the appliance to the mains.

Warning and Safety instructions

- ▶ The electrical safety of this microwave oven can only be guaranteed when continuity is complete between it and an effective earthing system. It is essential that this standard safety requirement is met to avoid the risk of damage or electric shock. If in any doubt, please have the electrical installation tested by a qualified electrician.
- ▶ For safety reasons, this appliance may only be used when it has been built in.
- ▶ Unauthorised or incorrect repairs can cause considerable danger to users. Repairs may only be carried out by a Miele authorised technician or by the Miele Customer Service Department.
- ▶ While the microwave oven is under warranty, repairs should only be undertaken by a Miele authorised service technician. Otherwise the warranty is invalidated.
- ▶ The microwave oven must be disconnected from the mains power supply during repairs or cleaning and maintenance. It is only completely isolated from the electricity supply when:
 - the plug has been disconnected from the back of the appliance or the appliance has been switched off at the wall socket and the plug withdrawn.Pull by the plug and not by the mains connection cable to disconnect your appliance from the mains electricity supply.
 - the mains circuit breaker is switched off.
 - the mains screw-out fuse is removed (in countries where this is applicable).
- ▶ Miele can only guarantee the safety of the appliance when genuine original Miele replacement parts are used. Faulty components must only be replaced by genuine Miele original spare parts.
- ▶ If the appliance is installed behind a kitchen furniture door, it may only be used with the furniture door open. Do not close the furniture door while the appliance is in use. Heat and moisture can build up behind the closed furniture door. This can result in damage to the appliance and furniture unit. Leave the furniture front/door open until the appliance has cooled down completely.
- ▶ The appliance must not be used in a non-stationary location (e.g. on a ship).

Correct use

 Risk of burning due to the grill.

When grilling with or without the microwave function, the microwave oven can get hot. You could burn yourself on the oven compartment, the grill element, food, accessories or the appliance door.

Use oven gloves when placing hot food in the appliance or removing it and when working in the hot oven compartment.

▶ Always ensure that food is sufficiently cooked or reheated.

The time required for this depends a number of factors, such as the nature of the food, its initial temperature and the amount to be cooked and recipe variations.

Some foods may contain micro-organisms which are only destroyed by thorough cooking at temperatures over 70 °C for a minimum of 10 minutes. Therefore when cooking or reheating foods, e.g. poultry, it is particularly important that food is fully cooked through. If in any doubt that a sufficiently high temperature has been reached, continue reheating for a little longer.

▶ It is important that the temperature in the food being cooked is evenly distributed and sufficiently high.

This can be achieved by stirring or turning the food, and observing a sufficiently long standing time (see charts), which should be added to the time needed for reheating, defrosting or cooking. During the standing time the temperature is distributed evenly in the food.

▶ Always remember that times for cooking, reheating and defrosting in a microwave oven are usually considerably shorter than with traditional methods of cooking food.

Excessively long cooking times can lead to food drying out and burning, or could even cause it to catch fire. Fire hazard. There is also a danger of fire if breadcrumbs, flowers, herbs, etc., are dried in the microwave oven. Do not dry these items in the microwave oven.

▶ Cushions or pads filled with cherry kernels, wheat grain, lavender or gel, such as those used in aromatherapy can ignite when heated even after they have been removed from the microwave oven. Do not heat these up in the microwave oven. Fire hazard.

▶ The microwave oven is not suitable for cleaning or disinfecting items. Items can get extremely hot and there is a danger of burning when the item is removed from the appliance. Fire hazard.

Warning and Safety instructions

- ▶ The appliance can be damaged if it is used without food being placed in it or if it is incorrectly loaded. Therefore do not use the appliance to preheat crockery or to dry herbs or similar items.
- ▶ Always ensure that food or a suitable microwave browning dish has been placed in the microwave oven and that the turntable is in position before switching on.
- ▶ Pressure can build up when reheating in sealed containers, causing the container to explode. Never cook or reheat food or liquids in sealed containers, jars or bottles.
With baby bottles, the screw top **and** teat must be taken off.
- ▶ Be careful when removing dishes from the appliance. Although heat is not normally produced in the container itself by the microwaves (apart from stoneware), heat transfer from the food to the container may be considerable, making the container itself hot. The dish is only warmed by the heat of the food. Before serving, always check the temperature of the actual food itself after taking it out of the microwave. The temperature of the container is not an indication of the temperature of the food or liquid in it. **This is particularly important when preparing food for babies, children, and the elderly or infirm.** After reheating food, especially food for babies and small children, stir the food or shake the container and check that the temperature does not pose any danger. Double check after it has been left to stand.
- ▶ When heating liquids, milk, sauces etc, using microwave power, the boiling point of the liquid may be reached without the production of typical bubbles. The liquid does not boil evenly throughout. This so-called 'boiling delay' can cause a sudden build-up of bubbles when the container is removed from the oven or shaken, which can lead to the liquid boiling over suddenly and explosively. Danger of burning. The formation of bubbles can be so strong that the pressure forces the oven door open. Danger of injury and damage to the appliance. Stir liquids well before heating. After heating, wait at least 20 seconds before removing the container from the oven. In addition, during heating a glass rod or similar item, if available, can be placed in the container.
- ▶ To avoid fuelling any flames, do not open the appliance door if there is smoke inside the oven compartment. Interrupt the process by switching the microwave oven off using the On/Off button and disconnect the plug from the electricity supply. Do not open the door until the smoke has dispersed.

Warning and Safety instructions

- ▶ Oils and fats can ignite if allowed to overheat. Never leave the microwave oven unattended when cooking with oil or fats. Do not use the appliance for deep-fat frying. Never attempt to put out oil or fat fires with water. Switch the oven off and extinguish the flames by leaving the door closed.
- ▶ Due to the high temperatures radiated, objects left near the microwave oven when it is in use could catch fire. Do not use the appliance to heat up the room.
- ▶ If using alcohol in your recipes, please be aware that high temperatures can cause the alcohol to vaporise. The vapour can catch fire on hot surfaces. Never heat undiluted alcohol in the microwave, as this can easily ignite. Fire hazard.
- ▶ Food which is stored in the oven or left in it to be kept warm can dry out and the moisture released can lead to corrosion damage in the microwave oven. This can also cause damage to the control panel, worktop and surrounding kitchen furniture. Always cover food that is left in the oven to keep warm.
- ▶ Try to avoid the interior walls being splashed with food or liquids containing salt. If it does happen, wipe these away thoroughly to avoid corrosion to stainless steel surfaces inside the cabinet.
- ▶ The oven interior can get hot during use. Danger of burning! Clean the oven interior and accessories as soon as it has cooled down. Waiting too long can make cleaning unnecessarily difficult and in some cases impossible. Stubborn soiling could damage the microwave oven in certain circumstances and could even be dangerous. Fire hazard. Please refer to the relevant instructions in "Cleaning and care".
- ▶ Fire hazard. Plastic containers which are not suitable for use in microwave ovens can be badly damaged and cause damage to the appliance if used. Do not use any containers or cutlery made from or containing metal, aluminium foil, lead crystal glassware, temperature-sensitive plastics, wooden utensils or cutlery, metal clips or plastic or paper covered wire ties. Do not use bowls with milled rims, or plastic pots with the foil lid only partially removed (see "Suitable containers for microwave use").
Using these items could result in damage to the container or present a fire risk.

Warning and Safety instructions

▶ Only those plastic disposable containers which are specified by the manufacturer as suitable for use in a microwave oven may be used.

Do not leave the oven unattended when heating or cooking food in disposable containers made of plastic, paper or other inflammable materials.

▶ Heat-retaining packaging consists of, among other things, a thin layer of aluminium foil. Microwaves are reflected by metal. This reflected energy can, in turn, cause the outer paper covering to become so hot that it ignites.

Do not use heat-retaining packaging, such as bags for grilled chicken for warming food in the microwave oven.

▶ If you cook eggs without their shells using microwave power, the yolks could explode due to the resulting pressure. Prick the yolk several times before cooking to avoid this.

▶ Eggs heated in their shells using microwave power can burst, even after they have been taken out of the oven. Eggs can only be cooked in their shells in a specially designed egg-boiling device.

Do not reheat hard-boiled eggs in the microwave oven.

▶ Food with a thick skin or peel, such as tomatoes, sausage, potatoes and aubergines can burst when heated. Pierce or score the skin of these types of food several times to allow steam to escape.

▶ Dishes with hollow knobs or handles are not suitable for use with microwave power. Moisture which has gathered in the hollow recesses can cause pressure to build up and the item can explode. If the hollow recess is sufficiently ventilated, the item could be used. However, we recommend that you do not use such dishes in the microwave oven.

▶ Do not use a thermometer containing mercury or liquid as these are not suitable for use with very high temperatures and break very easily.

To check food temperature, first interrupt the cooking process. Only use a thermometer specifically approved for food use to measure the temperature of the food.

▶ The steam from a steam cleaning appliance could reach live electrical components and cause a short circuit. Do not use a steam cleaner to clean the appliance.

The following applies for stainless steel surfaces:

- ▶ Adhesives will damage the coating of the stainless steel surface and cause it to lose its dirt-repellent effect. Do not use sticky notes, adhesive tape or other types of adhesive on the stainless steel surface.
- ▶ The surface is susceptible to scratching. Even magnets can cause scratches.

Accessories

- ▶ Only use original Miele accessories. If other parts are used, warranty, performance and product liability claims will be invalidated.
- ▶ Miele will guarantee to supply functional spare parts for a minimum of 10 years and up to 15 years following the discontinuation of your microwave oven.
- ▶ The rack and gourmet plate supplied are designed for use with microwave power and can be used for grilling with or without the microwave function.
They must not, however, be used at the same time as this would damage the gourmet plate. Always place the gourmet plate directly on the turntable.
- ▶ The gourmet plate gets extremely hot when in use. Always use oven gloves when handling it to avoid burns. Place it on a suitable heat-resistant mat or pot rest.
The rack and glass tray get hot during grilling (with and without the microwave function).
Danger of burning.
- ▶ Do not use the gourmet plate together with a commercially available, microwave-safe heat-retaining cover because the cover will get too hot.

Before using for the first time

After transportation, let the unpacked appliance stand for approx. 2 hours at room temperature before using it.

This is to allow time for the temperature to equalise between the temperature in the room and the appliance. This is important for the correct electronic functioning of the appliance.

 Risk of suffocation due to packaging material.

While playing, children may become entangled in packaging material (such as plastic wrapping) or pull it over their head with the risk of suffocation.

Keep packaging material away from children.

- Remove all the packaging materials from the appliance.

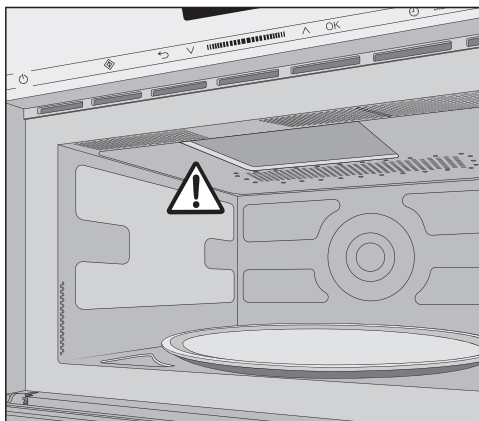

Do not remove the cover from the microwave outlet inside the oven compartment.

- Check the appliance for any damage.

 Health risk caused by a faulty appliance.

Operating a damaged appliance can result in microwave leakage and present a hazard to the user.

Do not use the microwave oven if:

- the appliance door is warped.
- the door hinges are loose.
- holes or cracks are visible in the casing, the door or the oven interior walls.

- Clean the oven compartment and all the accessories with sponge or cloth and hot water.

When installing the microwave oven, ensure that there is adequate ventilation to the front of the appliance.

Do not obstruct the air vents with any objects.

Lifting the microwave oven by the door handle could cause damage to the door.

Use the handle cut-outs on the side of the casing to lift the appliance.

Installation dimensions

Dimensions are given in mm.

Installation

Tall unit installation

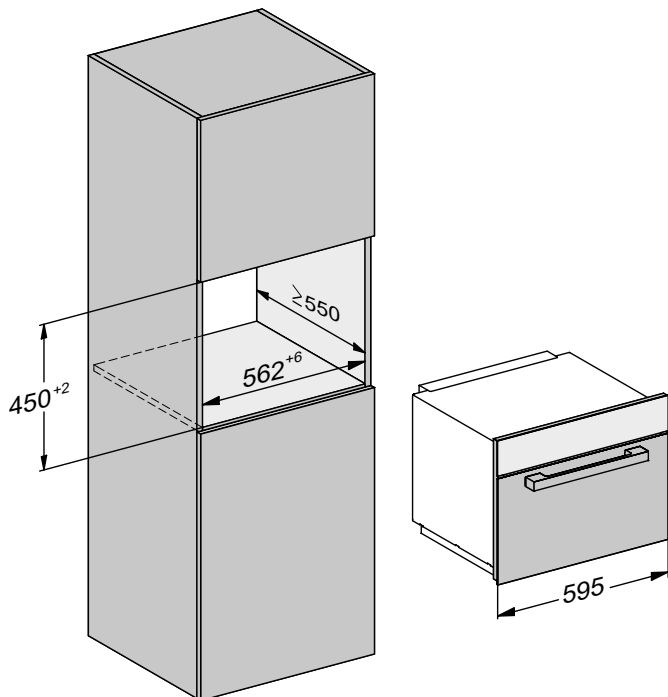

Base unit installation

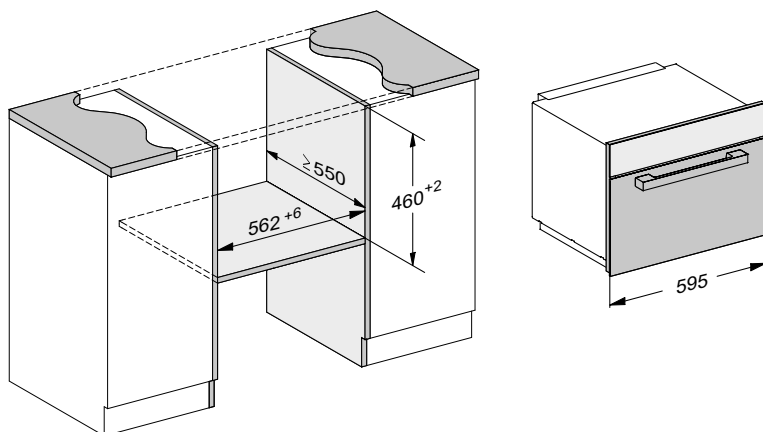

Side view

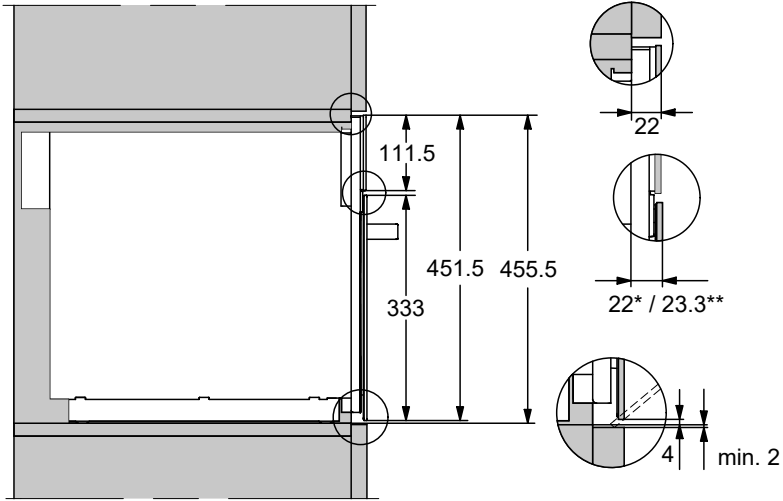

* Glass

** Stainless steel

Base unit connection

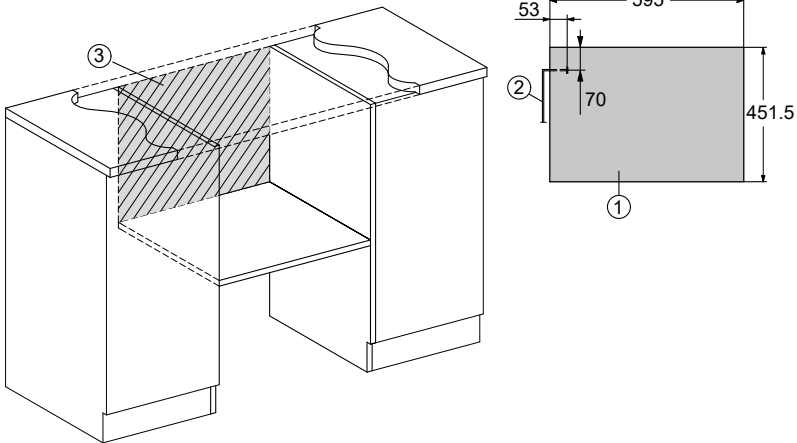

① Front view

② Mains connection cable,
Length = 1600 mm

③ No connections permitted in this area

Installation

Tall unit connection

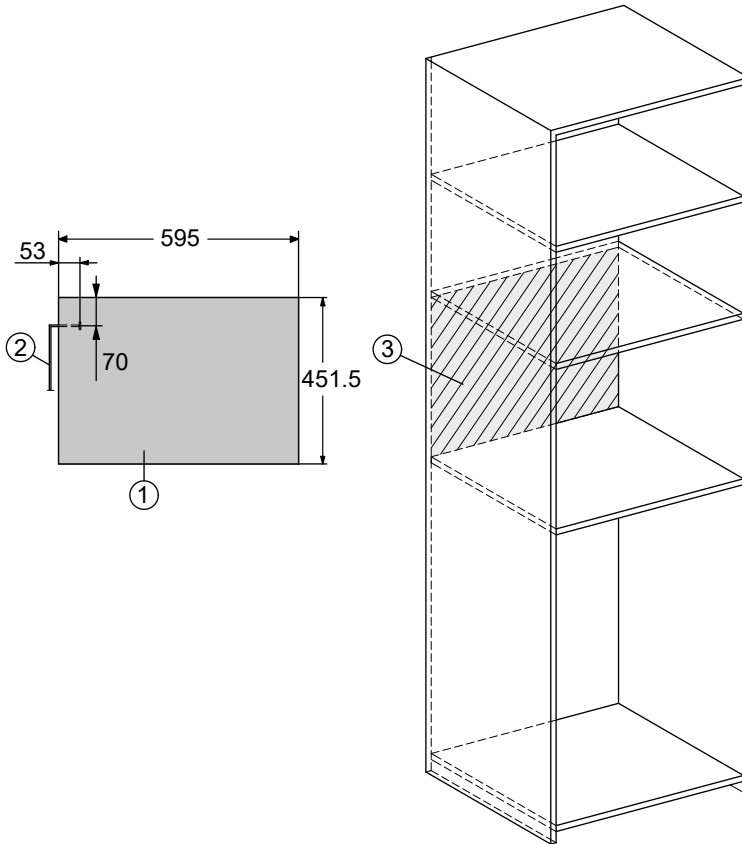

- ① Front view
- ② Mains connection cable,
Length = 1600 mm
- ③ No connections permitted in this area

Carrying out installation

The microwave oven must be built in before it can be used.

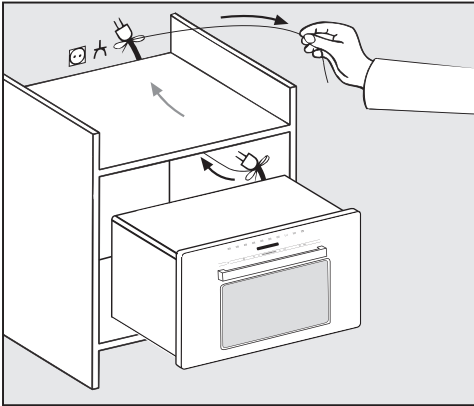

- Slide the microwave oven into the niche. Feed the cable with the plug through the back of the unit.

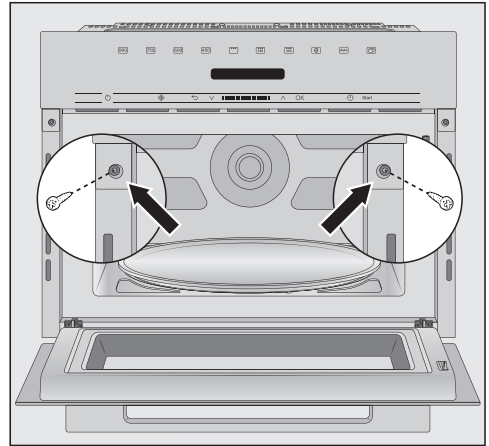

- Position the appliance.
- Open the appliance door and secure the appliance onto the side walls of the unit using the screws provided.

Installation

Electrical connection

 Risk of injury caused by a faulty appliance.

Before connecting the appliance, ensure that it has not been damaged in any way.

Never use a faulty appliance.

The appliance is supplied ready for connection with a cable and plug.

 Fire hazard due to overheating.

Connecting the appliance to a multi-socket plug adapter or to an extension lead can overload the cable.

The appliance must not be used with so-called energy-saving devices.

These reduce the amount of energy supplied to the appliance, causing it to overheat.

For safety reasons, do not use an extension lead or multi-socket plug adapter.

Connect the appliance directly to the power supply using the original cable and do not use any intermediate elements.

The electrical installation must comply with VDE 0100 requirements and local regulations (e.g. BS 7671 in the UK).

If the connection cable is damaged, it must only be replaced with a specific connection cable of the same type (available from the Miele Customer Service Department). For safety reasons, such replacement may only be carried out by a qualified technician or the Miele Customer Service Department.

The necessary connection data can be found on the data plate located on the front of the oven interior or on the back of the appliance.

Compare the specifications on the data plate with those of the electricity supply. Make sure that they match.

If in any doubt, consult a qualified electrician.

Temporary or permanent operation on an autonomous power supply system or a power supply system that is not synchronised with the mains power supply (e.g. island networks, back-up systems) is possible. A prerequisite for operation is that the power supply system complies with the specifications of EN 50160 or an equivalent standard. The function and operation of the protective measures provided in the domestic electrical installation and in this Miele product must also be maintained in isolated operation or in operation that is not synchronised with the mains power supply, or these measures must be replaced by equivalent measures in the installation. As described, for example, in the current version of VDE-AR-E 2510-2.

Disposing of the packaging material

The packaging material is used for handling and protects the appliance from transport damage. The packaging material used is selected from materials which are environmentally friendly for disposal and can generally be recycled.

Recycling the packaging material reduces the use of raw materials. Use material-specific collection points for valuable materials and take advantage of return options. Your Miele dealer will take the packaging material away.

Disposing of your old appliance



Instead, please make use of officially designated collection and disposal points to dispose of and recycle electrical and electronic appliances in your local community, with your dealer or with Miele, free of charge. By law, you are solely responsible for deleting any personal data from the old appliance prior to disposal. You are legally obliged to remove any old batteries which are not securely enclosed by the appliance and to remove any lamps without destroying them, where this is possible. These must be taken to a suitable collection point where they can be handed in free of charge. Please ensure that your old appliance poses no risk to children while being stored for disposal.

Guide to the appliance

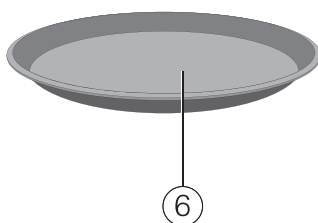
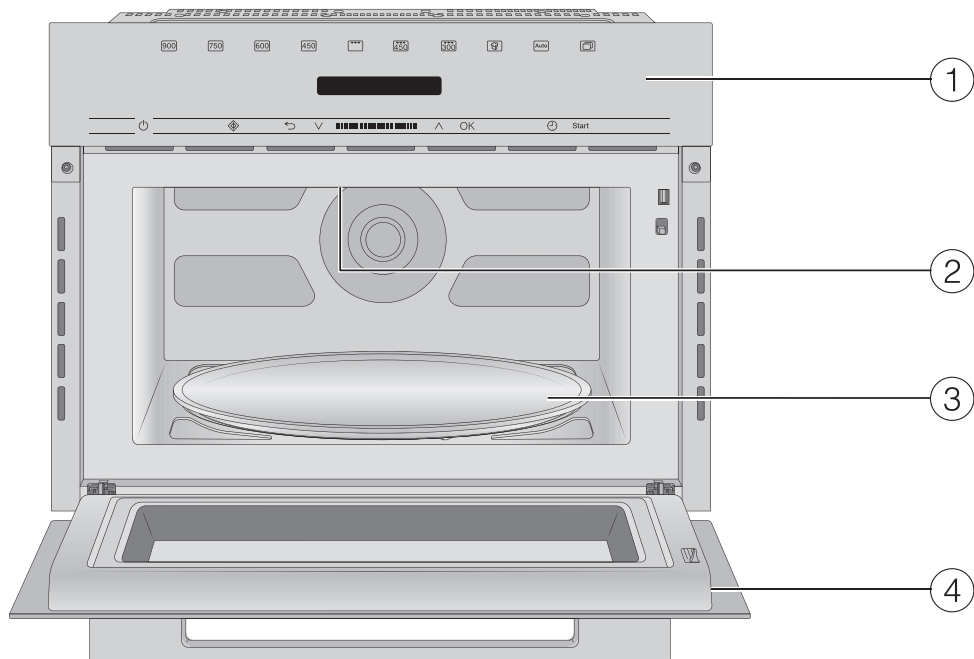

- ① Control panel
- ② Grill
- ③ Turntable
- ④ Door
- ⑤ Grilling rack
- ⑥ Gourmet plate

Grilling rack

The grilling rack can be used for all functions with and without microwave power, **except** for Microwave Solo mode.

To avoid the grilling rack being used inadvertently with Microwave Solo, it should not be stored inside the oven compartment.

Gourmet plate

The gourmet plate is a round, non-stick grilling plate. It can be used to heat snacks or small meals quickly whilst maintaining crispness.

Tip: These products and other accessories can be ordered through the Miele Webshop.

They can also be ordered from Miele (see end of this booklet for contact details) or from your Miele dealer.

Control panel

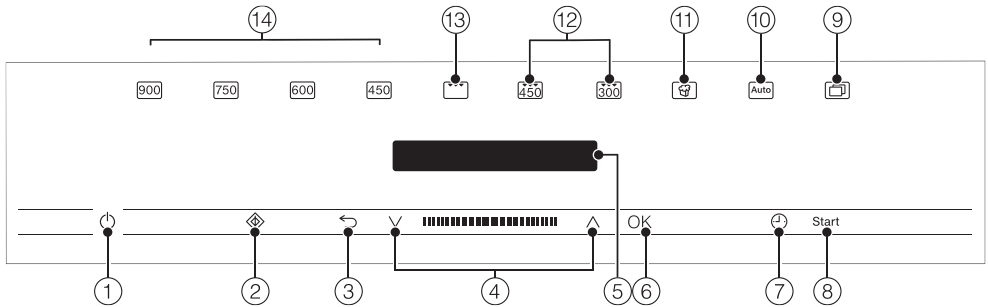

- ① On/Off button ①
- ② Quick microwave button ②
- ③ ↶ button for going back a step and for cancelling a cooking programme
- ④ Navigation area with ^ and v buttons for scrolling through lists and for changing values
- ⑤ Display for showing the time of day and information on operation
- ⑥ OK button for selecting functions and saving settings
- ⑦ ⌚ button for setting a minute minder or a cooking duration
- ⑧ Start button for starting a cooking programme
- ⑨ [Icon] button for further programmes and settings
- ⑩ Auto for various automatic cooking programmes
- ⑪ [Icon] button for popcorn
- ⑫ Combination mode for grill and microwave power
- ⑬ Grill operation
- ⑭ Various power levels of the microwave oven

On/Off button

The On/Off button  is recessed and reacts to touch.

It is used to switch the microwave oven on and off.

Display

The display is used to show the time of day or information about functions, temperatures, cooking durations, automatic programmes and settings.

After switching the microwave oven on using the On/Off button , the main menu will appear with the prompt Select function.

Sensor controls

The sensor controls react to touch. Every touch of a sensor control is confirmed with a keypad tone. This keypad tone can be switched off by selecting the Volume setting and then Keypad tone. Then turn the volume all the way down using the arrow buttons.

If the display is dark, the sensor controls will not react until the microwave oven is switched on.

Sensor controls above the display

Here you will find the operating modes and other functions of the microwave oven.

Operating mode/function

 Power level 900 watts

 Power level 750 watts

 Power level 600 watts

 Power level 450 watts

 Grill

 Combination mode
450 watts + Grill

 Combination mode
300 watts + Grill

 Popcorn

 Automatic programmes

 More
(programmes and Settings )

300 W

150 W

80 W

Grill + 150 W





Defrost

Reheat

Settings 

Control elements

Sensor controls under the display

| Sensor control | Function |
|---|---|
|  | Use this sensor control to start the Quick microwave function. The cooking programme runs at the maximum power level (900 W) and for a cooking duration of 1 minute (see “Quick microwave” section in the “Operation” chapter). Touching this sensor control repeatedly increases the cooking duration in set stages. |
|  | Depending on which menu you are in, this sensor control will take you back a level or back to the main menu. If a cooking programme is in progress, use this sensor control to stop and cancel the programme by pressing it again. |
|  | In the navigation area, use the arrow buttons or the area between them to scroll up or down in the selection lists. The display shows the menu option that you want to select. You can change the values and settings using the arrow buttons or the area between them. |
| <i>OK</i> | If a function appears in the display, you can select it by pressing <i>OK</i> . The selected function can then be changed. Confirm with <i>OK</i> to save changes. If information appears in the display, select <i>OK</i> to confirm the message. |
|  | You can use this sensor control to set a minute minder (e.g. for cooking eggs) at any point, even when a cooking programme is running at the same time. You can also use this sensor control to programme cooking durations. |
| Start | Use this sensor control to start a cooking programme. |

Display symbols

The following symbols may appear in the display:

| Symbol | Meaning |
|--------|---|
| | This symbol indicates that there is additional information and advice about using the appliance. Press the <i>OK</i> sensor control to confirm the information. |
| | This indicates that there are more menu options available, which are not visible because there is not enough space in the display. |
| | Some settings, e.g. display brightness and buzzer volume, are selected using a bar with segments. |
| | A tick next to a setting means that this option is currently selected. |
| | The system lock is switched on (see “Safety” section in the “Settings” chapter). The controls are locked. |
| | Minute minder |

Using the appliance

Selecting a menu option and changing a value or setting

The arrow buttons \wedge and \vee and the area between them **|||■|||** have the following functions:

- Select a menu option from a selection list.
- Change a value (e.g. the weight) or a setting (e.g. the volume of the buzzer).
- Touch the relevant arrow button or swipe to the right or left in the area between the arrow buttons until you reach the menu option or value you want.

Tip: If you press and hold the arrow buttons, the list or values continue scrolling automatically until you release the arrow button.

- Confirm your selection with *OK*.

✓ will appear beside the current setting.

Selecting an operating mode or function

The sensor controls for the operating modes and functions (e.g. settings) are located above the display. Select an operating mode or function using the relevant sensor control on the control panel (see the “Operation” and “Settings” chapters).

- Touch the sensor control for the function or operating mode you want.

The sensor control on the control panel lights up orange.

- Set the values or scroll through the lists until you reach the setting you want.

Cancelling a cooking programme

You can cancel a cooking programme using the function sensor control that lights up orange or using the \hookleftarrow sensor control.

- You can cancel the cooking programme by touching the relevant function sensor control or pressing the \hookleftarrow sensor control twice.
- If you have set a cooking duration, select *Cancel process* and confirm with *OK*.

The main menu will appear.

Description of function

The microwave oven contains a magnetron. This converts electrical energy into electromagnetic waves (microwaves). These microwaves are distributed evenly throughout the oven compartment, and are reflected off the metal appliance walls. This enables the microwaves to reach the food from all sides and heat it up. Microwave distribution is improved with the turntable engaged.

In order for microwaves to reach the food, they must be able to penetrate the cooking container being used.

Microwaves can pass through porcelain, glass, cardboard and plastics, but not metal. Do not, therefore, use containers made of metal, or which contain metal, for example in the form of gold or silver trim. The metal reflects microwaves and this could cause sparking. The microwaves cannot be absorbed.

Microwaves pass through a suitable container and find their way directly into the food. All food contains moisture molecules which, when subjected to microwave energy, start to oscillate at a rate of 2.5 billion times a second. This vibration creates heat. It first starts developing around the outside of the food and then slowly penetrates towards the centre. The more water a food contains, the faster it is reheated or cooked.

As heat is produced directly in the food, this has the following advantages:

- Food can generally be cooked without adding liquid or cooking oil, or with just a little water or oil.
- Cooking, reheating and defrosting in a microwave oven is quicker than using conventional methods.
- Nutrients, such as vitamins and minerals, are generally retained.

– The colour, texture and taste of food are not impaired.

Microwaves stop being produced as soon as the cooking process is interrupted or the appliance door is opened. When the appliance is in operation, the closed, sealed door prevents microwaves escaping from the appliance.

Modes of operation

Food is cooked, reheated or defrosted quickly in a microwave oven.

You can use the microwave oven in the following ways:

- Food can be defrosted, reheated or cooked by entering a power setting and a duration.
- Deep-frozen, ready meals can be defrosted and then reheated or cooked.
- The microwave oven can also be used for other tasks, e.g. for proving yeast dough, melting chocolate and butter, dissolving gelatine, preparing cake glazes and bottling small amounts of fruit and vegetables.

Functions

Microwave Solo mode

Suitable for defrosting, reheating and cooking.

Grilling

Ideal for grilling thin cuts of meat, e.g. steak or sausages.

Combination mode (Microwave + Grill)

Ideal for browning dishes with toppings. The microwave cooks the food, and the grill browns it.

Automatic programmes

You can choose from the following automatic programmes:

You can choose from four different automatic programme categories.

- Cook 
- Defrost
- Reheat
- Popcorn 

The programmes are weight dependent. You can set the weight of food in grams (g), pounds (lb) or pounds/ounces (lb/oz) (see “Changing settings” section in the “Settings” chapter).

Suitable containers for microwave ovens

Microwaves:

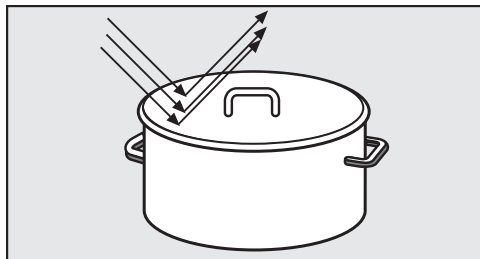

- are reflected by metal.

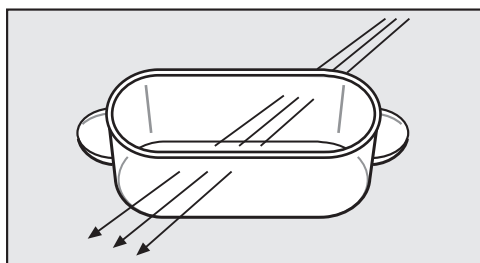

- pass through glass, porcelain, plastic and cardboard.

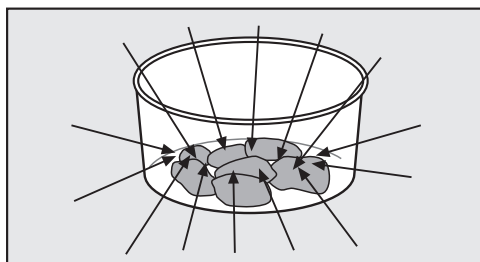

- are absorbed by food.

⚠ Fire hazard due to unsuitable container.

Containers which are not suitable for use in microwave ovens can be badly damaged and cause damage to the appliance if used.

Please observe the information on suitable containers.

Material and shape

The material and shape of the container used affect reheating and cooking durations. Round and oval-shaped shallow containers are particularly suitable. Food heats up more evenly in these containers than in square containers.

⚠ Risk of injury due to hollow handle elements and lid knobs. When using containers with hollow parts, moisture can get inside and pressure can build up, causing the container to crack or shatter.

Do not use containers with hollow handle elements or lid knobs unless the hollow parts are sufficiently ventilated.

Metal

Metal containers, aluminium foil, metal cutlery, and crockery with metallic decoration, such as gold rims or cobalt blue, must not be used in the microwave oven. Metal reflects microwaves and obstructs the cooking process.

Do not use containers where the foil lid has not been completely removed.

- Ready meals in aluminium foil dishes. These can be defrosted and reheated in the microwave oven. Important: Remove the lid and make sure the foil dish is at least 2 cm from the oven walls at all times. However, food is only heated from the top. Transferring the food from the aluminium foil container to a dish suitable for use in a microwave oven will result in more even heat distribution.

Suitable containers for microwave ovens

Do not place aluminium foil dishes on the rack in case the dish sparks or arcs.

- Pieces of aluminium foil

Make sure that the aluminium foil is at least 2 cm from the oven walls at all times. It must not touch the walls.

- Metal meat skewers or clamps
These should only be used if they are very small in comparison to the size of the cut of meat.

Glazes and colours

Some dishes have glazes and colours containing metallic substances. These dishes are unsuitable for microwave ovens.

Glass

Heat-resistant glass or ceramic dishes are ideal for use with microwave power.

Crystal glass is unsuitable as it contains lead which could cause the glass to crack in the microwave. It is therefore not suitable.

Porcelain

Porcelain is a suitable material.

However do not use porcelain with gold or silver edging or items with hollow knobs or handles, as insufficient ventilation may cause pressure.

Stoneware

Decorated stoneware is only suitable if the decoration is beneath an all-over glaze.

Stoneware can get hot.
Wear oven gloves.

Wood

Moisture contained in the wood evaporates during the cooking process. This causes the wood to dry and crack.

Wooden dishes are therefore not suitable.

Plastics

 Damage due to heat-sensitive plastic.

Plastic containers must be heat-resistant to a minimum of 110 °C. Otherwise the plastic may warp and fuse with the food.

Use only plastic containers suitable for use with Microwave Solo.

Plastic boiling bags can be used for cooking and reheating. They should be pierced beforehand. The holes allow the steam to escape. This prevents a build-up of pressure from forming and the bag from bursting.

There are also special bags available for steam cooking which do not need to be pierced. Please follow instructions given on the packet.

 Fire hazard due to unsuitable material.

Metal clips and plastic or paper ties containing wire can ignite.
Avoid using these clips and ties.

Suitable containers for microwave ovens

Single-use containers

 Fire hazard due to unsuitable container.

Single-use containers made of plastic, paper or other inflammable materials can ignite.

Do not leave the appliance unattended when reheating or cooking food in single-use containers made of plastic, paper or other inflammable materials.

To protect the environment, we do not recommend the use of single-use containers.

Testing containers

If in doubt as to whether glass, earthenware or porcelain plates or dishes are suitable for use in a microwave oven, a simple test can be performed:

- Place the empty item you wish to test in the centre of the oven compartment.
- Close the door.
- Press the  button.
- Select the 900 watt power level.
- Use the arrow buttons \wedge and \vee to set a duration of 30 seconds and confirm with *OK*.
- Press start button to start the test.

If you hear a crackling noise accompanied by sparks during the test, switch the appliance off immediately (press the  button and confirm with *OK*). Any containers which cause this reaction is unsuitable for use with microwave power. If in any doubt about the suitability of a container, please contact the manufacturer or supplier of the container.

This test cannot be used to check whether hollow handles are sufficiently ventilated.

Suitable containers for microwave ovens

A heat-retaining cover

- prevents too much steam escaping, especially when cooking foods with longer reheating times.
- speeds up the reheating process.
- prevents food from drying out.
- helps keep the oven compartment clean.

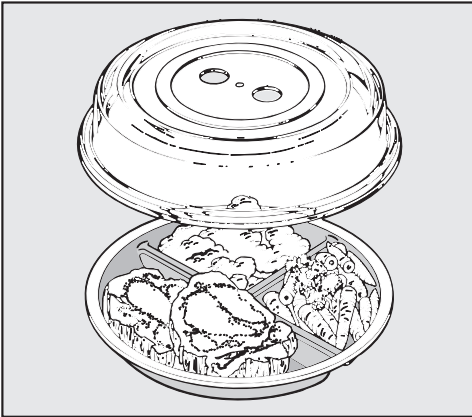

- When using Microwave Solo mode, always cover food with a microwave-safe heat-retaining cover.

Suitable heat-retaining covers are available from retail outlets.

! Damage due to heat-sensitive plastic.

The material of the cover can generally withstand temperatures of up to 110 °C (see manufacturer information). At higher temperatures the plastic can distort and fuse with the food.

The cover can therefore only be used in microwave ovens and only in Microwave Solo mode without the gourmet plate.

! Damage due to covered openings.

If the cover is used with a container with a small diameter, the cover could form a seal around the container and steam may not be able to escape through the openings in the side of the cover. The cover could get too hot and could start to melt. Make sure that the cover does not form a seal.

Do not use a heat-retaining cover if:

- food coated with breadcrumbs is being heated.
- cooking food which needs a crisp finish, e.g. toast.
- the gourmet plate is being used.

! Danger of explosion due to pressure build-up.

Pressure can build up during reheating in sealed containers or bottles, causing them to explode. Sealed glass containers, such as jars of baby food, must be opened before they are heated in the microwave oven. Do not attempt to heat them up unopened. With baby bottles, the screw top and teat must be taken off.

Before using for the first time

The microwave oven must be built in before it can be operated.

The microwave oven is ready to use as soon as it has been connected to the electricity supply.

Welcome screen

The Miele logo appears. You will then be requested to select some basic settings which are needed before the microwave oven can be used for the first time.

- Follow the instructions in the display.

Setting the language

- Select the language you want using the arrow buttons.
- Confirm with *OK*.

If you have selected the wrong language by mistake, proceed as described in the “Language ” section in the “Settings” chapter.

Setting the location

- Select the location you want using the arrow buttons.
- Confirm with *OK*.

Setting the time

- Set the time of day using the arrow buttons.
- Confirm with *OK*.

The display message *Clock display off* is marked with a .

- Confirm with *OK*.

The *Energy consumption - information* appears in the display because energy is saved when the time display is switched off.

- Press *OK*.

Set-up finished appears in the display.

- Confirm with *OK*.

Select function appears in the display.

The time of day display is set to run in the background (default setting). To save energy, the display does not light up.

You can change this appliance setting if you want to see the clock display at all times (see “Changing settings” section in the “Settings” chapter).

When the clock display is visible, all sensor controls react to touch as normal.



When the clock display is not visible, the appliance is switched off. It must be switched on using the *On/Off* button  before it can be used again.

Tip: The time of day can also be displayed in 12-hour format (see “Time of day” section in the “Settings” chapter).

Altering the time of day

- Switch on the appliance using the *On/Off* button .

Select function appears in the display.

- Touch the  sensor control.
- Select the sub-item *Settings*  using the arrow buttons and confirm the selection with *OK*.
- Then select the sub-item *Time* using the arrow buttons and confirm with *OK*.
- Select *Set* using the arrow buttons and confirm with *OK*.





The current time of day is highlighted in white in the display.

- Change the time of day using the arrow buttons and confirm with *OK*.
- Press the  sensor control repeatedly to go back to the first level.

Select function appears in the display.

Settings

Settings overview

| Menu option | Available settings |
|--|---|
| Language  | ...deutsch*, english... Location |
| Time | Display (Clock display off*, Clock display on, Night dimming) Clock format (24 h*, 12 h) Set |
| Volume | Buzzer tones  Keypad tone  |
| Display brightness |  |
| Units | Weight (g*, lb, lb/oz) |
| Keeping warm | On*, Off |
| Quick MW | Power level (...900 W*, 750 W, ...) Duration (01:00*, adjustable) |
| Popcorn | Duration 03:20*, adjustable between 2:30 and 3:50 min |
| Query food | On*, Off |
| Safety | Sensor lock (Off*, On) System lock  (Off*, On) |
| Software version | |
| Showroom programme | Demo mode (Off*, On) |
| Factory default | Do not reset, Reset |





* Factory default

Changing settings

Some of the standard settings for the appliance have an alternative. Please consult the chart for the different options for appliance settings.

The factory settings are marked with a star* on the chart.

To change a setting, proceed as follows:



- Press the  button.
- Then select Settings  using the arrow buttons.
- Confirm your selection with *OK*.
- You can now choose between the options listed in the chart using the arrow buttons.
Confirm the option you want with *OK*.
- Depending on the menu option, you can now enter values or select one of the sub-items using the arrow buttons.
- Touch the  button if you have not changed a setting and wish to switch to another.
- Touch the  button if you do not want to change any more settings.

Modifications to settings are not affected by a power cut.

Language

You can then select the location if the language selected has different variants depending on where it is spoken.

After selecting and confirming your choice, the language you have selected will appear in the display.

Tip: If you have selected the wrong language by mistake, select . Follow the  symbol to get back to the Language  sub-menu.

Time

Display

Select how you want the time of day to be displayed when the microwave oven is switched off:

-  On
The time always appears in the display. All sensor controls react to touch as normal.
- Off
To save energy, the display does not light up. The microwave oven has to be switched on before it can be used.
- Night dimming
To save energy, the time only appears in the display between 5 a.m. and 11 p.m. The display remains dark at all other times. The microwave oven has to be switched on before it can be used.

Clock format

The time of day can be displayed in the 24 or 12-hour format.



Set

Set the hours and the minutes.

If there is a power cut, the current time of day will reappear once power has been restored. The time of day is saved for approx. 150 hours.

Volume

The volume of the buzzers is represented by a bar with segments.

-  Maximum volume
-  The tone is switched off.

Settings

Buzzer tones

If the buzzers are activated, a buzzer will sound at the end of the set time.

Keypad tone

A buzzer will sound when you touch a sensor control if the keypad tone is activated.

Display brightness

The display brightness is represented by a bar with segments.

- ■■■■■■■■
Maximum brightness
- ■■■■■■■
Minimum brightness

Units

Weight

For automatic programmes, you can set the weight of food in grams (g), pounds (lb) or pounds/ounces (lb/oz).

Keeping warm

The Keeping warm function switches on automatically at the end of a cooking programme which has been using at least 450 W, providing the door remains closed and no buttons are pressed. After approx. 2 minutes, the food will be kept warm using 80 W for a maximum period of 15 minutes.

- On
The Keeping warm function is switched on.
- Off
The Keeping warm function is switched off.

Quick MW

Pressing the  button is sufficient to set the appliance operating on maximum power for 1 minute. Power and duration can be modified.

This means a frequently used cooking programme can be saved in this programme space.

- Power level
All available power levels can be selected.
- Duration
At the maximum power level, a maximum cooking duration of 5 minutes can be programmed; for other levels, it is a cooking duration of 10 minutes.

Popcorn

This programme is suitable for making microwave popcorn.

The factory default of 3:20 minutes can be changed.

It can be set between 2:30 and 3:50 minutes.

Query food

Operating the appliance without food can damage the appliance.

If a cooking programme has been started without the door having first been opened, the prompt *Food in oven?* appears in the display.

It is possible that there is no food inside the appliance because the door has not been opened for a long time (approx. 20 minutes).

The programme only starts after confirming with *OK* or after the door has been opened.

Safety

System lock

The system lock prevents the appliance being used unintentionally.

The minute minder can still be set when the system lock is active.

The system lock will remain activated even after a power outage.

- On
The system lock has been activated. Before you can use the microwave oven, you need to switch it on and touch *OK* for at least 6 seconds.
- Off
The system lock is deactivated. You can use the microwave oven as normal.

Sensor lock

The sensor lock prevents the microwave oven being switched off or a cooking programme being altered by accident. Once activated, the sensor lock prevents all sensor controls and fields in the display from working for a few seconds after a programme has been started.

- On
The sensor lock is active. Before you can use a function, touch *OK* for at least 6 seconds. The sensor lock is then deactivated for a short period.
- Off
The sensor lock is deactivated. All sensor controls react to touch as normal.

Software version

The software version is intended for the Miele Customer Service Department. You do not need this information for domestic use.

Showroom programme

This function enables the microwave oven to be demonstrated in showrooms without heating up. Do not activate this setting for domestic use.

Demo mode

If you switch the microwave oven on while demo mode is activated, the message *Demo mode* appears in the display. The appliance does not heat up.

- On
Touch *OK* for at least 4 seconds to activate demo mode.
- Off
Touch *OK* for at least 4 seconds to deactivate demo mode. The microwave oven is fully functional again.

Factory default

One setting can be used to reset all the changes made to the initial state of the microwave oven.

- Do not reset
All changes made still apply.
- Reset
All settings are reverted to the factory default settings.

Operation

Opening the door

If the microwave oven is in use, opening the door will interrupt the cooking process.

 Risk of injury from the open door. The door can support a maximum weight of 8 kg. Children could injure themselves on an open door. Do not let children sit on the door, lean against it or swing on it.

Placing the dish in the oven

Ideally the dish should be placed in the middle of the oven.

Turntable

Do not operate the microwave without the turntable in place.

The turntable starts turning automatically when the appliance is operated.

Do not cook, reheat or defrost food directly on the turntable. Check that the dish is not larger in size than the turntable.

Turn or stir food during cooking, or turn the dish so that it heats up evenly.

Closing the door

Close the door and touch "Start" again to resume an interrupted cooking programme.

Starting a programme

Select a microwave power level by pressing the corresponding sensor control.

- Touch the sensor control for the power level you want.

The sensor control on the control panel lights up orange.

- Use the arrow buttons to set the cooking duration you want and confirm your selection with *OK*.
- Press the start button.

The cooking programme starts.

You can choose between 7 power levels. The higher the power level, the more microwaves reach the food.

When heating up food which cannot be stirred or turned during cooking, as with a plated meal, it is best to use a lower microwave power level.

This ensures the heat is distributed evenly. Heat for long enough to cook the food properly.

The duration required depends on:

- the initial temperature of the food. Food taken straight from the refrigerator takes longer to heat or cook than food which has been kept at room temperature.
- the type and texture of the food. Fresh vegetables contain more water and cook more quickly than stored vegetables.
- the frequency of stirring or turning the food. Frequent stirring or turning heats the food more evenly, and it is therefore ready in a shorter time.
- the amount of food. As a general rule, allow almost double the time for double the quantity.

For a smaller quantity, shorten the duration accordingly.

- the shape and material of the container.

Food in oven?

Operating the appliance without food can damage the appliance.

If the Start button is pressed without the door having first been opened, Food in oven? appears in the display. It is possible that there is no food in the appliance because the door has not been opened for a long time. You cannot start a process until the door is opened.

Interrupting or restarting a programme

At any time, you can . . .

. . . interrupt a programme:

- Open the appliance door.

The duration stops counting down. Close the door appears in the display.

. . . continue a programme:

- Close the door and touch the start button.

The programme will continue.

Altering settings

If you discover after starting a programme that . . .

. . . the **microwave power level** is too high or too low, you can:

- Select a new level.

. . . the **duration** set is too short or too long, you can:

- Change the time using the arrow buttons and continue the programme (touch the start button).

Cancelling a programme

- Touch the ↶ button twice or touch the selected power level.

Cancel process appears in the display.

- Confirm with *OK*.

At the end of a programme

An audible tone will sound when the cooking programme is complete. The oven interior lighting goes out.

The audible tone is repeated several times. Finished appears in the display.

- Press the button for the selected power level to confirm.

Keeping warm

The Keeping warm function switches on automatically at the end of a cooking programme which has been using at least 450 W, providing the door remains closed and no buttons are pressed. After approx. 2 minutes, the food will be kept warm using 80 W for a maximum period of 15 minutes.

Keeping warm appears in the display.

Opening the door or operating one of the buttons cancels the function.

The Keeping warm function cannot be selected as a separate function.

You can deselect this function (see “Settings” chapter).

Operation

Programming cooking durations

Cooking results can be impaired if there is a long delay between the food being placed in the oven and the start of cooking. Fresh food can change colour and even deteriorate. Select as short a time as possible until the cooking programme starts.

You can switch the cooking programme on or off automatically by entering a time for Finish at or Start at.

- Finish at
Specify when you want the cooking programme to end. The microwave oven then switches off automatically at this time.
- Start at
Specify when you want the programme to start. The microwave oven then switches on automatically at this time.
- Place the food in the oven compartment.
- Select the function you want to use.
- Set the cooking duration and confirm with *OK*.
- Press the  button.
- Select Finish at or Start at using the arrow buttons and confirm with *OK*.
- Specify the time that you want the cooking programme to start or end using the arrow buttons and confirm with *OK*.

Start at and the start time appear in the display.

Selecting Quick microwave



Pressing the  button is sufficient to set the appliance operating on maximum power for 1 minute.

- Press the  button.

The appliance runs at maximum power for a cooking duration of 1 minute if the button is not pressed again.

Changing the time and power level

You can change the saved time and power level and save it as a main application.

- Select .
- Select Settings  and confirm with *OK*.
- Select Quick MW and confirm with *OK*.
- Select Power level.

Power level appears in the display and the saved power level appears next to it.

- If you want to change the power level, confirm with *OK*.

The saved power level is marked with .

- Change the power level using the arrow buttons and confirm the selection with *OK*.
- Then use the arrow buttons to select Duration and press *OK*.
- Use the arrow buttons to set the cooking duration you want and confirm with *OK*.

Duration appears in the display and the selected time appears next to it.

- Press  repeatedly to go back to the main level.



The modified power level and the modified time are now saved and are selected when the  button is pressed.

In the event of an interruption to the power supply, any altered programmed durations will be saved and do not need to be reentered.

System lock

The system lock prevents the appliance being used by children, for example.

System lock activation

- Select .
- Select Settings  and confirm with *OK*.
- Select Safety and confirm with *OK*.
- Select System lock  and then *OK*.
- Select On and then *OK*.
- Switch the appliance off to activate the system lock.

The appliance functions are now locked and can only be used when the system lock is deactivated.

Only the minute minder can be used when the system lock is activated (see “Minute minder” chapter).

The system lock will remain activated even after a power outage.

Deactivating the system lock

You can deactivate the system lock temporarily.

- Switch on the appliance using the On/Off button .

System lock  appears in the display.

- Confirm with *OK*.

Press *OK* for 6 seconds  appears in the display.

- Observe the prompt in the display.

The time is shown counting down in the display.

The system lock is then deactivated.

- Enter the cooking programme you want.

All buttons and programmes can be selected freely until the appliance is switched off.

The system lock is only reactivated once the appliance is switched off.

Deactivating the system lock

- Switch on the appliance using the On/Off button .

System lock  appears in the display.

- Confirm with *OK*.

Press *OK* for 6 seconds  appears in the display.

- Observe the prompt in the display.

The time is shown counting down in the display.

The system lock is then deactivated.

- Select .

- Select Settings  and confirm with *OK*.

- Select Safety and confirm with *OK*.

- Select System lock  and then *OK*.

- Select Off and then *OK*.

- Switch off the appliance.

The system lock is now deactivated. The appliance functions are available again.

Using the minute minder

The minute minder can be used to time any activity in the kitchen, e.g. boiling eggs. The time set counts down in one second steps.

The minute minder can also be used at the same time as a cooking programme for which automatic switch-on and switch-off times have been set (e.g. as a reminder to season the food part way through cooking).

Operation

- Touch the  button.

Min. minder appears in the display.

- Use the arrow buttons to set the minute minder time you want and confirm with *OK*.

 lights up in the display and the time counts down.

A buzzer sounds after the set time has elapsed.

 flashes and the time starts counting up. This is to show the time since the minute minder expired.

- Touch the  button to stop the minute minder.

Changing the minute minder duration

- Press the  button.

Change appears in the display. The current minute minder time is stopped.

- Confirm with *OK*.
- Modify the time using the arrow buttons and confirm with *OK*.

The minute minder will continue running.

Deleting the minute minder duration

- Press the  button.



Change appears in the display. The current minute minder time is stopped.

- Select *Delete* using the arrow buttons and confirm with *OK*.

The minute minder is cancelled.

Using the minute minder plus a cooking programme

The minute minder can be used at the same time as a cooking programme and counts down in the background.

- Touch the  button during the cooking programme.
- Select *Min. minder* using the arrow buttons and confirm with *OK*.
- Use the arrow buttons to set the minute minder time you want and confirm with *OK*.
- Touch the  button.

The elapsing cooking duration and the elapsing minute minder are visible next to each other in the display.

The grill has 4 settings: grill solo and 3 combination settings where the grill is used together with a specific microwave power level.

If the total grilling duration required is less than 15 minutes, the grill should be pre-heated for approx. 5 minutes.

Thin, flat cuts of fish and meat should be turned half way through grilling for even results. Larger, chunkier pieces should be turned several times.

Grilling durations depend on the type and thickness of the food and on the user's preference for a rare or well-cooked result.

When grilling directly on the rack, a heat-resistant, microwave-safe container should be placed underneath the rack to catch any fat or juices.

 Risk of damage due to overheating.

The gourmet plate supplied is not suitable for catching fat. It could overheat when empty. This would damage the coating.

Use a heat-resistant, microwave-safe dish instead.

- Place the food in a suitable dish.
- Place the rack and a heat-resistant, microwave-safe dish or the container with the food to be cooked on the turntable.

 Risk of burning due to hot dishes. The rack and container become hot during use. Wear oven gloves.

The container (and glass tray) and grill rack will be easier to clean if washed in soapy water immediately after grilling.

The area on the ceiling around the grill becomes discoloured over time. This is an unavoidable consequence of use, and does not impair the function of the appliance in any way.

Grilling without the microwave function

Ideal for grilling thin cuts of meat, e.g. steak or sausages.

- Press the  button.

The  button on the control panel lights up orange.

Duration and 00:00 min appear in the display.

- Use the arrow buttons to set the cooking duration you want and confirm your selection with *OK*.
- Press the start button.

The cooking programme starts.

An audible tone will sound when the cooking programme is complete.

Changing the grilling duration

The grilling duration can be changed during operation.

- Press an arrow button.

The programme will be interrupted.

- Change the duration using the arrow buttons.
- Continue the programme by pressing the *Start* button.

Operation – grilling

Selecting a start time or end time

The grilling time can proceed at a preset time and ends after a defined duration.

- Press the  button.

The  button on the control panel lights up orange.

Duration and 00:00 min appear in the display.

- Use the arrow buttons to set the cooking duration you want and confirm your selection with *OK*.
- Then press the  button.

Duration and the set duration for the grilling programme are shown in the display.

- Choose between the options *Start at* and *Finish at* using the arrow buttons.

With *Start at*, you have to specify when you want the grilling programme to start. With *Finish at*, you have to specify when you want the grilling programme to end.

Alternatively, you can also select *Min. minder* here if you want to start a minute minder for a separate process in addition to the grilling programme.

- Confirm your selection with *OK*.

Start at or *Finish at* appears in the display, depending on which option you selected. The time is also highlighted.

- Use the arrow buttons to select the start or end time you want and confirm by pressing *OK*.

Start at appears in the display and the  button lights up.

The grill programme starts at the selected time.





An audible tone will sound when the cooking programme is complete.





Combining grill and microwave

This function is very good for baking and browning. The microwave cooks the food, and the grill browns it.

The grill can be combined with 3 different microwave power levels: 150, 300 and 450 watts.

It is not possible to switch between these 3 combination levels during the cooking process without interrupting the programme.

The combinations  and  can be selected directly on the control panel; the combination  can be found under .

- Select the combination you want by pressing the ,  or  button if you want to select .

The corresponding button on the control panel lights up orange.

Duration and 00:00 min appear in the display.

- Use the arrow buttons to set the cooking duration you want and confirm your selection with *OK*.
- Press the start button.

The cooking programme starts. An audible tone will sound when the cooking programme is complete.

Changing the duration

The duration can be changed during operation.

- Press an arrow button.

The programme will be interrupted.

- Change the duration using the arrow buttons.
- Continue the programme by pressing the start button.

Selecting a start time or end time

The cooking duration can proceed at a preset time and ends after a defined duration.

- Select the combination function you want.

The corresponding button on the control panel lights up orange.

Duration and 00:00 min appear in the display.

- Use the arrow buttons to set the cooking duration you want and confirm your selection with *OK*.
- Then press the \oplus button.

Duration and the set duration for the grilling programme are shown in the display.

- Choose between the options *Start at* and *Finish at* using the arrow buttons.

With *Start at*, you have to specify when you want a programme to start.
With *Finish at*, you have to specify when you want a programme to end.

Alternatively, you can also select *Min. minder* here if you want to start a minute minder for a separate process in addition to the cooking programme.

- Confirm your selection with *OK*.

Start at or *Finish at* appears in the display, depending on which option you selected.

The time is also highlighted.

- Use the arrow buttons to select the start or end time you want and confirm by pressing *OK*.

Start at appears in the display and the button for the selected function lights up.

The cooking programme starts at the preset time.

An audible tone will sound when the cooking programme is complete.

Gourmet plate

Tips for use

 Risk of burning due to hot dishes. The gourmet plate gets extremely hot when in use. Always use oven gloves when handling it to avoid burns. Place it on a suitable heat-resistant mat or stand.

Before using for the first time

Before using the gourmet plate for the first time, fill it with 400 ml water and add 3 to 4 tbsp vinegar or lemon juice. Heat for 5 minutes at 450 W + Grill .

The gourmet plate has an easy-to-clean anti-stick coating so that food can be removed easily.

The coating is susceptible to cuts and scratches. Metallic or sharp objects can damage the non-stick coating. Therefore do not cut food up directly on the plate. Use wooden or plastic utensils to mix or turn food.

Searing/browning food

 Fire hazard due to overheating. Oils and fats can ignite if allowed to overheat. Never leave the gourmet plate unattended when cooking with oil or fats.

- Only very little fat or oil is necessary when cooking with this dish. This is because food does not stick to the non-stick coating. This has the added advantage of keeping down the calorie count.

- When using the gourmet plate, make sure that the food is ready to transfer to the gourmet plate as soon as it has heated up.
- Place the gourmet plate directly on the turntable.

Sparking can damage the gourmet plate and the oven compartment. Do not place the gourmet plate on the rack. Make sure there is a gap of approx. 2 cm between the gourmet plate and the interior walls of the microwave oven so that sparking cannot occur.

- Heat the plate at 450 W + Grill  for max. 5 minutes.

 Risk of damage due to overheating. Do not overheat the empty gourmet plate. This would damage the coating. For this reason, do not place the gourmet plate under the rack to catch the fat when grilling.

If using oil, you can either heat up the oil on the gourmet plate, or you can heat the oil separately and then add it to the plate.







Butter, however, should always be added after heating up the gourmet plate. It has a lower burning point than oil and would get too dark or burn if added too soon.

Always dry meat, poultry, fish and vegetables thoroughly before placing them on the gourmet plate.

Eggs can explode. Do not use the gourmet plate to cook eggs or reheat cooked eggs.

Examples of use:

Pre-heat the gourmet plate directly on the turntable for up to max. 5 minutes at 450 W + Grill .

- Fish fingers (frozen), 150 g + 2 tbsp oil , 3 – 4 minutes each side
- Hamburgers, 2 burgers + 2 tbsp oil , 3 – 4 minutes each side
- Croquette potatoes (frozen), 10 – 12 pieces + 2 tbsp oil , 6 – 8 minutes, turning halfway through
- Fillet steak, approx. 200 g , 5 minutes each side (according to taste)
- Pizza (frozen), 300 g, , 7 – 9 minutes
- Pizza (fresh), without pre-heating , 15 minutes approx. (depending on topping)

Recipes

The total time required includes the time required for preparation and cooking. Standing time or time for marinating food is quoted in addition to the total time required.

Croque monsieur (serves 3)

Total time required: 10 – 15 minutes

Ingredients

- 6 slices of white bread
- 30 g soft butter
- 75 g Emmental cheese, grated
- 3 slices of ham

Method

Butter the bread. Add the cheese to three of the bread slices in equal amounts and arrange a slice of ham on top of each. Place the remaining three slices of bread on top of the ham with the buttered side face down. Pre-heat the gourmet plate using 450 W + Grill for approx. 5 minutes, then place the bread on it. Place on the turntable and cook using 450 W + Grill for approx. 3 minutes each side until golden. Other fillings could include drained tuna fish with finely sliced onion rings, or pineapple, cheese and ham.

Gourmet plate

Vegetable medley (serves 3)

Total time required: 25 – 35 minutes

Ingredients

2 onions
2 tbsp oil
100 g oyster mushrooms or button mushrooms, cleaned
150 g sliced carrots
100 g broccoli florets
1 red pepper or 100 g frozen sliced peppers
1 tomato
Salt and pepper
30 g grated Parmesan cheese

Method

Slice the onions into fine rings. Halve, quarter and deseed the pepper, and then cut into strips. Dice the tomato. Place the gourmet plate on the turntable and pre-heat it using 450 W + Grill for approx. 5 minutes. Add oil and onion rings. Place gourmet plate back on the turntable and cook using 450 W + Grill for approx. 2 minutes. Add the mushrooms, carrots, broccoli, sliced pepper, diced tomato and seasoning. Mix well. Cook using 450 Watt + Grill for approx. 6 minutes. Turn out and sprinkle with Parmesan cheese before serving.

Pork fillets (serves 2)

Total time required: 15 – 20 minutes

Ingredients

1 pork tenderloin (approx. 400 g)
4 rashers of streaky bacon
Salt and pepper
10 g butter
200 g sliced button mushrooms
200 ml double cream
2 tbsp brandy

Method

Cut the pork tenderloin into four pieces. Season each piece with salt and pepper, and wrap in a rasher of streaky bacon. Secure with a cocktail stick if necessary. Place the gourmet plate on the turntable and pre-heat it using 450 W + Grill for approx. 5 minutes. Add the butter to the plate, and place the meat on top. Place on the turntable and cook using 450 W + Grill for approx. 3 minutes each side. Transfer the meat to a serving dish, cover and keep warm. Add the mushrooms, cream and brandy to the meat juices and heat on maximum power for approx. 4 minutes. Serve with the meat.

Pork fillet in a Roquefort sauce

Total time required: 10 – 12 minutes

Method

Cut 1 pork tenderloin into four pieces. Place on the pre-heated gourmet plate and cook using 450 W + Grill for approx. 4 minutes. Add 50 ml white wine, 125 ml double cream, 2 tbsp roux (made from 1 tbsp each of flour and melted butter) and 150 g Roquefort cheese. Stir the sauce until smooth, and cook for a further 3 minutes.

Curried chicken (serves 3)

Total time required: 25 – 35 minutes

Ingredients

600 g chicken or turkey breast fillets
2 tbsp oil
2 tbsp white wine
2 tbsp apple juice
1 tbsp lemon juice
Salt and freshly ground black pepper
1 tsp curry powder
1 pinch rosemary, ground
1 pinch ginger, ground
1 pinch cayenne pepper
 $\frac{1}{2}$ tsp Tabasco
20 g butter

Method

Dice the meat into 2 x 2 cm pieces. Combine the rest of the ingredients apart from the butter, and pour over the meat. Mix well, and leave to stand for approx. 30 minutes. Place the gourmet plate on the turntable, Pre-heat it using 450 Watt + Grill for approx. 5 minutes. Add the butter to the pre-heated plate, then add the slightly drained meat. Place the gourmet plate on the turntable and cook using 450 W + Grill for approx. 4 minutes, turn and cook for a further 4 minutes on the same setting. Drain surplus liquid from the meat if necessary so that it browns well.

Fisherman's salmon (serves 2)

Total time required: 5 – 10 minutes

Ingredients

2 salmon fillets (approx. 150 g each)
1 tbsp lemon juice
Salt, white pepper



Method



Drizzle the salmon with the lemon juice, and leave to stand for approx. 10 minutes. Place the gourmet plate on the turntable and pre-heat using 450 W + Grill for approx. 5 minutes. Pat the fish dry with kitchen paper, and place on the gourmet plate, pressing it down slightly. Place on the turntable and cook using 450 W + Grill for approx. $1\frac{1}{2}$ – 2 minutes each side. Serve with rice, hollandaise sauce or melted butter and a fresh green salad.

Operation – automatic programmes

All of the automatic programmes are weight dependent.

You can set the weight of food in grams (g), pounds (lb) or pounds/ounces (lb/oz) (see “Changing settings” section in the “Settings” chapter).

- Cook 
- Defrost
- Reheat
- Popcorn 

The cooking programmes and the popcorn programme can be selected using the  or  sensor controls.

The automatic programmes for the defrosting and reheating categories can be selected using the  sensor control and then the arrow buttons.

Using automatic programmes

- Select the automatic programme you want and confirm with *OK*.
- Enter the weight of the food and confirm with *OK*.
- Choose between the options Start now, Start at and Finish at using the arrow buttons.
- Follow the instructions in the display, for example Turn food or Stir the food.
- After cooking, leave the food to stand at room temperature for the suggested time (standing time) to allow the heat to be distributed evenly through the food.

Cook

 Damage due to heat-sensitive plastic.

The material of a heat-retaining cover can generally withstand temperatures of up to 110 °C (see manufacturer information). At higher temperatures the plastic can distort and fuse with the food.

A heat-retaining cover must only be used with Microwave Solo mode.

On no account may a cover be used if the grill is switched on, i.e. for programmes marked with *.

- Bacon
 - Potatoes
 - Chicken pieces *
 - Chicken in sauce
 - Fish fillet
 - Fish fillet in sauce
 - Frozen chips *
 - Soup
 - Vegetables
 - Frozen bakes *
 - Pizza - thin base *
 - Pizza - thick base *
 - Frozen ready meals
 - Frozen vegetables
 - Fruit compote
 - Bakes *
 - Grilled chicken *
 - Fish pie *
 - Grilled fish *
 - Rotisserie *
 - Meat in sauce
 - Rice
 - Stew
- * grill activated at times

Defrost

There are 13 programmes for defrosting different types of food. The standing time for each of these programmes is approx. 10 minutes.

- Bread
- Cakes
- Chicken legs
- Plated meals
- Fish fillet
- Fruit
- Meat pieces
- Minced meat
- Poultry
- Soup
- Sliced meat
- Vegetables
- Fish

Reheat

There are 8 automatic programmes for reheating different types of food. The standing time for each of these programmes is approx. 2 minutes.

- Bakes
- Chicken in sauce
- Plated meals
- Fish fillet in sauce
- Soup
- Meat in sauce
- Stew
- Vegetables

Popcorn

This automatic programme is suitable for making microwave popcorn.

Microwave popcorn is commercially available in packets of various sizes. This programme is designed for a packet size of approx. 100 g. The duration for this programme can be altered within a certain range to suit different packet sizes (see “Changing settings” section in the “Settings” chapter).

The duration cannot, however, be altered whilst the programme is running.

The programme is not suitable for making popcorn from kernels. Only use this automatic programme for popcorn which is specifically labelled as microwave popcorn.

- Place the packet on the turntable according to the instructions on the packaging.

Make sure that the packet has enough room to expand. If it comes into contact with the wall of the oven interior and gets stuck there, a heat build-up may occur.

Ensure that the packet can inflate unhindered.

- Touch .

The programme will start after a short time. It will start immediately if the start button is touched.

You will soon hear the first kernels popping.

- Stop the programme before the end if the popping noises become infrequent. Follow the instructions on the packaging.

 Risk of burning due to hot packet. The packet is very hot. Take care when removing it.

Recipes for automatic programmes

Below are some recipe suggestions for the automatic programmes from the “Cooking **Auto**” category. These can be adapted to suit your requirements.

If the weight guidelines for the relevant programme are exceeded, the food will not cook sufficiently. It is important to follow the weight guidelines for the programme concerned.

Vegetables

Method

Place the washed and prepared vegetables in a container. Add 3–4 tbsp water, depending on freshness and moisture content, and a little salt or other seasoning. Enter the weight including the water, place the covered cooking container on the turntable and cook. About halfway through the cooking duration, a buzzer will sound to prompt you to turn or stir the food.

When cooking vegetables in a sauce, the weight entered must include the sauce. Do not exceed the maximum weight guidelines.

Carrots in a chervil cream sauce (serves 2)

Total time required: 25–35 minutes

Ingredients

350 g carrots, cleaned
5 g butter
50 ml vegetable stock (instant)
75 ml crème fraîche
1 tbsp white wine
Salt and pepper
1 pinch of sugar
1/2 tsp mustard
1–2 tbsp chervil, fresh, chopped or
1 tbsp chervil, dried and ground
Approx. 1 tbsp cornflour

Method

Cut carrots into batons or slice (approx. 3–4 mm thick). Combine the rest of the ingredients, and pour over the carrots in a container. Cover and cook. Stir when the buzzer sounds.

Setting: **Auto** Vegetables
Weight: 525 g
Shelf level: Turntable

Potatoes

This programme can be used to cook peeled, boiled and bouillon potatoes.

Method

Enter the weight for the potatoes and the cooking liquid.
For peeled potatoes, place the wet potatoes in a cooking container. Season with a little salt, cover and cook.
When cooking potatoes, add approx. 1 tbsp water per potato. If cooking the potatoes in their skins, pierce the skins several times with a fork or skewer before cooking, then cover the container and cook.

Recipes for automatic programmes

Golden curried potatoes (serves 3)

Total time required: 25–35 minutes

Ingredients

500 g peeled potatoes
1 onion, finely diced
10 g butter
1–2 tbsp curry powder
250 ml vegetable stock (instant)
50 ml double cream
125 g peas (frozen)
Salt and pepper

Method

Roughly dice the potatoes (approx. 3 x 3 cm) or use small potatoes. Mix together all the ingredients in a suitably large dish. Cover and cook. Stir when the buzzer sounds and then continue cooking.

Setting:  Potatoes

Weight: 800 g

Shelf level: Turntable

Rice

Use this programme for cooking rice in the microwave oven.

Method

Enter the weight of the dry rice. Add boiling water to the dry rice in the ratio of 1 part rice to 2 parts water. Cover and cook the rice.

Vegetable gratin (serves 4)

Total time required: approx. 40 minutes

Ingredients

400 g cauliflower or broccoli
400 g carrots

For the cheese sauce

20 g margarine
20 g flour
300 ml vegetable stock (instant)
200 ml milk
100 g diced Emmental cheese
50 g Gouda, grated
Salt, pepper, nutmeg
1 tbsp parsley, chopped

Method

Cut the cauliflower or broccoli into small florets, and thinly slice the carrots (approx. 3 mm thick). Place the vegetables in a baking dish (approx. 24 cm in diameter), and mix well. Melt the margarine, stir in the flour and then add the stock and milk whilst continuing to stir. Stir in the Emmental cheese, and simmer until the cheese has melted. Season well with nutmeg, salt and pepper and add the parsley. Pour the sauce over the vegetables, and sprinkle over the grated Gouda cheese. Bake uncovered.

Setting:  Bakes

Weight: 1500 g

Shelf level: Turntable

Recipes for automatic programmes

Potato cheese gratin (serves 4)

Total time required: 45 minutes

Ingredients

For the gratin

600 g potatoes, floury

75 g Gouda, grated

For the topping

250 ml double cream

Salt, black pepper, nutmeg

Butter

For sprinkling

75 g Gouda, grated

For the dish

1 clove of garlic

Accessories

Microwave-safe ovenproof dish,

Ø 26 cm

Method

Rub the ovenproof dish with the garlic clove.

To make the cream topping, mix together the cream, salt, pepper and nutmeg.

Peel the potatoes and cut them into slices 3–4 mm thick. Mix the potatoes with the cheese and the cream topping, and transfer to the ovenproof dish.

Sprinkle with gouda, then bake uncovered.

Setting:  Bakes

Weight: 1000 g

Shelf level: Turntable

Pork kebabs (makes 8 kebabs)

Total time required: 25–35 minutes +
1 hour standing time

Ingredients

1 fillet of pork, approx. 300 g

1 red pepper

2 onions

For the marinade

8 tbsp oil

Salt, pepper, sweet paprika and chilli powder

8 wooden skewers

Method

Cut the pork fillet into 16 cubes. Wash the pepper and cut into bite-sized pieces. Cut the onions into eight pieces. Place the meat, pepper and onion pieces alternately on the skewers. Mix together the ingredients for the marinade and brush the kebabs with the mixture. Allow to marinate for approx. one hour. Lay the kebabs on the grill rack and place in the oven together with a heat-resistant, microwave-safe dish. Turn halfway through grilling when the audible tone sounds.

Setting:  Rotisserie

Weight: approx. 100 g per kebab

Shelf level: Rack and dish on turntable

Chicken kebabs (makes 8 kebabs)

Total time required: 25–35 minutes + 1 hour standing time

Ingredients

4 chicken breasts each approx. 120 g
4 tinned pineapple rings
16 tinned apricot halves

For the marinade

4 tbsp oil
4 tbsp sesame oil
Salt and pepper
 $\frac{1}{2}$ tsp paprika
 $\frac{1}{2}$ tsp curry powder
A little chilli powder
Ground ginger or coriander, if desired
8 wooden skewers

Method

Cut each chicken breast into 4 pieces. Cut the pineapple slices into quarters. Drain the tinned apricot halves well. Mix all ingredients for the marinade thoroughly.

Arrange the chicken pieces, pineapple and apricots alternately on the wooden skewers, brush with the marinade and set aside for 1 hour. Lay the kebabs on the grill rack and place in the oven together with a heat-resistant, microwave-safe dish. Turn halfway through the cooking duration when the buzzer sounds.

Setting:  Rotisserie

Weight: approx. 100 g per kebab

Shelf level: Rack and dish on turntable

Chicken thighs

Method

Brush the chicken thighs with butter or oil and season. Place on the grill rack in the oven together with a heat-resistant, microwave-safe dish. Halfway through cooking when a buzzer sounds, turn the chicken thighs over and continue to cook.

Setting:  Chicken pieces

Whole chicken

Method

Cut the chicken in half. Brush with melted butter or oil, and season. Then place the chicken halves on the grill rack in the oven with the cut side facing upwards together with a heat-resistant, microwave-safe dish. Halfway through cooking when a buzzer sounds, turn the chicken halves over and continue to cook.

Setting:  Grilled chicken

For grilling poultry

Method

For a good colour when grilling chicken, sprinkle over a mixture of paprika and curry powder. The spices will give the skin an appetising golden colour as well as enhancing the flavour.

Recipes for automatic programmes

Fish curry (serves 4)

Total time required: 35–45 minutes

Ingredients

300 g pineapple chunks
1 red pepper
1 small banana
500 g filleted redfish or rosefish
3 tbsp lemon juice
30 g butter
100 ml white wine
100 ml pineapple juice
Salt, sugar and chilli powder
2 tbsp cornflour

Method

Dice the fish and place in a suitable container. Drizzle with lemon juice. Quarter the peppers, remove the seeds and pith, and cut into narrow strips. Peel and slice the banana. Add to the fish together with the pepper and pineapple pieces and mix well. Add the butter. Mix together the wine, juice, seasoning and cornflour and pour over the fish. Mix everything thoroughly, then cover and cook.

Setting:  Fish fillet in sauce

Weight: approx. 1200 g

Shelf level: Turntable

Crispy fish pie (serves 2)

Total time required: 25–35 minutes

Ingredients

400 g filleted rosefish
3 tbsp lemon juice
Salt, white pepper
50 g butter
2 tsp mustard
1 onion, finely diced
40 g Gouda, grated
20 g breadcrumbs
2 tbsp fresh dill, chopped

Method

Drizzle the fish fillet with the lemon juice, and leave to stand for approx. 10 minutes. Grease a flat oven dish with a little butter. Pat the fish dry, season with salt and pepper and place in the dish. Mix the melted butter (450 W, 40–50 sec.) with the mustard, onions, gouda, breadcrumbs and dill and brush onto the fish. Bake until golden.

Setting:  Fish pie

Weight: approx. 600 g

Shelf level: Turntable

Rosefish and tomato gratin (serves 4)

Total time required: 35–45 minutes

Ingredients

500 g filleted rosefish
2 tbsp lemon juice
500 g tomatoes
Herb seasoning salt
2 tsp dried oregano
150 g Gouda, grated

Method

Cut the fish into pieces, drizzle with lemon juice and leave to stand for approx. 10 minutes. Dice the tomatoes, and place in a baking dish with the fish and half of the cheese. Season generously with salt and oregano, and mix well. Sprinkle with the rest of the cheese and bake uncovered.

Setting:  Fish pie

Weight: approx. 1150 g

Shelf level: Turntable

Recipes for automatic programmes

Grilled trout (serves 4)

Total time required: 25–30 minutes

Ingredients

4 trout, 250 g each
4–8 tbsp chopped parsley
Salt, pepper, lemon juice
Flakes of butter

Method

Clean the trout, season inside and out and stuff with herbs. Lay the trout on a lightly oiled grill rack, brush with softened butter and place in the oven compartment together with a heat-resistant, microwave-safe dish.

Setting:  Grilled fish

Weight: approx. 1000 g

Shelf level: Rack and dish on turntable

Bacon

Use this programme to make crispy bacon in the microwave.

Method

Place a sheet of kitchen paper on a microwave-safe plate.

Place the bacon on top of the paper and cover it with another sheet of kitchen paper.

Select the Bacon programme, enter the number of rashers and start the programme.

Chicken breast in mustard sauce (serves 4)

Total time required: 30 minutes

Ingredients

250 ml crème fraîche
1 clove of garlic, crushed
4 tbsp sweet mustard
1½ tsp salt
½ tsp sage
4 chicken breast fillets (200 g each), ready to cook

Accessories

Microwave-safe ovenproof dish

Method

To make the sauce, mix together the crème fraîche, garlic, mustard, salt and sage.

Place the chicken breast fillets in the ovenproof dish and spread the sauce over the top. Cover and start the programme.

Turn the chicken breast fillets over and baste them with the sauce when the instruction Turn appears in the display. Cover and continue to cook.

Setting:  Chicken in sauce

Weight: 1100 g

Shelf level: Turntable

Tip

As an alternative, try using coarse grain mustard instead.

Recipes for automatic programmes

Minestrone (serves 4)

Total time required: 40 minutes

Ingredients

50 g bacon
1 onion
150 g celery
2 tomatoes
150 g carrots
100 g green beans, frozen
100 g peas, frozen
50 g pasta (small shells)
1 tbsp mixed Italian herbs, frozen
100 ml vegetable stock
100 g hard cheese (Parmesan), whole piece

Accessories

Glass dish with lid, microwave safe

Method

Dice the bacon and onion. Dice the celery and tomatoes. Cut the carrots into slices. Put all of these into the glass dish.

Add the beans, peas, pasta and herbs along with the stock and stir. Cover and start the programme.

Stir the soup occasionally and cover and continue to cook.

Grate the parmesan and sprinkle it over the soup.

Setting:  Soup
Weight: 1000 g
Shelf level: Turntable

Tip

Instead of pasta, you could also use 150 g diced potatoes.

White cabbage stew (serves 4)

Total time required: 45 minutes

Ingredients

200 g beef mince
 $\frac{1}{2}$ tsp salt
 $\frac{1}{2}$ tsp sweet paprika
Pepper
1 onion
250 g potatoes
100 g leeks
250 g white cabbage
250 g beetroot
250 ml beef stock
 $1\frac{1}{2}$ tsp salt
2 tbsp red wine vinegar
150 ml crème fraîche
1 tbsp parsley, chopped

Accessories

Microwave-safe bowl

Method

Knead together the mince, paprika, salt and pepper. Form into small minced meat balls and place in the bowl.

Dice the onion and potatoes. Cut the leek into rings. Shred the white cabbage. Grate the beetroot.

Layer the vegetables on top of the meatballs. Add the beef stock and salt. Cover and cook according to the programme.

Stir in the crème fraîche and parsley. Season with the red wine vinegar to taste.

Setting:  Stew
Weight: 1600 g
Shelf level: Turntable

Recipes for automatic programmes

Meatballs (serves 4)

Total time required: 30 minutes

For the meatballs

40 g breadcrumbs
110 ml water
1 onion, finely diced
250 g pork mince
250 g beef mince
1 medium egg
1 tsp salt
Pepper

For the sauce

40 g softened butter
40 g plain white flour
500 ml cold meat stock
2 tbsp cream
1 tbsp capers
1 tsp lemon juice

Accessories

Microwave-safe ovenproof dish

Method

Mix together the water and breadcrumbs and leave to soak.

Add the mince and onions to the breadcrumbs. Add the egg, salt and pepper, and knead into a meat dough. Shape into 8 meatballs and place in an ovenproof dish.

Mix together the butter and flour. Divide this mixture into small portions and place next to the meatballs. Add the meat stock. Cover and cook according to the programme.

When the buzzer sounds, carefully stir the sauce until smooth. Season with the cream, capers and lemon and continue to cook.

Setting:  Meat in sauce

Weight: 1400 g

Shelf level: Turntable

Frozen pizza

You can use the Pizza - thin base and Pizza - thick base programmes to cook frozen pizzas.

The Pizza - thin base programme is suitable for thin, pre-baked pizzas; the Pizza - thick base programme is suitable for thicker pizzas with dough that still needs to rise in the oven compartment. Select the right programme depending on the pizza.

Fish fillet

Season the ready-to-cook fish fillet according to taste, place in a microwave-safe, ovenproof dish, cover with heat-resistant film or with a microwave-safe cover, enter the weight and cook.

Red berry compote (serves 4)

Total time required: 15–20 minutes

Ingredients

400 g mixed berries (e.g. strawberries, raspberries), fresh or frozen
50 ml strawberry syrup
1–2 tbsp cornflour
20 ml crème de cassis

Method

Add 100 ml water and the strawberry syrup to the berries in a bowl.

Mix together the cornflour with 2 tbsp water and the crème de cassis. Add to the berries and cook according to the programme.

Setting:  Fruit compote

Weight: 500 g

Shelf level: Turntable

Tip

Serve with vanilla ice cream or custard.

Reheat

Select the following microwave power levels to reheat food:

| | |
|------------------------------|-------|
| Drinks | 900 W |
| Food | 600 W |
| Food for babies and children | 450 W |

 Risk of burning due to hot food.
Food for babies and children must not be too hot.
Only heat it for 1/2 to 1 minute at 450 watts.

Tips on reheating

 Danger of explosion due to pressure build-up.
Pressure can build up during reheating in sealed containers or bottles, causing them to explode.
Sealed glass containers, such as jars of baby food, must be opened before they are heated in the microwave oven. Do not attempt to heat them up unopened. With baby bottles, the screw top and teat must be taken off.

 Risk of injury caused by overboiling.

When heating liquids using microwave power, the boiling point of the liquid may be reached without the production of typical bubbles. The liquid does not boil evenly throughout. This so-called boiling delay can cause a sudden build-up of bubbles when the container is removed from the microwave or shaken, which can lead to the liquid boiling over suddenly and explosively. The formation of bubbles can be so strong that the pressure forces the appliance door open.

A boiling delay can be avoided by stirring liquids before reheating them. After reheating, wait at least 20 seconds before removing the container from the oven compartment. In addition, a glass rod or similar item, if available, can be placed in the container during heating.

Eggs can explode.

Never reheat hard boiled eggs using the microwave oven, even without the shell.

Always ensure that food is sufficiently cooked or reheated.

If in any doubt that a sufficiently high temperature has been reached, continue reheating for a little longer.
Stir or turn larger amounts of food from time to time during reheating. Stir the food from the outside towards the middle, as food heats more quickly from the outside.

After reheating

Be careful when taking out a container. It may be hot.

Although the container is not normally heated by the microwaves (apart from stoneware), heat may transfer from the food to the container.

Allow food to stand for a few minutes at room temperature at the end of a reheating process. This enables the heat to spread evenly throughout the food.

 Risk of burning due to hot food.

The food can be very hot after reheating.

After reheating food, especially food for babies and small children, stir the food or shake the container and check that the temperature does not pose any danger.

Cooking

Place the food in a microwave safe container and cover it.

When cooking, it is a good idea to select a power level of 900 W to start with and then when the food is hot reduce the power level to 450 W for more gentle continued cooking.

For dishes such as **rice** or **semolina pudding**, first select a power level of 900 W, and then reduce it to 150 W for simmering.

Tips on cooking

Vegetable cooking durations depend on the texture of the vegetable. Fresh vegetables contain more water than vegetables which have been stored, and usually cook more quickly. Add a little water to vegetables which have been stored.

Food taken straight from the refrigerator takes longer to cook than food at room temperature.

 Health risk due to insufficient cooking duration.

It is very important to make sure that food which goes off easily, such as fish, is cooked for a sufficient time.

Ensure that this type of food is cooked for an appropriate length of time.

Food with a thick skin or peel, such as tomatoes, sausages, jacket potatoes and aubergines, should be pierced or the skin scored in several places before cooking to allow steam to escape and to prevent the food from bursting.

 Risk of injury due to eggs with shells.

Eggs heated in their shells can burst, even after they have been taken out of the oven compartment.

Eggs can only be cooked in their shells in the microwave oven in a specially designed egg-boiling device.

 Risk of burning due to eggs without shells.

If you cook eggs without their shells using microwave power, the yolks could explode due to the resulting pressure.

Eggs can only be cooked without their shells in the microwave oven if the yolk membrane has been punctured several times first.

After cooking

Be careful when removing a dish from the oven. It may be hot.

Although heat is not normally produced in the container itself by the microwaves (apart from stoneware), heat transfer from the food to the container may be considerable, making the container itself hot.

Allow food to stand for a few minutes at room temperature at the end of cooking. This enables the heat to spread evenly throughout the food.

Defrost

 Health risk due to refreezing.

Thawed or defrosted food loses nutritional value through refreezing and can go off.

Do not refreeze food once it has thawed. Use it as quickly as possible. Defrosted food may only be re-frozen after it has been cooked.

- 80 W
for defrosting very delicate food, e.g. cream, butter, gateau and cheese.
- 150 W
for defrosting everything else.

Remove the food from its packaging and place in a microwave-proof container. Defrost uncovered. Turn, stir or separate the food about halfway through the defrosting time.

 Health risk due to risk of salmonella.

It is particularly important to observe food hygiene rules when defrosting poultry.

Do not use the liquid produced during defrosting.

Meat, poultry and fish does not need to be fully defrosted before cooking. Defrost until the food has started to thaw. The surface will then be sufficiently thawed to absorb herbs and seasoning.

Defrosting and cooking

Deep-frozen food can be defrosted and immediately reheated or cooked.

First select 900 W followed by 450 W. Remove the food from its packaging and place in a covered microwave-proof dish for defrosting and reheating or cooking. Exception: Minced meat should be left uncovered while cooking.

Food with a high water content such as soup, stew and vegetables should be stirred several times during the process. Carefully separate and turn slices of meat halfway through the programme. Turn pieces of fish at the halfway stage.

After defrosting and reheating or cooking allow the food to stand at room temperature for a few minutes to enable the heat to spread evenly throughout the food.

Examples of use

| Food | Quantity | MW power (watts) | Duration (in minutes) | Notes |
|--|-------------------------------------|-------------------|-----------------------|--|
| Melting butter/margarine | 100 g | 450 | 1:00–1:10 | Do not cover |
| Melting chocolate | 100 g | 450 | 3:00–3:30 | Do not cover, stir halfway through melting |
| Dissolving gelatine | 1 packet + 5 tbsp water | 450 | 00:10–00:30 | Do not cover, stir halfway through dissolving |
| Preparing flan topping/jelly glaze | 1 packet + 250 ml liquid | 450 | 4–5 | Do not cover, stir halfway through heating |
| Yeast dough | Starter dough made with 100 g flour | 80 | 3–5 | Cover and leave to prove |
| Chocolate-coated marshmallows | 20 g | 600 | 00:10–00:20 | Place on a plate, do not cover |
| Steeping oil for salad dressing | 125 ml | 150 | 1–2 | Heat uncovered on a gentle heat |
| Tempering citrus fruits | 150 g | 150 | 1–2 | Place on a plate, do not cover |
| Softening ice cream | 500 g | 150 | 1–3 | Place open container in the appliance |
| Skinning tomatoes | 3 pieces | 450 | 6–7 | Cut a cross into the top of each tomato, cover, and heat in a little water. The skins will slip off easily. The tomatoes may get very hot. |
| Strawberry jam | 300 g strawberries, 300 g jam sugar | 900 | 7–9 | Mix the fruit and sugar in a deep container, cover and cook |
| Defrosting and crisping up bread rolls | 2 pieces | 150 + Grill Grill | 1–2 4–6 | Place uncovered on the rack, turning halfway through |

The information given in this chart is intended only as a guide.

Note for test institutes

| Test food acc. to EN 60705 | Microwave power level (W)+Grill/Automatic programme | Duration (min)/weight | Standing time* (min) | Notes |
|---|---|-----------------------|----------------------|---|
| Custard, 1000 g | 300 | 38–40 | 120 | Container see Standard, dimensions at the upper rim (25 x 25 cm) |
| Sponge cake, 475 g | 600 | 7–7:30 | 5 | Container see Standard, external diameter at the upper rim 220 mm, cook uncovered |
| Minced meat, 900 g | 600 450 | 4 17 | 5 | Container see Standard, dimensions at the upper rim 250 mm x 124 mm, cook uncovered |
| Potato gratin, 1100 g | Bakes | 1100 g | 5 | Container see Standard, external diameter at the upper rim 220 mm, cook uncovered |
| Chicken, 1200 g frozen weight, defrosted and halved | Grilled chicken | 1200 g | 2 | Grill rack with a heat-resistant, microwave-safe dish underneath, make sure the cut surfaces are facing upwards first, turn halfway through the cooking duration. |
| Defrost meat, (minced meat), 500 g | 300 150 | 3 6:30 | 10 | Container see Standard, do not cover, turn halfway through defrosting |
| Raspberries, 250 g | 150 | 7 | 3 | Container see Standard, defrost uncovered |

* Allow the food to stand at room temperature for the standing time specified to enable the heat to spread evenly throughout the food.

Disconnect the microwave oven from the power supply before cleaning.

Under no circumstances should a pressure cleaner be used to clean the microwave oven.

The steam from a steam cleaning appliance could reach live electrical components and cause a short circuit.

Oven interior and inside of the door

 Risk of burning due to hot oven compartment.

The oven compartment may be too hot to clean immediately after use. Clean the oven compartment as soon as it has cooled down.

 Fire hazard due to excessive soiling.

Excessive soiling could damage the appliance in certain circumstances and could even be dangerous due to the fire risk.

Do not wait too long to clean the appliance as this will make cleaning unnecessarily difficult and in extreme cases, impossible.

The oven compartment and the inside of the door can be wiped using a mild detergent or a little washing-up liquid and water. Wipe dry with a soft cloth.

For heavier soiling, heat a glass of water inside the oven compartment for 2 or 3 minutes until the water begins to boil. The steam will collect on the walls and soften the soiling. The oven interior can now be wiped clean using a little washing-up liquid if necessary.

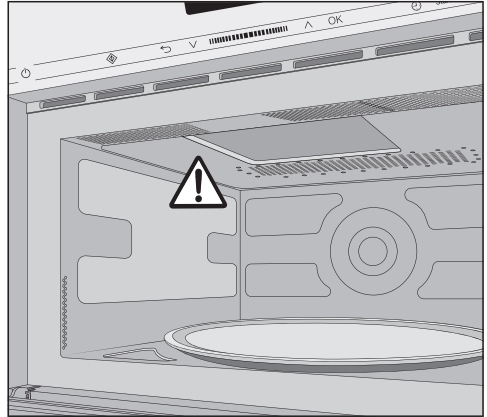

Do not remove the cover to the microwave outlet inside the oven.

Do not let water or any object find its way into or block the air vents of the appliance.

Do not use too much water and do not let water or any other liquid find its way into any openings.

Do not use scouring agents. These will scratch.

To neutralise odours in the microwave oven compartment, put a cup of water with some lemon juice in the appliance and simmer for a few minutes.

Cleaning and care

 Health risk caused by a faulty appliance.

If any damage to the door is noticed, the appliance should not be used until the fault has been rectified by a Miele authorised and trained service technician. Operating a damaged appliance can result in microwave leakage and present a hazard to the user.

The door should be kept clean at all times and checked at regular intervals for any signs of damage. Do not use the microwave oven if:

- the appliance door is warped.
- the door hinges are loose.
- holes or cracks are visible in the casing, the door or the oven interior walls.

To clean the interior:

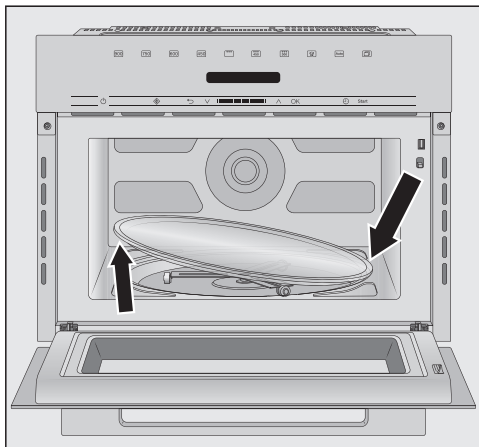

- Remove the turntable, and wash in the dishwasher or by hand.

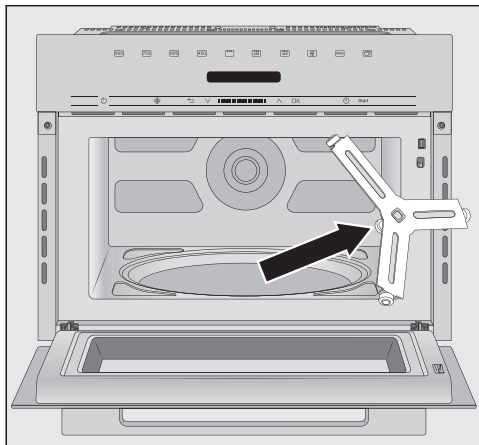

- Always keep the roller ring underneath it clean as well as the oven floor. Otherwise the turntable will not turn smoothly.
- Clean the surfaces between the turntable and the roller ring.

Do not turn the turntable and/or locator manually, as this could damage the drive motor.

Appliance front

Do not let water or any object find its way into or block the air vents in the door frame.

Soiling that is left too long might become impossible to remove and could cause the surfaces to alter or discolour.

Remove any soiling on the front of the appliance straight away.

All surfaces are susceptible to scratching. Scratches on glass can in some circumstances lead to breakage.

Contact with unsuitable cleaning agents can alter or discolour the external surfaces.

Please observe the cleaning instructions.

To avoid damaging the surfaces of the appliance, do not use:

- detergents containing soda, ammonia, acids or chlorides
- cleaning agents containing descaling agents
- abrasive cleaning agents, e.g. scouring powder, scouring liquid, or pumice stones
- cleaning agents containing solvents
- stainless steel cleaning agents
- dishwasher cleaner
- oven sprays
- glass cleaning agents
- hard, abrasive sponges and brushes, e.g. pot scourers
- eraser stain remover blocks
- sharp metal scrapers

Accessories supplied

Rack

Wash and dry the rack after each use. It is dishwasher-proof. Remove stubborn soiling with a stainless steel cleaner.

Gourmet plate

Do not use wire wool, or abrasive sponges, aggressive or abrasive cleaning agents.

Do not clean the gourmet plate in a dishwasher.

If the gourmet plate has been used to cook food with a strong aroma, you can neutralise any odours by adding some water and lemon juice to the gourmet plate and heating it up in the microwave oven using maximum power for a 2-3 minutes. Rinse the gourmet plate afterwards with clean water.

Problem solving guide

Many malfunctions and faults that can occur in daily operation can be easily remedied. You can save time and money in many cases, as you do not need to call the Miele Customer Service Department.

Information to help you rectify faults yourself can be found at www.miele.com/service.

The following tables are designed to help you to find the cause of a malfunction or a fault and to resolve it.

| Problem | Cause and remedy |
|--|---|
| A programme will not start. | Check whether: <ul style="list-style-type: none"> ■ the appliance door is closed. ■ the system lock has been activated (see “System lock” section in the “Operation” chapter). ■ Food in oven? has appeared in the display. The door has not been opened for a long time (approx. 20 minutes) (see “Food in oven?” section in the “Operation” chapter). ■ the appliance is plugged into the electricity supply and switched on at the socket. ■ the mains fuse has tripped. If it has, there could be a fault with the appliance, the household electricity supply or another appliance (disconnect the appliance from the electricity supply and contact a qualified electrician or the Miele Customer Service Department, see “Customer service” chapter). |
| A noise can be heard after a cooking programme. | This is not a fault. The cooling fan will continue to run for a while after the oven has been switched off to prevent any humidity building up in the oven compartment, on the control panel or on the oven housing unit. It will switch off automatically. |
| The display does not light up. | The time of day display has been switched off. <ul style="list-style-type: none"> ■ Switch on the appliance using the On/Off button ①. |
| The turntable does not turn smoothly. | The area underneath the turntable could be dirty. <ul style="list-style-type: none"> ■ Check whether there is any soiling underneath the turntable. ■ Check whether the surfaces between the turntable and the roller ring are clean. ■ Clean the area underneath the turntable. |
| Food is not adequately defrosted, heated or cooked at the end of the selected cooking duration. | The duration or power level were insufficient to cook the food. <ul style="list-style-type: none"> ■ Check whether the correct power level was selected for the duration set. The lower the power level, the longer the duration required. ■ Check whether the programme has been interrupted and not restarted. |

Problem solving guide

| Problem | Cause and remedy |
|--|---|
| The microwave function is working but not the oven lighting. | <p>The lamp is faulty. You can then operate the appliance as normal, but not the lighting.</p> <ul style="list-style-type: none"> ■ Contact Miele Customer Service if you need to replace the lighting. |
| Strange noises are heard when the microwave oven is being used. | <p>The food is covered with aluminium foil.</p> <ul style="list-style-type: none"> ■ Remove the aluminium foil. |
| | <p>Sparks are being created by the use of crockery with a metallic finish.</p> <ul style="list-style-type: none"> ■ Please observe the information on suitable containers. |
| The time of day in the display is not accurate. | <p>The time of day must be reset following an interruption to the power supply.</p> <ul style="list-style-type: none"> ■ Set the correct time of day. |
| Food cools down too quickly. | <p>In the microwave oven, food begins to cook from the outside first, the inside of the food relying on the slower conduction of heat.</p> <p>If food is cooked at a high power level, it is possible that the heat may not have reached the centre of the food, so it is hot on the outside but cold in the centre. During standing time heat is transferred to the centre of the food.</p> <ul style="list-style-type: none"> ■ When reheating food with different densities, such as plated meals, it is therefore sensible to select a lower power level and lengthen the duration required. |
| The microwave oven switches itself off during a cooking, reheating or defrosting programme. | <p>There may be insufficient air circulation.</p> <ul style="list-style-type: none"> ■ Check whether the air inlet or outlet is blocked. Remove any obstruction. |
| | <p>The appliance switches off automatically in cases of overheating.</p> <ul style="list-style-type: none"> ■ Cooking can be continued after a cooling-down period. |
| | <p>The appliance switches itself off again.</p> <ul style="list-style-type: none"> ■ Contact your Miele dealer. |

Service

Information to help you rectify faults yourself and about Miele spare parts can be found at www.miele.com/service.

Contact in the event of a fault

You can book a Miele Customer Service Department call-out online at www.miele.com/service.

Contact information for the Miele Customer Service Department can be found at the end of this document.

Please quote the model identifier and serial number of your appliance (Fabr./SN/Nr.) when contacting the Miele Customer Service Department. This information can be found on the data plate.

Please note that telephone calls may be monitored and recorded for training purposes and that a call-out charge will be applied to service visits where the problem could have been resolved as described in this booklet.

Warranty

For information on the appliance warranty specific to your country please contact Miele. See back cover for address.

In the UK, your appliance warranty is valid for 2 years from the date of purchase. However, you must activate your cover by calling 0330 160 6640 or registering online at www.miele.co.uk.

United Kingdom

Miele Co. Ltd., Fairacres, Marcham Road, Abingdon, Oxon, OX14 1TW
Tel: 0330 160 6600, Internet: www.miele.co.uk, E-mail: info@miele.co.uk

Australia

Miele Australia Pty. Ltd.
ACN 005 635 398
ABN 96 005 635 398
Level 4, 141 Camberwell Road
Hawthorn East, VIC 3123
Tel: 1300 464 353
E-mail: info@miele.com.au
Internet: www.miele.com.au

China Mainland

Miele Electrical Appliances Co., Ltd.
1-3 Floor, No. 82 Shi Men Yi Road
Jing' an District
200040 Shanghai, PRC
Tel: +86 21 6157 3500
Fax: +86 21 6157 3511
E-mail: info@miele.cn
Internet: www.miele.cn

Hong Kong, China

Miele (Hong Kong) Ltd.
41/F - 4101, Manhattan Place
23 Wang Tai Road
Kowloon Bay, Hong Kong
Tel: (852) 2610 1025
Fax: (852) 3579 1404
E-mail:
customerservices@miele.com.hk
Website: www.miele.hk

India

Miele India Pvt. Ltd.
1st Floor, Copia Corporate Suites,
Commercial Plot 9, Mathura Road,
Jasola, New Delhi - 110025
E-mail: customercare@miele.in
Website: www.miele.in

Ireland

Miele Ireland Ltd.
2024 Bianconi Avenue
Citywest Business Campus
Dublin 24
Tel: (01) 461 07 10
Fax: (01) 461 07 97
E-mail: info@miele.ie
Internet: www.miele.ie

Malaysia

Miele Sdn Bhd
Suite 12-2, Level 12
Menara Sapura Kencana
Petroleum
Solaris Dutamas No. 1
Jalan Dutamas 1
50480 Kuala Lumpur, Malaysia
Phone: +603-6209-0288
Fax: +603-6205-3768

New Zealand

Miele New Zealand Limited
IRD 98 463 631
8 College Hill
Freemans Bay, Auckland 1011
Tel: 0800 464 353
E-mail: customercare@miele.co.nz
Internet: www.miele.co.nz

Singapore

Miele Pte. Ltd.
29 Media Circle
#11-04 ALICE@Mediapolis
Singapore 138565
Tel: +65 6735 1191
Fax: +65 6735 1161
E-mail: info@miele.com.sg
Internet: www.miele.sg

South Africa

Miele (Pty) Ltd.
63 Peter Place, Bryanston 2194
P.O. Box 69434, Bryanston 2021
Tel: (011) 875 9000
Fax: (011) 875 9035
E-mail: info@miele.co.za
Internet: www.miele.co.za

Thailand

Miele Appliances Ltd.
BHIRAJ TOWER at EmQuartier
43rd Floor Unit 4301-4303
689 Sukhumvit Road
North Klongton Sub-District
Vadhana District
Bangkok 10110, Thailand

United Arab Emirates

Miele Appliances Ltd.
Showroom 1, Eiffel 1 Building
Sheikh Zayed Road, Umm Al Sheif
P.O. Box 114782 - Dubai
Tel. +971 4 3044 999
Fax. +971 4 3418 852
800-MIELE (64353)
E-mail: info@miele.ae
Website: www.miele.ae

Manufacturer: Miele & Cie. KG, Carl-Miele-Straße 29, 33332 Gütersloh, Germany

M 7244 TC

en-GB

M.-Nr. 11 193 961 / 09