

## Operating and installation instructions with recipes Oven





It is **essential** to read these operating and installation instructions before installing and using the appliance. This prevents both personal injury and damage to the appliance.

# Contents

---

<b>Warning and Safety instructions</b> .....	<b>6</b>
<b>Caring for the environment</b> .....	<b>13</b>
<b>Overview</b> .....	<b>14</b>
Oven .....	14
<b>Oven controls</b> .....	<b>15</b>
Function selector .....	16
Display .....	16
Rotary selector < > .....	16
Sensors .....	16
Symbols .....	17
<b>Operating principles</b> .....	<b>18</b>
Selecting a function .....	18
Entering numbers .....	18
Selecting a menu option from a list .....	18
Changing a setting in a list .....	18
Changing the setting with a segment bar .....	18
<b>Features</b> .....	<b>19</b>
Data plate .....	19
Items supplied .....	19
Accessories supplied and available to order .....	19
Safety features .....	25
PerfectClean treated surfaces .....	25
<b>Before using for the first time</b> .....	<b>26</b>
Miele@home .....	26
Standard settings .....	27
Heating up the oven for the first time .....	28
<b>Settings</b> .....	<b>29</b>
Settings overview .....	29
Opening the "Settings" menu .....	30
Language  .....	30
Time .....	30
Display .....	30
Volume .....	30
Units .....	31
Recommended temps .....	31
Pyrolytic recommendation .....	31
Cooling fan run-on .....	31
Operating hours .....	31
Miele@home .....	32
Remote control .....	33
RemoteUpdate .....	33
Software version .....	34

Showroom programme.....	34
Factory default .....	34
<b>Min. minder</b> .....	<b>35</b>
<b>Overview of functions</b> .....	<b>36</b>
<b>Energy saving tips</b> .....	<b>37</b>
<b>Operation</b> .....	<b>38</b>
Basic operation.....	38
Changing values and settings for a cooking programme.....	38
Changing the temperature .....	38
Setting cooking durations.....	38
Changing the set cooking durations .....	39
Deleting the set cooking durations .....	39
Cancelling cooking .....	39
Pre-heating the oven.....	40
<b>Automatic programmes</b> .....	<b>41</b>
Using Automatic programmes.....	41
Usage notes .....	41
<b>Baking</b> .....	<b>42</b>
Tips on baking.....	42
Notes on the cooking charts .....	42
Notes on the oven functions .....	43
<b>Roasting</b> .....	<b>44</b>
Tips for roasting.....	44
Notes on the cooking charts .....	44
Notes on the oven functions .....	45
<b>Grilling</b> .....	<b>46</b>
Tips for grilling.....	46
Notes on the cooking charts .....	46
Notes on the oven functions .....	47
Fan Grill  .....	48
Grill  .....	49
<b>AirFry</b> .....	<b>50</b>
Accessories .....	50
Tips for AirFrying.....	50
Using the AirFry  function .....	50
<b>Other applications</b> .....	<b>51</b>
Defrost .....	51
Low temperature cooking.....	51
Bottling.....	52
Drying.....	54
Frozen food/Ready meals.....	55
Heat crockery.....	55

# Contents

---

<b>Cleaning and care</b> .....	<b>56</b>
Unsuitable cleaning agents .....	56
Removing normal soiling .....	56
Removing stubborn soiling (excluding the FlexiClip telescopic runners).....	57
Stubborn soiling on the FlexiClip telescopic runners.....	57
Pyrolytic programme cleaning .....	58
Removing the door .....	61
Dismantling the door .....	62
Fitting the door .....	64
Removing the shelf runners with FlexiClip telescopic runners.....	65
<b>Problem solving guide</b> .....	<b>66</b>
<b>Service</b> .....	<b>69</b>
Contact in case of fault.....	69
Warranty .....	69
<b>Installation</b> .....	<b>70</b>
Building-in dimensions .....	70
Installation in a tall or base unit.....	70
Side view H 24xx .....	71
Side view H 27xx, H 28xx.....	72
Connections and ventilation .....	73
Installing the oven .....	74
Electrical connection .....	75
<b>Cooking charts</b> .....	<b>76</b>
Creamed mixture.....	76
Rubbed in mixture .....	77
Yeast dough.....	78
Quark dough.....	79
Sponge mixture.....	79
Choux pastry, puff pastry, meringue .....	80
Savoury snacks .....	81
Beef .....	82
Veal .....	83
Pork.....	84
Lamb, game .....	85
Poultry, fish.....	86
<b>Recipes for Automatic programmes</b> .....	<b>87</b>
Apple sponge .....	88
Deep sponge base .....	89
Sponge base filling .....	90
Marble cake.....	91
Fruit streusel cake .....	92
Biscuits .....	93
Drop cookies .....	94

# Contents

---

Walnut muffins .....	95
Pizza (yeast dough) .....	96
Pizza (Quark dough) .....	97
Chicken .....	98
Roast fillet of beef .....	99
Trout .....	100
Salmon fillet .....	101
Australian salmon .....	102
Potato and cheese gratin .....	103
Lasagne .....	104
<b>AirFry recipes</b> .....	<b>105</b>
Falafel with yoghurt dip .....	106
French fries and sweet potato fries .....	107
Sesame tofu sticks .....	108
Baked potatoes with cheese, spring onions and bacon .....	109
Baked potatoes with feta, tzatziki and Greek salad .....	110
Zucchini chips with blue cheese dip and chilli sauce .....	111
Corn grilled with hoisin glaze and coleslaw .....	112
Chicken nuggets with coconut sesame coating .....	113
Blue eye trevalla with crust .....	114
Bananas with pistachio and honey topping .....	115
Portuguese custard tarts .....	116
Vegan Portuguese custard tarts .....	117
<b>Technical data</b> .....	<b>118</b>
Copyright and licences for the communication module .....	118

## Warning and Safety instructions

---

This oven complies with all current local and national safety requirements. However, inappropriate use can lead to personal injury and damage to property.

Read the operating and installation instructions carefully before using the oven for the first time. They contain important information on safety, installation, use and maintenance of the appliance. This prevents both personal injury and damage to the oven.

In accordance with standard IEC 60335-1, Miele expressly and strongly advises that you read and follow the instructions in “Installation”, as well as in the “Warning and Safety instructions”.

Miele cannot be held liable for injury or damage caused by non-compliance with these instructions.

Keep these instructions in a safe place and pass them on to any future owner.

### Correct application

- ▶ This oven is designed for domestic use and for use in similar environments by guests in hotel or motel rooms, bed & breakfasts and other typical living quarters. This does not include common/shared facilities or commercial facilities within hotels, motels or bed & breakfasts.
- ▶ The oven is not suitable for outdoor use.
- ▶ The oven is intended for domestic use only to bake, roast, grill, cook, defrost, preserve, and dry food. Any other use is not permitted.
- ▶ This oven is not intended for use by persons (including children) with reduced physical, sensory or mental capabilities, or lack of experience and knowledge, unless they are supervised whilst using it. They may only use the oven unsupervised if they have been shown how to use it in a safe manner. They must be able to recognise and understand the dangers of misuse.
- ▶ The oven compartment is equipped with special lamps to cope with particular conditions (e.g. temperature, moisture, chemical resistance, abrasion resistance and vibration). These special lamps must only be used for the purpose for which they are intended. They are not suitable for room lighting.

## Safety with children

- ▶ Activate the system lock to ensure that children cannot switch on the oven inadvertently.
- ▶ Young children must not be allowed to use this appliance.
- ▶ Older children may only use the oven if its operation has been clearly explained to them and they are able to use it safely. They must be able to understand and recognise the possible dangers caused by incorrect operation.
- ▶ Cleaning work may only be carried out by older children under the supervision of an adult.
- ▶ Children should be supervised in the vicinity of the oven. Never allow children to play with the oven.
- ▶ Risk of suffocation from packaging material. Whilst playing, children may become entangled in packaging material (such as plastic wrapping) or pull it over their head with the risk of suffocation. Keep packaging material away from children.
- ▶ Risk of injury caused by hot surfaces. Children's skin is far more sensitive to high temperatures than that of adults. External parts of the oven such as the door glass, control panel and the vent become quite hot.  
Do not let children touch the oven when it is in operation.
- ▶ Risk of injury caused by hot surfaces. Children's skin is far more sensitive to high temperatures than that of adults. The oven gets much hotter during pyrolytic cleaning than during normal use.  
Do not let children touch the oven during pyrolytic cleaning.
- ▶ Risk of injury from the open door. The oven door can support a maximum weight of 15 kg. Children could injure themselves on an open door.  
Do not let children sit on the open door, lean against it or swing on it.

## Technical safety

- ▶ Unauthorised installation, maintenance and repairs (including removal of any cover) can cause considerable danger for the user. Installation must be performed by a suitably qualified and competent person. Maintenance and repairs must only be carried out by a Miele authorised technician.
- ▶ Damage to the oven can compromise your safety. Check the oven for visible signs of damage. Do not use a damaged oven.

## Warning and Safety instructions

---

- ▶ Temporary or permanent operation with a self-sufficient or non-mains synchronous energy supply system (e.g. isolated networks, back-up systems) is possible. A requirement for the operation is that the energy supply system complies with all current local and national requirements that apply to stand-alone, solar and/or battery systems. The protective measures provided in the installation and in this Miele product must also be assured in their function and operation in isolated operation or in non-mains synchronous operation, or replaced with equivalent measures in the installation.
- ▶ The electrical safety of this appliance can only be guaranteed when continuity is complete between it and an effective earthing system. It is essential that this basic safety requirement is present and tested regularly. If in doubt, the electrical installation should be checked by a qualified electrician.
- ▶ The connection data (voltage and frequency) on the data plate of the oven must match the mains electricity supply in order to avoid the risk of damage to the oven. Compare this before connecting the appliance to the mains electricity. If in any doubt, consult a qualified electrician.
- ▶ Multi-socket adapters and extension leads do not guarantee the required safety of the appliance. Do not use these to connect the oven to the mains electricity supply.
- ▶ For safety reasons, the oven may only be used when it has been fully installed.
- ▶ This oven must not be installed and operated in mobile installations (e.g. on a ship).
- ▶ Risk of injury due to electric shock. Any contact with live connections or tampering with the electrical or mechanical components of the oven will endanger your safety and may lead to appliance malfunctions.  
Do not open the oven housing under any circumstances.
- ▶ The manufacturer's warranty will be invalidated if the appliance is not repaired by a Miele approved service technician.
- ▶ Miele can only guarantee the safety of the appliance when original Miele spare parts are used. Faulty components must only be replaced by original spare parts.
- ▶ If the oven is delivered without a mains connection cable, a special cable must be installed by a suitably qualified and competent person (see “Installation - Electrical connection”).



## Warning and Safety instructions

---

- ▶ If the mains connection cable is damaged, it must be replaced with a special connection cable by a suitably qualified and competent person in order to avoid a hazard (see “Installation - Electrical connection”).
- ▶ During installation, maintenance and repair work, e.g. if the oven lighting is faulty, the oven must be completely disconnected from the electricity supply (see “Problem solving guide”). To ensure this:
  - Switch off the mains circuit breaker, or
  - switch off at the wall socket and withdraw the plug. To do this, pull the plug and not the mains connection cable.
- ▶ The oven requires a sufficient supply of cool air for efficient operation. Make sure that the supply of cool air is not hindered in any way (e.g. by heat insulation strips fitted in the housing unit). Furthermore, the required supply of cool air must not be excessively heated by other heat sources (e.g. solid fuel stoves).
- ▶ If the oven is built in behind a furniture front (e.g. a door), do not close the furniture door while the oven is in use. Heat and moisture can build up behind the closed furniture door. This can result in damage to the oven, housing unit and floor. Leave the furniture door open until the oven has cooled down completely.

### Correct use



- ▶ Risk of injury caused by hot surfaces. The oven gets hot during operation. You could burn yourself on the heating elements, oven compartment, accessories or food. Wear oven gloves when placing food in the oven or removing it, and when adjusting oven shelves etc. in a hot oven.
- ▶ To avoid fuelling any flames, do not open the oven door if smoke occurs inside the appliance. Interrupt the process by switching the appliance off and disconnect it from the mains electricity supply. Do not open the door until the smoke has dispersed.
- ▶ Due to the high temperatures radiated, objects left near the oven could catch fire. Do not use the oven to heat up the room.
- ▶ Oils and fats can ignite if allowed to overheat. Never leave the oven unattended when cooking with oil or fats. Never attempt to put out oil or fat fires with water. Switch the oven off and extinguish the flames by leaving the door closed.

## Warning and Safety instructions

---

▶ Grilling food for excessively long cooking durations can cause it to dry out with the risk of catching fire. Do not exceed the recommended cooking durations.

▶ Certain foods dry out quickly and may catch fire due to high grilling temperatures.

Never use a grill function to finish baking bake-off rolls or bread, or to dry flowers or herbs. Instead, use the Fan Plus  or Conventional Heat  function and always ensure this type of procedure is supervised.



▶ If using alcohol in your recipes, please be aware that high temperatures can cause the alcohol to evaporate. The vapour can catch fire on hot heating elements.

▶ When using residual heat to keep food warm, corrosion from high air humidity and condensation can occur in the oven. This can also cause damage to the control panel, worktop and surrounding kitchen furniture. Keep the oven on and select the lowest temperature available for the selected function. The cooling fan will then continue to run and dissipate the moisture.

▶ Food which is stored in the oven compartment or left in it to be kept warm can dry out and the moisture released can lead to corrosion damage in the oven. Always cover food that is left in the oven to keep warm.

▶ An accumulation of heat can cause the enamel on the floor of the oven to crack or flake off.

Never line the floor of the oven compartment with aluminium foil or oven liners.

If you wish to place crockery on the oven floor during cooking, or place crockery on the oven floor to heat it up, you can do so, but only with the Fan Plus  or Eco Fan Heat  function.

▶ The oven compartment floor can become damaged by items being pushed around on it. When placing pots, pans or crockery on the oven compartment floor, ensure that you avoid pushing them around.

▶ Danger of injury caused by steam. Pouring a cold liquid onto a hot surface creates steam, which can cause severe scalding. The sudden temperature change can also cause damage to hot surfaces. Never pour cold liquids directly onto hot surfaces.

▶ It is important that the temperature in the food being cooked is evenly distributed and sufficiently high. This can be achieved by stirring or turning the food.

## Warning and Safety instructions

---

- ▶ Plastic dishes that are not suitable for use in an oven will melt and may ignite at high temperatures and damage the oven. Use only plastic containers that are suitable for use in an oven. Follow the manufacturer's instructions.
- ▶ Preserving and heating food in sealed tins will result in an increase in pressure, which can cause them to explode. Do not use tins for preserving or heating food.
- ▶ Risk of injury from the open door. You could bang into the open door or trip over it. Avoid leaving the door open unnecessarily.
- ▶ The door can support a maximum load of 15 kg. Do not lean or sit on an open door, or place heavy items on it. Make sure that nothing gets trapped between the door and the oven compartment. This could damage the oven.

### **The following applies for stainless steel surfaces:**

- ▶ The coated stainless steel surface can be damaged by adhesives and will lose its dirt-repelling properties. Do not use sticky notes, adhesive tape or other types of adhesive on the stainless steel surface.
- ▶ Magnets can cause scratches. Do not use the stainless steel surface as a magnetic notice board.

### **Cleaning and care**

- ▶ Risk of injury due to electric shock. The steam from a steam cleaning appliance could reach electrical components and cause a short circuit. Never use a steam cleaner for cleaning.
- ▶ Excess spillage must be removed before cleaning. Coarse soiling in the oven compartment can cause thick smoke to develop. Coarse soiling should be removed from the oven compartment before running the pyrolytic cleaning programme.
- ▶ Risk of injury caused by hazardous steam. During pyrolytic cleaning, steam, which can irritate mucous membranes, may be released.  
During pyrolytic cleaning, do not stay in the kitchen for longer periods of time and do not let children and pets enter the kitchen. It is important to ensure that the kitchen is well ventilated during pyrolytic cleaning. Prevent odours from escaping into other rooms.
- ▶ The shelf runners can be removed (see "Cleaning and care – Removing the shelf runners with FlexiClip telescopic runners"). Refit the shelf runners correctly.

## Warning and Safety instructions

---

▶ Scratches on the door glass can cause the glass to break. Do not use abrasive cleaners, hard sponges, brushes or sharp metal tools to clean the door glass.

▶ In warm, moist environments, there is a higher probability of vermin infestations (e.g. cockroaches). Ensure the oven and the area surrounding it are always kept clean.

Damage caused by vermin is not covered by the warranty.

### Accessories

▶ Only use original Miele accessories. If other parts are used, warranty, performance and product liability claims will be invalidated.

▶ Miele will guarantee to supply functional spare parts for a minimum of 10 years and up to 15 years following the discontinuation of your oven.

▶ The Miele gourmet oven dish HUB 5000/HUB 5001 (if available) must not be inserted on shelf level 1. This will damage the oven floor. The lack of clearance will create an accumulation of heat which can cause the enamel to crack or flake off. Never place a Miele oven dish on the upper support of shelf level 1 either as it will not be secured by the non-tip safety notches. As a general rule, use shelf level 2.

▶ Accessories will be damaged by the high temperatures reached during pyrolytic cleaning.  
Remove all accessories from the oven compartment before starting the pyrolytic cleaning programme. This also applies to the shelf runners and any optional accessories.

### Disposal of the packing material

The transport and protective packaging has been selected from materials which are environmentally friendly for disposal, and can normally be recycled.

Recycling the packaging reduces the use of raw materials in the manufacturing process and also reduces the amount of waste in landfill sites.

Ensure that any plastic wrappings, bags etc. are disposed of safely and kept out of the reach of babies and young children. Danger of suffocation.

**Only for Australia:** Note for installer: Expanded polystyrene (EPS) packaging included. Please retain and dispose of EPS packaging responsibly. For further information, please contact Miele.

### Disposing of your old appliance

Electrical and electronic appliances often contain valuable materials. They also contain specific materials, compounds and components, which were essential for their correct function and safety. These could be hazardous to human health and to the environment if disposed of with your domestic waste or if handled incorrectly. Please do not, therefore, dispose of your old appliance with your household waste.



Please dispose of it at your local community waste collection / recycling centre for electrical and electronic appliances. You are also responsible for deleting any personal data that may be stored on the appliance prior to disposal. Please ensure that your old appliance poses no risk to children while being stored prior to disposal.

# Overview

---

## Oven

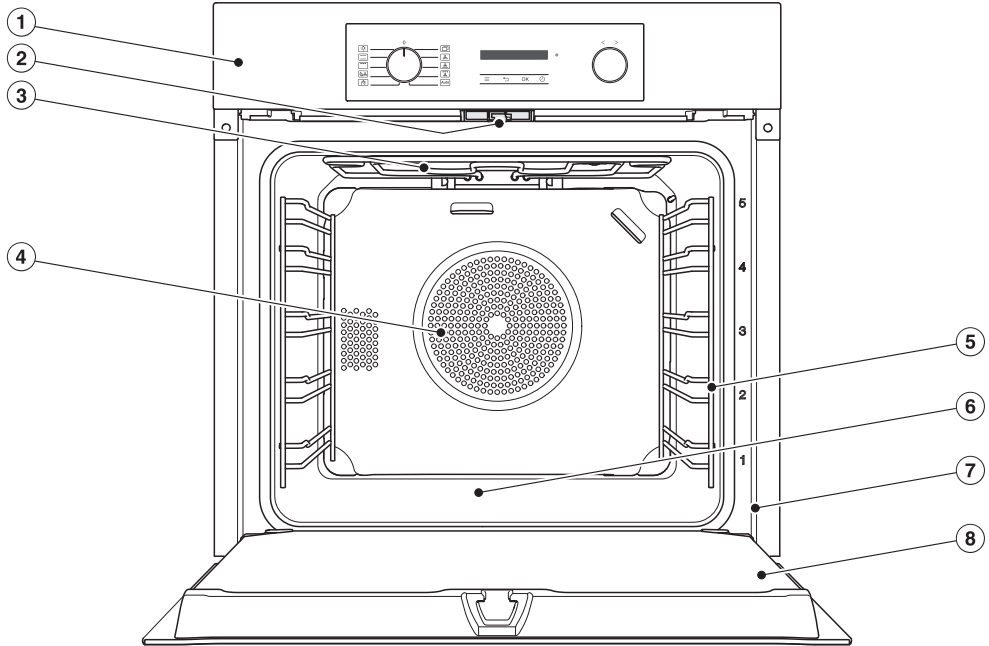

- ① Control panel
- ② Door lock for Pyrolytic cleaning
- ③ Top heat/grill element
- ④ Air inlet for the fan with ring heating element behind it
- ⑤ Shelf runners with 5 shelf levels
- ⑥ Oven floor with bottom heat element underneath it
- ⑦ Front frame with data plate
- ⑧ Door

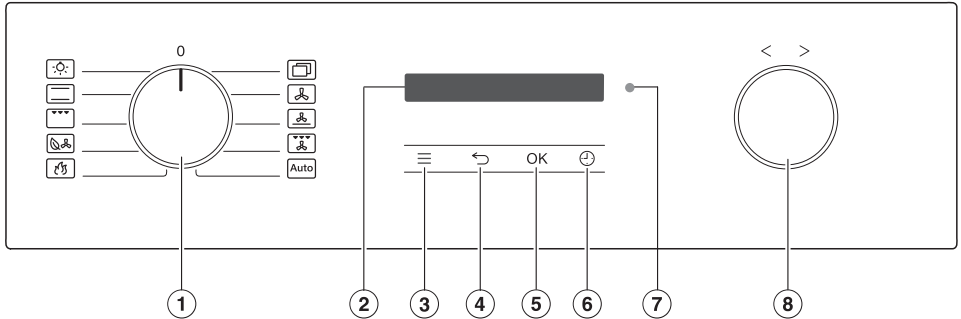

- ① **Function selector**  
For selecting oven functions
- ② **Display**  
For displaying the time of day and information on operation
- ③ **≡ sensor**  
For accessing settings
- ④ **← sensor**  
To go back a step
- ⑤ **OK sensor**  
For calling up functions and saving settings
- ⑥ **🕒 sensor**  
For setting a minute minder, the cooking duration or the start or finish time for the cooking programme
- ⑦ **Optical interface**  
(for Miele service technicians only)
- ⑧ **Rotary selector < >**  
For setting times, temperatures and for selecting menu options











# Oven controls

---

## Function selector

Use the function selector to select the required oven function and switch on the oven interior lighting independently. It can be turned clockwise or anti-clockwise.

### Oven functions

-  Lighting
-  Conventional Heat
-  Full Grill
-  Eco Fan Heat
-  Pyrolytic programme
-  Other | Booster 
-  Other | AirFry 
-  Fan Plus
-  Intensive Bake
-  Fan Grill
-  Automatic programmes

## Display

The display is used for showing the time of day or information about functions, temperatures, cooking durations, Automatic programmes and settings.

## Rotary selector < >

The rotary selector can be turned clockwise or anti-clockwise.

You can increase values such as temperatures and times in the display by turning the rotary selector clockwise > or you can decrease the values by turning it anti-clockwise <.

In addition, you can use the rotary selector to scroll through the selection lists for settings and Automatic programmes in the display.





Turn the rotary selector clockwise > to scroll down in the list and turn it anti-clockwise < to scroll up.

## Sensors

The sensors react to touch. Every touch of the sensors is confirmed by a keypad tone. You can switch this keypad tone off using the ≡ | Volume | Keypad tone sensor.









## Sensor controls under the display

Sensor	Function
	Use this sensor to access the settings when the function selector is in the <b>O</b> or the Lighting  position.
	Depending on which menu you are in, this sensor control will take you back a level or back to the main menu.
<i>OK</i>	By selecting this sensor you can access functions such as the minute minder, save changes to values or settings, or confirm instructions.
	If no cooking programme is in progress, you can use this sensor to set a minute minder (e.g. when boiling eggs on the cooktop) at any point.  While a cooking programme is in progress, you can set a minute minder, the cooking duration and a start or finish time for the programme.

## Symbols

The following symbols may appear in the display:

Symbol	Meaning
	This symbol indicates that there is additional information and advice about using the appliance. Select <i>OK</i> to confirm the information.
	Minute minder
	A tick indicates the option which is currently selected.
	Some settings, e.g. display brightness and signal tone volume, are selected using a segment bar.
	The system lock prevents the oven being switched on by mistake (see “Settings – System lock  ”).
	Remote control (only appears if you are in the Miele@home system and have selected the Remote control   On setting).

# Operating principles

---

## Selecting a function

- Turn the function selector to the required oven function.

The recommended temperature will appear in the display.

- Change the recommended temperature with the rotary selector < >, if necessary.
- Confirm with *OK*.

## Changing the function

You can change to another function during a cooking programme.

- Turn the function selector to the new oven function.

Any cooking durations set will be deleted.



## Entering numbers

Numbers that can be changed are highlighted.

- Turn the rotary selector < > clockwise or anti-clockwise to change the number.
- Confirm with *OK*.

The changed number is now saved.

## Selecting a menu option from a list

- When ,  and  are selected, the relevant menu appears.  
Using the rotary selector < >, scroll through the list until the menu option you want appears.
- Confirm with *OK*.

## Changing a setting in a list

A ✓ tick will appear beside the current setting.

- Turn the rotary selector < > clockwise or anti-clockwise until the required value or setting is shown.
- Confirm with *OK*.

The setting is now saved. This will take you back to the previous menu.

## Changing the setting with a segment bar

Some settings are represented by a  bar with seven segments. If all of the segments are illuminated, the maximum value is selected.

If none or only one of the segments is illuminated, the minimum value is selected or the setting is switched off altogether (e.g. volume).

- Turn the rotary selector < > clockwise or anti-clockwise until the required setting is shown.
- Confirm your selection with *OK*.

The setting is now saved. This will take you back to the previous menu.

A list of the models described in these operating and installation instructions can be found on the back page.

## Data plate

The data plate located on the front frame of the oven is visible when the door is open.

The data plate states the model number, the serial number as well as connection data (voltage, frequency and maximum rated load).

Have this information available if you need to contact Miele so that any issues can be rectified as quickly as possible.

## Items supplied

- Operating and installation instructions for using the oven
- Screws for fixing the oven to the housing unit
- Various accessories

## Accessories supplied and available to order

Features will vary depending on model. The shelf runners, universal tray and wire rack (or “rack” for short) are supplied as standard with the oven. Depending on the model, your oven may also come supplied with some of the accessories listed here.

All accessories and cleaning and care products listed in these instructions are designed for Miele ovens.

These are available to order via the Miele online shop or directly from Miele (see the end of this booklet for contact details).

When ordering, please quote the model number of your oven and the reference number of the accessories required.

## Shelf runners

Shelf runners for accessories are fitted on either side of the oven cavity for shelf levels  1.

The shelf level numbers are marked on the front of the oven frame.

Each level consists of 2 rails, one above the other.

Accessories (e.g. the rack) are pushed into the oven between the two rails.

The shelf runners can be removed (see “Cleaning and care – Removing the shelf runners with FlexiClip telescopic runners”).

## Baking tray, universal tray and rack with non-tip safety notches

Baking tray HBB 71:

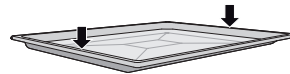

Universal tray HUBB 71:



Rack HBBR 71:



Insert these accessories into the shelf runners between the two rails of a shelf level.

The rack has a rail at the back to prevent dishes sliding off. Ensure the rack is inserted so that the rail is facing upwards.

Non-tip safety notches are located on accessories to prevent the trays being pulled out completely when you only wish to pull them out partially. They also prevent trays from tipping.

## Features

- The non-tip safety notches are located in the middle of the short sides of the baking tray and universal tray.
- The non-tip safety notches are located towards the back of the short sides of the rack.



If you are using the universal tray with the rack on top, insert the tray between the rails of a shelf runner and the rack will sit on top of it.

### FlexiClip telescopic runners HFC 70-C

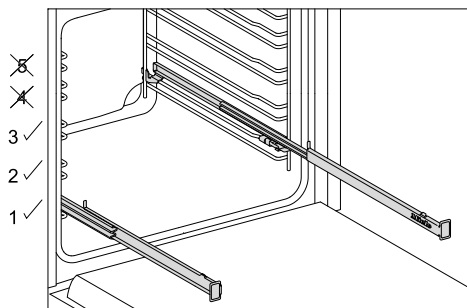

FlexiClip telescopic runners can only be fitted on levels 1, 2 and 3.

The FlexiClip telescopic runners can be drawn right out of the oven to give a good overview of the cooking in progress.

Push the FlexiClip telescopic runners right into the oven compartment before placing accessories on them.

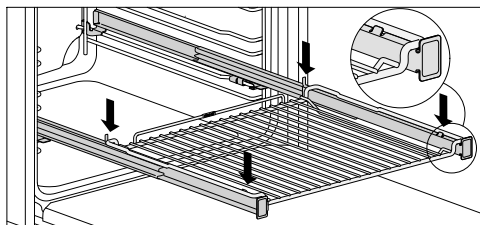
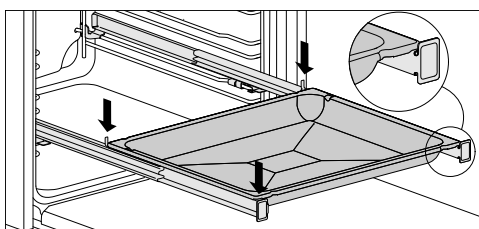

To prevent the risk of accessories sliding off the telescopic runners:

- Make sure that they are sitting securely on their runners in between the stoppers at either end of each runner.
- Always slide the rack onto the FlexiClip telescopic runners with the loading surface facing downwards.

The FlexiClip telescopic runners can support a maximum load of 15 kg.

Because the FlexiClip telescopic runners sit on the top rail of the shelf runners, the gap between the level that the FlexiClip telescopic runners are on and the one above is smaller than if, for instance, racks were fitted on each level. Cooking results will be affected if the gap is too small.

If you need to use more than one baking tray, universal tray or rack at a time:

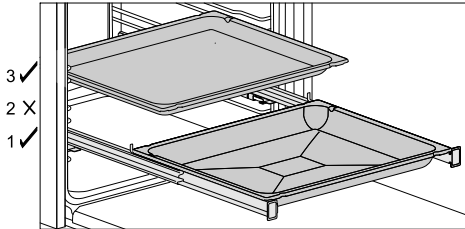

- Place the baking tray, universal tray or rack on the FlexiClip telescopic runners.
- Leave at least one shelf level free between it and any baking tray, universal tray or rack on the FlexiClip telescopic runners above it.

You can use the universal tray together with the rack on the FlexiClip telescopic runners.

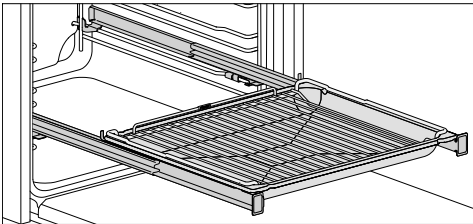

- Place the universal tray together with the rack on the FlexiClip telescopic runners. The rack will automatically slide between the rails of the shelf level above the FlexiClip telescopic runners.
- Leave at least one shelf level free between it and any baking tray, universal tray or rack on the FlexiClip telescopic runners above it.

## Fitting the FlexiClip telescopic runners

 Risk of injury caused by hot surfaces.

The oven gets hot during operation. You could burn yourself on the heating elements, the oven compartment, or accessories.

Allow the heating elements, oven compartment and the accessories to cool down before fitting or removing the FlexiClip telescopic runners.

Preferably fit the FlexiClip telescopic runners onto level 1. You can then use them for food which should be cooked on level 2.

Each level of the shelf runners consists of two rails. The FlexiClip telescopic runners are fitted on the upper rail of the two rails that make a shelf level.

The FlexiClip telescopic runner with the Miele logo is fitted on the right.

When fitting or removing the FlexiClip telescopic runners, do **not** extend them.

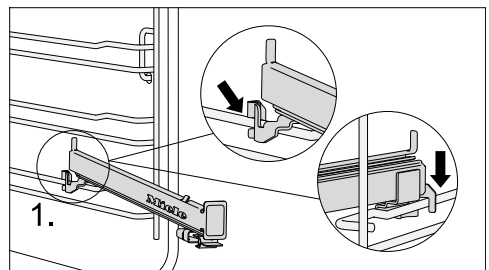

- Hook the FlexiClip telescopic runner onto the front of the top rail of a shelf runner (1.).

# Features

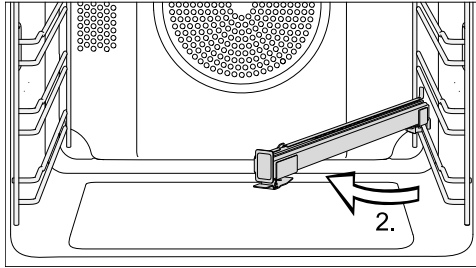

- Then hold the FlexiClip telescopic runner at an angle in towards the middle of the oven compartment (2.).

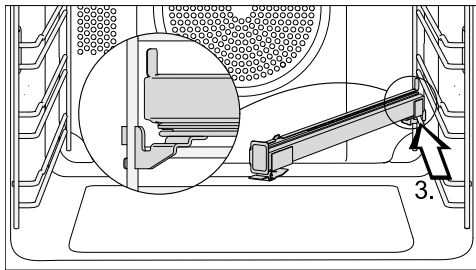

- Slide the FlexiClip telescopic runner at an angle along the top rail as far as it will go (3.).

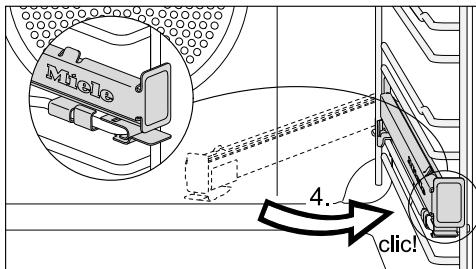

- Then swing the FlexiClip telescopic runner back to the side and secure it to the top rail with an audible click (4.).

If the FlexiClip telescopic runners are difficult to pull out after fitting, you may need to pull firmly on them once to release them.

## Removing the FlexiClip telescopic runners

⚠ Risk of injury caused by hot surfaces.

The oven gets hot during operation. You could burn yourself on the heating elements, the oven compartment, or accessories.

Allow the heating elements, oven compartment and the accessories to cool down before fitting or removing the FlexiClip telescopic runners.

- Push the FlexiClip telescopic runner in all the way.

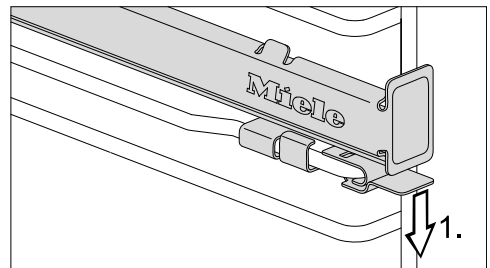

- Push down on the tab at the front of the FlexiClip telescopic runner (1.).

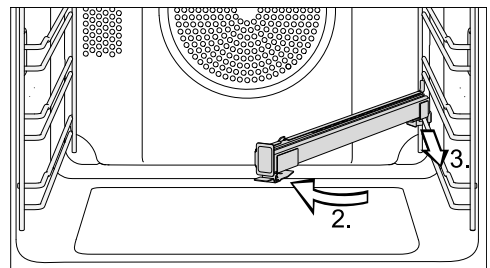

- Swing the FlexiClip telescopic runner towards the middle of the oven compartment (2.), then pull it forwards along the top rail (3.).
- Lift the FlexiClip telescopic runner off the rail and take it out of the oven.

## Gourmet baking and AirFry tray, perforated HBBL 71

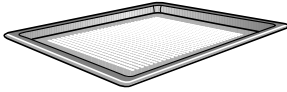

The fine perforations of the Gourmet baking and AirFry tray optimise cooking processes:

- Browning on the underside of baked goods made from fresh yeast and quark doughs, as well as bread and rolls is improved.  
Firstly, roll out the dough on an even work surface and then place it on the Gourmet baking and AirFry tray.
- Chips, croquettes, or similar items can be fried in a hot air flow (AirFrying) without using fat.
- During dehydrating/drying, the air circulation around the food for drying is optimised.

The surface has been treated with PerfectClean enamel.

The **perforated round baking and AirFry tray HBFP 27-1** can be used for these purposes.

## Round baking trays



The **solid round baking tray HBF 27-1** is suitable for cooking pizzas, flat cakes made with yeast or whisked mixtures, sweet and savoury tarts, baked desserts, flat bread, and can also be used for frozen cakes and pizzas.

The **perforated round baking and AirFry tray HBFP 27-1** can be used for the same purposes as the **perforated Gourmet baking and AirFry tray HBBL 71**.

The surface of both baking trays has been treated with PerfectClean enamel.

- Insert the rack and place the round baking tray on the rack.

## Grilling and roasting insert HGBB 71

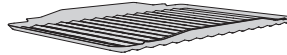

The grilling and roasting insert fits in the universal tray.

The tray will collect meat juices during grilling, roasting or AirFrying and stop them from burning so that they can be used for making gravy and sauces.

The enamelled surface has been treated with PerfectClean.

## Baking stone HBS 70



The baking stone is ideal for items which need a well baked base such as pizza, quiche, bread, bread rolls and savoury snacks.

The baking stone is made from heat-retaining fireclay and is glazed. A paddle made of untreated wood is supplied with the baking stone for placing food on it and taking it off.

- Slide the rack in and place the baking stone on it.

# Features

---

## HUB Gourmet oven dishes HBD Gourmet oven dish lids

Unlike other oven dishes, the Miele Gourmet oven dishes can be placed in the oven directly on the shelf runners.

They have non-tip safety notches like the rack to prevent them from being pulled out too far.

The surface of the oven dishes has a non-stick coating.

Gourmet oven dishes are available in different depths. The width and the height are the same.

Suitable lids are available separately. Please quote the model number when ordering.

### Depth: 22 cm

HUB 5000-M  
HUB 5001-M\*

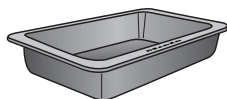

HBD 60-22

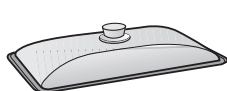

### Depth: 35 cm

HUB 5001-XL\*

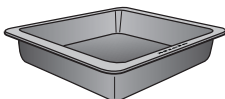

HBD 60-35

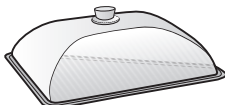

## Handle HEG

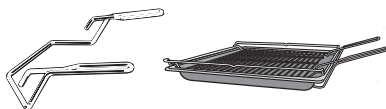

The handle makes it easier to take the universal tray, baking tray and rack out of the oven.



## Accessories for cleaning and care

- Miele all purpose microfibre cloth
- Miele oven cleaner

\* Suitable for induction cooktops



## Safety features

- **System lock**   
(see “Settings – System lock 

## PerfectClean treated surfaces

Surfaces treated with PerfectClean enamel are characterised by their exceptional non-stick properties and ease of cleaning.

Food can be easily removed from these surfaces. Soiling from baking and roasting can be easily removed from these surfaces.

Food can be sliced or cut up on PerfectClean surfaces.

However, do not use ceramic knives as these will scratch the PerfectClean surface.

Surfaces treated with PerfectClean enamel can be cleaned as you would clean glass.

Read the instructions in “Cleaning and care” so that the benefits of the non-stick properties and easy cleaning are retained.

PerfectClean treated surfaces:

- Universal tray
- Baking tray
- Gourmet baking and AirFry tray, perforated
- Grilling and roasting insert
- Round baking tray
- Round baking and AirFry tray, perforated

# Before using for the first time

---

## Miele@home

Your oven is equipped with an integrated Wi-Fi module.

In order to use it, you need:

- a Wi-Fi network
- the Miele App
- a Miele user account. The user account can be created via the Miele App.

The Miele App will guide you as you connect your oven to your home Wi-Fi network.

Once your oven is connected to your Wi-Fi network, you can use the App for a number of actions, including the following:

- Call up information on the operating status of your oven
- Retrieve information on cooking processes that are in progress
- End cooking programmes that are in progress

Connecting your oven to your Wi-Fi network will increase energy consumption, even when the oven is switched off.

Make sure that the signal of your Wi-Fi network is sufficiently strong in the place where your oven is installed.

## Availability of the Wi-Fi connection

The Wi-Fi connection shares a frequency range with other appliances (including microwave ovens and remote control toys). This may result in sporadic or even complete connection failures. Therefore, a constant availability of featured functions cannot be guaranteed.

## Miele@home availability

The ability to use the Miele App depends on the availability of the Miele@home service in your country.

The Miele@home service is not available in every country.

For information about availability, please visit [www.miele.com](http://www.miele.com).

## Miele App

You can download the Miele App from the Apple App Store® or the Google Play Store™ free of charge (only functional in selected countries).



# Before using for the first time

## Standard settings

The following settings must be made before starting up for the first time. You can change these settings again at a later time (see "Settings").

 Risk of injury caused by hot surfaces.

The oven gets hot during operation. For safety reasons, the oven may only be used after it has been fully installed.

The oven will switch on automatically when it is connected to the electricity supply. "Miele" will appear in the display and after a few seconds you will be prompted to set the language.

## Setting the language

- Use the < > rotary selector to select the required language.
- Confirm with *OK*.

If you have accidentally selected a language that you don't understand, proceed as described in "Settings – Language .

## Setting the location

- Use the < > rotary selector to select the required location.
- Confirm with *OK*.

## Setting up Miele@home

Set up "Miele@home" appears in the display.

- To set up Miele@home immediately, confirm by touching *OK*.
- To set it up at a later date, select *Skip* with the rotary selector and confirm with *OK*. See "Settings – Miele@home" for information on setting up at a later date.
- To set up Miele@home immediately, select the desired connection method.

You will then be guided by the display and the Miele App.

## Setting the time of day

- Set the time of day with the rotary selector < > in hours and minutes.
- Confirm with *OK*.

## Completing the initial commissioning process

Set-up successfully completed appears in the display.

- Confirm with *OK*.

Language  appears in the display.

- Select the  sensor.

The time of day appears.

The appliance is now ready for use.

## Before using for the first time

---

### Heating up the oven for the first time

When the oven is heated up for the first time it may give off a slight smell. This can be eliminated by heating the empty oven for at least an hour.

Ensure that the kitchen is well ventilated while the appliance is being heated up for the first time. Prevent odours from escaping into other rooms.

- Remove any protective foil and stickers except the data plate from the oven and accessories.
- Before heating the oven up, wipe the interior with a damp cloth to remove any dust or bits of packaging that may have accumulated during storage and unpacking.
- Fit the FlexiClip telescopic runners (if present) to the shelf runners and insert all trays and the rack.
- Use the function selector to select  Other.

Booster ✓ appears in the display.

- Confirm with *OK*.

The recommended temperature of 160 °C will appear.

The oven heating, lighting and cooling fan will switch on.

- Select the maximum temperature (250 °C).
- Heat up the empty oven for at least one hour.
- After heating up, turn the function selector to **O**.

### Cleaning the oven compartment after heating it up for the first time

 Risk of injury caused by hot surfaces.







The oven gets hot during operation. You could burn yourself on the heating elements, the oven compartment, or accessories.

Allow the heating elements, oven compartment and the accessories to cool before manual cleaning.

- Take all accessories out of the oven and clean them by hand (see “Cleaning and care”).
- Clean the oven compartment with a clean sponge and a solution of hot water and washing-up liquid or a clean, damp microfibre cloth.
- Dry all surfaces with a soft cloth.

Leave the oven door open until the oven interior is completely dry.

## Settings overview

Menu option	Available settings
Language 	...   deutsch   english   ... Location
Time	Display On*   Off   Night dimming Clock format 12 h   24 h* Set
Display	Brightness 
Volume	Buzzer tones Melodies*  Solo tone  Keypad tone 
Units	Temperature °C*   °F
Recommended temps	
Pyrolytic recommendation	On   Off*
Cooling fan run-on	Temperature-controlled* Time-controlled
Operating hours	
System lock 	On   Off*
Miele@home	Activate   Deactivate Connection status Set up again Reset Set up
Remote control	On*   Off
RemoteUpdate	On*   Off
Software version	
Showroom programme	Demo mode On   Off*
Factory default	Appliance settings Recommended temps



\* Factory settings

# Settings

---

## Opening the "Settings" menu

Using the  sensor to access the "Settings" menu, you can personalise your oven by adapting the factory default settings to suit your requirements.

- Turn the function selector to **0** or to the Lighting  position.
- Select the  sensor.

A list of settings will appear in the display.

- Use the rotary selector **< >** to select the required setting.



You can check settings or change them.

- Select the  sensor again to leave the menu.

## Language

You can set your language and location.

After selecting and confirming your choice, the language you have selected will appear in the display.

**Useful tip:** If you have selected the wrong language by mistake, select the  sensor. Follow the  symbol to get back to the Language  sub-menu.

## Time

### Display

Select how you want the time of day to appear in the display when the oven is switched off:

- On  
The time always appears in the display.
- Off  
The display switches off and goes dark to save energy.

- Night dimming  
To save energy, the time is only visible in the display between 5:00 am and 11:00 pm. The display remains dark at all other times.

### Clock format

The time of day can be displayed in the 24 or 12-hour format (24 h or 12 h).

### Set

Set the hours and then the minutes.

If there is a power cut, the current time of day will reappear once power has been restored. The time of day is saved for approx. 5 minutes.

## Display

### Brightness

The display brightness is represented by a segment bar.

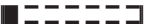
-   
Maximum brightness
-   
Minimum brightness

## Volume



### Buzzer tones

If buzzers are switched on, a buzzer will sound when the set temperature is reached and at the end of a set time.

### Melodies

At the end of a process, a melody will sound several times at intervals.



The volume of the melody is represented by a segment bar.

-   
Maximum volume
-   
Melody is switched off

### Solo tone



At the end of a process, a continuous tone will sound for a period of time.

The pitch of this continuous tone is represented by a segment bar.

-  Highest pitch
-  Lowest pitch

## Keypad tone

The volume of the tone that sounds each time you touch a sensor is represented by a segment bar.

-  Maximum volume
-  Keypad tone is switched off

## Units

### Temperature

You can set the temperature in degrees Celsius (°C) or degrees Fahrenheit (°F).

### Recommended temps

If you frequently cook with different temperatures, it makes sense to change the recommended temperatures.

After selecting this menu option, the list of functions will appear in the display together with their recommended temperatures.

- Select the function you want.
- Change the recommended temperature.
- Confirm with *OK*.

### Pyrolytic recommendation

You can set whether the recommendation for carrying out pyrolytic cleaning will appear (On) or will not appear (Off).

## Cooling fan run-on

The cooling fan will continue to run for a while after the oven has been switched off to prevent any humidity building up in the oven compartment, on the control panel or on the oven housing unit.

- Temperature-controlled  
The cooling fan switches off when the temperature in the oven drops below 70 °C.
- Time-controlled  
The cooling fan switches off after a period of about 25 minutes.

Condensate can damage the oven housing unit, damage the worktop and lead to corrosion in the oven.

If you have set the cooling fan to Time-controlled and leave food in the oven compartment to keep warm, moisture levels in the oven will increase, leading to condensation forming on the fascia panel and surrounding kitchen furniture, and drops of moisture collecting under the worktop.

Do not leave food in the oven to keep it warm if you have set the cooling fan to Time-controlled.

## Operating hours

Select *Operating hours* to query the total number of operating hours of your oven.

# Settings

---

## System lock

The system lock prevents the oven being switched on by mistake.

The minute minder can still be used when the system lock is active.

The system lock will remain activated even after a power failure.

- On  
The system lock is switched on. Before you can use the oven, touch the *OK* sensor for at least 6 seconds.
- Off  
The system lock is deactivated. You can use the oven as normal.

## Miele@home

The oven is a Miele@home compatible appliance. Your oven is fitted ex-works with a Wi-Fi communication module and is suitable for wireless communication.

There are a number of ways of connecting your oven to your Wi-Fi network. We recommend connecting your oven to your Wi-Fi network with the help of the Miele App or via WPS.

- Activate  
This setting is only visible if Miele@home is deactivated. The Wi-Fi function is reactivated.
- Deactivate  
This setting is only visible if Miele@home is activated. Miele@home remains set up, the Wi-Fi function is switched off.
- Connection status  
This setting is only visible if Miele@home is activated. The display shows information such as the Wi-Fi reception quality, network name and IP address.

- Set up again  
This setting is only visible if a Wi-Fi network has already been set up. Reset the network settings and immediately set up a new network connection.
- Reset  
This setting is only visible if a Wi-Fi network has already been set up. The Wi-Fi function is deactivated and the Wi-Fi network will be reset to the factory default. You must set up a new connection to the Wi-Fi network to be able to use Miele@home. The network settings should be reset whenever the oven is being disposed of or sold, or if a used oven is being put into operation. This is the only way to ensure that all personal data has been removed and, in the case of the latter, the previous owner will no longer be able to access the oven.
- Set up  
This setting is only visible if no connection to the Wi-Fi network has been set up yet. You must set up a new connection to the Wi-Fi network to be able to use Miele@home.



## Remote control

If you have installed the Miele App on your mobile device, have access to the Miele@home system and have activated the remote control function (On), you can set the temperature and cooking duration after selecting an oven function, retrieve information on cooking processes that are in progress or end a cooking process in progress, for instance.

The oven requires max. 2 W in networked standby.

## RemoteUpdate

The RemoteUpdate menu option is only displayed and can only be selected if the requirements for using Miele@home have been met (see “Before using for the first time – Miele@home” or “Settings”).

The RemoteUpdate function is used for updating the software in your oven. If an update is available for your oven, it will automatically download it. Updates will not be installed automatically. They must be initiated manually.

If you do not install an update, you can continue to use your oven as usual. However, Miele recommends installing updates.

## Switching on/Switching off

RemoteUpdate is switched on as standard. Available updates will be downloaded automatically and will only be installed if you initiate it.

Switch off RemoteUpdate if you do not wish any updates to be downloaded.

## Running a RemoteUpdate

Information about the content and scope of an update is provided in the Miele App.

A message will appear in your oven display if a software update is available. You can install the update immediately or postpone this until later. When the oven is switched on again, you will be reminded about the update.

Switch RemoteUpdate off if you do not wish to install updates.

The update can take several minutes.

Please note the following information about the RemoteUpdate function:

- You will only receive a message when an update is available.
- Once an update has been installed, it cannot be undone.
- Do not switch the oven off during the update. Otherwise, the update will be aborted and will not be installed.
- Some software updates can only be carried out by a Miele service technician.

# Settings

---

## Software version

The software version menu option is for use by Miele service technicians. You do not need this information for domestic use.

## Showroom programme

This function enables the oven to be demonstrated in showrooms without heating up. Do not activate this setting for domestic use.

## Demo mode

If you switch the oven on whilst it is in Demo mode, the following message will appear in the display: Demo mode is activated. The appliance will not heat up..

- On  
Touch the *OK* sensor for at least 4 seconds to activate Demo mode.
- Off  
Touch the *OK* sensor for at least 4 seconds to deactivate Demo mode.  
You can use the oven as normal.

## Factory default

- Appliance settings  
Any settings that have been altered will be reset to the factory default settings.
- Recommended temps  
Any recommended temperatures that have been changed will be reset to the factory default settings.

## Using the Min. minder function

The minute minder  can be used to time other activities in the kitchen, e.g. boiling eggs on the cooktop.

The minute minder can also be used at the same time as a cooking programme for which the start and finish times have been set (e.g. as a reminder to stir the food or add seasoning, etc.).

The maximum minute minder duration that can be set is 59:59 min.

## Setting the minute minder

Example: You want to boil some eggs and set a minute minder time of 6 minutes and 20 seconds.

- Select the  sensor.
- Select Min. minder if a cooking programme is in progress at the same time.

The prompt Set 00:00 min will appear.

- Use the rotary selector < > to enter 06:20.
- Confirm with *OK*.

The minute minder duration is now saved.

When the oven is switched off, the minute minder time counts down in the display and  appears instead of the time of day.

If you are cooking at the same time **without** a set cooking duration,  and the minute minder time will appear as soon as the selected temperature is reached.

If you are cooking at the same time **with** a set cooking duration, the minute minder will count down in the background as the cooking duration takes priority in the display.

If you are in a menu, the minute minder will count down in the background.

At the end of the minute minder duration,  will flash, a buzzer will sound and the time will start counting up to maximum 59:59 min.

- Select the  sensor.

The buzzer will stop and the symbols in the display will go out.

## Changing the time set for the minute minder

- Select the  sensor.
- Select Min. minder if a cooking programme is in progress at the same time.
- Select Change.
- Confirm with *OK*.

The minute minder time selected appears.

- Change the time set for the minute minder.
- Confirm with *OK*.













The altered minute minder time is now saved.

## Cancelling the minute minder



- Select the  sensor.
- Select Min. minder if a cooking programme is in progress at the same time.
- Select Delete.
- Confirm with *OK*.

The minute minder is now cancelled.

## Overview of functions

Oven functions	Recommended value	Range
 Fan Plus	160 °C	30–250 °C
 Intensive Bake	170 °C	50–250 °C
 Eco Fan Heat	190 °C	100–250 °C
 Other   Booster 	160 °C	100–250 °C
 Other   AirFry 	190 °C	30–250 °C
 Conventional Heat	180 °C	30–280 °C
 Full Grill	240 °C	200–300 °C
 Fan Grill	200 °C	100–260 °C
 Automatic programmes		
 Pyrolytic programme		

## Cooking programmes

- Remove any accessories from the oven that are not required for a cooking programme.
- In general, if a range of temperatures is given in a recipe or chart, it is best to select the lower temperature and to check the food after the shortest duration.
- Pre-heat the oven only if instructed to do so in the recipe or the cooking chart.
- Avoid opening the door during a cooking process.
- It is best to use dark bakeware and cooking containers with a matt finish made of non-reflective materials (enamelled steel, heat-resistant glass, non-stick coated cast aluminium). Shiny materials such as stainless steel or aluminium reflect the heat, preventing it from reaching the food efficiently. Do not cover the oven floor or the rack with heat-reflective aluminium foil.
- Monitor cooking durations to avoid wasting energy when cooking food. Set the cooking duration or use a food probe if you have one.
- The Fan Plus  function can be used for cooking many types of food. Because the fan distributes the heat in the oven compartment straight away, it allows you to use a lower temperature than you would with Conventional Heat . It also enables you to cook on several shelf levels at the same time.
- Eco Fan Heat  is an innovative function which is suitable for small amounts of food, e.g. frozen pizzas, bake-off rolls, biscuits and for meat dishes and roasts. The cooking process is energy-efficient thanks to optimal utilisation of heat. When cooking on a single level, up to 30% less energy is used with comparatively good cooking results. Do not open the door during the cooking programme.

- Fan Grill  is the best function for grilled dishes. With Fan Grill you can use lower temperatures than with other grill functions which use the maximum temperature setting.
- Whenever possible you should cook several dishes at the same time. Place them next to each other in the oven or on different shelf levels.
- Dishes which you are unable to prepare at the same time should, if possible, be cooked one after the other in order to make use of existing heat in the oven.

## Using residual heat

- The temperature in cooking programmes using temperatures above 140 °C which take longer than 30 minutes to cook can be turned down to the lowest possible temperature about 5 minutes before the end of cooking. The residual heat in the oven is sufficient for cooking the food. However, do not switch the oven off (see “Warning and safety instructions”).
- It is best to start the pyrolytic cleaning programme immediately after a cooking programme. The residual heat in the oven will help reduce the amount of energy required.

## Energy saving mode

The oven will switch itself off automatically to save energy if a programme is not being run and no controls have been operated. The time of day will appear in the display or the display will remain dark (see “Settings”).

# Operation

## Basic operation

- Place the food in the oven.
- Select the required oven function with the function selector.

The oven function is displayed briefly and then the recommended temperature will appear.

- Change the recommended temperature with the rotary selector < >, if necessary.

Otherwise the recommended temperature will be accepted within a few seconds. You can change the temperature subsequently via the < > rotary selector.

- Confirm with *OK*.

The current temperature will appear and the heating-up phase will begin.

You will see the temperature rising in the display. A buzzer will sound when the selected temperature is reached for the first time.

- When the cooking programme is finished, turn the function selector to **0**.
- Take the food out of the oven.

## Changing values and settings for a cooking programme

Depending on the function, as soon as a cooking programme is in progress, you can change the values or settings for this programme.

Depending on the function, you can change the following settings:

- Temperature
- Duration
- Finish at
- Start at

## Changing the temperature

You can permanently reset the recommended temperature to suit your cooking preferences via the ≡ | Recommended temps sensor.

- Change the temperature using the rotary selector < >.

The temperature changes in 5 °C steps.

- Confirm with *OK*.

**Useful tip:** If you have programmed a cooking duration, you first have to quit the “Cooking duration” menu by touching the ↵ sensor. You can then change the temperature using the rotary selector < >.

Then touch the ⊕ sensor to display the cooking duration again.

## Setting cooking durations

Cooking results can be adversely affected if there is a long delay between the food being placed in the oven and the start of cooking. Fresh food can change colour and even spoil.

When baking, the cake mixture or dough can dry out, and the raising agents can lose their effectiveness.

Select as short a time as possible until the start of the cooking process.

Example: You have placed the food in the oven compartment, selected a function and the required settings such as the temperature.

By entering Duration, Finish at or Start at via the ⊕ sensor, you can automatically switch the cooking programme off, or on and off.

- Duration  
Enter the required cooking duration for the food. The heating will switch off automatically once this duration has elapsed. The maximum cooking duration that can be set depends on the function that you have selected.
  - Finish at  
Specify when you want the cooking programme to finish. The oven heating will switch off automatically at the time you have set.
  - Start at  
This function will only appear in the menu if you have set a Duration or Finish at time. With Start at, you have to specify when you want the cooking programme to start. The oven heating will switch on automatically at the time you have set.
- Select the ⊕ sensor.
  - Set the required times.
  - Confirm with *OK*.
  - Touch the ↵ sensor to return to the menu of the selected function.

## Changing the set cooking durations

- Select the ⊕ sensor.
- Select the time.
- Confirm with *OK*.
- Select *Change*.
- Change the set time.
- Confirm with *OK*.
- Touch the ↵ sensor to return to the menu of the selected function.

These settings will be deleted in the event of a power failure.

## Deleting the set cooking durations

- Select the ⊕ sensor.
- Select the time.
- Confirm with *OK*.
- Select *Delete*.
- Confirm with *OK*.
- Touch the ↵ sensor to return to the menu of the selected function.

If you delete Duration, the set times for Finish at and Start at are also deleted.  
If you delete Finish at or Start at, the cooking programme will start using the cooking duration set.

## Cancelling cooking

- Turn the function selector to another oven function or to the **0** position.

Any cooking durations set will be deleted. If you have turned the function selector to the **0** position, the oven heating and lighting will also switch off.



# Operation

---

## Pre-heating the oven

The Booster function is used to quickly pre-heat the oven.

It is only necessary to pre-heat the oven in a few instances.

- Most dishes can be placed in a cold oven. They will then make use of the heat produced during the heating-up phase.
- Pre-heat the oven for the following preparations and oven functions:
  - Dark bread dough and beef sirloin joints and fillet with the Fan Plus  and Conventional Heat  functions
  - Cakes and pastries with a short cooking duration (up to approx. 30 minutes) and delicate items (e.g. sponge) with the Conventional Heat  function

## Rapid Heat-up

You can shorten the heating-up phase with the Booster  function.

Do not use the Booster  function to pre-heat the oven when baking pizzas or delicate mixtures (e.g. sponge cake, biscuits). This food will otherwise brown too quickly from the top.

- Use the function selector to select  Other.
- Confirm **Booster** ✓ with *OK*.
- Select the temperature.
- Change to the required oven function after the set temperature has been reached.
- Place the food in the oven.



## Using Automatic programmes

The Automatic programmes enable you to achieve excellent results with ease.

Please refer to "Automatic programmes Recipes" at the end of the operating and installation instructions.

- Select Automatic programmes .

A list will appear.

- Select the Automatic programme that you want to use.
- Confirm with *OK*.
- Follow the instructions in the display.

## Usage notes

- When using Automatic programmes, the recipes provided are designed as a guide only. For optimum cooking results, we recommend using the quantities and accessories given in the recipes.
- To find the correct shelf level, please remove the FlexiClip telescopic runners HFC 70-C before starting an Automatic programme.
- After cooking, allow the oven compartment to cool down to room temperature again before starting an Automatic programme.
- Some Automatic programmes require a pre-heating phase before food can be placed in the oven. An appropriate message will appear in the display.

# Baking

Handling food carefully will help protect your health.  
Cakes, pizzas and chips should be cooked until golden, not dark brown.

## Tips on baking

- Set a cooking duration. When baking, the oven should not be set to start a long time off. Otherwise the cake mixture or dough will dry out, and the raising agents will lose their effectiveness.
- Generally, you can use the rack, baking tray, universal tray and any type of baking tray made of heat-resistant material.
- Avoid using bright, thin-walled tins as they give an uneven or poor browning result. In certain unfavourable conditions, the food will not cook properly.
- Place cakes in rectangular tins on the rack with the longer side across the width of the oven for optimum heat distribution and even results.
- Always place bakeware on the rack.
- Bake cakes with fruit toppings or deep cakes on the universal tray.

## Using baking paper

Miele accessories, e.g. the universal tray, are treated with PerfectClean enamel (see “Features”). Surfaces treated with PerfectClean enamel generally do not need to be greased or covered with baking paper.

- Use baking paper when baking lye pastries (e.g. pretzels) because the sodium hydroxide can damage the PerfectClean treated surface.
- Use baking paper when baking sponge, meringue, macaroons or similar items. These are more likely to stick due to their high egg white content.
- Use baking paper when cooking frozen food on the rack.

## Notes on the cooking charts

You can find the cooking charts at the end of this book.

## Selecting the temperature

- As a general rule, select the lower temperature given in the chart. Baking at temperatures higher than those recommended may reduce the cooking duration, but will lead to uneven browning of the food, and unsatisfactory cooking results.

## Selecting the cooking duration

Unless otherwise stated, the cooking durations given in the cooking charts are for an oven compartment which has not been pre-heated. With a pre-heated oven compartment, shorten durations by around 10 minutes.

- As a general rule, check whether the food is cooked after the shortest duration. Stick a wooden skewer into the food.

If it comes out clean without any batter/dough on it, the food is done.

## Notes on the oven functions

You can find an overview of all the functions with their recommended values in "Overview of functions".

### Using Automatic programmes

- Follow the instructions in the display.

### Using Fan Plus

Because the fan distributes the heat around the oven compartment straight away, you can use a lower temperature than you would with the Conventional Heat  function.

Use this function if you are baking on multiple shelf levels at the same time.

- 1 shelf: Place the food on shelf level 2.
- 2 shelves: Place the food on shelf levels 1+3 or 2+4.
- 3 shelves: Place the food on shelf levels 1+3+5.

## Useful tips

- If you are cooking on multiple shelf levels at the same time, slide the universal tray in on the lowest level.
- For moist biscuits and cakes, bake on a maximum of 2 shelf levels at once.

### Using Intensive Bake

Use this function for baking cakes with moist toppings.

Do **not** use this function for baking thin biscuits.

- Place cakes on shelf level 1 or 2.

### Using Conventional Heat

Dark metal, enamel, or aluminium bakeware with a matt finish, as well as heat-resistant glass, ceramic, and coated bakeware can be used.

Use this function for baking traditional recipes. If using an older recipe or cookbook, set the oven temperature 10 °C lower than that recommended. This will not change the cooking duration.

- Place the food on shelf level 1 or 2.

### Using Eco Fan Heat

Use this function for cooking small amounts of food, e.g. frozen pizzas, bake-off rolls or biscuits, while saving energy.

- Place the food on shelf level 2.

# Roasting

---

## Tips for roasting

- You can use any crockery made from temperature-resistant materials, e.g. oven dishes, roasting pans with lid, ovenproof glass dishes, roasting bags, dishes made from earthenware or cast iron, the universal tray, rack and/or grilling and roasting insert (if present) on top of the universal tray.
- **Pre-heating** the oven compartment is only required when roasting beef sirloin joints and fillet. Pre-heating is generally not necessary.
- Use a **closed roasting dish** for roasting meat, such as an oven dish. The meat stays succulent. The oven compartment will also stay cleaner than when roasting on the rack. It ensures that sufficient stock remains for making gravy.
- If you are using a **roasting bag**, follow the instructions on the packaging.
- If you are using the **rack** or an **open roasting dish** for roasting, you can add a little fat or oil to very lean meat or place a few strips of streaky bacon on the top.
- **Season** the meat and place in the roasting dish. Dot with butter or margarine or brush with oil or cooking fat if necessary. For large lean cuts of meat (2–3 kg) and fatty poultry, add about 1/8 l of water to the dish.
- Do not add too much liquid during cooking as this will hinder the **browning** of the meat. Browning only occurs towards the end of the cooking duration. Remove the lid about halfway through the cooking duration if a more intensive browning result is desired.



- At the end of the programme, take the food out of the oven compartment, cover it and leave to **stand** for about 10 minutes. This helps retain juices when the meat is carved.
- For a crisp finish, baste **poultry** 10 minutes before the end of the cooking duration with slightly salted water.

## Notes on the cooking charts

You can find the cooking charts at the end of this book.

- Take note of the temperature range, the shelf levels and the timings. These also take the type of cooking container, the size of the meat and cooking practices into account.

## Selecting the temperature

- As a general rule, select the lower temperature given in the chart. If higher temperatures are used than those specified, the meat will brown on the outside, but will not be properly cooked through.
- When cooking with Fan Plus , select a temperature 20 °C lower than when using Conventional Heat .
- For cuts which weigh more than 3 kg, select a temperature approx. 10 °C lower than that given in the cooking chart. The roasting process will take longer, but the meat will cook evenly through and the skin or crackling will not be too thick.
- When roasting on the rack, set a temperature approx. 10 °C lower than for roasting in a covered oven dish.

## Selecting the cooking duration

Unless otherwise stated, the durations given in the cooking chart are for an oven compartment which has not been pre-heated.

- Determine the cooking duration by multiplying the thickness of the roast [cm] with the time per cm [min./cm] stated below, depending on the type of meat:
  - Beef/Venison: 15–18 min./cm
  - Pork/Veal/Lamb: 12–15 min./cm
  - Sirloin joints/Fillets: 8–10 min./cm
- As a general rule, check whether the food is cooked after the shortest duration.

## Notes on the oven functions

You can find an overview of all the functions with their recommended values in “Overview of functions”.



### Using Automatic programmes

- Follow the instructions in the display.

Do not use the Intensive Bake  function for roasting as the juices will become too dark.

### Using Fan Plus

This function is suitable for roasting meat, fish and poultry that needs to be well browned as well as sirloin joints and fillet.

The Fan Plus  function allows you to use a lower temperature than you would with the Conventional Heat  function, because the heat is immediately distributed throughout the oven compartment.

- Place the food on shelf level 2.

### Using Conventional Heat

Use this function for baking traditional recipes. If using an older recipe or cookbook, set the oven temperature 10 °C lower than that recommended. This will not change the cooking duration.

- Place the food on shelf level 2.

### Using Eco Fan Heat

Use this function for cooking smaller roasts or meat dishes in an energy-saving way.

- Place the food on shelf level 2.

# Grilling

 Risk of injury caused by hot surfaces.

If you grill with the door open, hot air will escape from the oven instead of being cooled by the cooling fan. The control elements will get hot.

Grill with the oven door closed.

## Tips for grilling

- Pre-heating is necessary when grilling. Pre-heat the top heat/grill element for approx. 5 minutes with the door closed.
- Trim the meat if necessary. Season meat 10-15 minutes before cooking.
- Add a little oil to lean meat if necessary. Do not use other types of fat as they can easily burn and cause smoke.
- Clean fish in the normal way. To enhance the flavour, season with a little salt. Fish can also be drizzled with lemon juice.
- Use the universal tray with the rack or the grilling and roasting insert (if present) placed on top. The tray under the insert will collect the meat juices and stop them from burning so that they can be used for making gravy and sauces. To grill, brush the rack or the grilling and roasting insert with oil and then place the food on the rack.

Do not use the baking tray.

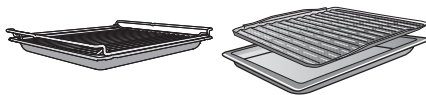

## Notes on the cooking charts

You can find the cooking charts at the end of this book.

- Take note of the temperature range, the shelf levels and the timings. These take the size of the meat and cooking practices into account.
- Check the food after the shortest duration quoted.

## Selecting the temperature

- As a general rule, select the lower temperature given in the chart. If higher temperatures than those specified are used, the meat will brown on the outside, but will not be properly cooked through.

## Choosing a shelf level

- Select the shelf level depending on the thickness of the food to be cooked.
- Place flat food on shelf level 3 or 4.
- Place thicker food on shelf level 1 or 2.

## Selecting the cooking duration

- Grill thinner cuts of meat/slices of fish for approx. 6–8 minutes per side. It is best to grill food of a similar thickness at the same time so that the cooking durations do not vary too much.
  - As a general rule, check whether the food is cooked after the shortest duration.
  - To **test the food**, press down on the meat with a spoon. This lets you determine how well the meat has been cooked.
- **Rare**  
If the meat gives easily to the pressure of the spoon, it will still be red on the inside.
  - **Medium**  
If there is some resistance, the inside will be pink.
  - **Well-done**  
If there is great resistance, it is cooked through.

**Useful tip:** If the surface of a thicker cut of meat is browned but the centre is still raw, move the food to a lower level or reduce the temperature and continue grilling. This will stop the surface from becoming excessively charred.

## Notes on the oven functions

You can find an overview of all the functions with their recommended values in “Overview of functions”.

### Using Full Grill

Use this function to grill flat thin cuts in large quantities and for browning large baked dishes.

The entire top heat/grill element will get hot and glow red.



### Using Fan Grill

This function is suitable for grilling thicker food, such as chicken.



A temperature setting of 220 °C is generally recommended for thinner types of food, while 180–200 °C is recommended for thicker cuts.



# Grilling

## Fan Grill

- Use the Fan Grill  function for meat, fish, poultry and vegetables.
- Always pre-heat for at least 5 minutes before Fan Grilling.
- It is not necessary to turn food when Fan Grilling . Only one side of the food, however, will become brown.
- The door must be closed when using Fan Grill .
- When using red meat, pat the meat dry before Fan Grilling as this encourages a richer colour.

All temperatures are approximations and must be varied according to the thickness and preparation of the meat. The chart below is a suggested guide only. Personal taste and size of serves will vary times and temperatures. We recommend you monitor cooking results for best outcomes.

Food to be grilled	 [°C]	 5 1	 [min.]
Lean thin sausages	180	4	8–10
Thick sausages	180	4	15–20
Lean beef fillet steak	220	5	6–12
Chicken breast fillet	200	4	14–18
Whole butterflied chicken	200	3	30–35
Thin white fish fillets	220	5	6–10
Thick fish fillets, cutlets or steaks	200	4	10–15
Oily fish	200	4	8–12
Lamb loin chops	190	4	12–16
Lamb back straps	220	5	8–10
Vegetables, capsicum, zucchini, sweet potato, eggplant	200	5	12–15
Potato wedges or small roast potatoes	220	3	20–25
Kebabs and satays (red meat)	200	5	12–15
Chicken satays	200	4	12–15

 Temperature /  Shelf level /  Duration

Fan Grill  can be used for small roasts but is only recommended for lean, tender cuts of meat, e.g. lamb racks, rump roasts, and beef fillet. Fan Grill the roast at 200 °C on shelf level 3 for approximately 25 minutes, depending on thickness.



## Grill

- Use Grill  for thick toasts, muffins, cheese on toast, focaccia, bruschetta and bacon.
- Pre-heat the grill for at least 5 minutes at 200–220 °C.
- Select the appropriate shelf level for the thickness of the food.
- The door must be closed when using the Grill function.

This is a suggested guide only. Personal taste and size of serves will vary times and temperatures.

# AirFry

Handling food carefully will help protect your health.

Chips and similar foods should be cooked until golden, not dark brown.

Food is fried in hot air using the AirFry  function. AirFrying is a gentle cooking method and achieves an even, crispy cooking result.

AirFrying is therefore particularly suited to preparing frozen foods such as chips, croquettes and the like.

You can also find a number of usage possibilities in "AirFry Recipes", as well as in the "Savoury snacks" and "Poultry, fish" cooking charts.

## Accessories

- Use the Gourmet baking and AirFry tray for **food which does not contain liquid**, e.g. chips.

The food is browned and crisped on all sides by way of the small perforations of the Gourmet baking and AirFry tray.

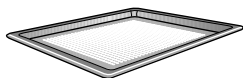

- For **food containing liquid or fat**, e.g. chicken thighs, use the universal tray with the grilling and roasting insert (if present) placed on top. The tray under the insert will collect the meat juices and stop them from burning so that they can be used for making gravy and sauces. Brush the grilling and roasting insert with oil and then place the food on top.

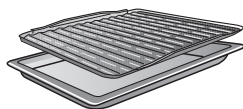

- Always place food in bakeware in the centre of the rack.

## Tips for AirFrying

- Do not defrost frozen food.
- Distribute the food evenly and in a single layer over the perforated Gourmet baking and AirFry tray or the grilling and roasting insert.
- Place the food in the cold oven. If the cooking result is not crispy enough, you can pre-heat the oven compartment next time.
- Only cook on one level. When cooking on several shelf levels, the moisture in the oven compartment becomes too high and the food does not become crispy.
- In general, place the food on shelf level 2. If you want more browning on top, you can use a higher shelf level next time.
- If possible, turn the food, e.g. chips, halfway through the cooking duration. Set a minute minder to remind you when to do so.

## Using the AirFry function

- Distribute the food evenly and in a single layer over the perforated Gourmet baking and AirFry tray or the grilling and roasting insert.
- Place the food on shelf level 2.
- Use the function selector to select  Other.
- Use the rotary selector to select AirFry.
- Confirm with *OK*.

The recommended temperature will appear.

- Change the recommended temperature according to the information in the recipe or the cooking chart.
- At the end of the cooking duration, check whether the food is crispy and brown enough.

This section provides information on the following applications:

- Defrost
- Low temperature cooking
- Bottling
- Drying
- Frozen food/Ready meals
- Heating crockery

### Defrost

Gentle defrosting of frozen goods means that the vitamins and minerals are generally retained.

- Select the Fan Plus  function and a temperature of 30–50 °C.

Air is circulated throughout the oven compartment to gently defrost the frozen food.

 Risk of infection from bacteria.

Bacteria such as salmonella can cause life-threatening food poisoning. It is particularly important to observe food hygiene rules when defrosting fish and meat, and in particular when defrosting poultry.

Do not use the liquid produced during defrosting.

Process the food as required as soon as it has been defrosted.

### Useful tips

- Remove the packaging and place the frozen goods on the universal tray or in a suitable bowl or dish.
- Use the universal tray with the rack placed on top of it for defrosting poultry. This way the frozen food will not be lying in the defrosting liquid.
- Meat and poultry need to be fully defrosted before cooking. Fish, on the other hand, can be partially defrosted before cooking. Defrost so that the surface is sufficiently soft to take herbs and seasoning.

### Low temperature cooking

Low temperature cooking is ideal for cooking delicate cuts of beef, pork, veal or lamb when a tender result is desired.

First briefly sear the meat all over at a high temperature on the cooktop in order to seal it.

Then place the meat in the pre-heated oven where the low temperature and long cooking duration will cook it to perfection and ensure it is very tender.

The meat will relax. The juices inside will start to circulate evenly throughout the meat to reach the outer layers.

This gives very tender and succulent results.

- Use lean meat which has been correctly hung and trimmed. Bones should be removed before cooking.
- For searing, use a suitable cooking oil or fat that can withstand high temperatures (e.g. clarified butter, vegetable oil).
- Do not cover meat during the cooking process.

The cooking duration takes approx. 2–4 hours depending on the weight and size of the meat and how well you want it cooked.

- As soon as the cooking programme has finished, you can carve the meat straight from the oven. It does not need to rest.
- The meat can be left in the oven compartment to keep warm until you serve it. This will not affect results in any way.
- Serve on pre-heated plates with very hot sauce or gravy to prevent it cooling down too quickly. The meat is at the ideal temperature for eating straight away.

## Other applications

### Using Conventional Heat

Refer to the information in the cooking charts at the end of this booklet.

Use the universal tray with the rack placed on top of it.

- Place the rack together with the universal tray on shelf level 2.
- Select the Conventional Heat  function and a temperature of 120 °C.
- Pre-heat the oven together with the universal tray and rack for approx. 15 minutes.
- While the oven is pre-heating, sear the meat on all sides on the cooktop.

 Risk of burning due to hot surfaces!

The oven gets hot during operation. You could burn yourself on the heating elements, the oven compartment, food or accessories. Wear oven gloves when placing food in the oven or removing it, and when adjusting oven shelves etc. in a hot oven.

- Place the seared meat on the oven rack.
- Reduce the temperature to 100 °C (see “Cooking charts”).
- Continue cooking until the end of the programme.

### Bottling

 Risk of infection from bacteria.

The spores of the botulinum bacterium are not sufficiently killed by bottling pulses and meat only once. Toxins may form which can lead to serious poisoning. These spores are only destroyed by reheating the food within 2 days after preserving.

After they have cooled down, **always** reheat pulses and meat a second time within 2 days.

 Risk of injury from increased pressure in sealed tins.

Preserving and heating food in sealed tins will result in an increase in pressure, which can cause them to explode.

Do not use tins for preserving or heating food.

### Preparing fruit and vegetables

The instructions are for 6 jars with a capacity of 1 litre each.

Only use special jars for preserving (preserving jars or jars with a screw cap). Only use undamaged jars and rubber rings.

- Rinse the jars with hot water before bottling and fill them up to a maximum of 2 cm below the rim.
- After you have filled the jars with the produce, clean the glass rims with a clean cloth and hot water and then seal the jars.
- Place the universal tray on shelf level 2 and place the closed jars on the tray.

- Select the Fan Plus  function and a temperature of 160–170 °C.
- Wait until bubbles evenly rise in the jars.



Reduce the temperature in time to prevent the contents from boiling over.

## Bottling fruit and gherkins

- Set the specified continued warming temperature as soon as bubbles are visible in the jars, then leave the jars in the warm oven for the time specified.

## Bottling vegetables

- As soon as bubbles are visible in the jars, set the specified bottling temperature and cook the vegetables for the time specified.
- After bottling, set the specified continued warming temperature, then leave the jars in the warm oven for the time specified.

		
Fruit	—/—	30 °C 25–35 min.
Gherkins	—/—	30 °C 25–30 min.
Beetroot	120 °C 30–40 min.	30 °C 25–30 min.
Beans (green or yellow)	120 °C 90–120 min.	30 °C 25–30 min.

 Bottling temperature and time once bubbles are visible in the jars

 Continued warming temperature and time

## Removing the jars after bottling

 Risk of injury caused by hot surfaces.

The jars are very hot after bottling. Wear oven gloves when removing the jars from the oven.

- Take the jars out of the oven.
- Cover the jars with a towel and leave for approx. 24 hours in a draught-free area.
- After they have cooled down, **always** reheat pulses and meat a second time within 2 days.
- Remove the fasteners from the jars and make sure all jars are closed properly when storing them.

Either boil open jars again or store them in a cool place and consume the preserved fruit or vegetables immediately.

- Check the jars during storage. If jars have opened during storage or if the screw cap is bulging and does not make a popping noise when opened, destroy the contents.

## Other applications

### Drying

Drying is a traditional method of preserving fruit, certain vegetables and herbs.





It is important that fruit and vegetables are ripe and not bruised before they are dried.



- Prepare the food for drying by cutting it up, and peeling and coring it if necessary.
- Distribute the food for drying evenly in a single layer according to size over the rack or the universal tray.

**Useful tip:** You can also use the perforated Gourmet baking and AirFry tray, if you have one.

- Dry on a maximum of 2 levels at the same time.  
Place the food for drying on shelf levels 1+3.  
If using the rack and universal tray, place the universal tray below the rack.
- Select Fan Plus .
- Change the recommended temperature and set the drying time.
- Turn the food for drying on the universal tray at regular intervals.

The drying times are longer for whole or halved dried food.

Food		🌡️ [°C]	🕒 [h]
Fruit		60–70	2–8
Vegetables		55–65	4–12
Mushrooms		45–50	5–10
Herbs*		30–35	4–8

 Function, 🌡️ Temperature, 🕒 Drying time,  
 Fan Plus,  Conventional Heat

\* Dry herbs only on the universal tray on shelf level 2 and use the Conventional Heat  function, as the fan is switched on in the Fan Plus function.

- Reduce the temperature if condensation begins to form in the oven.

### Removing the dried food

 Risk of injury caused by hot surfaces.

The oven gets hot during operation. You could burn yourself on the heating elements, the oven compartment, or accessories. Use oven gloves when removing dried food from the oven.

- Allow the dried fruit or vegetables to cool down after drying.

Dried fruit needs to be completely dry, but also soft and elastic. Juice should not escape when cut.

- Store dried food in sealed glass jars or tins.

### Frozen food/Ready meals

#### Tips for oven chips, croquettes and similar items

Prepare these frozen goods using the AirFry  function (see "AirFry").

#### Tips for cakes, pizza and baguettes

- Bake cakes, pizza and baguettes on baking paper on the rack. Do not use the baking tray or the universal tray for frozen foods with a large surface area. The tray could become warped and difficult, or even impossible, to remove from the oven compartment when hot. Additional use will make the warping worse.
- Use the lowest temperature recommended on the packaging.

#### Preparing frozen food/ready meals

Handling food carefully will help protect your health.

Cakes, pizzas and chips should be cooked until golden, not dark brown.

- Select the function and temperature recommended on the manufacturer's packaging.
- Pre-heat the oven.
- Place the food in the pre-heated oven on the shelf level recommended on the packaging.
- Check the food at the end of the shortest cooking duration recommended on the packaging.

### Heat crockery

Use the Fan Plus  function for pre-heating crockery.

Only pre-heat heat-resistant dishes.

- Place the rack on shelf level 1 and place the crockery to be pre-heated on it. Depending on the size of the dishes, you can also place them on the oven floor and take out the shelf runners to make more room.
- Select Fan Plus .
- Set the temperature to 50–80 °C.

 Danger of burning!

Wear oven gloves when removing dishes from the oven. Droplets of water may have accumulated underneath the crockery.

- Remove the heated crockery from the oven.

# Cleaning and care

 Risk of injury caused by hot surfaces.

The oven gets hot during operation. You could burn yourself on the heating elements, the oven compartment, or accessories. Allow the heating elements, oven compartment and the accessories to cool before manual cleaning.

 Risk of injury due to electric shock.

The steam from a steam cleaning appliance could reach electrical components and cause a short circuit. Never use a steam cleaner for cleaning the oven.

The use of unsuitable cleaning agents can cause the surfaces to discolour or alter. The oven front is particularly susceptible to damage from oven cleaners or descaling agents. All surfaces of this appliance are susceptible to scratching. Scratches on glass surfaces could cause a breakage in certain circumstances. Remove all cleaning agent residues immediately.

## Unsuitable cleaning agents

To avoid damaging the surfaces of your appliance, do not use:

- cleaning agents containing soda, alkalines, ammonia, acids or chlorides
- cleaning agents containing descaling agents on the front
- abrasive cleaning agents, e.g. powder cleaners and cream cleaners
- solvent-based cleaning agents
- stainless steel cleaning agents
- dishwasher cleaners
- glass cleaning agents

- cleaning agents for ceramic cooktops
- hard, abrasive brushes or sponges, e.g. pot scourers, brushes or sponges which have been previously used with abrasive cleaning agents
- dirt eraser sponges
- sharp metal scrapers
- steel wool or metal scourers
- spot cleaning with mechanical cleaning agents
- oven cleaner
- stainless-steel spiral pads

If soiling is left on for any length of time, it may become impossible to remove. Continued use without regular cleaning will make the oven much harder to clean. Failure to maintain the oven in a clean condition could lead to deterioration of the surfaces that could adversely affect the life of the appliance and result in a hazardous situation. Remove any soiling immediately.

The accessories are not dishwasher-safe.

**Useful tip:** Soiling caused by spilled fruit juices and cake mixtures is best removed while the oven is still warm. Exercise caution and make sure the oven is not too hot.

To make it easier to clean the oven:

- Remove the door.
- You can remove the shelf runners together with the FlexiClip telescopic runners (if present).

## Removing normal soiling

The fibreglass seal around the front of the oven should be handled carefully. Do not rub and scour it. Ideally, you should avoid cleaning it.



## Removing normal soiling

- It is best to remove normal soiling immediately using a clean sponge and a solution of hot water and washing-up liquid, or a clean, damp microfibre cloth.
- Remove any residual cleaning agent thoroughly with clean water. This is particularly important for any parts with a PerfectClean finish, as cleaning agent residues will impair the non-stick properties.
- After cleaning, wipe the surfaces dry using a soft cloth.

## Removing stubborn soiling (excluding the FlexiClip telescopic runners)

Spilled fruit and roasting juices may cause lasting discolouration or matt patches on surfaces. This discolouration will not affect the functional characteristics of the surface finish.

Do not attempt to remove these marks. Clean them following the instructions given here.

- Baked-on deposits can be removed with a glass scraper or with a stainless steel spiral pad, hot water and washing-up liquid.

## Using oven cleaners

- Very stubborn soiling on PerfectClean surfaces can be cleaned using Miele Oven Cleaner. This cleaner must only be applied to cold surfaces.

If the oven spray gets into gaps and openings, a strong odour is generated during subsequent cooking programmes.

Do not spray the oven cleaner onto the roof of the oven compartment.

Do not spray the oven cleaner into the gaps and openings of the oven compartment walls and rear wall.

- Follow the instructions on the packaging.

Oven cleaners from other manufacturers must only be used in a cold oven and must not be left on for longer than 10 minutes.

- If necessary, the scouring pad on the back of a non-scratching washing-up sponge can be used to remove the soiling after the soaking time.
- Remove any residual cleaning agent thoroughly with clean water.
- Dry all surfaces with a soft cloth.

## Stubborn soiling on the FlexiClip telescopic runners

Do not clean the FlexiClip telescopic runners in a dishwasher. The special lubricant used in the telescopic runners will wash out during dishwashing.

This will impair their smooth functioning.

For stubborn surface soiling or if the bearings become sticky, proceed as follows:

- Soak the FlexiClip telescopic runners briefly (approx. 10 minutes) in a solution of hot water and dishwashing liquid.  
If necessary, the scouring pad on the

# Cleaning and care

back of a non-scratching dishwashing sponge can be used to remove the soiling. You can clean the bearings with a soft brush.

The runners may appear discoloured or a lighter colour in places after they have been cleaned. This will not affect the functioning of the runners in any way.

## Pyrolytic programme cleaning

Instead of cleaning the oven compartment manually you can run the Pyrolytic programme  function.

During Pyrolytic cleaning the oven compartment reaches temperatures in excess of 400 °C. Any residual soiling is burnt off and turned to ash by the high temperatures.

There are 3 Pyrolytic settings available, each with a different duration.

- Level 1 for light soiling
- Level 2 for heavier soiling
- Level 3 for very heavy soiling

The oven door is automatically locked when the Pyrolytic cleaning process is started. It cannot be opened until after the programme has finished.

The timer can be used to delay the start time of the Pyrolytic cleaning programme, for instance to make use of cheaper electricity tariffs.

At the end of the Pyrolytic cleaning programme any residues such as ash from the pyrolytic process, which are formed depending on the oven compartment's degree of soiling, can be easily wiped away.

## Preparing for pyrolytic cleaning

Accessories that are not suitable for pyrolytic cleaning will be damaged by the high temperatures.

Remove all accessories that are not suitable for pyrolytic cleaning from the oven compartment before starting the Pyrolytic cleaning programme. This also applies to the shelf runners and any optional accessories.

Coarse soiling in the oven compartment can cause thick smoke to develop.

Burnt-on residues can leave lasting discolouration or matt patches on enamelled surfaces.

Before starting the Pyrolytic cleaning programme, remove coarse soiling from the oven compartment and scrape any burnt-on residues off enamelled surfaces with a glass scraper.

- Remove all accessories from the oven compartment, including the shelf runners.

## Starting pyrolytic cleaning

 Risk of injury caused by hazardous steam.

During pyrolytic cleaning, steam, which can irritate mucous membranes, may be released.

During pyrolytic cleaning, do not stay in the kitchen for longer periods of time and do not let children and pets enter the kitchen.

It is important to ensure that the kitchen is well ventilated during pyrolytic cleaning. Prevent odours from escaping into other rooms.

 Risk of injury caused by hot surfaces.

The oven gets much hotter during pyrolytic cleaning than during normal use.

Do not let children touch the oven during pyrolytic cleaning.

- Select Pyrolytic programme .
- Select the level required according to the amount of soiling.
- Confirm with *OK*.

Follow the instructions in the display.

- Confirm with *OK*.

You can start pyrolytic cleaning straight away or schedule it to begin at a later time.

### Starting pyrolytic cleaning straight away

- To start the pyrolytic cleaning programme straight away, select *Start now*.
- Confirm with *OK*.

The pyrolytic cleaning programme will start.

The door will lock automatically. The oven heating and the cooling fan will switch on automatically.

The oven interior lighting will not come on during pyrolytic cleaning.

The time left for the pyrolytic cleaning programme will start counting down in the display. It cannot be changed.

You can use the minute minder at the same time as running the cleaning programme. At the end of the minute minder time the buzzer will sound,  will start flashing and the time can be

viewed counting up in the display. When you touch the  sensor, the acoustic and optical signals will switch off.

### Starting pyrolytic cleaning at a later time

- To start the pyrolytic cleaning programme later, select *Start at*.
- Confirm with *OK*.
- Set the time at which you want the pyrolytic cleaning programme to start.
- Confirm with *OK*.

The door will lock automatically. *Start at* and the set start time will appear in the display.

You can reset the start time via the  sensor at any point up to the starting time.

As soon as the start time is reached, the oven heating and the cooling fan will switch on automatically. The remaining duration of the programme will appear in the display.

### Finalising pyrolytic cleaning

When the time remaining has counted down to 0:00 h, a message will appear in the display to tell you that the door is unlocking.

*Process finished* will appear in the display and a buzzer will sound as soon as the door has been unlocked.

- Switch the oven off.

The visual and acoustic signals will switch off.

## Cleaning and care

 Risk of injury caused by hot surfaces.

At the end of the Pyrolytic cleaning programme, the oven will still be very hot. You could burn yourself on the heating elements and the oven interior.

Allow the heating elements and the oven compartment temperature to drop to a safe level before removing any residues.

- Clean the oven compartment to remove any pyrolytic residues (e.g. ash) that may have built up depending on the degree of soiling in the oven.

Most residues can be removed with warm water, a little washing-up liquid and a clean sponge or a clean, damp microfibre cloth.

Depending on the level of soiling, a visible deposit can build up on the glass on the inside of the oven door. This can be removed with a dishwashing sponge, a glass scraper or a stainless steel spiral pad and a little washing-up liquid.

The fibreglass seal around the front of the oven should be handled carefully. Do not rub and scour it. Ideally, you should avoid cleaning it.

Enamelled surfaces can be permanently discoloured by spilled fruit juice. Such discolouration does not affect the properties of the enamel.

Do not attempt to remove these marks.

### Pyrolytic cleaning interrupted

If pyrolytic cleaning is cancelled, the oven door will remain locked until the temperature inside the oven drops to below 280 °C.

The following events will cause the pyrolytic cleaning programme to stop:

- The function selector is turned to a different function or to the **O** position.  
Turn the function selector to Pyrolytic cleaning  again if you want to restart the pyrolytic cleaning programme.
- Turn the function selector to a different oven function.

Before you can use another oven function, the oven temperature must have fallen below 280 °C. During this time, **Cooling down** will appear in the display.

- A power cut.

When power is restored, **Process cancelled** will appear until the oven compartment temperature has fallen below 280 °C. The door is then unlocked.

- Confirm with **OK** if you want to start the pyrolytic cleaning programme again. Then you can select the pyrolytic cleaning programme you want and start it again.

## Removing the door

The door weighs approx. 10 kg.



The oven door is connected to the hinges by retainers. Before removing the door from the retainers, the locking clamps on both hinges have to be released.

- Open the door fully.

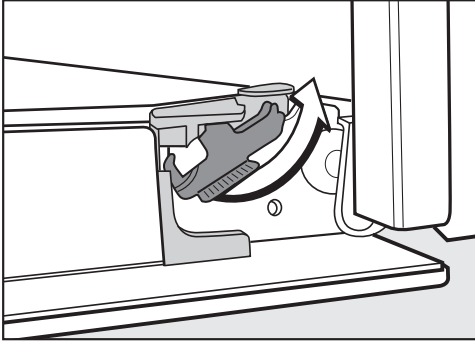

- Release the locking clamps by turning them as far as they will go.

The oven can be damaged if you remove the door incorrectly.

Do not pull the door horizontally off its retainers, as they will spring back against the oven.

Do not pull the door off the retainers by the handle, as the handle could break off.

- Raise the door up till it rests partially open.

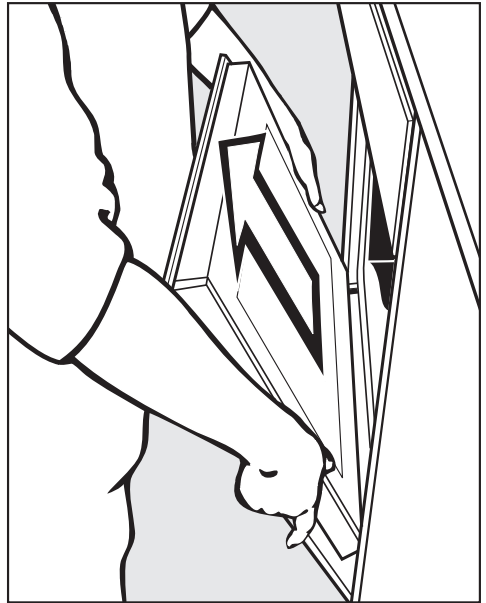

- Hold the door on either side and pull it diagonally upwards from the hinge guides. Make sure that the door is straight.

# Cleaning and care

## Dismantling the door

The oven door is an open system with 4 glass panes which have a heat-reflective coating on some of their surfaces.

When the oven is operating, air is directed through the door to keep the outer pane cool.

If soiling has worked its way in between the glass panes, the door can be dismantled in order to clean in between the panes.

Scratches on the door glass can cause the glass to break.

Do not use abrasive cleaners, hard sponges, brushes or sharp metal tools to clean the door glass.

When cleaning the door glass, you must also follow the instructions that apply to the oven front.

The different sides of the door glass have different coatings. The sides facing the oven compartment have heat-reflecting properties.

The oven will be damaged if you fit the door glass the wrong way round. Make sure that you place the door glass back in the right position after cleaning.

Oven cleaners will damage the surface of the aluminium profiles.

Only clean these parts with warm water and washing-up liquid applied with a clean sponge, or with a clean, damp microfibre cloth.

The door glass panes can break if dropped.

Keep the disassembled door glass in a safe place.

 Risk of injury caused by the door slamming shut.

The door may slam shut if you attempt to disassemble it when it is fitted to the oven.

Always remove the door before disassembling it.

- Place the door with the outer glass pane on a soft surface (e.g. a tea towel) to prevent it getting scratched. The door handle should line up with the edge of the table so that the glass lies flat and does not get broken during cleaning.

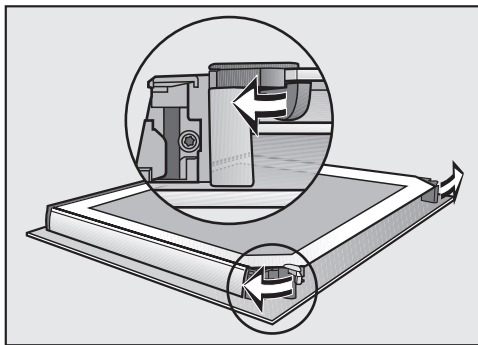

- Flip the two glass pane retainers outwards to open them. You can now remove the inner pane and the two middle panes one after the other.

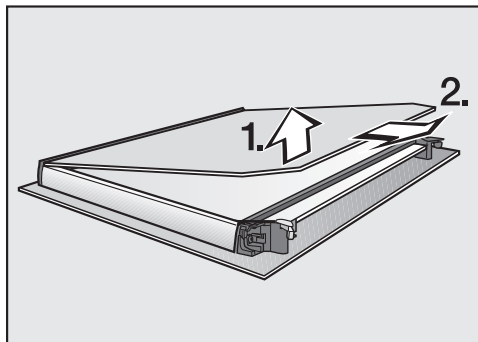

- Gently lift the inner pane up and out of the plastic strip.

## Cleaning and care

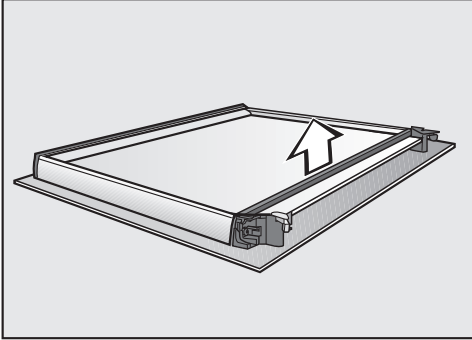

- Remove the seal.

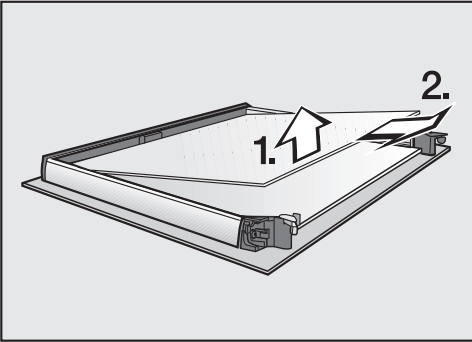

- Gently lift the top of the two middle panes up and take it out.

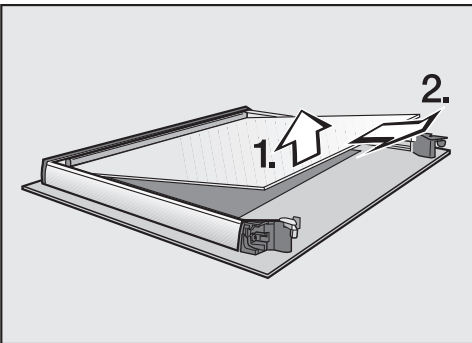

- Then lift the bottom of the two middle panes up carefully and take it out.

- Clean the door panes and other individual parts with a clean sponge and a solution of hot water and washing-up liquid or a clean, damp microfibre cloth.
- Dry all parts with a soft cloth.

Then reassemble the door carefully.

The two middle panes are identical. To help you put them back in correctly, the material number is printed on the panes.

- Refit the lower of the two middle panes in such a way that the material number is legible (i.e. not reversed).

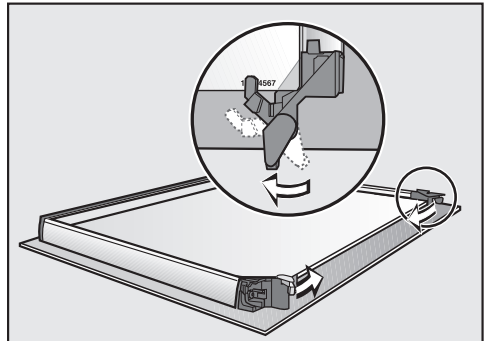

- Flip the glass pane retainers inwards in such a way that they fit over the lower of the two middle panes.
- Refit the upper of the two middle panes in such a way that the material number is legible (i.e. not reversed). The pane must rest on the retainers.

## Cleaning and care

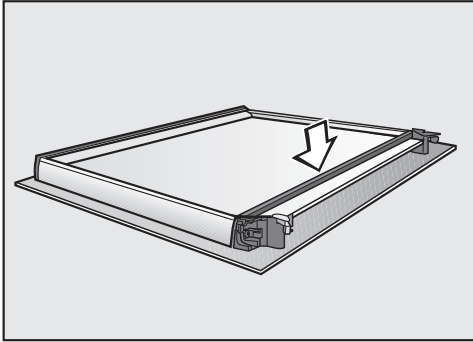

- Refit the seal.

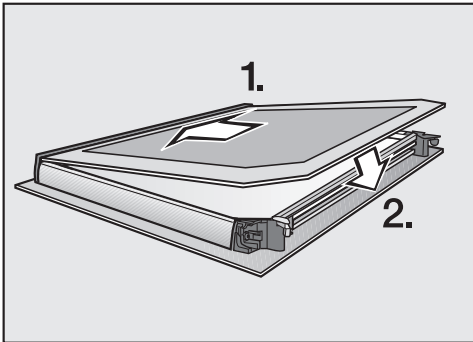

- Push the inner pane with the matt printed side facing downwards into the plastic strip and place it between the retainers.

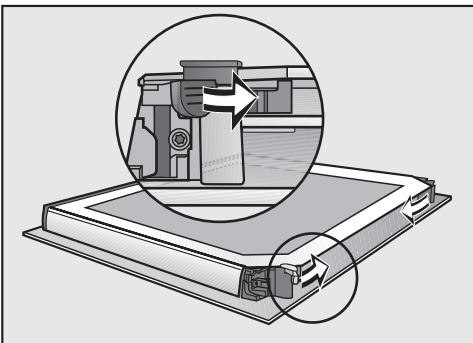

- Flip both the glass pane retainers inwards to close them.

The door is now reassembled.

## Fitting the door

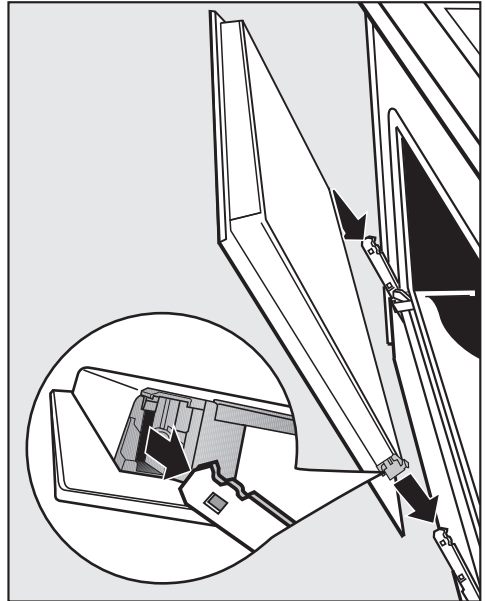

- Hold the door securely on both sides and carefully fit it back onto the hinge retainers. Make sure that the door goes back on straight.
- Open the door fully.

If the locking clamps are not locked, the door could work loose resulting in damage. Ensure that the locking clamps are locked after refitting the door.



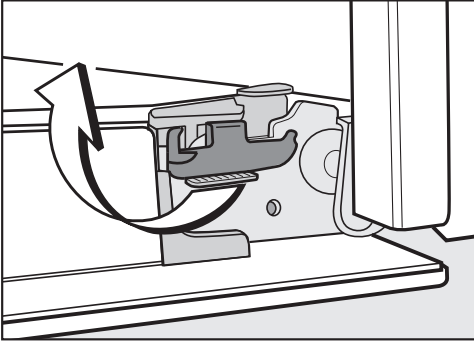

- To relock the locking clamps, flip them back up into a horizontal position as far as they will go.

### Removing the shelf runners with FlexiClip telescopic runners

You can remove the shelf runners together with the FlexiClip telescopic runners (if present).

If you wish to remove the FlexiClip telescopic runners separately beforehand, please follow the instructions in “Features – Fitting and removing the FlexiClip telescopic runners”.

 Risk of injury caused by hot surfaces.

The oven gets hot during operation. You could burn yourself on the heating elements, the oven compartment, or accessories. Allow the heating elements, oven compartment and the accessories to cool before removing the shelf runners.

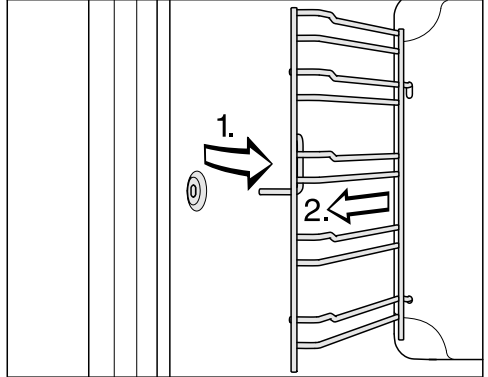

- Pull the shelf runners out of the holder (1) at the front of the oven and then pull them out of the oven (2).



**Refit** in the reverse order.

- Ensure that all parts are correctly fitted.

## Problem solving guide

Many malfunctions and minor faults that can occur in daily operation can be corrected without contacting Miele. This will save you time and money because you will not need a service call.



You can find information on how to remedy faults yourself at [www.miele.com.au/service](http://www.miele.com.au/service) or [www.miele.co.nz/service](http://www.miele.co.nz/service) and on the Miele website. Please note, however, that a call-out charge will be applied to unnecessary service visits where the problem could have been rectified as described in these operating instructions.

Problem	Possible cause and remedy
<b>The display is dark.</b>	You have selected the Time   Display   Off setting. When the oven is switched off, the display is dark. <ul style="list-style-type: none"> <li>■ If you want the time of day to be displayed constantly, select the Time   Display   On setting.</li> </ul>
	There is no power to the oven. <ul style="list-style-type: none"> <li>■ Check that the oven plug is correctly inserted into the socket and switched on.</li> <li>■ Check if the circuit breaker has tripped. If it has, contact a qualified electrician or Miele.</li> </ul>
<b>The signal tone does not sound.</b>	The buzzers are deactivated or set at too low a volume. <ul style="list-style-type: none"> <li>■ Switch on the buzzers or increase the volume with the Volume   Buzzer tones setting.</li> </ul>
<b>The oven compartment does not heat up.</b>	Demo mode is active. You can select oven functions and sensors, but the oven heating does not work. <ul style="list-style-type: none"> <li>■ Deactivate Demo mode with the Showroom programme   Demo mode   Off setting.</li> </ul>
System lock  <b>appears in the display.</b>	The system lock  has been switched on. <ul style="list-style-type: none"> <li>■ Confirm with <i>OK</i>.</li> </ul> Press <i>OK</i> for 6 seconds appears in the display. <ul style="list-style-type: none"> <li>■ You can deactivate the system lock for a cooking process by touching the <i>OK</i> sensor for at least 6 seconds.</li> <li>■ If you want to permanently deactivate the system lock, select the System lock    Off setting.</li> </ul>
<b>12:00 appears in the display.</b>	The power supply was interrupted for longer than 5 minutes. <ul style="list-style-type: none"> <li>■ Reset the time of day (see “Settings – Time of day”). Cooking process durations will also need to be reset.</li> </ul>
Power cut <b>appears in the display.</b>	There has been a brief power cut. This has caused the current cooking programme to stop. <ul style="list-style-type: none"> <li>■ Turn the function selector to <b>0</b>.</li> <li>■ Restart the cooking programme.</li> </ul>

## Problem solving guide

Problem	Possible cause and remedy
Max. op. hours reached <b>appears in the display.</b>	The oven has been operating for an unusually long time. This has triggered the safety switch-off function. <ul style="list-style-type: none"> <li>■ Confirm with <i>OK</i>.</li> </ul> The oven is now ready to use.
⚠ Fault <b>F32</b> <b>appears in the display.</b>	The door lock for pyrolytic cleaning has not locked. <ul style="list-style-type: none"> <li>■ Switch the oven off and then back on again. Start the pyrolytic cleaning programme again.</li> <li>■ If the message appears again, contact Miele.</li> </ul>
⚠ Fault <b>F33</b> <b>appears in the display.</b>	The door lock for pyrolytic cleaning does not open. <ul style="list-style-type: none"> <li>■ Switch the oven off and then back on again.</li> <li>■ If the door lock still does not unlock itself, contact Miele.</li> </ul>
Fault <b>and a fault code not listed here appears in the display.</b>	A fault has occurred that you cannot resolve. <ul style="list-style-type: none"> <li>■ Call Miele.</li> </ul>
<b>A noise can be heard after a cooking process.</b>	The cooling fan remains switched on after a cooking programme (see “Settings – Cooling fan run-on”).
<b>The oven has switched itself off.</b>	The oven will switch itself off automatically to save energy if no other action is taken within a certain time frame after switching it on or after the end of a cooking programme. <ul style="list-style-type: none"> <li>■ Switch the oven back on.</li> </ul>
<b>Cakes and biscuits are not cooked properly after the duration given in the cooking chart.</b>	A different temperature from the one given in the recipe has been used. <ul style="list-style-type: none"> <li>■ Select the temperature required for the recipe.</li> </ul>
	The ingredient quantities used are different from those given in the recipe. <ul style="list-style-type: none"> <li>■ Check whether you have amended the recipe. The addition of more liquid or more eggs makes a moister mix which would take longer to cook.</li> </ul>
<b>The browning of baked goods is uneven.</b>	The wrong temperature or shelf level was selected. <ul style="list-style-type: none"> <li>■ There will always be a slight unevenness in browning. If browning is very uneven, check whether the correct temperature and shelf level were selected.</li> </ul>
	The material or colour of the baking tin is not suitable for the oven function. <ul style="list-style-type: none"> <li>■ When using the Conventional Heat  function, light coloured, shiny tins are not as suitable. Dark, matt tins are best for baking.</li> </ul>

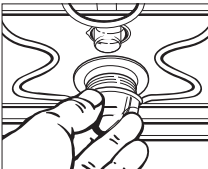
## Problem solving guide

Problem	Possible cause and remedy
<p><b>The FlexiClip telescopic runners do not push in or pull out smoothly.</b></p>	<p>The bearings in the FlexiClip telescopic runners are not sufficiently lubricated.</p> <ul style="list-style-type: none"> <li>■ Lubricate the bearings with the special Miele lubricant. Only the special Miele lubricant is designed to withstand the high temperatures in the oven compartment. Other lubricants may harden and stick to the FlexiClip telescopic runners when they are heated. You can obtain the special Miele lubricant from your Miele dealer or from Miele.</li> </ul>
<p><b>There is still soiling in the oven compartment after a pyrolytic cleaning programme.</b></p>	<p>The pyrolytic cleaning programme burns off soiling in the oven and leaves it as ash.</p> <ul style="list-style-type: none"> <li>■ Remove the ash using a damp microfibre cloth or a clean sponge and a solution of hot water and washing-up liquid. If there is still coarse soiling left in the oven after the pyrolytic cleaning programme, you should start the programme again, selecting a higher level if necessary.</li> </ul>
<p><b>The door will not open after the Pyrolytic cleaning programme.</b></p>	<p>The door lock for pyrolytic cleaning does not open.</p> <ul style="list-style-type: none"> <li>■ Turn the function selector to <b>0</b>.</li> <li>■ If the door lock still does not release itself, call Miele.</li> </ul>
<p><b>The oven lighting does not switch on.</b></p> 	<p>The halogen lamp is faulty and needs replacing.</p> <div style="border: 1px solid gray; padding: 5px; margin-bottom: 10px;"> <p> Risk of injury caused by hot surfaces. The oven gets hot during operation. You could burn yourself on the heating elements, the oven compartment, or accessories. Allow the heating elements, oven compartment and the accessories to cool before manual cleaning.</p> </div> <ul style="list-style-type: none"> <li>■ Disconnect the appliance from the electricity supply. Switch off at the wall and withdraw the plug from the socket, or switch off at the mains circuit breaker.</li> <li>■ Turn the lamp cover a quarter turn anti-clockwise to release it and then pull it together with its seal downwards to take it out.</li> <li>■ Replace the halogen lamp (Osram 66725 AM/A, 230 V, 25 W, G9).</li> <li>■ Refit the lamp cover together with its seal and turn clockwise to secure.</li> <li>■ Reconnect the oven to the electricity supply.</li> </ul>

You can find information on how to remedy faults yourself and about Miele spare parts at [www.miele.com.au/service](http://www.miele.com.au/service) or [www.miele.co.nz/service](http://www.miele.co.nz/service).

## Contact in case of fault

In the event of any faults which you cannot remedy yourself, please contact Miele.

You can book a Miele customer service call-out online at [www.miele.com.au/service](http://www.miele.com.au/service) or [www.miele.co.nz/service](http://www.miele.co.nz/service).

Contact information for Miele can be found at the end of this booklet.

Please quote the model and serial number of your appliance when contacting Miele. This information can be found on the data plate.

This information is given on the data plate, visible on the front frame of the oven, with the door fully open.

## Warranty

The manufacturer's warranty for this appliance is 2 years.

For further information, please refer to your warranty booklet.

# Installation

## Building-in dimensions

Dimensions are given in mm.

### Installation in a tall or base unit

When building the oven into a base unit underneath a cooktop, please also observe the installation instructions for the cooktop as well as the building-in height required for the cooktop.

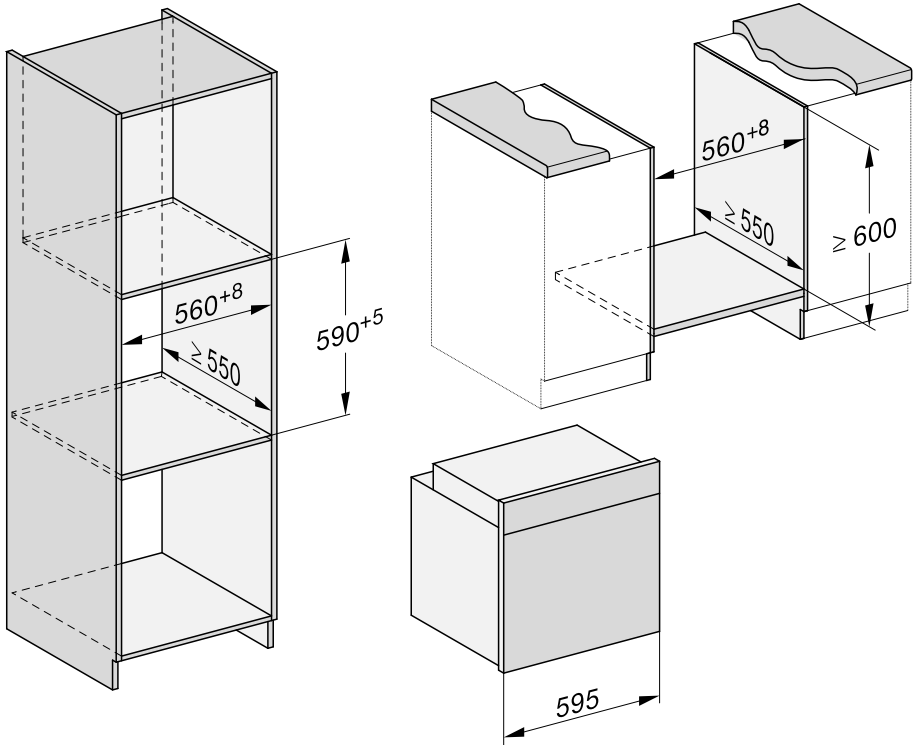

Side view H 24xx

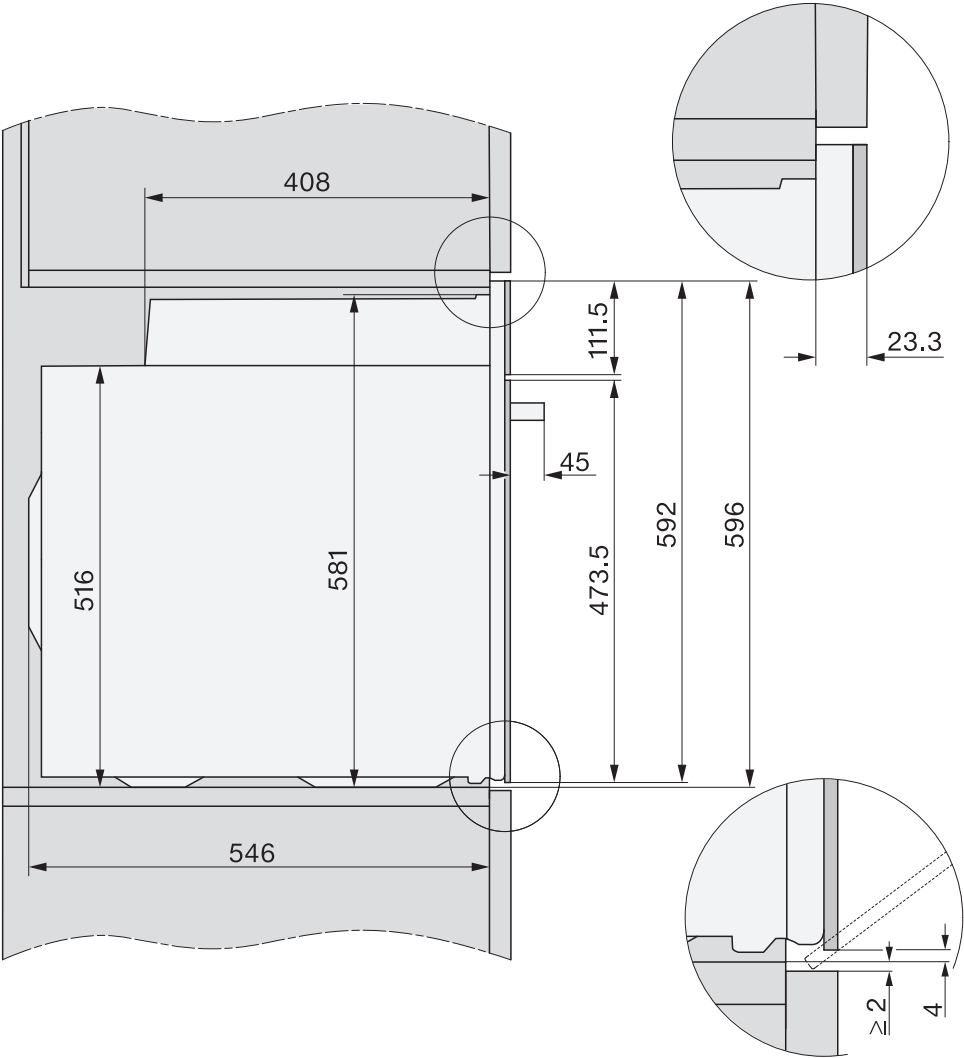

# Installation

Side view H 27xx, H 28xx

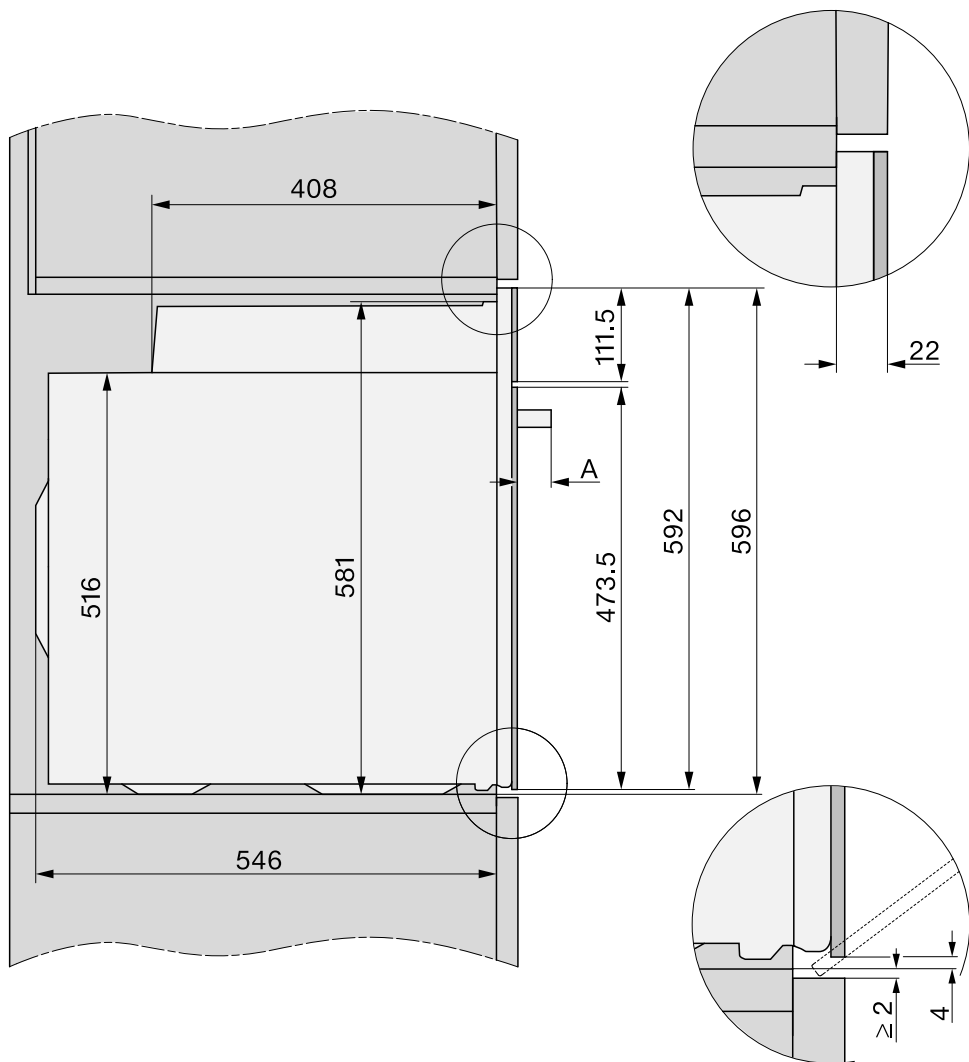

**A** H 27xx: 43 mm  
H 28xx: 47 mm



## Connections and ventilation

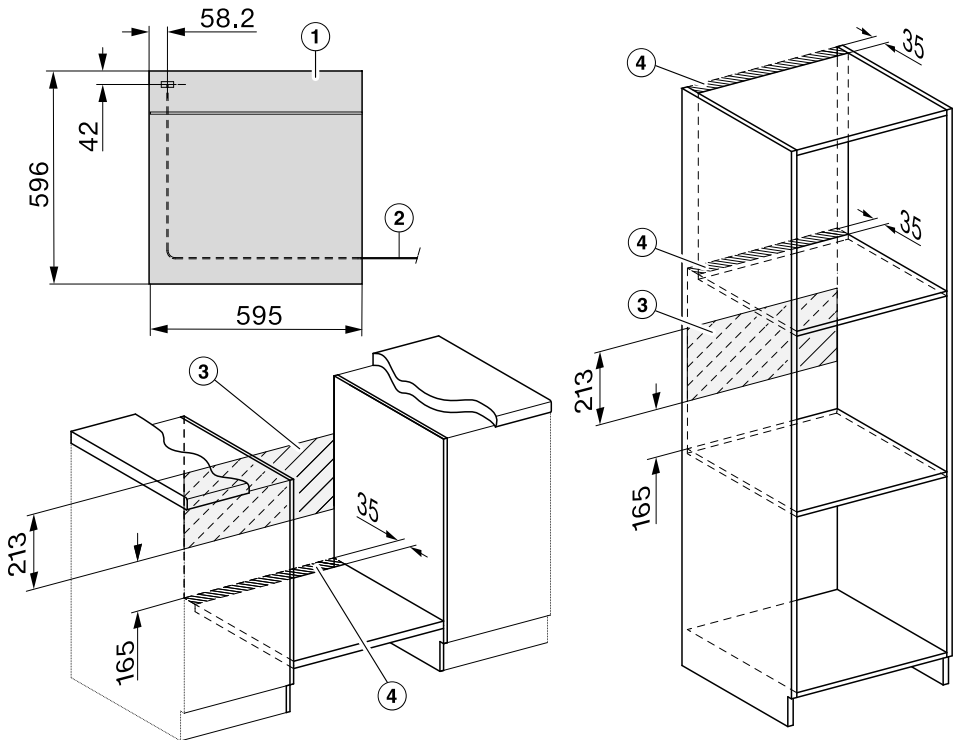

- ① Front view
- ② Mains connection cable, length = 1,500 mm
- ③ No connections permitted in this area
- ④ Ventilation cut-out, min. 150 cm<sup>2</sup>

# Installation

## Installing the oven

For safety reasons, the oven may only be used after it has been fully installed.

The oven requires a sufficient supply of cool air for efficient operation. The required supply of cool air must not be excessively heated by other heat sources (e.g. solid fuel stoves).

The following must be observed when installing the appliance:  
Make sure that the shelf that the oven sits on does not touch the wall.  
Do not fit heat insulation strips to the side walls of the housing unit.

- Connect the mains cable from the oven to the electricity supply.

Do not carry the oven by the door handle. The door can be damaged.  
Use the handle cut-outs on the side of the housing to lift the appliance.

It is a good idea to remove the door (see "Cleaning and care - Removing the door") and the accessories before installing the appliance. This makes the oven lighter when you push it into the housing unit and you do not run the risk of lifting it by the door handle by mistake.

- Push the oven into the housing unit and align it.
- Open the door, if you have not removed it.

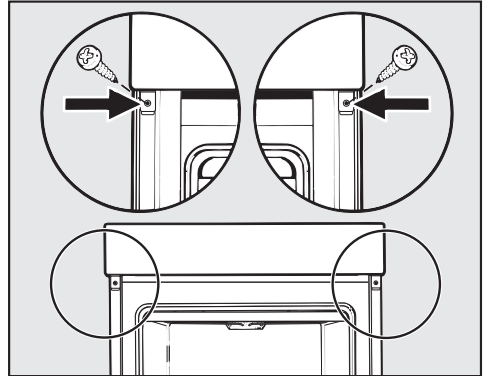

- Use the screws supplied to secure the oven to the side walls of the housing unit.
- Refit the door, if necessary (see "Cleaning and care - Fitting the door").

## Electrical connection



**Danger of injury!**  
Miele cannot be held liable for unauthorised installation, maintenance and repair work as this can be dangerous to users.

Connection to the electrical mains may only be carried out by a qualified electrician in accordance with national and local regulations and the additional regulations of the local electrical supply companies.

Connection of this appliance must comply with national and local safety regulations.

If the appliance is **hardwired** or if the switch is not accessible after installation, an additional means of disconnection must be provided for all poles.

The means of disconnection must be incorporated in the fixed wiring in accordance with the wiring rules.

Suitable means of disconnection include switches with an all-pole contact gap of at least 3 mm. These include isolator switches, fuses and relays in accordance with the wiring rules AS/NZS 3000.

**Voltage, rated load and fuse rating** are given on the data plate situated at the front of the oven compartment. Please ensure the connection data matches the household supply.

When contacting Miele, please quote the following:

- Model number
- Serial number
- Connection data (voltage/frequency/maximum rated load)

If the mains connection cable is damaged, it must be replaced by a suitably qualified electrician with a specialist connection cable of type H 05 VV-F, available from Miele, in order to avoid a hazard.

Temporary or permanent operation with a self-sufficient or non-mains synchronous energy supply system (e.g. isolated networks, back-up systems) is possible. A requirement for the operation is that the energy supply system complies with all current local and national requirements that apply to stand-alone, solar and/or battery systems.

The protective measures provided in the domestic installation and in this Miele product must also be assured in their function and operation in isolated operation or in non-mains synchronous operation, or replaced with equivalent measures in the installation.

### Oven



















Ovens are supplied with a 3-core cable for connection to a 230 V, 50 Hz alternating current supply.





Fuse rating is 16 A.

Maximum rated load: see data plate.

# Cooking charts























## Creamed mixture







Cakes/Biscuits (accessories)		🌡️ [°C]	 <sup>5</sup>		🕒 [min.]
			+HFC	-HFC	
Muffins (1 tray)		150–160	1	2	25–35
Muffins (2 trays)		150–160	1+3 <sup>3</sup>	1+3	30–40 <sup>4</sup>
Small cakes (1 tray)		150	1	2	30–40
		160 <sup>2</sup>	2	3	20–30
Small cakes (2 trays)		150 <sup>2</sup>	1+3 <sup>3</sup>	1+3	30–40
Sand cake (rack, loaf tin, 30 cm) <sup>1</sup>		150–160	1	2	60–70
		155–165 <sup>2</sup>	1	2	60–70
Marble, nut cake (rack, loaf tin, 30 cm) <sup>1</sup>		150–160	1	2	55–65
		150–160	1	2	60–70
Marble, nut cake (rack, ring tin/Bundt cake tin, Ø 26 cm) <sup>1</sup>		150–160	1	2	55–65
		150–160	1	2	60–70
Fresh fruit cake (1 tray)		160–170	1	2	40–50
		160–170	1	1	55–65
Fresh fruit cake (rack, springform cake tin, Ø 26 cm) <sup>1</sup>		150–160	1	2	55–65
		165–175 <sup>2</sup>	1	2	50–60
Flan base (rack, flan base tin, Ø 28 cm) <sup>1</sup>		150–160	1	2	25–35
		170–180 <sup>2</sup>	1	2	15–25

 Oven function, 🌡️ Temperature, <sup>5</sup> Shelf level (+HFC: with FlexiClip telescopic runners HFC 70-C / -HFC: without FlexiClip telescopic runners HFC 70-C), 🕒 Cooking duration,  Fan Plus,  Conventional Heat

- <sup>1</sup> Use a dark coloured, matt baking tin and place it centrally on the rack.
- <sup>2</sup> Pre-heat the oven before placing the food inside. Do not use the Booster  function for this purpose.
- <sup>3</sup> Fit the FlexiClip telescopic runners HFC 70-C (if available) onto the bottom shelf level.
- <sup>4</sup> Take the baking trays out of the oven early if the food has already browned sufficiently before the specified cooking time has elapsed.

## Rubbed in mixture



















Cakes/Biscuits (accessories)		🌡️ [°C]	 <sup>5</sup> 1		🕒 [min.]
			+HFC	-HFC	
Cookies (1 tray)		140–150	1	2	25–35
		150–160	1	2	25–35
Cookies (2 trays)		140–150	1+3 <sup>3</sup>	1+3	25–35 <sup>4</sup>
Drop cookies (1 tray)		140	1	2	35–45
		160 <sup>2</sup>	2	3	25–35
Drop cookies (2 trays)		140	1+3 <sup>3</sup>	1+3	40–50 <sup>4</sup>
Flan base (rack, flan base tin, Ø 28 cm) <sup>1</sup>		150–160	1	2	35–45
		170–180 <sup>2</sup>	1	2	20–30
Cheesecake (rack, springform cake tin, Ø 26 cm) <sup>1</sup>		170–180	1	2	80–90
		150–160	1	2	80–90
Apple pie (rack, springform cake tin, Ø 20 cm) <sup>1</sup>		160	1	2	80–100
		180	–	1	75–85
Apple pie (rack, springform cake tin, Ø 26 cm) <sup>1</sup>		180–190 <sup>2</sup>	1	2	60–70
		160–170	1	2	60–70
Fresh fruit cake, glazed (rack, springform cake tin, Ø 26 cm) <sup>1</sup>		170–180	1	2	60–70
		150–160	1	2	55–65
Fresh fruit cake, glazed (1 tray)		170–180	1	2	50–60
		160–170	1	2	45–55
Fruit flan (1 tray)		210–220 <sup>2</sup>	–	1	55–65
		180–190	–	1	35–45
Scones (2 x aluminium tray on rack, 4 x 4 pieces on each tray)		180–190 <sup>2</sup>	–	1+3	15–20 <sup>4</sup>





 Oven function, 🌡️ Temperature, <sup>5</sup> Shelf level (+HFC: with FlexiClip telescopic runners HFC 70-C / -HFC: without FlexiClip telescopic runners HFC 70-C), 🕒 Cooking duration,  Fan Plus,  Eco Fan Heat,  Conventional Heat,  Intensive Bake

- <sup>1</sup> Use a dark coloured, matt baking tin and place it centrally on the rack.
- <sup>2</sup> Pre-heat the oven before placing the food inside. Do not use the Booster  function for this purpose.
- <sup>3</sup> Fit the FlexiClip telescopic runners HFC 70-C (if available) onto the bottom shelf level.
- <sup>4</sup> Take the baking trays out of the oven early if the food has already browned sufficiently before the specified cooking time has elapsed.

# Cooking charts







## Yeast dough







Cakes/Biscuits (accessories)		🌡️ [°C]	 <sup>5</sup>		🕒 [min.]
			+HFC	-HFC	
Bundt cake (rack, Bundt cake tin, Ø 24 cm) <sup>1</sup>		150–160	1	2	50–60
		160–170	1	2	50–60
Stollen (1 tray)		150–160	1	2	55–65
		160–170	1	2	55–65
Streusel cake with/without fruit (1 tray)		160–170	1	2	40–50
		170–180	2	3	45–55
Fresh fruit cake (1 tray)		160–170	1	2	45–55
		170–180	2	3	45–55
Apple turnovers/raisin scrolls (1 tray)		160–170	1	2	25–35
Apple turnovers/raisin scrolls (2 trays)		160–170	1+3 <sup>3</sup>	1+3	30–40 <sup>5</sup>
White bread, free form (1 tray)		180–190	1	2	35–45
		190–200	1	2	30–40
White bread (rack, loaf tin, 30 cm) <sup>1</sup>		180–190	1	2	35–45
		190–200 <sup>2</sup>	1	2	30–40
Wholegrain bread (rack, loaf tin, 30 cm) <sup>1</sup>		180–190	1	2	55–65
		210–220 <sup>2</sup>	1	2	45–55
Prove yeast dough (rack)		30–35	– <sup>4</sup>	– <sup>4</sup>	–

 Oven function, 🌡️ Temperature, <sup>5</sup> Shelf level (+HFC: with FlexiClip telescopic runners HFC 70-C / -HFC: without FlexiClip telescopic runners HFC 70-C), 🕒 Cooking duration,  Fan Plus,  Conventional Heat

- <sup>1</sup> Use a dark coloured, matt baking tin and place it centrally on the rack.
- <sup>2</sup> Pre-heat the oven before placing the food inside. Do not use the Booster  function for this purpose.
- <sup>3</sup> Fit the FlexiClip telescopic runners HFC 70-C (if available) onto the bottom shelf level.
- <sup>4</sup> Place the rack on the floor of the oven, and stand the bowl with the dough on the rack. Depending on the size of the dish, you may need to remove the shelf runners.
- <sup>5</sup> Take the baking trays out of the oven early if the food has already browned sufficiently before the specified cooking time has elapsed.







## Quark dough







Cakes/Biscuits (accessories)		Temperature [°C]	Shelf level <sup>5</sup> 		Cooking duration [min.]
			+HFC	-HFC	
Fresh fruit cake (1 tray)		160–170	1	2	40–50
		170–180	2	3	50–60
Apple turnovers/raisin scrolls (1 tray)		160–170	2	3	25–35
Apple turnovers/raisin scrolls (2 trays)		150–160	1+3 <sup>1</sup>	1+3	25–35 <sup>2</sup>

 Oven function,  Temperature,  Shelf level (+HFC: with FlexiClip telescopic runners HFC 70-C / -HFC: without FlexiClip telescopic runners HFC 70-C),  Cooking duration,  Fan Plus,  Conventional Heat

- <sup>1</sup> Fit the FlexiClip telescopic runners HFC 70-C (if available) onto the bottom shelf level.
- <sup>2</sup> Take the baking trays out of the oven early if the food has already browned sufficiently before the specified cooking time has elapsed.

## Sponge mixture









Cakes/Biscuits (accessories)		Temperature [°C]	Shelf level <sup>5</sup> 		Cooking duration [min.]
			+HFC	-HFC	
Sponge cake base (2 eggs) (rack, springform cake tin, Ø 26 cm) <sup>1</sup>		160–170 <sup>2</sup>	1	2	15–25
Sponge cake base (4–6 eggs) (rack, springform cake tin, Ø 26 cm) <sup>1</sup>		150–160 <sup>2</sup>	1	2	30–40
Whisked sponge (rack, springform cake tin, Ø 26 cm) <sup>1</sup>		180 <sup>2</sup>	1	2	20–30
		150–170 <sup>2</sup>	1	2	25–45
Sponge cake base (1 tray)		180–190 <sup>2</sup>	1	2	10–20



 Oven function,  Temperature,  Shelf level (+HFC: with FlexiClip telescopic runners HFC 70-C / -HFC: without FlexiClip telescopic runners HFC 70-C),  Cooking duration,  Fan Plus,  Conventional Heat

- <sup>1</sup> Use a dark coloured, matt baking tin and place it centrally on the rack.
- <sup>2</sup> Pre-heat the oven before placing the food inside. Do not use the Booster  function for this purpose.

# Cooking charts

## Choux pastry, puff pastry, meringue





















Cakes/Biscuits (accessories)		🌡️ [°C]	 <sup>5</sup> 1		🕒 [min.]
			+HFC	-HFC	
Choux buns (1 tray)		160–170	1	2	30–40
Pastry puffs (1 tray)		180–190	1	2	20–30
Pastry puffs (2 trays)		180–190	1+3 <sup>1</sup>	1+3	20–30 <sup>2</sup>
Macaroons (1 tray)		120–130	1	2	25–50
Macaroons (2 trays)		120–130	1+3 <sup>1</sup>	1+3	25–50 <sup>2</sup>
Meringues/pavlovas (1 tray of 6, each Ø 6 cm)		80–100	1	2	120–150
Meringues/pavlovas (2 trays of 6, each Ø 6 cm)		80–100	1+3 <sup>1</sup>	1+3	150–180











 Oven function, 🌡️ Temperature, <sup>5</sup> Shelf level (+HFC: with FlexiClip telescopic runners HFC 70-C / -HFC: without FlexiClip telescopic runners HFC 70-C), 🕒 Cooking duration,  Fan Plus



- <sup>1</sup> Fit the FlexiClip telescopic runners HFC 70-C (if available) onto the bottom shelf level.
- <sup>2</sup> Take the baking trays out of the oven early if the food has already browned sufficiently before the specified cooking time has elapsed.



## Savoury snacks

















Food (accessories)		🌡️ [°C]	 5 1		🕒 [min]
			+HFC	-HFC	
Savoury flan (1 tray)		220–230 <sup>2</sup>	–	1	35–45
		180–190	–	1	30–40
Onion tart (1 tray)		180–190 <sup>2</sup>	1	2	25–35
		170–180	1	2	30–40
Pizza, yeast dough (1 tray)		170–180	1	2	25–35
		210–220 <sup>2</sup>	1	2	20–30
Pizza, yeast dough (1 aluminium Pizza dish Ø 35 cm on rack)		200 <sup>2</sup>	–	1	14–16
Pizza, quark dough (1 tray)		170–180	1	2	25–35
		190–200 <sup>2</sup>	1	2	25–35
Frozen pizza, pre-cooked (rack)		200–210	1	2	20–25
Toast (rack)		300	–	3	6–9
Baked dishes/gratins (e.g. toast) (rack on universal tray)		275 <sup>3</sup>	2	3	3–6
Grilled vegetables (rack on universal tray)		275 <sup>3</sup>	3	4	5–10 <sup>4</sup>
		250 <sup>3</sup>	3	3	5–10 <sup>4</sup>
Ratatouille (1 universal tray)		180–190	1	2	40–60
Oven chips, frozen <sup>1</sup> (Gourmet baking and AirFry tray, perforated)	   	180–190	2	3	30–35 <sup>4</sup>
Croquettes, frozen <sup>1</sup> (Gourmet baking and AirFry tray, perforated)	   	180–190	2	3	23–25 <sup>4</sup>

 Oven function, 🌡️ Temperature,  5 1 Shelf level (+HFC: with FlexiClip telescopic runners HFC 70-C / -HFC: without FlexiClip telescopic runners HFC 70-C), 🕒 Cooking duration,  Conventional Heat,  Intensive Bake,  Fan Plus,  Eco Fan Heat,  Full Grill,  Fan Grill,  |  Other | AirFry



- <sup>1</sup> Please follow the manufacturer's instructions on the packaging.
- <sup>2</sup> Pre-heat the oven before placing the food inside. Do not use the Booster  function for this purpose.
- <sup>3</sup> Pre-heat the oven for 5 minutes before placing the food inside. Do not use the Booster  function for this purpose.
- <sup>4</sup> If possible, turn the food halfway through the cooking duration.

# Cooking charts















## Beef







Food (accessories)		 [°C]	 <sup>5</sup> <sub>1</sub>	 [min.]	 <sup>10</sup> [°C]
Braised beef, approx. 1 kg (oven dish with lid)	 <sup>2</sup>	150–160 <sup>3</sup>	2 <sup>6</sup>	120–130 <sup>7</sup>	–
	 <sup>2</sup>	170–180 <sup>3</sup>	2 <sup>6</sup>	120–130 <sup>7</sup>	–
	 <sup>2</sup>	180–190	2 <sup>6</sup>	160–180 <sup>8</sup>	–
Fillet of beef, approx. 1 kg (universal tray)	 <sup>2</sup>	180–190 <sup>3</sup>	2 <sup>6</sup>	25–60	53–75
Fillet of beef, "rare", approx. 1 kg <sup>1</sup>	 <sup>2</sup>	80–85 <sup>4</sup>	2 <sup>6</sup>	70–80	53–55
Fillet of beef, "medium", approx. 1 kg <sup>1</sup>	 <sup>2</sup>	90–95 <sup>4</sup>	2 <sup>6</sup>	80–90	60–65
Fillet of beef, "well-done", approx. 1 kg <sup>1</sup>	 <sup>2</sup>	95–100 <sup>4</sup>	2 <sup>6</sup>	110–130	70–75
Sirloin joint, approx. 1 kg (universal tray)	 <sup>2</sup>	180–190 <sup>3</sup>	2 <sup>6</sup>	35–65	53–75
Sirloin joint, "rare", approx. 1 kg <sup>1</sup>	 <sup>2</sup>	80–85 <sup>4</sup>	2 <sup>6</sup>	80–90	53–55
Sirloin joint, "medium", approx. 1 kg <sup>1</sup>	 <sup>2</sup>	90–95 <sup>4</sup>	2 <sup>6</sup>	110–120	60–65
Sirloin joint, "well-done", approx. 1 kg <sup>1</sup>	 <sup>2</sup>	95–100 <sup>4</sup>	2 <sup>6</sup>	130–140	70–75
Burger, rissoles (rack on shelf level 4 and universal tray on shelf level 1)	 <sup>5</sup>	300 <sup>5</sup>	4	15–25 <sup>9</sup>	–

 Function,  Temperature,  <sup>5</sup><sub>1</sub> Shelf level,  Cooking duration,  Core temperature,  Fan Plus,  Conventional Heat,  Eco Fan Heat,  Full Grill

- <sup>1</sup> Use the rack and the universal tray.
- <sup>2</sup> Sear the meat on the cooktop first.
- <sup>3</sup> Pre-heat the oven before placing the food inside. Do not use the Booster  function for this purpose.
- <sup>4</sup> Pre-heat the oven at 120 °C for 15 minutes. Reduce the temperature when you place the food in the oven.
- <sup>5</sup> Pre-heat the oven for 5 minutes before placing the food inside. Do not use the Booster  function for this purpose.
- <sup>6</sup> Fit the FlexiClip telescopic runners HFC 70-C (if available).
- <sup>7</sup> Roast with the lid on first. Remove the lid after roasting for 90 minutes and add approx. 0.5 litre of liquid.
- <sup>8</sup> Roast with the lid on first. Remove the lid after roasting for 100 minutes and add approx. 0.5 litre of liquid.
- <sup>9</sup> Turn the food halfway through cooking.
- <sup>10</sup> If you are using a food probe, you can use the core temperature shown.

## Veal

















Food (accessories)		 [°C]	 <sup>5</sup> <sub>1</sub>	 [min.]	 <sup>7</sup> [°C]
Braised veal, approx. 1.5 kg (roasting dish with lid)	 <sup>2</sup>	160–170 <sup>3</sup>	2 <sup>5</sup>	120–130 <sup>6</sup>	–
	 <sup>2</sup>	170–180 <sup>3</sup>	2 <sup>5</sup>	120–130 <sup>6</sup>	–
Fillet of veal, approx. 1 kg (universal tray)	 <sup>2</sup>	160–170 <sup>3</sup>	2 <sup>5</sup>	30–60	53–75
Fillet of veal, “rare”, approx. 1 kg <sup>1</sup>	 <sup>2</sup>	80–85 <sup>4</sup>	2 <sup>5</sup>	50–60	53–55
Fillet of veal, “medium”, approx. 1 kg <sup>1</sup>	 <sup>2</sup>	90–95 <sup>4</sup>	2 <sup>5</sup>	80–90	60–65
Fillet of veal, “well-done”, approx. 1 kg <sup>1</sup>	 <sup>2</sup>	95–100 <sup>4</sup>	2 <sup>5</sup>	90–100	70–75
Saddle of veal, “rare”, approx. 1 kg <sup>1</sup>	 <sup>2</sup>	80–85 <sup>4</sup>	2 <sup>5</sup>	80–90	53–55
Saddle of veal, “medium”, approx. 1 kg <sup>1</sup>	 <sup>2</sup>	90–95 <sup>4</sup>	2 <sup>5</sup>	100–130	60–65
Saddle of veal, “well-done”, approx. 1 kg <sup>1</sup>	 <sup>2</sup>	95–100 <sup>4</sup>	2 <sup>5</sup>	130–140	70–75

 Function,  Temperature,  <sup>5</sup><sub>1</sub> Shelf level,  Cooking duration,  Core temperature,  Fan Plus,  Conventional Heat

- <sup>1</sup> Use the rack and the universal tray.
- <sup>2</sup> Sear the meat on the cooktop first.
- <sup>3</sup> Pre-heat the oven before placing the food inside. Do not use the Booster  function for this purpose.
- <sup>4</sup> Pre-heat the oven at 120 °C for 15 minutes. Reduce the temperature when you place the food in the oven.
- <sup>5</sup> Fit the FlexiClip telescopic runners HFC 70-C (if available).
- <sup>6</sup> Roast with the lid on first. Remove the lid after roasting for 90 minutes and add approx. 0.5 litre of liquid.
- <sup>7</sup> If you are using a food probe, you can use the core temperature shown.

# Cooking charts











## Pork







Food (accessories)		 [°C]	 <sup>5</sup> <sub>1</sub>	 [min.]	 <sup>10</sup> [°C]
Pork joint/pork neck roast, approx. 1 kg (oven dish with lid)		160–170	2 <sup>5</sup>	130–140 <sup>6</sup>	80–90
		180–190	2 <sup>5</sup>	130–140 <sup>6</sup>	80–90
Pork joint with crackling, approx. 2 kg (oven dish)		180–190	2 <sup>5</sup>	130–150 <sup>7</sup>	80–90
		190–200	2 <sup>5</sup>	130–150 <sup>7</sup>	80–90
Fillet of pork, approx. 350 g <sup>1</sup>	 <sup>2</sup>	90–100 <sup>3</sup>	2 <sup>5</sup>	70–90	60–69
Ham roast, approx. 1.5 kg (oven dish with lid)		160–170	2 <sup>5</sup>	130–160 <sup>8</sup>	80–90
Gammon joint, approx. 1 kg (universal tray)		150–160	2 <sup>5</sup>	50–60	63–68
Gammon joint, approx. 1 kg <sup>1</sup>	 <sup>2</sup>	95–105 <sup>3</sup>	2 <sup>5</sup>	140–160	63–66
Meat loaf, approx. 1 kg (universal tray)		170–180	2 <sup>5</sup>	60–70 <sup>7</sup>	80–85
		190–200	2 <sup>5</sup>	70–80 <sup>7</sup>	80–85
Bacon <sup>1</sup>		300 <sup>4</sup>	4	3–5	–
Sausage <sup>1</sup>		220 <sup>4</sup>	3 <sup>5</sup>	8–15 <sup>9</sup>	–

 Function, 
  Temperature, 
  <sup>5</sup><sub>1</sub> Shelf level, 
  Cooking duration, 
  <sup>10</sup> Core temperature, 
  Fan Plus, 
  Conventional Heat, 
  Eco Fan Heat, 
  Full Grill

- <sup>1</sup> Use the rack and the universal tray.
- <sup>2</sup> Sear the meat on the cooktop first.
- <sup>3</sup> Pre-heat the oven at 120 °C for 15 minutes. Reduce the temperature when you place the food in the oven.
- <sup>4</sup> Pre-heat the oven for 5 minutes before placing the food inside. Do not use the Booster  function for this purpose.
- <sup>5</sup> Fit the FlexiClip telescopic runners HFC 70-C (if available).
- <sup>6</sup> Roast with the lid on first. Remove the lid after roasting for 60 minutes and add approx. 0.5 litre of liquid.
- <sup>7</sup> Add approx. 0.5 l of liquid halfway through roasting.
- <sup>8</sup> Roast with the lid on first. Remove the lid after roasting for 100 minutes and add approx. 0.5 litre of liquid.
- <sup>9</sup> Turn the food halfway through cooking.
- <sup>10</sup> If you are using a food probe, you can use the core temperature shown.

## Lamb, game

















Food (accessories)		 [°C]	 <sup>5</sup> <sub>1</sub>	 [min.]	 <sup>6</sup> [°C]
Leg of lamb on the bone, approx. 1.5 kg (oven dish with lid)		170–180	2 <sup>4</sup>	100–120 <sup>5</sup>	53–75
Saddle of lamb, off the bone (universal tray)	 <sup>1</sup>	180–190 <sup>2</sup>	2 <sup>4</sup>	10–20	53–75
Saddle of lamb, off the bone (rack and universal tray)	 <sup>1</sup>	95–105 <sup>3</sup>	2 <sup>4</sup>	40–60	53–75
Saddle of venison, off the bone (universal tray)	 <sup>1</sup>	160–170 <sup>2</sup>	2 <sup>4</sup>	70–90	54–57
Roebuck saddle, off the bone (universal tray)	 <sup>1</sup>	140–150 <sup>2</sup>	2 <sup>4</sup>	25–35	60–81
Leg of wild boar, off the bone, approx. 1 kg (oven dish with lid)	 <sup>1</sup>	170–180	2 <sup>4</sup>	100–120 <sup>5</sup>	80–90











 Function,  Temperature, <sup>5</sup><sub>1</sub> Shelf level,  Cooking duration, <sup>6</sup> Core temperature,  Conventional Heat



- <sup>1</sup> Sear the meat on the cooktop first.
- <sup>2</sup> Pre-heat the oven before placing the food inside. Do not use the Booster  function for this purpose.
- <sup>3</sup> Pre-heat the oven at 120 °C for 15 minutes. Reduce the temperature when you place the food in the oven.
- <sup>4</sup> Fit the FlexiClip telescopic runners HFC 70-C (if available).
- <sup>5</sup> Roast with the lid on first. Remove the lid after roasting for 50 minutes and add approx. 0.5 litre of liquid.
- <sup>6</sup> If you are using a food probe, you can use the core temperature shown.

# Cooking charts

## Poultry, fish

Food (accessories)		 [°C]	 <sup>5</sup> <sub>1</sub>	 [min]	 <sup>8</sup> [°C]
Poultry, 0.8–1.5 kg (universal tray)		170–180	2 <sup>4</sup>	55–65	85–90
Chicken, approx. 1.2 kg (rack on universal tray)		180–190 <sup>2</sup>	2 <sup>4</sup>	55–65 <sup>5</sup>	85–90
Poultry, approx. 2 kg (oven dish)		180–190	2 <sup>4</sup>	100–120 <sup>6</sup>	85–90
		190–200	2 <sup>4</sup>	110–130 <sup>6</sup>	85–90
Poultry, approx. 4 kg (oven dish)		160–170	2 <sup>4</sup>	180–200 <sup>7</sup>	90–95
		180–190	2 <sup>4</sup>	180–200 <sup>7</sup>	90–95
Chicken thighs (grilling and roasting insert on universal tray)		190–200	2 <sup>4</sup>	30–35	–
Fish, 200–300 g, e.g. trout (universal tray)		210–220 <sup>3</sup>	2 <sup>4</sup>	15–25	75–80
Fish, 1–1.5 kg, e.g. Australian salmon (universal tray)		210–220 <sup>3</sup>	2 <sup>4</sup>	30–40	75–80
Fish fillet in foil, 200–300 g (universal tray)		200–210	2 <sup>4</sup>	25–30	75–80
Fish fingers, frozen <sup>1</sup> (Gourmet baking and AirFry tray, perforated)		220–230	2 <sup>4</sup>	13–15 <sup>5</sup>	–

 Function,  Temperature,  <sup>5</sup><sub>1</sub> Shelf level,  Cooking duration,  Core temperature,  Fan Plus,  Fan Grill,  Conventional Heat,  Eco Fan Heat,  Other | AirFry

- <sup>1</sup> Please follow the manufacturer's instructions on the packaging.
- <sup>2</sup> Pre-heat the oven for 5 minutes before placing the food inside. Do not use the Booster  function for this purpose.
- <sup>3</sup> Pre-heat the oven before placing the food inside. Do not use the Booster  function for this purpose.
- <sup>4</sup> Fit the FlexiClip telescopic runners HFC 70-C (if available).
- <sup>5</sup> If possible, turn the food halfway through the cooking duration.
- <sup>6</sup> Add approx. 0.25 litre of liquid at the start.
- <sup>7</sup> Add approx. 0.5 litre of liquid after 30 minutes.
- <sup>8</sup> If you are using a food probe, you can use the core temperature shown.

## Recipes for Automatic programmes

---

Below are the recipes to use with the Automatic programmes.

For optimum cooking results, we recommend using the quantities and accessories given in the recipes.

To find the correct shelf level, please remove the FlexiClip telescopic runners HFC 70-C before starting an Automatic programme.

# Recipes for Automatic programmes

---

## Apple sponge

Preparation time: 95 minutes

Serves 12

### For the topping

500 g apples, sharp

1 tbsp. lemon juice

### For the dough

150 g butter | softened

150 g caster sugar

1 ½ tsp. vanilla sugar

3 medium eggs

150 g plain white flour

½ tsp. baking powder

### For the tin

1 tsp. butter

### For dusting

1 tbsp. icing sugar

### Accessories

Rack

Springform cake tin, Ø 26 cm

Fine sieve

### Preparation

Peel and quarter the apples. Starting on the curved side, cut 1 cm thick slices, mix with lemon juice and place to one side.

Grease the springform tin.

Cream together the butter, sugar and vanilla sugar for approx. 2 minutes. Fold in each egg for half a minute.

Sift the baking powder and flour together and beat into the creamed mixture.

Spoon evenly into the greased springform cake tin. Press the apples gently into the cake mix with the curved side up.

Place the springform tin on the rack inside the oven and bake.

Leave the cake in the tin for 10 minutes after baking. Then release the sides of the tin and leave the cake to cool on the rack. Dust with icing sugar.

### Settings

#### Automatic programme

 | Apple sponge

Programme duration: 55 minutes

#### Manual

Function: 

Temperature: 165–175 °C

Pre-heat: No

Duration: 45–55 minutes

Shelf level: +HFC 70-C: 1 | -HFC 70-C: 2

#### Useful tip

Instead of dusting with icing sugar, you can spread some slightly warm apricot jam over the top.



## Deep sponge base

Preparation time: 75 minutes

Serves 12

### For the dough

4 medium eggs

2 tbsp. water | hot

175 g caster sugar

200 g plain white flour

1 tsp. baking powder

### For the tin

1 tsp. butter

### Accessories

Rack

Fine sieve

Springform cake tin, Ø 26 cm

Baking paper

### Preparation

Separate the egg whites from the yolks. Beat the egg whites with the water until stiff. Slowly add the sugar, beating after each addition. Whisk and then fold in the egg yolks.

Place the rack in the oven. Start the Automatic programme or pre-heat the oven.

Stir the baking powder into the flour, sift over the egg mixture, and then gently fold into the egg mixture with a large egg whisk.

Grease the base of the springform tin and line with baking paper. Pour the mixture into the springform tin and level with a spoon or spatula.

Place the sponge base in the oven and bake until golden.

Allow the cake to cool in the tin for approx. 10 minutes after baking. Turn out onto the rack and leave to cool. Cut horizontally through the cake twice to make 3 layers.

Spread over the prepared filling.

### Settings

#### Automatic programme

 | Sponge base

Programme duration: 36 minutes

#### Manual

Function: 

Temperature: 160–170 °C

Pre-heat: Yes

Duration: 30–40 minutes

Shelf level: +HFC 70-C: 1 | -HFC 70-C: 2

#### Useful tip

To make a chocolate sponge, add 2-3 teaspoons of cocoa powder to the flour mixture.

# Recipes for Automatic programmes

---

## Sponge base filling

Preparation time: 30 minutes

### For quark and cream filling

500 g quark, 20% fat in dry matter  
100 g caster sugar  
100 ml milk, 3.5% fat  
1 ½ tsp. vanilla sugar  
1 lemon | juice only  
6 gelatine leaves  
500 g cream

### For dusting

1 tbsp. icing sugar

### For cappuccino filling

100 g dark chocolate  
500 g cream  
6 gelatine leaves  
80 ml espresso  
80 ml coffee liqueur  
3 tsp. vanilla sugar  
1 tbsp. cocoa powder

### For dusting

1 tbsp. cocoa powder

### Accessories

Serving plate  
Fine sieve

### Preparation for quark and cream filling

Mix together the quark, sugar, milk, vanilla sugar and lemon juice. Soak the gelatine in cold water. Squeeze the gelatine, then dissolve it in the microwave or in a pan on the cooktop on a low heat.

Stir a portion of the quark mixture into the gelatine.

Stir this mixture into the remaining quark mixture and place in the refrigerator to chill. Whip the cream until stiff and fold into the quark mixture.

Place one layer of cake on a serving

platter and spread half of the quark mixture over it. Top it with another layer of the cake. Add the other half of the mixture, then top it with the final piece of the cake.

Place in the refrigerator to chill. Dust with icing sugar before serving.

### Preparation for cappuccino filling

Melt the chocolate for the cappuccino filling. Whip the cream until stiff and set a small portion aside to spread on the top layer. Soak the gelatine in cold water. Squeeze the gelatine, then dissolve it in the microwave or in a pan on the cooktop on a low heat. Leave to cool slightly.

Stir half the espresso and half the coffee liqueur into the gelatine and add to the whipped cream.

Divide the coffee and cream mixture in half. Stir the vanilla sugar into one half and the chocolate and cocoa into the other half.

Place one layer of cake on a serving platter and drizzle with a little coffee liqueur and espresso, and spread the chocolate cream over this. Top with the second layer of cake, drizzle with the remaining liqueur and espresso and spread this with the vanilla cream. Place the third layer on top, coat it with the cream you set aside and dust with cocoa powder.

### Useful tip

For a fruity variation, add some grated lemon zest and 300 g drained mandarin segments or apricot pieces.

## Marble cake

Preparation time: 80 minutes

Serves 18

### For the dough

250 g butter | softened

200 g caster sugar

1½ tsp. vanilla sugar

4 medium eggs

200 g sour cream

400 g plain white flour

3 tsp. baking powder

A pinch of salt

3 tbsp. cocoa powder

### For the tin

1 tsp. butter

### Accessories

Ring tin, Ø 26 cm

Rack

### Preparation

Cream together the butter, sugar and vanilla sugar. Add the eggs one by one, stirring for ½ minute each time. Add the sour cream. Sift together the flour, baking powder and salt. Then fold into the other ingredients.

Grease the ring tin and spoon in half of the mixture.

Fold the cocoa powder into the other half of the mixture. Pour the dark mixture over the light mixture. Swirl a fork through the mixture to give a marbled effect.

Place the ring tin on the rack in the oven and bake.

Leave the cake in the tin for 10 minutes after baking. Turn out onto the rack and leave to cool.

### Settings

#### Automatic programme

 | Marble cake

Programme duration: 55 minutes

#### Manual

Function: 

Temperature: 150–160 °C

Pre-heat: No

Duration: 50–60 minutes

Shelf level: +HFC 70-C: 1 | -HFC 70-C: 2

# Recipes for Automatic programmes

---

## Fruit streusel cake

Preparation time: 150 minutes

Serves 20

### For the dough

42 g fresh yeast  
150 ml milk, 3.5% fat | lukewarm  
450 g plain white flour  
50 g caster sugar  
90 g butter | softened  
1 medium egg

### For the topping

1.25 kg apples

### For the streusel

240 g plain white flour  
150 g caster sugar  
3 tsp. vanilla sugar  
1 tsp. cinnamon  
150 g butter | softened

### Accessories

Baking tray or universal tray

### Preparation

Stir the yeast into the milk to dissolve it. Add to the flour, sugar, butter and egg, and knead to a smooth dough.

Shape the dough into a ball, place it in a bowl, cover it with a damp cloth and place it in the oven compartment. Prove according to the settings in proving phase 1.

Peel and core the apples and slice them into wedges.

Lightly knead the dough and then roll it out on a baking tray or the universal tray. Spread the apples evenly across the dough. Mix together the flour, sugar, vanilla sugar and cinnamon. Then knead in the butter to create a streusel mix. Scatter this over the apples.

Place the cake in the oven and prove the dough using the settings indicated for proving phase 2.

Bake the cake until golden brown.

### Settings for proving yeast dough

Proving phase 1

Function: 

Temperature: 30 °C

Proving time: 30–45 minutes

Proving phase 2

Function: 

Temperature: 30 °C

Proving time: 30 minutes

### Automatic programme for baking cake

 | Fruit streusel cake

Programme duration: 44 minutes

### Manual

Function: 

Temperature: 180–190 °C

Pre-heat: No

Duration: 40–50 minutes

Shelf level: +HFC 70-C: 2 | -HFC 70-C: 3

### Useful tip

Instead of the apples, try using 1 kg stoned plums or cherries.

# Recipes for Automatic programmes

---

## Biscuits

Preparation time: 135 minutes

Makes 70 (2 trays)

### Ingredients

250 g plain white flour

½ tsp. baking powder

80 g caster sugar

1 ½ tsp. vanilla sugar

1 tsp. rum essence

1 ½ tbsp. water

120 g butter | softened

### Accessories

Rolling pin

Biscuit cutters

2 baking trays or universal trays

### Preparation

Mix together the flour, baking powder, sugar and vanilla sugar. Add the rest of the ingredients and quickly knead to form a smooth dough. Chill for at least 60 minutes.

Roll out the dough to a thickness of approx. 3 mm, cut out the biscuits and place them on the baking or universal trays.

Place the biscuits in the oven and bake.

### Settings

#### Automatic programme

 | Biscuits |

1 tray / 2 trays

Programme duration for 1 tray:

25 minutes

Programme duration for 2 trays:

26 minutes

#### Manual

Oven function: 

Temperature: 140–150 °C

Pre-heat: No

Duration: 25–35 minutes

Shelf level, 1 tray:

+HFC 70-C: 1 | -HFC 70-C: 2

Shelf level, 2 trays:

+HFC 70-C: 1+3 | -HFC 70-C: 1+3

#### Useful tip

The quantities for the ingredients are for 2 trays. For 1 tray, halve the quantities or bake the biscuits one after the other.

# Recipes for Automatic programmes

---

## Drop cookies

Preparation time: 50 minutes

Makes 50 (2 trays)

### Ingredients

160 g butter | softened

50 g brown sugar

50 g icing sugar

1½ tsp. vanilla sugar

A pinch of salt

200 g plain white flour

1 medium egg | just the white

### Accessories

Piping bag

Star nozzle, 9 mm

2 baking trays or universal trays

### Preparation

Beat butter until creamy. Add the sugar, icing sugar, vanilla sugar and salt and beat until soft. Then fold in the flour, followed by the egg white.

Put the dough in a piping bag and pipe it onto the baking tray or universal tray in strips measuring approx. 5–6 cm in length.

Place the drop cookies in the oven and bake until golden.

### Settings

#### Automatic programme

 | Drop cookies | 1 tray / 2 trays

Programme duration for 1 tray:

24 minutes

Programme duration for 2 trays:

31 minutes

#### Manual

##### For 1 tray

Function: 

Temperature: 150–160 °C

Pre-heat: No

Duration: 20–30 minutes

Shelf level: +HFC 70-C: 1 | -HFC 70-C: 2

##### For 2 trays

Function: 

Temperature: 140–150 °C

Pre-heat: No

Duration: 25–35 minutes

Shelf level: +HFC 70-C: 1+3 | -HFC 70-C: 1+3

#### Useful tip

The quantities for the ingredients are for 2 trays. For 1 tray, halve the quantities or bake the biscuits one after the other.

## Walnut muffins

Preparation time: 95 minutes

Makes 12

### Ingredients

80 g raisins

40 ml rum

120 g butter | softened

120 g caster sugar

1 ½ tsp. vanilla sugar

2 medium eggs

140 g plain white flour

1 tsp. baking powder

120 g walnuts | roughly chopped

### Accessories

12-cup muffin tin with cup Ø 5 cm

Paper cases, Ø 5 cm

Rack

### Preparation

Drizzle the rum over the raisins and leave for approx. 30 minutes.

Beat butter until creamy. Gradually mix in the sugar, vanilla sugar and eggs. Sift together the flour and baking powder and fold in. Stir in the walnuts. Finally, add the rum and raisins.

Line the muffin tin with the paper cases. Using 2 tablespoons, distribute the mixture evenly between the muffin cases.

Place the muffin tin on the rack in the oven and bake.

### Settings

#### Automatic programme

 | Walnut muffins

Programme duration: 37 minutes

#### Manual

Function: 

Temperature: 150–160 °C

Pre-heat: No

Duration: 30–40 minutes

Shelf level: +HFC 70-C: 1 | -HFC 70-C: 2

# Recipes for Automatic programmes

---

## Pizza (yeast dough)

Preparation time: 90 minutes

Serves 4

### For the dough

30 g fresh yeast  
170 ml water | lukewarm  
300 g plain white flour  
1 tsp. sugar  
1 tsp. salt  
½ tsp. thyme, ground  
1 tsp. oregano, ground  
½ tbsp. oil

### For the topping

2 onions  
1 clove of garlic  
400 g tinned tomatoes, skinned and chopped  
2 tbsp. tomato paste  
1 tsp. sugar  
1 tsp. oregano, ground  
1 bay leaf  
1 tsp. salt  
Pepper  
125 g mozzarella  
125 g Gouda cheese, grated

### For frying

½ tbsp. olive oil

### Accessories

Baking tray or universal tray

### Preparation

Stir the yeast into the water to dissolve it. Add to the flour, sugar, salt, thyme, oregano and oil and knead for 6–7 minutes until you have a smooth dough.

Shape the dough into a ball, place it in a bowl and cover with a damp cloth. Leave to prove at room temperature for 20 minutes.

To make the topping, finely dice the onions and garlic. Heat the oil in a pan. Sweat the onions and garlic until glassy. Add the tomatoes, tomato paste, sugar, oregano, bay leaf and salt.

Allow the sauce to simmer for 5 minutes.

Remove the bay leaf, season with salt and pepper to taste. Slice the mozzarella.

Roll the dough out onto the baking tray or universal tray. Leave to prove at room temperature for 10 minutes.

Start the Automatic programme or pre-heat the oven.

Spread the sauce over the dough. Leave a gap of approx. 1 cm all the way round the edge. Top with the mozzarella and sprinkle on the Gouda.

Place the pizza in the oven and bake.

### Settings

#### Automatic programme

 | Pizza | Yeast dough

Programme duration: 32 minutes

#### Manual

Function: 

Temperature: 200–210 °C

Pre-heat: Yes

Duration: 20–30 minutes

Shelf level: +HFC 70-C: 1 | -HFC 70-C: 2

#### Useful tip

As an alternative, try topping the pizza with ham, salami, mushrooms, onions or tuna.



## Pizza (Quark dough)

Preparation time: 60 minutes

Serves 4

### For the dough

120 g quark, 20% fat in dry matter

2 tbsp. milk, 3.5% fat

2 tbsp. oil

2 medium eggs | yolk only

1 tsp. salt

1½ tsp. baking powder

250 g plain white flour

### For the topping

2 onions

1 clove of garlic

400 g tinned tomatoes, skinned and chopped

2 tbsp. tomato paste

1 tsp. sugar

1 tsp. oregano

1 bay leaf

1 tsp. salt

Pepper

125 g mozzarella

125 g Gouda cheese, grated

### For frying

½ tbsp. olive oil

### Accessories

Baking tray or universal tray

### Preparation

To make the topping, finely dice the onions and garlic. Heat the oil in a pan. Sweat the onions and garlic until glassy. Add the tomatoes, tomato paste, sugar, oregano, bay leaf and salt.

Allow the sauce to simmer for 5 minutes.

Remove the bay leaf. Season with salt and pepper to taste. Slice the mozzarella.

To make the dough, start by mixing together the quark, milk, oil, egg yolk and salt. Sift together the flour and baking powder. Mix half the amount into the dough. Then knead in the rest.

Roll the dough out onto the baking tray or universal tray.

Start the Automatic programme or pre-heat the oven.

Spread the sauce over the dough. Leave a gap of approx. 1 cm all the way round the edge. Top with the mozzarella and sprinkle on the Gouda.

Place the pizza in the oven and bake.

### Settings

#### Automatic programme

 | Pizza | Quark dough

Programme duration: 33 minutes

#### Manual

Function: 

Temperature: 180–190 °C

Pre-heat: Yes

Duration: 25–35 minutes

Shelf level: +HFC 70-C: 2 | -HFC 70-C: 3

#### Useful tip

As an alternative, try topping the pizza with ham, salami, mushrooms, onions or tuna.

# Recipes for Automatic programmes

---

## Chicken

Preparation time: 95 minutes

Serves 2

### Ingredients

1 chicken (1.2 kg), ready to cook

1 tbsp. oil

1½ tsp. salt

2 tsp. sweet paprika

1 tsp. curry powder

### Accessories

Rack

Ovenproof dish, 22 cm x 29 cm

Kitchen string

### Preparation

Mix the oil with the salt, paprika and curry powder; then coat the chicken with it.

Tie the legs together with kitchen twine and put the chicken breast side up in the ovenproof dish.

Place the ovenproof dish on the rack and place it in the oven with the legs of the bird pointing towards the oven door. Roast the chicken.

### Settings

#### Automatic programme

 | Chicken

Programme duration: 80 minutes

#### Manual

Function: 

Temperature: 180–190 °C

Pre-heat: No

Duration: 75–85 minutes

Shelf level: +HFC 70-C: 1 | -HFC 70-C: 2

## Roast fillet of beef

Preparation time: 65 minutes

Serves 4

### For the beef fillet

1 kg beef fillet, ready to cook

1 tbsp. oil

1 tsp. salt

Pepper

### For frying

1 tbsp. oil

### Accessories

Universal tray

### Preparation

Start the Automatic programme or pre-heat the oven.

Heat the oil in a pan and sear the beef fillet all over (approx. 1 minute per side).

Remove the beef fillet. Mix together the oil, salt and pepper; then coat the beef fillet with it.

Place the fillet of beef onto the universal tray and slide into the oven compartment. Cook the beef fillet.

### Settings

#### Automatic programme

 | Fillet of beef

Programme duration:

Rare: 36 minutes

Medium: 43 minutes

Well-done: 59 minutes

#### Manual

Function: 

Temperature: 180–190 °C

Pre-heat: Yes

Duration: 20–30 minutes (Rare),

35–45 minutes (Medium),

50–60 minutes (Well-done)

Shelf level: +HFC 70-C: 1 | -HFC 70-C: 2

# Recipes for Automatic programmes

---

## Trout

Preparation time: 65 minutes

Serves 4

### For the trout

4 trout (250 g each), ready to cook

1 tbsp. lemon juice

Salt

Pepper

### For the stuffing

200 g button mushrooms, fresh

½ onion

1 clove of garlic

25 g parsley

Salt

Pepper

### For dotting

3 tbsp. butter

### Accessories

Universal tray

### Preparation

Drizzle the lemon juice over the trout. Season with salt and pepper inside and out.

To make the stuffing, clean the mushrooms. Finely chop the onion, garlic, mushrooms and parsley, and mix well. Season the mixture with salt and pepper.

Start the Automatic programme or pre-heat the oven.

Stuff the trout with the filling and place side by side on the universal tray. Dot with small chunks of butter.

Place the universal tray in the oven. Cook the trout.

### Settings

#### Automatic programme

 | Trout

Programme duration: 36 minutes

#### Manual

Function: 

Temperature: 210–220 °C

Pre-heat: Yes

Duration: 20–30 minutes

Shelf level: +HFC 70-C: 1 | -HFC 70-C: 2

#### Useful tip

Serve with slices of lemon and browned butter.

## Salmon fillet

Preparation time: 40 minutes

Serves 4

### For the salmon fillet

4 salmon fillets (200 g each), ready to cook

1 tbsp. lemon juice

Salt

Pepper

### For dotting

3 tbsp. butter

### For sprinkling

1 tsp. dill, chopped

### Accessories

Universal tray

### Preparation

Start the Automatic programme or pre-heat the oven.

Place the salmon fillets on the universal tray. Drizzle with lemon juice. Season with salt and pepper. Dot the salmon fillets with small chunks of butter and sprinkle with dill.

Place the universal tray in the oven and cook the salmon fillets.

### Settings

#### Automatic programme

 | Salmon fillet

Programme duration: 27 minutes

#### Manual

Function: 

Temperature: 200–210 °C

Pre-heat: Yes

Duration: 10–20 minutes

Shelf level: +HFC 70-C: 1 | -HFC 70-C: 2

# Recipes for Automatic programmes

---

## Australian salmon

Preparation time: 65 minutes

Serves 4

### For the salmon

1 Australian salmon (1 kg), whole, ready to cook

1 lemon | juice only

Salt

### For the stuffing

2 shallots

2 cloves of garlic

2 slices of white bread

50 g small capers

1 medium egg | just the yolk

1 tbsp. olive oil

Salt

Pepper

Chilli powder

### Accessories

8 wooden skewers

Universal tray

### Preparation

Drizzle the lemon juice over the salmon. Season with salt inside and out.

To make the stuffing, finely dice the shallots, garlic and bread. Mix together the capers, egg yolk, olive oil, shallots, garlic and bread. Season with salt, pepper and chilli powder.

Start the Automatic programme or pre-heat the oven.

Stuff the salmon with the mixture. Seal the opening with small wooden skewers.

Place the salmon onto the universal tray and place in the oven. Cook the salmon.

### Settings

#### Automatic programme

 | Ocean trout

Programme duration: 46 minutes

#### Manual

Function: 

Temperature: 210–220 °C

Pre-heat: Yes

Duration: 30–40 minutes

Shelf level: +HFC 70-C: 1 | -HFC 70-C: 2

## Potato and cheese gratin

Preparation time: 90 minutes

Serves 4

### For the gratin

600 g potatoes, floury

75 g Gouda cheese, grated

### For the tin

1 clove of garlic

### For the topping

250 g cream

1 tsp. salt

Pepper

Nutmeg

### For sprinkling

75 g Gouda cheese, grated

### Accessories

Ovenproof dish, Ø 26 cm

Rack

### Preparation

Rub the dish with the garlic clove.

To make the cream mixture, mix together the cream, salt, pepper and nutmeg.

Peel the potatoes and cut them into slices 3–4 mm thick. Mix the potatoes with the cheese and the cream mixture, and transfer to the ovenproof dish.

Sprinkle with Gouda.

Place the potato and cheese gratin on the rack. Then place in the oven and cook until golden brown.

### Settings

#### Automatic programme

 | Potato gratin

Programme duration: 50 minutes

#### Manual

Function: 

Temperature: 180–190 °C

Pre-heat: No

Duration: 55–65 minutes

Shelf level: +HFC 70-C: 1 | -HFC 70-C: 2

# Recipes for Automatic programmes

---

## Lasagne

Preparation time: 125 minutes

Serves 4

### For the lasagne

8 lasagne sheets (not pre-cooked)

### For the Bolognese sauce

50 g smoked streaky bacon | finely diced

375 g mince, half beef and half pork

2 onions | diced

800 g tinned tomatoes, skinned

30 g tomato paste

125 ml stock

1 tsp. fresh thyme | chopped

1 tsp. fresh oregano | chopped

1 tsp. fresh basil | chopped

Salt

Pepper

### For the mushroom sauce

20 g butter

1 onion | diced

100 g fresh mushrooms | sliced

2 tbsp. plain white flour

250 g cream

250 ml milk, 3.5% fat

Salt

Pepper

Nutmeg

2 tbsp. fresh parsley | chopped

### For sprinkling

200 g Gouda cheese, grated

### Accessories

Ovenproof dish, 32 cm x 22 cm

Rack

### Preparation

To make the Bolognese sauce, start by heating a non-stick pan. Fry the diced bacon, add the mince and continue to fry, stirring constantly. Add the onions

and allow to sweat. Chop the tomatoes. Add the tomatoes, tomato juice, tomato paste and stock. Season with herbs, salt and pepper. Allow to simmer for approx. 5 minutes.

To make the mushroom sauce, sweat the onions in butter. Add the mushrooms and sauté briefly. Sprinkle with flour and stir. Deglaze with the cream and milk. Season with nutmeg, salt and pepper. Allow the sauce to simmer for approx. 5 minutes. Finally, add the parsley.

To make the lasagne, layer up the ingredients in the ovenproof dish in the order listed below:

- One third of the bolognese sauce
- 4 lasagne sheets
- One third of the bolognese sauce
- Half of the mushroom sauce
- 4 lasagne sheets
- One third of the bolognese sauce
- Half of the mushroom sauce

Sprinkle the lasagne with the Gouda and place it on the rack. Then place in the oven and cook until golden brown.

### Settings

#### Automatic programme

 | Lasagne

Programme duration: 55 minutes

#### Manual

Function: 

Temperature: 185–195 °C

Pre-heat: No

Duration: 55–65 minutes

Shelf level: +HFC 70-C: 1 | -HFC 70-C: 1



On the following pages you will find recipes for the AirFry function.

For optimum cooking results, we recommend using the quantities and accessories given in the recipes.

# AirFry recipes

---

## Falafel with yoghurt dip

Preparation time: 60 minutes + 12 hours standing time

Serves 4

### For the falafel

250 g chickpeas, dried  
2 l water  
2 onions | finely diced  
2 cloves of garlic | finely chopped  
30 g parsley | chopped  
1 tbsp. lemon juice  
½ tbsp. olive oil  
50 g tahini (sesame paste)  
1 tsp. coriander, ground  
1 tsp. oregano  
½ tsp. ras-el-hanout  
1 tsp. cumin  
1 ½ tsp. salt  
A pinch of pepper  
A pinch of chilli  
60 g plain white flour  
1 tsp. baking powder

### For the yoghurt dip

500 g yoghurt, 3.5% fat  
100 g cream cheese  
1 tbsp. tahini (sesame paste)  
1 ½ tbsp. lemon juice  
20 g parsley | chopped  
1 tsp. salt  
A pinch of pepper

### Accessories

Sieve  
Blender with cutting blades  
Mixer with dough hook  
Gourmet baking and AirFry tray,  
perforated

### Preparation

Soak the chickpeas in water for 12 hours.

Mix all of the ingredients together for the yoghurt dip and chill in the refrigerator.

Pour the chickpeas into a sieve.

Add the parsley, onions, garlic, lemon juice, oil, tahini and spices to the blender. Add the chickpeas little by little. While doing so, stir the mixture with a tablespoon occasionally.

Place the mixture in a bowl. Mix together the flour and baking powder and fold into the mixture. Divide the dough into 24 balls. Flatten the balls slightly in your hands and place them on the Gourmet baking and AirFry tray. Place in the oven and bake until golden brown.

### Settings

Oven function:  | AirFry

Temperature: 210 °C

Duration: 18 minutes

Shelf level: 2

## French fries and sweet potato fries

Preparation time: 50 minutes

Serves 4

### For the fries

500 g potatoes, firm | in batons  
(approx. 0.5 x 0.5 x 6 cm)  
500 g sweet potatoes | in batons  
(approx. 0.5 x 0.5 x 6 cm)  
30 ml sunflower oil

### For the dip

150 g Greek style natural yoghurt  
150 g buttermilk  
¼ lemon | juice and zest  
½ bunch of dill  
¼ tsp. rosemary, dried  
¼ tsp. oregano, dried  
½ tsp. onion powder  
¼ tsp. garlic powder  
A pinch of salt  
A pinch of pepper

### For the seasoned salt

2 tbsp. salt  
1 tsp. paprika, smoked  
½ tsp. onion powder  
½ tsp. garlic powder

### Accessories

Ovenproof dish  
Tea towels  
Gourmet baking and AirFry tray,  
perforated

### Preparation

Bring the water to the boil on the cooktop. Blanch the potato batons in boiling water for 3 minutes. Then drop them into cold water and pat dry on a tea towel.

Marinate the potato batons with the sunflower oil. Then place on the Gourmet baking and AirFry tray and cook according to the settings. Turn after 15 minutes and cook for a further 10 minutes.

To make the dip, mix all the ingredients together and season with salt and pepper to taste. Chill the dip until ready to serve.

To make the seasoned salt, mix all the spices together and set aside.

At the end of the cooking duration, season the fries generously and serve with the dip.

### Settings

Oven function:  | AirFry  
Temperature: 220 °C  
Duration: 25 minutes  
Shelf level: 2

# AirFry recipes

---

## Sesame tofu sticks

Preparation time: 35 minutes

Serves 3

### Ingredients

- 400 g tofu
- 1 ½ tbsp. teriyaki sauce
- 4 tbsp. tahini (sesame paste)
- 1 tbsp. vegetable oil
- 1 tbsp. agave syrup
- 1 tbsp. sesame seeds, white
- 1 tbsp. sesame seeds, black
- 1 tbsp. cornflour
- 3 tbsp. breadcrumbs

### Accessories

- Paper towels
- Grilling and roasting insert
- Universal tray

### Preparation

Cut the tofu into 1 cm thick slices and press firmly between pieces of paper towel. Then cut the tofu slices into sticks 1 cm wide and 3 cm long. Press the sticks between pieces of paper towel again in order to remove as much moisture as possible from the tofu. Leave the sticks on the paper towel for 15 minutes.

Mix together the teriyaki sauce, tahini, oil and agave syrup. Mix this sauce with the sesame seeds.

Place the tofu sticks in a bowl and add the cornflour. Toss the tofu sticks in the bowl until they are evenly coated with the cornflour. Pre-heat the oven using the indicated settings.

Add the sauce to the bowl containing the tofu sticks and mix everything together. Then sprinkle over the breadcrumbs and mix everything

together again. Place the grilling and roasting insert on the universal tray and place the tofu sticks on the insert so they are not touching each other. Place the tofu sticks in the pre-heated oven and bake.

### Settings: Pre-heat

Oven function:  | Booster  
Temperature: 190 °C

### Settings: baking the sesame tofu sticks

Oven function:  | AirFry  
Temperature: 190 °C  
Duration: 7 minutes  
Shelf level: 2

## Baked potatoes with cheese, spring onions and bacon

Preparation time: 70 minutes

Serves 4

### For the potatoes

4 baking potatoes (200 g each)

1 tbsp. oil

2 tsp. salt

### For the dip

150 g sour cream

30 g chives | finely chopped

A pinch of salt

A pinch of pepper

1 pinch of ground nutmeg

### For the topping

100 g diced bacon

½ bunch of spring onions | sliced into thin rings

200 g mature cheese (e.g. Gruyère, Sbrinz and Emmental) | grated

### Accessories

Grilling and roasting insert

Universal tray

### Preparation

Wash the potatoes thoroughly and dry them. Prick the potatoes all over with a fork. Then rub with a generous amount of oil and salt. Place the grilling and roasting insert on the universal tray, place the potatoes on top and bake according to cooking stages 1 and 2.

In the meantime, mix the sour cream with the chives to make the dip. Season with salt, pepper and nutmeg to taste.

For the topping, fry the bacon on medium heat until crisp. Get the spring onions ready.

After cooking stage 2, take the potatoes out of the oven. Carefully cut them in half and place them back on the grilling and roasting insert with the cut side facing up. Sprinkle with cheese and bake until golden brown using the settings indicated for cooking stage 3.

Serve the baked potatoes with the spring onions, bacon and dip.

### Settings

Cooking stage 1

Oven function:  | AirFry

Temperature: 200 °C

Duration: 20 minutes

Shelf level: 2

Cooking stage 2

Oven function:  | AirFry

Temperature: 180 °C

Duration: 30 minutes

Cooking stage 3

Oven function: 

Temperature: 180 °C

Duration: 10 minutes

Shelf level: 3

# AirFry recipes

---

## Baked potatoes with feta, tzatziki and Greek salad

Preparation time: 70 minutes

Serves 4

### For the potatoes

4 baking potatoes (200 g each)

1 tbsp. oil

2 tsp. salt

### For the tzatziki

½ cucumber

¼ tsp. salt

200 g Greek style natural yoghurt

1 clove of garlic | finely chopped

¼ tsp. salt

A pinch of pepper

½ lemon | juice and zest

### For the salad

½ cucumber | diced

3 tomatoes | diced

1 yellow capsicum | finely diced

1 red capsicum | finely diced

1 red onion | finely diced

### For the dressing

½ tsp. salt

A pinch of pepper

½ lemon | juice only

1 tsp. dill, chopped

### For the topping

200 g feta | crumbled

### Accessories

Grilling and roasting insert

Universal tray

### Preparation

Wash the potatoes thoroughly and dry them. Prick the potatoes all over with a fork. Then rub with a generous amount of oil and salt. Place the grilling and roasting insert on the universal tray, place the potatoes on top and bake according to cooking stages 1 and 2.

In the meantime, grate and salt the cucumber for the tzatziki and leave for 10 minutes.

Squeeze the liquid out of the cucumber. Mix the squeezed cucumber with the yoghurt and garlic. Then add salt, pepper, lemon juice and lemon zest to taste.

For the salad, put the vegetables in a bowl.

For the dressing, mix together the salt, pepper, dill, lemon juice and olive oil. Pour the dressing over the salad. Set aside until ready to serve.

After cooking stage 2, take the potatoes out of the oven. Carefully cut them in half and place them back on the grilling and roasting insert with the cut side facing up. Sprinkle with feta and bake until golden brown using the settings indicated for cooking stage 3.

Serve the baked potatoes with the tzatziki and salad.

### Settings

Cooking stage 1

Oven function:  | AirFry

Temperature: 200 °C

Duration: 20 minutes

Shelf level: 2

Cooking stage 2

Oven function:  | AirFry

Temperature: 180 °C

Duration: 30 minutes

Cooking stage 3

Oven function: 

Temperature: 180 °C

Duration: 10 minutes

Shelf level: 3

## Zucchini chips with blue cheese dip and chilli sauce

Preparation time: 55 minutes

Serves 2

### For the vegetables

2 zucchinis  
3 medium eggs  
50 ml milk, 3.5% fat  
1 tbsp. sunflower oil  
200 g panko breadcrumbs  
2 tsp. salt  
½ tsp. garlic powder  
½ tsp. onion, granulated  
¼ tsp. black pepper | coarsely ground  
100 g mature Alpine cheese | grated  
100 g plain white flour

### For the blue cheese dip

150 g blue cheese, strong  
2 tbsp. mayonnaise  
80 g yoghurt, 3.5% fat  
A pinch of salt  
A pinch of pepper  
¼ tsp. paprika, smoked

### For serving

1 tsp. sriracha sauce

### Accessories

Grilling and roasting insert  
Hand-held blender  
Universal tray

### Preparation

Halve the zucchinis crosswise and cut each half into 8 equal pieces.

Whisk the eggs, milk and oil together in a shallow bowl.

In another bowl, mix together the panko breadcrumbs, spices and Alpine cheese. Place the flour in a third bowl. Now coat the zucchini pieces with the breadcrumbs.

To do this, first turn the zucchini pieces in the flour, then in the egg mixture. Then coat them evenly with the panko mixture. For a particularly even and crispy coating, turn the pieces in the egg and panko mixtures a second time.

Place the grilling and roasting insert on the universal tray, place the zucchini pieces on top and bake according to the settings. Turn after 15 minutes and bake for a further 10 minutes.

To make the dip, blend all the ingredients for around 1 minute. Blending for too long may cause the dip to separate. Chill the dip until ready to serve.

Serve the zucchini chips with the dip and drizzle with the sriracha sauce.

### Settings

Oven function:  | AirFry  
Temperature: 205 °C  
Duration: 25 minutes  
Shelf level: 2

# AirFry recipes

---

## Corn grilled with hoisin glaze and coleslaw

Preparation time: 40 minutes

Serves 4

### For the dressing

100 g mayonnaise  
½ tbsp. cider vinegar  
1 tbsp. mustard  
½ tsp. caster sugar  
A pinch of salt  
A pinch of pepper

### For the salad

¼ white cabbage | thinly sliced  
¼ red cabbage | thinly sliced  
2 carrots | thinly sliced

### For the corn with hoisin glaze

4 cobs, pre-cooked | quartered  
50 g hoisin sauce  
50 g mayonnaise

### For serving

2 tbsp. sesame seeds, white

### Accessories

Grilling and roasting insert  
Universal tray

### Preparation

For the dressing, mix together the mayonnaise, cider vinegar, mustard and sugar. Season with salt and pepper to taste. For the salad, mix together the white cabbage, red cabbage and carrots in a bowl. Pour the dressing over the salad and fold in. Set the salad aside until ready to serve.

Place the grilling and roasting insert on the universal tray, place the corn cobs on top and cook according to the settings.

For the glaze, mix together the hoisin sauce and mayonnaise. After 15 minutes, brush the corn with the hoisin mixture and cook for a further 10 minutes.

Sprinkle the cobs with the sesame seeds to taste. Serve with coleslaw.

### Setting

Oven function:  | AirFry  
Temperature: 210 °C  
Duration: 25 minutes  
Shelf level: 2



## Chicken nuggets with coconut sesame coating

Preparation time: 25 minutes

Serves 2

### For the coating

100 g breadcrumbs  
50 g sesame seeds, white  
50 g desiccated coconut  
2 tsp. salt  
1 tsp. paprika, smoked  
1 tsp. garlic powder  
1 tsp. onion powder  
100 g plain white flour  
3 medium eggs  
½ tbsp. vegetable oil  
1 ½ tbsp. milk, 3.5% fat

### For the chicken nuggets

2 chicken breast fillets, ready to cook |  
in finger-width strips

### For serving

2 tsp. sweet chilli sauce

### Accessories

Gourmet baking and AirFry tray,  
perforated

### Preparation

For the coating, mix together the breadcrumbs, sesame seeds, desiccated coconut, salt, paprika, onion powder and garlic powder in a bowl. Place the flour in another bowl. Whisk the eggs, oil and milk together in a third bowl.

Now coat the chicken strips with the breadcrumbs.  
To do this, first turn the chicken strips in the flour, then in the egg/oil mixture. Then coat them with the breadcrumb/spice mixture. Place the coated nuggets

directly on the Gourmet baking and AirFry tray and cook according to the settings. Turn after 10 minutes.

Serve the cooked chicken nuggets with the sweet chilli sauce.

### Setting

Oven function:  | AirFry

Temperature: 210 °C

Duration: 15 minutes

Shelf level: 2

# AirFry recipes

---

## Blue eye trevalla with crust

Preparation time: 70 minutes

Serves 4

### For the blue eye trevalla with crust

60 g butter | softened  
1 tbsp. mustard  
50 g sundried tomatoes in oil  
½ bunch of parsley, flat leaf  
½ bunch of chives  
½ tbsp. lemon thyme  
60 g panko breadcrumbs  
4 blue eye trevalla (or ling) fillets (150 g each), ready to cook  
4 pinches of salt

### For the capsicum and potato salad

2 capsicums, red | roughly chopped  
2 capsicums, yellow | roughly chopped  
200 g potatoes, firm | cut into thin wedges  
1 onion, red | cut into thin wedges  
1 clove of garlic | crushed  
½ tbsp. olive oil  
½ tsp. salt  
¼ tsp. paprika, smoked

### For the dressing

30 ml balsamic vinegar  
1 tbsp. mustard  
2 tbsp. honey  
A pinch of salt  
A pinch of pepper  
60 ml olive oil

### For serving

125 g rocket | washed

### Accessories

Hand-held blender  
Grilling and roasting insert  
Universal tray  
Screw-top jar

### Preparation

For the crust, blend together the butter, mustard, sundried tomatoes, parsley, lemon thyme and chives. Fold in the panko breadcrumbs and season with salt to taste. Pat the fish fillets dry and salt them. Shape the crust into 4 pieces corresponding to the size of the fish fillets and place them on the fish. Place the grilling and roasting insert on the universal tray. Place the fish on the left side of the grilling and roasting insert.

For the vegetables, place the two types of capsicum, potato wedges, onions and garlic in a bowl, drizzle with oil and season. Then spread out the vegetables on the right side of the grilling and roasting insert. Place the tray in the oven and roast the blue eye trevalla and vegetables using the indicated settings.

For the dressing, mix together the balsamic vinegar, mustard, honey, salt and pepper in a screw-top jar. Add the olive oil, seal the jar and shake vigorously for approx. 1 minute.

Before serving, mix the rocket with the warm vegetables and marinate the salad with the dressing. Serve the fish on the salad.

### Settings

Oven function:  | AirFry  
Temperature: 210 °C  
Duration: 20 minutes  
Shelf level: 2

## Bananas with pistachio and honey topping

Preparation time: 25 minutes

Serves 4

### Ingredients

50 g pistachio nuts | shelled

A pinch of salt

4 bananas

2 tbsp. wild honey

### Settings

Oven function:  | AirFry

Temperature: 200 °C

Duration: 8 minutes

Shelf level: 2

### Accessories

Pan

Grilling and roasting insert

Universal tray

### Preparation

Roughly chop the pistachios and toast lightly in the pan. Add the salt. Remove the pan from the cooktop and leave to cool slightly.

Place the grilling and roasting insert on the universal tray. Cut the bananas in half lengthways (still in the skin) and place them on the grilling and roasting insert with the cut side facing up. Mix the honey with the pistachios. Spread the pistachio/honey mixture over the banana halves. Place the bananas in the oven and cook.

# AirFry recipes

---

## Portuguese custard tarts

Preparation time: 60 minutes

Serves 12

### For the tarts

2 medium eggs  
37 g vanilla custard powder for cooking  
200 ml milk, 3.5% fat  
250 ml cream  
70 g caster sugar  
A pinch of salt  
Approx. 275 g puff pastry

### For dusting

1 tsp. icing sugar  
A pinch of cinnamon

### For the tin

1 tsp. butter

### Accessories

Sieve  
Muffin tin for 12 muffins  
Whisk  
Rolling pin  
Rack

### Preparation

Whisk the eggs and press through a sieve. Mix 2 ½ tbsp. of the milk with the custard powder and the eggs until smooth. Bring the rest of the milk, the cream, sugar and salt to the boil while stirring. Remove the pan from the cooktop and add the custard mixture while stirring. Bring everything to the boil while stirring. Pour the mixture into a bowl, cover and chill.

Grease the muffin tin. Roll out the puff pastry and cut out 12 circles with a diameter of 10 cm. Place the circles in the recesses of the muffin tin and press

in firmly so there are no bubbles in the base and the dough does not protrude out of the recesses.

Divide the custard mixture between the 12 recesses. Place the muffin tin in the oven on the baking and roasting rack. Bake the tarts until brown spots appear on the custard mixture.

Mix together the icing sugar and cinnamon and sprinkle it over the tarts while still warm. Remove the tarts from the tin while still warm and leave to cool on the baking and roasting rack.

### Settings

Oven function:  | AirFry  
Temperature: 200 °C  
Duration: 18 minutes  
Shelf level: 2

## Vegan Portuguese custard tarts

Preparation time: 60 minutes

Serves 12

### For the tarts

500 ml oat milk

40 g potato starch

40 g caster sugar

1 vanilla pod

Approx. 275 g puff pastry

¼ tsp. ground cinnamon

### For serving

¼ tsp. ground cinnamon

### Accessories

Muffin tin for 12 muffins

Whisk

Ovenproof dish

Rolling pin

Rack

### Preparation

Mix 2 tbsp. of oat milk with the potato starch and set aside. Bring the rest of the oat milk to the boil with the sugar, vanilla seeds and vanilla pod. Stir the oat milk that was mixed with the potato starch into the boiling oat milk. Bring the thickened mixture to the boil for approx. 1 minute while stirring, then pour into a bowl, cover and leave to cool.

Roll the puff pastry into a tight roll, cut into 12 pieces and chill. Take out one pastry piece at a time and roll out into a circle with a diameter of approx. 10 cm. Place the circle into a recess of the muffin tin and press in firmly so there are no bubbles in the base and the dough does not protrude out of the recess. Repeat the process with the remaining 11 pastry pieces.

Fill the recesses max.  $\frac{3}{4}$  with the custard mixture. Place the muffin tin in the oven on the baking and roasting rack and bake the tarts immediately using the indicated settings. To achieve the typical flavour, the Portuguese custard tarts should have a few very dark spots on top. Dust with cinnamon before serving.

### Settings

Cooking stage 1

Oven function:  | AirFry

Temperature: 210 °C

Duration: 25 minutes

Shelf level: 2

Cooking stage 2

Oven function:  | AirFry

Temperature: 245 °C

Duration: 10 minutes

Shelf level: 2

## Copyright and licences for the communication module

For the purpose of operating and controlling the communication module, Miele uses proprietary or third-party software that is not covered by open source licensing terms. These items of software/software components are protected by copyright. The copyright powers of Miele and third parties must be respected.

In addition, the communication module contains software components which are distributed under open source licensing terms. The open source components contained in the appliance along with the corresponding copyright notices, copies of the licensing terms valid at the time, and any further information can be accessed locally via IP using a web browser (*http://<IP address>/Licenses*), where <IP address> is the IP address of the appliance. The liability and warranty arrangements for the open source licences displayed in this location only apply in relation to the respective rights holders.

**Miele Australia Pty. Ltd.**

ACN 005 635 398

ABN 96 005 635 398

Level 4, 141 Camberwell Road  
Hawthorn East, VIC 3123

**1300 464 353 (1300 4 MIELE)**

**info@miele.com.au**

**www.miele.com.au**

**Miele New Zealand Limited**

IRD 98 463 631

8 College Hill  
Freemans Bay, Auckland 1011

**0800 464 353 (0800 4 MIELE)**

**customercare@miele.co.nz**

**www.miele.co.nz**

**Miele Global Headquarters**

**Germany**

**Miele & Cie. KG**

Carl-Miele-Straße 29

33332 Gütersloh

Federal Republic of Germany

H 2465 BP, H 2467 BP, H 2851 BP, H 2861 BP

en-AU, NZ

M.-Nr. 12 433 280 / 05