









Operating and Installation Instructions Commercial washer-dryer stack PDW 909

Always read the operating instructions before setting up, installing, and commissioning the machine. This prevents both personal injury and damage to the appliance.

en-US

Contents

Caring for the environment	8
IMPORTANT SAFETY INSTRUCTIONS	9
Explanation of the safety notes and warnings on the machine	9
Appropriate use	10
Foreseeable misuse	11
Technical safety	12
Correct use.....	14
Chlorine and component damage.....	17
Accessories	18
Disposing of your old machine	18
Description of the machine	19
Description of the machine.....	19
Operating	21
Control panel.....	21
Sensor controls and touch display.....	22
Main menu	22
Main menu	23
“☐ Programs” menu	23
“★ Favorites” menu.....	23
“⚙ Supervisor” menu	23
Examples of how to operate the machine	23
Operating a laundromat machine	27
Washing	28
Preparing for use	28
Loading and switching on the washing machine	28
Loading the washing machine	28
Washing with detergent drawer	31
Adding detergent using the detergent drawer.....	31
Adding fabric softener or liquid starch separately	31
Adding starch separately	31
Selecting a program	33
Selecting program settings	33
Selecting Extras	37
Pre-wash 	37
Soak 	37
Rinse plus 	37
Rinse hold 	37
Filling stop 	37
Intensive 	37
Water plus 	37
Program start – program end	38
Timer	39
Special features in the program sequence	40
Spinning	40
Anti-crease	40
Skip	41
Manual control.....	41

Drying	44
1. Notes on correct laundry care	44
Washing before drying	44
Removing foreign objects	44
Care symbols	44
2. Loading the tumble dryer	44
3. Selecting a program	45
Switching on the tumble dryer	45
4. Selecting program settings	46
Selecting the drying level	46
Selecting extra options	46
5. Starting a program	48
Calling up current program parameters	48
Program runtime/estimated time remaining	48
Program end	48
End of the program	48
Removing the laundry	49
Care notes	49
Timer	49
Prerequisite for setting the timer	49
Setting the timer	49
Changing the program sequence	50
Washing machine	50
Changing a program	50
Interrupting a program	50
Switching on the washing machine after a power failure	50
Adding or removing laundry	52
Tumble dryer	53
Changing a program once it has started	53
Canceling the current program	53
Adding laundry	53
Time left	53
Frequently asked questions	55
Troubleshooting	55
Opening the door in the event of a blocked drain outlet and/or power outage	56
Miele Service	58
Frequently asked questions	58
A program cannot be started	58
Program cancellation and fault message	59
The display shows a message	59
Insufficient wash results	60
Insufficient drying results	60
General problems with the washer-dryer stack	62
The door will not open or close	63
Cleaning and care	64
Build-up of rust	64
Cleaning the detergent drawer, detergent compartments, and siphons	65
Cleaning the water inlet filters	67

Contents

Cleaning the lint filter.....	68
Removing the lint filter.....	68
Dismantling the lint filter	68
Cleaning the lint filter parts (dry).....	69
Cleaning the lint filter parts (wet).....	69
Inserting the lint filter.....	69
Cleaning the air guide	71
Rapid cleaning.....	71
Additional cleaning	71
INSTALLATION INSTRUCTIONS	74
General operating conditions	74
Facilitating maintenance	75
PDW 909	75
Installing the washer-dryer stack.....	76
Shipping struts.....	78
Leveling	80
Securing the machine	81
Plumbing.....	83
Use of non-return valves	83
Cold water connection.....	84
Using the machine in cold water mode.....	84
Hot water connection	84
Using the machine in hot water mode	84
Electrical connection	85
Supply air and exhaust air management.....	86
Ventilation.....	86
Exhaust air management	86
Calculating the total ducting length.....	88
Exhaust duct dimensions	90
Exhaust air management with plug-in pipes.....	90
Exhaust air management with flexible aluminum hose.....	91
Shared exhaust air duct	91
Reference to external machines.....	93
Optional accessories	93
Washing machine accessories	93
Tumble dryer accessories.....	95
Washing machine supervisor level	96
Opening the supervisor level	96
Opening the supervisor level (self-service)	96
Code-based access	96
Changing the code	96
Closing the Settings menu.....	96

Controls / Display.....	97
Language.....	97
Language entry.....	97
Set languages.....	97
Time.....	97
Date.....	97
Logo.....	98
Start screen.....	98
Mode.....	98
Display brightness.....	98
Display off status.....	98
Machine off status.....	98
Volume.....	98
Visibility parameters.....	98
Delay start.....	99
Memory.....	99
Manual control.....	99
Change order.....	99
Measuring system.....	99
Supervisor code.....	99
Wi-Fi.....	99
Program selection.....	100
Controls.....	100
Program packages.....	101
Favorite programs.....	101
Sort programs.....	101
Program color allocation.....	101
Expert code.....	101
Process technology.....	102
Anti-crease.....	102
Automatic drainage.....	102
Service.....	102
Service interval.....	102
External applications.....	102
Payment system lock.....	102
Connector box.....	102
Automatic dispensing.....	102
Dosage.....	103
Peak load prevention.....	103
Machine parameters.....	103
Maximum spin speed.....	103
Max. adjust. temperature.....	103
Legal Information.....	103
Tumble dryer supervisor level.....	104
Opening the Supervisor level.....	104
Access via code.....	104
Change code.....	104
Closing the settings menu.....	104

Contents

Controls / Display.....	104
Language.....	104
Language entry.....	104
Set languages.....	105
Display brightness.....	105
Clock display.....	105
Date.....	105
Volume.....	105
Res. moisture display.....	105
Visibility parameters.....	106
Display off status.....	106
Machine off status.....	106
Delay start.....	106
Memory.....	107
Temperature unit.....	107
Weight unit.....	107
Change code.....	107
Program selection.....	107
Controls.....	107
Program packages.....	108
Favorite programs.....	108
Special programs.....	109
Sort programs.....	110
Program color allocation.....	110
Process technology.....	110
Anti-crease.....	110
Drying levels.....	110
Additional cooling.....	111
Cooling down temperature.....	111
Fan pulsed operation.....	111
Service.....	111
Clean out the airways.....	111
Clean the filters.....	112
Service interval.....	112
External applications.....	113
External exhaust flap.....	113
Additional fan.....	113
Pressure sensor.....	113
Peak load signal.....	113
Peak load prevention.....	113
Select KOM module.....	114
Availability of Miele digital products.....	114
WiFi / LAN.....	114
Network time.....	114
Remote.....	115
Remote Update.....	115
SmartGrid.....	115
Machine parameters.....	116
Legal information.....	116

Networking	117
Pairing instructions	117
Network connection.....	117
Opening the supervisor level	117
Initial network setup.....	117
Setting up a network connection manually	118
Establishing the network connection via WPS	119
Establishing the network connection via soft AP	120
Establishing the network connection using a LAN cable.....	120
Wi-Fi/LAN interface configured	121
Technical data	121
Technical data	123
PDW 909 machine data	123
Electrical connection.....	123
Installation dimensions.....	123
Weight and floor load.....	123
Water connection	123
Supply air	123
Exhaust air	124
Emission values.....	124
Product safety	124
WiFi.....	124
WiFi data protection	125
Data protection and data security	125
Factory default settings for network configuration	125
Copyrights and licenses	125

Caring for the environment

Disposal of the packing material

The cardboard box and packing materials protect the appliance during shipping. They have been designed to be biodegradable and recyclable.

Ensure that any plastic wrappings, bags, etc. are disposed of safely and kept out of the reach of children. Danger of suffocation!

Disposing of your old machine

Old electrical and electronic machines often contain valuable materials. However, they also contain harmful substances which were essential for their correct functioning and safety. These could be hazardous to human health and to the environment if disposed of with household waste or if handled incorrectly. Therefore, please do not dispose of your old machine with household waste.

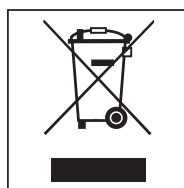

Please dispose of it at your local community waste collection/recycling center. Consult your dealer if necessary. Please ensure that your old machine poses no risk to children while being stored for disposal.

Energy saving tips

Energy and water consumption

- Make use of the **maximum** load size that the wash program can accommodate. The most efficient use of energy and water is achieved when a full load is washed.
- If suitable, use programs from the Eco program package. The programs are characterized by particularly low energy consumption.

Detergent

- Do not exceed the amounts of detergent recommended on the packaging.
- Reduce the amount of detergent for smaller load sizes.





When drying with a tumble dryer

Select the highest possible spin speed for the wash program to save energy in the subsequent drying cycle.

IMPORTANT SAFETY INSTRUCTIONS

Original operating instructions

Explanation of the safety notes and warnings on the machine

	Read the operating instructions
	Warning, hot surfaces
	Warning, voltage up to 1,000 volts
	Protective ground
	Equipotential bonding

This washer-dryer stack complies with all relevant current safety requirements. Inappropriate use can, however, lead to personal injury and material damage.

Read the operating instructions carefully before using the washer-dryer stack. They contain important information on safety, installation, use, and maintenance. This prevents both personal injury and damage to the washer-dryer stack.

In accordance with standard IEC 60335-1, Miele strongly advises that you read and follow the instructions in the chapter on installing the washer-dryer stack as well as the IMPORTANT SAFETY INSTRUCTIONS.

Miele cannot be held liable for injury or damage caused by non-compliance with these instructions.

Keep these operating instructions in a safe place and pass them on to any future user.

When instructing other people how to use the washer-dryer stack, they must be made aware of these IMPORTANT SAFETY INSTRUCTIONS.

IMPORTANT SAFETY INSTRUCTIONS

Appropriate use

- ▶ The washing machine is only suitable for washing fabrics with a care label stating that they are suitable for machine washing. Any other applications may be dangerous. The manufacturer cannot be held liable for damage resulting from incorrect or improper use or operation of the machine.
- ▶ The tumble dryer is intended exclusively for drying textiles washed in water which have been labeled as suitable for tumble drying by the manufacturer on the care label. Any other applications may be dangerous. Miele cannot be held liable for damage resulting from incorrect or improper use or operation.
- ▶ The washer-dryer stack must be used as described in the operating instructions and must be checked on a regular basis to make sure it is functioning correctly.
- ▶ The washer-dryer stack is not suitable for outdoor use.
- ▶ Do not install the washer-dryer stack in a room where there is a risk of frost. Frozen hoses are at risk of tearing or bursting. The reliability of the electronic module may be impaired at temperatures below freezing point.
- ▶ This washer-dryer stack is intended only for use in a commercial environment.
- ▶ The washer-dryer stack must not be used in a non-stationary installation site (e.g., on a ship).
- ▶ This washer-dryer stack can only be used by people with reduced physical, sensory, or mental capabilities, or lack of experience or knowledge, if they are supervised while using it or have been shown how to use it in a safe way and understand and recognize the consequences of incorrect operation.
- ▶ Children must not be allowed near the washer-dryer stack.
- ▶ Disinfection programs must not be interrupted, as this can have a limiting effect on the disinfection result. It is the operator's responsibility to ensure that the standard of disinfection in thermal as well as chemo-thermal procedures is maintained by carrying out suitable validation tests.

IMPORTANT SAFETY INSTRUCTIONS

Foreseeable misuse

▶ Never use solvent-based cleaning agents, e.g., those containing benzene, in the washer-dryer stack. This may result in damage to component parts and create toxic fumes. **Risk of fire and explosion!**

▶ When washing with high temperatures, remember that the porthole glass becomes hot. Do not touch it during the wash process.

Danger of injury by burning!

▶ Close the drum door after each wash or drying cycle.

▶ Do not damage, remove, or bypass the safety features or control elements of the washer-dryer stack.

▶ Machines with damaged control elements or cable insulation may only be replaced by the manufacturer/Miele Service or a qualified electrician.

▶ Water used for washing in this machine consists of suds and is not drinking water! Drain the suds into a proper drainage system.

▶ Always make sure that the drum is stationary before reaching in to remove laundry. Reaching into a rotating drum is extremely dangerous and may result in injury.

▶ Be careful not to put your hands in the gap between door and frame when closing the drum door.

Please note: The drum door is locked automatically as soon as the washing machine starts.

▶ It is particularly important to observe the manufacturer's instructions when using a combination of cleaning agents and special application products. Products must only be used for applications approved by the manufacturer to avoid any material damage or the occurrence of strong chemical reactions.

IMPORTANT SAFETY INSTRUCTIONS

Technical safety

- ▶ Before setting up the washer-dryer stack, check it for any externally visible damage. Do not install or use a damaged washer-dryer stack.
- ▶ The electrical safety of this washer-dryer stack can only be guaranteed when correctly grounded. It is essential that this standard safety requirement is observed and regularly tested. If in any doubt, please have the electrical installation inspected by a specialist. Miele cannot be held liable for the consequences of an inadequate grounding system.
- ▶ Unauthorized repairs could result in unforeseen dangers for the user, for which the manufacturer cannot accept liability. Repairs must only be carried out by a Miele authorized technician, otherwise any subsequent damage will not be covered by the warranty.
- ▶ Do not make any alterations to the washer-dryer stack, unless authorized to do so by Miele.
- ▶ Disconnect the washer-dryer stack from the power supply in the event of a fault and for cleaning and maintenance. The washer-dryer stack is only electrically disconnected from the power supply when:
 - Both washer-dryer stack electrical plugs have been disconnected from the socket or
 - The circuit breakers for both machine parts are disconnected or
 - The circuit breakers for both machine parts have been completely removed.

See “Installation and connection – Electrical connection”.

- ▶ The washing machine may only be connected to the water supply using the set of hoses supplied with the machine. Old sets of hoses must not be re-used. Check the sets of hoses regularly for signs of wear. Change the sets of hoses ahead of time to avoid the risk of leaks and subsequent water damage.
- ▶ The cause of any leaks must be dealt with before the washer-dryer stack is restarted. Disconnect the washer-dryer stack immediately if any water leaks out.
- ▶ Faulty components must only be replaced by genuine Miele replacement parts. Miele can only guarantee the safety standards of the machine when Miele replacement parts are used.
- ▶ All relevant national provisions and regulations relating to accident insurance are applicable to this washer-dryer stack.
- ▶ Please observe the instructions in “Installation and connection” and “Technical data”.
- ▶ The electrical plugs for the washer-dryer stack must always be kept accessible so that the washer-dryer stack can be easily disconnected from the power supply.
- ▶ For hard-wired machines, an all-pole means of deactivation must be provided on site.
- ▶ If the washer-dryer stack is to be hard-wired, there must be a means of disconnecting all poles from the power supply. The disconnection switches must be close to the washer-dryer stack and be clearly identifiable, unhindered, and easily accessible at all times.
- ▶ The tumble dryer may only be operated when the ducting has been installed and the room is sufficiently ventilated in accordance with all local codes.

IMPORTANT SAFETY INSTRUCTIONS

► The ducting must never be installed in any of the following flues or shafts:

- Chimneys or smokestacks that are in use.
- Shafts that are used to ventilate installation rooms with fireplaces.
- Flues that are used by third parties.

Smoke or exhaust gas that is fed back into the flue or shaft may be toxic.

► Regularly check all components in the ducting (e.g., wall pipe, external grille, bends, elbows, etc.) to make sure that air can move through them and to ensure that they are working properly. Clean components when necessary. Lint deposits in the ducting system will prevent the air from being extracted properly and, as a result, will stop the tumble dryer from working properly.

If existing ducting is due to be used, it must be checked before being installed in the tumble dryer.

Low pressure must not occur in the ducting.

► There is a risk of suffocation and poisoning due to exhaust gases being sucked back if gas-powered flow heaters, gas-powered room heaters, coal-burning stoves with a flue connection, etc., are installed in the same room, in the same apartment, or in neighboring rooms and the negative pressure is 0.58 psi (4 kPa) or more.

The following measures for suitable room ventilation (examples) can help to prevent negative pressure in the installation area:

- Install vents that cannot be closed in the exterior walls.
- Use window switches so that the tumble dryer can only be switched on when a window is open.

Always seek approval from the appropriate authority (gas installer, chimney sweep, etc.) to confirm that the machine can be operated without risk and that negative pressure of over 0.58 psi (4 kPa) can be prevented.

► If multiple tumble dryers are to be connected to one exhaust air duct, a non-return flap must be installed directly on the duct for each tumble dryer.

If this requirement is not observed, the tumble dryers may be damaged and their electrical safety could be affected.

► Follow the instructions in “Installing the ducting”.

► The dryer, when installed, must be electrically grounded in accordance with local codes or, in the absence of local codes, with the National Electrical Code, ANSI/NFPA 70, or the Canadian Electrical Code, CSA C22.1.

► The dryer must not be installed or stored in an area where it will be exposed to water and/or weather.

► Caution: Label all wires prior to disconnection when servicing controls. Wiring errors can cause improper operation.

IMPORTANT SAFETY INSTRUCTIONS

Correct use

- ▶ The maximum dry laundry load size is 22 lb (10 kg). See the “Program chart” for the maximum recommended load sizes for individual programs.
- ▶ Before commissioning the washing machine, check that the shipping struts have been removed (see “Installation – Removing the shipping struts”). During spinning, shipping struts that are still in place may result in damage to both the washer-dryer stack and adjacent furniture or machines.
- ▶ Never try to open the drum door of the washing machine using force. The door can only be opened when a corresponding message appears in the display.
- ▶ Do not push back the soft mount drum of the machine while the machine is running.
- ▶ When closing the drum door there is a danger of crushing and shearing between the door frame and the drum opening and also at the hinges.
Caution: The drum door locks automatically when the machine is started.
- ▶ Turn off the water inlet if the washing machine is to be left for any length of time (e.g., during vacation), especially if there is no floor drain (gully) in the immediate vicinity.
- ▶ Take care to ensure that foreign objects (e.g., nails, pins, coins, paper clips) do not find their way into the machine with the laundry. These may damage components of the machine (e.g., suds container, drum). Damaged components can damage the laundry.
- ▶ If the correct amount of detergent is dispensed, the washing machine should not need to be descaled. If, however, you do wish to descale your washing machine, only use proprietary non-corrosive descaling agents. Special descaling agent is available from your Miele dealer or from Miele Customer Service. Strictly observe the instructions for the descaler.
- ▶ Fabrics that have been pre-treated in solvent-based cleaning agents must be thoroughly rinsed in clean water before being washed in the machine. Note that solvent residues may only be discharged into waste water in compliance with local legislation.
- ▶ Never use solvent-based cleaning agents, e.g., those containing benzene, in this washing machine. This may result in damage to component parts and create toxic fumes. **Risk of fire and explosion!**
- ▶ Do not store or use gasoline, paraffin, or any easily flammable substances near the washing machine. Do not use the machine lid as storage space.
Risk of fire and explosion!
- ▶ Do not store chemicals (liquid detergents, additives) on the machine lid. They may cause discoloration or lacquer damage. Accidentally spilled chemicals should be removed from the surface immediately with a wet cloth.
- ▶ Only use dyes, dye removers, and descaling agents suitable for use in a washing machine. The manufacturer’s instructions on the packaging must be observed.
- ▶ Dye removers contain sulfur compounds which can cause damage such as corrosion. Do not use these products in this washing machine.

IMPORTANT SAFETY INSTRUCTIONS

- ▶ Avoid contact between stainless steel surfaces and liquid detergents or disinfecting agents containing chlorine or sodium hypochlorite. These agents can cause corrosion on stainless steel. Aggressive chlorine bleach vapors can also be corrosive. Do not store open containers of these agents near the machine.
- ▶ Do not use a pressure washer or water jet to clean the washer-dryer stack.
- ▶ Never operate the tumble dryer without the lint filter or with a damaged lint filter. This could lead to malfunctions. Lint can clog the air passages, heating elements, and ducting, which could result in a fire. In this case, stop the tumble dryer immediately and replace the damaged lint filter.
- ▶ The lint filter must be cleaned on a regular basis.
- ▶ To ensure problem-free operation of the tumble dryer:
 - Remove the lint from the lint filter after every drying cycle.
 - In addition, the lint filter and the air passages must be cleaned when prompted by the display.
- ▶ To prevent the risk of fire, the following items must not be dried in the tumble dryer:
 - Items which have not been washed.
 - Items which have not been thoroughly cleaned and are still soiled with grease, oil, or other deposits (such as kitchen linens or cosmetics cloths with cooking oils, grease, lotions, etc). If items have not been thoroughly cleaned, there is a danger that they might ignite when heated, even after they have been removed from the tumble dryer at the end of the program.
 - Items (e.g., mops and floor cloths) that have been treated with flammable cleaning agents or which contain residues of acetone, alcohol, benzene, petrol, kerosene, stain remover, turpentine, wax and wax remover, or other chemicals.
 - Items which have been soiled with hair spray, nail polish remover, or similar substances.

Wash heavily soiled items thoroughly by increasing the amount of detergent and selecting a high washing temperature. If in doubt, wash the items several times.

▶ Remove all items from the pockets of the laundry to be dried (e.g., lighters, matches, keys).

▶ **Warning:** Never switch the tumble dryer off before the end of the drying program. If you absolutely must interrupt the program, remove all items immediately and spread them out to cool down.

▶ Risk of fire.

This tumble dryer must not be connected to a controllable socket (e.g., a timer or a device with peak-load negotiation).

The tumble dryer may only be operated with a peak-load device if this is connected to the tumble dryer via the Miele XCI box and the relevant settings have been configured on the tumble dryer.

There is a risk of the laundry self-igniting if the drying program is canceled before the cooling phase has finished.

IMPORTANT SAFETY INSTRUCTIONS

- ▶ To prevent the risk of fire, the following textiles must never be dried in the tumble dryer:
 - Items which have been cleaned using chemicals (e.g., professional dry-cleaning agents).
 - Items which contain a large proportion of rubber, foam rubber, or rubber-like materials. For example, products made from latex foam rubber, shower caps, waterproof textiles, rubberized articles, and items of clothing and pillows with foam rubber filling.
 - Items which contain padding or fillings (e.g., pillows, jackets) and are damaged. The filling could fall out and cause a risk of fire.
- ▶ Do not expose the tumble dryer to air which contains chlorine, fluorine, or other solvent vapors. This contaminated air can cause a fire.
- ▶ Many programs are followed by a cooling phase to ensure that the items are not too hot to handle when you remove them (this also reduces the risk of the laundry self-igniting). Always remove all items of laundry from the tumble dryer immediately after the cooling phase.

IMPORTANT SAFETY INSTRUCTIONS

Chlorine and component damage

► Frequent use of chlorine products increases the risk of damage to components.

► The use of substances containing chlorine, such as sodium hypochlorite and chlorine bleach in powder form, can result in damage to the protective layer of stainless steel and corrosion on components. Therefore, refrain from using substances containing chlorine. Use oxygen-based bleaching agents instead.

If, however, chlorine bleaching agents are used, an anti-chlorine treatment must always be carried out. Otherwise, both the washing machine components and the laundry may suffer persistent and irreparable damage.

► Anti-chlorine treatment must be carried out immediately after chlorine bleaching agents have been used. Hydrogen peroxide as well as oxygen-based detergents and bleaching agents are suitable for anti-chlorine treatment. The suds must not be drained in between.

Treatments with thiosulfates can result in gypsum-like deposits particularly when used in combination with hard water. This gypsum can build up in the washing machine or cause incrustations on the laundry. Treatment with hydrogen peroxide is recommended over treatment with thiosulfates because hydrogen peroxide neutralizes chlorine.

The exact dispensing quantities and the treatment temperatures required must be set and tested on site in accordance with the dispensing recommendations of the detergent and cleaning agent manufacturers. The laundry must also be tested to check whether it contains any active chlorine residues.

IMPORTANT SAFETY INSTRUCTIONS

Accessories

▶ Only use genuine Miele spare parts and accessories with this machine. Using parts or accessories from other manufacturers will invalidate the warranty, and Miele cannot accept liability.

Disposing of your old machine

▶ Ensure that the door locks are unusable when disposing of or scrapping old washer-dryer stacks. This will prevent the risk of children playing accidentally locking themselves in and endangering their lives.

Miele cannot be held liable for damage caused by failure to comply with these IMPORTANT SAFETY INSTRUCTIONS.

Description of the machine

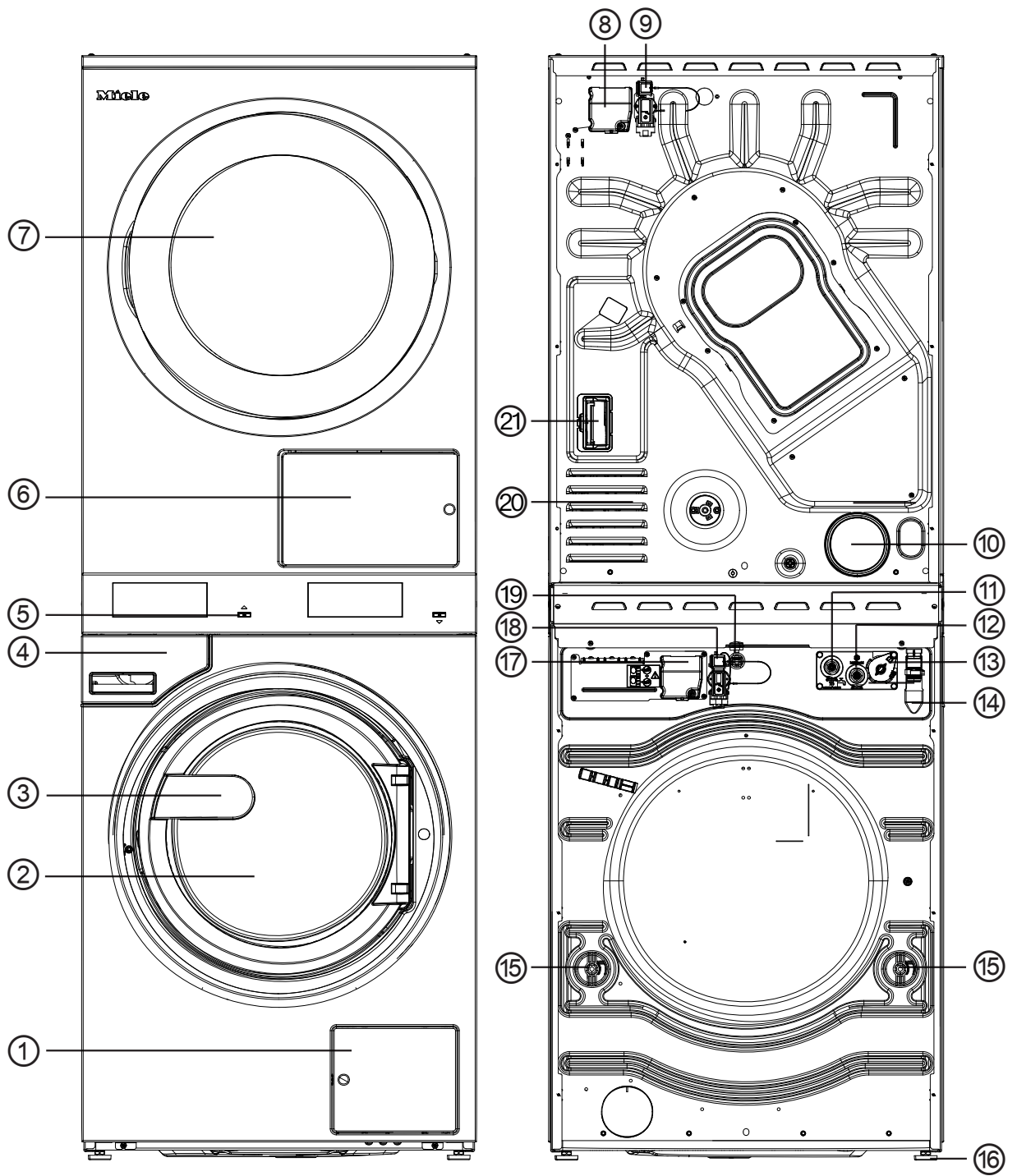





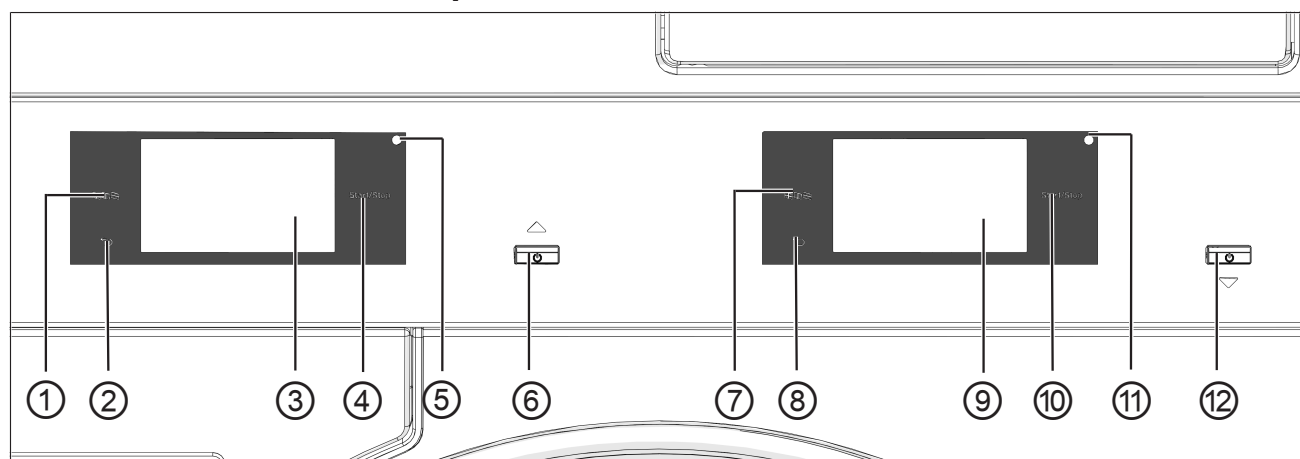

Description of the machine



- ① Access flap to drain filter and drain pump
- ② Washing machine drum door
- ③ Door handle
- ④ Detergent drawer
- ⑤ Display (additional information can be found in the “Operation” section)
- ⑥ Lint filter flap
- ⑦ Tumble dryer drum door
- ⑧ Tumble dryer electrical connection
- ⑨ Interface for communication box
- ⑩ Exhaust duct Ø 4" (100 mm)
- ⑪ Hot water connection
- ⑫ Cold water connection
- ⑬ Interface for external dispensing
- ⑭ Drain hose connection (for drain pump variant)
- ⑮ Shipping struts
- ⑯ 4 height-adjustable screw feet
- ⑰ Washing machine electrical connection
- ⑱ Interface for Connector Box (optional second interface)
- ⑲ Interface for LAN
- ⑳ Intake vents for drying air
- ㉑ Communication module slot

Control panel



- ① **Tumble dryer language sensor control** 
For selecting the current user language. The supervisor language is displayed again at the end of the program.
- ② **Tumble dryer back sensor control** 
Takes you back one level in a menu.
- ③ **Tumble dryer touch display**
- ④ **Start/Stop tumble dryer sensor control**
For starting the program selected and canceling a program once it has started. The program selected can be started as soon as the sensor control starts flashing.
- ⑤ **Tumble dryer optical interface**
For Customer Service.
- ⑥ **Tumble dryer button** 
For switching the tumble dryer on and off. The tumble dryer switches off automatically to save energy. It is switched off an adjustable time after the end of the program/Anti-crease phase, or after being switched on if no further selection is made.
- ⑦ **Washing machine language sensor control** 
For selecting the current user language. The supervisor language is displayed again at the end of the program.
- ⑧ **Washing machine back sensor control** 
Takes you back one level in a menu.
- ⑨ **Washing machine touch display**
- ⑩ **Start/Stop washing machine sensor control**
For starting the program selected and canceling a program once it has started. The program selected can be started as soon as the sensor control starts flashing.
- ⑪ **Washing machine optical interface**
For Customer Service.
- ⑫ **Washing machine button** 
For switching the washing machine on and off.

Sensor controls and touch display

The sensor controls , , and *Start/Stop* and the elements in the display respond to finger tip contact. Every tap of a sensor control is confirmed with an audible keypad tone. You can adjust the volume of the keypad tone or switch it off (see “Supervisor level”).

The control field with sensor controls and the touch display can be scratched by pointed or sharp objects, e.g., pens.
Only touch the control field with your fingers.

Main menu

After switching on the washing machine, the main menu will appear in the display.

You can access all the important submenus from the main menu.

Touch the  symbol at any time to return to the main menu. Values set previously are not saved.

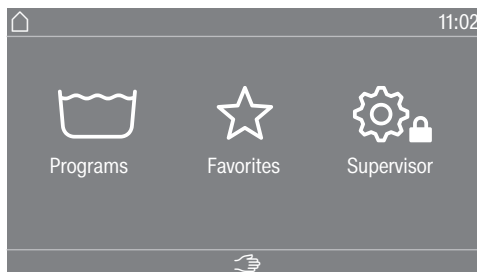

Programs” menu

In this menu, you can select the wash programs.

Favorites” menu

In this menu, you can select 1 favorite program from a total of 24 favorite programs. The wash programs can be set up and saved by the supervisor in the Favorites menu (see “Favorite programs” under “Supervisor level”).

Supervisor” menu

You can alter the washing machine’s user interface to suit changing requirements in the supervisor level (see “Supervisor level”).

Main menu

After switching on the tumble dryer, the main menu will appear in the display. You can access all the important sub-menus from the main menu.

Touch the  sensor button at any time to return to the main menu. Values set previously are not saved.

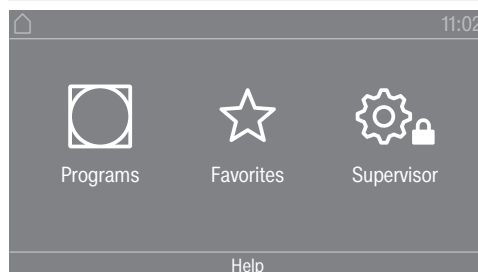

Main menu

Programs” menu

In this menu, you can select the drying programs.

Favorites” menu

In this menu, you can select 1 favorite program from a total of 12 favorite programs. The drying programs can be set up and saved by the supervisor in the Favorites menu (see “Favorite programs” under “Supervisor level”).

Supervisor” menu

You can alter the tumble dryer’s electronic to suit changing requirements in the supervisor level (see “Supervisor level”).

Examples of how to operate the machine

Lists

“Programs” menu (single selection)

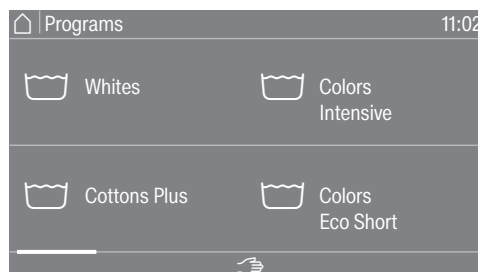

You can scroll right or left by swiping your finger across the screen. To do this, place your finger on the touch display and swipe it in the direction you want.

The orange scroll bar under the pictures shows that there are additional options to choose from.

Touch a program name to select the wash program.

The display will change to the standard menu for that program.

“Extras” menu (multiple selection)

To access the level for selecting Extras, you first need to select a program, e.g., Whites.

Operating

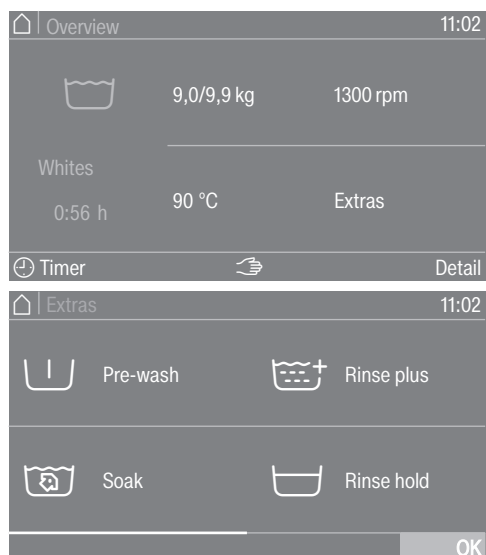

Touch one or several *Extras* to select it/them.
Currently selected *Extras* are highlighted orange.
To deselect an *Extra*, simply touch the *Extra* again.
Use the *OK* sensor control to activate all selected *Extras*.

Setting numerical values

You can set numerical values in some menus.

The following example shows how to set the time of day. The “Supervisor level” section describes how to get to this level.

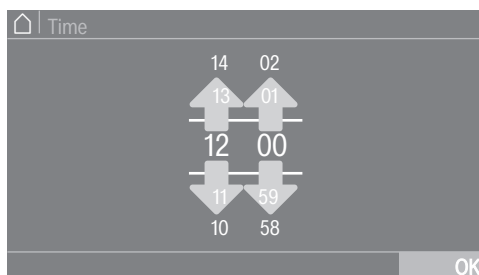

Enter the numbers by swiping upward or downward.

Place your finger on the number that you want to change and move your finger in the direction you want. Use the *OK* symbol to accept the set numerical value.

Tip: A numerical keypad may also appear to adjust the value for some settings.

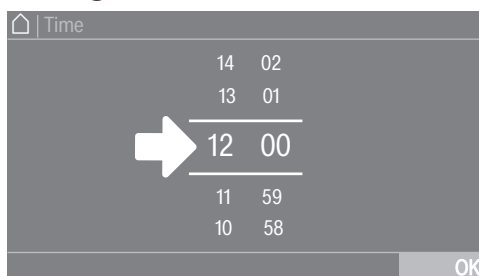

Briefly touching a number between the two lines will bring up the numerical keypad.

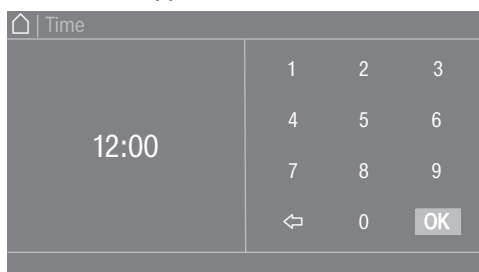

Once a valid number has been entered, the *OK* symbol will be highlighted green.

Operating

Pull-down menu

The following example describes the display for an ongoing wash program. The “Program start – program end” section describes how to get to this level.

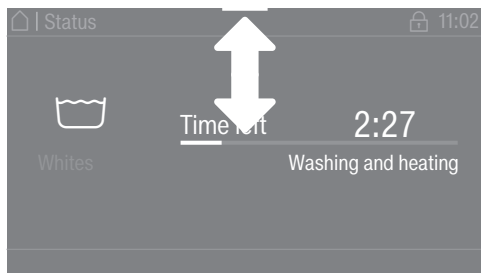

If an orange bar appears at the top of the screen in the middle of the display, you can open the pull-down menu. Touch the bar and drag down with your finger.

Exiting a menu level

- Touch the ↶ symbol to return to the previous screen.

Entries you have made before this which have not yet been confirmed with *OK* will not be saved.

Help display

With some menus, Help appears along the bottom line of the display.

- Touch the Help selection area to display the text.
- Touch the Close selection area to return to the previous screen.

Operating a laundromat machine

The main menu will vary depending on the programming status (see “Supervisor level”).

Shortcuts are the easiest way to operate the machine. Operating staff are unable to change pre-set programs.

Laundromat, basic

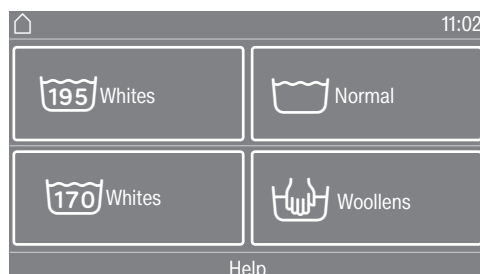

Between 4 and 24 pre-set programs are available. These programs cannot be changed by the user.

Laundromat logo

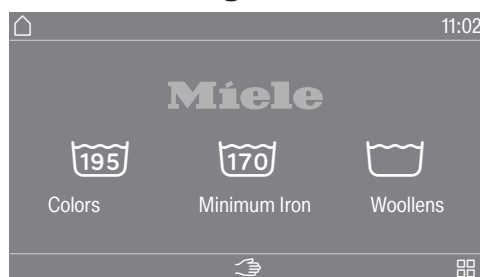

Up to 24 pre-set programs are available. The first 3 programs can be selected directly. The remaining programs are selected from a list . These programs cannot be changed by the user.

Washing

Preparing for use

Emptying pockets

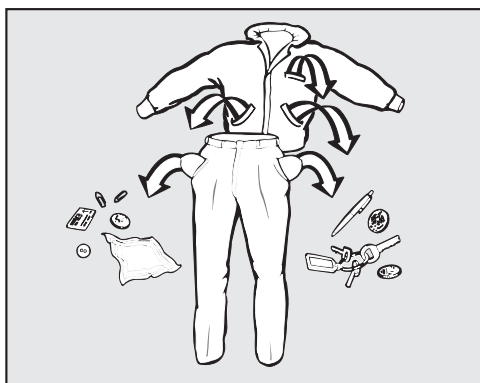

- Empty all pockets.

⚠ Damage due to foreign objects.
Nails, coins, paper clips, and so on can cause damage to garments and components in the machine.
Check the laundry before washing and remove any such foreign objects.

Sorting the laundry

- Sort the laundry according to color and the garment care label.

Preparing mops, all-purpose cloths, etc.

- Shake mops, all-purpose cloths, and pads out well to get rid of coarse soiling before placing them in the washing machine drum.

Pre-treating stains

- Badly soiled areas and stains should be cleaned as soon as possible. Stains should be carefully dabbed off using a soft, colorfast cloth.

General tips

- Do not machine wash items which are specified by the manufacturer as not washable on the care label (☒).
- Curtains: Remove rollers and lead weights or place in a laundry bag.
- Sew in or remove any loose underwiring in bras.
- Turn garments inside out, if recommended by the manufacturer.
- Close any zippers and velcro fasteners before washing.
- Fasten duvet covers and pillow cases to prevent small items from becoming rolled up inside them.
- Please refer to the “Program chart” for more tips and tricks.

Loading and switching on the washing machine

Loading the washing machine

- Prepare the washing machine.
- Switch on the washing machine with the ⏻ button. The welcome screen will light up.
- Open the drum door with the handle.

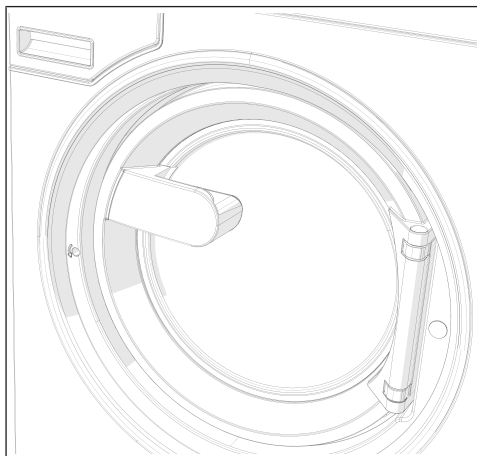

- Unfold the laundry and load loosely into the drum.

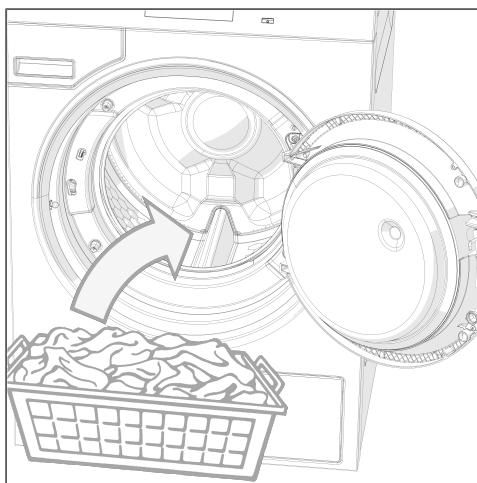

Washing

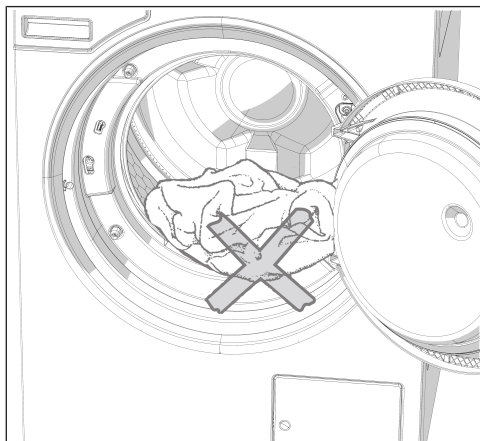

⚠ Make sure that no items are caught between the drum door and the opening.

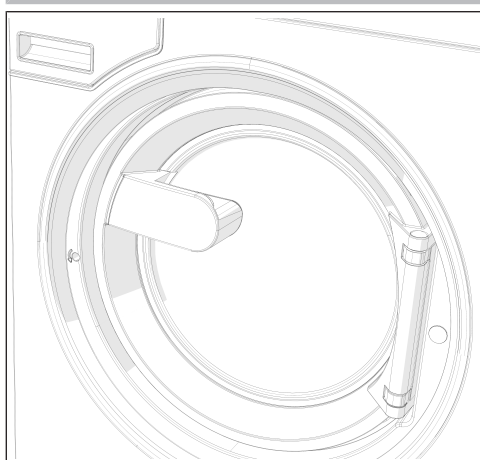





■ Close the drum door by pressing it until the pre-latch engages.

The drum door engages, but is not locked yet. The drum door locks automatically as soon as the machine starts.

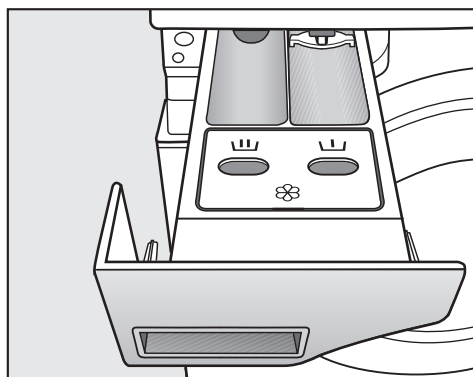
Washing with detergent drawer

Adding detergent using the detergent drawer



- For the standard programs, add powder detergent to the  drawer for the main wash. If desired, add detergent for a pre-wash to the  drawer. Add fabric softener to the front of the  drawer.

Adding fabric softener or liquid starch separately

- Select the Separate Rinse program.
- Change the spin speed if necessary.

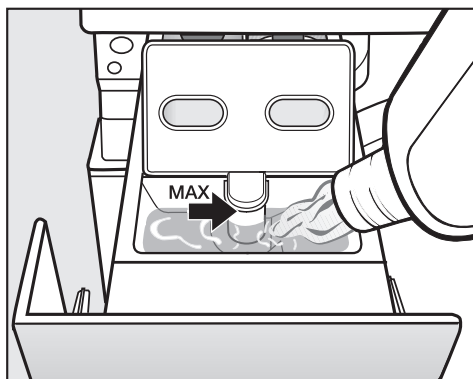

- Add the fabric softener or the liquid starch to the  compartment. **Do not exceed the maximum level mark.**
- Touch the *Start/Stop* sensor control.

Adding starch separately

- Prepare the starch solution in accordance with the manufacturer's instructions on the packaging.
- Select the Starch program.
- Add the prepared starch to the  compartment.
- Touch the *Start/Stop* sensor control.

Tip: If starching separately or automatically, thoroughly clean the detergent drawer regularly.

Washing

Dyes, dye removers, and descaling agents

Proprietary dyes, dye removers, and descaling agents may only be used in this machine if the manufacturer expressly states that they are suitable for use in a washing machine. The manufacturer's instructions on the packaging must be observed.

Detergent dispensing

Avoid dispensing more than the required amount as this can cause excessive foaming.

- Only use low-foaming detergents.
- Follow the detergent manufacturer's recommendations.

The amount to dispense will depend on:

- the amount of laundry
- the water hardness
- the degree of soiling of the laundry

Amount of detergent

Please dispense according to water hardness levels and follow the detergent manufacturer's instructions.

Water hardness levels

Water hardness level	Total hardness in gpg	German scale °dH
Soft (I)	0-8.7	0-8.4
Medium (II)	8.7-14.6	8.4-14
Hard (III)	Above 14.6	Above 14

Check with your local water supplier if you do not know the water hardness level in your area.

Selecting a program

Programs

There are different ways to select a program.

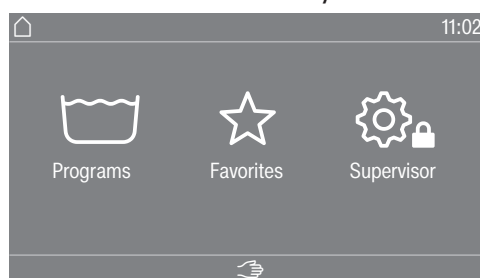

You can select a program from the Programs menu.

- Touch the Programs selection area.

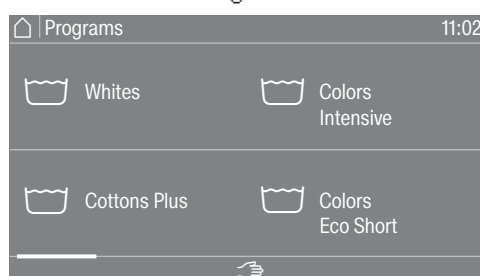

- Scroll to the right in the display until the program you want appears.
- Touch the required program on the touch display.

The display will change to the standard menu for that wash program.

Favorites

Alternatively, you can select a program from the Favorites menu.

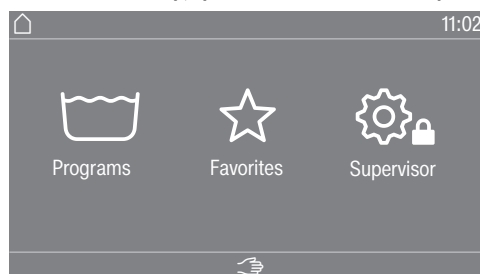

- Touch the Favorites selection area.

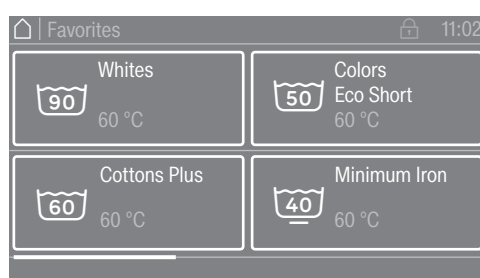

- Scroll to the right in the display until the program you want appears.
- Touch the required program on the touch display.

The display will change to the standard menu for that wash program.

In the case of favorite programs, the majority of the program settings are already fixed and cannot be changed.

Selecting program settings

Washing

Selecting the load size

To enable load-specific external dispensing and an adapted program sequence, you can specify the load size for some programs.

- Touch the Weight (lbs) selection area.

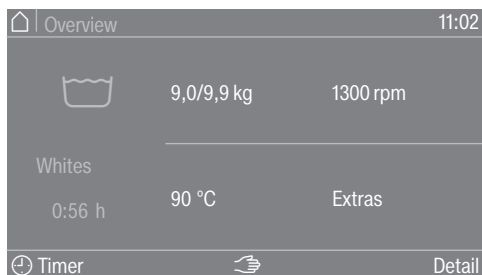

- Enter a valid value for the load size.

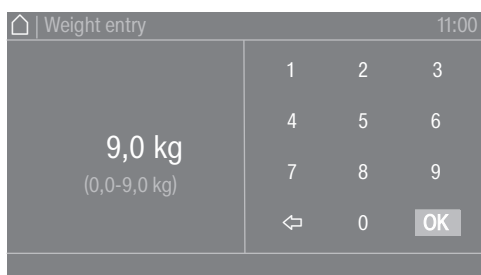

- Press the OK symbol.

The display will change to the Overview menu.

Selecting a temperature

You can alter the pre-set temperature of a wash program.

- Touch the Temperature (°F) selection area.



- Select the desired temperature from the presets.

The display will change back to the Overview menu.

If you select the Finer adjustment selection area, you can set additional temperatures within the available temperature range by entering them directly.

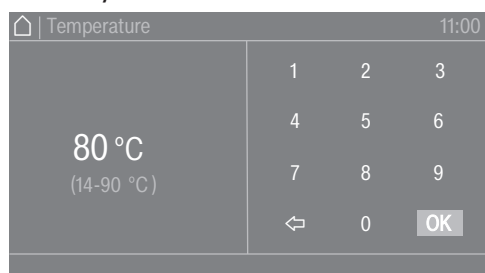

- Select the desired value using the keypad.
- Press the OK symbol.

The display will change back to the Overview menu.

The temperature can only be selected within the range specified below the current setting (e.g., 57-194°F (14-90°C)).

Washing

Selecting a spin speed

You can alter the pre-set spin speed of a wash program.

- Touch the Spin speed (rpm) selection area.



- Select the spin speed you want from the presets.

The display will change back to the Overview menu.

If you select the **Finer adjustment** selection area, you can set additional speeds within the available speed range.

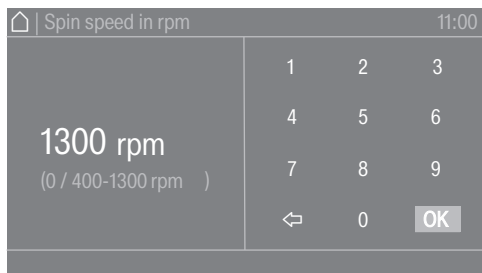

- Select the desired value using the keypad.
- Press the OK symbol.

The display will change back to the Overview menu.

The speed can only be selected within the range specified below the current setting (e.g., 0 / 400–1,300 rpm).

Selecting Extras

Selecting Extras

You can select Extras for some wash programs.

- Touch the Extras selection area.

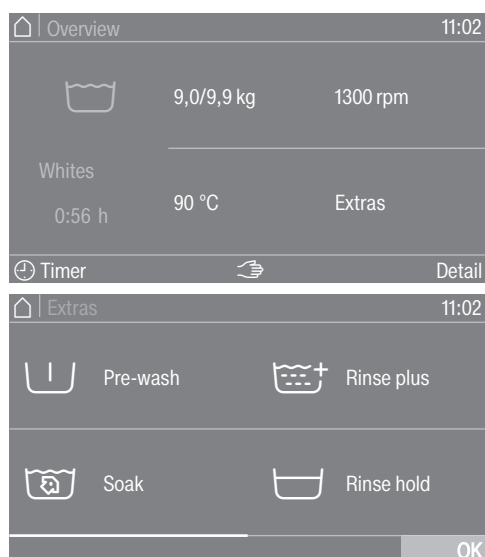

- Select one or more Extras.
- Press the OK symbol.

The display will change to the Overview menu.

Pre-wash

A pre-wash can be added for heavily soiled laundry. Coarse soiling is loosened and removed before the main wash.

Soak

For heavily soiled and stained items with protein stains. The soak duration is 10 minutes.

Rinse plus

An extra rinse can be activated to achieve a more thorough wash result.

Rinse hold

The laundry is not spun after the final rinse and remains in the rinse water. This helps prevent creasing if the laundry is not going to be removed from the washing machine drum immediately after the end of the program.

Filling stop

Water is drained out of the machine before the final rinse and the program stops. The required starch, dye, proofing agent, etc. is added directly to the drum. The program is continued with the *Start/Stop* sensor control.

Intensive

For hard-wearing laundry that is very heavily soiled. Extending the main wash increases cleaning efficiency.

Water plus

The water level in the wash cycle will be increased.

Washing

Program start – program end

Starting a program The program can be started as soon as the *Start/Stop* sensor control is flashing on and off.

- Touch the *Start/Stop* sensor control.

The door will lock (🔒 symbol) and the wash program will start.

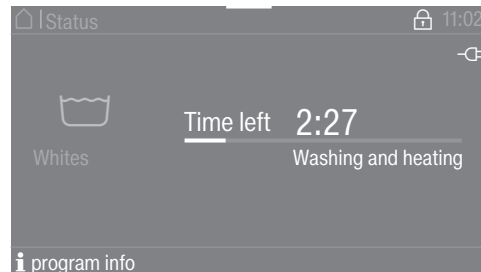

Tip: You can use the pull-down menu to display the selected temperature, spin speed, and any selected Extras.

If a delay start period (🕒 Timer) has been selected, this will appear in the display at the bottom left.

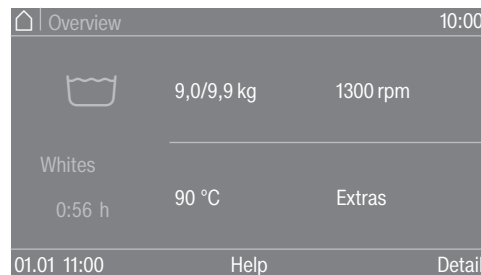

If you select the **i** program info selection area, all program-related information will be displayed.

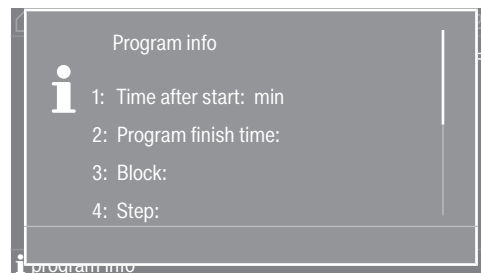

The program duration will appear in the display either straight away or once the delay start period has elapsed. The program sequence is also shown in the display.

End of the program

Depending on the setting selected in the supervisor level or in the program, the machine will switch to the anti-crease action cycle at the end of the program. The door remains locked. The door can be unlocked at any time by touching the *Start/Stop* sensor control.

Removing the laundry

- Pull open the door.
- Remove the laundry.

Items left in the drum could discolor other items in the next wash or become discolored themselves.
Remove all items from the drum.

- Check the door sealing ring for any foreign objects.
- Switch the washing machine off with the  button.

Tip: Leave the detergent drawer slightly open to allow it to dry.

Timer

The timer can be used to select a program start date, program start time, or program end time. This mode is also referred to as delay start.

Setting the timer

- Touch the  Timer selection area.

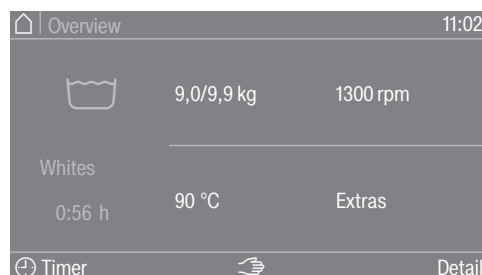

- Select option Finish at, Start date, or Start at.

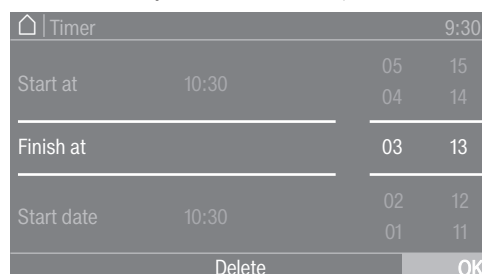

- Set the hours and the minutes or the date and confirm with the  symbol.

Deleting the timer

The selected delay start period can be canceled before the program starts.

- Touch the selection area with the selected settings in the timer field, e.g., 01.01. 11:00.

The selected delay start period will appear in the display.

- Touch the Delete selection area.
- Confirm with the  symbol.

The selected delay start period is deleted.

Starting the timer

- Touch the *Start/Stop* sensor control.

The door will lock and the time until the program starts will appear in the display.

After the program has started, the selected delay start period can only be changed or canceled by interrupting the program.

The program can be started immediately at any time.

- Touch the Start immediately selection area.

Special features in the program sequence

Spinning

Final spin speed

When a program is selected, the maximum spin speed for this wash program is shown in the display in the pre-start menu.

You can reduce the final spin speed.

Depending on the program, it may also be possible to increase the speed. The setting options are displayed when you tap the spin speed.

Rinse-spin

There is a spin cycle after the main wash and between the rinse cycles. A reduction in the final spin speed will also reduce the rinse-spin speed as appropriate.

Anti-crease

At the end of the program, the drum continues to turn at intervals for up to 30 minutes to help prevent creasing.

The drum door cannot be opened until the program has ended.

Anti-crease is program-dependent. The option can be switched on or off in the supervisor level.

Skip

The Skip function enables users to skip forward or backward in the program sequence. The program sequence is continued from the selected step.

If a program is interrupted using the *Start/Stop* sensor control, the Skip ⇨ function is available in the program stop screen.



If the Skip ⇨ function is selected, the required program step can be selected via the display.

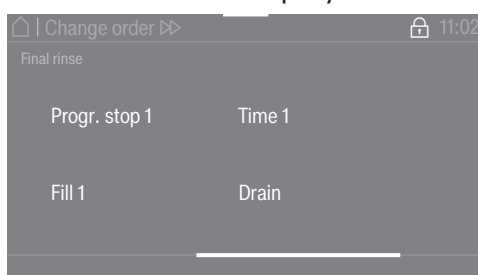

The program can then be continued with the *Start/Stop* sensor control.

Manual control

Manual control is possible either before a program is started or when a program has been stopped.

Switching to manual control

Manual control is possible before a program is started or when a program has been stopped.

- Press the ⇨ “Manual control” button to access the password entry screen.

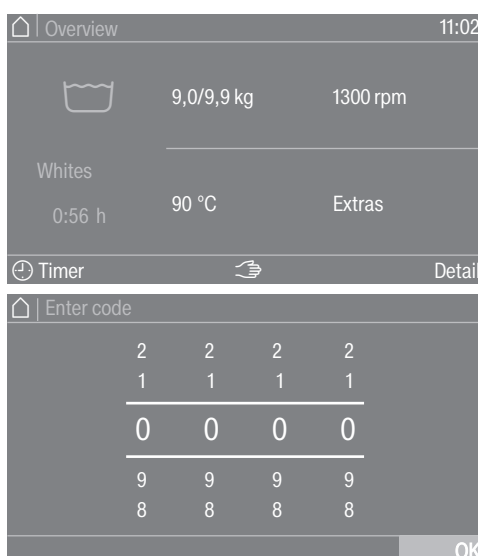

- Enter the password.
- Confirm the password entry with the OK sensor control.

The Manual control menu is displayed:

Washing

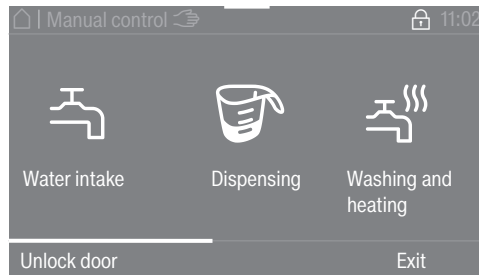



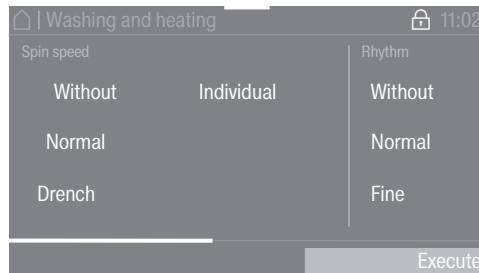

The current level, spin speed, and temperature statuses of the machine appear orange.



- Select the desired setting.
- Confirm the entry with the Execute sensor control.

The submenus appear in various operating modes. See “Examples of how to operate the machine” for an in-depth description.

The function buttons are assigned with specific manual control functions:

- Water inlet 
- Dispensing 
- Washing and heating 
- Drain with drum rotation 
- Spin 

- Press the button again to end a selected function.

Water intake

Water intake valves and the water level can be set.

- Press the  Water intake function button.
- Select the desired value.
- Confirm your selection with the Execute sensor control.

If a higher numerical value is set, the values below this will no longer be displayed.







The wash program will start or continue.





Dispensing

The dispensing quantity for the various dispenser pumps can be set.

This function is only possible if the Connector Box, the dispenser pumps, and automatic dispensing have been selected in the supervisor level; see “Supervisor level” section.

- Press the  Dispensing function button.
- Select the desired dispenser pump and dispensing quantity, e.g., D1 50 mL.
- Confirm your selection with the Execute sensor control.

- The wash program will start or continue.
- Washing and heating  Spin speed, rhythm, and temperature can be set.
- Press the  Washing and heating function button.
 - Select the desired settings.
- The selected setting will appear in orange in the multiple selection.
- Confirm your selection with the **Execute** sensor control.
- The wash program will start or continue.
- Drain with agitation  Drain path, spin speed, and rhythm can be set.
- Press the  Drain with agitation function button.
 - Select the desired settings.
- The selected setting will appear in orange in the multiple selection.
- Confirm your selection with the **Execute** sensor control.
- Spin  The spin speed can be set.
- Press the  Spin function button.
 - Select the desired value.
 - Confirm your selection with the **Execute** sensor control.
- The wash program will start or continue.
- Function combinations Water inlet, dispensing, washing and heating can be selected simultaneously in any combination*.

 Water inlet	 Dispensing	 Washing and heating	 Drainage with agitation	 Spinning
<input checked="" type="checkbox"/>	<input checked="" type="checkbox"/>	<input type="checkbox"/>	<input type="checkbox"/>	<input type="checkbox"/>
<input type="checkbox"/>	<input checked="" type="checkbox"/>	<input checked="" type="checkbox"/>	<input type="checkbox"/>	<input type="checkbox"/>
<input checked="" type="checkbox"/>	<input type="checkbox"/>	<input checked="" type="checkbox"/>	<input type="checkbox"/>	<input type="checkbox"/>
<input checked="" type="checkbox"/>	<input checked="" type="checkbox"/>	<input checked="" type="checkbox"/>	<input type="checkbox"/>	<input type="checkbox"/>

* possible function combinations

Drying

1. Notes on correct laundry care

Washing before drying

Heavily soiled laundry must be washed particularly thoroughly. Use sufficient detergent and select a high wash temperature. If in doubt, wash the items several times.

The tumble dryer must not be used for drying items of laundry which have been cleaned using industrial chemicals.

New, dark, and colored items must be washed thoroughly and separately. Do not dry dark and colored items with light-colored garments. There is the risk of colors running and discoloring other garments or even plastic components in the tumble dryer. Dark-colored fibers can also settle on light-colored garments and vice versa.

Removing foreign objects

Before drying, ensure that there are no foreign objects in the laundry.

⚠ Damage due to foreign objects which were not removed from the laundry.

Foreign objects in the laundry can melt, burn, or explode.

Ensure that any foreign objects (e.g., detergent dispensing aids, lighters, etc.) have been removed from the laundry.







Check seams and stitching to ensure that padding and linings are intact. This way you will avoid the danger of filling coming out and causing a fire. Sew in or remove underwiring from bras.

⚠ Risk of fire due to incorrect use and operation.

The laundry can burn and destroy the tumble dryer and the surroundings.

Read and observe the "IMPORTANT SAFETY INSTRUCTIONS".

Care symbols

Drying	
	Normal/higher temperature
	Low temperature*
* Select Low temperature.	
	Do not tumble dry
Ironing	
	Very hot
	Hot
	Warm
	Do not iron

2. Loading the tumble dryer

Loading laundry into the tumble dryer

Laundry may be damaged.
Before loading, read chapter "1. Notes on correct laundry care" first.

- Open the door.
- Load laundry into the tumble dryer.

Risk of damage with laundry getting trapped.
Laundry can be damaged by getting trapped when closing the door. When closing the door, make sure that laundry does not get trapped in the door opening.

Do not overload the drum. Overloading can cause unnecessary wear and tear to the laundry and cause a disappointing drying result. It can also cause more creasing.

Closing the door

⚠ Damage caused by laundry getting trapped.
Laundry can be damaged by getting trapped when closing the door. When closing the door, make sure that laundry does not get trapped in the door opening.

- Shut the door gently.

3. Selecting a program

Switching on the tumble dryer

- Press the  button.

The welcome screen will light up.

There are different ways to select a drying program in the main menu.

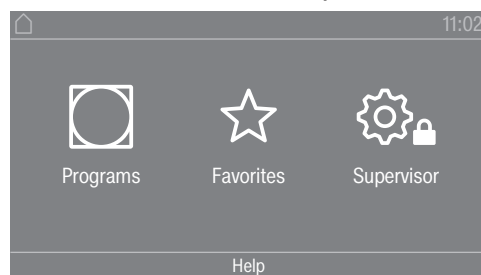

- Touch the  Programs sensor button.

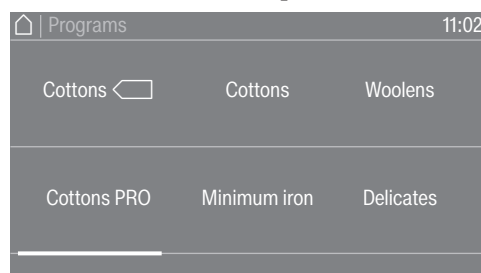

- Swipe to the left until you reach the required program.
- Touch the sensor button for that program.

The display will change to the standard menu for that drying program.

Alternatively, you can select a program from the Favorites list.
The pre-set programs under  Favorites can be changed via the Supervisor level.

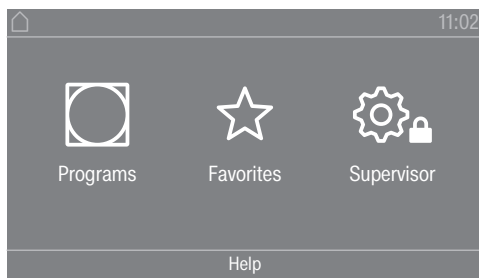

- Touch the ☆ Favorites sensor control.

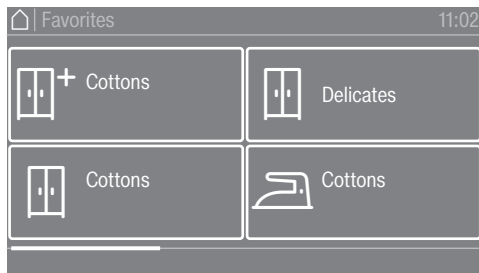

- Swipe to the left until you reach the required program.
- Touch the required program.

The display will change to the standard menu for that drying program.

4. Selecting program settings

Selecting the drying level

The pre-set drying level for many programs can be changed if required. Different drying levels are available depending on the program.

Selecting extra options

The drying programs can be augmented with various Options. Some Options can only be selected for certain drying programs.

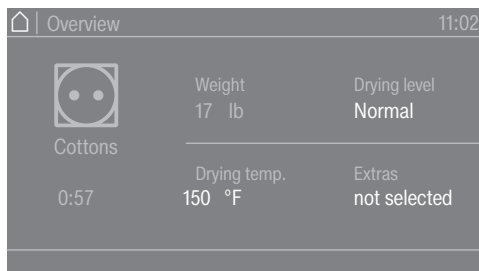



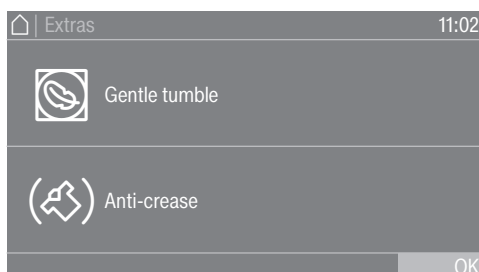

- Touch the Extras sensor button.



- Touch the sensor button for the option you want.
- Only press OK when the option appears on the display.

The relevant symbol for the selected option (☺ or ☹) lights up.

-  Low temperature Delicate fabrics (with the  symbol on the care label, e.g., acrylic garments) are dried at a lower temperature and the program duration is longer.
-  Gentle tumble Sensitive items are dried with fewer drum rotations and a lower drying temperature.
-  Anti-crease After the program has finished, the drum will continue to rotate in a certain rhythm, depending on the selected program. This helps to prevent creasing after the program has ended.

The Anti-crease function is switched off as the factory default setting. The Anti-crease function can be switched on in the supervisor level with a variable duration of up to 12 hours. You can find this setting in the supervisor level under the Process technology/Anti-crease menu.

Drying

5. Starting a program

Starting a program The program can be started as soon as the *Start/Stop* sensor button is flashing on and off.

- Touch the *Start/Stop* sensor button.

If a delay-start period has been selected, this will appear in the display.

The drying program will start either straight away or once the delay-start period has elapsed. The program time left is shown in the display.

Calling up current program parameters

While the program is running, you can use the pull-down menu to view the parameters of the current drying program (e.g., drying level, load size, selected options, drying temperature).

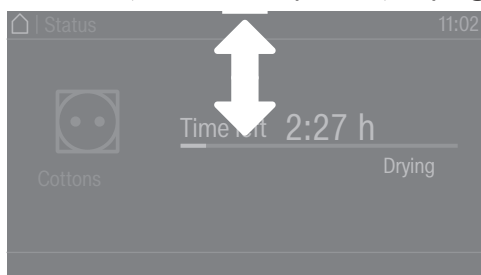

- To call up the pull-down menu, swipe your finger from top to bottom while the program is running.



The pull-down menu displays the parameters of the drying program.

- To close the pull-down menu again, swipe your finger from bottom to top or press the ↶ sensor control.

Program runtime/estimated time remaining

The program runtime depends on the quantity of laundry, the type of fabric, and the residual moisture in the laundry. The displayed program duration for drying level programs can therefore vary or “jump”. The tumble dryer’s electronic adapts during the ongoing drying program. The displayed program runtime becomes more and more accurate.

When using the programs for the first time, the displayed time sometimes deviates significantly from the real time left. The difference between the estimated and achieved time becomes smaller if the corresponding program is run more often. If different load sizes are dried in one program, the time left display can only show an approximate time.

Program end

End of the program

The laundry will be cooled down after the end of the program. The message **Finish/Cooling down** will appear on the display during the cooling phase. The laundry can now be unloaded.

After the cooling phase and the drying program is completed, the message **Finish** is displayed.

The tumble dryer will switch off automatically after the set time after the end of a program.

If the Anti-crease (🌀)* option has been selected, the drum continues to rotate in intervals after the end of the program. This reduces creasing if the laundry cannot be unloaded straight away.

* The Anti-crease function is switched off as the factory default setting and can be activated in the supervisor level.

Removing the laundry

- Open the door.
- Remove everything from the drum.

Items left in the dryer could be damaged by over-drying when the dryer is used the next time.

Always remove all items from the drum.

- Switch the tumble dryer off by pressing the ⏻ button.

Care notes

This tumble dryer requires regular maintenance, particularly if it is used on a continuous basis. Please see “Cleaning and care” for details.

Timer

Prerequisite for setting the timer

The Delay start must be activated in the Supervisor level in the Controls / Display menu so that the Timer can be selected. Before the program starts, the Timer can be used to select a program start time or program end time.

Setting the timer

- Touch the Timer sensor button.
- Select the **Finish at**, **Start in**, or **Start at** option.
- Set the hours and the minutes and confirm your entry with the OK sensor button.

Changing the program sequence

Washing machine

Changing a program

Altering the wash program

You will need to cancel the current program before you can select a new one.

Interrupting a program

You can interrupt a wash program at any time after it has started.

If the program is locked, the disinfection programs or payment programs can only be canceled by entering a code.

- Touch the *Start/Stop* sensor control.

The following will appear in the display:

i Program stopped. Continue with "Start/Stop"

The following will appear in the display:



- Select Finish.

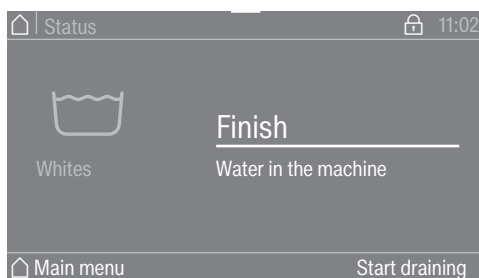

The suds are not drained so they can be used again in a subsequent program. Once the program has ended, the program end screen is displayed. It is possible to switch to the main menu while the suds are in the drum or to drain the suds by pressing the Start draining control. If permanent automatic water drainage is required, Automatic drainage can be activated at supervisor level.

The drum door remains locked while there is water in the machine.

The door can be opened under the condition Program end without water. If the temperature is too high, wait until it has cooled down so that the door can be opened.

- Wait until the door unlocks.
- Pull open the door.
- Remove the laundry.

Switching on the washing machine after a power failure

If the washing machine is switched off with the  button during a wash program, the program will be interrupted.

- Switch the washing machine back on with the  button.
- Note the message in the display.

Changing the program sequence

- Touch the *Start/Stop* sensor control.
The program continues.

Changing the program sequence

Adding or removing laundry

You can add or remove laundry for a short period immediately after the program has started.

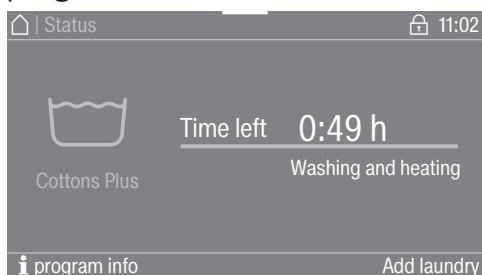

- Touch the **Add laundry** selection area.

If the message **Add laundry** is not visible in the display then it is no longer possible to add items of laundry.

The wash program will stop and the door will unlock.

 Risk of chemical burns from detergent.
When adding or removing laundry, your skin may come into contact with detergent, particularly if the detergent is dispensed externally. Take care when placing your hands inside the drum.
If suds have come into contact with the skin, rinse off immediately with plenty of lukewarm water.

- Pull open the door.
- Add laundry or remove individual items.
- Close the door.
- Touch the *Start/Stop* sensor control.

The wash program will continue.

Tumble dryer

Changing a program once it has started

You cannot change to another program once a program has started (this prevents unintentional alterations). You will need to cancel the current program before you can select a new one.

 Risk of fire due to incorrect use and operation. The laundry can burn and destroy the tumble dryer and the surroundings. Read and observe the "IMPORTANT SAFETY INSTRUCTIONS".

Canceling the current program

- Touch the *Start/Stop* sensor control.

The following message appears in the display: Cancel the program?

- Touch the *Yes* sensor control to cancel the current program.

 Risk of burns by touching hot laundry or the tumble dryer drum. Touching the hot laundry or the tumble dryer drum may cause burns. Let the laundry cool down and remove it carefully.

Opening the door of the tumble dryer during the program sequence will cancel the current program.

If the Door opening status/Interrupt program function is selected in the supervisor level, the current program will be interrupted when the door is opened. In the case of an interruption, the tumble dryer will remain in the current program.

The interrupted program will be continued when the door is closed and the *Start/Stop* sensor control is pressed.

Reselecting a canceled program

- Open and close the door.
- Select and start a new program.

Adding laundry

- Open the door.

 Risk of burns by touching hot laundry or the drum. The laundry and the tumble dryer drum are still hot and can cause burns if they are touched. Let the laundry cool down and remove it carefully.

- Add items.
- Close the door.
- Start the program.

Adding laundry during ongoing Delay Start period

You can open the door to add or remove laundry.

- All program settings will be saved.
- You can still change the drying level, if required.

- Open the door.
- Remove or add the laundry.
- Close the door.
- Touch the *Start/Stop* sensor button so that the Delay Start period continues.

Changing the program sequence

Time left

Altering the program sequence can cause the program duration shown in the display to be adjusted.

Troubleshooting

Opening the door in an emergency in case of a power outage

The drum door cannot be opened.

⚠ Warning! Danger from rotating drum and danger of scalding.
Before inserting the Torx wrench, make sure that the machine is disconnected, the drum has stopped, and there is no water in the machine.

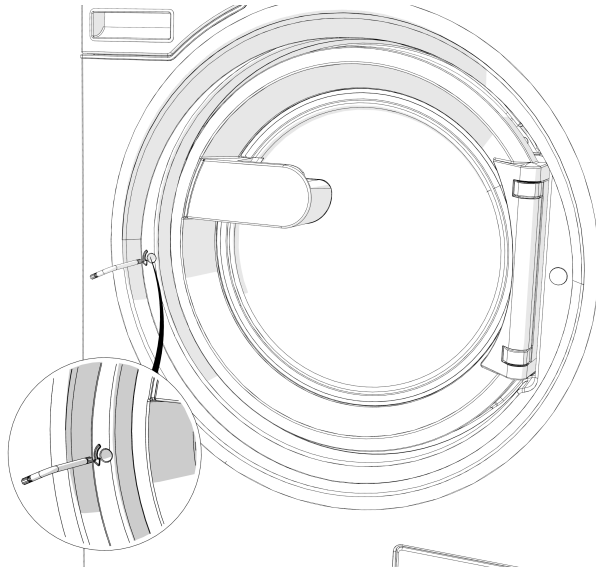

- Using a T 40 Torx wrench, turn the release element with the inner hexagon 2 whole revolutions **in the direction of the arrow**.

Tip: Pushing on the door at the same time makes it easier to turn the emergency release mechanism.

The release element is opposite the door hinge at the same height as the door handle (see diagram).

The release element must not be turned against the direction of the arrow.
This damages the door lock.

The resistance will noticeably decrease. When the release element moves freely, the door is unlocked.

Tip: The release element does not need to be screwed back in.

The door can now be opened.

Frequently asked questions

Opening the door in the event of a blocked drain outlet and/or power outage

⚠ Disconnect the machine from the electricity supply.

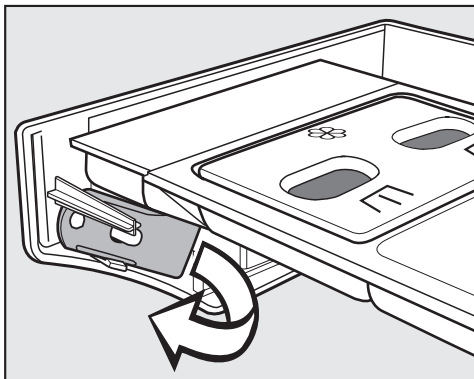

- There is a lever behind the detergent drawer panel which opens the access panel to the drainage system.
The lever is provided in the accessory pack for models with a locked detergent drawer.
Remove the lever.

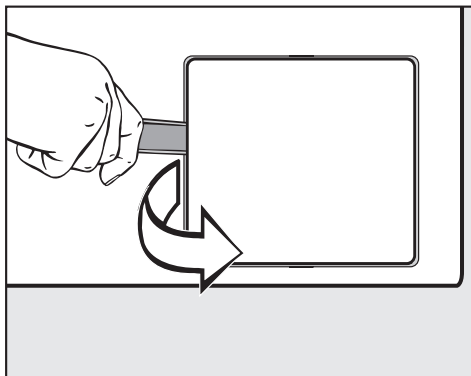

- Open the access panel to the drainage system.

If the drain outlet is clogged, a large amount of water may be retained in the washing machine.

⚠ If laundry has been washed at a high temperature, water draining out of the machine will still be hot.

- Place a suitable container under the access panel.

Do not unscrew the drain filter completely.

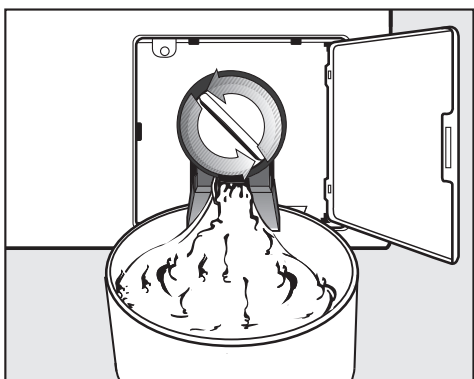

- Unscrew the drain filter to let the water out.

Frequently asked questions

- Tighten the drain filter back up again if you need to interrupt the flow of water.

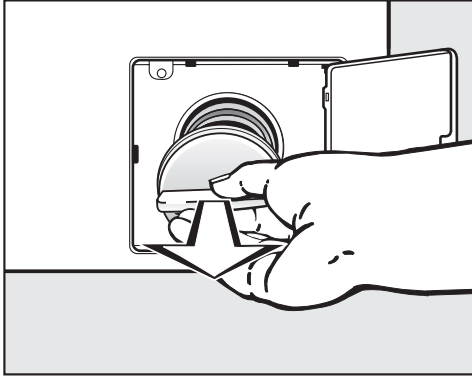

- If no water flows out, unscrew the drain filter completely.
- Clean the drain filter thoroughly.

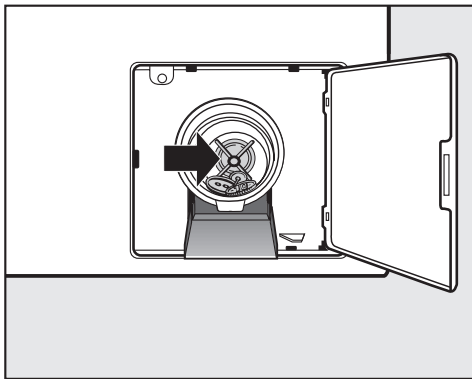

- Remove any foreign objects (e.g., buttons, coins, etc.) and clean the interior. Turn the impeller by hand to check that it rotates freely.
- Put the drain filter back in place and screw it tight.

⚠ Make sure the drain filter is reinserted and securely tightened. Otherwise there is a risk of water leakage during use.

Frequently asked questions

Miele Service

In the event of a fault, contact Miele Service.

When contacting Miele Service, please quote the model, serial number (SN), and material number (mat. no.) of your machine. This information can be found on the data plate. The data plate is visible in the door ring when the drum door is open, or on the back of the machine at the top:

Please also tell Miele Service the fault message that appears on the machine display.

Use only original Miele spare parts. Miele Service will also require the model, serial number (SN), and material number (mat. no.) when ordering.

Frequently asked questions

The majority of faults and problems that arise during day-to-day use can be remedied without external assistance. You can save time and money in many cases, as you do not need to contact Miele Customer Service.





The following tables are designed to help you to find the cause of a malfunction or an error and to resolve it. However, please note:

 Repair work to electrical appliances must only be carried out by an authorized technician. Incorrect repairs can cause considerable danger to users.





A program cannot be started

Problem	Possible cause and solution
The display remains dark, and the <i>Start/Stop</i> sensor control does not light up or flash.	No power is being supplied to the washer-dryer stack. <ul style="list-style-type: none"> ■ Check whether the washer-dryer stack is switched on. ■ Check whether the washer-dryer stack is connected to the power supply. ■ Check whether the fuse has tripped.
	The washer-dryer stack has switched off automatically to save energy. <ul style="list-style-type: none"> ■ Switch the washer-dryer stack back on with the  button.
The following appears in the display: F - Door lock fault. You can continue by pressing the "Start/Stop" button	The door has failed to lock. <ul style="list-style-type: none"> ■ Close the door again. ■ Start the program again. If the fault message appears again, contact Miele Service.
The display is dark and the <i>Start/Stop</i> sensor control is flashing slowly.	If the Standby function has been activated at supervisor level, the display switches off automatically to save energy. <ul style="list-style-type: none"> ■ Touch any of the controls. The display switches back on.
The program is on the pre-start screen and the <i>Start/Stop</i> sensor control is not flashing.	The drum door has been pushed to but is not closed correctly. <ul style="list-style-type: none"> ■ Check whether the drum door is closed correctly.

Program cancellation and fault message

Problem	Possible cause and solution
 F - Water drainage fault. If restart fails, contact Service.	<p>The drain is blocked or restricted. The drain hose has been fixed too high.</p> <ul style="list-style-type: none"> ■ Clean the drain filter and the drain pump. ■ The maximum delivery head is 3' 3" (1 m).
 F - Water intake fault. If restart fails, contact Miele.	<p>The water inlet is blocked or restricted.</p> <ul style="list-style-type: none"> ■ Check whether the water inlet is turned on properly. ■ Check the water inlet hoses for leaks. ■ Check whether the water connection pressure is sufficient. ■ Check whether the water inlet hoses are kinked.
	<p>The water inlet filters are blocked.</p> <ul style="list-style-type: none"> ■ Clean the filters.
 Disinfection temperature not reached	<p>The required temperature was not reached during the disinfection program.</p> <ul style="list-style-type: none"> ■ The washing machine has not carried out the disinfection cycle correctly. ■ Restart the program.
 Fault F. If restart fails, contact Service.	<p>There is a fault.</p> <ul style="list-style-type: none"> ■ Disconnect the washer-dryer stack from the electricity supply. ■ Wait at least 2 minutes before reconnecting the washer-dryer stack to the electricity supply. ■ Switch the washer-dryer stack on again. ■ Restart the program. If the fault message appears again, contact Customer Service.

The display shows a message

Problem	Possible cause and solution
 Container empty	<p>One of the liquid dispensing detergent containers is empty.</p> <ul style="list-style-type: none"> ■ Refill the detergent containers.
 Hygiene info: run a program of at least 60°C	<p>During the last wash, a wash program with a temperature below 140°F (60°C) was selected.</p> <ul style="list-style-type: none"> ■ Start a program with a minimum temperature of 140°F (60°C) or the Clean MachineExtrasIntensive program.
 F - Water intake fault. If restart fails, contact Miele.	<p>The hot water supply is blocked or restricted.</p> <ul style="list-style-type: none"> ■ Check whether the hot water supply has been turned on properly. ■ Check whether the water inlet hose is kinked.
 Laundry not properly spun	<p>The selected spin speed was not reached during the final spin due to excessive imbalance.</p> <ul style="list-style-type: none"> ■ Check that the washing machine is level. ■ Start the spin cycle again.

Frequently asked questions

Problem	Possible cause and solution
i Machine is leaking	The washing machine or drain valve is leaking. <ul style="list-style-type: none"> ■ Close the faucet. ■ Contact Customer Service.

Insufficient wash results

Problem	Possible cause and solution
Liquid detergent is not achieving the required results.	Liquid detergents usually contain no bleaching agents. They do not remove fruit, coffee, or tea stains. <ul style="list-style-type: none"> ■ Use powder detergent containing a bleaching agent. ■ Pour powder stain remover into drawer  in the dispenser compartment and liquid detergent into a dispenser ball. ■ Never put powder stain remover and liquid detergent together in the detergent drawer.
White residues which look like powder detergent are seen on dark textiles after washing.	The detergent contained compounds (zeolites) to aid water softening which are not soluble in water. These have ended up on the laundry. <ul style="list-style-type: none"> ■ Try and brush off the residues with a soft brush once the laundry is dry. ■ In the future, wash dark textiles using a detergent which contains no zeolites. Liquid detergents do not usually contain zeolites.
Textiles that were very greasy are not properly clean.	<ul style="list-style-type: none"> ■ Select a program with pre-wash. Use liquid detergent for the pre-wash. ■ Continue to use universal powder detergent for the main wash. <p>The use of heavy-duty detergent is recommended in the main wash for very heavily soiled workwear. Please seek advice from the detergent and cleaning agent manufacturer.</p>
There are gray, oily particles clinging to washed laundry.	Not enough detergent was dispensed. The laundry was heavily soiled with grease (oils, ointments). <ul style="list-style-type: none"> ■ Use more detergent or liquid detergent with this type of soiled laundry. ■ Before washing the next load, run a 140°F (60°C) program with liquid detergent and no load.

Insufficient drying results

Problem	Possible cause and solution
Adjust the load The drum is empty or the laundry is too dry.	This is not a fault. In some programs, if the drum has been underloaded or is empty, the program will be canceled. This can also happen if the items are already dry. <ul style="list-style-type: none"> ■ Use the hot air drying program to dry individual items. ■ Delete the message: <ul style="list-style-type: none"> – Open the door.

Frequently asked questions

Problem	Possible cause and solution
Power supply interruption; program stop. Please press OK button	<p>The tumble dryer was switched off or there was a power outage during the drying process.</p> <ul style="list-style-type: none"> ■ Press the <i>OK</i> button after switching the tumble dryer back on/restoring the power and start the program again.
Clean air channels Clean the lint filter. Check the air guide.	<p>Reminder to clean the lint filter.</p> <ul style="list-style-type: none"> ■ Clean the lint filter. ■ Delete the problem message: <ul style="list-style-type: none"> – Press <i>OK</i>.
	<p>A defect in the air guide was identified.</p> <ul style="list-style-type: none"> ■ Clean the lint filter. ■ Check all possible causes described under “The drying process goes on too long or even switches off”. ■ Delete the problem message: <ul style="list-style-type: none"> – Open and close the door.
	<p>The vent ducting may be very long, but this is not a fault.</p> <ul style="list-style-type: none"> ■ If the vent ducting is very long, the program times will be longer and energy consumption will be higher.
	<p>A significant defect in the air guide was identified.</p> <ul style="list-style-type: none"> ■ See above. ■ Delete fault message: <ul style="list-style-type: none"> – Press <i>OK</i>.
The laundry is not sufficiently dry.	<p>The load consisted of different types of fabric.</p> <ul style="list-style-type: none"> ■ Finish drying using the Time Dry program. ■ Select a more suitable program next time; see the “Program overview” document.
Feather-filled pillows smell after drying.	<p>Feathers tend to develop a build-up of their own smell or smells from other sources when they are heated.</p> <ul style="list-style-type: none"> ■ Smells can be reduced through natural ventilation after drying.
Items made of synthetic fibers are charged with static electricity after drying.	<p>Synthetic fibers tend to attract static charge.</p> <ul style="list-style-type: none"> ■ Static charge can be reduced by adding a fabric softener to the final rinse in the washing program.
There is a build-up of lint.	<p>Lint is principally the result of friction when garments are being worn and to some extent when they are being washed. By contrast, the tumble dryer exerts barely any stress on the garments, which means it hardly affects their life.</p> <ul style="list-style-type: none"> ■ Lint is collected by the lint filter and can be easily removed (see “Cleaning and care”).
Condensation is forming in the drum.	<p>The tumble dryer is installed on a shared exhaust-air duct.</p> <ul style="list-style-type: none"> ■ The tumble dryer must always be installed with a non-return flap when using a shared duct. ■ Check the non-return flap for possible defects on a regular basis and replace the flap if necessary.



Frequently asked questions

Problem	Possible cause and solution
The drying process goes on too long or even switches off.	In some circumstances, you may be asked to clean the air channels/air guide. <ul style="list-style-type: none"> ■ Please check all the possible causes described below.
	The lint filter is clogged with lint. <ul style="list-style-type: none"> ■ Remove the lint.
	The air guide area is clogged with hair and lint, for example. <ul style="list-style-type: none"> ■ Cleaning the air guide area. ■ You can remove the cover in the loading area to clean the air guide area underneath.
	The vent ducting or its openings are clogged with hair and lint, for example. <ul style="list-style-type: none"> ■ Check and clean all components in the vent ducting (e.g., wall pipe, external grille, bends, elbows, etc.).
	The flow of air is insufficient (e.g., because it is installed in a small room). <ul style="list-style-type: none"> ■ When drying, open a door or window to ensure sufficient ventilation.
	The laundry has not been spun sufficiently. <ul style="list-style-type: none"> ■ In future, make sure that your laundry is thoroughly spun at the appropriate spin speed in the washing machine.
	The tumble dryer has been overloaded. <ul style="list-style-type: none"> ■ Do not exceed the maximum load size for the drying program selected.
	Metallic components, e.g., zippers, have prevented the tumble dryer from registering the correct laundry moisture level. <ul style="list-style-type: none"> ■ Open any zippers next time. ■ If the problem occurs again, dry garments with long zippers using the hot air drying program.

General problems with the washer-dryer stack

Problem	Possible cause and solution
The washer-dryer stack shakes during the spin cycle.	The machine feet are not level and not secured. <ul style="list-style-type: none"> ■ Level the washer-dryer stack and adjust the feet correctly.
Strange pump noises can be heard.	This is not a fault. These slurping noises occur at the start and end of a pump sequence as a normal part of the operation.
Large amounts of detergent residue remain in the detergent drawer.	The water flow pressure is too low. <ul style="list-style-type: none"> ■ Clean the water inlet filters.
	Powder detergent used in conjunction with water softeners tends to become sticky. <ul style="list-style-type: none"> ■ Clean the detergent drawer and, in future, add detergent first and then the water softener.

Frequently asked questions

Problem	Possible cause and solution
Fabric softener is not completely dispensed or too much water remains in the  compartment.	The siphon is not correctly positioned or is clogged up. <ul style="list-style-type: none"> ■ Clean the siphon (see “Cleaning the detergent drawer” under “Cleaning and care”).
The display is in a different language.	A different language has been selected. <ul style="list-style-type: none"> ■ Switch the washer-dryer stack off and on again. The selected supervisor language appears in the display.
	The supervisor language has been changed. <ul style="list-style-type: none"> ■ Select the language you require (see “Supervisor level – Language”).
The laundry has not been spun properly. The laundry is still wet.	The machine detected a high level of imbalance during the final spin and reduced the spin speed automatically. <ul style="list-style-type: none"> ■ Include both large and small items in the load as this will achieve better distribution.
The drum remains stationary but the program keeps running.	Fault in the program sequence <ul style="list-style-type: none"> ■ Switch the washing machine off and then back on with the  button. ■ Note the message in the display. ■ Touch the <i>Start/Stop</i> sensor control. The drum continues to spin and the program continues.

The door will not open or close

Problem	Possible cause and solution
The door cannot be opened.	The door is locked during the wash process. <ul style="list-style-type: none"> ■ Touch the <i>Start/Stop</i> sensor control. ■ Select Program abort or Add laundry. The door will unlock and you will be able to pull it open.
	There is still water in the drum and the washing machine is unable to drain. <ul style="list-style-type: none"> ■ Empty the drainage system as described in “Frequently asked questions”.
At the end of a program or when a program is canceled, the following appears in the display: Cooling down.	To protect the user against scalding, the door cannot be opened if the suds temperature is higher than 122°F (50°C). <ul style="list-style-type: none"> ■ Wait until the temperature in the drum has decreased and the message has gone out in the display.
The following appears in the display: F - Door lock fault. Contact Service.	The door lock has jammed. <ul style="list-style-type: none"> ■ Contact Customer Service.

Cleaning and care

⚠ Disconnect the washer-dryer stack from the electricity supply.

- Carry out cleaning and maintenance of the washer-dryer stack after use if possible.

Do not use a pressure washer or water jet to clean the washer-dryer stack.

- Clean the **casing, control panel, and plastic parts** with a mild, non-abrasive cleaning agent or with a soft, damp cloth only. Wipe dry with a soft cloth.

Scouring agents will scratch the surface.

- Clean stainless-steel parts of the casing with a standard commercial stainless steel cleaner.
- Remove any deposits from the door seal with a damp cloth.

Cleaning agent can seep into electrical components.

- When disinfecting the surfaces, use a moist cloth only to clean the front and around the door lock. Do not spray any liquids.

Build-up of rust

The drum is made of stainless steel. Water or foreign objects containing ferrous substances (e.g., paper clips, metal buttons, or metal swarf) which are placed in the machine with the laundry can cause a build-up of rust in the drum. Clean the drum regularly in this case and if rust occurs, remove it immediately with a proprietary stainless steel care product. Check the door seals for ferrous residues and clean thoroughly as described above. This must be carried out regularly.

Cleaning the detergent drawer, detergent compartments, and siphons

- Clean the detergent drawer and the detergent compartments thoroughly with hot water as required to remove detergent residues and incrustations.
- If the machine is not going to be used for a long time, leave the flap of the detergent drawer open.

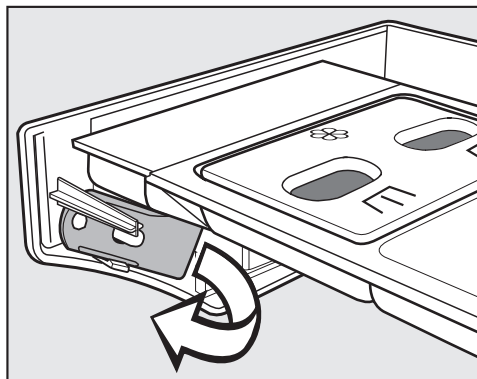

- There is a yellow lever behind the detergent drawer panel.
- Remove the lever.

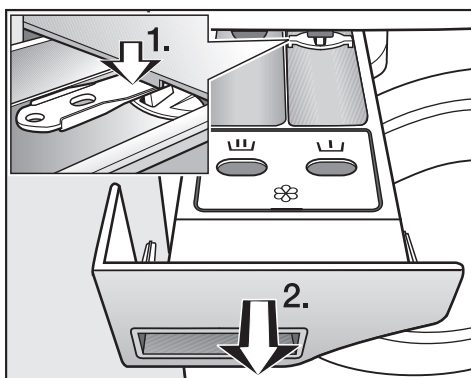

- Pull out the detergent drawer until a resistance is felt.
 1. Use the lever to push down and release the lock.
 2. Remove the detergent drawer.

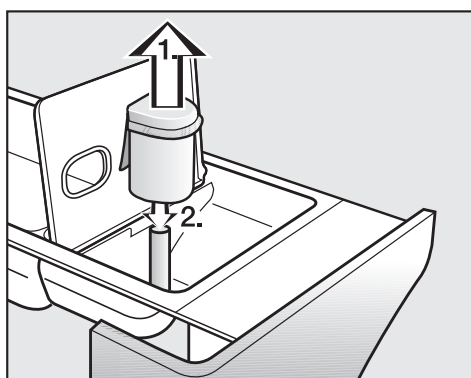

- Clean the siphon.
 1. Remove the siphon from the  compartment and rinse under warm running water. Clean the siphon tube in the same way.
 2. Reinsert the siphon.

Cleaning and care

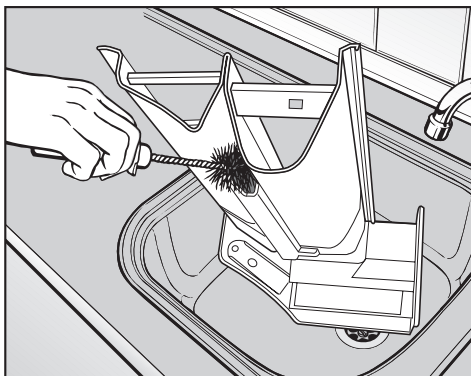

- Clean the fabric softener channel using a brush and warm water.

Clean the siphon and fabric softener channel particularly thoroughly after using liquid starch a few times. Liquid starch results in clogging.

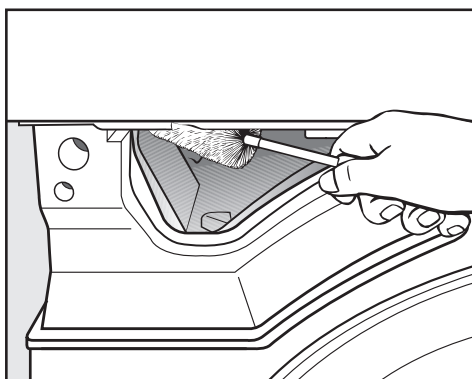

- Use a bottle brush to remove detergent residues and limescale from the jets inside the detergent drawer.

Cleaning the water inlet filters

The washing machine has filters to protect the water intake valves. You should inspect the filters approximately every 6 months. Check the filters more often if there are frequent interruptions to the external water supply.

Cleaning the filters in the inlet hoses

- Turn off the faucet.
- Unscrew the inlet hose from the faucet.

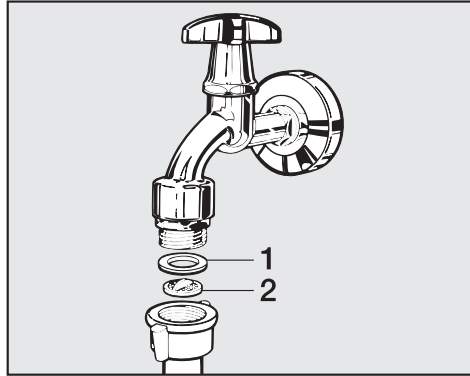

- Remove the rubber seal (1) from the recess.
- Using combination or needle-nose pliers, take hold of the plastic filter bar (2) and remove it.
- Clean the plastic filter.
- Re-assemble in reverse order.

Turn on the water supply and check the connection is watertight. If water drips out, tighten the connection.

Cleaning the filters in the water intake valves

- Using pliers, carefully loosen the ribbed plastic nut on the intake valve and unscrew.

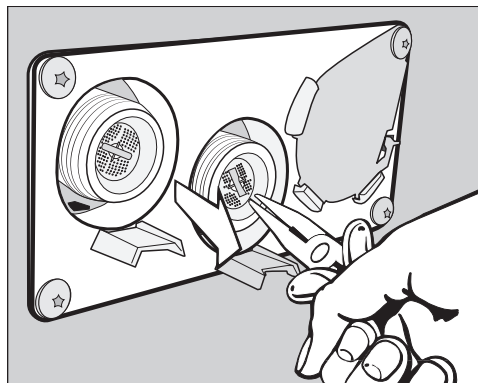

- Use needle-nose pliers to withdraw the filter by the bar and clean it. Re-assemble in reverse order.

The filters must be reinserted after cleaning.

Cleaning and care

Cleaning the lint filter

A two-part lint filter in the air guide collects lint released by textiles. Remove and dismantle the lint filter for cleaning.

Check and clean the lint filter at the latest when the *Clean out airways* message appears.

Tip: You can also use a vacuum cleaner so that you can remove the lint without touching it.

Removing the lint filter

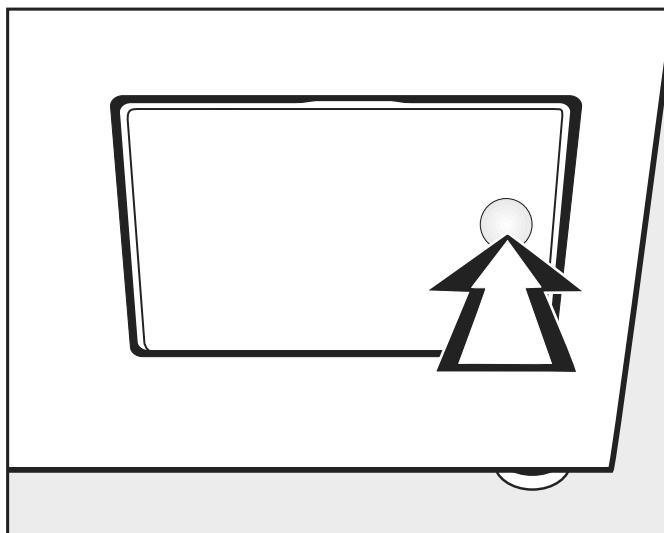

- To open, press against the right side of the lint filter flap.

When pulling out the lint filter, do not rotate the handle (see below) as this will dismantle the filter.

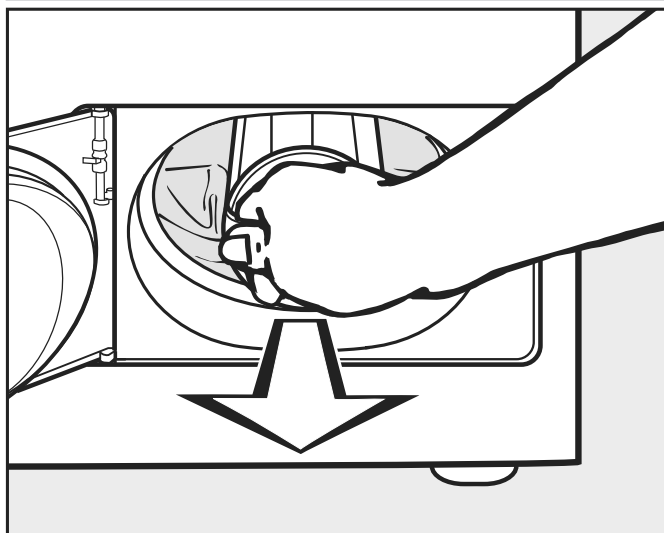

- Use the handle to pull out the lint filter.

Dismantling the lint filter

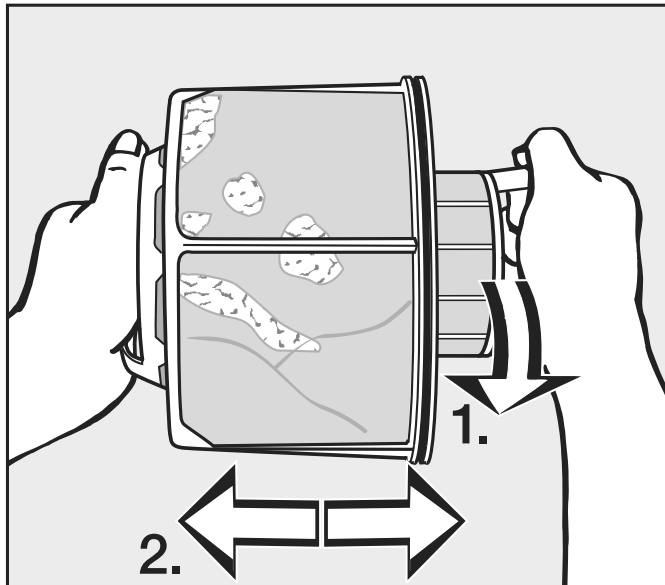

- Hold the lint filter by the handles.
- 1. Rotate the inner part of the lint filter (1).
- 2. Pull the two parts of the lint filter apart (2).

Cleaning the lint filter parts (dry)

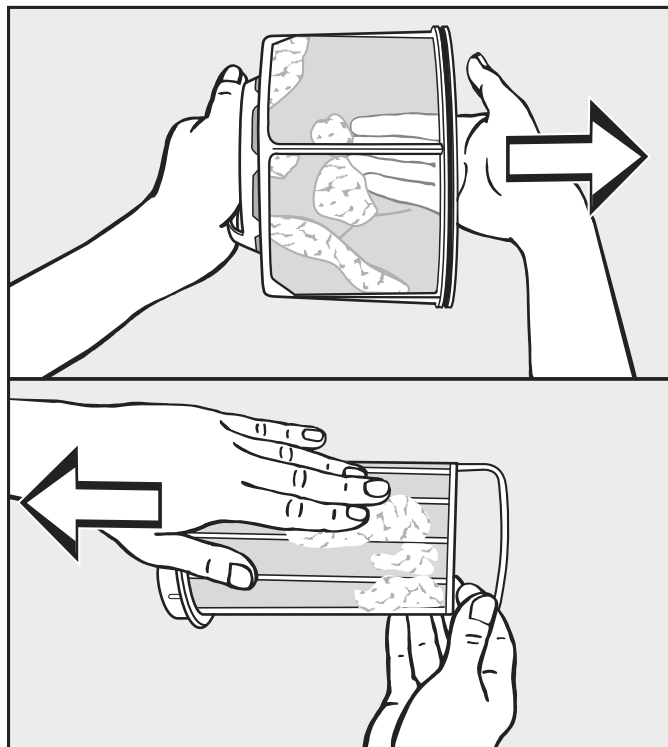

- Shake out the lint and/or pick it off with your fingers.
- Only clean the lint filter parts under warm running water if there is a lot of compacted lint on them.

Cleaning the lint filter parts (wet)

Dry the lint filter parts before reassembling them. A wet lint filter could cause operational faults while drying.

Inserting the lint filter

If there is a lot of visible lint, clean the air guide before reinserting the cleaned lint filter. See next page.

Cleaning and care

- Insert the inner part of the lint filter into the outer part.
- Turn the inner part of the lint filter clockwise slightly until you feel it engage.
- Hold the lint filter by its handle and push it into the lower air guide as far as it will go.

Do not rotate the handle as this will dismantle the filter.

- Close the lint filter flap.

Cleaning the air guide

Check the air guide from time to time and clean it if there is a lot of lint present.

Rapid cleaning

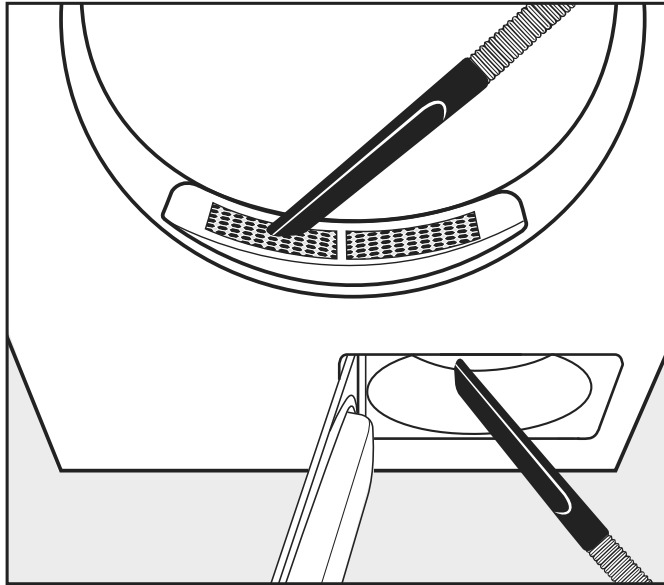

- Use a vacuum cleaner to remove lint:
 - from the cover in the door area (top)
 - from the air guide in front of the fan impeller (bottom) after first removing and cleaning the lint filter

Additional cleaning

- Fan impeller

The fan impeller behind the lint filter flap may be soiled with detergent residue and lint.

Check the fan impeller from time to time and clean it if it is heavily soiled.

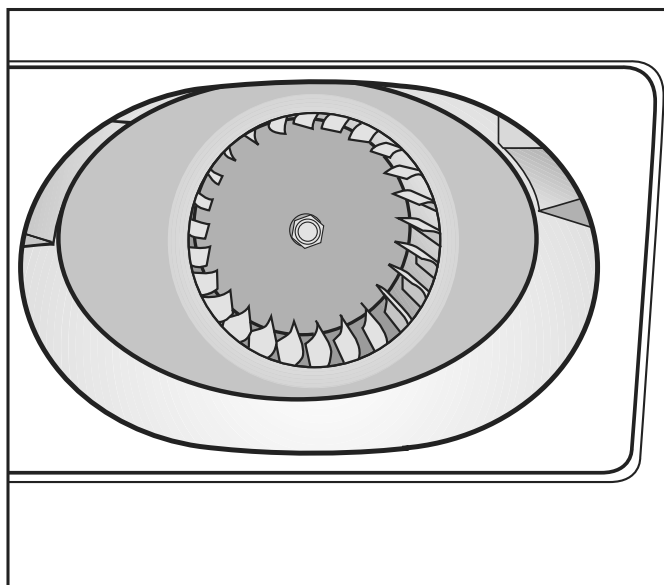

- Using a damp cleaning cloth, carefully remove the coating on the fan impeller.

Cleaning and care

- Also clean the area in front of the fan impeller.
- Use a vacuum cleaner to remove lint.
- Remove any lint from the inside of the open lint filter flap and the sealing element. Be careful not to damage the sealing element.

- Cover in door area

Only remove the cover in the door area in the event of a major blockage.

Removing the cover

- Look inside the drum.

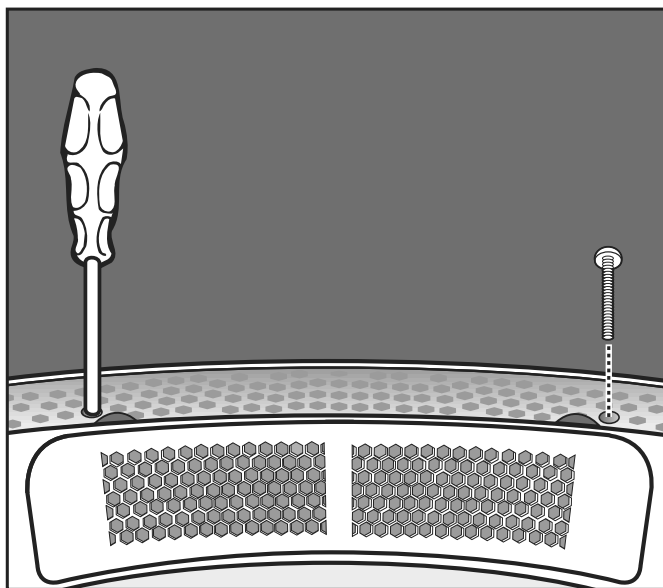

- Underneath the cover on the left and right, unscrew the Torx screws through the round holes.

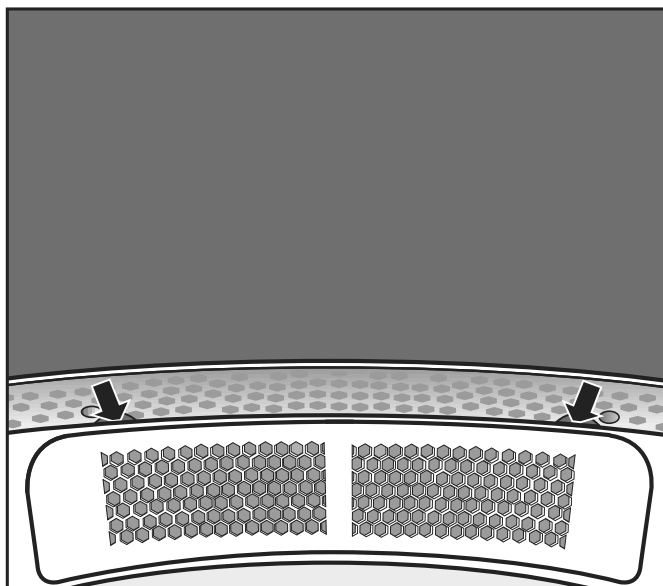

- Reach under the edge of the cover (see arrows) and lift off the cover.
- Clean the air guide underneath the cover with a vacuum cleaner.
- Clean the cover.
- Clean the air guide in front of the fan impeller (open the lint filter flap).

- Reassembly
- Carefully position the cover on the left or right side of the opening.
 - Press down the cover until it engages on the opposite side.
- Securing the cover
- Look inside the drum.
 - Underneath the cover on the left and right, screw in the Torx screws through the round holes.

INSTALLATION INSTRUCTIONS

- To avoid the risk of frost damage, the washer-dryer stack must not be located in rooms which may be subject to very low temperatures.

General operating conditions

This washer-dryer stack is intended only for use in a commercial environment and must only be operated indoors.

- Ambient temperature: 32-105°F (0-40°C)
- Relative humidity: non-condensing
- Maximum height above sea level of location site: 6500 ft (2000 m)

Depending on the nature of the installation site, sound emissions and vibration may occur.

Tip: Have the machine's installation site inspected and seek the advice of a specialist in instances where increased noise may cause a nuisance.

- Transport the machine on a pallet truck inside the room.

Machines with feet must not be pushed to move them.
This could damage the machine feet.

- Remove the packaging carefully with a suitable tool.
- Lift the individual machines in the washer-dryer stack off the pallet using a lifting device.

INSTALLATION INSTRUCTIONS

Facilitating maintenance

To facilitate future maintenance and servicing by Miele Service, the minimum clearances and distance to the wall must be provided to enable access.

- You must observe the minimum clearances and distance from the wall.

Minimum safety distance to the wall approx. 15 3/4" (400 mm) to allow for maintenance.

Minimum safety distance to the side 11 3/4" (300 mm) (wall or other machines).

- Adjust the washer-dryer stack's adjustable feet until the machine is level.

The washer-dryer stack must be completely level to ensure smooth operation.

PDW 909

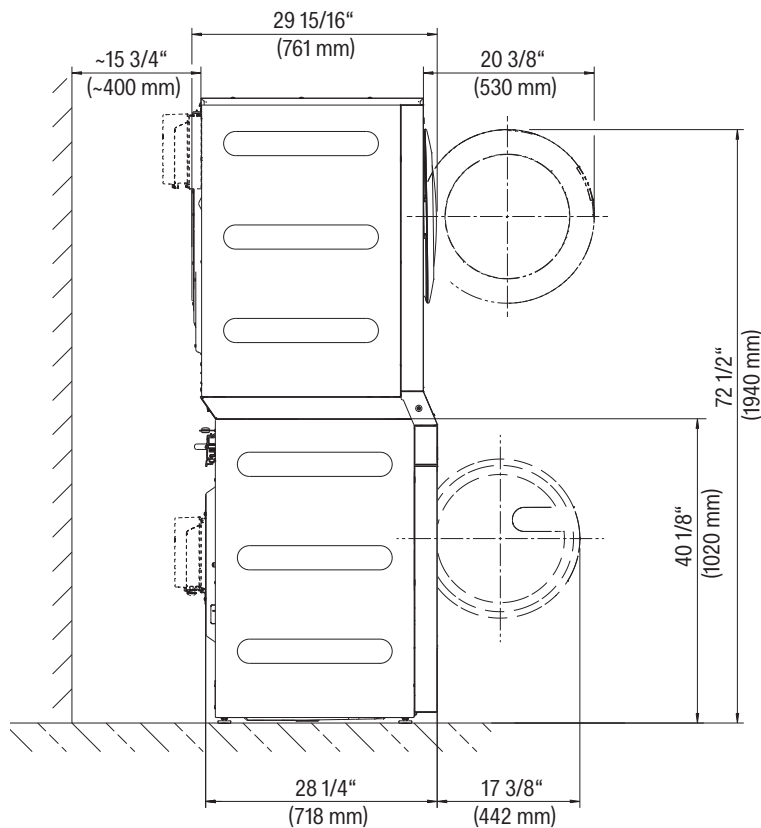

INSTALLATION INSTRUCTIONS

Installing the washer-dryer stack

The washer-dryer stack must be installed by Miele Customer Service or by an authorized dealer. Please observe the instructions in the installation plan.

This washer-dryer stack is only intended for items of laundry that have not been proofed with dangerous or inflammable substances.

The washing machine or tumble dryer must not be operated as individual machines.

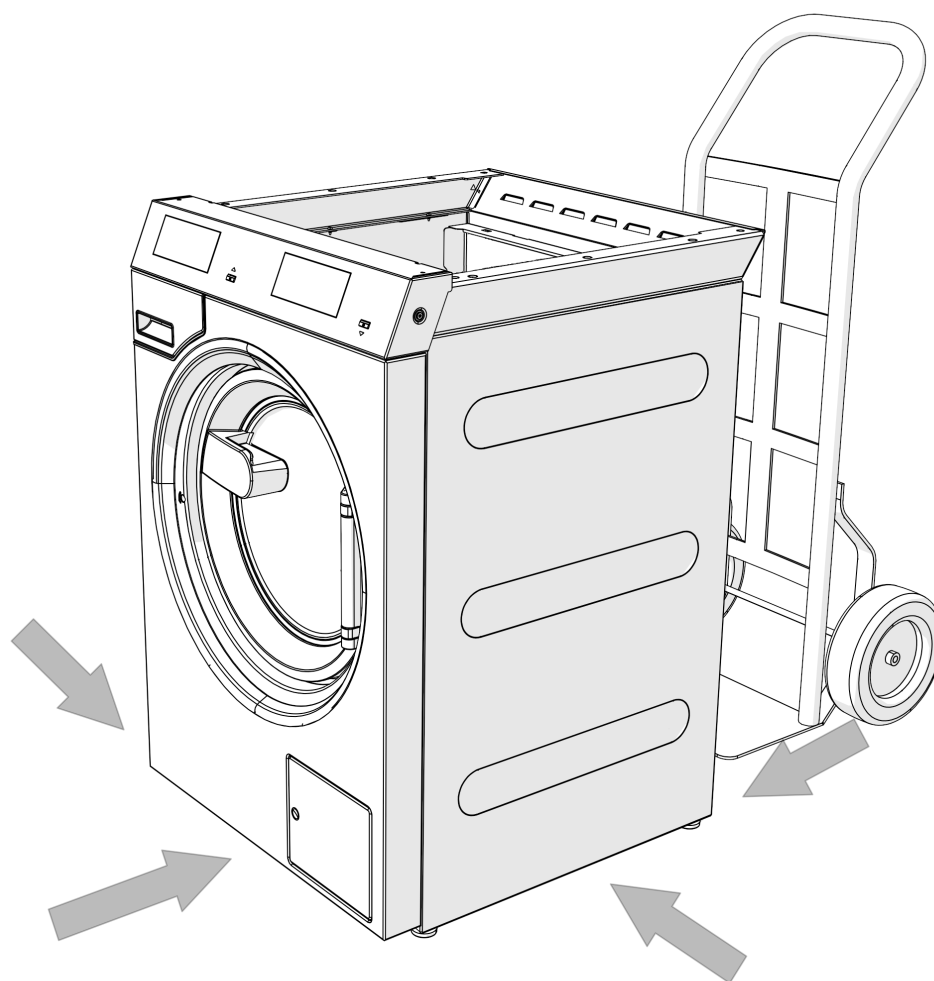

- Transport the washing machine and the tumble dryer in the washer-dryer stack to the installation site one at a time.

⚠ During transportation of the machines, ensure their stability.

⚠ Do not pick them up by the drum door.

- You can also transport the washer-dryer stack to its installation site once it has been assembled.

The assembled washer-dryer stack weighs 461 lb (209 kg).

INSTALLATION INSTRUCTIONS

 During transportation of the complete washer-dryer stack, ensure its stability. The height and center of gravity present a risk of tipping over.

INSTALLATION INSTRUCTIONS

Shipping struts

Removing the shipping struts

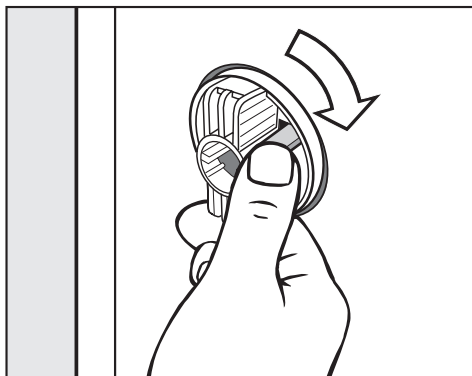

- Release the catch and turn the left-hand shipping strut 90° clockwise.

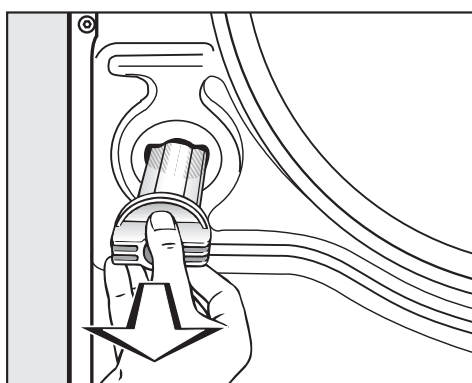

- Pull out the shipping strut.

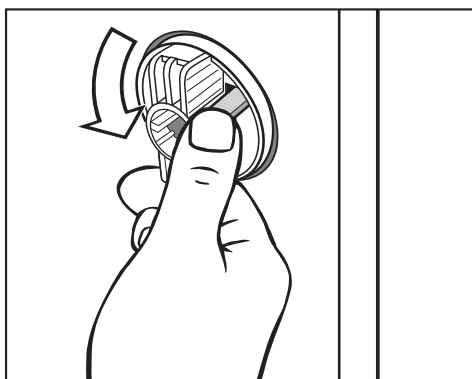

- Release the catch and turn the right-hand transit bar 90° counter-clockwise.

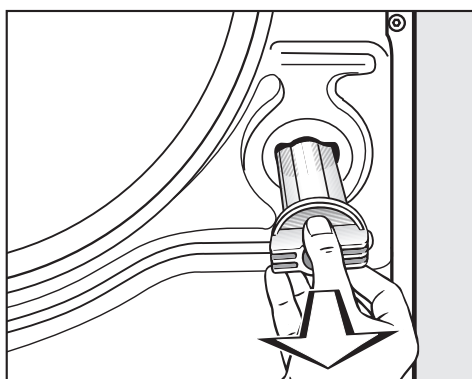

INSTALLATION INSTRUCTIONS

- Pull out the shipping strut.

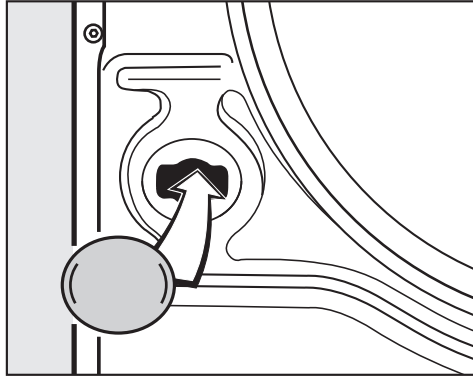

- Place the supplied stoppers on the two holes.

Keep the shipping struts. They must be re-assembled before transporting the machine.

Reinstalling the shipping struts

- Reinstall the shipping struts by following these instructions in reverse order.

INSTALLATION INSTRUCTIONS

Leveling

Ensure that the machine feet and the installation surface are dry to prevent the machine from slipping during the spin cycle.

Incorrect installation may increase water and energy consumption and may cause the machine to move about.

The four adjustable feet are used to level the washing machine. All of the feet are screwed in when the appliance is delivered.

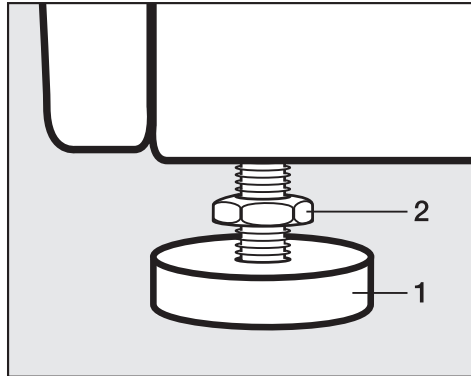

- Using the wrench supplied, turn the counter nut (2) in a clockwise direction. Then turn the counter nut (2) together with the foot (1) to unscrew.

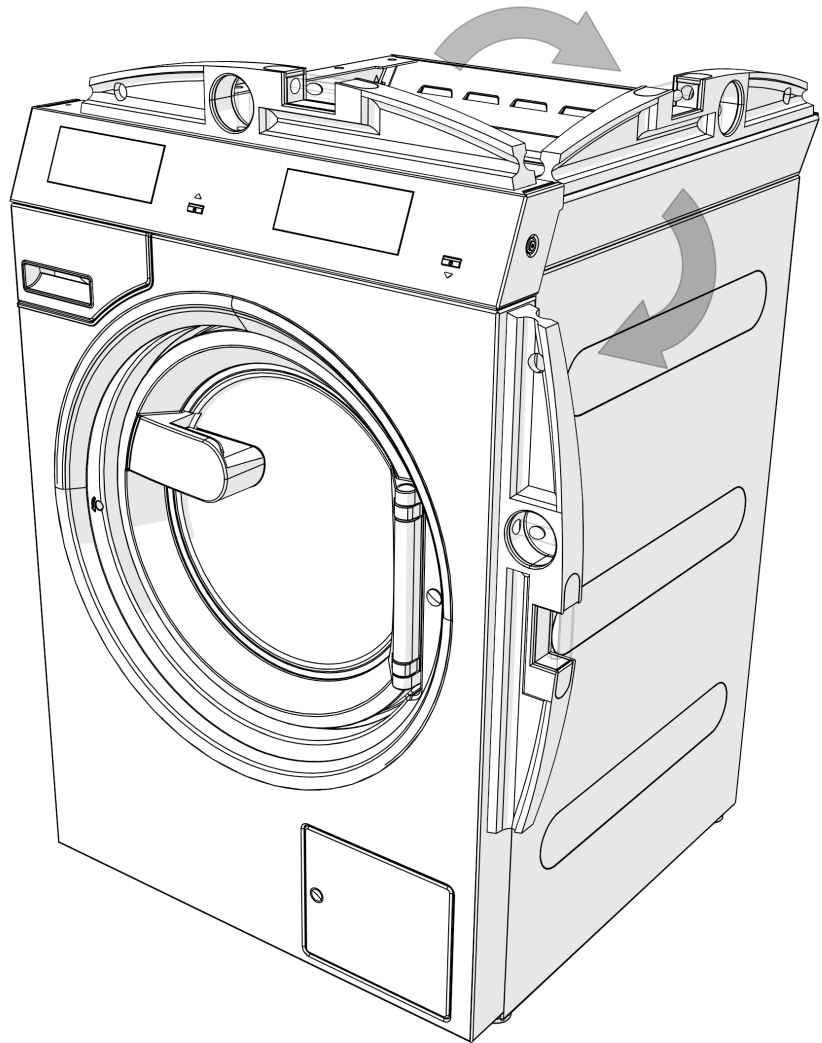

- Use a spirit level to check the machine is standing level.
- Hold the foot (1) securely with a pipe wrench. Turn the counter nut (2) again using the wrench supplied until it sits firmly up against the casing.

All four counter nuts must sit firmly up against the housing. Please also check this for the feet which did not need adjustment. Otherwise there is the danger of the washer-dryer stack moving about.

Securing the machine

- The feet of the washing machine must be secured to the concrete base using the fixtures and fastenings supplied.

Fittings supplied are for installation on a concrete floor. For other types of flooring please purchase suitable fitting materials separately.

⚠ The washer-dryer stack must be secured using tensioning strips during installation.

INSTALLATION INSTRUCTIONS

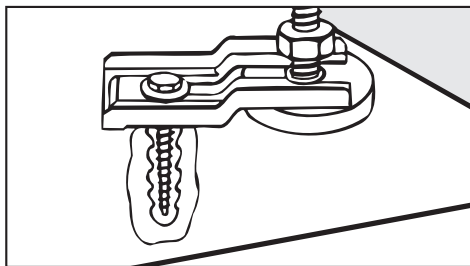

- Secure all four feet of the washer-dryer stack with the tensioning strips provided.
- Follow the installation instructions supplied.

Plumbing

Use of non-return valves

In Germany, the machine must be connected to the water supply using the non-return valve.

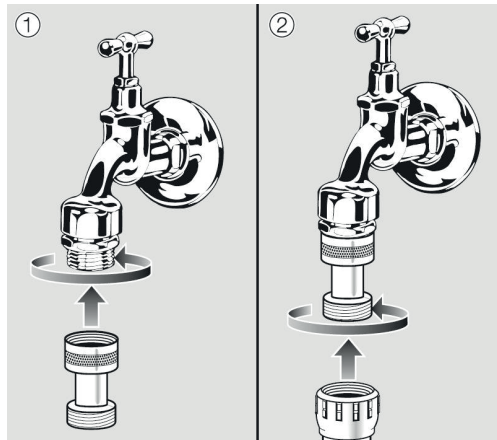

- Attach the non-return valve to the faucet.
- Attach the water inlet hose to the thread of the non-return valve.

⚠ Risk to health and risk of damage due to contaminated incoming water.

The quality of the incoming water must comply with the drinking water regulations in the country in which the washing machine is being operated.

Always connect the washing machine to the drinking water supply.

INSTALLATION INSTRUCTIONS

Cold water connection

For the cold water connection one faucet each with a $\frac{3}{4}$ " screw thread is required.

If a water connection is not available, only a qualified installer may connect the washing machine to the drinking water supply.

The inlet hose for cold water is not suitable for connection to a hot water connection.

Using the machine in cold water mode

For cold water mode, a cold water connection must be established at the cold and hot water valve.

Alternatively, the hot water valve can be deactivated by the technician. The following steps must be performed.

The service technician must deactivate the hot water valve.

- Unscrew the hot water hose.
- Screw on a stopper.

Hot water connection

The same connection requirements as for cold water also apply to hot water up to 158 °F (70 °C).

A suitable connection hose with a threaded union is supplied with the machine.

The machine with hot water connection also requires a cold water connection.

In the event that hot water is not available on site, a cold water supply must be used for the hot water connection.

The required amount of hot water should be added to the cold water volume.

Alternatively, the hot water connection should be blocked using the blind stopper supplied with the machine and the machine controls should be set to cold water intake.

Using the machine in hot water mode

For hot water mode, connect the hot water and cold water connections to the relevant valves. Both connections are required.

Drain pump (depending on model)

In machines with drain pump, the suds are drained through a drain pump with a delivery head of max. 3.3 ft (1 m).

The drain hose must be installed free of kinks for the suds to drain freely.

There are the following options for draining the machine:

- drain hose connected to a plastic drain pipe with a rubber sleeve (there is no need to use a siphon)
- drain hose connected securely to a sink with a plastic nipple
- connected securely to a floor drain (gully)

If required, the hose can be extended to a length of up to 16.4 ft (5 m).

For a drain height of more than 3' 3" (1 m), a replacement drain pump for a delivery head of max. 6 ft (1.8 m) is may be needed.

Special regulations for Austria

The washing machine can be connected directly to the drain pipe if the sewer system meets the requirements of Austrian standard ÖNORM 2501.

Electrical connection

The electrical connection must only be carried out by a suitably qualified electrician in accordance with local and national regulations.

A **residual current device (RCD) type B** (sensitive to universal current) must be used if one is being installed.

The electrical components of the machine comply with EN 60335-1, EN 50571.

The voltage is stated on the data plate.

For hard-wired machines, an all-pole means of deactivation must be provided on site. Switches with a minimum contact gap greater than 3 mm are suitable disconnection switches. These include C/Bs, fuses, and contactors (VDE 0660).

The plug connections or disconnection switches must be accessible at all times.

If the machine is disconnected from the power supply, the disconnection switches must be lockable or the points of disconnection must be monitored at all times.

Preventing hazards

If one of the power cords for this machine is damaged, it must be replaced by the manufacturer, Customer Service, or a similarly qualified person.

Please check the enclosed wiring diagram.

INSTALLATION INSTRUCTIONS

Supply air and exhaust air management

The tumble dryer may only be operated when the ducting has been connected properly and the room is sufficiently ventilated.

Ventilation

The air required for drying is taken from the room where the dryer is installed.

Ensure sufficient room ventilation, e.g., by means of ventilation openings that cannot be closed in the exterior wall.

- It must not be possible to seal off ventilation openings.
- The room ventilation is only working properly if no low pressure occurs. Avoid low pressure, e.g., by means of ventilation openings in the exterior wall.
- For each tumble dryer, there must be a cross section of 52.5 sq.in. (237 cm²) per ventilation opening.

The tumble dryer draws in air at the back. Therefore, there must be a sufficiently large gap between the back of the machine and the wall.

This would otherwise hinder a sufficient flow of air as well as the operational performance of the tumble dryer.

Observe the necessary spacing between the machine and the wall. Do not reduce the gap between the bottom of the tumble dryer and the floor (e.g., toe-kicks, deep pile carpet).

Exhaust air management

The tumble dryer must only be operated if the humid exhaust air generated during drying is conveyed outside through installed vent ducting.

The exhaust air should not be vented into a wall, a ceiling, or a concealed space of building.

Exceptions regarding the design of the exhaust air management system must be designed in accordance with the applicable local building regulations. Seek approval from the relevant building inspector.

- While installing the ducting, keep the tumble dryer disconnected from the power supply.
- Make sure that the plug connections are fully sealed.
- The duct is not to be assembled with screws or other fastening means that extend into the duct and catch lint
- Only use heat-resistant materials with a temperature resistance of at least 175°F (80°C).
- Only use rigid metal duct. Consult local building codes.
- Condensation will form in the exhaust air management system. A condensate drain must therefore be placed at the lowest point in the system.

The opening of the vent ducting (e.g., a wall pipe) must be arranged in such a way that the humid exhaust air:

INSTALLATION INSTRUCTIONS

- does not flow back into the room where the tumble dryer is installed
- does not cause damage or unacceptable disturbance

The air required for drying is taken from the room where the dryer is installed. You must therefore ensure that the room is sufficiently ventilated. Otherwise, there is a risk of suffocation due to exhaust gases being sucked back from other technical systems or fuel-burning installations, and the drying time will be much longer.

The length of the required ductwork and the number and shape of the elbows are determined by the structural conditions on-site. In order to maximize the airflow efficiency, the pipeline should be as short as possible and contain few or minimal elbows.

 The exhaust ducting must not be made from flammable materials.

Otherwise there is a risk of fire.

Use only non-flammable materials for the exhaust ducting. All local regulations for metallic ducting must be observed. Plastic must not be used for ventilation.

In upward exhaust ducting systems, a condensate drain must be fitted to the bottom. The condensate must be drained via a water collection tray or a floor drain positioned in an appropriate location.

If air is being directed from multiple appliances into a combined line (exceptional circumstances), a non-return device (non-return flap) must be installed in each separate line to prevent backflow.

To make subsequent cleaning of the pipes easier, cleaning flaps should be fitted to elbows wherever possible.

The on-site exhaust ducting and venting to the outdoors must be regularly checked for lint deposits and cleaned if necessary.

When connected to the vent ducting through the exhaust duct of a machine, particular care must be taken to make sure the connection is secure and air-tight.

With complex ducting with many bends and additional components, or when several different machines are connected to a shared duct, it is recommended that a detailed pipework calculation is carried out by a qualified specialist.

The vent ducting must not be channeled into a chimney or flue already in use for any gas-, coal-, or oil-burning installation. The warm and moist exhaust air is to be conducted outside or to a suitable venting duct over the shortest path possible.

The vent ducting must be laid so that air flow is not hindered. To achieve this, use as few bends as possible along with short pipelines and well-made connections and transitions checked for air-tightness. No filters or grilles may be fitted in the vent ducting.

The end of the vent ducting leading out into the open should be protected against the elements, e.g., with a downward-facing 90° bend.

 During tumble dryer operation, the room must be adequately ventilated.

INSTALLATION INSTRUCTIONS

- The following should be avoided:
- long vent ducting
 - too many tight bends or elbows
- This will help to stop a reduced dryer performance and excessive time and energy requirements.
- Use:
- for the vent ducting: exhaust air hose* or a plastic waste water pipe (e.g., HT piping systems) with a minimum diameter of 4" (100 mm). Observe local codes.
 - for the extraction ducting outside: wall pipe* or window connection*. Observe local codes.
- *optional accessories

Calculating the total ducting length The friction of the vent ducting with its bends and various components provides resistance to the flow of exhaust air. This friction resistance is expressed as a relative pipe length. The **relative pipe length** indicates how much greater the resistance of a bend is, for example, when compared to 1 meter of a straight plastic waste water pipe (Table I).

Adding together the relative pipe lengths for all of the components gives the **total ducting length**. The total ducting length expresses the resistance of the entire exhaust air system.

As a larger **duct diameter** has a lower flow resistance, a longer duct requires a greater duct diameter (Table II).

- Procedure
1. Measure the length needed for the straight sections of vent ducting. Multiply this value by the corresponding relative pipe length from **Table I**.
 2. Calculate the number of bends and components needed. Use **Table I** to help you add together their relative pipe lengths.
 3. Add together all of the relative pipe lengths calculated above to calculate the total ducting length.
 4. Refer to **Table II** for the pipe diameter needed for the total ducting length.

INSTALLATION INSTRUCTIONS

Table I	
Components	Relative pipe length
Exhaust air hose (flexible aluminum)* / pipe (temperature resistance min. 175°F (80°C)) – 3' 3" (1 m) laid straight or 3' 3" (1 m) straight pipe – 45° bend (radius of bend = 10" (0.25 m)) – 90° bend (radius of bend = 10" (0.25 m))	3' 3" (1.0 m) 2' (0.6 m) 2' 7 1/2" (0.8 m)
The use of a wall pipe or window connection is regarded as an exception to the design principles of the exhaust air management system. This must be carried out in accordance with the applicable local building regulations. Seek approval from the relevant building inspector where necessary.	
Wall pipe* or window connection* – with inserted grate – with non-return flap (swinging flap)	12' 5 5/8" (3.8 m) 4' 11" (1.5 m)
Non-return flap*	46' 11" (14.3 m)
* optional accessories	

Table II	
Maximum permissible total ducting length	Required diameter
65' (20 m)	4" (100 mm)
130' (40 m)	5" (125 mm)
262' (80 m)	6" (150 mm)

Sample calculation

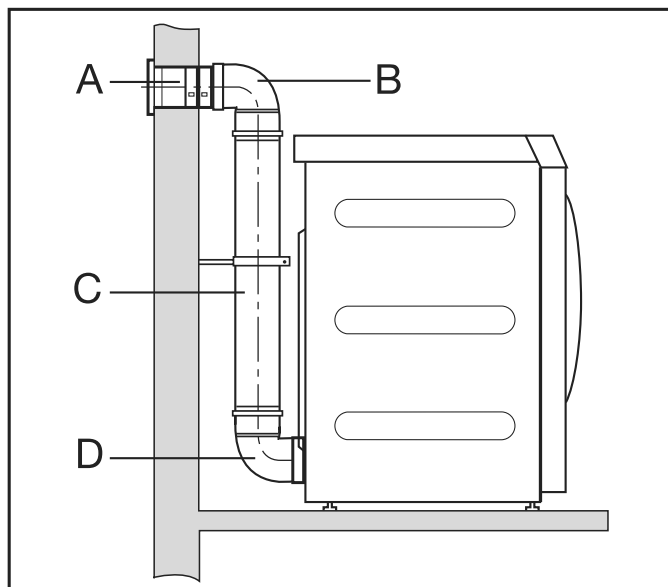

INSTALLATION INSTRUCTIONS

A	Wall pipe, with inserted grate = 1 x 12' 5 5/8" (3.8 m) relative pipe length	= 12' 5 5/8" (3.8 m)
B/D	2 bends, 90° = 2 x 2' 7 1/2" (0.8 m) relative pipe length	= 5' 3" (1.6 m)
C	1' 7 11/16" (0.5 m) pipe = 0.5 x 3' 3" (1 m) relative pipe length	= 1' 7" (0.5 m)
Total ducting length		= 19' 4" (5.9 m)

Result: The total ducting length is less than 65' 7 3/8" (20 m) (as per Table II). A pipe diameter of 4" (100 mm) will therefore suffice.

Exhaust duct dimensions

View from above

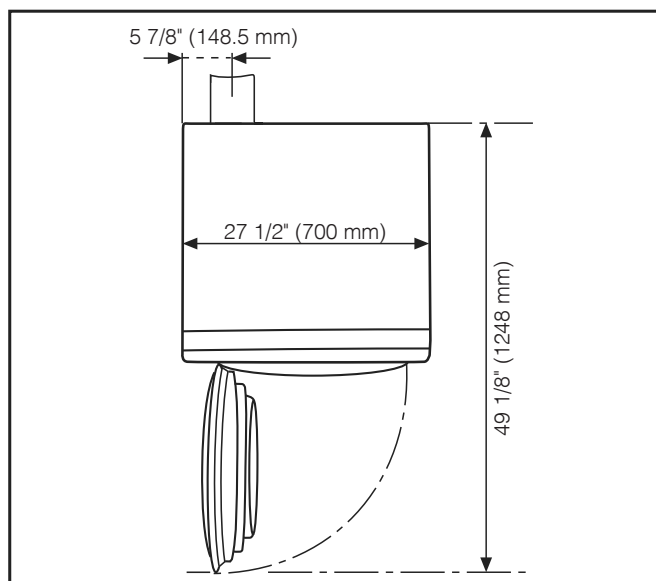

Rear view

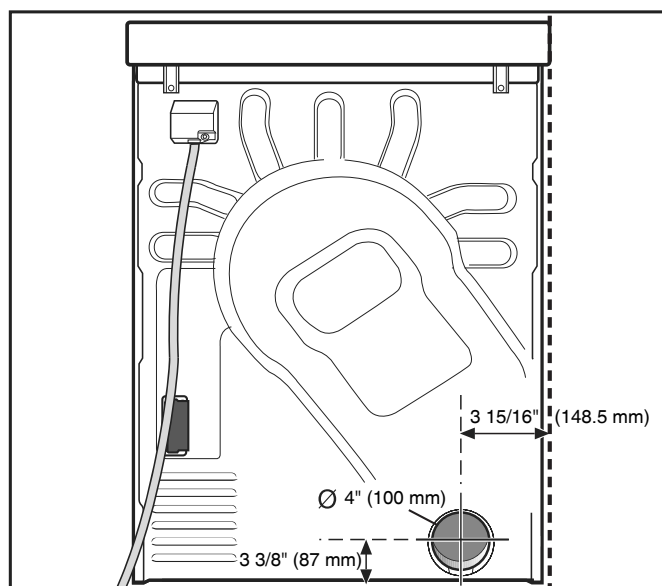

INSTALLATION INSTRUCTIONS

Exhaust air management with plug-in pipes

You will need:

- the connector (supplied)
- pipes and connecting pieces from a suitable retailer

Only use heat-resistant materials with a temperature resistance of at least 175°F (80°C). Observe local ventilation codes.

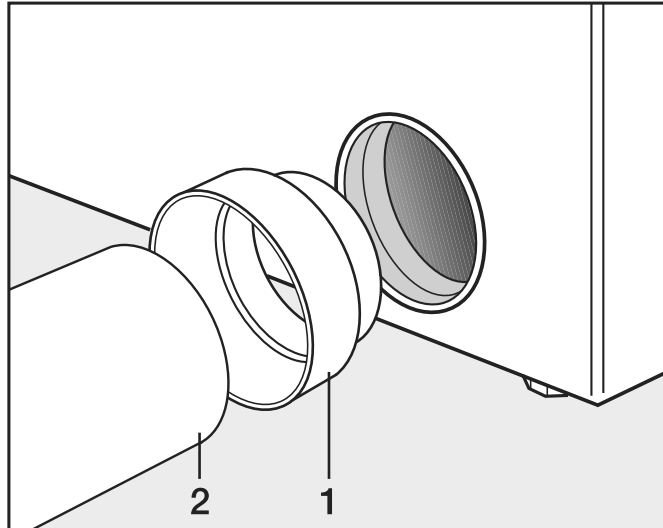

- Install the connector (1) and the pipe (2).

⚠ Wrap heat-resistant metallic tape around the plug connections.

Exhaust air management with flexible aluminum hose

You will need:

- the adapter (supplied)
- flexible aluminum exhaust air hose (where permitted by code)

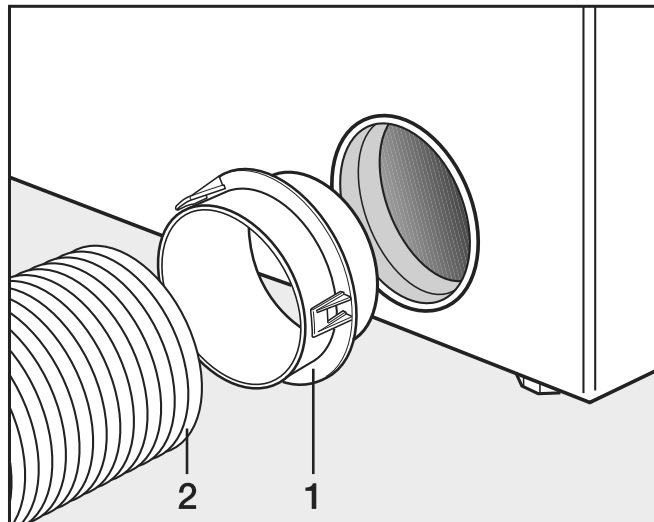

- Install the adapter (1) and the flexible aluminum exhaust air hose (2).

⚠ Wrap heat-resistant metallic tape around plug connections.

Shared exhaust air duct

A shared exhaust air duct is only permitted in exceptional cases. The shared exhaust air duct must be approved by the relevant building inspector.

INSTALLATION INSTRUCTIONS

⚠ A non-return flap must be installed for each tumble dryer. Otherwise, the tumble dryers may be damaged by a backflow of condensation and their electrical safety could be affected.

If 3–5 tumble dryers are installed on one shared exhaust air duct, the pipe diameter **D** must be increased.

Number of tumble dryers	Factor for increasing the pipe diameters from Table II
3	1.25
4–5	1.5

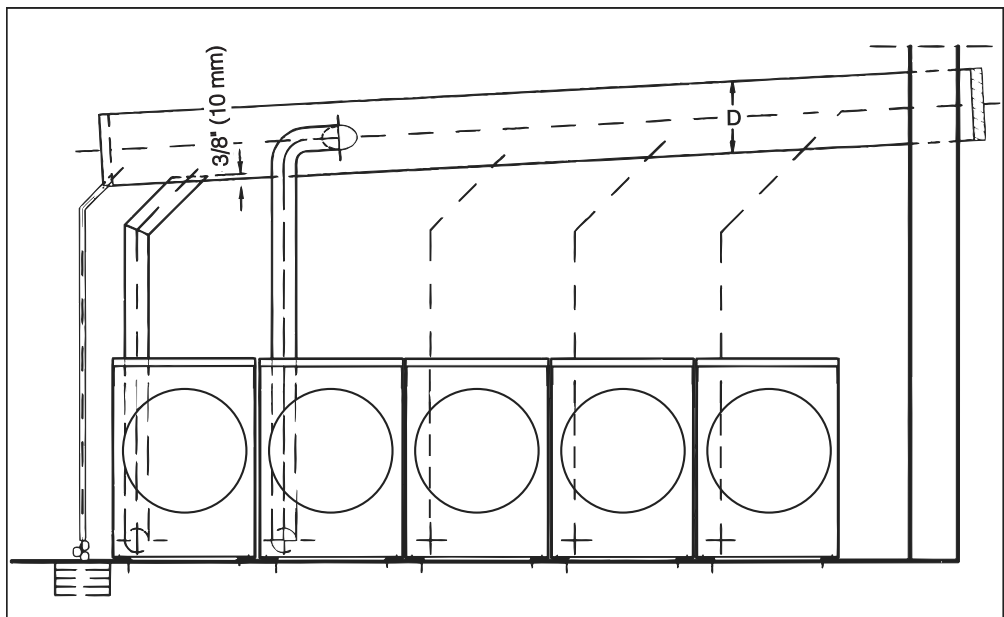

Reference to external machines

A reference to external hardware appears.

- Confirm with the *OK* symbol.

If using a Connector Box, connect it before initial commissioning. The washing machine must be disconnected from the power supply. Then start the commissioning process.

Optional accessories

Only use genuine Miele spare parts and accessories with this machine.

Using parts or accessories from other manufacturers may void the warranty, and Miele cannot accept liability.

Washing machine accessories

Connector Box

The Connector Box allows external hardware from Miele and other suppliers to be connected to the Miele Professional washing machine. The Connector Box is supplied with voltage by the Miele Professional washing machine.

The separately available set consists of the Connector Box and fasteners for installation on the machine or on the wall.

Peak load/energy management

A peak-load or energy management system can be connected via the Connector Box.

The energy management system monitors the energy consumption of a system and deactivates individual pieces of equipment temporarily by means of the peak-load negotiation in order to ensure that certain total load limits are not exceeded.

When the peak-load function is activated, the heating is deactivated and the program stopped. A message appears in the display to inform you of this.

The program is resumed automatically when the peak-load function finishes.

Liquid dispensing connection

External liquid dispensing pumps can be controlled by the Connector Box to dispense liquid detergents. An input for empty sensing is assigned to each dispensing pump output. These inputs can be used if required. In addition, flow sensors can be connected to each dispensing outlet to monitor the dispensing quantity.

It is particularly important to observe the manufacturer's instructions when using a combination of cleaning agents and special application products.

Payment device

The washing machine can be equipped with a single-machine payment system as an optional accessory via the Connector Box.

The programming required for connecting a payment system can be carried out during the initial commissioning process. After initial commissioning, changes should only be carried out by Miele Service.

INSTALLATION INSTRUCTIONS

Please note that the status of the Connector Box must be set to “on” in the supervisor level as required. The payment system settings can be configured at the supervisor level.

The payment system is not activated via the supervisor level.

Wi-Fi/LAN interface

The washing machine is equipped with a Wi-Fi/LAN interface for exchanging data.

The data interface provided on the LAN connection complies with SELV (Safety Extra Low Voltage). The LAN connection uses a RJ45 connector in accordance with EIA/TIA 568-B.

Connected machines must also comply with SELV.

Tumble dryer accessories

Communication box

The optional communication box allows external hardware from Miele and other suppliers to be connected to the Miele Professional machine. External hardware includes e.g., peak-load systems, pressure sensors, or an external vent flap.

The communication box is supplied with voltage by the Miele Professional machine.

The separately available set consists of the communication box and fasteners for installation on the machine or on the wall.

APCL106

The optional Miele communication module can be used to establish a data connection between a Miele Professional machine and a data processor in accordance with the Ethernet or WiFi standard.

This communication module fits into the communication slot which is a standard feature on all machines. The communication module offers the option of intelligent app-based communication with external systems. In addition, it can display detailed machine and program status information.

This module forms the basis for wired communication with Miele MOVE.

It is not possible to integrate the machine into the “Miele@home” app for domestic installations.

The communication module is intended exclusively for commercial use and is supplied with voltage directly via the Miele Professional machine. No additional power connection is required. The Ethernet interface provided via the communication module complies with SELV (safety extra low voltage) requirements in accordance with EN 60950. Connected external machines must also comply with SELV.

Washing machine supervisor level

Opening the supervisor level

- Switch on the washing machine.

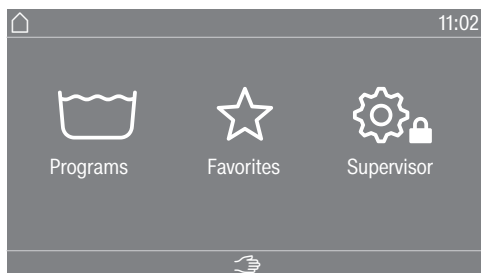

- Touch the Supervisor  sensor control.

The display will change to the Supervisor level menu.

Opening the supervisor level (self-service)

- Switch on the washing machine and open the door.
- ❶ Touch the *Start/Stop* sensor control and hold it down whilst carrying out steps ❷—❸.
- ❷ Close the washing machine door.
- ❸ The *Start/Stop* sensor control will now be flashing quickly; wait until it lights up constantly.
- ❹ Release the *Start/Stop* sensor control when the *Start/Stop* sensor control lights up constantly.

Code-based access

The supervisor level is accessed using a code.

The code is **8000** (factory default).

After entering the code, you will be in the supervisor level. The individual setting options are described in the following sections.

Changing the code

You can alter the supervisor level access code to protect the washing machine from unauthorized access.

Please inform Miele Customer Service if you have forgotten your new code. Customer Service will have to reset the code. Make a note of your new code and store it in a safe place.

Closing the Settings menu

- Touch the  symbol.

The display will then go back to the previous menu level.

- Touch the  symbol.

The display will change to the main menu.

Controls / Display

Language

The display contents can be displayed in a variety of languages. To select the permanent supervisor language you want, go to the Languages submenu.

When a program is running, you can change the user language using the  sensor control.

Language entry

The display can be set to one of several different user languages. This setting allows you to determine how languages can be selected.

International

6 languages are available. The  sensor control is not active. Note the setting *Set languages*.

Language setting

The  sensor control can be used to select a language. All languages are available (factory default).

You can change the order of the first 4 languages. These slots are allocated to the most commonly used languages.

Default language

The user language cannot be changed. The user language is the same as the supervisor language. The  sensor control is not active.

Set languages

The languages for the Language entry International setting can be changed.

6 languages can be selected. All languages are available.

If you wish to add a new language to the language menu:

- First select the language you want to replace.

All available languages are displayed.

- Select and confirm the language to replace the previous language.

The new language appears instead of the old one.

Time

After selecting the clock format, you can set the time of day.

Clock format

- 24 h clock
- 12 h clock
- No clock

Set

- The time can be set.

Date

The date can be set after selecting the date format.

Date format

- DD.MM.YYYY
- YYYY.MM.DD
- MM.DD.YYYY

Date

- The date can be set.

Washing machine supervisor level

Logo	Different logos can be selected for the user interface.
Start screen	Different views can be selected for the start screen. The start screen is displayed after exiting a submenu.
Mode	Different supervisor modes can be selected.
Display brightness	<div style="border: 1px solid black; padding: 5px;">The brightness of the display can be altered. The setting depends on the various lighting conditions in the place of installation.</div> <p>It can be set to one of 10 different levels.</p>
Display off status	<div style="border: 1px solid black; padding: 5px;">In order to save energy, the display can be set to switch to standby mode automatically after the end of the program or if no further selection is made. In the default setting, the machine will not switch to standby mode automatically.</div> <p>Changing this factory default setting may lead to increased energy consumption.</p> <ul style="list-style-type: none">- Off- On (10 min.) Not curr.prog.- Logo (10 min.) Not curr.prog.- On after 10 min.- On (30 min.) Not curr.prog.- Logo (30 min.) Not curr.prog.- On after 30 min.
Machine off status	<div style="border: 1px solid black; padding: 5px;">In order to save energy, the washing machine can be set to switch to standby mode automatically after the end of the program or if no further selection is made. In the default setting, the machine will not switch to standby mode automatically.</div> <p>Changing this setting may lead to increased energy consumption.</p> <ul style="list-style-type: none">- No switch-off (factory default)- Switch-off after 15 minutes- Switch-off after 20 minutes- Switch-off after 30 minutes
Volume	<div style="border: 1px solid black; padding: 5px;">The volume for various sounds can be changed.</div> <p>It can be set to one of 7 different levels or switched off altogether.</p> <ul style="list-style-type: none">- Finish tone- Keypad tone- Welcome tone- Fault tone <p>The fault tone can be activated or deactivated.</p>
Visibility parameters	<div style="border: 1px solid black; padding: 5px;">Various parameters, such as the temperature, spin speed, Extras, etc., are displayed when a program is selected. You can decide which parameters should not be displayed. The parameters cannot be changed/are no longer displayed.</div> <p>Factory default: all parameters are visible (marked in orange)</p>

Washing machine supervisor level

Sorting extra options	<p>Under the setting <i>Visibility parameters</i>, <i>Sort Extras</i> appears in the bottom line. Touch the sensor control to change the sequence of extra options (see “Supervisor level – Arranging programs”).</p>
Delay start	<p>The delay start (timer) display can be switched on or off.</p> <p>Factory default: on</p>
Memory	<p>The washing machine will save the settings (temperature, spin speed, and some of the options) which have been selected for a wash program after the program has started.</p> <p>When the wash program is chosen again, the saved settings will appear in the display.</p> <p>Factory default: off</p>
Manual control	<p>The manual control function can be switched on or off. Switch-on can be carried out with or without identification.</p>
Change order	<p>The skip function can be switched on or off.</p>
Measuring system	<p>You can choose whether the temperature and weight are displayed in metric or imperial units.</p>
Supervisor code	<p>You can alter the access code to the supervisor level. The code supervisor is independent of the code expert.</p> <ul style="list-style-type: none">■ Enter the current code.■ Enter a new code. <p>When creating a new code, number sequences such as 1234 and four-digit numbers such as 2222 are not permitted.</p>
Wi-Fi	<p>In this menu, you control the networking of your washing machine (see “Networking”).</p>

Washing machine supervisor level

Program selection

Controls

Tip: Start by configuring all necessary settings and changes to the washing machine before selecting any of the options below.

If “Laundromat, basic” or “Laundromat, Logo” is selected, the supervisor level can no longer be opened from the display after the *Supervisor level* is closed. Please follow the instructions below for special access to the supervisor level if you wish to change any other settings.

Standard (factory default).

All functions and programs can be displayed.

Laundromat, basic

Up to 24 programs are available. Go to Favorite programs to select which programs are to be listed.

Laundromat logo

Up to 24 programs are available. Go to Favorite programs to select which programs are to be listed.

External program selection

Programs are selected using a communication module with Ethernet, e.g., via an external terminal.

Washing machine supervisor level

Program packages	<p>The selection of programs can be expanded by activating single programs from the target group program packages.</p> <p>The programs selected from the program packages (marked in orange) are displayed during program selection.</p>
Favorite programs	<p>After switching on, you can also select a program via: ☆ Favorites. 24 programs can be stored as favorites based on your own priorities and requirements.</p> <p>These favorite programs will also be made available in the control options</p> <ul style="list-style-type: none">- <i>Laundromat logo</i>- <i>Laundromat, basic control options.</i> <p>You can specify the control option under Controls.</p> <p>Tip: You can assign a separate colored frame to each program. In this case, the “Color assign. program setting must be set to <i>On</i>.</p> <p>Changing favorite programs</p> <ul style="list-style-type: none">■ Select the program you wish to change or replace.■ Confirm the program or the setting to be changed. <p>Another menu opens, enabling you to select a new program or change the parameters.</p> <ul style="list-style-type: none">■ Confirm by touching the <i>Save</i> selection area. <p>Your selection is now active.</p>
Sort programs	<p>Programs can be moved within the program list and in the favorites list.</p> <p>Factory default: off</p>
Moving programs	<ul style="list-style-type: none">■ Touch the selection area for the program you want to move.■ Press and hold the selection area until the frame changes.■ Drag the program to the required place.
Program color allocation	<p>You can assign a frame to a favorite program. In the list of favorites, each favorite program is given a colored frame, which can be adjusted.</p> <p>Factory default: on</p>
Expert code	<p>A code has to be entered to cancel a disinfection program. The code can be modified.</p> <p>The code expert is independent of the code supervisor level.</p> <p>The code is: 8 0 0 0</p> <p>Make a note of your new code if you ever change it.</p>

Washing machine supervisor level

Process technology

Anti-crease

The Anti-crease function helps prevent creasing after the end of the program. At the end of the program, the drum continues to turn for up to 30 minutes.

The washing machine door can be opened at any time during the Anti-crease phase.

Factory default: on

Automatic drainage

Automatic water drainage can be switched on or off. Automatic water drainage means that the suds are always drained away after the end of a program. This is also the case for programs that reach the program end with water still in the drum.

Factory default: off

Service

Service interval

Service information can appear in the display. You can configure whether a date or the number of operating hours is displayed.

You can select up to 2 messages with their own text.

Your message is displayed at the end of the program and can be acknowledged with *OK*. The same message appears at the end of the next program.

Settings

This setting allows you to determine the interval (by hours or date) at which the message appears.

- Factory default: off
- By time
You can then select a time interval from 1–9,999 hours.
- By date
You can then enter a date.

Message text

Enter your message for your planned maintenance work.

Resetting the display

The message appears until the display is permanently reset. The message then appears again once the next interval is reached.

External applications

Payment system lock

The payment device lock can be switched on or off. When the lock is switched on, the duration until locking can be selected from various time intervals.

Connector box

External hardware is connected via the Connector Box. This can be switched on or off.

The Connector Box must be selected in order for settings to be made in the Dispensing menu.

Automatic dispensing

Automatic dispensing can be switched on or off.

Automatic dispensing can be activated via the Connector Box or the COM module.

Dosage

The Connector Box must be switched on in order for settings to be adopted in the Dispensing menu.

1–6 dispenser pumps can be switched on.

Further settings can be made after activating the dispenser pump.

- Deactivate disp. pump
- Calibration
- Flow rate (new): ml/min
- Correction factor
- Container size
- Adv. warning level reminder
- Reset adv. warning
- Level reminder
- Flow meter

Peak load prevention

The peak-load prevention function can be switched on or off. With this function, the execution of a wash program is not affected when a peak-load signal is in place. The heater stays switched on.

Machine parameters

Maximum spin speed

The maximum spin speed can be set via a keypad.

Max. adjust. temperature

The maximum temperature can be set via a keypad.

Legal Information

[Open source licenses](#)

You can view information here (see WiFi data protection).

Tumble dryer supervisor level

Opening the Supervisor level

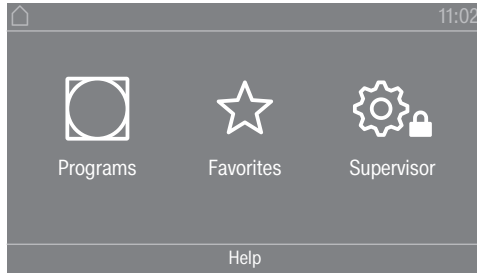

Touching the  sensor button takes you to the Supervisor level.

Access via code

The supervisor level is accessed using a code.

Factory default: The code is **000**.

Change code

You can alter the supervisor-level access code to protect the tumble dryer from unauthorized access.

Carefully enter a new code.
Please inform Technical Service if you have forgotten your new code. Technical Service will have to reset the code.
Make a note of your new code and store it in a safe place.

Closing the settings menu

- Touch the  sensor control.

The display will then go back to the previous menu level.

- Touch the  sensor control.

The display will change to the main menu.

Controls / Display

Language

The display can be set to appear in one of several different languages. To select the language you want, go to the *Languages* sub-menu.

You can change the language as follows:

- Permanently using the supervisor level (= “Supervisor language”).
- For the duration of the current program only using the  sensor control. The supervisor language is displayed again at the end of the program.

Language entry

The display can be set to one of several different user languages. This setting allows you to determine how languages can be selected.

You can change the language as follows:

International

6 languages are available. The  sensor button is not active. Note the setting *Set languages*.

Language setting

The  sensor button can be used to select a language. All languages are available (factory default).

You can change the order of the first 4 languages. These slots are allocated to the most commonly used languages.

Standard language

The user language cannot be changed. The user language is the same as the supervisor language. The  sensor button is not active.

Set languages

The languages for the International lang. entry setting can be changed.

6 languages can be selected. All languages are available.

If you wish to add a new language to the language menu:

- First select the language you want to replace.

All available languages are displayed.

- Select and confirm the language to replace the previous language.

The new language appears instead of the old one.

Display brightness

The brightness of the display can be altered. The setting depends on the various lighting conditions in the place of installation.

- It can be set to one of 10 different levels.

Clock display

After selecting the clock format, you can set the time of day.

Clock format

- Factory default: 24-hour display
- 12-hour display
- No clock

Set

- The time can be set.

Date

The date can be set after selecting the date format.

- Date format

The date can be shown starting with the day, month, or year.

- Date

The date is set.

Volume

The volume for various sounds can be changed.

The volume can be changed for the following tones:

- Finish tone
The finish tone signals the end of the drying program.
- Keypad tone
- Welcome tone
- Fault alarm

The fault tone signals a fault and can be switched off. The volume of the fault tone cannot be adjusted.

Tumble dryer supervisor level

Res. moisture display

In addition to displaying the drying level, the residual moisture can also be indicated as a percentage.

- Factory default: Without % value
- With % value

Visibility parameters

Various parameters are offered/displayed when a program is selected. You can decide which parameters should not be displayed. These parameters can then not be edited during program selection.

- Residual moisture
- Duration
- Low temperature
- Anti-crease
- Load size
- Drying temperature

Display off status

The display switches off to save energy; only the *Start/Stop* sensor control flashes slowly. You can change this setting.

Changing this setting leads to increased energy consumption.

- Off
No switching off
- On (10 min.) Not curr.prog.
The display will remain on while the program is running but will go out 10 minutes after the end of the program.
- Logo (10 min.) Not curr.prog.
The display will remain on while the program is running but the logo will light up 10 minutes after the end of the program.
- Factory default: On after 10 min.
The display is switched off after 10 minutes.
- On (30 min.) Not curr.prog.
The display will remain on while the program is running but will go out 30 minutes after the end of the program.
- Logo (30 min.) Not curr.prog.
The display will remain on while the program is running but the logo will light up 30 minutes after the end of the program.
- On after 30 min.
The display will go out after 30 minutes.

Machine off status

In order to save energy, the tumble dryer will switch off automatically after the end of the program or if no further selection is made. You can change this setting.

Changing this setting leads to increased energy consumption.

- No switch off
- Factory default: Switch off after 15 minutes
- Switch off after 20 minutes
- Switch off after 30 minutes

Delay start

The delay start (timer) can be activated or deactivated.

- Factory default: Off
 - On
- Memory**
- The tumble dryer saves the settings that were selected last for a drying program (drying level and/or extra option, or the duration for some programs).
- Factory default: Off
 - On
- Temperature unit**
- You can select the unit for the temperature display.
- Factory default: °C
 - °F
- Weight unit**
- You can decide whether load quantities are displayed in “kg” or “lb”.
- Factory default: kg
 - lb
- Change code**
- You can alter the access code to the supervisor level.
- Enter the current code.
 - Enter a new code.
- Program selection**
- Controls**
- You can select whether the tumble dryer is operated as a “laundromat” machine. Shortcuts are the easiest way to operate the machine. Operating staff are unable to change pre-set programs.
- Tip:** Start by configuring all necessary settings and changes to the tumble dryer before adjusting any of the options below.
- Caution:** When activating any of these options, the supervisor level will no longer be available. You will no longer be able to access the supervisor level via the display. Please follow the instructions below if you wish to change any other settings.
- Opening the supervisor level (laundromat version)
- Switch the tumble dryer on and open the dryer door.
 - ❶ Touch the *Start/Stop* sensor control and hold it down while carrying out steps ❷—❸.
 - ❷ Close the tumble-dryer door.
 - ❸ Wait until the *Start/Stop* sensor control, which will now be flashing quickly, lights up constantly ...
 - ❹ ... and then release the *Start/Stop* sensor control.
- Standard
 - Factory default: All (selected) programs are available.
 - Laundromat, basic
 - 12 programs are available.
 - Under Favorite programs, you can set which of the 12 programs to select or modify.

Tumble dryer supervisor level

- Laundromat Logo
12 programs are available.
Under Favorite programs, you can set which 12 programs to select/modify.
- Laundromat Logo ext. time
4 timed programs* with different temperature levels are time-controlled.
The set value indicates the program runtime and cannot be modified by the user.
* The maximum program runtime is specified during initial commissioning.
- Laundromat Logo int. time
4 timed programs* with different temperature levels are time-controlled via the tumble dryer's electronic.
The set value indicates the maximum program runtime and can be modified by the user.
* The maximum program runtime is specified during initial commissioning.
- External prog. selection
A communication module can be used to select the program from an external terminal.

Program packages

This allows you to specify the scope of the tumble dryer's program. You can select all of the programs or individual programs from the relevant program packages.

The tumble dryer's additional scope of programs can be configured. The programs are listed under "Program overview".

Favorite programs

After switching on, you can also select a program via: ☆ Favorites. 12 programs can be stored as favorites based on your own priorities and requirements.

These favorite programs will also be made available in the control options

- *Laundromat ext. (12 prog)*
- *Laundromat, basic (4 prog)* (the first 4 of the 12 favorite programs).

You can specify the control option under Controls.

Tip: You can assign a different color to each program. In this case, the Program color allocation setting must be set to *On*.

Changing Favorite programs

- Select the program you wish to change or replace.
- Confirm the program or the setting to be changed.

Another menu opens, enabling you to select a new program or change the parameters.

- Confirm with the *Save sensor control*.

Your selection is now active.

Special programs

You can put together 5 special residual-moisture or time-controlled programs and assign your own program names.

First, enter the program name.

- Select the special program you want to change.

The **Save as** menu opens.

- Use the letters and symbols below the line to enter the name.
- Touch the **Save sensor control**.

You can now enter the parameters for a **Res. moisture program** or **Timed drying**.

The 5 special programs are pre-programmed at the factory. You can change these special programs.

The special programs are added to the program packages. Enter the name and settings of your special program into the “Special programs” table in the “Program overview” chapter.

Res. moisture program:

- Final residual moisture:
-6% (dry) – 40% (damp)
- Extra drying time:
0–60 minutes
- Temperature (Process air):
cold – 165°F (75°C)
- Cooling down temperature (Process air):
105–130°F (40–55°C)
 - Drum rotation main direction:
20–600 seconds
 - Pause:
2–15 seconds
 - Drum reversal:
20–600 seconds
- Anti-crease
 - Drum rotation main direction:
0–500 seconds
 - Pause:
100–3,000 seconds
 - Drum reversal:
0–500 seconds

Timed drying:

- Running time:
5–180 minutes
- Temperature (Process air):
cold – 165°F (75°C)
- Cooling down temperature (Process air):
105–130°F (40–55°C)

Tumble dryer supervisor level

- Drum rotation main direction:
20–600 seconds
- Pause:
2–15 seconds
- Drum reversal:
20–600 seconds
- Anti-crease
 - Drum rotation main direction:
0–500 seconds
 - Drum reversal:
0–500 seconds
 - Pause:
100–300 seconds

Sort programs

Programs can be moved within the program list and in the Favorites list.

- Factory default: Off
- On

Moving programs/ favorites

You can move/change the order of the programs (program menu – single option list). You can also move and change the order of the favorites that you edit in the *Supervisor level* under *Favorite programs*.

- Touch the program that you wish to move.
- Press and hold the sensor control until the frame changes.
- Drag the program to the required place.

Program color allocation

You can assign a specific color to a favorite program. In the list of favorites, each favorite program is given a colored frame, which can be adjusted.

- Factory default: Off
- On

Process technology

Anti-crease

At the end of the program, the drum will continue to rotate at intervals if the laundry is not removed immediately.

Changing this setting leads to increased energy consumption.

The setting for Anti-crease (🌀) can either be switched off or a time between 1 and 12 hours can be selected.

Factory default: 2 hours

Drying levels

Changing this setting leads to increased energy consumption.

You can alter the drying levels for the Cottons, Minimum iron, and Automatic Plus programs.

Drying levels Cottons, Minimum iron, and Automatic Plus can be set to one of 7 different levels.

Factory default: Normal

The residual moisture in drying level Machine iron can be set in 11 levels from 16% (dryer) to 26% (damper).

Factory default: 20%

Additional cooling

If extended cooling is activated, the drum temperature is checked approx. 1 minute before the machine goes into standby mode at the end of the program. If the temperature is above 130°F (55°C), the dryer will carry out cooling until it is below 130°F (55°C).

Changing this setting leads to increased energy consumption.

- Factory default: Off

- On

Cooling down temperature

The laundry will be cooled down automatically after the end of the program. The automatic cooling phase can be set at a cooler level for all programs. This means that the cooling phase is extended.

Changing this setting leads to increased energy consumption.

The setting can be changed from 104-131°F (40°C–55°C).

Factory default: 131°F (55°C)

Fan pulsed operation

The fan operates intermittently to release laundry that is stuck in front of the inner drum door. With Heat-Pump Dryers, the fan operates intermittently to dry duvets.

The fan is switched on and off at certain intervals.

Deact. pulsed operation

Pulsed delay after start

Fan down time

Reversing cycle

Service

Clean out the airways

The tumble dryer's electronic calculates the degree to which lint or detergent residues in the lint filters and vent ducting are impairing performance. A message to check the contamination appears. You can decide at what level of lint this reminder should be emitted.

If the message appears on the display even though the lint filter is clean, the vent ducting is regarded as borderline. Miele recommends improving the vent ducting. Poor vent ducting will result in longer program runtimes and greater energy consumption.

This reminder, which you can configure, is displayed: Clean out the airways

- Off

The reminder does not appear. However, if there is a very severe blockage in the ducting, the program will be canceled regardless of this option.

- Heavy

The reminder only appears when there is a heavy build-up of lint.

- Factory default: normal

Tumble dryer supervisor level

- Light

The reminder appears when there is only a small build-up of lint.

Clean the filters

The lint filter in the air-supply area must be cleaned on a regular basis. You can set an hourly interval for the reminder.

The selected hourly interval depends on how much lint tends to build up and how often you wish to clean the filter, e.g., for hygiene purposes.

You can adjust this reminder: Clean the filters

- Time interval of 5 – 55 hours
- Factory default: after 55 hours
- Off

Service interval

The tumble dryer shows a custom message at a selected interval to prompt you to undertake specific maintenance tasks.

3 different messages can be created: 1/2/3. Each message is created in the language and alphabet of the current supervisor language.

Your message is displayed at the end of the program and can be acknowledged with OK. The same message appears at the end of the next program.

Settings

This setting allows you to determine the interval (by hours or date) at which the message appears.

- Factory default: Off
- By time
You can then select a time interval from 1–9999 hours.
- By date
You can enter a date.

Message text

Enter your message for your planned maintenance work. You can edit one, two, or all three of the 1/2/3 messages.

Resetting the display

The message appears until the display is permanently reset. The message then appears again once the next interval is reached.

External applications

External exhaust flap

External hardware is connected via the Miele Connector Box.

The time delay between the external exhaust-air flap's activation point and the switch-on time for the drum/fan motor is regulated.

A message appears in the display while the exhaust air flap is open.

- Factory default: off

This option must always be selected if there is no exhaust air flap to activate. This prevents the program from being canceled.

- On (1 second to 5 minutes)

Additional fan

External hardware is connected via the Miele Connector Box.

The additional fan is switched on by the dryer (via Connector Box) in parallel with the internal fan.

- Off

- On

Pressure sensor

External hardware is connected via the Miele Connector Box.

When using a shared exhaust air duct, one tumble dryer may have to be switched off or suppressed from the outset if certain pressure levels have built up in the ducting. The external pressure sensor is only checked if the external exhaust air flap and/or the external additional fan is set to "on".

A message appears in the display while the exhaust air flap is open.

- Off = Not active

- Normally open contact = Active

Responds to **high potential**

- NC contact = Active

Responds to **low potential**

Peak load signal

External hardware is connected via the Miele Connector Box.

The peak-load negotiation function enables the tumble dryer to be connected to an energy management system. When a signal is registered, the tumble dryer's heater is switched off for a short period or the machine is prevented from being switched on.

A peak-load signal can be issued via the Connector Box or via the COM module.

- Factory default: No function

- Peak load with 230V

- Peak load with 0V

- KOM module

Peak load prevention

With this function, the application of a hygiene program is not amended when a peak-load signal is in place. The heater stays switched on.

- Factory default: Off

Tumble dryer supervisor level

	<ul style="list-style-type: none">- On
Select KOM module	<div style="border: 1px solid black; padding: 5px;"><p>This tumble dryer is equipped with an integrated WiFi module. However, the tumble dryer can also be equipped with an external module.</p></div> <ul style="list-style-type: none">- Factory default:<ul style="list-style-type: none">Off- Internal module The internal WiFi module is used.- external module An XKM module is inserted into the module slot.
Availability of Miele digital products	<p>The ability of Miele digital products depends on the availability of the services in your country.</p> <p>The different services are not available in all countries.</p> <p>For information about availability, please visit www.miele.com.</p>
WiFi / LAN	<div style="border: 1px solid black; padding: 5px;"><p>Control the networking of your tumble dryer.</p><p>Networking of the tumble dryer for use with the digital Professional tools is only possible with the external module. The internal module can only be used by Miele Customer Service.</p></div> <ul style="list-style-type: none">- Deactivate (visible when the network is activated) The network remains set up; the WiFi function is switched off.- Activate (visible when the network is deactivated) The WiFi function is reactivated.- Connection status (visible when the network is activated) The following values are displayed:<ul style="list-style-type: none">– the quality of WiFi reception– the network name– the IP address- Set up again (visible when set up) Resets the WiFi login (network) to immediately re-establish a new connection.- Reset (visible when set up) The network is no longer set up. A new connection has to be established in order to use the network again.<ul style="list-style-type: none">– The WiFi is switched off– The WiFi connection will be reset to the factory default
Network time	<div style="border: 1px solid black; padding: 5px;"><p>The date and time can be synchronized over the network.</p></div> <ul style="list-style-type: none">- Off The date and time are not synchronized over the network.- As master The machines are in a network but are not connected to the Internet. A machine is declared as the master and sends data to the <i>slave</i> appliances.- As slave

Tumble dryer supervisor level

The machines are in a network and are connected to the Internet. All machines are configured as *slaves*. Data is synchronized over the Internet.

Remote

External program selection is possible via an external terminal (program may only be started on the machine). However, programs may also be selected and started on the machine.

Factory default: on

Remote Update

The RemoteUpdate function is used for updating the software in your dryer.

RemoteUpdate is activated by default.

If you do not install a RemoteUpdate, you can continue to use your tumble dryer in the usual way. However, Miele recommends installing RemoteUpdates.

Miele's RemoteUpdate function can only be used if the dryer is connected to a WiFi/LAN network and you have an account in the Miele Professional app. The dryer must be registered in the app.

See the Miele Professional app for terms of use.

If a RemoteUpdate is available for your tumble dryer, it will be displayed automatically when the supervisor level is open.

You can choose to start the RemoteUpdate immediately or wait until later. If you select "Start later", the prompt to run the RemoteUpdate will be displayed again the next time you switch on your tumble dryer.

The RemoteUpdate can take a few minutes.

Please note the following information about the RemoteUpdate function:

- You will only receive a message when a RemoteUpdate is available.
- Once a RemoteUpdate has been installed, it cannot be undone.
- Do not switch off the tumble dryer during a RemoteUpdate. Otherwise, the RemoteUpdate will be aborted and will not be installed.

SmartGrid

The SmartGrid setting is only visible if a WiFi network has been set up and activated. This function can be used for starting your Miele Professional Machine automatically at a time when your energy costs are most economical.

Activating SmartGrid gives the Timer sensor control a new function. Use the Timer sensor control to set SmartStart. The tumble dryer will then start within the timeframe specified when it receives a signal from the energy supplier. If it has not received a signal from the energy supplier by the latest start time set, the tumble dryer will start automatically.

Factory default: Off

Tumble dryer supervisor level

Machine parameters

Legal information

Open Source Licenses

Copyrights and licenses

You can view information here.

For the purpose of operating and controlling the machine, Miele uses proprietary or third-party software that is not covered by open source licensing conditions. This software/these software components are protected by copyright. The copyrights held by Miele and third parties must be respected.

Furthermore, this machine contains software components which are distributed under open source licensing conditions. You can access these open source components along with the corresponding copyright notices, copies of the licensing conditions valid at the time, and any further information. This information can be found under the menu option Settings/Machine parameters/Legal information/Open Source Licenses. The liability and warranty arrangements for the open source licenses displayed in this location only apply in relation to the respective rights holders.

Pairing instructions

Follow the steps below to connect the washing machine to your network.

Network connection

Miele Professional washing machines can be integrated into local networks to utilize Miele's digital solutions or communicate with external systems. The washing machines are equipped with an integrated Wi-Fi module for this purpose. In addition, the washing machines each have an Ethernet connection at the rear for setting up wired interfaces.

⚠ Unauthorized access poses a health risk.
 Settings in the washing machine, e.g., parameters for disinfection or dispensing process chemicals, may be changed as a result of unauthorized access via the network.
 Under no circumstances should it be possible to access the washing machine via the Internet or other public or unsecured networks, either directly or indirectly (e.g., using port forwarding).

1. The washing machine should be operated only in a separate network segment which meets one of the following requirements:
 - It is physically separated from other network segments.
 - Access to the segment is restricted by a firewall or a router which has been configured accordingly.
2. Limit access to this separate network segment to persons requiring access in the course of their work.
3. Use strong passwords to protect access to systems that are connected to the washing machine.
4. Configure the Ethernet interface.

Opening the supervisor level

- Select the Supervisor menu option in the machine display.
- Select the Access via code menu option.
- Enter the 4-digit supervisor code.

Initial network setup

- Select the Supervisor level menu option from the External applications menu.
- Select WiFi / LAN.

The options in the WiFi / LAN menu vary depending on whether the Wi-Fi interface is already set up or needs to be set up.

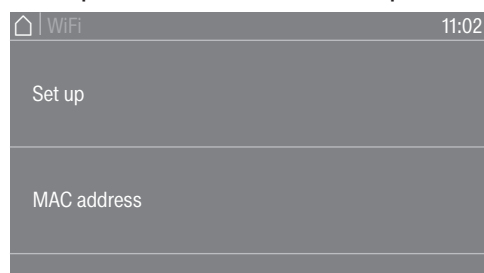

- Select Set up to connect the machine to a network.

The message Set up only appears if the washing machine has not yet been connected to a Wi-Fi network. Various options are available for setting up the Wi-Fi interface.

Networking

- Select MAC address to read out the MAC addresses of the network adapters.

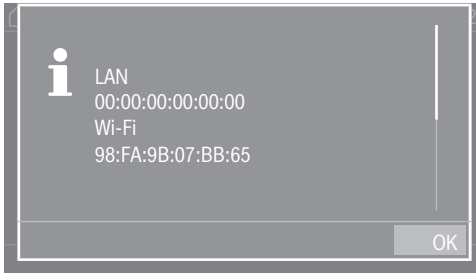

The MAC address of the network adapters is displayed. No settings can be made.

Setting up a network connection manually

- Select the Supervisor level menu option from the External applications menu.
- Then select the WiFi / LAN menu option.
- Select Set up.
- Select the Manual connection method.

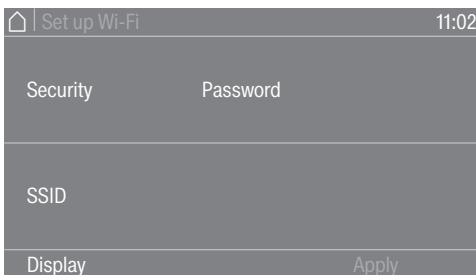
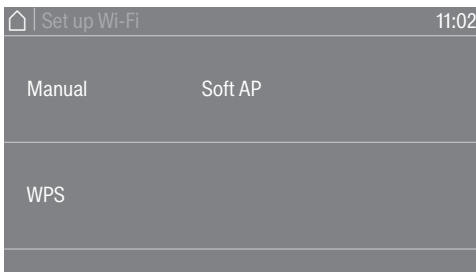

- Select Security to set the security standard for the wireless connection.
- Select Password to enter the Wi-Fi password.
- Select SSID to enter the network name (SSID).

You can view all settings for Security, Password, and SSID under Display.

- Save all settings with Apply.

Establishing the network connection via WPS

- Select the Supervisor level menu option from the External applications menu.
- Then select the WiFi / LAN menu option.
- Select Set up.
- Select the Via WPS connection method.
- Now press the WPS button on your router and confirm with OK in the machine display.

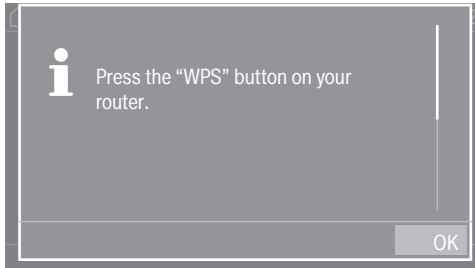

A timer starts. The network connection via WPS is being established.

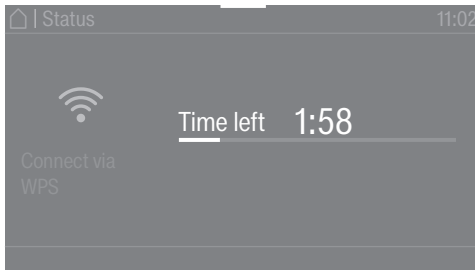

The machine is now successfully connected.

- Tap OK to confirm.

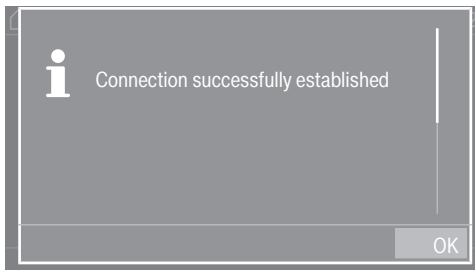

Networking

Establishing the network connection via soft AP

- Select the Supervisor level menu option from the External applications menu.
- Then select the WiFi / LAN menu option.
- Select Set up.
- Select the Via Soft AP connection method.
- Confirm by pressing OK and follow the instructions in the external application.

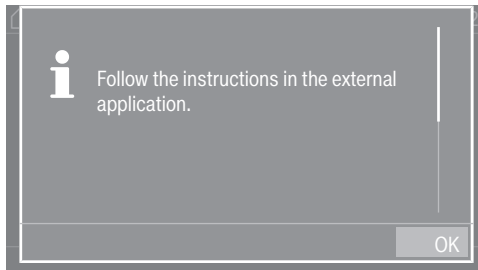

The display shows the message *Waiting for connection* for approx. 10 minutes. If the connection is successful, a message is then displayed. If the connection has failed, the message *Connection failed* is displayed.

- If the connection fails, confirm with OK and start a new connection attempt.

Establishing the network connection using a LAN cable

- Connect the machine to your router/switch using the network cable.

The machine is now successfully connected.

Wi-Fi/LAN interface configured

Once the network connection has been successfully set up, you can select additional options in the menu.

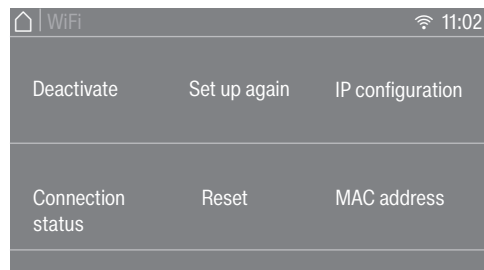

- The Wi-Fi function is switched off with **Deactivate** (visible when the network is activated). The network remains set up.
- The Wi-Fi function is reactivated with **Activate** (visible when the network is deactivated).
- All network parameters are displayed under **Connection status**.
- You can set up the Wi-Fi interface again under **Set up again**.
- Use **Reset** to disconnect the network setup. The Wi-Fi function is deactivated and the Wi-Fi connection will be reset to the factory default. A new connection has to be established in order to use the network again.
- You can configure the IP settings manually under **IP configuration**. The interface can be set up via a Dynamic Host Configuration Protocol (DHCP). If you deactivate the DHCP setting, you can configure the interface using the following parameters:
 - IP address
 - Subnet mask
 - Gateway
 - DNS Auto
 - DNS server 1
 - DNS server 2
- The address of the network adapters is displayed under **MAC address**.

Technical data

System requirements for WiFi

- WiFi 802.11b/g/n
- 2.4 GHz band
- WPA/WPA2 encryption
- DHCP activated
- MulticastDNS/Bonjour/IGMP snooping activated
- Ports 443, 80, 53, and 5353 open
- IP DNS server = IP standard gateway/router
- Mesh/repeater use: same SSID and password as standard gateway/router
- SSID must be permanently visible

System requirements for LAN



- DHCP activated
- MulticastDNS/Bonjour/IGMP snooping activated
- Ports 443, 80, 53, and 5353 open
- IP DNS server = IP standard gateway/router

Networking

Wi-Fi signal strength – guide values

The Wi-Fi signal strength is only a rough guide. These details do not provide absolute certainty.

The Wi-Fi signal strength can be read directly on the machine.

Wi-Fi signal strength		Meaning
	 *	
76–100%	3/3**	Generally, reliable operation possible
51–75%	2/3	
26–50%	1/3	Generally, operation possible
1–25%	0/3	Generally, reliable operation not possible
0%		Operation not possible

* Displayed on the machine

** Number of bars  3/3–0/3

The signal strength can be adversely affected by many factors, including:

- people in the room
- open or closed doors
- moved objects
- varying radio signal sources or interference
- other machines with Bluetooth or Wi-Fi wireless technology

PDW 909 machine data

Electrical connection

Connection voltage	See data plate
Frequency	See data plate
Power rating	See data plate
Current	See data plate
Fuse rating	See data plate
Heater rating	See data plate

Installation dimensions

Casing width (without add-on components)	27 1/4" (692 mm)
Casing height (without add-on components)	76 3/8" (1940 mm)
Casing depth (without add-on components)	29 15/16" (761 mm)
Overall machine width	27 1/4" (692 mm)
Overall machine height	76 7/16" (1942 mm)
Overall machine depth	76 7/16" (851 mm)
Minimum width of transport opening	50 7/8" (1292 mm)
Minimum safety distance between wall and rear of machine	15 3/4" (400 mm)
Door opening diameter	14 9/16" (370 mm)
Door opening angle	180°

Weight and floor load

Net weight	see installation plan
Maximum floor load during operation	see installation plan

Water connection

Cold water connection

Required flow pressure	14.5-145 psi (100-1000 kPa/1-10 bar)
Maximum flow rate	10 l/min
Threaded union required (male thread, to be provided by customer on site in accordance with DIN 44991, flat sealing)	3/4"
Length of water inlet hose supplied	61" (1.55 m)

Warm water connection

Maximum permissible hot water temperature	158 °F (70 °C)
Required flow pressure	14.5-145 psi (100-1000 kPa/1-10 bar)
Maximum flow rate	10 l/min
Threaded union required (male thread, in accordance with DIN 44991, flat sealing)	3/4"
Length of water inlet hose supplied	61" (1.55 m)

Drainage (DP)

Maximum waste water temperature	203 °F (95 °C)
Waste water connection (on machine)	External diameter 22 (DN 22 / 22 mm / 7/8")
Maximum drainage rate	26 l/min

Supply air

Recommended free air intake cross-section into the room: (equivalent to 3 times the exhaust air cross-section of a machine).	237 cm ²
---	---------------------

There must be sufficient air intake to the installation site to match the air outlet volume.

Technical data

Exhaust air

Maximum nominal volume flow rate	320 m ³ /h
Maximum permitted pressure loss	0.03 psi (220 Pa)
Connector on machine side (external diameter)	4" (100 mm)
Connection pipe provided on site (internal diameter)	4" (100 mm)
Maximum exhaust air temperature	175°F (80°C)

As relative humidity inside the exhaust ducting can be as high as 100%, suitable measures must be taken to prevent a backflow of condensate into the machine.

Emission values

Emission sound pressure level in accordance with EN ISO 11204/11203	< 70 dB(A) re 20 µPa
Sound power level, EN ISO 9614-2	< 80 dB(A)

Product safety

Product safety standards	See data plate
--------------------------	----------------

WiFi

Frequency range of the WiFi module	2.400–2.4835 GHz
Maximum transmission power of the WiFi module	< 100 mW

Data protection and data security

When you activate the networking function and connect your machine to the Internet, your machine sends the following data to the Miele Cloud:

- machine serial number
- machine model and technical features
- machine status
- information about the software status of your machine

Initially, this data cannot be assigned to a specific user and is not saved permanently. Data cannot be saved permanently or assigned to a specific user until after you have linked your machine to a user. Data transmission and processing are governed by Miele's strict security standards.

Factory default settings for network configuration

You can reset all of the settings on the communication module or your integrated WiFi module to the factory default settings. The network configuration should be reset whenever a machine is being disposed of or sold, or if a used machine is being put into operation. This is the only way to ensure that all personal data has been removed and the previous owner will no longer be able to access the machine.

Copyrights and licenses

For the purpose of operating and controlling the communication module, Miele uses proprietary or third-party software that is not covered by open source licensing terms. This software/these software components are protected by copyright. The copyrights held by Miele and third parties must be respected.

This communication module contains software components which are distributed under open source licensing terms. The open source components contained in the machine along with the corresponding copyright notices, copies of the licensing terms valid at the time, and any additional information can be accessed locally by IP via a web browser (<https://<IP address>/Licenses>). The liability and warranty arrangements for the open source licenses displayed in this location only apply in relation to the respective rights holders.

ANY CHANGES OR MODIFICATIONS NOT EXPRESSLY APPROVED BY THE PARTY RESPONSIBLE FOR COMPLIANCE COULD VOID THE USER'S AUTHORITY TO OPERATE THE EQUIPMENT.

THIS DEVICE COMPLIES WITH PART 15 OF THE FCC RULES AND CONTAINS LICENSE-EXEMPT TRANSMITTER(S)/RECEIVER(S) THAT COMPLY WITH INNOVATION, SCIENCE AND ECONOMIC DEVELOPMENT CANADA'S LICENCE-EXEMPT RSS STANDARD(S). OPERATION IS SUBJECT TO THE FOLLOWING TWO CONDITIONS: (1) THIS DEVICE MAY NOT CAUSE HARMFUL INTERFERENCE, AND (2) THIS DEVICE MUST ACCEPT ANY INTERFERENCE RECEIVED, INCLUDING INTERFERENCE THAT MAY CAUSE UNDESIRED OPERATION.

Contains FCC ID: 2ACUWEK047

WiFi data protection

Contains IC: 5669C-EK047

RADIATION EXPOSURE STATEMENT: THIS EQUIPMENT COMPLIES WITH FCC AND WITH ISED RADIATION EXPOSURE LIMITS SET FORTH FOR AN UNCONTROLLED ENVIRONMENT. THIS EQUIPMENT SHOULD BE INSTALLED AND OPERATED WITH A MINIMUM DISTANCE OF 20CM BETWEEN THE RADIATOR AND YOUR BODY. THIS DEVICE AND ITS ANTENNA(S) MUST NOT BE CO-LOCATED OR OPERATION IN CONJUNCTION WITH ANY OTHER ANTENNA OR TRANSMITTER.

Please have the model and serial number
of your machine available when
contacting Technical Service.

U.S.A.

Miele, Inc.

National Headquarters

9 Independence Way
Princeton, NJ 08540
Phone: 800-991-9380
www.miele-professional.com
prosales@mieleusa.com

Technical Service & Support

Phone: 800-991-9380
proservice@mieleusa.com

Canada

Importer
Miele Limited

Professional Division

161 Four Valley Drive
Vaughan, ON L4K 4V8
Phone: 1-888-325-3957
www.miele-professional.ca
professional@miele.ca

Miele Professional Technical Service

Phone: 1-888-325-3957
serviceprofessional@miele.ca



Manufacturer: Miele & Cie. KG
Carl-Miele-Straße 29, 33332 Gütersloh, Germany