

## Operating and installation instructions Oven



It is **essential** to read the operating and installation instructions before setup, installation, and commissioning. This prevents both personal injury and damage to the appliance.

# Contents

---

<b>Warnings and safety notes</b> .....	<b>7</b>
<b>Sustainability and environmental protection</b> .....	<b>14</b>
Energy saving tips.....	15
<b>Familiarisation</b> .....	<b>17</b>
Your oven .....	17
Control panel.....	18
Switching on the oven.....	19
Operating mode selector .....	19
Display.....	19
Rotary selector < > .....	19
Sensor controls .....	19
Symbols .....	20
Features .....	21
Data plate.....	21
Scope of delivery .....	21
Optional accessories.....	21
Safety features.....	24
PerfectClean surfaces .....	24
Pyrolytic cleaning .....	24
Operation.....	25
Selecting an operating mode .....	25
Entering numbers .....	25
Selecting a menu option from a list .....	25
Changing a setting in a list .....	25
Changing the setting with a segment bar .....	25
<b>Commissioning</b> .....	<b>27</b>
Miele@home .....	27
Commissioning procedure.....	27
Heating up the oven for the first time .....	28
<b>Adjusting settings</b> .....	<b>29</b>
Settings overview.....	29
Opening the “Settings” menu .....	30
Language  .....	30
Time.....	30
Display .....	30
Volume .....	31
Units .....	31
Recommended temps. ....	31
Pyrolytic reminder .....	31
Cooling fan run-on.....	31
Operating hours.....	32

Miele@home .....	32
Performing Scan & Connect .....	33
Remote control .....	33
RemoteUpdate .....	33
Software version.....	34
Showroom programme.....	34
Factory default .....	34
<b>Operating modes .....</b>	<b>35</b>
<b>Operation .....</b>	<b>36</b>
Easy to use .....	36
Pre-heating the oven.....	36
Changing the temperature .....	37
Cooking durations .....	37
Set cooking duration .....	37
Setting the finish time (Finish at) .....	37
Setting the start time (Start at) .....	37
Changing the set cooking durations .....	38
Deleting the set cooking durations .....	38
Cancelling a cooking process .....	38
Using the AirFry  operating mode.....	38
Using automatic programmes .....	38
Min. minder .....	38
Using the Min. minder function .....	38
Using accessories .....	39
Using the rack .....	39
Using bakeware.....	40
Using baking trays .....	40
Using the rack with the universal tray.....	40
Using the grilling and roasting insert with the universal tray .....	40
Using the Gourmet baking and pizza stone .....	40
Using the Gourmet oven dish.....	40
Fitting and removing HFC 70-C FlexiClip runners.....	41
<b>Good to know.....</b>	<b>44</b>
Baking.....	44
Tips on baking .....	44
Notes on the cooking charts.....	44
Notes on the functions .....	44
Roasting.....	45
Tips for roasting .....	45
Notes on the cooking charts.....	46
Notes on the functions .....	46

# Contents

---

Grilling.....	47
Tips for grilling.....	47
Notes on the cooking charts.....	48
Notes on the functions.....	48
Defrost.....	49
Low temperature cooking.....	49
Drying.....	50
Heat crockery.....	51
Frozen food/Ready meals.....	51
AirFry.....	52
Accessories.....	52
AirFrying tips.....	52
AirFry recipes.....	53
Falafel with yoghurt dip.....	54
French fries and sweet potato fries.....	55
Sesame tofu sticks.....	56
Baked potatoes with cheese and spring onions.....	57
Baked potatoes with feta, tzatziki and Greek salad.....	58
Courgette fries with blue cheese dip and chilli sauce.....	60
Corn grilled with hoisin glaze and coleslaw.....	61
Chicken nuggets with coconut sesame coating.....	62
Cod with crust.....	63
Bananas with pistachio and honey topping.....	64
Pasteis de nata.....	65
Vegan pasteis de nata.....	66
Automatic programmes.....	67
Usage notes.....	67

Recipes for automatic programmes .....	67
Apple sponge.....	68
Sponge base.....	69
Layered sponge cake fillings.....	70
Marble cake .....	72
Fruit streusel cake.....	73
Biscuits.....	74
Drop cookies .....	75
Walnut muffins.....	76
Pizza (yeast dough).....	77
Pizza (quark dough) .....	79
Chicken.....	80
Fillet of beef (roast) .....	81
Trout.....	82
Salmon fillet.....	83
Salmon trout.....	84
Potato and cheese gratin.....	85
Lasagne .....	86
Cooking charts.....	87
Creamed mixture .....	87
Shortcrust pastry.....	88
Yeast dough .....	89
Quark dough .....	90
Sponge mixture .....	90
Choux pastry, puff pastry, meringue .....	91
Savoury dishes .....	92
Beef.....	93
Veal .....	94
Lamb, game .....	95
Poultry, fish .....	96
<b>Cleaning and care .....</b>	<b>97</b>
Unsuitable cleaning agents.....	97
Removing or taking out accessories.....	98
Cleaning the front.....	98
Oven compartment.....	98
Cleaning the oven compartment manually.....	98
Cleaning the oven compartment by means of Pyrolytic.....	98
Side runners .....	101
Removing and installing side runners .....	101
Cleaning the side runners.....	101
FlexiClip runners.....	102
Cleaning the FlexiClip runners .....	102

# Contents

---

Baking and roasting rack .....	102
Cleaning the rack .....	103
Baking trays and bakeware .....	103
Cleaning baking trays and bakeware with PerfectClean surfaces.....	103
Gourmet baking and pizza stone.....	104
Cleaning the Gourmet baking and pizza stone and wooden paddle.....	104
Gourmet oven dish with lid.....	104
Cleaning the Gourmet oven dish.....	105
Door.....	105
Removing the door .....	105
Dismantling the door.....	106
Fitting the door.....	109
<b>Troubleshooting.....</b>	<b>111</b>
Messages in the display .....	111
Unexpected behaviour.....	112
Unsatisfactory results.....	114
Unusual noises .....	114
<b>Customer Service Department.....</b>	<b>115</b>
Contact in case of malfunction .....	115
Warranty .....	115
<b>Installation.....</b>	<b>116</b>
Installation dimensions .....	116
Installation in a tall or base unit.....	116
Side view H 24xx.....	117
Side view H 28xx, H 27xx.....	118
Connections and ventilation .....	119
Installing the oven .....	120
Electrical connection .....	121
<b>Technical data.....</b>	<b>122</b>
Copyrights and licences for the communication module.....	122

This oven complies with all current local and national safety requirements. However, inappropriate use can lead to personal injury and damage to property.

Read the operating and installation instructions carefully before using the oven. They contain important information on safety, installation, use and maintenance. This prevents both personal injury and damage to the oven.

In accordance with standard IEC/EN 60335-1, Miele expressly and strongly advises that you read and follow the instructions in the chapter on installing the oven as well as the safety instructions and warnings.

Miele cannot be held liable for damage caused by non-compliance with these instructions.

Keep these instructions in a safe place and pass them on to any future owner.

### Appropriate use

▶ This oven is intended for use in the home and in similar environments, for example

- in shops, offices and similar work settings
- by the guests in hotels
- in motels, bed & breakfasts and other typical home settings.

This appliance is not intended for outdoor use.

▶ The oven is not intended for outdoor use.

▶ The oven is intended for domestic use only to bake, roast, grill, cook, defrost and dry food.

All other types of use are not permitted.

▶ This oven may only be used by people with reduced physical, sensory or mental capabilities or lack of experience and knowledge if they are supervised whilst using it.

They may only use it unsupervised if they have been shown how to use it in a safe manner. They must be able to recognise and understand the dangers of misuse.

▶ The oven compartment is equipped with special lamps to cope with particular conditions (e.g. temperature, moisture, chemical resistance, abrasion resistance and vibration). These special lamps must only be used for the purpose for which they are intended. They are not suitable for room lighting.

## Warnings and safety notes

---

▶ The oven contains 1 light source corresponding to energy efficiency class G.

### Safety with children

▶ Activate the system lock to ensure that children cannot switch the oven on by mistake.

▶ Children under 8 years of age must be kept away from the oven unless they are constantly supervised.

▶ Children aged 8 and older may only use the oven without supervision if they have been shown how to use it in a safe manner. Children must be able to understand and recognise the possible dangers caused by incorrect operation.

▶ Children must not be allowed to clean or maintain the oven unsupervised.

▶ Children should be supervised in the vicinity of the oven. Never allow children to play with the oven.

▶ Risk of suffocation due to packaging material. Whilst playing, children may become entangled in packaging material (such as plastic wrapping) or pull it over their head, presenting the risk of suffocation.

Keep packaging material away from children.

▶ Risk of injury caused by hot surfaces. Children's skin is far more sensitive to high temperatures than that of adults. External parts of the oven such as the door glass, control panel and the vent become quite hot.

Do not let children touch the oven when it is in operation.

▶ Danger of injury caused by hot surfaces. Children's skin is far more sensitive to high temperatures than that of adults. The oven gets much hotter during pyrolytic cleaning than during normal use.

Do not let children touch the oven during pyrolytic cleaning.

▶ Risk of injury from the open door.

The oven door can support a maximum weight of 15 kg. Children could injure themselves on an open door.

Do not let children sit on the open door, lean against it or swing on it.

### Technical safety

▶ Unauthorised installation, maintenance and repairs can cause considerable danger for the user. Installation, maintenance and repairs must only be carried out by a Miele authorised technician.

## Warnings and safety notes

---

▶ Damage to the oven can compromise your safety. Check the oven for visible signs of damage. Do not use a damaged oven.

▶ Temporary or permanent operation on an autonomous power supply system or a power supply system that is not synchronised with the mains power supply (e.g. island networks, back-up systems) is possible. A prerequisite for operation is that the power supply system complies with the specifications of EN 50160 or an equivalent standard.

The function and operation of the protective measures provided in the domestic electrical installation and in this Miele product must also be maintained in isolated operation or in operation that is not synchronised with the mains power supply, or these measures must be replaced by equivalent measures in the installation. As described, for example, in the current version of BS OHSAS 18001–2 ISO 45001.

▶ The electrical safety of this oven can only be guaranteed when correctly earthed. It is most important that this basic safety requirement is fulfilled. If in doubt, the electrical installation should be checked by a qualified electrician.

▶ The connection data (voltage and frequency) on the data plate of the oven must match the mains electricity supply in order to avoid the risk of damage to the oven. Compare this before connecting the appliance to the mains. If in any doubt, consult a qualified electrician.

▶ Multi-socket adapters and extension leads do not guarantee the required safety of the appliance. Do not use these to connect the oven to the mains electricity supply.

▶ For safety reasons, the oven may only be used when it has been built in and fully installed.

▶ The oven must not be used in a non-stationary location (e.g. on a ship).

▶ Risk of injury due to electric shock. Any contact with live connections or tampering with the electrical or mechanical components of the oven will endanger your safety and may lead to the oven malfunctioning.

Do not open the oven housing under any circumstances.

▶ While the oven is under warranty, repairs should only be undertaken by a Miele authorised technician. Otherwise the warranty will be invalidated.

## Warnings and safety notes

---





- ▶ Miele can only guarantee the safety of the oven when original Miele spare parts are used. Faulty components must only be replaced by original spare parts.
- ▶ If an oven is delivered without a mains supply cord, a special cord must be installed by a Miele authorised technician.
- ▶ If the supply cord is damaged, it must be replaced with a special supply cord by a Miele authorised technician.
- ▶ During installation, maintenance and repair work, e.g. if the oven interior lighting is faulty, the oven must be completely disconnected from the household electricity supply. To ensure this, do one of the following:
  - Disconnect the mains fuse
  - Completely unscrew the screw-out fuse (in countries where this is applicable)
  - Pull out the plug (if one is present) at the wall socket. To do this, pull the plug and not the mains supply cord.
- ▶ The oven requires a sufficient supply of cool air for efficient operation. Make sure that the supply of cool air is not hindered in any way (e.g. by fitting heat insulation strips in the housing unit). Furthermore, the required supply of cool air must not be excessively heated by other heat sources (e.g. solid fuel stoves).
- ▶ If the oven is built in behind a furniture front (e.g. a door), do not close the furniture door while the oven is in use. Heat and moisture can build up behind the closed furniture door. This can result in damage to the oven, housing unit and floor. Leave the furniture front/door open until the oven has cooled down completely.

### Correct use

- ▶ Risk of injury caused by hot surfaces. The oven gets hot during operation. You could burn yourself on the heating elements, oven compartment, accessories or food. Wear oven gloves when placing hot food in the oven or removing it and when adjusting oven shelves, for example, in a hot oven compartment.
- ▶ To avoid fuelling any flames, do not open the oven door if smoke occurs inside the appliance. Interrupt the process by switching the appliance off and disconnect it from the mains electricity supply. Do not open the door until the smoke has dispersed.

## Warnings and safety notes

---

- ▶ Due to the high temperatures radiated, objects left near the oven could catch fire. Do not use the oven to heat up the room.
- ▶ Oils and fats can ignite if allowed to overheat. Never leave the oven unattended when cooking with oil or fats. Never attempt to put out oil or fat fires with water. Switch the oven off and extinguish the flames by leaving the door closed.
- ▶ Grilling food for excessively long cooking durations can cause it to dry out with the risk of catching fire. Do not exceed the recommended cooking durations.
- ▶ Certain foods dry out quickly and may catch fire due to high grill temperatures.  
Never use grill modes to finish baking partially baked rolls or bread or to dry flowers or herbs. Instead, use the Fan plus  or Conventional heat  function.
- ▶ When using residual heat to keep food warm, corrosion from high air humidity and condensation can occur in the oven. This can also cause damage to the control panel, worktop and surrounding kitchen furniture. Keep the oven on and select the lowest temperature available for the selected function. The cooling fan will then continue to run automatically.
- ▶ Food which is stored in the oven compartment or left in it to be kept warm can dry out and the moisture released can lead to corrosion damage in the oven. Always cover food that is left in the oven to keep warm.
- ▶ An accumulation of heat can cause the floor of the oven to crack or flake off.  
Never line the floor of the oven compartment with aluminium foil or oven liners.  
If you wish to place crockery on the oven floor during cooking, or place crockery on the oven floor to heat it up, you can do so, but only with the Fan plus  or Eco Fan heat  function.
- ▶ The oven compartment floor can become damaged by items being pushed around on it. When placing pots, pans or crockery on the oven compartment floor, ensure that you avoid pushing them around.
- ▶ Risk of injury caused by steam. Pouring a cold liquid onto a hot surface creates steam, which can cause severe scalding. The sudden temperature change can also cause damage to hot enamelled surfaces. Never pour cold liquids directly onto hot enamelled surfaces.

## Warnings and safety notes

---

- ▶ It is important that the temperature in the food being cooked is evenly distributed and sufficiently high. This can be achieved by stirring or turning the food.
- ▶ Plastic dishes that are not suitable for use in an oven will melt and may ignite at high temperatures, and can damage the oven. Use only plastic containers that are suitable for use in an oven. Follow the manufacturer's instructions.
- ▶ Heating up food in closed containers, such as tins or sealed jars, will result in an increase in pressure, which can cause them to explode. Do not heat up unopened tins or jars of food in the oven.
- ▶ Risk of injury from the open door. You could bang into the open door or trip over it. Avoid leaving the door open unnecessarily.
- ▶ The door can support a maximum load of 15 kg. Do not lean or sit on an open door, or place heavy items on it. Make sure that nothing gets trapped between the door and the oven compartment. This could damage the oven.

### **The following applies to stainless steel surfaces:**

- ▶ Adhesives will damage the stainless steel surface and cause it to lose its dirt-repellent protective coating. Do not use sticky notes, adhesive tape or other types of adhesive on the stainless steel surface.
- ▶ Magnets can cause scratches. Do not use the stainless steel surface as a magnetic notice board.

### **Cleaning and care**

- ▶ Risk of injury due to electric shock. The steam from a steam cleaning appliance could reach live electrical components and cause a short circuit. Do not use a steam cleaner to clean the appliance.
  - ▶ Coarse soiling in the oven compartment can cause thick smoke to develop. Coarse soiling should be removed from the oven compartment before running the pyrolytic cleaning programme.
  - ▶ Risk of injury caused by hazardous steam. During pyrolytic cleaning, steam, which can irritate mucous membranes, can be released.
- During pyrolytic cleaning, do not stay in the kitchen for longer periods of time and do not let children and pets enter the kitchen. It is important to ensure that the kitchen is well ventilated during pyrolytic cleaning. Prevent the odour from escaping into other rooms.

- ▶ The side runners can be removed. Refit the side runners correctly.
- ▶ Scratches on the door glass can cause the glass to break. Do not use abrasive cleaners, hard sponges, brushes or sharp metal tools to clean the door glass.
- ▶ In warm, moist environments, there is a higher probability of pest infestations (such as cockroaches). Ensure the oven and the area surrounding it are always kept clean.  
Damage caused by pests is not covered by the warranty.

### Accessories

- ▶ Only use original Miele accessories. If other parts are used, warranty, performance and product liability claims will be invalidated.
- ▶ Miele will guarantee to supply functional spare parts for a minimum of 10 years and up to 15 years following the discontinuation of your oven.
- ▶ The Miele gourmet oven dish HUB 5000/HUB 5001 (if available) must not be inserted into shelf level 1. This will damage the floor of the oven. The lack of clearance will create an accumulation of heat which can cause the enamel to crack or flake off. Never place a Miele oven dish on the upper support of shelf level 1 either as it will not be secured by the non-tip safety notches. As a general rule, use shelf level 2.
- ▶ Remove all accessories as well as the runners and any extra accessories such as FlexiClip runners from the oven interior before starting the Pyrolytic cleaning programme.  
The high temperatures needed for pyrolysis will damage them.

# Sustainability and environmental protection

---

## Disposing of the packaging material

The packaging material is used for handling and protects the appliance from transport damage. The packaging material used is selected from materials which are environmentally friendly for disposal and can generally be recycled.

Recycling the packaging material reduces the use of raw materials. Your Miele dealer will take the packaging material away.

## Disposal of your old appliance

Electrical and electronic appliances often contain valuable materials. They also contain materials which, if handled or disposed of incorrectly, could be potentially hazardous to human health and to the environment. They are, however, essential for the correct functioning of your appliance. Please do not therefore dispose of it with your household waste.

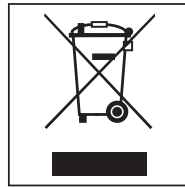

Please contact your Miele dealer. They will provide support for its disposal.





Ensure that it presents no danger to children while being stored for disposal.

# Sustainability and environmental protection

---

## Energy saving tips

### Cooking programmes

- Remove all accessories from the oven compartment that are not required for cooking.
- In general, if a range of temperatures is given in a recipe or chart, it is best to select the lower temperature and to check the food after the shortest duration.
- Preheat the oven compartment only if instructed to do so in the recipe or the cooking chart.
- If possible, do not open the door during a programme.
- Use dark, matt bakeware and cooking containers made of non-reflective materials (enamelled steel, heat-resistant glass, coated aluminium). Shiny materials such as stainless steel or aluminium reflect the heat and therefore can give a more uneven food heating result. Do not cover the oven floor or the rack with heat-reflecting aluminium foil.
- Monitor cooking durations to avoid wasting energy when cooking. Set the cooking duration, or use a food probe if you have one.
- The Fan plus  function can be used for cooking many types of food. Because the fan distributes the heat in the oven compartment straight away, it allows you to use a lower temperature than you would with Conventional heat . It also enables you to cook on multiple shelf levels at the same time.
- Eco Fan heat  is an innovative function which is suitable for smaller foodstuffs, e.g. frozen pizzas, part-baked rolls, biscuits and for meat dishes and roasts. Energy-efficient cooking thanks to optimal utilisation of heat. When cooking on a single shelf, up to 30 % less energy is used with comparatively good cooking results. Do not open the door during the cooking programme.
- Fan grill  is the best function for grilled dishes. With this function you can use lower temperatures than in other grill functions which use the maximum temperature setting.
- Whenever possible you should cook multiple foods at the same time. Place them next to each other in the oven or on different shelf levels.
- Foods which you are unable to cook at the same time should, if possible, be cooked one after the other in order to make use of existing heat in the oven.

# Sustainability and environmental protection

---

## Residual heat utilisation

- In cooking processes using temperatures greater than 140 °C and with cooking durations longer than 30 minutes, the temperature can be turned down to the lowest possible level about 5 minutes before the end of the cooking process. The residual heat in the oven is sufficient for cooking the food until it is done. Do not switch the oven off completely.
- It is best to start the pyrolytic cleaning programme immediately after a cooking programme. The residual heat in the oven will help reduce the amount of energy required.

## Adjusting settings

- Select the Time | Display | Off setting for the display to reduce energy consumption.

## Energy-saving mode

The oven will switch itself off automatically to save energy if a cooking process is not in progress and no controls have been operated.

## Your oven

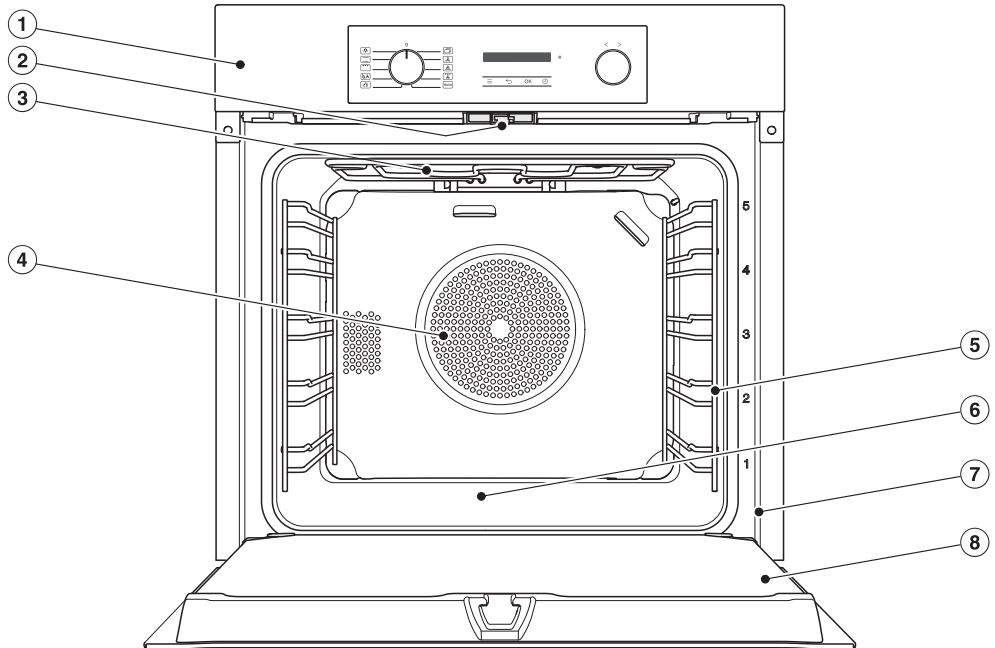

- ① Control elements
- ② Door lock for pyrolytic cleaning
- ③ Top heat/grill element
- ④ Air inlet for the fan with ring heating element behind it
- ⑤ Side runners with 5 shelf levels
- ⑥ Oven floor with bottom heat element underneath it
- ⑦ Front frame with data plate
- ⑧ Door

# Familiarisation

## Control panel

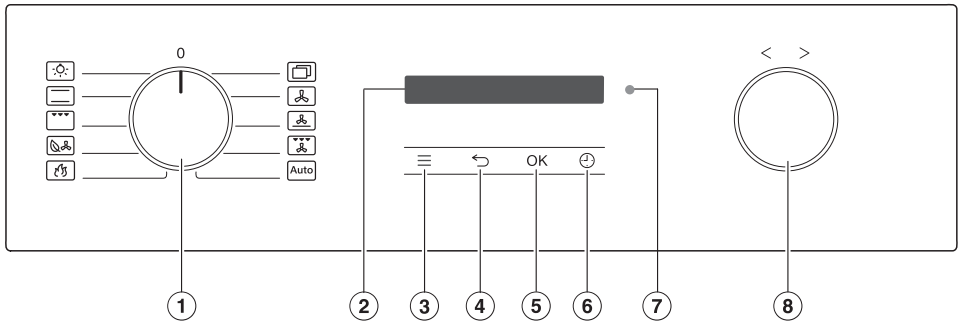

- ① **Function selector**  
For selecting oven functions
- ② **Display**  
For displaying the time of day and information on operation
- ③ **≡ sensor control**  
For accessing settings
- ④ **↶ sensor control**  
To go back a step
- ⑤ **OK sensor control**  
For selecting functions and saving settings
- ⑥ **↷ sensor control**  
For setting a minute minder, the cooking duration or the start or end time for the cooking programme
- ⑦ **Optical interface**  
(For your Miele dealer only)
- ⑧ **Rotary selector < >**  
For setting times, temperatures and for selecting menu options

## Switching on the oven

The time of day display is factory-set as deactivated to save energy. The display is dark and the sensor controls do not respond.

To change the settings or set a timer, you must switch on the oven:

- Turn the operating mode selector clockwise once and back again.

The sensor controls respond to the touch of a finger.

If you do not use the oven for a long period of time, it will switch itself off automatically and the sensor controls will no longer respond.

## Operating mode selector

Use the operating mode selector to select the required operating mode and switch on the oven interior lighting independently.

It can be turned clockwise or anti-clockwise.

## Operating modes

-  Lighting
-  Conventional heat
-  Full grill
-  Eco Fan heat
-  Pyrolytic
-  Further | Booster 
-  Further | AirFry 
-  Fan plus
-  Intensive bake
-  Fan grill
-  Automatic programmes

## Display

The display is used for showing the time of day or information about operating modes, temperatures, cooking durations, automatic programmes and settings.

## Rotary selector < >

The rotary selector can be turned clockwise or anti-clockwise.

You can increase values such as temperatures and times in the display by turning the rotary selector clockwise > or you can decrease the values by turning it anti-clockwise <.

In addition, you can use the rotary selector to scroll through the setting and automatic programme lists in the display.



Turn the rotary selector clockwise > to scroll down in the list and turn it anti-clockwise < to scroll up.





## Sensor controls

The sensor controls react to touch. Every touch of a sensor control is confirmed with an audible keypad tone. You can turn this keypad tone off using the  | Volume | Keypad tone sensor control.

# Familiarisation







## Sensor controls under the display

**Tip:** If the display is dark and the  and  sensor controls do not respond, turn the operating mode selector clockwise once and back again.

Sensor control	Function
	Use this sensor control to access the settings when the operating mode selector is in the <b>O</b> or the Lighting  position.
	Depending on which menu you are in, this sensor control will take you back a level or back to the main menu.
<i>OK</i>	By selecting this sensor control you can access functions such as the minute minder, save changes to values or settings or confirm instructions.
	If no cooking programme is in progress, you can use this sensor control to set a minute minder (e.g. when boiling eggs) at any point.  If a cooking programme is in progress at the same time, you can set a minute minder, the cooking duration and a start or end time for the programme.

## Symbols

The following symbols may appear in the display:

Symbol	Meaning
	This symbol indicates that there is additional information and advice about using the appliance. Press the <i>OK</i> sensor control to confirm the information.
	Minute minder
	A tick indicates the option which is currently selected.
	Some settings, e.g. display brightness and buzzer volume are selected using a bar chart.
	The system lock prevents the oven being switched on by mistake.
	Remote control (only appears if you are in the Miele@home system and have selected the Remote control   On setting)

## Features

The models described in this document can be found at the back.

Features will vary depending on model.

Your oven is supplied with the accessories listed under “Scope of delivery”.

Depending on the model, your oven may also come supplied with some of the accessories listed here.

## Data plate

The data plate is located on the front frame, visible when the door is open. The data plate states the model identifier, the serial number as well as connection data (mains voltage, frequency and maximum rated load).

Please have this information to hand, should you need to contact Miele regarding any questions or problems.

## Scope of delivery

- Side runners
- Universal tray
- Baking and roasting rack (rack for short)
- Operating and installation instructions
- Screws for fastening
- Further accessories (depending on the model)

## Optional accessories

Products specially tailored to your oven – such as appliance care products and accessories – are available from the Miele online shop, from Miele Customer Service or from your Miele dealer.

You can access the Miele online shop via the following QR code:



## Side runners

There are side runners on the left and right of the oven compartment with shelves  for inserting accessories.

The numbers for the shelf levels are marked on the front frame.

Each level consists of 2 rails, one above the other. The accessories (e.g. the rack) are pushed into the oven between the two rails.

You can remove the side runners.

## HFC 70-C FlexiClip runners

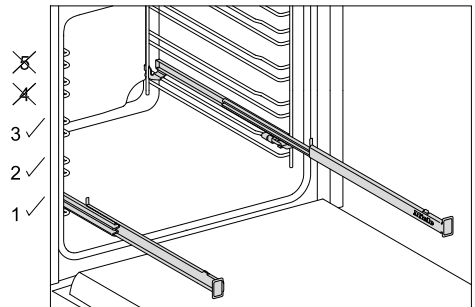

You can only use the FlexiClip runners on shelf levels 1, 2 and 3.

One level of the side runners consists of two rails. The FlexiClip runners are fitted on the upper rail of the two rails that make up a shelf level.

The FlexiClip runners can support a maximum load of 15 kg.

# Familiarisation

---

## Baking tray, universal tray and rack with non-tip safety notches

Baking tray HBB 71

(non-tip safety notches in the centre):

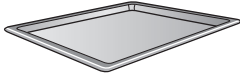

Universal tray HUBB 71

(non-tip safety notches in the centre):



Baking and roasting rack HBBR 71

(non-tip safety notches in the centre):



The non-tip safety notches on the short edges of these accessories prevent the side runners from being pulled right out when they only need to be pulled partially out.

## Gourmet baking and AirFry tray, perforated HBBL 71

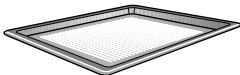

The fine perforations of the Gourmet baking and AirFry tray optimise cooking processes:

- Browning on the underside of baked goods made from fresh yeast and quark doughs as well as bread and rolls is improved.  
Roll out the dough on a level surface first and then place it on the Gourmet baking and AirFry tray.
- French fries, croquettes or similar items can be fried in a hot air flow without fat (AirFrying).

- During dehydrating/drying, the air circulation around the food for drying is optimised.

The enamelled surface has been treated with PerfectClean.

The **round baking and AirFry tin, perforated HBFP 27-1** can be used for the same purposes.

## Grilling and roasting insert HGBB 71

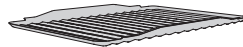

The grilling and roasting insert fits in the universal tray.

When grilling, roasting or AirFrying, the tray will collect meat juices and stop them from burning so that they can be used for making gravy and sauces.

The enamelled surface has been treated with PerfectClean.

## Round baking tins HBF 27-1 and HBFP 27-1



Enamelled round baking tins with PerfectClean finish for baking pizzas, quiches or tarts.

The perforated round baking tin is also suitable for AirFrying, as the hot air circulates optimally around the food.

## HBS 70 Gourmet baking and pizza stone



Gourmet baking and pizza stone made from heat-retaining fireclay for baking pizza, quiche, bread, rolls or savoury pastries with a well baked base.

A paddle made of untreated wood is supplied with the Gourmet baking and pizza stone for placing food on it and taking it off.

## **HUB gourmet oven dishes** **HBD gourmet oven dish lids**

Unlike other oven dishes, Miele gourmet oven dishes can be placed in the oven directly on the shelf runners. They have non-tip safety notches like the rack to prevent them from being pulled out too far.

The surface of the oven dish has a non-stick coating.

Gourmet oven dishes are available in different depths. The width and the height are the same.

Suitable lids are available separately. Please quote the model number when ordering.

### **Depth: 22 cm**

HUB 5000-M  
HUB 5001-M\*

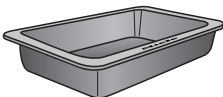

HBD 60-22

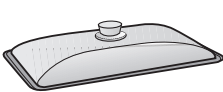

### **Depth: 35 cm**

HUB 5001-XL\*

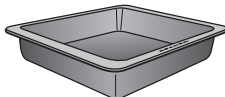

HBD 60-35

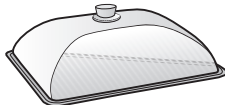

\* Suitable for use on induction hobs

## **Handle HEG**

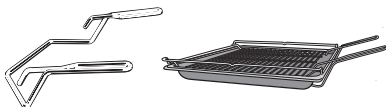

The handle makes it easier to take the universal tray, baking tray and rack out of the oven.

## **Accessories for cleaning and care**

- Miele all-purpose microfibre cloth
- Miele oven cleaner

# Familiarisation

---

## Safety features

### System lock

The system lock prevents the oven being switched on by mistake.

### Cooling fan

A cooling fan will come on automatically at the start of every cooking process. It ensures that the hot oven air is mixed with cool ambient air and thus cooled before it is expelled via the gap between the door and control panel.

The cooling fan will continue to run for a while after the oven has been switched off to prevent any humidity building up in the oven compartment, on the control panel or on the oven housing unit. The cooling fan will switch itself off automatically after a certain period of time.

### Safety switch-off

The safety switch-off is activated automatically if the oven has been operating for an unusually long period of time. The length of this period of time depends on the programme selected.

### Vented oven door

The oven door is made of glass panes that have a heat-reflective coating on part of their surface. When the oven is operating, air is passed through the door to keep the outer pane cool.

### Door lock for pyrolytic cleaning

At the beginning of a pyrolytic cleaning programme the door will lock for safety reasons. The door will only be unlocked when the temperature in the oven compartment has dropped to below 280 °C.

## PerfectClean surfaces

PerfectClean surfaces have very good non-stick properties and are exceptionally easy to clean. These surfaces are comparable to glass in terms of care.

Food can be easily removed from these surfaces. Soiling from baking and roasting processes can be easily removed from these surfaces.

Food can be sliced or cut up on PerfectClean surfaces.

However, do not use ceramic knives as these will scratch the PerfectClean surface.

PerfectClean surfaces:

- Universal tray
- Baking tray
- Gourmet baking and AirFry tray, perforated
- Grilling and roasting insert
- Round baking tray
- Round baking and AirFry tin, perforated

## Pyrolytic cleaning

Accessories will be damaged by the high temperatures in pyrolytic cleaning.

Remove all accessories from the oven before starting the pyrolytic cleaning programme. This also applies to the side runners, the FlexiClip runners, the rack and other optional accessories.

Instead of cleaning the oven compartment manually, you can run the Pyrolytic  function.

During pyrolytic cleaning the oven compartment reaches temperatures in excess of 400 °C. Any residual soiling is burnt off and turned to ash by the high temperatures.

There are 3 pyrolytic cleaning levels available, each with a different duration:

- Level 1 for light soiling
- Level 2 for heavier soiling
- Level 3 for very heavy soiling

The timer can be used to delay the start time of the pyrolytic cleaning programme, for instance to make use of cheaper electricity tariffs.

The oven door is automatically locked when the pyrolytic cleaning process is started. It cannot be opened until after the programme has finished.

At the end of the pyrolytic cleaning programme any residues such as ash from the pyrolytic process, which may be formed depending on the oven compartment's degree of soiling, can be easily wiped away.

## Operation

### Selecting an operating mode

- Turn the operating mode selector to the required operating mode.

The recommended temperature will appear in the display.

- Change the recommended temperature with the rotary selector < >, if necessary.
- Confirm with *OK*.

### Changing the operating mode

You can change to another operating mode during a cooking process.

- Turn the operating mode selector to the new operating mode.

Any cooking durations set will be deleted.

### Entering numbers

Numbers that can be changed are highlighted.

- Turn the rotary selector < > clockwise or anti-clockwise to change the number.
- Confirm with *OK*.

The changed number is now saved.

### Selecting a menu option from a list

- When  $\equiv$ ,  $\oplus$  and Auto are selected, the relevant menu appears. Using the rotary selector < >, scroll through the list until the menu option you want appears.
- Confirm with *OK*.

### Changing a setting in a list

A ✓ tick will appear beside the current setting.

- Turn the rotary selector < > clockwise or anti-clockwise until the required value or setting is shown.
- Confirm with *OK*.

The setting is now saved. This will take you back to the previous menu.

### Changing the setting with a segment bar

Some settings are represented by a bar  with seven segments. If all of the segments are illuminated, the maximum value is selected.

## Familiarisation

---

If none of the segments are illuminated, or only one of them is, the minimum value is selected or the setting is switched off altogether (e.g. volume).

- Turn the rotary selector < > clockwise or anti-clockwise until the required setting is shown.
- Confirm your selection with *OK*.

The setting is now saved. This will take you back to the previous menu.

## Miele@home

Your oven is equipped with an integrated WiFi module.

In order to use it, you will need:

- A WiFi network
- The Miele app
- A Miele user account The user account can be created via the Miele app.

The Miele app will guide you as you connect your oven to your home WiFi network.

Once your oven is connected to your WiFi network, you can use the app, for example, to carry the following activities:

- Call up information on the operating status of your oven
- Retrieve information on oven cooking programmes that are in progress
- End cooking programmes that are in progress

Connecting your oven to your WiFi network will increase energy consumption, even when the oven is switched off.

Make sure that the signal of your WiFi network is sufficiently strong in the place where your oven is installed.

### Availability of the WiFi connection

The WiFi connection shares a frequency range with other appliances (including microwave ovens and remote control toys). This can give rise to sporadic or even complete connection failures. Therefore, the availability of featured functions cannot be guaranteed.

## Miele@home availability

The ability to use the Miele app depends on the availability of the Miele@home service in your country.

The Miele@home service is not available in every country.

For information about availability, please visit [www.miele.com](http://www.miele.com).

## Miele App

The Miele App is available to download free of charge from the Apple App Store® or from the Google Play Store™.



## Commissioning procedure

 Risk of injury caused by hot surfaces.

The oven gets hot during operation. For safety reasons, the oven may only be used when it has been fully installed.

The oven will switch on automatically when it is connected to the electricity supply. The display will show "Miele" followed by a prompt to set the language after a few seconds.

- Follow the steps on the display. Using the rotary control < >, scroll through the list until the menu option you want appears, then confirm with OK.

Set up finished will then appear.

# Commissioning

- Confirm with *OK*.

Language  will appear.

- Select the  sensor control.

The time of day appears. Initial commissioning is now complete.

## Heating up the oven for the first time

When the oven is heated up for the first time it may give off a slight smell. This can be eliminated by heating the oven for at least an hour.

It is important to ensure that the kitchen is well ventilated during this operation.  
Prevent the odour from escaping into other rooms.

- Remove any protective wrapping and stickers from the oven and accessories.
- Before heating the oven up, wipe the oven compartment with a damp cloth to remove any dust or bits of packaging that may have accumulated inside during storage and unpacking.
- Fit the FlexiClip runners (if present) to the side runners and insert all trays and the rack.
- Select  Further with the operating mode selector.

Booster  will appear.

- Confirm with *OK*.

The recommended temperature of 160 °C will appear.

The oven heating, oven interior lighting and cooling fan will switch on.

- Set the maximum temperature (250 °C).

- Heat the oven for at least an hour.
- After the heating-up phase, turn the operating mode selector to **0**.

## Cleaning the oven compartment after heating it up for the first time

 Risk of injury caused by hot surfaces.







The oven gets hot during operation. You could burn yourself on the heater elements, oven compartment or accessories.

Allow the heater elements, oven compartment and accessories to cool before manual cleaning.

- Take all accessories out of the oven compartment and clean it by hand.
- Clean the oven compartment with a clean sponge and a solution of hot water and washing-up liquid or a clean, damp microfibre cloth.
- Dry all surfaces with a soft cloth.

Leave the oven door open until the oven compartment is completely dry.

## Settings overview

Menu option	Available settings
Language 	...   deutsch   english   ... Location
Time	Display On   Off*   Night dimming Clock format 12 h   24 h* Set
Display	Brightness 
Volume	Buzzer tones Melodies*  Solo tone  Keypad tone 
Units	Temperature °C*   °F
Recommended temps.	
Pyrolytic reminder	On   Off*
Cooling fan run-on	Temperature controlled* Time controlled
Operating hours	
System lock 	On   Off*
Miele@home	Activate   Deactivate Connection status Set up again Reset Set up
Remote control	On*   Off
RemoteUpdate	On*   Off
Software version	
Showroom programme	Demo mode On   Off*
Factory default	Appliance settings Recommended temps.

\* Factory default setting

# Adjusting settings

---

## Opening the “Settings” menu

Use the ≡ sensor control to access the “Settings” menu can personalise your oven by adapting the factory default settings to suit your requirements.

If the display is dark, you must switch on the oven to change the settings:

- Turn the operating mode selector clockwise once and then back to position **O**.
- Select the ≡ sensor control.

A list of settings will appear in the display.



- Use the rotary control < > to select the required setting.

You can check settings or change them.

- Select the ≡ sensor control again to quit the menu.

## Language

You can set your language and location. After selecting and confirming your choice, the language you have selected will appear in the display.

**Tip:** If you have selected the wrong language by mistake, select the ≡ sensor control. Follow the  symbol to get back to the Language  sub-menu.

## Time

### Display

Select how you want the time of day to show in the display when the oven is switched off:

- On  
The time always appears in the display. Changing this setting increases energy consumption.
- Off  
To save energy, the display does not light up.
- Night dimming  
The time only shows on the display between 5:00 a.m. and 11:00 p.m. The display remains dark at all other times. Changing this setting increases energy consumption.

### Clock format

The time of day can be displayed in the 24 or 12-hour format (24 h or 12 h).

### Set

Set the hours and the minutes.

If there is a power cut, the current time of day will reappear once power has been restored. The time of day is saved for approx. 5 minutes.

## Display

### Brightness

The display brightness is represented by a bar with seven segments.

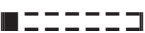
-   
Maximum brightness
-   
Minimum brightness

## Volume

### Buzzer tones

If buzzers are switched on, a buzzer will sound when the set temperature is reached and at the end of a set time.

### Melodies

At the end of a process, a melody will sound several times in intervals.

The volume of the melody is represented by a bar with seven segments.

- ■■■■■■■■

Maximum volume

- □□□□□□□

Melody is switched off

### Solo tone

At the end of a process, a continuous tone will sound for a period of time.

The pitch of this continuous tone is represented by a segment bar.

- ■■■■■■■■■■■■■■■■

Maximum pitch

- □□□□□□□□□□□□

Minimum pitch

### Keypad tone

The volume of the tone that sounds each time you touch a sensor control is represented by a bar with seven segments.

- ■■■■■■■■

Maximum volume

- □□□□□□□

Tone is switched off

## Units

### Temperature

You can set the temperature in degrees Celsius (°C) or degrees Fahrenheit (°F).

### Recommended temps.

If you often cook with different temperatures, it makes sense to change the recommended temperatures.

After selecting this menu option, the list of operating modes will appear in the display together with their recommended temperatures.

- Select the relevant operating mode.
- Change the recommended temperatures.
- Confirm with *OK*.

### Pyrolytic reminder

You can set whether you want a reminder to run the pyrolytic cleaning programme to come on (On) or not (Off).

### Cooling fan run-on

The cooling fan will continue to run for a while after the oven has been switched off to prevent any humidity building up in the oven compartment, on the fascia panel or on the oven housing unit.

- Temperature controlled  
The cooling fan switches off when the temperature in the oven drops below 70 °C.
- Time controlled  
The cooling fan switches off after a period of about 25 minutes.

# Adjusting settings

Condensate can damage the oven housing unit and the worktop and lead to corrosion in the oven. If you have set the cooling fan to Time controlled and leave food in the oven compartment to keep warm, moisture levels in the oven will increase, leading to condensation forming on the fascia panel and surrounding kitchen furniture, and drops of moisture collecting under the worktop.

Do not leave food in the oven compartment to keep it warm if you have selected Time controlled.

## Operating hours

Select Operating hours to query the total number of operating hours of your oven.

## System lock

The system lock prevents the oven being switched on by mistake.

The minute minder can still be used when the system lock is active.

The system lock will remain activated even after a power failure outage.

- On  
The system lock has been activated. Before you can use the oven, touch the OK sensor control for at least 6 seconds.
- Off  
The system lock is deactivated. You can use the oven as normal.

## Miele@home

The oven is a Miele@home-compatible appliance. Your oven is fitted ex-works with a WiFi communication module and is suitable for wireless communication.

There are a number of ways of connecting your oven to your WiFi network. We recommend connecting your oven to your WiFi network with the help of the Miele app or via WPS.

- Activate  
This setting is only visible if Miele@home is deactivated. The WiFi function is reactivated.
- Deactivate  
This setting is only visible if Miele@home is activated. Miele@home remains set up, the WiFi function is switched off.
- Connection status  
This setting is only visible if Miele@home is activated. The display shows information such as the WiFi reception quality, network name and IP address.
- Set up again  
This setting is only visible if a WiFi network has already been set up. Reset the network settings and immediately set up a new network connection.
- Reset  
This setting is only visible if a WiFi network has already been set up. The WiFi function is deactivated and the WiFi network connection will be reset to the factory default. You must set up a new WiFi network connection to be able to use Miele@home. The network settings should be reset whenever an oven is being disposed

of or sold, or if a used oven is being put into operation. This is the only way to ensure that all personal data has been removed and the previous owner will no longer be able to access the oven.

- Set up

This setting is only visible if no WiFi network connection has been set up yet. You must set up a new WiFi network connection to be able to use Miele@home.

## Performing Scan & Connect

Initial commissioning has been carried out without Miele@home having been set up.

■ Scan the QR code.

If you have installed the Miele app and have a user account, you will be taken directly to the networking steps.

If you have not yet installed the Miele app, you will be taken to the Apple App Store® or the Google Play Store™.

■ Install the Miele app and set up a user account.

■ Scan the QR code again.

The Miele app will guide you through the setup process.



## Remote control

If you have installed the Miele app on your mobile device, have access to the Miele@home system and have activated the remote control function (On), you can set the temperature and

cooking duration after selecting an operating mode, retrieve information on cooking processes that are in progress or end a cooking process in progress, for instance.

## RemoteUpdate

The RemoteUpdate menu option is only displayed and can only be selected if the requirements for using Miele@home have been met.

The RemoteUpdate function is used for updating the software in your oven. If an update is available for your oven, it will automatically download it. Updates will not be installed automatically. They must be initiated manually.

If you do not install an update, you can continue to use your oven as usual. However, Miele recommends installing updates.

## Activating/deactivating

The RemoteUpdate function is activated as standard. Available updates will be downloaded automatically but will only be installed if you initiate installation manually.

Deactivate RemoteUpdate if you do not want any updates to be downloaded automatically.

## Running a RemoteUpdate

Information about the content and scope of an update will be provided in the Miele app.

A message will appear in your oven display if a software update is available. You can install the update immediately or postpone this until later. When the oven is switched on again, you will be reminded about the update.

# Adjusting settings

---

Deactivate RemoteUpdate if you do not want to install the update.

The update may take several minutes.

Please note the following information about the RemoteUpdate function:

- You will only receive a message when an update is available.
- Once an update has been installed, it cannot be undone.
- Do not switch the oven off during the update. Otherwise, the update will be aborted and will not be installed.
- Some software updates can only be carried out by your Miele dealer.

## Software version

The software version is intended for your Miele dealer. You do not need this information for domestic use.

## Showroom programme

This function enables the oven to be demonstrated in showrooms without heating up. This setting is not needed for domestic use.

## Demo mode













If you have demo mode activated, Demo mode active. The appliance will not heat up will appear when you switch the oven on.

- On  
Touch the *OK* sensor control for at least 4 seconds to activate demo mode.
- Off  
Touch the *OK* sensor control for at least 4 seconds to deactivate demo mode. You can use the oven as normal.

## Factory default

- Appliance settings  
Any settings that have been altered will be reset to the factory default settings.
- Recommended temps.  
Any recommended temperatures that have been changed will be reset to the factory default settings.

## Operating modes

Functions	Recommended value	Range
 Fan plus	160 °C	30–250 °C
 Intensive bake	170 °C	50–250 °C
 Eco Fan heat	190 °C	100–250 °C
 Further   Booster 	160 °C	100–250 °C
 Further   AirFry 	190 °C	30–250 °C
 Conventional heat	180 °C	30–280 °C
 Full grill	240 °C	200–300 °C
 Fan grill	200 °C	100–260 °C
 Automatic programmes		
 Pyrolytic		

# Operation

## Easy to use

- Place the food in the oven.
- Select the required oven operating mode with the operating mode selector.

The operating mode is displayed briefly and then the recommended temperature will appear.

- Change the recommended temperature with the rotary selector < >, if necessary.

The recommended temperature will be accepted within a few seconds. You can change the temperature subsequently via the < > rotary selector.

- Confirm with *OK*.



The actual temperature will appear and the heating-up phase will commence. You will see the temperature increasing. A buzzer will sound when the set temperature is reached for the first time.

- When the cooking process is finished, turn the operating mode selector to **O**.
- Take the food out of the oven compartment.

## Pre-heating the oven

The Booster operating mode is used to quickly pre-heat the oven compartment.

It is only necessary to pre-heat the oven compartment in a few instances.

- Most dishes can be placed in the cold oven to make use of the heat produced during the heating-up phase.
- Pre-heat the oven when cooking the following food with the following operating modes:
  - Dark bread dough as well as roast beef and fillet with the Fan plus  and Conventional heat  operating modes
  - Cakes and pastries with a short cooking duration (approx. 30 minutes or less) as well as delicate items (e.g. sponge) with the Conventional heat  operating mode

## Rapid heat-up

The heating-up phase can be shortened with the Booster  operating mode.

Do not use the Booster  operating mode to pre-heat the oven when baking pizzas or delicate mixtures (e.g. sponges, biscuits).

The food will brown too quickly on top.

- Select  Further with the operating mode selector.
- Confirm **Booster**✓ with *OK*.
- Select a temperature.
- Change to the required operating mode after the set temperature has been reached.
- Place the food in the oven.

## Changing the temperature

You can permanently reset the recommended temperature to suit your cooking preferences by selecting the  | Recommended temps. sensor control.

- Change the temperature using the rotary selector < >.

The temperature changes in 5 °C steps.

- Confirm with *OK*.

**Tip:** If you have programmed a cooking duration, you first have to quit the “Cooking duration” menu by touching the  sensor control. You can then change the temperature using the rotary selector < >.

Then touch the  sensor control to display the cooking duration again.

## Cooking durations

Cooking results can be impaired if there is a long delay between the food being placed in the oven and the start time of cooking. Fresh food can change colour and even deteriorate. When baking, the cake mixture or dough can dry out, and the raising agents can lose their effectiveness. Select as short as possible a time until the cooking process starts.

### Set cooking duration

You have placed the food in the oven compartment, selected an operating mode and the required settings such as the temperature.

Enter the cooking duration you require. The heating will switch off automatically once this duration has elapsed. The

maximum cooking duration that can be set depends on the operating mode that you have selected.

- Select the  sensor control.
- Set the cooking duration.
- Confirm with *OK*.

### Setting the finish time (Finish at)

You have placed the food in the oven compartment, selected an operating mode and the required settings such as the temperature.

Specify when you want the cooking process to end. The oven heating will switch off automatically at the time you have set.

- Select the  sensor control.
- Select Finish at.
- Enter the time you want the cooking process to stop.
- Confirm with *OK*.

### Setting the start time (Start at)



You have placed the food in the oven compartment, selected an operating mode and the required settings such as the temperature.

This function will only appear in the menu if you have set a Duration or Finish at time. With Start at, you have to specify when you want the cooking process to start. The oven compartment heating will switch on automatically at the time you have set.

- Select the  sensor control.
- Select Start at.
- Enter the time you want the cooking process to start.
- Confirm with *OK*.



# Operation

## Changing the set cooking durations

- Select the  sensor control.
- Select the desired time.
- Confirm with *OK*.
- Select *Change*.
- Change the set time.
- Confirm with *OK*.
- Touch the  sensor control to return to the menu of the selected function.

These settings will be deleted in the event of a power failure.

## Deleting the set cooking durations

- Select the  sensor control.
- Select the desired time.
- Confirm with *OK*.
- Select *Delete*.
- Confirm with *OK*.
- Touch the  sensor control to return to the menu of the selected function.

If you delete *Duration*, the set times for *Finish at* and *Start at* are also deleted.

If you delete *Finish at* or *Start at*, the cooking programme will start using the cooking duration set.

## Cancelling a cooking process

- Turn the operating mode selector to another operating mode or to the **0** position.

Any cooking durations set will be deleted. If you have turned the operating mode selector to the **0** position, the oven heating and lighting will also switch off.

## Using the AirFry operating mode

- Spread the food evenly over the perforated Gourmet baking and AirFry tray or the grilling and roasting insert in a single layer if possible.
- Place the food on shelf level 2.
- Select  Further with the operating mode selector.
- Select *AirFry* with the rotary selector.
- Confirm with *OK*.

The recommended temperature will appear.

- Change the recommended temperature according to the information in the recipe or the cooking chart.
- At the end of the cooking duration, check whether the food is crispy and browned enough for you.

## Using automatic programmes

The automatic programmes enable you to achieve excellent results with ease.

- Select *Automatic programmes* .

A list will appear in the display.

- Select the desired automatic programme.
- Confirm with *OK*.
- Follow the instructions on the display.

## Min. minder

### Using the Min. minder function

The  timer can be used to time other activities in the kitchen, e.g. boiling eggs.

The timer can also be used at the same time as a cooking process for which the cooking duration start and finish times have been set (e.g. as a reminder to stir the food or add seasoning, etc.).

The maximum time that can be set is 59:59 min.

If the display is dark, you must switch on the oven to change the settings:

- Turn the operating mode selector clockwise once and back again.

### Setting the minute minder

Example: you want to boil some eggs and set a minute minder of 6 minutes and 20 seconds.

- Select the ⊕ sensor control.
- Select Min. minder if a cooking process is in progress at the same time.

The prompt Set 00:00 min appears.

- Use the rotary control < > to enter 06:20.
- Confirm with *OK*.

The minute minder duration is now saved.

When the oven is switched off, the minute minder counts down in the display and △ appears instead of the time of day.

If you are cooking at the same time **without** a set cooking duration, △ and the minute minder will appear as soon as the desired temperature is reached.

If you are cooking at the same time **with** a set cooking duration, the minute minder will count down in the background as the cooking duration appears first in the display.

If you are in a menu, the minute minder counts down in the background.

When the minute minder finishes, △ will flash, a signal will sound and the time will start counting up.

- Select the ⊕ sensor control.

The buzzer will stop and the symbols on the display will go out.

### Changing the minute minder duration

- Select the ⊕ sensor control.
- Select Min. minder if a cooking programme is in progress at the same time.
- Select Change.
- Confirm with *OK*.

The minute minder duration selected appears.

- Change the duration set for the minute minder.
- Confirm with *OK*.

The altered minute minder duration is now saved.

### Deleting the minute minder duration

- Select the ⊕ sensor control.
- Select Min. minder if a cooking programme is in progress at the same time.
- Select Delete.
- Confirm with *OK*.

The minute minder duration is now deleted.

### Using accessories

Features will vary depending on model.

#### Using the rack

- Always slide the rack into the rails of the side runners with the catches facing down.

# Operation

## Using bakeware

- Always slide the rack into the rails of the side runners with the catches facing down.
- If you are using bakeware, ovenproof dishes and similar items, place these in the centre of the rack.

## Using baking trays

- The baking tray, universal tray and Gourmet baking and AirFry tray, perforated are inserted into the oven between the two rails of a side runner.

**Tip:** When baking with the HBBL 71 Gourmet baking and AirFry tray, perforated, roll out the dough on a level surface first and then place it on the perforated tray.

## Using the rack with the universal tray

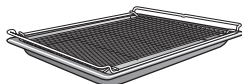

- Place the rack on top of the universal tray.
- Insert the universal tray into the oven between the two rails of a side runner. The rack is automatically inserted on the upper rail.

## Using the grilling and roasting insert with the universal tray

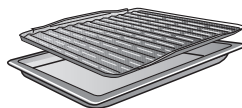

- Place the grilling and roasting insert on the universal tray.
- Insert the universal tray with the grilling and roasting insert into the oven between the two rails of a side runner.

## Using the Gourmet baking and pizza stone

- Always slide the rack into the rails of the side runners with the catches facing down.
- Place the Gourmet baking and pizza stone on the rack with the raised edge at the back.
- Preheat the Gourmet baking and pizza stone for 30 minutes in Conventional heat  operating mode at a temperature between 200 °C and 250 °C.

**Tip:** Detailed information can be found in the operating instructions for the Gourmet baking and pizza stone.

## Using the Gourmet oven dish

Damage to the enamel of the oven compartment floor caused by heat accumulation.

If you slide the Miele HUB 5000/5001 Gourmet oven dish into level 1, heat can accumulate at the bottom of the oven compartment due to lack of clearance, and the enamel may crack or flake off.

**Do not** insert the Miele HUB 5000/5001 Gourmet oven dish into level 1.

Never place the oven dish on the upper support of shelf level 1 either as it will not be secured by the non-tip safety notches.

**As a general rule** use **level 2** or, for browning, level 3 or 4.

- The Gourmet oven dish is inserted into the oven between the two rails of a side runner.

Oven dishes cannot be used together with lids (if they have them) on certain levels because the total height would exceed the available height inside the oven compartment.

**Tip:** Detailed information can be found in the operating instructions for the Gourmet oven dish.

## Fitting and removing HFC 70-C FlexiClip runners

 Risk of injury caused by hot surfaces.

The oven gets hot during operation. You could burn yourself on the heater elements, oven compartment or accessories.

Allow the heater element, oven compartment, and accessories to cool down.

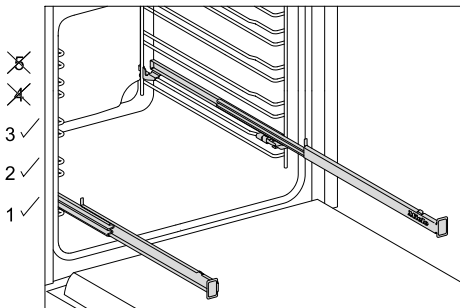

You can only use the FlexiClip runners on shelf levels 1, 2 and 3.

One level of the side runners consists of two rails. The FlexiClip runners are fitted on the upper rail of the two rails that make up a shelf level.

To use the FlexiClip runners for all food that is to be cooked on level 2, fit the FlexiClip runners on level 1.

Because the FlexiClip runners sit on the top rail of the side runners, the gap between the level the FlexiClip runners are on and the one above is smaller than if, for instance, racks were fitted on each level. Cooking results will be affected if the gap is too small.

The accessories will only sit securely in between the retainers at either end of each runner and be prevented from sliding off if the FlexiClip runners are fully inserted.

The FlexiClip runners can support a maximum load of 15 kg.

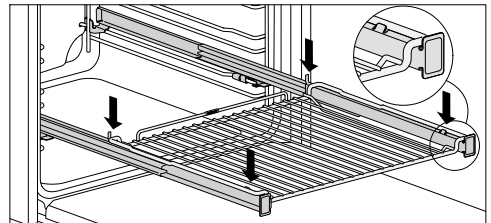
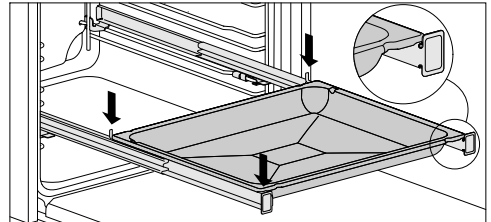

To prevent the risk of accessories sliding off the runners:

- Make sure that they are sitting securely on their runners in between the retainers at either end of each runner.
- Always place the rack on the FlexiClip runners with the catches facing down.

When fitting or removing the FlexiClip runners, do **not** fully extend them.

The FlexiClip runner with the Miele logo is fitted on the **right-hand** side of the oven compartment.

# Operation

## Fitting the FlexiClip runners

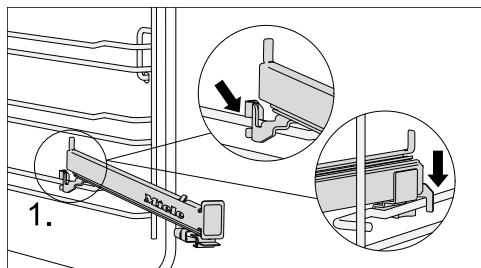

- Hook the FlexiClip runner onto the front of the top rail of a side runner (1.).

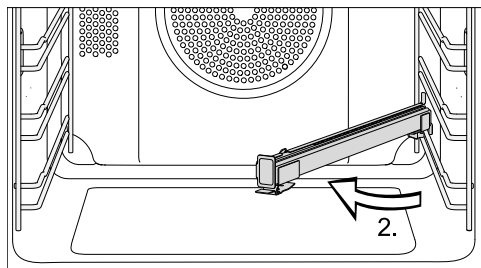

- Then hold the FlexiClip runner at an angle towards the middle of the oven compartment (2.).

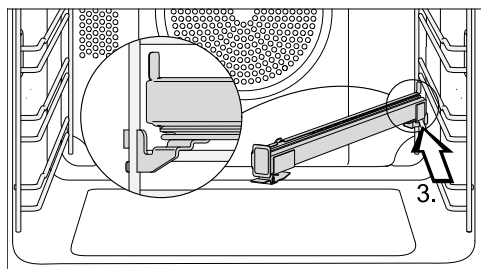

- Slide the FlexiClip runner at an angle along the top rail as far as it will go (3.).

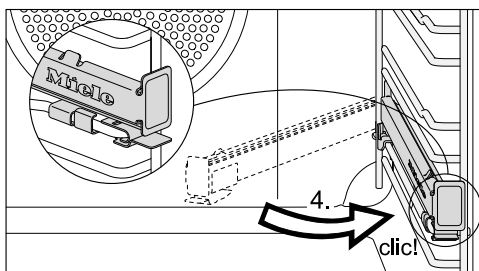

- Then swing the FlexiClip runner back to the side of the oven compartment and secure it to the top rail with an audible click (4.).

**Tip:** If the FlexiClip runners are difficult to pull out after fitting, pull firmly on them once to release them.

## Removing the FlexiClip runners

- Push the FlexiClip runner in all the way.

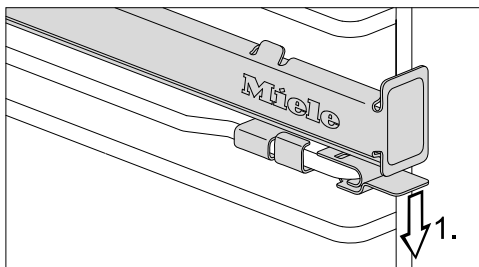

- Push down on the tab at the front of the FlexiClip runner (1.).

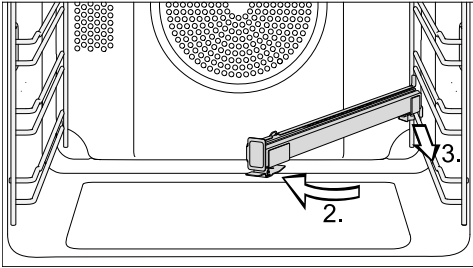

- Swing the FlexiClip runner towards the middle of the oven compartment (2.), then pull it forwards along the top rail (3.).
- Lift the FlexiClip runner off the rail and take it out of the oven.

# Good to know

## Baking

Handling food carefully will help protect your health.

Cakes, pizzas and french fries should be cooked until golden, not dark brown.

### Tips on baking

- Set a cooking duration. If used for baking, do not delay the start for too long. Cake mixture or dough will dry out, and the raising agents will lose their effectiveness.
- Generally speaking, you can use racks, baking trays, universal trays and any type of baking tray made of heat-resistant material.
- Avoid using bright, thin-walled tins as they give an uneven or poor browning result. Under adverse circumstances, the food will not cook properly.
- Position rectangular tins with the longer side across the width of the oven compartment for optimum heat distribution and even baking results.
- Always place bakeware on the rack.
- Bake cakes with fruit toppings or deep cakes on the universal tray.

### Using baking parchment

Miele accessories, e.g. the universal tray, are finished with PerfectClean. Surfaces finished with PerfectClean generally do not need to be greased or covered with baking parchment.

- Use baking parchment when baking lye mixtures because the sodium hydroxide used can damage surfaces finished with PerfectClean.
- Use baking parchment when baking sponge, meringue, macaroons or similar items. Due to their high egg white content, these are more likely to stick.
- Use baking parchment when cooking frozen food on the rack.

### Notes on the cooking charts

#### Selecting the temperature

- As a general rule, select the lower temperature given in the chart. Baking at temperatures higher than those recommended may reduce the cooking duration, but will lead to uneven browning of the food, and unsatisfactory cooking results.

#### Selecting the cooking duration

Unless otherwise stated, the cooking durations given in the cooking charts are for an oven compartment which has not been pre-heated. With a pre-heated oven compartment, shorten times by around 10 minutes.

- As a general rule, check the food after the shortest duration. Stick a wooden skewer into the food.

If it comes out clean without any batter/dough on it, the food is done.

### Notes on the functions

You can find an overview of all the functions with their recommended values in “Overview of functions”.

### Using Automatic programmes

- Follow the instructions on the display.

## Using Fan plus

Because the fan distributes the heat around the oven compartment straight away, it allows you to use a lower temperature than you would with the Conventional heat  function.

Use this function if you are baking on multiple shelves at the same time.

- 1 shelf: place the food in shelf level 2.
- 2 shelves: place the food on shelf levels 1+3 or 2+4.
- 3 shelves: place the food on shelf levels 1+3+5.

## Tips

- If you are cooking on multiple shelves at the same time, slide the universal tray in on the lowest level.
- For moist biscuits and cakes, bake on a maximum of 2 shelf levels at once.

## Using Intensive bake

Use this function for baking cakes with moist toppings.

Do **not** use this function for baking thin biscuits.

- Place cakes on shelf level 1 or 2.

## Using Conventional heat

Dark metal, enamel, or aluminium bakeware with a matt finish, as well as heat-resistant glass, ceramic, and coated bakeware can be used.

Use this function for baking traditional recipes. If using an older recipe or cookbook, set the oven temperature 10 °C lower than the recommended one. This will not change the cooking duration.

- Place the food in shelf level 1 or 2.

## Using Eco Fan heat

Use this function for cooking small amounts of food, e.g. frozen pizzas, part-baked rolls or biscuits, while saving energy.

- Place the food in shelf level 2.

## Roasting

### Tips for roasting

- You can use all crockery made from temperature-resistant materials, e.g. roasting dishes, roasting pans with lid, ovenproof glass dishes, roasting bags, dishes made from earthenware or cast iron, the universal tray, rack and/or anti-splash insert (if available) on top of the universal tray.
- **Pre-heating** the oven compartment is only required when roasting beef sirloin joints and fillet. Pre-heating is generally not necessary.
- Use a **closed roasting dish** for roasting meat, such as an oven dish. The meat stays succulent. The oven compartment will also stay cleaner than when roasting on the rack. This ensures that sufficient stock remains for making gravy.
- If you are using a **roasting bag**, follow the instructions on the packaging.
- If you are using the **rack** or an **open roasting dish** for roasting, you can add a little fat or oil to very lean meat.
- **Season** the meat and place in the roasting dish. Dot with butter or margarine or brush with oil or cooking fat if necessary. For large lean cuts of meat (2–3 kg) and fatty poultry add about 1/8 litre of water to the dish.

## Good to know



---

- Do not add too much liquid during cooking as this will hinder the **browning** process. Browning only occurs towards the end of the cooking duration. Remove the lid about halfway through the cooking duration if a more intensive browning result is desired.
- At the end of the programme, take the food out of the oven compartment, cover it and leave to **stand** for about 10 minutes. This helps retain juices when the meat is carved.
- For a crisp finish, baste **poultry** 10 minutes before the end of the cooking duration with slightly salted water.

### Notes on the cooking charts

- Take note of the temperature range, the shelf levels and the timings. These also take the type of cooking container, the size of the meat and cooking practices into account.

### Selecting the temperature

- As a general rule, select the lower temperature given in the chart. If higher temperatures are used than those specified, the meat will brown on the outside, but will not be properly cooked through.
- When cooking with Fan plus , select a temperature which is approx. 20 °C lower than with Conventional heat .
- For cuts which weigh more than 3 kg, select a temperature approx. 10 °C lower than that given in the cooking chart. The roasting process will take

longer, but the meat will cook evenly through and the skin or crackling will not be too thick.

- When roasting on the wire rack, set a temperature approx. 10 °C lower than for roasting in a covered oven dish.

### Selecting the cooking duration

Unless otherwise stated, the durations given in the roasting chart are for an oven compartment which has not been pre-heated.

- The traditional British method for calculating the roasting time is to allow 15 to 20 minutes per lb/450 grammes, according to type of meat, plus approx. 20 minutes, adjusting the length of time as roasting proceeds to obtain the required result. The roasting time can also be determined by multiplying the thickness of the roast [cm] with the time per cm [min/cm] stated below, depending on the type of meat:
  - Beef/venison: 15–18 min/cm
  - Veal/lamb: 12–15 min/cm
  - Sirloin/fillet: 8–10 min/cm
- As a general rule, check the food after the shortest duration.

### Tips

- For frozen meat, increase the cooking duration by approx. 20 minutes per kg.
- Frozen meat weighing less than approx. 1.5 kg does not need to be defrosted before roasting.

### Notes on the functions

You can find an overview of all the functions with their recommended values in “Overview of functions”.



Do not use the Intensive bake  operating mode for roasting as the juices will become too dark.

## Using Automatic programmes

- Follow the instructions on the display.

## Using Fan plus

This function is suitable for roasting meat, fish and poultry that needs to be well browned as well as sirloin joints and fillet.

The Fan plus  function allows you to use a lower temperature than you would with the Conventional heat  function, because the heat is immediately distributed around the oven compartment.

- Place the food in shelf level 2.

## Using Conventional heat

Use this function for baking traditional recipes. If using an older recipe or cookbook, set the oven temperature 10 °C lower than the recommended one. This will not change the cooking duration.

- Place the food in shelf level 2.

## Using Eco Fan heat

Use this function for cooking smaller roasts or meat dishes while saving energy.

- Place the food in shelf level 2.

## Grilling

 Risk of injury caused by hot surfaces.

If you grill with the door open, hot air will escape from the oven instead of being cooled by the cooling fan. The control elements will get hot.

Grill with the oven door closed.

## Tips for grilling

- Pre-heating is necessary when grilling. Pre-heat the top heat/grill element for approx. 5 minutes with the door closed.
- Trim the meat if necessary. Do not season the meat with salt before grilling as this draws the juices out.
- Add a little oil to lean meat if necessary. Do not use other types of fat as they can easily burn and cause smoke.
- Clean fish in the normal way. To enhance the flavour, season with a little salt. Fish can also be drizzled with lemon juice.
- Use the universal tray with the wire rack or the grilling and roasting insert (if present) in place. The juices collect under the insert. This prevents them from spitting and making the oven dirty and they can then be used for making gravy and sauces. Brush the wire rack or the grilling and roasting insert with oil and then place the food on top.

Do not use the baking tray.

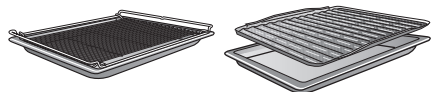

# Good to know

---

## Notes on the cooking charts

- Take note of the temperature range, the shelf levels and the timings. These take the size of the meat and cooking practices into account.
- Check the food after the shortest duration quoted.

## Selecting the temperature

- As a general rule, select the lower temperature given in the chart. If higher temperatures are used than those specified, the meat will brown on the outside, but will not be properly cooked through.

## Choosing a shelf level

- Select the shelf level depending on the thickness of the food to be cooked.
- Place flat food in shelf level 3 or 4.
- Place thicker food in shelf level 1 or 2.

## Selecting the cooking duration

- Grill thinner cuts of meat/slices of fish for approx. 6–8 minutes per side. It is best to grill food of a similar

thickness at the same time so that the cooking durations do not vary too much.

- As a general rule, check whether the food is cooked after the shortest duration.
- To **test the food**, press down on the meat with a spoon. This lets you determine how well the meat has been cooked.

### - **Rare/pink**

If the meat gives easily to the pressure of the spoon, it will still be red on the inside.

### - **Medium**

If there is some resistance, the inside will be pink.

### - **Well done**

If there is very little resistance, it is cooked through.

**Tip:** If the surface of a thicker cut of meat is browned but the centre is still raw, move the food to a lower level or reduce the temperature and continue grilling. This will stop the surface from becoming excessively charred.

## Notes on the functions

You can find an overview of all the functions with their recommended values in “Overview of functions”.

### Using Full grill

Use this function to grill flat thin cuts in large quantities and for browning large baked dishes.

The whole of the top heating/grill element glows red to provide the required heat.

### Using Fan grill

This function is suitable for grilling thicker food, such as chicken.

A temperature setting of 220 °C is generally recommended for thinner types of food, while 180–200 °C is recommended for thicker cuts.

### Defrost

Gentle defrosting of frozen goods means that the vitamins and minerals are generally retained.

- Select Fan plus  and a temperature of 30–50 °C.

Air is circulated throughout the oven compartment to gently defrost the frozen goods.

 Risk of infection from bacteria. Bacteria such as salmonella can cause life-threatening food poisoning. It is particularly important to observe food hygiene rules when defrosting fish and meat, and in particular when defrosting poultry. Do not use the liquid produced during defrosting. Process the food as required as soon as it has been defrosted.

### Tips

- Remove the packaging and place the frozen goods on the universal tray or in a suitable bowl or dish.
- Use the universal tray with the rack placed on top of it for defrosting poultry. This way the frozen goods will not be lying in the defrosted liquid.
- Meat, poultry or fish does not need to be fully defrosted before cooking. Defrost until the food has started to thaw. The surface will then be sufficiently thawed to take herbs and seasoning.

### Low temperature cooking

Low temperature cooking is ideal for cooking delicate cuts of beef, veal or lamb when a tender result is desired.

First sear the meat all over at a high temperature on the hob in order to seal it.

Then place the meat in the pre-heated oven compartment where the low temperature and long cooking duration will cook it to perfection and ensure it is very tender.

The meat will relax. The juices inside will start to circulate evenly throughout the meat to reach the outer layers.

This gives very tender and succulent results.

- Only use lean meat which has been correctly hung and trimmed. Bones must be removed before cooking.
- For searing, use a suitable cooking oil or fat that can withstand high temperatures (e.g. clarified butter, vegetable oil).
- Do not cover meat during the cooking process.

## Good to know

The cooking duration takes approx. 2–4 hours depending on the weight and size of the meat and how well you want it cooked.

- As soon as the cooking process is done, you can carve the meat straight from the oven. It does not need to rest.
- The meat can be left in the oven compartment to keep warm until you serve it. This will not affect results in any way.
- Serve on pre-heated plates with very hot sauce or gravy to prevent it cooling down too quickly. The meat is at the ideal temperature for eating straight away.

### Using Conventional heat

Use the universal tray with the rack placed on top of it.

- Place the rack together with the universal tray on shelf level 2.
- Select the Conventional heat  operating mode and a temperature of 120 °C.
- Pre-heat the oven together with the universal tray and rack for approx. 15 minutes.
- Whilst the oven is pre-heating, sear the meat thoroughly on all sides on the hob.

 Risk of burning due to hot surfaces.

The oven gets hot during operation. You could burn yourself on the heater elements, oven compartment or accessories.

Use oven gloves when placing hot food in the appliance or removing it and when adjusting oven shelves etc. in a hot oven compartment.

- Place the seared meat on the rack.
- Reduce the temperature to 100 °C.
- Continue cooking the meat until it is done.

### Drying

Dehydrating or drying is a traditional method of preserving fruit, certain vegetables and herbs.

It is important that fruit and vegetables are ripe and not bruised before they are dried.

- Peel and core the food for drying, if necessary, and cut it up.
- Depending on how big it is, distribute the food for drying evenly in a single layer (if possible) over the baking and roasting rack or the universal tray.





**Tip:** You can also use the perforated Gourmet baking and AirFry tray, if you have one.



- Dry on a maximum of 2 levels at the same time.  
Place the food for drying on shelf levels 1+3.

If using the baking and roasting rack and universal tray, place the universal tray below the rack.

- Select Fan plus .
- Change the recommended temperature and set the drying time.
- Turn the food for drying on the universal tray at regular intervals.

The drying times are longer for whole or halved food items.

Food for drying		🌡️ [°C]	🕒 [h]
Fruit		60–70	2–8
Vegetables		55–65	4–12
Mushrooms		45–50	5–10
Herbs*		30–35	4–8

-  Operating mode, 🌡️ Temperature,
- 🕒 Drying time,  Fan plus,
-  Conventional heat

\*When drying herbs, always use the universal tray on shelf level 2 and use the Conventional heat  operating mode, as the fan is switched on in the Fan plus operating mode.

- Reduce the temperature if condensation begins to form in the oven compartment.

## Removing the dried food

 Risk of injury caused by hot surfaces.

The oven gets hot during operation. You could burn yourself on the heating elements, oven compartment or accessories.

Use oven gloves when removing dried food from the oven.

- Allow the dried fruit or vegetables to cool down after drying.

Dried fruit needs to be completely dry, but also soft and elastic. Juice should not escape when cut.

- Store dried food in sealed glass jars or tins.

## Heat crockery

Use the Fan plus  operating mode for pre-heating crockery.

Only pre-heat heat-resistant crockery.

- Place the wire rack on shelf level 1 and place the crockery to be pre-heated on it. Depending on the size of the crockery, you can also place the rack on the oven floor and take the side runners out to make more room.
- Select Fan plus .
- Set the temperature to 50–80 °C.

 Risk of burns!

Use oven gloves when removing the crockery from the oven. Droplets of water may have accumulated underneath the crockery.

- Remove the heated crockery from the oven.

## Frozen food/Ready meals

### Tips for French fries, croquettes and similar items

Use the AirFry  operating mode to cook these frozen foods.

## Good to know

### Tips for cakes, pizza and baguettes

- Bake cakes, pizza and baguettes on baking paper on the rack. Do not use the baking tray or the universal tray for frozen foods with a large surface area. The tray could become warped and difficult, or even impossible, to remove from the oven compartment when hot. Additional use will make the warping worse.
- Use the lowest temperature recommended on the packaging.

### Preparing frozen food/ready meals

Handling food carefully will help protect your health.

Cakes, pizzas and french fries should be cooked until golden, not dark brown.

- Select the function and temperature recommended on the packaging.
- Pre-heat the oven compartment.
- Place the food in the pre-heated oven compartment on the shelf level recommended on the packaging.
- Check the food at the end of the shortest cooking duration recommended on the packaging.

### AirFry

Handling food carefully will help protect your health.

Food such as French fries should be cooked until golden, not dark brown.

The AirFry  operating mode is used to fry food in hot air. AirFrying is a gentle method of cooking which achieves even, crispy results.

AirFrying is therefore ideal for cooking frozen food such as French fries or potato croquettes.

### Accessories

- For **foods which do not drip**, e.g. French fries, use the Gourmet baking and AirFry tray, perforated. The fine perforations of the Gourmet baking and AirFry tray ensure that the food is browned and crispy on all sides.

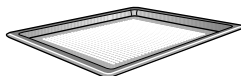

- For **food that drips**, e.g. chicken thighs, use the universal tray with the grilling and roasting insert (if present) placed on top. The tray under the insert will collect the meat juices and stop them from burning so that they can be used for making gravy and sauces. Brush the grilling and roasting insert with oil and then place the food on top.

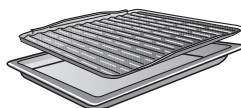

- Place food in bakeware centrally on the rack.

### AirFrying tips

- Do not defrost frozen food.
- Spread the food evenly over the perforated Gourmet baking and AirFry tray or the grilling and roasting insert in a single layer if possible.
- Place the food in the oven (without pre-heating). If the food is not crispy enough for you, you can try pre-heating the oven next time.

- Only cook on one level.  
Cooking on multiple levels will create too much moisture in the oven compartment and the food will not become crispy.
- As a general rule, food should be placed on shelf level 2.  
If you would like more browning on top, you can try using a higher level next time.
- Food such as French fries should be turned halfway through the cooking duration if possible.  
Set the minute minder to remind you.

### **AirFry recipes**

Below are the recipes to use with the AirFry operating mode.

For optimum cooking results, we recommend using the quantities and accessories given in the recipes.

# Good to know

---

## Falafel with yoghurt dip

Total time required: 60 minutes + 12 hours of soaking time

Serves 4

### For the falafel

250 g chickpeas, dried  
2 l water  
2 onions | finely diced  
2 cloves of garlic | finely chopped  
30 g parsley | chopped  
2 tbsp lemon juice  
1 tbsp olive oil  
50 g tahini (sesame paste)  
1 tsp coriander, ground  
1 tsp oregano  
½ tsp ras el hanout  
1 tsp cumin  
1½ tsp salt  
1 pinch of pepper  
1 pinch of chilli powder  
60 g plain white flour  
1 tsp baking powder

### For the yoghurt dip

500 g yoghurt, 3.5 % fat  
100 g cream cheese  
1 tbsp tahini (sesame paste)  
3 tbsp lemon juice  
20 g parsley | chopped  
1 tsp salt  
1 pinch of pepper

### Accessories

Sieve  
Mixer with cutting blade  
Mixer with dough hook  
Gourmet baking and AirFry tray,  
perforated

### Method

Soak the chickpeas in water for at least 12 hours.

To make the yoghurt dip, mix together all of the ingredients and chill.

Drain the chickpeas in a sieve.

Place the parsley, onions, garlic, lemon juice, oil, tahini and spices in the mixer. Gradually add the chickpeas. Stir the mixture with a tablespoon in between adding the chickpeas.

Put the mixture in a bowl. Mix the flour and baking powder and knead into the mixture. Shape the mixture into 24 balls. Flatten the balls slightly in your hands and place them on the Gourmet baking and AirFry tray. Place in the oven and bake until golden brown.

### Settings

Operating mode:  | AirFry  
Temperature: 210 °C  
Cooking duration: 18 minutes  
Shelf level: 2

## French fries and sweet potato fries

Total time required: 50 minutes

Serves 4

### For the fries

500 g potatoes, waxy | in batons  
(approx. 0.5 x 0.5 x 6 cm)

500 g sweet potatoes | in batons  
(approx. 0.5 x 0.5 x 6 cm)

30 ml sunflower oil

### For the dip

150 g Greek yoghurt

150 g buttermilk

¼ lemon | juice and zest

½ bunch of dill

¼ tsp rosemary, dried

¼ tsp oregano, dried

½ tsp onion, dried

¼ tsp garlic, dried

1 pinch of salt

1 pinch of pepper

### For the seasoned salt

2 tbsp salt

1 tsp paprika, smoked

½ tsp onion, dried

½ tsp garlic, dried

### Accessories

Pan

Kitchen towels

Gourmet baking and AirFry tray,  
perforated

### Method

Bring the water to the boil on the hob.  
Blanch the potato batons in boiling  
water for 3 minutes. Then drop them  
into cold water and pat dry on a kitchen  
towel.

Marinate the potato batons with the  
sunflower oil. Then place on the  
Gourmet baking and AirFry tray and  
cook according to the settings. Turn  
after 15 minutes and cook for a further  
10 minutes.

To make the dip, mix all the ingredients  
together and season with salt and  
pepper to taste. Chill the dip until ready  
to serve.

To make the seasoned salt, mix all the  
spices together and set aside.

At the end of the cooking duration,  
season the fries generously and serve  
with the dip.

### Settings

Operating mode:  | AirFry

Temperature: 220 °C

Cooking duration: 25 minutes

Shelf level: 2

# Good to know

---

## Sesame tofu sticks

Total time required: 35 minutes

Serves 3

### Ingredients

400 g tofu  
3 tbsp teriyaki sauce  
4 tbsp tahini (sesame paste)  
2 tbsp vegetable oil  
2 tbsp agave syrup  
1 tbsp sesame seeds, white  
1 tbsp sesame seeds, black  
1 tbsp cornflour  
3 tbsp breadcrumbs

### Accessories

Kitchen roll  
Grilling and roasting insert  
Universal tray

### Method

Cut the tofu into 1 cm thick slices and press firmly between pieces of kitchen roll. Then cut the tofu slices into sticks 1 cm wide and 3 cm long. Press the sticks between pieces of kitchen roll again in order to remove as much moisture as possible from the tofu. Leave the sticks on the kitchen roll for 15 minutes.

Mix together the teriyaki sauce, tahini, oil and agave syrup. Mix this sauce with the sesame seeds.

Place the tofu sticks in a bowl and add the cornflour. Toss the tofu sticks in the bowl until they are evenly coated with the cornflour. Pre-heat the oven using the indicated settings.

Add the sauce to the bowl containing the tofu sticks and mix everything together. Then sprinkle over the breadcrumbs and mix everything

together again. Place the grilling and roasting insert on the universal tray and place the tofu sticks on the insert so they are not touching each other. Place the tofu sticks in the pre-heated oven and bake.

### Settings: pre-heating

Operating mode:  | Booster  
Temperature: 190 °C

### Settings: baking the sesame tofu sticks

Operating mode:  | AirFry  
Temperature: 190 °C  
Cooking duration: 7 minutes  
Shelf level: 2

## Baked potatoes with cheese and spring onions

Total time required: 70 minutes

Serves 4

### For the potatoes

4 baking potatoes (200 g each)

2 tbsp oil

2 tsp salt

### For the dip

150 ml soured cream

30 g chives | finely chopped

1 pinch of salt

1 pinch of pepper

1 pinch of ground nutmeg

### For the topping

½ bunch of spring onions | sliced into thin rings

200 g cheese, mature (e.g. Gruyère, Sbrinz and Emmental) | grated

### Accessories

Grilling and roasting insert

Universal tray

### Method

Wash the potatoes thoroughly and dry them. Prick the potatoes all over with a fork. Then rub with a generous amount of oil and salt. Place the grilling and roasting insert on the universal tray, place the potatoes on top and bake according to cooking stages 1 and 2.

In the meantime, mix the soured cream with the chives to make the dip. Season with salt, pepper and nutmeg to taste.

After cooking stage 2, take the potatoes out of the oven. Carefully cut them in half and place them back on the grilling and roasting insert with the cut side

facing up. Sprinkle with cheese and bake until golden brown using the settings indicated for cooking stage 3.

Serve the baked potatoes with the spring onions and dip.

### Settings

Cooking stage 1

Operating mode:  | AirFry

Temperature: 200 °C

Cooking duration: 20 minutes

Shelf level: 2

Cooking stage 2

Operating mode:  | AirFry

Temperature: 180 °C

Cooking duration: 30 minutes

Cooking stage 3

Operating mode: 

Temperature: 180 °C

Cooking duration: 10 minutes

Shelf level: 3

## Good to know

---

### Baked potatoes with feta, tzatziki and Greek salad

Total time required: 70 minutes

Serves 4

#### For the potatoes

4 baking potatoes (200 g each)  
2 tbsp oil  
2 tsp salt

#### For the tzatziki

½ cucumber  
¼ tsp salt  
200 g Greek yoghurt  
1 clove of garlic | finely chopped  
¼ tsp salt  
1 pinch of pepper  
½ lemon | juice and zest

#### For the salad

½ cucumber | diced  
3 tomatoes | diced  
1 yellow pepper | finely diced  
1 red pepper | finely diced  
1 red onion | finely diced

#### For the dressing

½ tsp salt  
1 pinch of pepper  
½ lemon | juice only  
1 tsp dill | chopped

#### For the topping

200 g feta | crumbled

#### Accessories

Grilling and roasting insert  
Universal tray

#### Method

Wash the potatoes thoroughly and dry them. Prick the potatoes all over with a fork. Then rub with a generous amount of oil and salt. Place the grilling and

roasting insert on the universal tray, place the potatoes on top and bake according to cooking stages 1 and 2.

In the meantime, grate and salt the cucumber for the tzatziki and leave for 10 minutes.

Squeeze the liquid out of the cucumber. Mix the squeezed cucumber with the yoghurt and garlic. Then add salt, pepper, lemon juice and lemon zest to taste.

For the salad, put the vegetables in a bowl.

For the dressing, mix together the salt, pepper, dill, lemon juice and olive oil. Pour the dressing over the salad. Set aside until ready to serve.

After cooking stage 2, take the potatoes out of the oven. Carefully cut them in half and place them back on the grilling and roasting insert with the cut side facing up. Sprinkle with feta and bake until golden brown using the settings indicated for cooking stage 3.

Serve the baked potatoes with the tzatziki and salad.

#### Settings

Cooking stage 1  
Operating mode:  | AirFry  
Temperature: 200 °C  
Cooking duration: 20 minutes  
Shelf level: 2

Cooking stage 2

Operating mode:  | AirFry

Temperature: 180 °C

Cooking duration: 30 minutes

Cooking stage 3

Operating mode: 

Temperature: 180 °C

Cooking duration: 10 minutes

Shelf level: 3

## Good to know

---

### Courgette fries with blue cheese dip and chilli sauce

Total time required: 55 minutes

Serves 2

#### For the vegetables

2 courgettes  
2 eggs, medium  
50 ml milk, whole  
2 tbsp sunflower oil  
200 g panko breadcrumbs  
2 tsp salt  
½ tsp garlic powder  
½ tsp onion, granulated  
¼ tsp black pepper | coarsely ground  
100 g mature Alpine cheese | grated  
100 g plain white flour

#### For the blue cheese dip

150 g blue cheese, strong  
2 tbsp mayonnaise  
80 g yoghurt, 3.5 % fat  
1 pinch of salt  
1 pinch of pepper  
¼ tsp paprika, smoked

#### To serve

1 tsp sriracha sauce

#### Accessories

Grilling and roasting insert  
Hand blender  
Universal tray

#### Method

Halve the courgettes crosswise and cut each half into 8 equal pieces.

Whisk the eggs, milk and oil together in a shallow bowl.

In another bowl, mix together the panko breadcrumbs, spices and Alpine cheese. Place the flour in a third bowl. Now coat the courgette pieces with the breadcrumbs.

To do this, first turn the courgette pieces in the flour, then in the egg mixture. Then coat them evenly with the panko mixture. For a particularly even and crispy coating, turn the pieces in the egg and panko mixtures a second time.

Place the grilling and roasting insert on the universal tray, place the courgette pieces on top and bake according to the settings. Turn after 15 minutes and bake for a further 10 minutes.

To make the dip, blend all the ingredients for around 1 minute. Blending for too long may cause the dip to separate. Chill the dip until ready to serve.

Serve the courgette fries with the dip and drizzle with the sriracha sauce.

#### Settings

Operating mode:  | AirFry  
Temperature: 205 °C  
Cooking duration: 25 minutes  
Shelf level: 2

### Corn grilled with hoisin glaze and coleslaw

Total time required: 40 minutes

Serves 4

#### For the dressing

100 g mayonnaise  
1 tbsp cider vinegar  
1 tbsp mustard  
½ tsp caster sugar  
1 pinch of salt  
1 pinch of pepper

#### For the salad

¼ white cabbage | cut into thin strips  
¼ red cabbage | thinly sliced  
2 carrots | thinly sliced

#### For the corn with hoisin glaze

4 cobs, pre-cooked | quartered  
50 g hoisin sauce  
50 g mayonnaise

#### To serve

2 tbsp sesame seeds, white

#### Accessories

Grilling and roasting insert  
Universal tray

#### Method

For the dressing, mix together the mayonnaise, cider vinegar, mustard and sugar. Season with salt and pepper to taste. For the salad, mix together the white cabbage, red cabbage and carrots in a bowl. Pour the dressing over the salad and fold in. Set the salad aside until ready to serve.

Place the grilling and roasting insert on the universal tray, place the corn cobs on top and cook according to the settings.

For the glaze, mix together the hoisin sauce and mayonnaise. After 15 minutes, brush the corn with the hoisin mixture and cook for a further 10 minutes.

Sprinkle the cobs with the sesame seeds to taste. Serve with coleslaw.

#### Setting

Operating mode:  | AirFry  
Temperature: 210 °C  
Cooking duration: 25 minutes  
Shelf level: 2

## Good to know

---

### Chicken nuggets with coconut sesame coating

Total time required: 25 minutes

Serves 2

#### For the coating

100 g breadcrumbs  
50 g sesame seeds, white  
50 g desiccated coconut  
2 tsp salt  
1 tsp paprika, smoked  
1 tsp garlic powder  
1 tsp onion powder  
100 g plain white flour  
3 eggs, medium  
1 tbsp vegetable oil  
3 tbsp milk, whole

#### For the chicken nuggets

2 chicken breast fillets, ready to cook |  
in finger-width strips

#### To serve

2 tsp sweet chilli sauce

#### Accessories

Gourmet baking and AirFry tray,  
perforated

#### Method

For the coating, mix together the breadcrumbs, sesame seeds, desiccated coconut, salt, paprika, onion powder and garlic powder in a bowl. Place the flour in another bowl. Whisk the eggs, oil and milk together in a third bowl.

Now coat the chicken strips with the breadcrumbs.  
To do this, first turn the chicken strips in the flour, then in the egg/oil mixture. Then coat them with the breadcrumb/spice mixture. Place the coated nuggets

directly on the Gourmet baking and AirFry tray and cook according to the settings. Turn after 10 minutes.

Serve the cooked chicken nuggets with the sweet chilli sauce.

#### Setting

Operating mode:  | AirFry  
Temperature: 210 °C  
Cooking duration: 15 minutes  
Shelf level: 2

## Cod with crust

Total time required: 70 minutes

Serves 4

### For the cod with crust

60 g butter | softened  
1 tbsp mustard  
50 g tomatoes, sundried, in oil  
½ bunch of parsley, flat leaf  
½ bunch of chives  
1 tbsp lemon thyme  
60 g panko breadcrumbs  
4 cod fillets (150 g each), ready to cook  
4 pinches of salt

### For the pepper and potato salad

2 peppers, red | roughly chopped  
2 peppers, yellow | roughly chopped  
200 g potatoes, waxy | cut into thin wedges  
1 onion, red | cut into thin wedges  
1 clove of garlic | crushed  
1 tbsp olive oil  
½ tsp salt  
¼ tsp paprika, smoked

### For the dressing

30 ml balsamic vinegar  
1 tbsp mustard  
2 tbsp honey  
1 pinch of salt  
1 pinch of pepper  
60 ml olive oil

### To serve

125 g rocket | washed

### Accessories

Hand blender  
Grilling and roasting insert  
Universal tray  
Screw-top jar

### Method

For the crust, blend together the butter, mustard, sundried tomatoes, parsley, lemon thyme and chives. Fold in the panko breadcrumbs and season with salt to taste. Pat the fish fillets dry and salt them. Shape the crust into 4 pieces corresponding to the size of the fish fillets and place them on the fish. Place the grilling and roasting insert on the universal tray. Place the fish on the left side of the grilling and roasting insert.

For the vegetables, place the two types of pepper, potato wedges, onions and garlic in a bowl, drizzle with oil and season. Then spread out the vegetables on the right side of the grilling and roasting insert. Place the tray in the oven and roast the cod and vegetables using the indicated settings.

For the dressing, mix together the balsamic vinegar, mustard, honey, salt and pepper in a screw-top jar. Add the olive oil, seal the jar and shake vigorously for approx. 1 minute.

Before serving, mix the rocket with the warm vegetables and marinate the salad with the dressing. Serve the fish on the salad.

### Settings

Operating mode:  | AirFry  
Temperature: 210 °C  
Cooking duration: 20 minutes  
Shelf level: 2

## Good to know

---

### Bananas with pistachio and honey topping

Total time required: 25 minutes

Serves 4

#### Ingredients

50 g pistachio nuts | shelled

1 pinch of salt

4 bananas

2 tbsp wild honey

#### Accessories

Frying pan

Grilling and roasting insert

Universal tray

#### Method

Roughly chop the pistachios and toast lightly in the pan. Add the salt. Remove the pan from the hob and leave to cool slightly.

Place the grilling and roasting insert on the universal tray. Cut the bananas in half lengthways (still in the skin) and place them on the grilling and roasting insert with the cut side facing up. Mix the honey with the pistachios. Spread the pistachio/honey mixture over the banana halves. Place the bananas in the oven and cook.

#### Settings

Operating mode:  | AirFry

Temperature: 200 °C

Cooking duration: 8 minutes

Shelf level: 2

### Pasteis de nata

Total time required: 60 minutes

Serves 12

#### For the pasteis

2 eggs, medium  
37 g vanilla custard powder for cooking  
200 ml milk, whole  
250 ml double cream  
70 g caster sugar  
1 pinch of salt  
Approx. 275 g puff pastry

#### For dusting

1 tsp icing sugar  
1 pinch of cinnamon

#### For the tin

1 tsp butter

#### Accessories

Sieve  
Muffin tin for 12 muffins  
Whisk  
Rolling pin  
Baking and roasting rack

#### Method

Whisk the eggs and press through a sieve. Mix 5 tbsp of the milk with the custard powder and the eggs until smooth. Bring the rest of the milk, the cream, sugar and salt to a boil while stirring. Remove the pan from the hob and add the custard mixture while stirring. Bring everything to the boil while stirring. Pour the mixture into a bowl, cover and chill.

Grease the muffin tin. Roll out the puff pastry and cut out 12 circles with a diameter of 10 cm. Place the circles in the recesses of the muffin tin and press

in firmly so there are no bubbles in the base and the dough does not protrude out of the recesses.

Divide the custard mixture between the 12 recesses. Place the muffin tin in the oven on the baking and roasting rack. Bake the pasteis until brown spots appear on the custard mixture.

Mix together the icing sugar and cinnamon and sprinkle it over the pasteis while still warm. Remove the pasteis from the tin while still warm and leave to cool on the baking and roasting rack.

#### Settings

Operating mode:  | AirFry  
Temperature: 200 °C  
Cooking duration: 18 minutes  
Shelf level: 2

# Good to know

---

## Vegan pasteis de nata

Total time required: 60 minutes

Serves 12

### For the pasteis

500 ml oat milk

40 g potato starch

40 g caster sugar

1 vanilla pod

Approx. 275 g puff pastry

¼ tsp cinnamon, ground

### To serve

¼ tsp cinnamon, ground

### Accessories

Muffin tin for 12 muffins

Whisk

Pan

Rolling pin

Baking and roasting rack

### Method

Mix 4 tbsps of oat milk with the potato starch and set aside. Bring the rest of the oat milk to the boil with the sugar, vanilla seeds and vanilla pod. Stir the oat milk that was mixed with the potato starch into the boiling oat milk. Bring the thickened mixture to the boil for approx. 1 minute while stirring, then pour into a bowl, cover and leave to cool.

Roll the puff pastry into a tight roll, cut into 12 pieces and chill. Take out one pastry piece at a time and roll out into a circle with a diameter of approx. 10 cm. Place the circle into a recess of the muffin tin and press in firmly so there are no bubbles in the base and the dough does not protrude out of the recess. Repeat the process with the remaining 11 pastry pieces.

Fill the recesses max.  $\frac{3}{4}$  with the custard mixture. Place the muffin tin in the oven on the baking and roasting rack and bake the pasteis immediately using the indicated settings. To achieve the typical flavour, the pasteis de nata should have a few very dark spots on top. Dust with cinnamon before serving.

### Settings

Cooking stage 1

Operating mode:  | AirFry

Temperature: 210 °C

Cooking duration: 25 minutes

Shelf level: 2

Cooking stage 2

Operating mode:  | AirFry

Temperature: 245 °C

Cooking duration: 10 minutes

Shelf level: 2

### Automatic programmes

#### Usage notes

- When using automatic programmes, the recipes provided are designed as a guide only. For optimum cooking results, we recommend using the quantities and accessories given in the recipes.
- After a cooking process, allow the oven compartment to cool down to room temperature again before starting an automatic programme.
- Some automatic programmes require a pre-heating phase before food can be placed in the oven. This will be indicated in the display.

#### Recipes for automatic programmes

Below are the recipes to use with the automatic programmes.

For optimum cooking results, we recommend using the quantities and accessories given in the recipes.

To find the correct shelf level, please remove the FlexiClip runners HFC 70-C before starting an automatic programme.

# Good to know

---

## Apple sponge

Total time required: 95 minutes

Serves 12

### For the topping

500 g apples, tart

2 tbsp lemon juice

### For the dough

150 g butter | softened

150 g caster sugar

8 g vanilla paste

3 medium eggs

150 g plain white flour

½ tsp baking powder

### For the tin

1 tsp butter

### For dusting

1 tbsp icing sugar

### Accessories

Baking and roasting rack

Springform tin, Ø 26 cm

Sieve, fine

### Preparation

Peel and quarter the apples. Cut into the outside of each apple quarter (opposite side to the core), making cuts approximately 1 cm apart. Mix with the lemon juice and put to one side.

Grease the springform tin.

Cream together the butter, sugar and vanilla paste for approximately 2 minutes. Stir in the eggs one at a time (½ minute each).

Sift together the flour and baking powder and mix with the other ingredients.

Pour the mixture into the springform tin, spreading it evenly. Press the apples gently into the mixture with the core side down.

Place the springform tin on the baking and roasting rack inside the oven and bake.

Leave the cake in the tin for 10 minutes. Then release the sides of the tin and leave to cool on the baking and roasting rack. Dust with icing sugar.

### Settings

#### Automatic programme

 | Apple sponge

Programme running time: 55 minutes

#### Manual

Operating mode: 

Temperature: 165–175 °C

Pre-heating: no

Duration: 45–55 minutes

Shelf level: +HFC 70-C: 1 | -HFC 70-C: 2

#### Tip

As an alternative to dusting the cake with icing sugar, try an apricot glaze instead. To create the glaze, gently heat some apricot jam and stir it until smooth.

## Sponge base

Total time required: 75 minutes

Serves 12

### For the dough

4 medium eggs

4 tbsp water | hot

175 g caster sugar

200 g plain white flour

1 tsp baking powder

### For the tin

1 tsp butter

### Accessories

Baking and roasting rack

Sieve, fine

Springform tin, Ø 26 cm

Baking parchment

### Preparation

Separate the egg whites from the yolks. Beat the egg whites with the water until stiff. Slowly add the sugar, beating after each addition. Then fold in the beaten egg yolk.

Place the baking and roasting rack in the oven. Start the automatic programme or pre-heat the oven.

Mix the flour and baking powder, sieve into the egg mixture and fold in with a large whisk.

Grease the base of the springform tin and line with baking parchment. Pour the mixture into the tin and spread it out evenly.

Place the sponge base in the oven and bake until golden.

After baking, allow to cool in the tin for 10 minutes. Then, remove from the tin and allow to cool on the baking and

roasting rack. Slice the sponge base twice horizontally to make three separate layers.

Spread with the prepared filling.

### Settings

#### Automatic programme

 | Sponge base

Programme running time: 36 minutes

#### Manual

Operating mode: 

Temperature: 160–170 °C

Pre-heating: yes

Duration: 30–40 minutes

Shelf level: +HFC 70-C: 1 | -HFC 70-C: 2

#### Tip

To make a chocolate sponge, add 2–3 teaspoons of cocoa powder to the flour mixture.

# Good to know

---

## Layered sponge cake fillings

Total time required: 30 minutes

### For the quark and double cream filling

500 g quark, 20 % fat in dry matter  
100 g caster sugar  
100 ml milk, whole  
8 g vanilla paste  
1 lemon | juice only  
6 sheets of gelatine, white  
500 ml double cream

### For dusting

1 tbsp icing sugar

### For the cappuccino filling

100 g chocolate, dark  
500 ml double cream  
6 sheets of gelatine, white  
160 ml espresso  
16 g vanilla paste  
1 tbsp cocoa powder

### For dusting

1 tbsp cocoa powder

### Accessories

Cake platter  
Sieve, fine

### Method for the quark and double cream filling

To make the quark and double cream filling, stir together the quark, sugar, milk, vanilla paste and lemon juice. Soak the gelatine in cold water, then squeeze the water out and dissolve it in the microwave or on the cooking zone on low.

Stir a little of the quark mixture into the gelatine.

Stir this mixture into the remaining quark mixture and chill. Whip the double cream until stiff and stir it into the quark mixture.

Place the first layer of sponge on a cake platter and cover it with the quark mixture. Place the second layer on top and cover with the quark mixture too. Then place the third layer on top of that.

Cool the cake thoroughly. Dust with icing sugar before serving.

### Method for the cappuccino filling

To make the cappuccino filling, start by melting the chocolate. Whip the cream until stiff and set a small portion aside to spread on the top layer. Soak the gelatine in cold water, then squeeze the water out and dissolve it in the microwave or on the cooking zone on low. Then leave it to cool slightly.

Stir half of the espresso into the gelatine. Then fold this mixture into the whipped cream.

Divide the coffee and cream mixture in half. Stir the vanilla paste into one half and the chocolate and cocoa powder into the other half.

Place the first layer of sponge on a cake platter, drizzle some of the espresso over the top and then coat with the dark cream mixture. Place the second sponge layer on top of the first, drizzle the remaining liquid over it and then coat with the light cream mixture.

Place the third layer on top, coat it with the cream you set aside and dust with cocoa powder.

**Tip**

For a fruity variation, add some grated lemon zest and 300 g tinned apricots or mandarin segments (drained) to the quark and cream filling.

# Good to know

---

## Marble cake

Total time required: 80 minutes

Serves 18

### For the dough

250 g butter | softened

200 g caster sugar

8 g vanilla paste

4 medium eggs

200 ml soured cream

400 g plain white flour

16 g baking powder

1 pinch of salt

3 tbsp cocoa powder

### For the tin

1 tsp butter

### Accessories

Ring tin, Ø 26 cm

Baking and roasting rack

### Preparation

Cream together the butter, sugar and vanilla paste. Add the eggs one by one, stirring for ½ minute each time. Add the soured cream. Mix together the flour, baking powder and salt. Then stir into the other ingredients.

Grease the ring tin and place half of the mixture into it.

Stir the cocoa powder into the other half of the mixture. Pour the dark mixture over the light mixture. Swirl a fork through the mixture to give a marbled effect.

Place the ring tin on the baking and roasting rack in the oven and bake.

Leave the cake in the tin for 10 minutes. Then, remove from the tin and allow to cool on the baking and roasting rack.

### Settings

#### Automatic programme

 | Marble cake

Programme running time: 55 minutes

#### Manual

Operating mode: 

Temperature: 150–160 °C

Pre-heating: no

Duration: 50–60 minutes

Shelf level: +HFC 70-C: 1 | -HFC 70-C:

2

## Fruit streusel cake

Total time required: 150 minutes

Serves 20

### For the dough

42 g fresh yeast  
150 ml milk, whole | lukewarm  
450 g plain white flour  
50 g caster sugar  
90 g butter | softened  
1 egg, medium

### For the topping

1.25 kg apples

### For the streusel crumble

240 g plain white flour  
150 g caster sugar  
16 g vanilla paste  
1 tsp cinnamon  
150 g butter | softened

### Accessories

Baking tray or universal tray

### Preparation

Stir the yeast into the milk to dissolve it. Add to the flour, sugar, butter and the egg, and knead to form a smooth dough.

Shape the dough into a ball, place it in a bowl, cover it with a damp cloth and place it in the oven compartment. Prove the dough using the settings indicated for proving phase 1.

Peel and core the apples and slice them into wedges.

Lightly knead the dough and then roll it out on a baking tray or the universal tray. Arrange the apples evenly across the dough. Mix together the flour, sugar, vanilla paste and cinnamon. Then knead in the butter to create a crumble mix. Scatter over the apples.

Place the cake in the oven and prove the dough using the settings indicated for proving phase 2.

Bake the cake until golden brown.

### Settings

#### Prove dough

Proving phase 1

Operating mode: 

Temperature: 30 °C

Proving time: 30–45 minutes

Proving phase 2

Operating mode: 

Temperature: 30 °C

Proving time: 30 minutes

### Baking

#### Automatic programme

 | Fruit streusel cake

Programme running time: 44 minutes

#### Manual

Operating mode: 

Temperature: 180–190 °C

Pre-heating: no

Duration: 40–50 minutes

Shelf level: +HFC 70-C: 2 | -HFC 70-C:

3

#### Tip

Instead of the apples, try using 1 kg stoned plums or cherries.

# Good to know

---

## Biscuits

Total time required: 135 minutes

Makes 70 (2 trays)

### Ingredients

250 g plain white flour

½ tsp baking powder

80 g caster sugar

8 g vanilla paste

3 tbsp water

120 g butter | softened

### Accessories

Rolling pin

Biscuit cutters

2 baking trays or universal trays

### Preparation

Mix together the flour, baking powder, sugar and vanilla paste. Add the rest of the ingredients and quickly knead to form a smooth dough. Chill for at least 60 minutes.

Roll out the dough to a thickness of approx. 3 mm, cut out the biscuits and place them on the baking or universal trays.

Place the biscuits in the oven compartment and bake.

### Settings

#### Automatic programme

 | Biscuits |

1 tray / 2 trays

Programme running time for 1 tray:

25 minutes

Programme running time for 2 trays:

26 minutes

### Manual

Operating mode: 

Temperature: 140–150 °C

Pre-heating: no

Duration: 25–35 minutes

Shelf level, 1 tray:

+HFC 70-C: 1 | -HFC 70-C: 2

Shelf level, 2 trays:

+HFC 70-C: 1+3 | -HFC 70-C: 1+3

### Tip

The quantities for the ingredients are for 2 trays. For 1 tray, halve the quantities or bake the biscuits one batch after the other.

## Drop cookies

Total time required: 50 minutes

Makes 50 (2 trays)

### Ingredients

160 g butter | softened

50 g sugar, brown

50 g icing sugar

8 g vanilla paste

1 pinch of salt

200 g plain white flour

1 egg, medium | white only

### Accessories

Piping bag

Star nozzle, 9 mm

2 baking trays or universal trays

### Preparation

Beat the butter until creamy. Add the sugar, icing sugar, vanilla paste and salt and beat until soft. Then fold in the flour followed by the egg white.

Put the dough in a piping bag and pipe it onto the baking tray or universal tray in strips measuring approx. 5–6 cm in length.

Place the shortbread biscuits in the oven compartment and bake until golden.

### Settings

#### Automatic programme

 | Drop cookies | 1 tray / 2 trays

Programme running time for 1 tray:

24 minutes

Programme running time for 2 trays:

31 minutes

### Manual

#### For 1 tray

Operating mode: 

Temperature: 150–160 °C

Pre-heating: no

Duration: 20–30 minutes

Shelf level: +HFC 70-C: 1 | -HFC 70-C:  
2

#### For 2 trays

Operating mode: 

Temperature: 140–150 °C

Pre-heating: no

Duration: 25–35 minutes

Shelf level: +HFC 70-C: 1+3 | -HFC 70-C:  
1+3

### Tip

The quantities for the ingredients are for 2 trays. For 1 tray, halve the quantities or bake the biscuits one batch after the other.

# Good to know

---

## Walnut muffins

Total time required: 95 minutes

Makes 12

### Ingredients

80 g raisins

40 ml water

120 g butter | softened

120 g caster sugar

8 g vanilla paste

2 medium eggs

140 g plain white flour

1 tsp baking powder

120 g walnuts | roughly chopped

### Accessories

Muffin tin for 12 muffins, Ø 5 cm each

Paper cases, Ø 5 cm

Baking and roasting rack

### Preparation

Drizzle the water over the raisins and leave to soak for approximately 30 minutes.

Beat the butter until creamy. Gradually mix in the sugar, vanilla paste and eggs. Sift together the flour and baking powder and mix in. Stir in the walnuts. Finally, add the raisins.

Line the muffin tin with the paper cases. Using 2 tablespoons, distribute the mixture evenly between the muffin cups.

Place the muffin tin on the baking and roasting rack in the oven and bake.

### Settings

#### Automatic programme

 | Walnut muffins

Programme running time: 37 minutes

### Manual

Operating mode: 

Temperature: 150–160 °C

Pre-heating: no

Duration: 30–40 minutes

Shelf level: +HFC 70-C: 1 | -HFC 70-C: 2

## Pizza (yeast dough)

Total time required: 90 minutes

Serves 4

### For the dough

30 g fresh yeast  
170 ml water | lukewarm  
300 g plain white flour  
1 tsp caster sugar  
1 tsp salt  
½ tsp thyme, dried rubbed  
1 tsp oregano, dried rubbed  
1 tbsp oil

### For the topping

2 onions  
1 clove of garlic  
400 g tomatoes, tinned, peeled and chopped  
2 tbsp tomato purée  
1 tsp caster sugar  
1 tsp oregano, dried rubbed  
1 bay leaf  
1 tsp salt  
Pepper  
125 g mozzarella  
125 g Gouda, grated

### For frying

1 tbsp olive oil

### Accessories

Baking tray or universal tray

### Preparation

Stir the yeast into the water to dissolve it. Add to the flour, sugar, salt, thyme, oregano and oil and knead for 6–7 minutes until you have a smooth dough.

Shape the dough into a ball, place it in a bowl and cover with a damp cloth. Leave to prove at room temperature for 20 minutes.

To make the topping, finely dice the onions and garlic. Heat the oil in a pan. Sauté the onions and garlic until translucent. Add the tomatoes, tomato purée, sugar, oregano, bay leaf and salt.

Allow the sauce to simmer for 5 minutes.

Remove the bay leaf, then season with salt and pepper to taste. Slice the mozzarella.

Roll the dough out onto the baking tray or universal tray. Leave to prove at room temperature for 10 minutes.

Start the automatic programme or pre-heat the oven.

Spread the sauce over the dough. Leave a gap of approximately 1 cm all the way round the edge. Top with the mozzarella and sprinkle on the Gouda.

Place the pizza in the oven compartment and bake.

### Settings

#### Automatic programme

 Pizza | Yeast dough

Programme running time: 32 minutes

#### Manual

Operating mode: 

Temperature: 200–210 °C

Pre-heating: yes

Duration: 20–30 minutes

Shelf level: +HFC 70-C: 1 | -HFC 70-C:

2

## Good to know

---

**Tip**

As an alternative, try topping the pizza with sausage, mushrooms, onions or tuna.

## Pizza (quark dough)

Total time required: 60 minutes

Serves 4

### For the dough

120 g quark, 20 % fat in dry matter

4 tbsp milk, whole

4 tbsp oil

2 eggs, medium | yolks only

1 tsp salt

1½ tsp baking powder

250 g plain white flour

### For the topping

2 onions

1 clove of garlic

400 g tomatoes, tinned, peeled and chopped

2 tbsp tomato purée

1 tsp caster sugar

1 tsp oregano

1 bay leaf

1 tsp salt

Pepper

125 g mozzarella

125 g Gouda, grated

### For frying

1 tbsp olive oil

### Accessories

Baking tray or universal tray

### Preparation

To make the topping, finely dice the onions and garlic. Heat the oil in a pan. Sauté the onions and garlic until translucent. Add the tomatoes, tomato purée, sugar, oregano, bay leaf and salt.

Allow the sauce to simmer for 5 minutes.

Remove the bay leaf. Season with salt and pepper to taste. Slice the mozzarella.

To make the dough, start by mixing together the quark, milk, oil, egg yolk and salt. Sift together the flour and baking powder. Mix half the amount into the dough. Then knead in the rest.

Roll the dough out onto the baking tray or universal tray.

Start the automatic programme or pre-heat the oven.

Spread the sauce over the dough. Leave a gap of approximately 1 cm all the way round the edge. Top with the mozzarella and sprinkle on the Gouda.

Place the pizza in the oven compartment and bake.

### Settings

#### Automatic programme

 | Pizza | Quark dough

Programme running time: 33 minutes

#### Manual

Operating mode: 

Temperature: 180–190 °C

Pre-heating: yes

Duration: 25–35 minutes

Shelf level: +HFC 70-C: 2 | -HFC 70-C:

3

#### Tip

As an alternative, try topping the pizza with sausage, mushrooms, onions or tuna.

# Good to know

---

## Chicken

Total time required: 95 minutes

Serves 2

### Ingredients

1 chicken, ready to cook (1.2 kg)

2 tbsp oil

1½ tsp salt

2 tsp paprika, sweet

1 tsp curry powder

### Accessories

Baking and roasting rack

Ovenproof dish, 22 cm x 29 cm

Kitchen string

### Preparation

Mix the oil with the salt, paprika and curry powder, then coat the chicken with it.

Tie the legs together with kitchen string and put the chicken breast side up in the ovenproof dish.

Place the ovenproof dish on the baking and roasting rack and slide it into the oven compartment with the legs of the bird pointing towards the door. Roast the chicken.

### Settings

#### Automatic programme

 | Chicken

Programme running time: 80 minutes

#### Manual

Operating mode: 

Temperature: 180–190 °C

Pre-heating: no

Duration: 75–85 minutes

Shelf level: +HFC 70-C: 1 | -HFC 70-C:

2

## Fillet of beef (roast)

Total time required: 65 minutes

Serves 4

### For the fillet of beef

1 kg fillet of beef, ready to cook

2 tbsp oil

1 tsp salt

Pepper

### For frying

2 tbsp oil

### Accessories

Universal tray

### Preparation

Start the automatic programme or pre-heat the oven.

Heat the oil in a pan and sear the fillet of beef all over (approximately 1 minute per side).

Remove the fillet of beef. Mix together the oil, salt and pepper, then coat the fillet of beef with it.

Place the fillet of beef onto the universal tray and slide into the oven compartment. Cook the fillet of beef.

### Settings

#### Automatic programme

 | Fillet of beef

Programme running time:

Rare: 36 minutes

Medium: 43 minutes

Well-done: 59 minutes

### Manual

Operating mode: 

Temperature: 180–190 °C

Pre-heating: yes

Duration: 20–30 minutes (Rare),

35–45 minutes (Medium),

50–60 minutes (Well-done)

Shelf level: +HFC 70-C: 1 | -HFC 70-C:

2

# Good to know

---

## Trout

Total time required: 65 minutes

Serves 4

### For the trout

4 trout (250 g each), ready to cook

2 tbsp lemon juice

Salt

Pepper

### For the stuffing

200 g fresh mushrooms

½ onion

1 clove of garlic

25 g parsley

Salt

Pepper

### For dotting

3 tbsp butter

### Accessories

Universal tray

### Preparation

Drizzle the lemon juice over the trout. Season with salt and pepper inside and out.

To make the stuffing, clean the mushrooms. Finely chop the onion, garlic, mushrooms and parsley, and mix well. Season the mixture with salt and pepper.

Start the automatic programme or pre-heat the oven.

Stuff the trout with the filling and place side by side on the universal tray. Dot with small chunks of butter.

Place the universal tray in the oven compartment. Cook the trout.

### Settings

#### Automatic programme

 | Trout

Programme running time: 36 minutes

#### Manual

Operating mode: 

Temperature: 210–220 °C

Pre-heating: yes

Duration: 20–30 minutes

Shelf level: +HFC 70-C: 1 | -HFC 70-C:

2

#### Tip

Serve with slices of lemon and browned butter.

## Salmon fillet

Total time required: 40 minutes

Serves 4

### For the salmon fillet

4 salmon fillets (200 g each), ready to cook

2 tbsp lemon juice

Salt

Pepper

### For dotting

3 tbsp butter

### For sprinkling

1 tsp dill, chopped

### Accessories

Universal tray

### Preparation

Start the automatic programme or pre-heat the oven.

Place the salmon fillets on the universal tray. Drizzle with lemon juice. Season with salt and pepper. Dot the salmon fillets with small chunks of butter and sprinkle with dill.

Place the universal tray in the oven compartment and cook the salmon fillets.

### Settings

#### Automatic programme

 | Salmon fillet

Programme running time: 27 minutes

#### Manual

Operating mode: 

Temperature: 200–210 °C

Pre-heating: yes

Duration: 10–20 minutes

Shelf level: +HFC 70-C: 1 | -HFC 70-C:

2

# Good to know

---

## Salmon trout

Total time required: 65 minutes

Serves 4

### For the salmon trout

1 salmon trout (1 kg), whole, ready to cook

1 lemon | juice only

Salt

### For the stuffing

2 shallots

2 cloves of garlic

2 slices of white bread

50 g small capers

1 egg, medium | yolk only

2 tbsp olive oil

Salt

Pepper

Chilli powder

### Accessories

Wooden skewers

Universal tray

### Preparation

Drizzle the lemon juice over the salmon trout. Season with salt inside and out.

To make the stuffing, finely dice the shallots, garlic and bread. Mix together the capers, egg yolk, olive oil, shallots, garlic and bread. Season with salt, pepper and chilli powder.

Start the automatic programme or pre-heat the oven.

Stuff the salmon trout with the mixture. Seal the opening with small wooden skewers.

Place the salmon trout onto the universal tray and slide into the oven compartment. Cook the salmon trout.

### Settings

#### Automatic programme

 | Salmon trout

Programme running time: 46 minutes

#### Manual

Operating mode: 

Temperature: 210–220 °C

Pre-heating: yes

Duration: 30–40 minutes

Shelf level: +HFC 70-C: 1 | -HFC 70-C:  
2

## Potato and cheese gratin

Total time required: 90 minutes

Serves 4

### For the gratin

600 g potatoes, floury

75 g Gouda, grated

### For the tin

1 clove of garlic

### For the topping

250 ml double cream

1 tsp salt

Pepper

Nutmeg

### For sprinkling

75 g Gouda, grated

### Accessories

Ovenproof dish, Ø 26 cm

Baking and roasting rack

### Preparation

Rub the ovenproof dish with the garlic clove.

To make the topping, mix together the cream, salt, pepper and nutmeg.

Peel the potatoes and cut them into slices 3–4 mm thick. Mix the potatoes with the Gouda and the cream topping, and transfer to the ovenproof dish.

Sprinkle with the Gouda.

Place the potato and cheese gratin on the baking and roasting rack in the oven and cook until golden brown.

### Settings

#### Automatic programme

 | Potato gratin

Programme running time: 50 minutes

### Manual

Operating mode: 

Temperature: 180–190 °C

Pre-heating: no

Duration: 55–65 minutes

Shelf level: +HFC 70-C: 1 | -HFC 70-C:  
2

# Good to know

---

## Lasagne

Total time required: 125 minutes

Serves 4

### For the lasagne

8 lasagne sheets (not pre-cooked)

### For the bolognese sauce

375 g mince, beef

2 onions | diced

800 g tinned tomatoes, skinned

30 g tomato purée

125 ml stock

1 tsp thyme, fresh | chopped

1 tsp oregano, fresh | chopped

1 tsp basil, fresh | chopped

Salt

Pepper

### For the mushroom sauce

20 g butter

1 onion | diced

100 g fresh mushrooms | sliced

2 tbsp plain white flour

250 ml double cream

250 ml milk, whole

Salt

Pepper

Nutmeg

2 tbsp parsley, fresh | chopped

### For sprinkling

200 g Gouda, grated

### Accessories

Ovenproof dish, 32 cm x 22 cm

Baking and roasting rack

### Preparation

To make the bolognese sauce, start by heating a non-stick pan. Fry the minced meat, stirring constantly. Add the onions and sauté them. Chop the tomatoes. Add the tomatoes, tomato

juice, tomato purée and stock. Season with herbs, salt and pepper. Allow to simmer for approx. 5 minutes.

To make the mushroom sauce, sauté the onions in butter. Add the mushrooms and sauté briefly. Sprinkle with flour and stir. Deglaze with the cream and milk. Season with salt, pepper and nutmeg. Allow the sauce to simmer for approximately 5 minutes. Finally, add the parsley.

To make the lasagne, layer up the ingredients in the ovenproof dish in the order listed below:

- One third of the bolognese sauce
- 4 lasagne sheets
- One third of the bolognese sauce
- Half of the mushroom sauce
- 4 lasagne sheets
- One third of the bolognese sauce
- Half of the mushroom sauce

Sprinkle the lasagne with the Gouda, place it on the baking and roasting rack in the oven and cook until golden brown.

### Settings

#### Automatic programme

 | Lasagne

Programme running time: 55 minutes

#### Manual

Operating mode: 

Temperature: 185–195 °C

Pre-heating: no



















Duration: 55–65 minutes





Shelf level: +HFC 70-C: 1 | -HFC 70-C:

1

## Cooking charts

### Creamed mixture























Cakes/biscuits (accessories)		🌡️ [°C]	 <sup>5</sup> <sub>1</sub>		🕒 [min]
			+HFC	-HFC	
Muffins (1 tray)		150–160	1	2	25–35
Muffins (2 trays)		150–160	1+3 <sup>3</sup>	1+3	30–40 <sup>4</sup>
Small cakes (1 tray)		150	1	2	30–40
		160 <sup>2</sup>	2	3	20–30
Small cakes (2 trays)		150 <sup>2</sup>	1+3 <sup>3</sup>	1+3	30–40
Madeira cake (baking and roasting rack, loaf tin, 30 cm) <sup>1</sup>		150–160	1	2	60–70
		155–165 <sup>2</sup>	1	2	60–70
Marble, nut cake (baking and roasting rack, loaf tin, 30 cm) <sup>1</sup>		150–160	1	2	55–65
		150–160	1	2	60–70
Marble, nut cake (baking and roasting rack, ring tin/Bundt cake tin, Ø 26 cm) <sup>1</sup>		150–160	1	2	55–65
		150–160	1	2	60–70
Fresh fruit cake (1 tray)		160–170	1	2	40–50
		160–170	1	1	55–65
Fresh fruit cake (baking and roasting rack, springform cake tin, Ø 26 cm) <sup>1</sup>		150–160	1	2	55–65
		165–175 <sup>2</sup>	1	2	50–60
Flan base (baking and roasting rack, flan base tin, Ø 28 cm) <sup>1</sup>		150–160	1	2	25–35
		170–180 <sup>2</sup>	1	2	15–25





 Operating mode, 🌡️ Temperature, <sup>5</sup><sub>1</sub> Shelf level (+HFC: with FlexiClip runners HFC 70-C / -HFC: without FlexiClip runners HFC 70-C), 🕒 Cooking duration,  Fan plus,  Conventional heat

- <sup>1</sup> Use a dark coloured, matt bakeware and place it centrally on the baking and roasting rack.
- <sup>2</sup> Pre-heat the oven before putting food inside. Do not use the Booster  operating mode for this purpose.
- <sup>3</sup> Fit the FlexiClip runners HFC 70-C (if available) onto the bottom shelf level.
- <sup>4</sup> Take the trays out of the oven early if the food is sufficiently browned before the specified cooking duration has elapsed.

# Good to know



















## Shortcrust pastry





Cakes/biscuits (accessories)		🌡️ [°C]	 <sup>5</sup> 1		🕒 [min]
			+HFC	-HFC	
Biscuits (1 tray)		140–150	1	2	25–35
		150–160	1	2	25–35
Biscuits (2 trays)		140–150	1+3 <sup>3</sup>	1+3	25–35 <sup>4</sup>
Drop cookies (1 tray)		140	1	2	35–45
		160 <sup>2</sup>	2	3	25–35
Drop cookies (2 trays)		140	1+3 <sup>3</sup>	1+3	40–50 <sup>4</sup>
		170–180 <sup>2</sup>	1	2	20–30
Flan base (baking and roasting rack, flan base tin, Ø 28 cm) <sup>1</sup>		150–160	1	2	35–45
		170–180 <sup>2</sup>	1	2	20–30
Cheesecake (baking and roasting rack, springform cake tin, Ø 26 cm) <sup>1</sup>		170–180	1	2	80–90
		150–160	1	2	80–90
Apple pie (baking and roasting rack, springform cake tin, Ø 20 cm) <sup>1</sup>		160	1	2	80–100
		180	–	1	75–85
Apple pie, double crust (baking and roasting rack, springform cake tin, Ø 26 cm) <sup>1</sup>		180–190 <sup>2</sup>	1	2	60–70
		160–170	1	2	60–70
Fresh fruit cake, glazed (baking and roasting rack, springform cake tin, Ø 26 cm) <sup>1</sup>		170–180	1	2	60–70
		150–160	1	2	55–65
Fresh fruit cake, glazed (1 tray)		170–180	1	2	50–60
		160–170	1	2	45–55
Fruit flan (1 tray)		210–220 <sup>2</sup>	–	1	55–65
		180–190	–	1	35–45

 Operating mode, 🌡️ Temperature, <sup>5</sup> Shelf level (+HFC: with FlexiClip runners HFC 70-C / -HFC: without FlexiClip runners HFC 70-C), 🕒 Cooking duration,  Fan plus,  Eco Fan heat,  Conventional heat,  Intensive bake

- <sup>1</sup> Use a dark coloured, matt bakeware and place it centrally on the baking and roasting rack.
- <sup>2</sup> Pre-heat the oven before putting food inside. Do not use the Booster  operating mode for this purpose.
- <sup>3</sup> Fit the FlexiClip runners HFC 70-C (if available) onto the bottom shelf level.
- <sup>4</sup> Take the trays out of the oven early if the food is sufficiently browned before the specified cooking duration has elapsed.

## Yeast dough

Cakes/biscuits (accessories)		🌡️ [°C]	 <sup>5</sup> 1		⌚ [min]
			+HFC	-HFC	
Bundt cake (baking and roasting rack, Bundt cake tin, Ø 24 cm) <sup>1</sup>		150–160	1	2	50–60
		160–170	1	2	50–60
Stollen (1 tray)		150–160	1	2	55–65
		160–170	1	2	55–65
Streusel cake with/without fruit (1 tray)		160–170	1	2	40–50
		170–180	2	3	45–55
Fresh fruit cake (1 tray)		160–170	1	2	45–55
		170–180	2	3	45–55
Apple turnovers/raisin whirls (1 tray)		160–170	1	2	25–35
Apple turnovers/raisin whirls (2 trays)		160–170	1+3 <sup>3</sup>	1+3	30–40 <sup>5</sup>
White bread, free-form (1 tray)		180–190	1	2	35–45
		190–200	1	2	30–40
White bread (baking and roasting rack, loaf tin, 30 cm) <sup>1</sup>		180–190	1	2	35–45
		190–200 <sup>2</sup>	1	2	30–40
Wholegrain bread (baking and roasting rack, loaf tin, 30 cm) <sup>1</sup>		180–190	1	2	55–65
		210–220 <sup>2</sup>	1	2	45–55
Proving yeast dough (baking and roasting rack)		30–35	– <sup>4</sup>	– <sup>4</sup>	–

 Operating mode, 🌡️ Temperature, <sup>5</sup> Shelf level (+HFC: with FlexiClip runners HFC 70-C / -HFC: without FlexiClip runners HFC 70-C), ⌚ Cooking duration,  Fan plus,  Conventional heat

- <sup>1</sup> Use a dark coloured, matt bakeware and place it centrally on the baking and roasting rack.
- <sup>2</sup> Pre-heat the oven before putting food inside. Do not use the Booster  operating mode for this purpose.
- <sup>3</sup> Fit the FlexiClip runners HFC 70-C (if available) onto the bottom shelf level.
- <sup>4</sup> Place the baking and roasting rack on the floor of the oven and stand the bowl containing the dough on the rack. Depending on the size of the bowl, you may need to remove the side runners.
- <sup>5</sup> Take the trays out of the oven early if the food is sufficiently browned before the specified cooking duration has elapsed.

## Good to know

### Quark dough

Cakes/biscuits (accessories)		🌡️ [°C]	<sup>5</sup> <sub>1</sub>		🕒 [min]
			+HFC	-HFC	
Fresh fruit cake (1 tray)		160–170	1	2	40–50
		170–180	2	3	50–60
Apple turnovers/raisin whirls (1 tray)		160–170	2	3	25–35
Apple turnovers/raisin whirls (2 trays)		150–160	1+3 <sup>1</sup>	1+3	25–35 <sup>2</sup>

Operating mode, 🌡️ Temperature, <sup>5</sup><sub>1</sub> Shelf level (+HFC: with FlexiClip runners HFC 70-C / -HFC: without FlexiClip runners HFC 70-C), 🕒 Cooking duration, Fan plus, Conventional heat

<sup>1</sup> Fit the FlexiClip runners HFC 70-C (if available) onto the bottom shelf level.

<sup>2</sup> Take the trays out of the oven early if the food is sufficiently browned before the specified cooking duration has elapsed.

### Sponge mixture









Cakes/biscuits (accessories)		🌡️ [°C]	<sup>5</sup> <sub>1</sub>		🕒 [min]
			+HFC	-HFC	
Sponge cake base (2 eggs) (baking and roasting rack, springform cake tin, Ø 26 cm) <sup>1</sup>		160–170 <sup>2</sup>	1	2	15–25
Sponge cake base (4–6 eggs) (baking and roasting rack, springform cake tin, Ø 26 cm) <sup>1</sup>		150–160 <sup>2</sup>	1	2	30–40
Whisked sponge (baking and roasting rack, springform cake tin, Ø 26 cm) <sup>1</sup>		180 <sup>2</sup>	1	2	20–30
		150–170 <sup>2</sup>	1	2	25–45
Swiss roll sponge (1 tray)		180–190 <sup>2</sup>	1	2	10–20

Operating mode, 🌡️ Temperature, <sup>5</sup><sub>1</sub> Shelf level (+HFC: with FlexiClip runners HFC 70-C / -HFC: without FlexiClip runners HFC 70-C), 🕒 Cooking duration, Fan plus, Conventional heat

<sup>1</sup> Use a dark coloured, matt bakeware and place it centrally on the baking and roasting rack.

<sup>2</sup> Pre-heat the oven before putting food inside. Do not use the Booster operating mode for this purpose.

## Choux pastry, puff pastry, meringue

Cakes/biscuits (accessories)		🌡️ [°C]	 <sup>5</sup> 1		🕒 [min]
			+HFC	-HFC	
Choux buns (1 tray)		160–170	1	2	30–40
Pastry puffs (1 tray)		180–190	1	2	20–30
Pastry puffs (2 trays)		180–190	1+3 <sup>1</sup>	1+3	20–30 <sup>2</sup>
Macaroons (1 tray)		120–130	1	2	25–50
Macaroons (2 trays)		120–130	1+3 <sup>1</sup>	1+3	25–50 <sup>2</sup>
Meringues/pavlovas (1 tray of 6, each Ø 6 cm)		80–100	1	2	120–150
Meringues/pavlovas (2 trays of 6, each Ø 6 cm)		80–100	1+3 <sup>1</sup>	1+3	150–180

 Operating mode, 🌡️ Temperature, <sup>5</sup> Shelf level (+HFC: with FlexiClip runners HFC 70-C / -HFC: without FlexiClip runners HFC 70-C), 🕒 Cooking duration,  Fan plus

<sup>1</sup> Fit the FlexiClip runners HFC 70-C (if available) onto the bottom shelf level.

<sup>2</sup> Take the trays out of the oven early if the food is sufficiently browned before the specified cooking duration has elapsed.

# Good to know

















## Savoury dishes









Food (accessories)		🌡️ [°C]			🕒 [min]
			+HFC	-HFC	
Savoury flan (1 tray)		220–230 <sup>2</sup>	–	1	35–45
		180–190	–	1	30–40
Onion tart (1 tray)		180–190 <sup>2</sup>	1	2	25–35
		170–180	1	2	30–40
Pizza, yeast dough (1 tray)		170–180	1	2	25–35
		210–220 <sup>2</sup>	1	2	20–30
Pizza, quark dough (1 tray)		170–180	1	2	25–35
		190–200 <sup>2</sup>	1	2	25–35
Frozen pizza, pre-cooked (baking and roasting rack)		200–210	1	2	20–25
Toast (baking and roasting rack)		300	–	3	6–9
Baked dishes/gratins, e.g. toast (baking and roasting rack on universal tray)		275 <sup>3</sup>	2	3	3–6
Grilled vegetables (baking and roasting rack on universal tray)		275 <sup>3</sup>	3	4	5–10 <sup>4</sup>
		250 <sup>3</sup>	3	3	5–10 <sup>4</sup>
Ratatouille (1 universal tray)		180–190	1	2	40–60
French fries, frozen <sup>1</sup> (Gourmet baking and AirFry tray, perforated)		180–190	2	3	30–35 <sup>4</sup>
Potato croquettes, frozen <sup>1</sup> (Gourmet baking and AirFry tray, perforated)		180–190	2	3	23–25 <sup>4</sup>



Operating mode, 🌡️ Temperature, Shelf level (+HFC: with FlexiClip runners HFC 70-C / -HFC: without FlexiClip runners HFC 70-C), 🕒 Cooking duration, Conventional heat, Intensive bake, Fan plus, Eco Fan heat, Full grill, Fan grill, | Further | AirFry

- Follow the manufacturer's instructions on the packaging.
- Pre-heat the oven before putting food inside. Do not use the Booster operating mode for this purpose.
- Pre-heat the oven for 5 minutes before putting food inside. Do not use the Booster operating mode for this purpose.
- If possible, turn the food halfway through the cooking duration.

## Beef















Food (accessories)		 [°C]	 <sup>5</sup> <sub>1</sub>	 [min]	 <sup>10</sup> [°C]
Braised beef, approx. 1 kg (oven dish with lid)	 <sup>2</sup>	150–160 <sup>3</sup>	2 <sup>6</sup>	120–130 <sup>7</sup>	–
	 <sup>2</sup>	170–180 <sup>3</sup>	2 <sup>6</sup>	120–130 <sup>7</sup>	–
	 <sup>2</sup>	180–190	2 <sup>6</sup>	160–180 <sup>8</sup>	–
Fillet of beef, approx. 1 kg (universal tray)	 <sup>2</sup>	180–190 <sup>3</sup>	2 <sup>6</sup>	25–60	45–75
Fillet of beef (rare), approx. 1 kg <sup>1</sup>	 <sup>2</sup>	80–85 <sup>4</sup>	2 <sup>6</sup>	70–80	45–48
Fillet of beef (medium), approx. 1 kg <sup>1</sup>	 <sup>2</sup>	90–95 <sup>4</sup>	2 <sup>6</sup>	80–90	54–57
Fillet of beef (well done), approx. 1 kg <sup>1</sup>	 <sup>2</sup>	95–100 <sup>4</sup>	2 <sup>6</sup>	110–130	63–66
Roast beef, approx. 1 kg (universal tray)	 <sup>2</sup>	180–190 <sup>3</sup>	2 <sup>6</sup>	35–65	45–75
Roast beef (rare), approx. 1 kg <sup>1</sup>	 <sup>2</sup>	80–85 <sup>4</sup>	2 <sup>6</sup>	80–90	45–48
Roast beef (medium), approx. 1 kg <sup>1</sup>	 <sup>2</sup>	90–95 <sup>4</sup>	2 <sup>6</sup>	110–120	54–57
Roast beef (well done), approx. 1 kg <sup>1</sup>	 <sup>2</sup>	95–100 <sup>4</sup>	2 <sup>6</sup>	130–140	63–66
Burger, meat patties (baking and roasting rack on shelf level 4 and universal tray on shelf level 1)		300 <sup>5</sup>	4	15–25 <sup>9</sup>	–

 Operating mode,  Temperature,  <sup>5</sup><sub>1</sub> Shelf level,  Cooking duration,  Core temperature,  Fan plus,  Conventional heat,  Eco Fan heat,  Full grill

- <sup>1</sup> Use the baking and roasting rack and universal tray.
- <sup>2</sup> Sear the meat on the hob first.
- <sup>3</sup> Pre-heat the oven before putting food inside. Do not use the Booster  operating mode for this purpose.
- <sup>4</sup> Pre-heat the oven at 120 °C for 15 minutes. Reduce the temperature when you place the food in the oven.
- <sup>5</sup> Pre-heat the oven for 5 minutes before putting food inside. Do not use the Booster  operating mode for this purpose.
- <sup>6</sup> Fit the FlexiClip runners HFC 70-C (if available).
- <sup>7</sup> Roast with the lid on to start with. Remove the lid 90 minutes into the cooking duration and add approx. 0.5 litres of liquid.
- <sup>8</sup> Roast with the lid on to start with. Remove the lid 100 minutes into the cooking duration and add approx. 0.5 litres of liquid.
- <sup>9</sup> Turn the food halfway through cooking.
- <sup>10</sup> If you are using a food probe, you can use the core temperature shown.

## Good to know











### Veal







Food (accessories)		 [°C]	 <sup>5</sup> <sub>1</sub>	 [min]	 <sup>7</sup> [°C]
Braised veal, approx. 1.5 kg (oven dish with lid)	 <sup>2</sup>	160–170 <sup>3</sup>	2 <sup>5</sup>	120–130 <sup>6</sup>	–
	 <sup>2</sup>	170–180 <sup>3</sup>	2 <sup>5</sup>	120–130 <sup>6</sup>	–
Fillet of veal, approx. 1 kg (universal tray)	 <sup>2</sup>	160–170 <sup>3</sup>	2 <sup>5</sup>	30–60	45–75
Fillet of veal (pink), approx. 1 kg <sup>1</sup>	 <sup>2</sup>	80–85 <sup>4</sup>	2 <sup>5</sup>	50–60	45–48
Fillet of veal (medium), approx. 1 kg <sup>1</sup>	 <sup>2</sup>	90–95 <sup>4</sup>	2 <sup>5</sup>	80–90	54–57
Fillet of veal (well done), approx. 1 kg <sup>1</sup>	 <sup>2</sup>	95–100 <sup>4</sup>	2 <sup>5</sup>	90–100	63–66
Saddle of veal (pink), approx. 1 kg <sup>1</sup>	 <sup>2</sup>	80–85 <sup>4</sup>	2 <sup>5</sup>	80–90	45–48
Saddle of veal (medium), approx. 1 kg <sup>1</sup>	 <sup>2</sup>	90–95 <sup>4</sup>	2 <sup>5</sup>	100–130	54–57
Saddle of veal (well done), approx. 1 kg <sup>1</sup>	 <sup>2</sup>	95–100 <sup>4</sup>	2 <sup>5</sup>	130–140	63–66

 Operating mode,  Temperature,  <sup>5</sup><sub>1</sub> Shelf level,  Cooking duration,  Core temperature,  Fan plus,  Conventional heat

- <sup>1</sup> Use the baking and roasting rack and universal tray.
- <sup>2</sup> Sear the meat on the hob first.
- <sup>3</sup> Pre-heat the oven before putting food inside. Do not use the Booster  operating mode for this purpose.
- <sup>4</sup> Pre-heat the oven at 120 °C for 15 minutes. Reduce the temperature when you place the food in the oven.
- <sup>5</sup> Fit the FlexiClip runners HFC 70-C (if available).
- <sup>6</sup> Roast with the lid on to start with. Remove the lid 90 minutes into the cooking duration and add approx. 0.5 litres of liquid.
- <sup>7</sup> If you are using a food probe, you can use the core temperature shown.

## Lamb, game



















Food (accessories)		 [°C]	 <sup>5</sup>	 [min]	 <sup>6</sup> [°C]
Leg of lamb on the bone, approx. 1.5 kg (oven dish with lid)		170–180	2 <sup>4</sup>	100–120 <sup>5</sup>	64–82
Saddle of lamb, off the bone (universal tray)		180–190 <sup>2</sup>	2 <sup>4</sup>	10–20	53–80
Saddle of lamb, off the bone (baking and roasting rack and universal tray)		95–105 <sup>3</sup>	2 <sup>4</sup>	40–60	54–66
Saddle of venison, off the bone (universal tray)		160–170 <sup>2</sup>	2 <sup>4</sup>	70–90	60–81
Roebuck saddle, off the bone (universal tray)		140–150 <sup>2</sup>	2 <sup>4</sup>	25–35	60–81











 Operating mode,  Temperature, <sup>5</sup> Shelf level,  Cooking duration, <sup>6</sup> Core temperature,  Conventional heat



- <sup>1</sup> Sear the meat on the hob first.
- <sup>2</sup> Pre-heat the oven before putting food inside. Do not use the Booster  operating mode for this purpose.
- <sup>3</sup> Pre-heat the oven at 120 °C for 15 minutes. Reduce the temperature when you place the food in the oven.
- <sup>4</sup> Fit the FlexiClip runners HFC 70-C (if available).
- <sup>5</sup> Roast with the lid on to start with. Remove the lid 50 minutes into the cooking duration and add approx. 0.5 litres of liquid.
- <sup>6</sup> If you are using a food probe, you can use the core temperature shown.

# Good to know

## Poultry, fish

Food (accessories)		 [°C]	 <sup>5</sup> <sub>1</sub>	 [min]	 <sup>8</sup> [°C]
Poultry, 0.8–1.5 kg (universal tray)		170–180	2 <sup>4</sup>	55–65	85–90
Chicken, approx. 1.2 kg (baking and roasting rack on universal tray)		180–190 <sup>2</sup>	2 <sup>4</sup>	55–65 <sup>5</sup>	85–90
Poultry, approx. 2 kg (oven dish)		180–190	2 <sup>4</sup>	100–120 <sup>6</sup>	85–90
		190–200	2 <sup>4</sup>	110–130 <sup>6</sup>	85–90
Poultry, approx. 4 kg (oven dish)		160–170	2 <sup>4</sup>	180–200 <sup>7</sup>	90–95
		180–190	2 <sup>4</sup>	180–200 <sup>7</sup>	90–95
Chicken thighs (grilling and roasting insert on universal tray)	   	190–200	2 <sup>4</sup>	30–35	–
Fish, 200–300 g, e.g. trout (universal tray)		210–220 <sup>3</sup>	2 <sup>4</sup>	15–25	75–80
Fish, 1–1.5 kg, e.g. salmon trout (universal tray)		210–220 <sup>3</sup>	2 <sup>4</sup>	30–40	75–80
Fish fillet in foil, 200–300 g (universal tray)		200–210	2 <sup>4</sup>	25–30	75–80
Fish fingers, frozen <sup>1</sup> (Gourmet baking and AirFry tray, perforated)	   	220–230	2 <sup>4</sup>	13–15 <sup>5</sup>	–

 Operating mode,  Temperature,  <sup>5</sup><sub>1</sub> Shelf level,  Cooking duration,  <sup>8</sup> Core temperature,  Fan plus,  Fan grill,  Conventional heat,  Eco Fan heat,  |  Further | AirFry

- <sup>1</sup> Follow the manufacturer's instructions on the packaging.
- <sup>2</sup> Pre-heat the oven for 5 minutes before putting food inside. Do not use the Booster  operating mode for this purpose.
- <sup>3</sup> Pre-heat the oven before putting food inside. Do not use the Booster  operating mode for this purpose.
- <sup>4</sup> Fit the FlexiClip runners HFC 70-C (if available).
- <sup>5</sup> If possible, turn the food halfway through the cooking duration.
- <sup>6</sup> Add approx. 0.25 litres of liquid at the start of the cooking process.
- <sup>7</sup> Add approx. 0.5 litres of liquid after 30 minutes.
- <sup>8</sup> If you are using a food probe, you can use the core temperature shown.

 Danger of injury caused by hot surfaces.

The oven gets hot during operation. You could burn yourself on the heating elements, oven compartment or accessories.

Allow the heating elements, oven compartment and the accessories to cool before manual cleaning.

 Risk of injury due to electric shock.

The steam from a steam cleaning appliance could reach live electrical components and cause a short circuit.

Never use a steam cleaner for cleaning.

Failure to maintain the oven in a clean condition could lead to deterioration of the surface that could adversely affect the life of the appliance and possibly result in a hazardous situation.

Surfaces can discolour or alter if unsuitable cleaning agents are used.

The oven front is particularly susceptible to damage from oven cleaners or descaling agents.

All surfaces are susceptible to scratching. Scratches on glass can in some circumstances lead to breakage.

Remove all cleaning agent residues immediately.

### Unsuitable cleaning agents

To avoid damaging the surfaces, do not use the following cleaning agents:

- Cleaning agents containing soda, ammonia, acids or chlorides
- Cleaning agents containing descaling agents on the front
- Abrasive cleaning agents (e.g. powder cleaners, scouring milk, scouring pads)
- Solvent-based cleaning agents
- Stainless steel cleaners
- Dishwasher cleaning agents
- Glass cleaner on matt surfaces
- Cleaning agents for ceramic glass hobs
- Hard, abrasive brushes or sponges (e.g. pot scourers, brushes or sponges which have been previously used with abrasive cleaning agents)
- Eraser stain remover blocks
- Sharp metal scrapers (e.g. metal spatula)
- Steel wool
- Stainless steel spiral pads on matt surfaces and FlexiClip runners
- Oven cleaners
- Spot cleaning with mechanical cleaning agents

The accessories are not dishwasher-safe.

**Tip:** Soiling caused by spilt fruit juices and cake mixtures is best removed while the oven compartment is still warm.

# Cleaning and care

## Removing or taking out accessories

Accessories will be damaged by the high temperatures in pyrolytic cleaning.

Remove all accessories from the oven before starting the pyrolytic cleaning programme. This also applies to the side runners, the FlexiClip runners, the rack and other optional accessories.

We recommend removing the accessories from the oven compartment for easier manual cleaning.

- Remove the side runners and the FlexiClip runners (if fitted).
- Remove all accessories from the oven compartment.

## Cleaning the front

- Clean the appliance front with a clean, soft sponge and a solution of warm water and washing-up liquid.
- After cleaning, wipe the front dry using a soft cloth.

**Tip:** A clean, damp microfibre cloth without detergent can also be used.

## Oven compartment

### Cleaning the oven compartment manually

Instead of using the Pyrolytic  function, you can clean the oven compartment manually depending on the degree of soiling.

Removing the door, the accessories and the side runners makes it easier to clean the oven compartment.

 Risk of injury caused by hot surfaces.

The oven gets hot during operation. You could burn yourself on the heater elements, oven compartment or accessories.

Allow the heater element, oven compartment, and accessories to cool down.

There is a delicate fibreglass seal around the oven compartment which seals the inside of the glass oven door and can be damaged by rubbing and scouring.

Avoid cleaning the fibreglass seal.

- Ideally, remove soiling immediately with warm water, washing-up liquid and a clean sponge cloth or a clean, damp microfibre cloth.
- If necessary, use the abrasive side of a dishwashing sponge to remove baked-on soiling. You can also use a glass scraper or a stainless steel spiral pad (e.g. Spontex Spirinett).
- Remove all cleaning agent residues thoroughly with clean water.
- After cleaning, wipe the surfaces dry using a soft cloth.

### Cleaning the oven compartment by means of Pyrolytic

Instead of manually, you can clean the oven compartment with the Pyrolytic  function depending on the degree of soiling.

Accessories will be damaged by the high temperatures in pyrolytic cleaning.

Remove all accessories from the oven before starting the pyrolytic cleaning programme. This also applies to the side runners and any optional accessories.

Coarse soiling in the oven compartment can cause thick smoke to develop.

Burnt-on residues can cause lasting discolouration or matt spots on enamelled surfaces.

Before starting the pyrolytic cleaning programme, remove coarse soiling from the oven compartment and scrape any burnt-on residues off enamelled surfaces with a glass scraper.

- Remove any accessories from the oven compartment, including the side runners.

### Starting pyrolytic cleaning

 Risk of injury caused by hazardous steam.

During pyrolytic cleaning, steam, which can irritate mucous membranes, can be released.

During pyrolytic cleaning, do not stay in the kitchen for longer periods of time and do not let children and pets enter the kitchen.

It is important to ensure that the kitchen is well ventilated during pyrolytic cleaning. Prevent the odour from escaping into other rooms.

 Risk of injury caused by hot surfaces.

The oven gets much hotter during pyrolytic cleaning than during normal use.

Do not let children touch the oven during pyrolytic cleaning.

- Select Pyrolytic .
- Select the level required according to the amount of soiling.
- Confirm with *OK*.

Follow the instructions in the display.

- Confirm with *OK*.

You can start the pyrolytic cleaning programme straight away or delay the start time.

### Starting pyrolytic cleaning straight away

- To start the pyrolytic cleaning programme straight away, select *Start now*.
- Confirm with *OK*.

The pyrolytic cleaning programme will start.

The door will lock automatically. The oven heating and the cooling fan will then switch on automatically.

The oven interior lighting will not come on during the pyrolytic cleaning programme.

The time left for the pyrolytic cleaning programme will start counting down in the display. You cannot alter the duration.

You can use the minute minder at the same time as running the cleaning programme. At the end of the minute minder time the buzzer will sound,  will start flashing and the time can be

# Cleaning and care

viewed counting up in the display. When you touch the  sensor control, the acoustic and optical signals are switched off.

## Starting pyrolytic cleaning at a later time

- To start the pyrolytic cleaning programme later, select *Start at*.
- Confirm with *OK*.
- Set the time at which pyrolytic cleaning should start.
- Confirm with *OK*.

The door will lock automatically. *Start at* and the start time set will appear in the display.

You can reset the start time via the  sensor control at any point up to the starting time.

As soon as the start time has been reached, the oven heating and cooling fan will switch on automatically and the time left will appear in the display.

## Finishing off the pyrolytic cleaning process

When the time remaining has counted down to 0:00 h, a message will appear in the display to tell you that the door is unlocking.

*Process finished* will appear in the display and a buzzer will sound as soon as the door has been unlocked.

- Switch the oven off.

The visual and acoustic signals will switch off.

 Risk of injury caused by hot surfaces.

At the end of the pyrolytic cleaning function, the oven will still be very hot. You could burn yourself on the heater elements and oven compartment.

Allow the heater elements and the oven compartment temperature to drop to a safe level before removing any residues.

- Clean the oven compartment to remove any pyrolytic residues (e.g. ash) that may have built up depending on the degree of soiling in the oven.

Most residues can be removed with hot water, a little washing-up liquid and a clean sponge or a clean, damp microfibre cloth.

Depending on the degree of soiling, a visible deposit could build up on the glass on the inside of the oven door. This can be removed with a dishwashing sponge, a glass scraper or a stainless steel spiral pad (e.g. Spontex Spirinett) and a little washing-up liquid.

There is a delicate fibreglass seal around the oven compartment to seal the glass in the oven door. This can be damaged by rubbing or scouring.

Avoid cleaning the fibreglass seal.

Enamelled surfaces can be permanently discoloured by spilt fruit juices. Such discolouration does not affect the properties of the enamel.

Do not attempt to remove these stains.

## Pyrolytic cleaning interrupted

If pyrolytic cleaning is cancelled, the oven door will remain locked until the temperature inside the oven drops to below 280 °C.

The following events will cause the pyrolytic cleaning programme to stop:

- Turn the operating mode selector to another operating mode or to the **0** position.

Turn the operating mode selector to Pyrolytic cleaning  again, if you want to start the pyrolytic cleaning programme anew.

- Turn the operating mode selector to a different operating mode.

If you use another operating mode, the oven temperature must have fallen below 280 °C. During this time, *Cooling down* will appear in the display.

- There has been a power cut.

When power is restored, *Process cancelled* will appear until the oven compartment temperature has fallen below 280 °C. The door is then unlocked.

- Confirm with *OK* if you want to start the pyrolytic cleaning programme again. Then you can select the pyrolytic cleaning programme you want and start it again.

## Side runners

We recommend removing the side runners for easier manual cleaning.

### Removing and installing side runners

The side runners can be removed together with the FlexiClip runners (if inserted).

You can remove the FlexiClip runners separately beforehand.

 Risk of injury caused by hot surfaces.

The oven gets hot during operation. You could burn yourself on the heater elements, oven compartment or accessories.

Allow the heater element, oven compartment, and accessories to cool down.

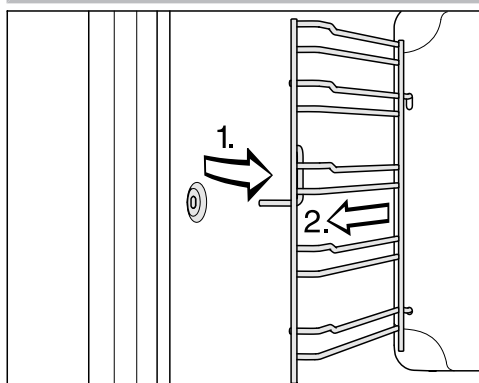

- Pull the side runners out of holder (1.) from the front and remove them (2.).
- Re-install the side runners in reverse order.
- Refit the FlexiClip runners (if used).

### Cleaning the side runners

Spilt fruit and roasting juices may cause lasting discolouration or matt patches on surfaces. This discolouration will not affect the properties of the surface finish.

Do not attempt to remove these stains. Only use the equipment specified.

# Cleaning and care

Prerequisite: The side runners have been removed.

- Ideally, remove soiling immediately with warm water, washing-up liquid and a clean sponge cloth or a clean, damp microfibre cloth.
- If necessary, use the abrasive side of a dishwashing sponge to remove baked-on soiling. With the exception of FlexiClip runners, you can also use a glass scraper or a stainless steel spiral pad (e.g. Spontex Spirinett).
- Remove all cleaning agent residues thoroughly with clean water.
- After cleaning, wipe the surfaces dry using a soft cloth.

## FlexiClip runners

We recommend removing the FlexiClip runners for easier manual cleaning.

### Cleaning the FlexiClip runners

 Risk of injury caused by hot surfaces.

The oven gets hot during operation. You could burn yourself on the heater elements, oven compartment or accessories.

Allow the heater element, oven compartment, and accessories to cool down.

Spilt fruit and roasting juices may cause lasting discolouration or matt patches on surfaces. This discolouration will not affect the properties of the surface finish. Do not attempt to remove these stains. Only use the equipment specified.

Prerequisite: the FlexiClip runners have been removed.

- Ideally, remove soiling immediately with warm water, washing-up liquid and a clean sponge cloth or a clean, damp microfibre cloth.
- If necessary, use the abrasive side of a dishwashing sponge to remove baked-on soiling. Do not use stainless steel spiral pads, as these can scratch the surfaces.
- Remove all cleaning agent residues thoroughly with clean water.
- After cleaning, wipe the surfaces dry using a soft cloth.

Do not clean FlexiClip runners in a dishwasher. The special lubricant used in the telescopic runners will wash out during dishwashing. Never clean FlexiClip runners in a dishwasher.

**Tip:** For stubborn surface soiling or if the bearings become sticky, proceed as follows:

- Soak the FlexiClip runners briefly (approx. 10 minutes) in a solution of hot water and washing-up liquid. You can use the scouring pad on the back of a washing-up sponge if necessary. You can clean the bearings with a soft brush.

After cleaning, discolorations or lighter areas may remain on the runners. This will not affect performance in any way.

## Baking and roasting rack

We recommend removing the rack from the oven compartment for easier manual cleaning.

## Cleaning the rack

 Risk of injury caused by hot surfaces.

The oven gets hot during operation. You could burn yourself on the heater elements, oven compartment or accessories.

Allow the heater element, oven compartment, and accessories to cool down.

Spilt fruit and roasting juices may cause lasting discolouration or matt patches on surfaces. This discolouration will not affect the properties of the surface finish. Do not attempt to remove these stains. Only use the equipment specified.

Prerequisite: the rack has been removed from the oven compartment.

- Ideally, remove soiling immediately with warm water, washing-up liquid and a clean sponge cloth or a clean, damp microfibre cloth.
- If necessary, use the abrasive side of a dishwashing sponge to remove baked-on soiling. You can also use a glass scraper or a stainless steel spiral pad (e.g. Spontex Spirinett).
- Remove all cleaning agent residues thoroughly with clean water.
- After cleaning, wipe the surfaces dry using a soft cloth.

## Baking trays and bakeware

We recommend removing baking trays and bakeware from the oven compartment for easier cleaning.

## Cleaning baking trays and bakeware with PerfectClean surfaces

Prerequisite: the baking trays and bakeware have been removed from the oven compartment.

 Risk of injury caused by hot surfaces.

The oven gets hot during operation. You could burn yourself on the heater elements, oven compartment or accessories.

Allow the heater element, oven compartment, and accessories to cool down.

Damage to PerfectClean surfaces. Cleaning in a dishwasher can damage PerfectClean surfaces.

**Never** clean PerfectClean accessories in a dishwasher.

Adverse effect on non-stick properties.

The non-stick properties of PerfectClean surfaces can be adversely affected by residues of cleaning agents and food.

Always remove all residues from PerfectClean surfaces.

- Ideally, remove soiling immediately with warm water, washing-up liquid and a clean sponge cloth or a clean, damp microfibre cloth.
- If necessary, use the abrasive side of a dishwashing sponge to remove baked-on soiling.

## Cleaning and care

You can also use a glass scraper or a stainless steel spiral pad (e.g. Spontex Spirinett).

- Remove all cleaning agent residues thoroughly with clean water.
- After cleaning, wipe the surfaces dry using a soft cloth.

### Gourmet baking and pizza stone

We recommend removing the Gourmet baking and pizza stone from the oven compartment for easier cleaning.

#### Cleaning the Gourmet baking and pizza stone and wooden paddle



Risk of injury caused by hot surfaces.

The Gourmet baking and pizza stone gets hot during operation and stores the heat.

You can burn yourself on the Gourmet baking and pizza stone.

Allow the Gourmet baking and pizza stone to cool down in the oven compartment before cleaning manually.

Large differences in temperature can damage the Gourmet baking and pizza stone.

Do not place the hot Gourmet baking and pizza stone on cold surfaces such as tile or stone.

Do not clean the hot Gourmet baking and pizza stone in cold water.

Cleaning in a dishwasher or using a pyrolytic cleaning process can damage the Gourmet baking and pizza stone.

Always clean the Gourmet baking and pizza stone manually.

Do not clean the wooden paddle in the dishwasher or leave it in water for a long time as this will damage it.

This would cause the wood to swell and warp.

Because the wooden paddle is made from untreated wood, it can suffer noticeable discolouration from oils and toppings such as tomato sauce.

Rinse the wooden paddle briefly and then dry it.

Prerequisite: the Gourmet baking and pizza stone has been removed from the oven compartment.

- Clean the Gourmet baking and pizza stone and the wooden paddle with warm water and washing-up liquid.
- Dry all surfaces with a clean cloth.

#### Tips

- It is best to remove baked-on residues with a glass scraper or after soaking. You can soak the Gourmet baking and pizza stone in hot water with some white vinegar. Because the underside is not glazed, oils or toppings such as tomato sauce can leave noticeable discolouration.
- Matt areas, caused by the oils in cheese, for example, can be removed using a suitable cream cleaner.

### Gourmet oven dish with lid

We recommend removing the Gourmet oven dish with lid from the oven compartment for easier cleaning.

## Cleaning the Gourmet oven dish

⚠ Risk of injury caused by hot surfaces.

The oven gets hot during operation. You could burn yourself on the heater elements, oven compartment or accessories.

Allow the heater element, oven compartment, and accessories to cool down.

Abrasive or aggressive cleaning agents such as barbecue and oven sprays, stain and rust removers, scouring sponges, sponges with a scratchy surface or sharp objects. can damage the non-stick coating. Only clean the oven dish with hot washing-up liquid and a soft brush or sponge. Stubborn soiling can be removed by soaking with detergent solution.

Precondition: the Gourmet oven dish has been removed from the oven compartment.

- Clean the oven dish with hot washing-up liquid and a soft brush or sponge.
- Clean the lid (if there is one) with a soft cloth, warm water and washing-up liquid.

**Tip:** You can also clean the oven dish and lid (if there is one) in a dishwasher. Under certain circumstances, this may result in spotting on the base of the oven dish. However, this will not affect functionality.

## Door

The door weighs approx. 10 kg.

The oven door is an open system with 4 glass panes which have a heat-reflective coating on some of their surfaces.

When the oven is operating, air is directed through the door to keep the outer panel cool.

To clean the door panels, proceed as follows:

1. Remove the door
2. Dismantle the door
3. Clean the door panels
4. Assemble the door
5. Fit the door

## Removing the door

⚠ Risk of injury caused by hot surfaces.

The oven gets hot during operation. You could burn yourself on hot surfaces.

Allow the oven to cool down before removing the door.

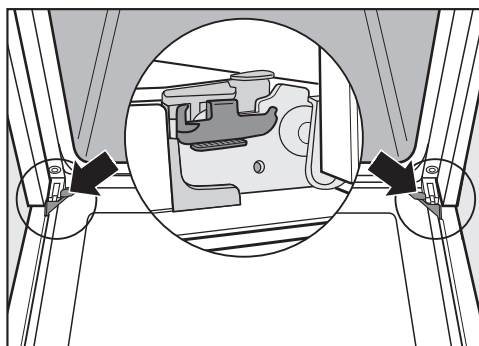

The oven door is connected to the door hinges by retainers.

Before removing the door from the retainers, the locking clamps on both door hinges have to be released.

- Open the door fully.

## Cleaning and care

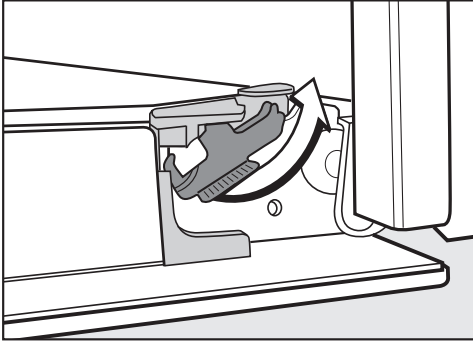

- Release the locking clamps by turning them as far as they will go.

The oven could become damaged if you incorrectly remove the door. Never pull the door horizontally off its retainers, as they will spring back against the oven.

Never pull the door off the retainers by the handle, as the handle could break off.

- Raise the door up until it rests partially open.

The door weighs approx. 10 kg.

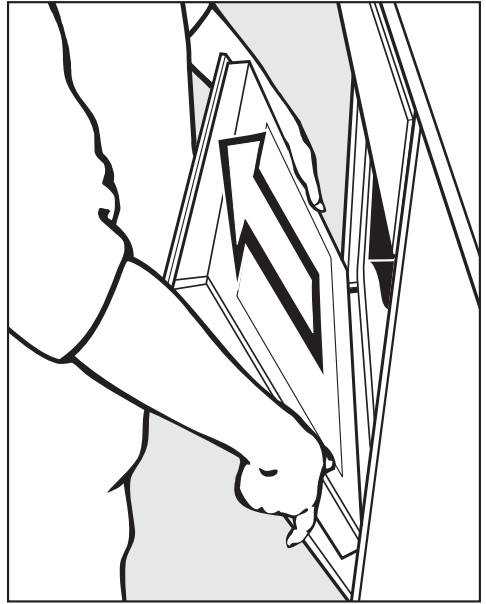

- Hold the door on either side and pull it diagonally upwards off the retainers. Make sure that the door is straight.

### Dismantling the door

The oven door is an open system with 4 glass panes which have a heat-reflective coating on some of their surfaces.

When the oven is operating, air is directed through the door to keep the outer pane cool.

If soiling has worked its way in between the glass panes, the door can be dismantled in order to clean in between the panes.

Scratches on the door glass can cause the glass to break.

Do not use abrasive cleaners, hard sponges, brushes or sharp metal tools to clean the door glass.

When cleaning the door glass, you must also follow the instructions that apply to the oven front.

## Cleaning and care

The different sides of the door glass have different coatings. The sides facing the oven compartment have heat-reflecting properties. The oven could become damaged if you fit the door glass the wrong way round.

Make sure that you place the door glass back in the right position after cleaning.

Oven cleaners will damage the surface of the aluminium profiles. Only clean these parts with warm water and washing-up liquid, applied with a clean sponge cloth or a clean, damp microfibre cloth.

The door glass could break if dropped.

Keep the disassembled door glass in a safe place.

 Risk of injury caused by the door slamming shut.

The door may slam shut if you attempt to disassemble it when it is fitted to the oven.

Always remove the door before disassembling it.

- Place the door with the outer glass pane on a soft surface (e.g. a tea towel) to prevent it getting scratched. The door handle should line up with the edge of the table so that the glass lies flat and does not get broken during cleaning.

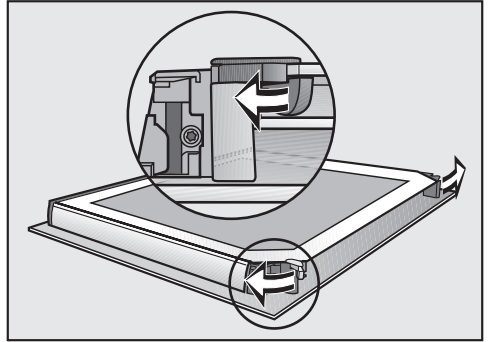

- Flip the two glass pane retainers outwards to open them.

Remove the inner pane and the two middle panes one after the other:

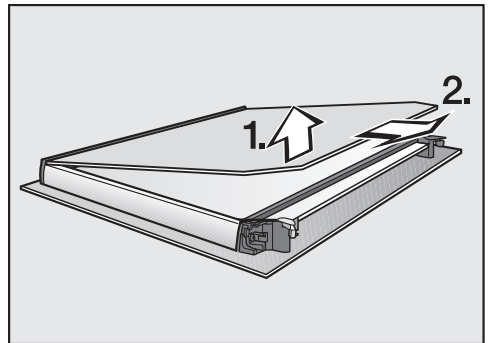

- **Gently** lift the inner pane up and out of the plastic strip.

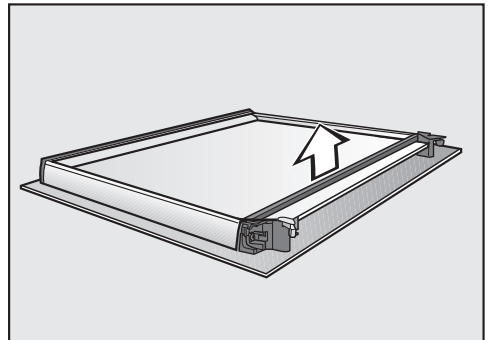

- Remove the seal.

## Cleaning and care

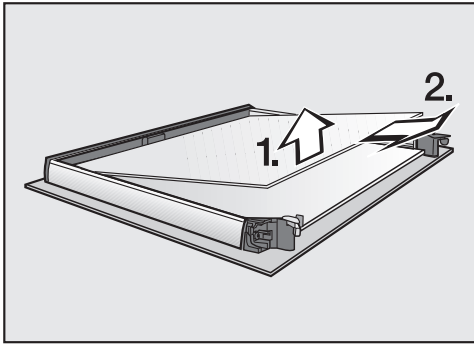

- Carefully lift the upper of the two middle panes up and take it out.

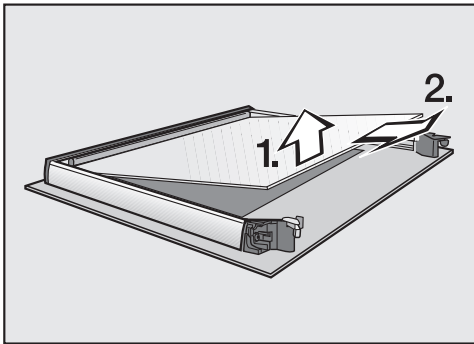

- Then lift the lower of the two middle panes up carefully and take it out.
- Clean the door panes and other parts with a clean sponge and a solution of hot water and washing-up liquid or a clean, damp microfibre cloth.
- Dry all parts with a soft cloth.

Then reassemble the door carefully:

The two middle panes are identical. To help you put them back in correctly, the material number is printed on the panes.

- Refit the lower of the two middle panes in such a way that the material number is legible (i.e. not reversed).

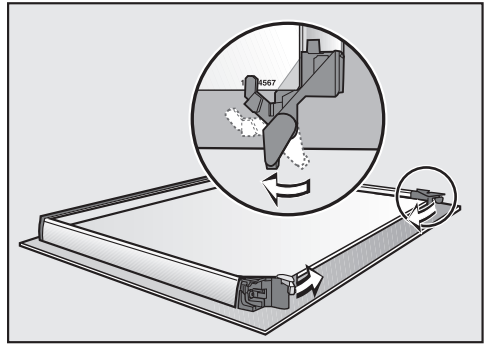

- Flip both the glass pane retainers inwards in such a way that they fit over the lower of the two middle panes.
- Refit the upper of the two middle panes in such a way that the material number is legible (i.e. not reversed). The pane must rest on the retainers.

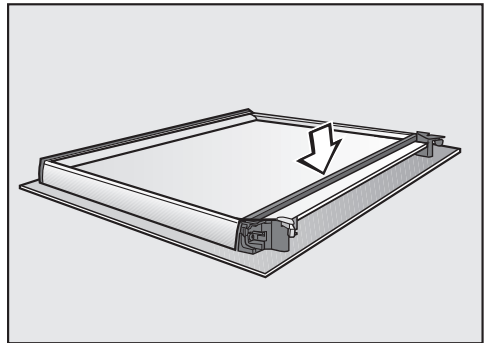

- Refit the seal.

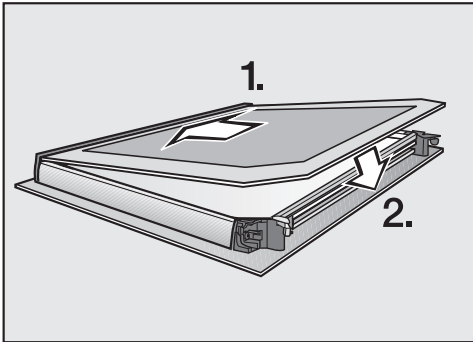

- Push the inner pane with the matt printed side facing downwards into the plastic strip and place it between the retainers.

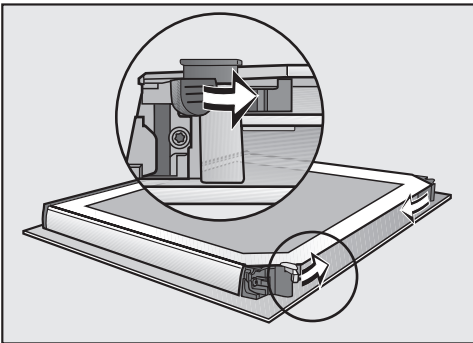

- Flip both the glass pane retainers inwards to close them.

The door is now reassembled.

## Fitting the door

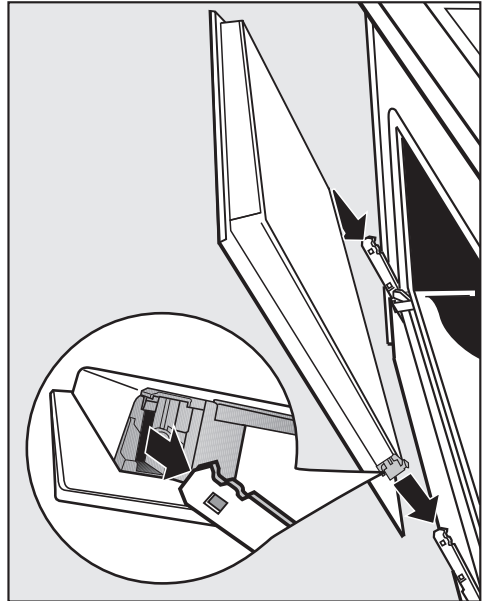

- Hold the door securely on both sides and carefully fit it back into the hinge retainers. Make sure that you fit the door straight.
- Open the door fully.

If the locking clamps are not locked, the door could become loose, resulting in damage. Always ensure that the locking clamps are locked after refitting the door.

## Cleaning and care

---

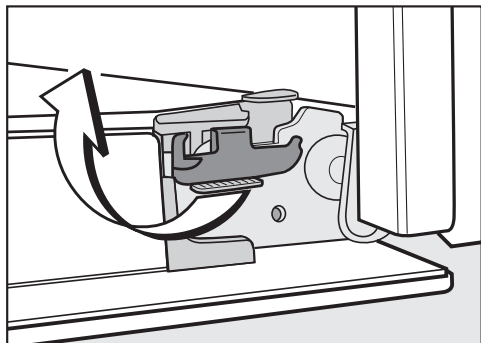



- To relock the locking clamps, turn them back up to the horizontal position as far as they will go.

Many malfunctions and faults can be easily remedied. You can save time and money in many cases, as you do not need to contact Customer Service.



More information to help you remedy faults yourself can be found at [www.miele.ae/support/customer-assistance](http://www.miele.ae/support/customer-assistance).



## Messages in the display



Issue	Cause and remedy
<b>The display is dark.</b>	You have selected the Time   Display   Off setting. When the oven is switched off, the display is dark. <ul style="list-style-type: none"> <li>■ If you want the time of day to be displayed constantly, select the Time   Display   On setting.</li> </ul>
	There is no power to the oven. <ul style="list-style-type: none"> <li>■ Check that the oven plug is correctly inserted into the socket and switched on.</li> <li>■ Check whether the fuse has tripped. Contact a qualified electrician or your Miele dealer.</li> </ul>
<b>System lock  appears in the display.</b>	The  system lock has been activated. <ul style="list-style-type: none"> <li>■ Confirm with <i>OK</i>.</li> </ul> Press “OK” for 6 secs will appear. <ul style="list-style-type: none"> <li>■ You can deactivate the system lock for a cooking process by touching the <i>OK</i> sensor control for at least 6 seconds.</li> <li>■ If you want to permanently deactivate the system lock, select the System lock    Off setting.</li> </ul>
<b>12:00 appears in the display.</b>	The power supply was interrupted for longer than 5 minutes. <ul style="list-style-type: none"> <li>■ Reset the time of day. Cooking process times will also need to be reset.</li> </ul>
<b>Power cut appears in the display.</b>	There has been a brief power cut. This has caused the current cooking process to stop. <ul style="list-style-type: none"> <li>■ Turn the operating mode selector to <b>0</b>.</li> <li>■ Restart the cooking process.</li> </ul>
<b>Max. op. hours reached appears in the display.</b>	The oven has been operating for an unusually long time. This has triggered the safety switch-off function. <ul style="list-style-type: none"> <li>■ Confirm with <i>OK</i>.</li> </ul> The oven is now ready to use.

# Troubleshooting

Issue	Cause and remedy
 Fault <b>F32</b> appears in the display.	The door lock for pyrolytic cleaning has not locked. <ul style="list-style-type: none"><li>■ Switch the oven off and then back on again. Start the pyrolytic cleaning programme again.</li><li>■ If the message appears again, contact your Miele dealer.</li></ul>
 Fault <b>F33</b> appears in the display.	The door lock for pyrolytic cleaning has not opened. <ul style="list-style-type: none"><li>■ Switch the oven off and then back on again.</li><li>■ If the door lock still does not deactivate itself, contact your Miele dealer.</li></ul>
Fault <b>and a fault code not listed here</b> appears in the display.	A fault has occurred that you cannot resolve. <ul style="list-style-type: none"><li>■ Call your Miele dealer.</li></ul>

## Unexpected behaviour

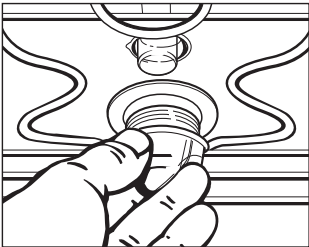
Issue	Cause and remedy
<b>The buzzer does not sound.</b>	The buzzers are deactivated or set at too low a volume. <ul style="list-style-type: none"><li>■ Switch on the buzzers or increase the volume with the <b>Volume   Buzzer tones</b> setting.</li></ul>
<b>The oven compartment does not heat up.</b>	Demo mode is activated. You can select operating modes and sensor controls, but the oven heating does not work. <ul style="list-style-type: none"><li>■ Deactivate demo mode with the <b>Showroom programme   Demo mode   Off</b> setting.</li></ul>
<b>The ≡ sensor control flashes when you switch on the oven.</b>	You have not yet connected your oven to a WiFi network. The sensor control flashes to tell you that you can easily network the oven by holding down this sensor control. The sensor control will stop flashing once the oven has been switched on and off multiple times, but the networking function will remain active.
<b>The oven has switched itself off.</b>	To save power, the oven switches off automatically if a button is not pressed after a certain amount of time or after a cooking programme has ended. <ul style="list-style-type: none"><li>■ Switch the oven back on.</li></ul>

Issue	Cause and remedy
<p><b>The FlexiClip runners do not push in or pull out smoothly.</b></p>	<p>The bearings in the FlexiClip runners are not sufficiently lubricated.</p> <ul style="list-style-type: none"> <li>■ Lubricate the bearings with the special Miele lubricant.</li> </ul> <p>Only the special Miele lubricant is designed for the high temperatures in the oven compartment. Other lubricants may resinify when heated and will gum up the FlexiClip runners. You can obtain the special Miele lubricant from your Miele dealer.</p>
<p><b>The door will not open after the pyrolytic cleaning programme.</b></p>	<p>The door lock for pyrolytic cleaning has not opened.</p> <ul style="list-style-type: none"> <li>■ Turn the function selector to <b>0</b>.</li> <li>■ If the door lock still does not release itself call your Miele dealer.</li> </ul>
<p><b>The oven interior lighting does not switch on.</b></p> 	<p>The halogen lamp is faulty.</p> <div style="border: 1px solid gray; padding: 5px; margin: 10px 0;"> <p>⚠ Risk of injury caused by hot surfaces. The oven gets hot during operation. You could burn yourself on the heating elements, oven compartment or accessories. Allow the heating elements, oven compartment and the accessories to cool before manual cleaning.</p> </div> <ul style="list-style-type: none"> <li>■ Disconnect the appliance from the mains. Switch off at the wall and withdraw the plug from the socket or switch off the fuse of the electrical installation.</li> <li>■ Turn the lamp cover a quarter turn anti-clockwise to release it and then pull it together with its seal downwards to take it out.</li> <li>■ Replace the halogen lamp (Osram 66725 AM/A, 230 V, 25 W, G9).</li> <li>■ Refit the lamp cover together with its seal and turn clockwise to secure.</li> <li>■ Reconnect the appliance to the electricity supply.</li> </ul>
<p><b>The oven interior lighting switches off even though the operating mode selector is in the Lighting  position.</b></p>	<p>When the selector is in the Lighting  position, the oven interior lighting is switched on for approx. 20 minutes. The oven interior lighting then switches off automatically.</p>

# Troubleshooting

## Unsatisfactory results

Issue	Cause and remedy
<b>Cakes/biscuits are not cooked properly after the duration given in the cooking chart.</b>	A different temperature from the one given in the recipe was used. ■ Select the temperature required for the recipe.
	The ingredient quantities are different from those given in the recipe. ■ Check whether you amended the recipe. The addition of more liquid or more eggs makes a moister mix which requires a longer cooking duration.
<b>The browning of the baked goods is uneven.</b>	The wrong temperature or shelf level was selected. ■ There will always be a slight unevenness in browning. If browning is very uneven, check whether the correct temperature and shelf level were selected.
	The material or colour of the bakeware is not suitable for the oven function selected. ■ When using the Conventional heat  function, light coloured, shiny tins will not produce as desirable results. Dark, matt tins are best for baking.
<b>There is still soiling in the oven compartment after a pyrolytic cleaning programme.</b>	The pyrolytic cleaning programme burns off soiling in the oven and leaves it as ash. ■ Remove the ash using a damp microfibre cloth or with a clean sponge and a solution of hot water and washing-up liquid. If there is still coarse soiling left in the oven after the pyrolytic cleaning programme you should start the programme again, selecting a longer duration if necessary.

## Unusual noises

Issue	Cause and remedy
<b>A noise can be heard after a cooking process.</b>	The cooling fan remains switched on after a cooking process.

Information to help you rectify faults yourself and about Miele spare parts can be found at [www.miele.com/service](http://www.miele.com/service).

## Contact in case of malfunction

In the event of any faults which you cannot remedy yourself, please contact your Miele dealer.

Contact details for your Miele dealer are given at the end of this document.

Please note that telephone calls may be monitored and recorded for training purposes and that a call-out charge will be applied to service visits where the problem could have been resolved as described in this booklet.

Please quote the model and serial number of your appliance when contacting your Miele dealer. This information can be found on the data plate.

This information is given on the data plate, which is visible on the front frame of the oven when the door is fully open.

## Warranty

For information on the appliance guarantee specific to your country please contact your Miele dealer. See end of this booklet for contact details.

# Installation

## Installation dimensions

Dimensions are given in mm.

### Installation in a tall or base unit

When building the oven into a base unit underneath a hob, please also observe the installation instructions for the hob as well as the building-in depth required for the hob.

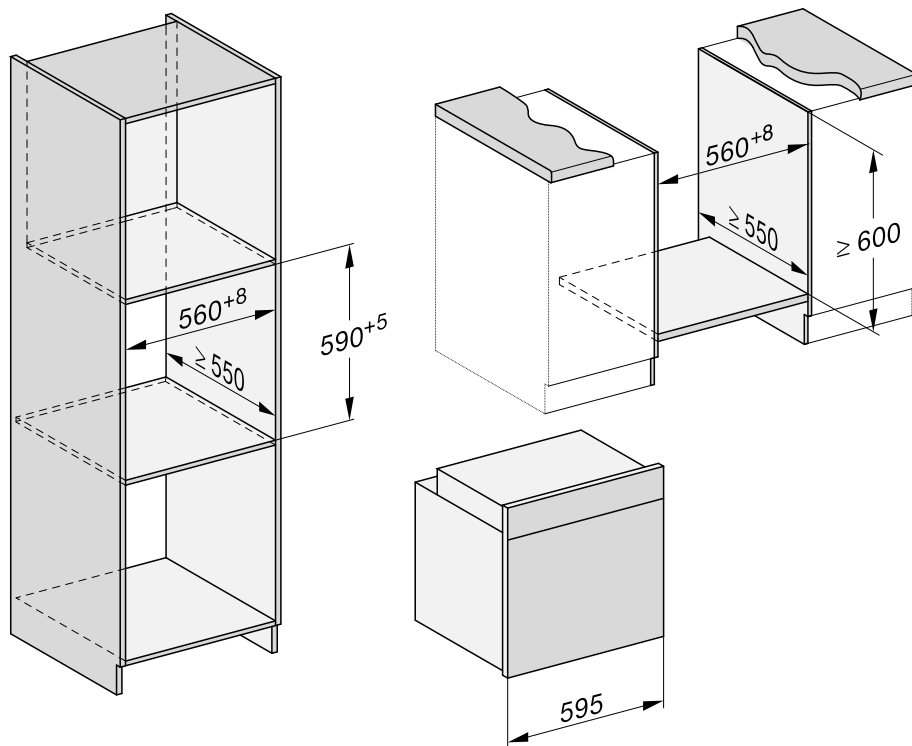

## Side view H 24xx

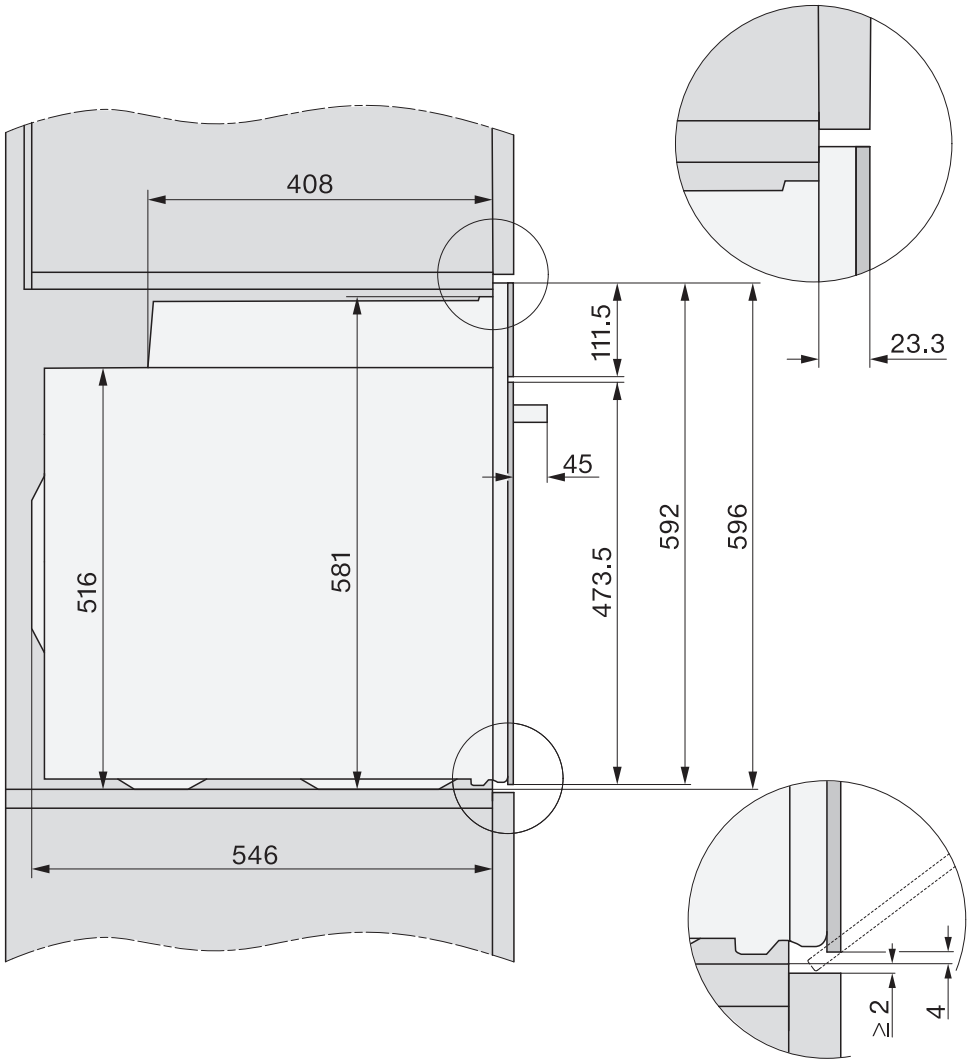

# Installation

Side view H 28xx, H 27xx

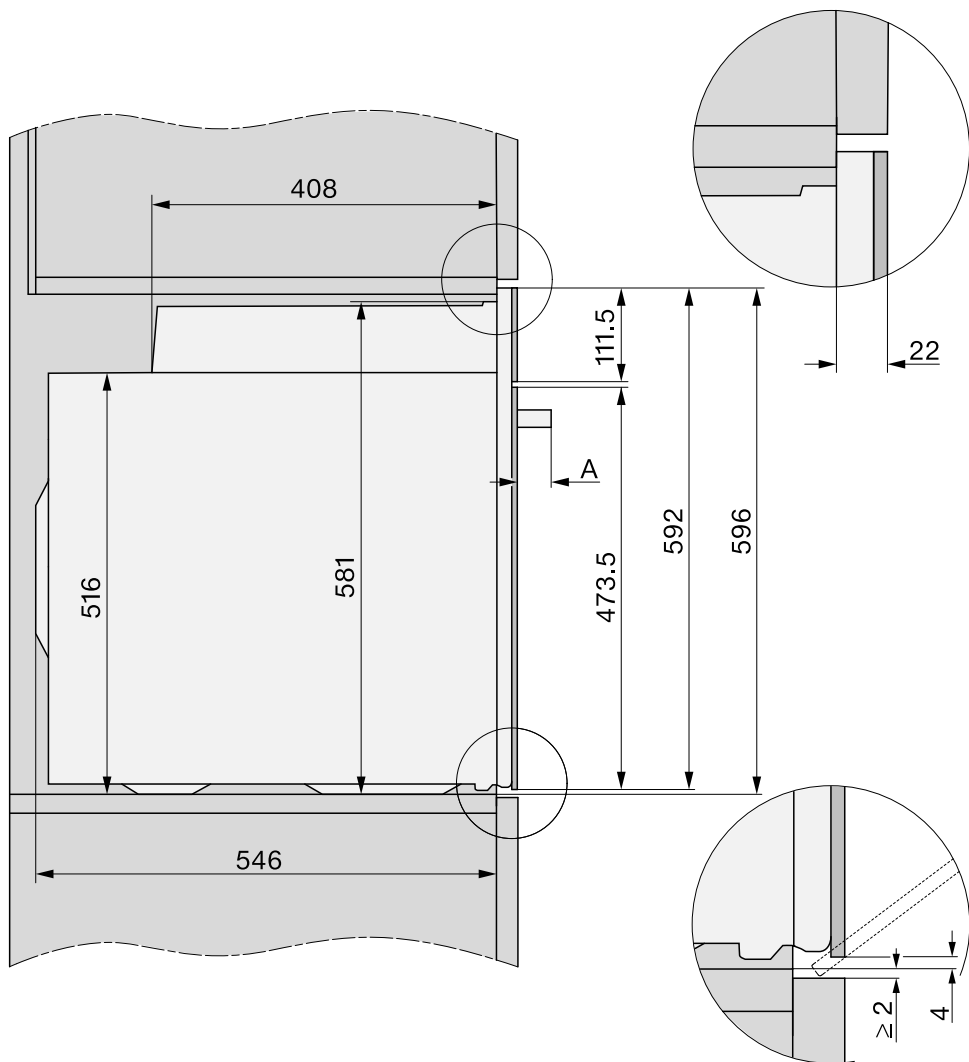

**A** H 27xx: 43 mm  
H 28xx: 47 mm

## Connections and ventilation

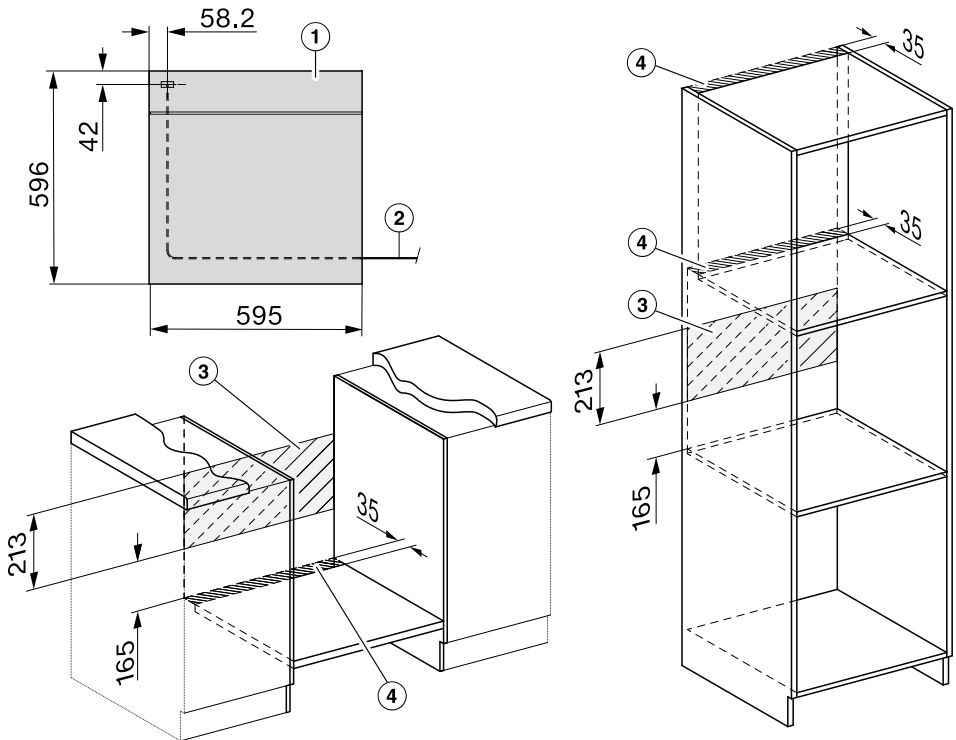

- ① Front view
- ② Mains supply cord, length = 1.500 mm
- ③ No connections permitted in this area
- ④ Ventilation cut-out, min. 150 cm<sup>2</sup>

# Installation

## Installing the oven

For safety reasons, the oven may only be used when it has been fully installed.

The oven requires a sufficient supply of cool air for efficient operation. The required supply of cool air must not be excessively heated by other heat sources (e.g. solid fuel stoves).

The following must be observed when installing the appliance:  
Make sure that the shelf that the oven sits on does not touch the wall.  
Do not fit heat insulation strips to the side walls of the housing unit.

- Connect the oven to the power supply.

Carrying the oven by the door handle could damage the door.

Use the recessed grips on the side of the housing to carry the appliance.

It is a good idea to remove the door and the accessories before installing the appliance. This makes the oven lighter when you push it into the housing unit and you do not run the risk of lifting it by the door handle by mistake.

- Push the oven into the housing unit and align it.
- Open the door, if you have not removed it.

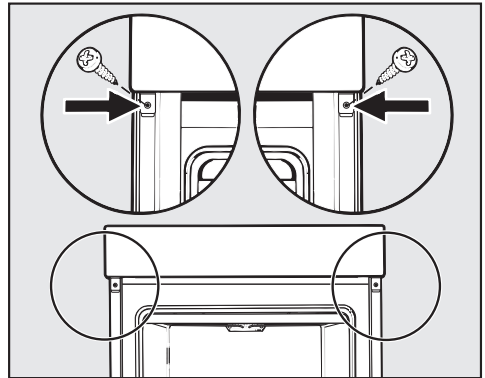

- Use the screws supplied to secure the oven to the side panels of the housing unit.
- Refit the door if necessary.

## Electrical connection

All electrical work should be carried out by a suitably qualified and competent Miele approved technician in strict accordance with local and national safety regulations.

This appliance is supplied with a power cord without plug for fixed connection to your power system.

Fuse rating of branch circuit should be minimum 15 A and maximum 30 A.

The voltage and connected load are given on the data plate situated at the front of the oven interior. Please ensure that these match the household mains supply.

Connection should be made via a fused connection unit or a suitable isolator, which complies with national and local safety regulations, and the on/off switch should be easily accessible after the appliance has been installed.

If the switch is not accessible after installation (depending on country) an additional means of disconnection must be provided for all poles.

Switches with a minimum all-pole contact gap of 3 mm are suitable for isolating the appliance. These include circuit breakers, fuses and protective devices.

For extra safety it is advisable to install a suitable residual current device (RCD) / ground fault interrupter (GFI). Contact a qualified electrician for advice.

If the supply cord is damaged, it must be replaced by the manufacturer, its service agent or similarly qualified persons in order to avoid a hazard. For safety reasons, such replacement may only be carried out by a qualified specialist or your Miele dealer.

The wires in the mains lead are coloured as follows:

Green/yellow = earth

Blue = neutral

Brown = live

When replacing the cable supplied with another cable or changing the connection, only cable type H 05 VV-F with a suitable cross-sectional area (CSA) may be used.

 **WARNING - THIS APPLIANCE MUST BE EARTHED**

Temporary or permanent operation on an autonomous power supply system or a power supply system that is not synchronised with the mains power supply (e.g. island networks, back-up systems) is possible. A prerequisite for operation is that the power supply system complies with the specifications of EN 50160 or an equivalent standard. The function and operation of the protective measures provided in the domestic electrical installation and in this Miele product must also be maintained in isolated operation or in operation that is not synchronised with the mains power supply, or these measures must be replaced by equivalent measures in the installation. As described, for example, in the current version of BS OHSAS 18001–2 ISO 45001.

### **Copyrights and licences for the communication module**

For the purpose of operating and controlling the communication module, Miele uses proprietary or third-party software that is not covered by open source licensing terms. These items of software/software components are protected by copyright. The copyrights held by Miele and third parties must be respected.

Furthermore, this communication module contains software components which are distributed under open source licence conditions. The open source components contained in the appliance along with the corresponding copyright notices, copies of the licensing terms valid at the time, and any further information can be accessed locally via IP using a web browser (*http://<IP address>/Licenses*). The liability and warranty arrangements for the open source licences displayed in this location only apply in relation to the respective rights holders.

**Miele in Saudi Arabia:**

**Awad Badi Nahas Trading Co. Ltd.**

Medina Road, P.O. Box 11529  
Jeddah 21463  
Kingdom of Saudi Arabia  
Tel. +966 12 2560888  
Hotline for customer care 920003240  
(Sat – Thu; 8 am – 5 pm)  
Fax +966 12 2560555  
E-mail: [info@awadnahas.com](mailto:info@awadnahas.com)  
Website: [www.awadnahas.com](http://www.awadnahas.com)

**Miele in United Arab Emirates:**

**Miele Appliances Ltd.**

Showroom 1 Eiffel 1 Building  
Sheikh Zayed Road, Umm Al Sheif  
P.O. Box 114782 - Dubai  
United Arab Emirates  
Tel. +971 4 3044 999  
Fax +971 4 3418 852  
800-MIELE (64353)  
E-mail: [info@miele.ae](mailto:info@miele.ae)  
Website: [www.miele.ae](http://www.miele.ae)  
Webshop: [shop.miele.ae](http://shop.miele.ae)

**Manufacturer:** Miele & Cie. KG, Carl-Miele-Straße 29, 33332 Gütersloh, Germany



H 2465 BP

en-AE, KW

M.-Nr. 12 433 261 / 00 / 002