

**Miele**



# Operating and Installation Instructions Commercial Washing Machine

PWM 912

PWM 916

PWM 920

---













**Always** read the operating instructions before setting up, installing, and commissioning the machine. This prevents both personal injury and damage to the appliance.

en-US, CA

M.-Nr. 11 874 834

# Contents

---

<b>Caring for the environment</b> .....	<b>6</b>
<b>IMPORTANT SAFETY INSTRUCTIONS</b> .....	<b>8</b>
Explanation of the safety notes and warnings on the machine .....	8
Appropriate use .....	8
Foreseeable misuse .....	9
Technical safety .....	9
Correct use.....	10
Chlorine and component damage.....	11
Accessories .....	12
<b>Description of the machine</b> .....	<b>13</b>
Models with detergent drawer (DD) .....	13
Models without detergent drawer (DD) .....	14
Control panel.....	15
<b>Operating</b> .....	<b>16</b>
Sensor controls and touch display.....	16
Main menu .....	16
Examples of how to operate the machine .....	16
Operating a laundromat machine .....	19
<b>Washing</b> .....	<b>20</b>
Preparing for use .....	20
Loading and switching on the washing machine .....	20
Washing with detergent drawer .....	21
Selecting a program .....	23
Selecting program settings .....	24
Selecting Extras .....	28
Pre-wash  .....	29
Soak  .....	29
Rinse plus  .....	29
Rinse hold  .....	29
Filling stop  .....	29
Intensive  .....	29
Water plus  .....	29
Program start – program end .....	29
Timer .....	31
<b>Special features in the program sequence</b> .....	<b>32</b>
Spinning.....	32
Anti-crease .....	32
Skip.....	32
Manual control.....	33
Switching to manual control .....	33
Water intake  .....	34
Dispensing  .....	34
Washing and heating  .....	34
Drain with agitation  .....	34
Spin  .....	34
Function combinations .....	34
Weighing system .....	36
<b>Changing the program sequence</b> .....	<b>37</b>
Changing a program .....	37
Altering the wash program .....	37

Interrupting a program .....	37
Switching on the washing machine after a power failure .....	37
Adding or removing laundry .....	38
<b>Frequently asked questions .....</b>	<b>39</b>
Troubleshooting .....	39
Contact in case of fault .....	41
Frequently asked questions .....	41
The wash program will not start.....	41
Program cancellation and fault message .....	42
The display shows a message .....	42
Insufficient wash results .....	43
General problems with the washing machine.....	43
The door will not open or close .....	45
Continuing a program after a power failure .....	46
<b>Cleaning and care .....</b>	<b>47</b>
Build-up of rust.....	47
Cleaning the detergent drawer, detergent compartments, and siphons .....	48
Cleaning the water inlet filters.....	49
Cleaning the drum, suds container, and drainage system.....	49
<b>Installation.....</b>	<b>51</b>
Installing the washing machine .....	51
Securing the machine .....	51
General operating conditions .....	51
Performing maintenance .....	52
Installation on a base .....	52
Transport safety devices .....	53
Removing the transport safety devices .....	53
Water connection.....	53
Dispenser pump connections .....	55
Drainage.....	56
Electrical connection .....	56
Optional accessories .....	56
Connector Box .....	56
Wi-Fi/LAN interface.....	57
Base (APWM 031/035) .....	57
Vapor and suds venting kit (APWM 063).....	57
<b>Supervisor level.....</b>	<b>58</b>
Opening the supervisor level.....	58
Opening the supervisor level (self-service) .....	58
Code-based access .....	58
Changing the code .....	58
Closing the Settings menu.....	58

# Contents

---

Controls / Display.....	59
Language.....	59
Language entry.....	59
Set languages.....	59
Time.....	59
Date.....	59
Logo.....	60
Start screen.....	60
Mode.....	60
Display brightness.....	60
Display off status.....	60
Machine off status.....	60
Volume.....	60
Visibility parameters.....	60
Delay start.....	61
Memory.....	61
Manual control.....	61
Change order.....	61
Measuring system.....	61
Supervisor code.....	61
Wi-Fi.....	61
Program selection.....	62
Controls.....	62
Program packages.....	62
Favorite programs.....	62
Sort programs.....	62
Program color allocation.....	63
Expert code.....	63
Process technology.....	63
Anti-crease.....	63
Automatic drainage.....	63
Service.....	63
Service interval.....	63
External applications.....	65
Payment system lock.....	65
Connector box.....	65
Automatic dispensing.....	65
Dosage.....	65
Peak load prevention.....	65
Machine parameters.....	65
Maximum spin speed.....	65
Max. adjust. temperature.....	65
Legal Information.....	65
Payment system.....	65

<b>Networking</b> .....	<b>67</b>
Pairing instructions .....	67
Network connection.....	67
Opening the supervisor level .....	67
Initial network setup.....	67
Setting up a network connection manually .....	68
Establishing the network connection via WPS .....	69
Establishing the network connection via soft AP .....	70
Establishing the network connection using a LAN cable.....	70
Wi-Fi/LAN interface configured .....	71
Technical data .....	71
<b>Technical data</b> .....	<b>73</b>
PWM 912 machine data .....	73
Electrical connection.....	73
Installation dimensions.....	73
Weight and floor load.....	73
Emission values.....	73
Product safety .....	73
WiFi.....	73
PWM 916 machine data .....	74
Electrical connection.....	74
Installation dimensions.....	74
Weight and floor load.....	74
Emission values.....	74
Product safety .....	74
WiFi.....	74
PWM 920 machine data .....	75
Electrical connection.....	75
Installation dimensions.....	75
Weight and floor load.....	75
Emission values.....	75
Product safety .....	75
WiFi.....	75
<b>WiFi data protection</b> .....	<b>77</b>
Data protection and data security .....	77
Factory default settings for network configuration .....	77
Copyrights and licenses .....	77

### Disposal of the packaging material

The packaging is designed to protect the washing machine against transport damage. The packaging materials used are selected from materials which are environmentally friendly for disposal and can therefore be recycled.

Recycling the packaging material reduces the use of raw materials in the manufacturing process and also reduces the amount of waste in landfill sites. Your dealer will take the packaging material away.

### Disposing of your old machine

Old electrical and electronic machines often contain valuable materials. However, they also contain harmful substances which were essential for their correct functioning and safety. These could be hazardous to human health and to the environment if disposed of with household waste or if handled incorrectly. Therefore, please do not dispose of your old machine with household waste.



Please dispose of it at your local community waste collection/recycling center. Consult your dealer if necessary. Please ensure that your old machine poses no risk to children while being stored for disposal.

► Ensure that the door locks are unusable when disposing of or scrapping old washing machines. This will prevent the risk of anyone or anything accidentally locking themselves in while playing and endangering their lives.

Miele cannot be held liable for damage caused by failure to comply with these IMPORTANT SAFETY INSTRUCTIONS.

### Energy saving tips

#### Energy and water consumption

- Make use of the **maximum** load size that the wash program can accommodate.  
The most efficient use of energy and water is achieved when a full load is washed.
- If suitable, use programs from the Eco program package. The programs are characterized by particularly low energy consumption.

#### Detergent





- Do not exceed the amounts of detergent recommended on the packaging.
- Reduce the amount of detergent for smaller load sizes.

#### When drying with a tumble dryer

Select the highest possible spin speed for the wash program to save energy in the subsequent drying cycle.

# IMPORTANT SAFETY INSTRUCTIONS

## Explanation of the safety notes and warnings on the machine

	Read the operating instructions
	Warning, hot surfaces
	Warning, voltage up to 1,000 volts
	Protective ground
	Equipotential bonding

This washing machine complies with all current local and national safety requirements. Inappropriate use can, however, lead to personal injury and material damage.

Read the operating instructions carefully before using the washing machine. They contain important information on safety, installation, use, and maintenance. This prevents both personal injury and damage to the washing machine.

Miele expressly and strongly advises that you read and follow the instructions in the section on installing the washing machine as well as the IMPORTANT SAFETY INSTRUCTIONS.

Miele cannot be held liable for injury or damage caused by non-compliance with these instructions.

Keep these operating instructions in a safe place and pass them on to any future user.

When instructing other people how to use the washing machine, they must be made aware of these IMPORTANT SAFETY INSTRUCTIONS.

### Appropriate use

- ▶ The washing machine is only suitable for washing fabrics with a care label stating that they are suitable for machine washing. Any other applications may be dangerous. The manufacturer cannot be held liable for damage resulting from incorrect or improper use or operation of the machine.
- ▶ This washing machine must be used as described in the operating instructions and must be checked on a regular basis to make sure it is functioning correctly. Maintenance must be carried out when necessary.
- ▶ The washing machine is not suitable for outdoor use.
- ▶ Do not install the washing machine in a room where there is a risk of frost. Frozen hoses are at risk of tearing or bursting. The reliability of the electronic may be impaired at temperatures below freezing point.
- ▶ This washing machine is intended only for use in a commercial environment.
- ▶ The washing machine must not be used in a non-stationary installation site (e.g., on a ship).

## IMPORTANT SAFETY INSTRUCTIONS

- ▶ This washing machine should not be used by persons with reduced physical, sensory, or mental capabilities, or a lack of experience and knowledge, unless they are supervised or instructed on its use by a responsible person.
- ▶ Always supervise any children in the vicinity of the washing machine. Never allow children to play with the washing machine.
- ▶ Disinfection programs must not be interrupted, as this can have a limiting effect on the disinfection result. It is the operator's responsibility to ensure that the standard of disinfection in thermal as well as chemo-thermal procedures is maintained by carrying out suitable validation tests.

### Foreseeable misuse

- ▶ Never use solvent-based cleaning agents, e.g., those containing benzene, in this washing machine. This may result in damage to component parts and create toxic fumes. **Risk of fire and explosion!**
- ▶ When washing with high temperatures, remember that the porthole glass becomes hot. Do not touch it during the wash process.  
**Danger of injury by burning!**
- ▶ Do not damage, remove, or bypass the safety features or control elements of this washing machine.
- ▶ Machines with damaged control elements or cable insulation may only be replaced by the manufacturer/Miele Service or a qualified electrician.
- ▶ Water used for washing in this machine consists of suds and is not drinking water! Drain the suds into a proper drainage system.
- ▶ Always make sure that the drum is stationary before reaching in to remove laundry. Reaching into a rotating drum is extremely dangerous and may result in injury.
- ▶ Be careful not to put your hands in the gap between door and frame when closing the drum door.

**Please note:** The drum door is locked automatically as soon as the washing machine starts.

- ▶ It is particularly important to observe the manufacturer's instructions when using a combination of cleaning agents and special application products. Products must only be used for applications approved by the manufacturer to avoid any material damage or the occurrence of strong chemical reactions.

### Technical safety

- ▶ Before installing the washing machine, check it for visible signs of damage. Do not install or use a damaged washing machine.
- ▶ The electrical safety of this washing machine can only be guaranteed when correctly grounded. It is essential that this standard safety requirement is observed and regularly tested. If in any doubt, please have the electrical installation inspected by a specialist. Miele cannot be held liable for the consequences of an inadequate grounding system.
- ▶ Unauthorized repairs could result in unforeseen dangers for the user, for which the manufacturer cannot accept liability. Repairs must only be carried out by a Miele authorized technician, otherwise any subsequent damage will not be covered by the warranty.
- ▶ Do not make any alterations to the machine, unless authorized to do so by Miele.

## IMPORTANT SAFETY INSTRUCTIONS

---

- ▶ Disconnect the washing machine from the power supply in the event of a fault and for cleaning and maintenance. The washing machine is only electrically disconnected from the power supply when
  - the electrical plug of the washing machine is unplugged, or
  - the fuse is disconnected, or
  - the screw-in fuse has been completely removed.

For more information, see “Installation – Electrical connection”.

- ▶ The washing machine may only be connected to the water supply using the set of hoses supplied with the machine. Old sets of hoses must not be re-used. Check the sets of hoses regularly for signs of wear. Change the sets of hoses ahead of time to avoid the risk of leaks and subsequent water damage.

- ▶ The cause of any leaks must be dealt with before the washing machine is restarted. Disconnect the washing machine immediately if any water leaks out.

- ▶ In the case of a fault with the steam heating there can be increased temperatures in the vicinity of the door, the detergent compartment panel and in the drum interior (especially at the edges). Danger of burning.

This only applies for machines with steam heating.

- ▶ Faulty components must only be replaced by genuine Miele replacement parts. Miele can only guarantee the safety standards of the machine when Miele replacement parts are used.

- ▶ All relevant national provisions and regulations (DGUV in Germany) relating to accident insurance are applicable to this machine. It is recommended to carry out testing in accordance with the regulatory framework described in DGUV 100-500/Chapter 2.6/Section 4. The test book required for the documentation is available from Miele Customer Service.

- ▶ Please observe the instructions in “Installation and connection” and “Technical data”.

- ▶ If the washing machine is connected using an electrical plug, the electrical plug must always be kept accessible so that the washing machine can be easily disconnected from the power supply.

- ▶ If the washing machine is to be hard-wired, there must be a means of disconnecting all poles from the power supply. The disconnection switch must be close to the washing machine and be clearly identifiable, unhindered, and easily accessible at all times.

- ▶ A central Emergency shut off device must be available for models without an Emergency shut off.

### **Correct use**

- ▶ The maximum dry-laundry weight for the PW 912 is 27 lb (12 kg), for the PWM 916 it is 36 lb (16 kg), and for the PWM 920 it is 45 lb (20 kg). See the “Program chart” for the maximum recommended loads for individual programs.

- ▶ Before using the washing machine for the first time, ensure that the transport safety devices have been removed (see “Installation – Removing the transport safety device”). If the transport safety device is not removed, it may cause damage to adjacent furniture or machines during the spin cycle.

- ▶ Never try to open the drum door of the washing machine using force. The door can only be opened when a corresponding message appears in the display.

## IMPORTANT SAFETY INSTRUCTIONS

- ▶ Do not push back the soft mount drum of the machine while the machine is running.
- ▶ When closing the drum door there is a danger of crushing and shearing between the door frame and the drum opening and also at the hinges.  
Caution: The drum door locks automatically when the machine is started.
- ▶ Turn off the water inlet if the washing machine is to be left for any length of time (e.g., during vacation), especially if there is no floor drain (gully) in the immediate vicinity.
- ▶ Take care to ensure that foreign objects (e.g., nails, pins, coins, paper clips) do not find their way into the machine with the laundry. These may damage components of the machine (e.g., suds container, drum). Damaged components can damage the laundry.
- ▶ If the correct amount of detergent is dispensed, the washing machine should not need to be descaled. If, however, you do wish to descale your washing machine, only use proprietary non-corrosive descaling agents. Special descaling agent is available from your Miele dealer or from Miele Customer Service. Strictly observe the instructions for the descaler.
- ▶ Solvent-based cleaning agents must not be used.
- ▶ Do not store or use gasoline, paraffin, or any easily flammable substances near the washing machine. Do not use the machine lid as storage space.

### **Risk of fire and explosion!**

- ▶ Do not store chemicals (liquid detergents, additives) on the machine lid. They may cause discoloration or lacquer damage. Accidentally spilled chemicals should be removed from the surface immediately with a wet cloth.
- ▶ The fan casing is located on the back of the machine. The casing must never be covered or blocked. Observe the minimum distance on the installation plan.
- ▶ Only use dyes, dye removers, and descaling agents suitable for use in a washing machine. The manufacturer's instructions on the packaging must be observed.
- ▶ Dye removers contain sulfur compounds which can cause damage such as corrosion. Do not use these products in this washing machine.
- ▶ Avoid contact between stainless steel surfaces and liquid detergents or disinfecting agents containing chlorine or sodium hypochlorite. These agents can cause corrosion on stainless steel. Aggressive chlorine bleach vapors can also be corrosive. Do not store open containers of these agents near the machine.
- ▶ Do not use a power washer or hose to clean the washing machine.

### **Chlorine and component damage**

- ▶ Frequent use of chlorine products increases the risk of damage to components.
- ▶ The use of substances containing chlorine, such as sodium hypochlorite and chlorine bleach in powder form, can result in damage to the protective layer of stainless steel and corrosion on components. Therefore, refrain from using substances containing chlorine. Use oxygen-based bleaching agents instead.

## IMPORTANT SAFETY INSTRUCTIONS

---

If, however, chlorine bleaching agents are used, an anti-chlorine treatment must always be carried out. Otherwise, both the washing machine components and the laundry may suffer persistent and irreparable damage.

► Anti-chlorine treatment must be carried out immediately after chlorine bleaching agents have been used. Hydrogen peroxide as well as oxygen-based detergents and bleaching agents are suitable for anti-chlorine treatment. The suds must not be drained in between.

Treatments with thiosulfates can result in gypsum-like deposits particularly when used in combination with hard water. This gypsum can build up in the washing machine or cause incrustations on the laundry. Treatment with hydrogen peroxide is recommended over treatment with thiosulfates because hydrogen peroxide neutralizes chlorine.

The exact dispensing quantities and the treatment temperatures required must be set and tested on site in accordance with the dispensing recommendations of the detergent and cleaning agent manufacturers. The laundry must also be tested to check whether it contains any active chlorine residues.

### **Accessories**

► Only use genuine Miele spare parts and accessories with this machine. Using parts or accessories from other manufacturers will invalidate the warranty, and Miele cannot accept liability.

## Models with detergent drawer (DD)

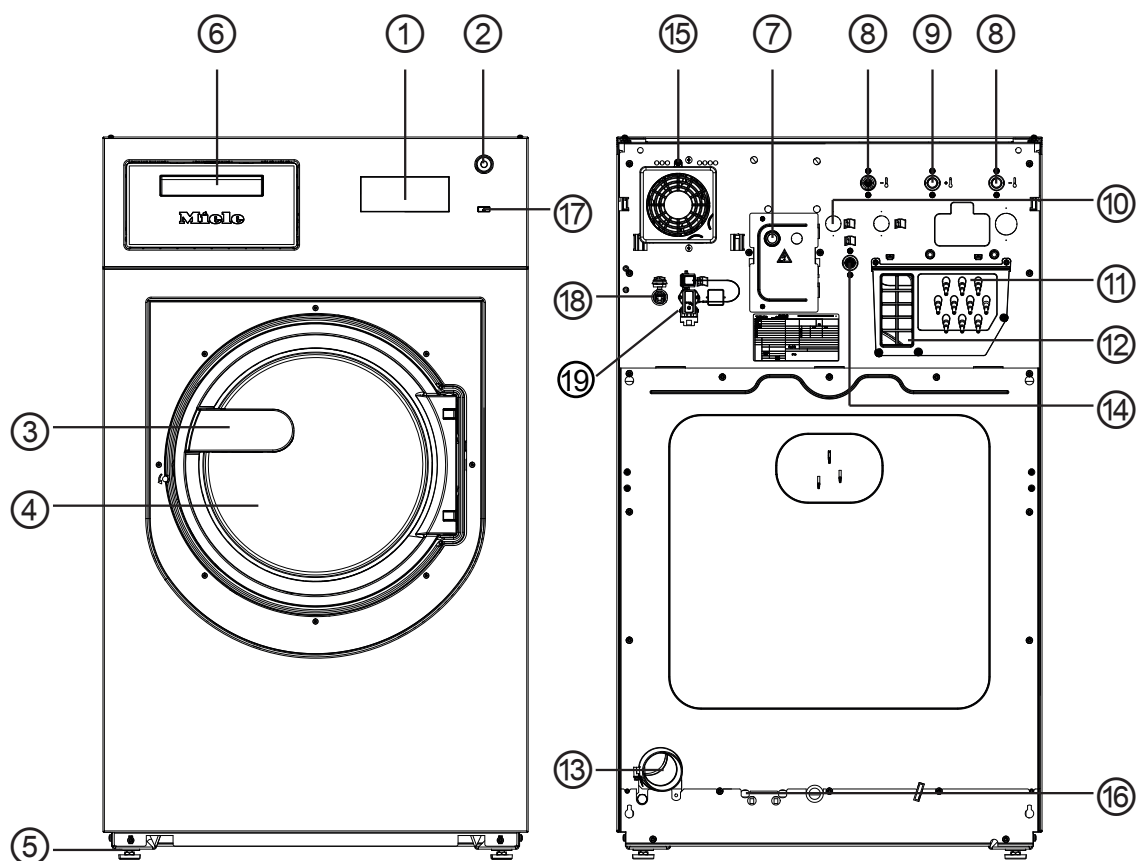

- ① **Display**  
see "Control panel"
- ② **Emergency shut-off switch**  
see "Control panel"
- ③ **Door handle**
- ④ **Drum door**
- ⑤ **4 adjustable feet**
- ⑥ **Detergent drawer**
- ⑦ **Electrical connection**
- ⑧ **Cold water connection**
- ⑨ **Hot water connection**
- ⑩ **2 x hard water connection**  
(Optional)
- ⑪ **Connections for external dispenser pumps**
- ⑫ **Vapor extraction/free outlet Type AB**
- ⑬ **Drainage**
- ⑭ **Cold water connection for liquid dispensing**
- ⑮ **Fan casing**
- ⑯ **Connection option for direct/indirect steam**  
(depending on model)
- ⑰ **⏻ button**
- ⑱ **Ethernet interface RJ45, for external communication**
- ⑲ **Connection for Connector Box**  
(1 x model series, 2 x optional)

# Description of the machine

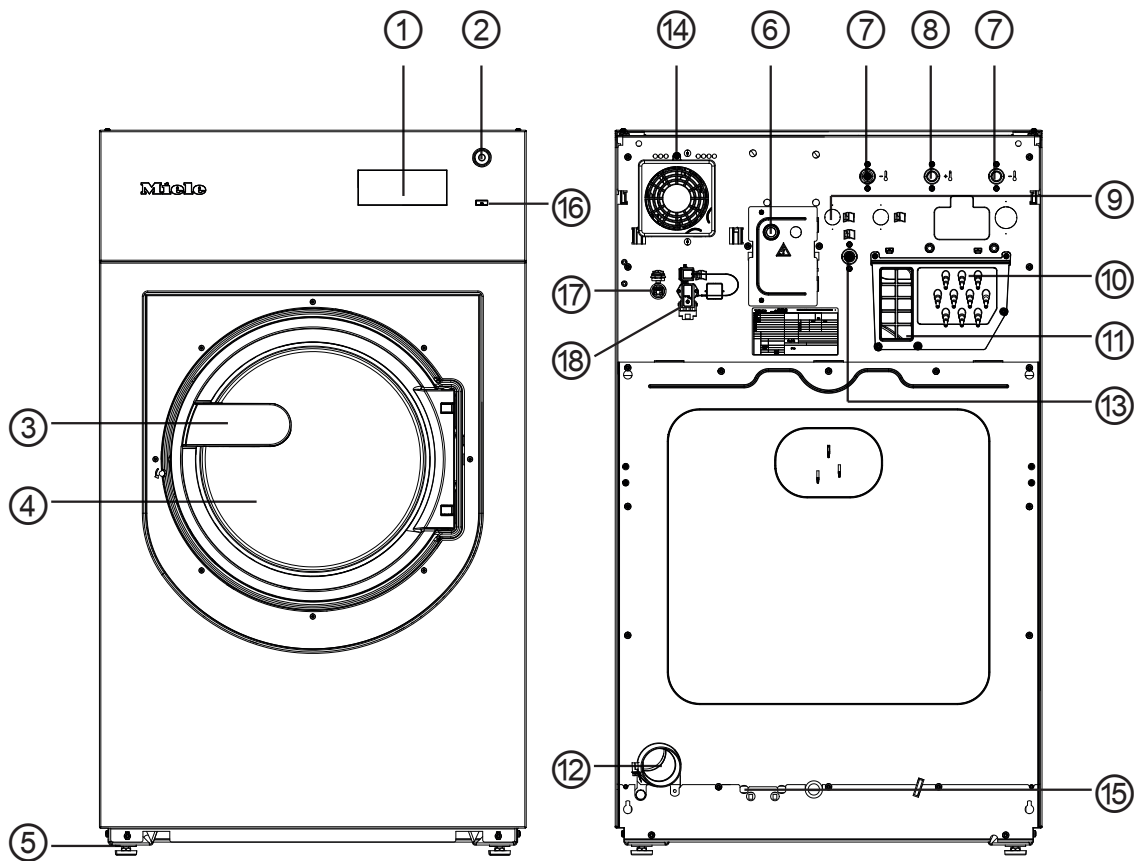

## Models without detergent drawer (DD)



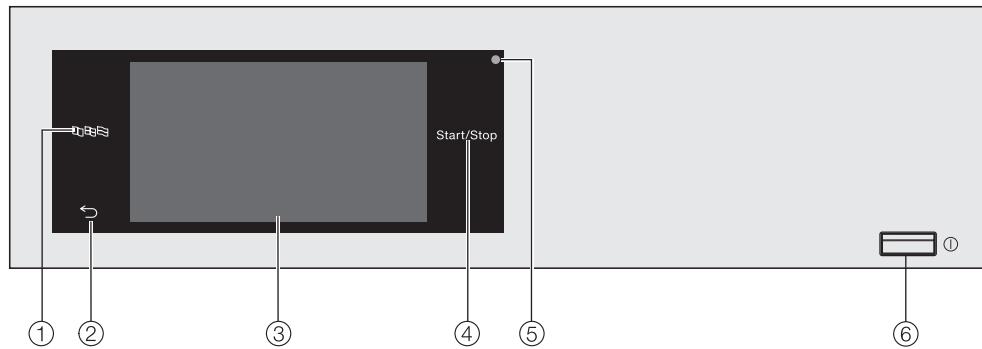

- ① **Display**  
see "Control panel"
- ② **Emergency shut-off switch**  
see "Control panel"
- ③ **Door handle**
- ④ **Drum door**
- ⑤ **4 adjustable feet**
- ⑥ **Electrical connection**
- ⑦ **Cold water connection**
- ⑧ **Hot water connection**
- ⑨ **2 x hard water connection**  
(Optional)
- ⑩ **Connections for dispenser pumps**
- ⑪ **Vapor extraction/free outlet Type AB**
- ⑫ **Drainage**
- ⑬ **Cold water connection for liquid dispensing**
- ⑭ **Fan casing**
- ⑮ **Connection option for direct/indirect steam**  
(depending on model)
- ⑯ **button**
- ⑰ **Interface for communicating with external devices**
- ⑱ **Connection for Connector Box**  
(1 x model series, 2 x optional)

## Control panel



- ① **Language sensor control**   
For selecting the current user language.  
The supervisor language is displayed again at the end of the program.
- ② **Back sensor control**   
Takes you back one level in a menu.
- ③ **Touch display**
- ④ **Start/Stop sensor control**  
For starting the wash program selected and canceling a program once it has started. The program selected can be started as soon as the sensor control starts flashing.
- ⑤ **Optical interface**  
For Miele Service.
- ⑥ **Power button**   
For switching the washing machine on and off.

## Sensor controls and touch display

The sensor controls , , and *Start/Stop* and the elements in the display respond to finger tip contact. Every tap of a sensor control is confirmed with an audible keypad tone. You can adjust the volume of the keypad tone or switch it off (see “Supervisor level”).

The control field with sensor controls and the touch display can be scratched by pointed or sharp objects, e.g., pens.  
Only touch the control field with your fingers.

## Main menu

After switching on the washing machine, the main menu will appear in the display.

You can access all the important submenus from the main menu.

Touch the  symbol at any time to return to the main menu. Values set previously are not saved.

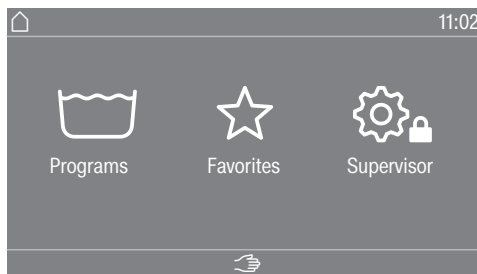

### “ Programs” menu

In this menu, you can select the wash programs.

### “ Favorites” menu

In this menu, you can select 1 favorite program from a total of 24 favorite programs. The wash programs can be set up and saved by the supervisor in the Favorites menu (see “Favorite programs” under “Supervisor level”).

### “ Supervisor” menu

You can alter the washing machine’s user interface to suit changing requirements in the supervisor level (see “Supervisor level”).

## Examples of how to operate the machine

### Lists

#### “Programs” menu (single selection)

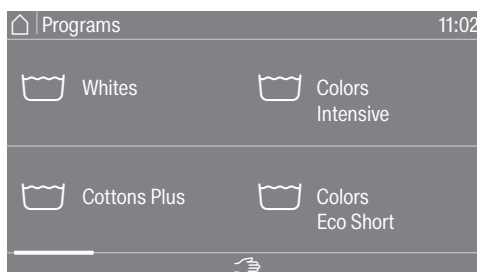

You can scroll right or left by swiping your finger across the screen. To do this, place your finger on the touch display and swipe it in the direction you want.

The orange scroll bar indicates that there are further options to choose from.

Touch a program name to select the wash program.  
The display will change to the standard menu for that program.

## “Extras” menu (multiple selection)

To access the level for selecting *Extras*, you first need to select a program, e.g., *Whites*.

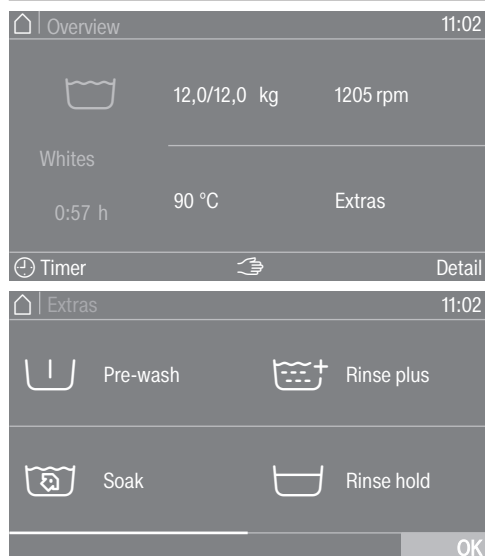

Touch one or several *Extras* to select it/them.  
Currently selected *Extras* are highlighted orange.  
To deselect an *Extra*, simply touch the *Extra* again.  
Use the *OK* sensor control to activate all selected *Extras*.

## Setting numerical values

You can set numerical values in some menus.

The following example shows how to set the time of day. The “Supervisor level” section describes how to get to this level.

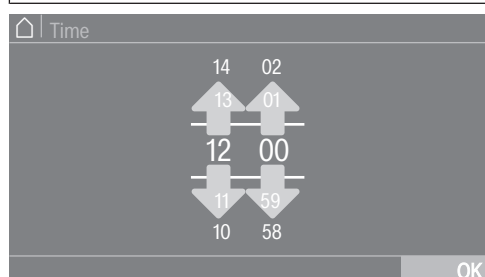

Enter the numbers by swiping upward or downward.  
Place your finger on the number that you want to change and move your finger in the direction you want. Use the *OK* symbol to accept the set numerical value.

**Tip:** A numerical keypad may also appear to adjust the value for some settings.

## Operating

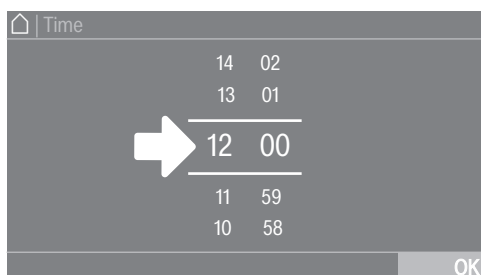

Briefly touching a number between the two lines will bring up the numerical keypad.

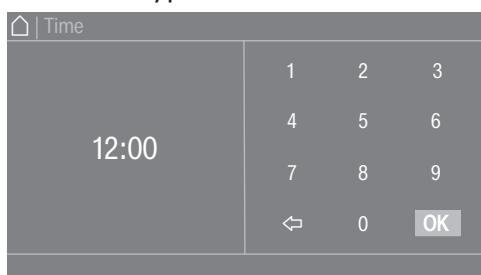

Once a valid number has been entered, the *OK* symbol will be highlighted green.

### Pull-down info

The following example describes the display for an ongoing wash program. The “Program start – program end” section describes how to get to this level.

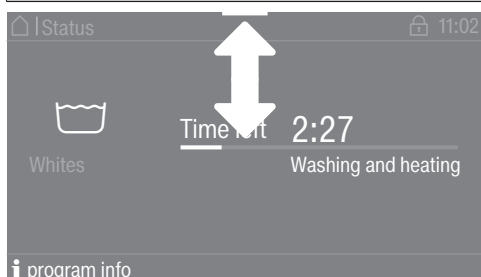

If an orange bar appears at the top of the screen in the middle of the display, you can open the pull-down menu. Drag the bar downward to display it. To hide it, slide the bar upward again.

### Exiting a menu level

- Touch the ↶ symbol to return to the previous screen.

Entries you have made before this which have not yet been confirmed with *OK* will not be saved.

## Operating a laundromat machine

The main menu will vary depending on the programming status (see “Supervisor level”).

Shortcuts are the easiest way to operate the machine. Operating staff are unable to change pre-set programs.

### Laundromat, basic

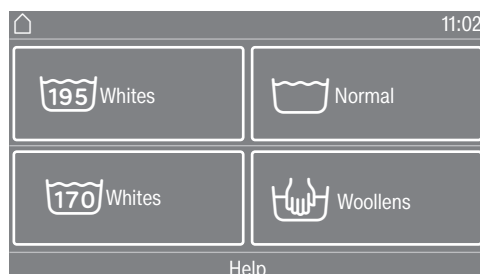

Between 4 and 24 pre-set programs are available. These programs cannot be changed by the user.

### Laundromat logo

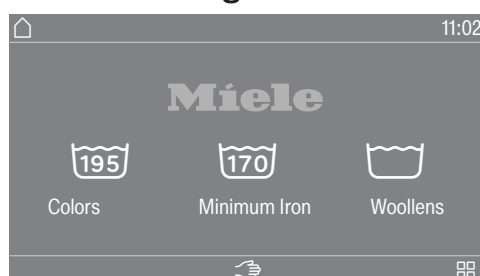

Up to 24 pre-set programs are available. The first 3 programs can be selected directly. The remaining programs are selected from a list . These programs cannot be changed by the user.

# Washing

## Preparing for use

### Emptying pockets

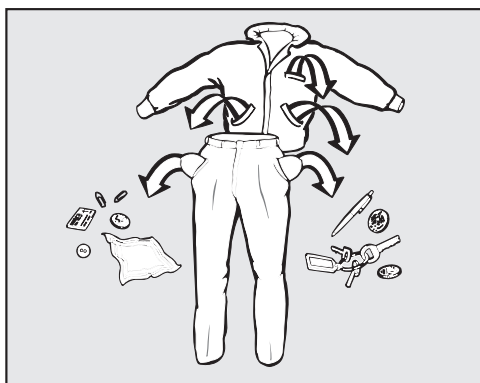

- Empty all pockets.

⚠ Damage due to foreign objects.  
Nails, coins, paper clips, and so on can cause damage to garments and components in the machine.  
Check the laundry before washing and remove any such foreign objects.

### Load sizes

(dry laundry)

PWM 912	PWM 916	PWM 920
max. 27 lb (12 kg)	max. 36 lb (16 kg)	max. 45 lb (20 kg)

Load sizes are given in the program chart.

### Sorting the laundry

- Sort the laundry according to color and the garment care label.

### Preparing mops, all-purpose cloths, etc.

- Shake mops, all-purpose cloths, and pads out well to get rid of coarse soiling before placing them in the washing machine drum.

### Pre-treating stains

- Badly soiled areas and stains should be cleaned as soon as possible. Stains should be carefully dabbed off using a soft, colorfast cloth.

### General tips

- Do not machine wash items which are specified by the manufacturer as not washable on the care label (☒).
- Curtains: Remove rollers and lead weights or place in a laundry bag.
- Sew in or remove any loose underwiring in bras.
- Turn garments inside out, if recommended by the manufacturer.
- Close any zippers and velcro fasteners before washing.
- Fasten duvet covers and pillow cases to prevent small items from becoming rolled up inside them.
- Please refer to the “Program chart” for more tips and tricks.

## Loading and switching on the washing machine

### Loading the washing machine

- Switch on the washing machine with the ⏻ button.
- Pull the door handle to open the drum door.
- Unfold the laundry and load loosely into the drum. Mixing both large and small items gives better wash results and also helps distribute the load evenly during spinning.

The most efficient energy and water consumption is achieved when a full load is washed. However, do not overload as this makes cleaning less effective and causes creases.

## Closing the drum door

- Close the drum door by pressing it until the pre-latch engages.



⚠ Make sure that no items are caught between the drum door and the sealing ring.

The drum door engages, but is not securely locked yet. The drum door locks automatically as soon as the machine starts.

## Washing with detergent drawer

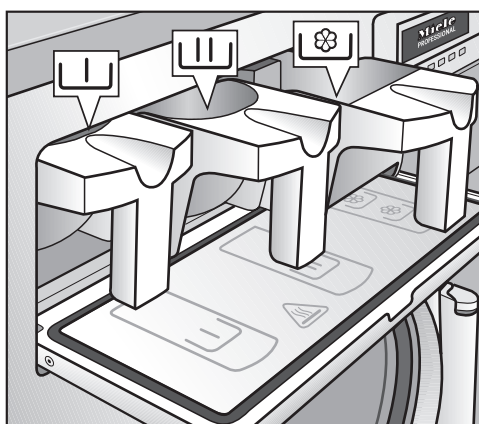
### Adding detergent using the detergent drawer



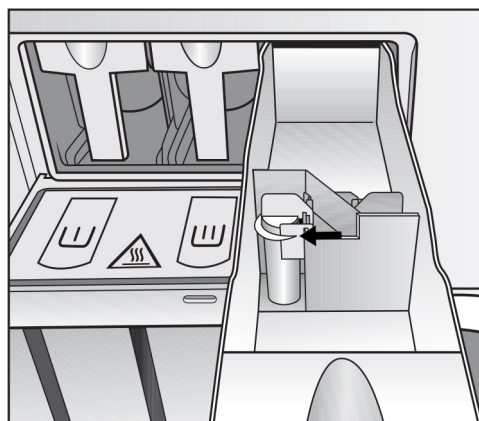

- For standard programs, add powder detergent for the main wash to the  compartment and if desired, add detergent for a pre-wash to the  compartment. Add fabric softener to the front of the  compartment.

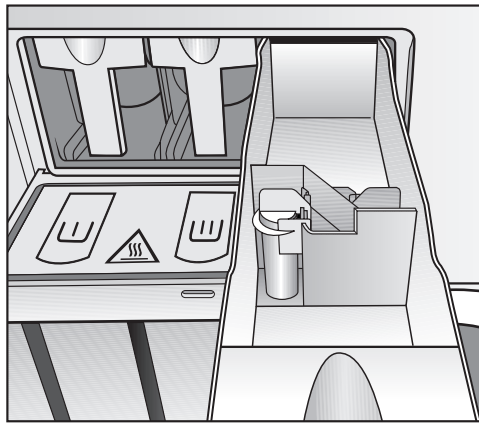

- Add any other liquid agents to the back of compartment  (if this has been programmed).

## Washing



Do not fill the  compartments above the level marker with liquid agents. They will otherwise run through the siphon and into the drum before they are needed.

### Bleaching agent

Only use bleach on fabrics with the  $\Delta$  symbol on the care label.

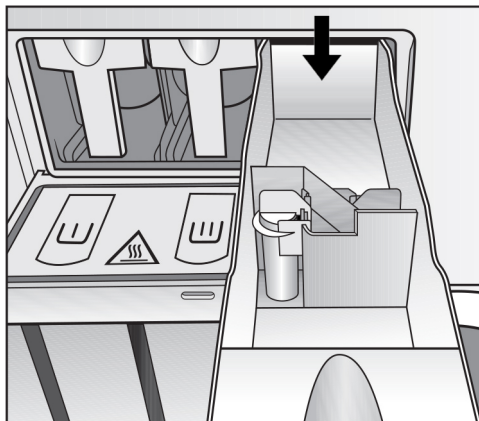

Liquid bleaching agents must only be dispensed through the designated dispenser drawer compartment. Only then it is ensured that the agent is added in to the second rinse cycle automatically. Liquid bleaching agents should only be used on colored items which have a wash care label stating that they are colorfast and suitable for bleaching.

 Frequent use of chlorine products increases the risk of damage to components.

### Dyes, dye removers, and descaling agents

Proprietary dyes, dye removers, and descaling agents may only be used in this machine if the manufacturer expressly states that they are suitable for use in a washing machine. The manufacturer's instructions on the packaging must be observed.

## Detergent dispensing

Avoid dispensing more than the required amount as this can cause excessive foaming.

- Only use low-foaming detergents.
- Follow the detergent manufacturer's recommendations.

The amount to dispense will depend on:

- the amount of laundry
- the water hardness
- the degree of soiling of the laundry

## Amount of detergent

Please dispense according to water hardness levels and follow the detergent manufacturer's instructions.

## Water hardness levels

Water hardness level	Total hardness in gpg	German scale °dH
Soft (I)	0-8.7	0-8.4
Medium (II)	8.7-14.6	8.4-14
Hard (III)	Above 14.6	Above 14

Check with your local water supplier if you do not know the water hardness level in your area.

## Selecting a program

### Programs

There are different ways to select a program.

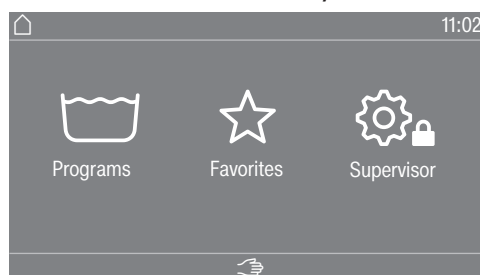

You can select a program from the Programs menu.

- Touch the Programs selection area.

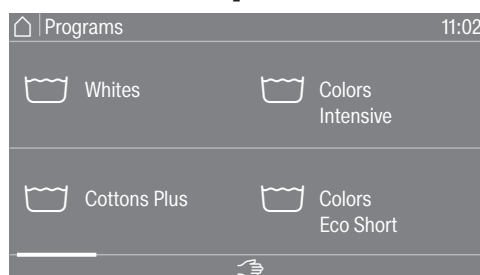

- Scroll to the right in the display until the program you want appears.
- Touch the required program on the touch display.

The display will change to the standard menu for that wash program.

# Washing

## Favorites

Alternatively, you can select a program from the Favorites menu.

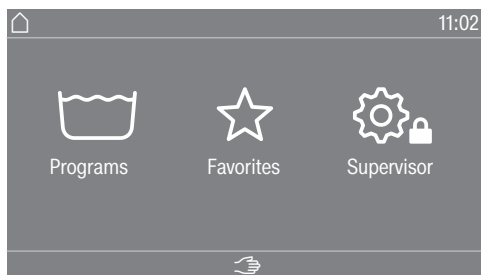

- Touch the Favorites selection area.

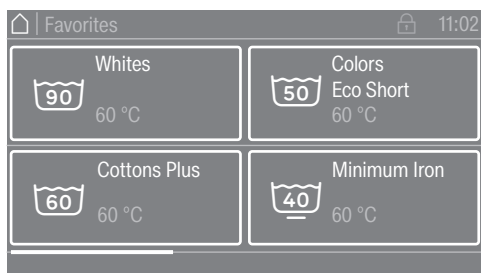

- Scroll to the right in the display until the program you want appears.
- Touch the required program on the touch display.

The display will change to the standard menu for that wash program.

In the case of favorite programs, the majority of the program settings are already fixed and cannot be changed.

## Selecting program settings

### Selecting the load size

To enable load-specific external dispensing and an adapted program sequence, you can specify the load size for some programs.

- Touch the Weight (kg) selection area.

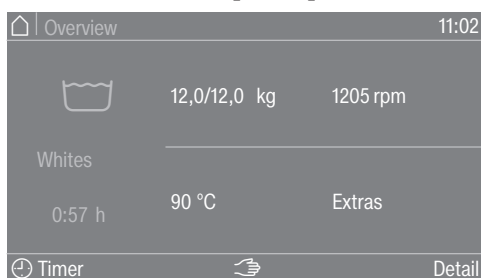

- Enter a valid value for the load size.

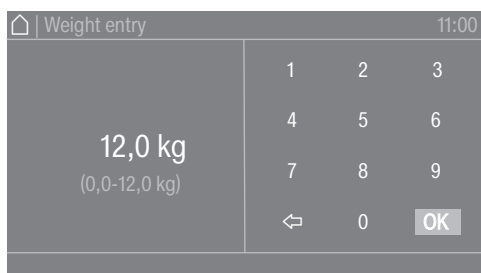

- Press the OK symbol.

The display will change to the Overview menu.

## Selecting a temperature

You can alter the preset temperature of a wash program.

- Touch the Temperature (°C) selection area.



- Select the desired temperature from the presets.

The display will change back to the Overview menu.

If you select the Finer adjustment selection area, you can set additional temperatures within the available temperature range by entering them directly.

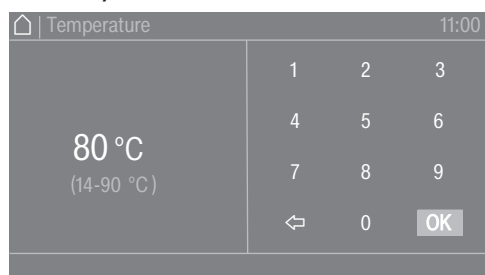

- Select the desired value using the keypad.
- Press the OK symbol.

The display will change back to the Overview menu.

The temperature can only be selected within the range specified below the current setting.

## Selecting a spin speed

You can alter the preset spin speed of a wash program.

- Touch the Spin speed (rpm) selection area.

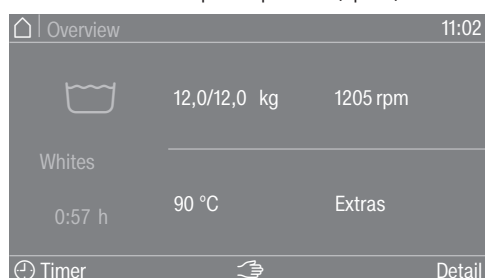

# Washing

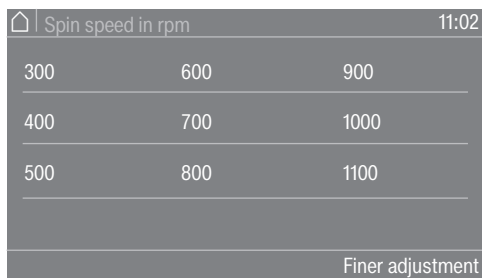

The orange scroll bar indicates that there are additional options to choose from.



- Select the spin speed you want from the presets.

The display will change back to the Overview menu.

If you select the Finer adjustment selection area, you can set additional speeds within the available speed range.

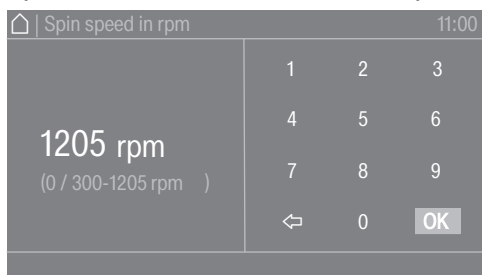

- Select the desired value using the keypad.
- Press the OK symbol.

The display will change back to the Overview menu.

The speed can only be selected within the range specified below the current setting.

PWM 912	0/300–1,205 rpm
PWM 916	0/300–1,120 rpm
PWM 920	0/300–1,120 rpm

## BoostSpin

For wash programs with maximum speed, the Boost Spin function is activated at the end of a wash program. This is done so that the laundry has the lowest possible residual moisture due to the maximum spin speed.

BoostSpin is activated at the factory but is displayed as **not** visible.

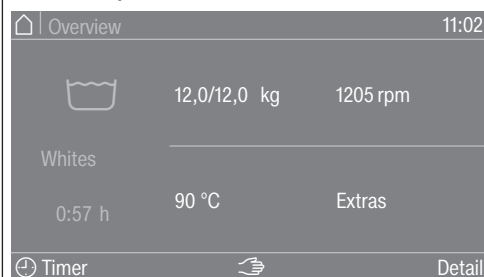

If the Boost Spin function is active and visible, the options are displayed under the  symbol.

- Touch the  symbol to select additional options.

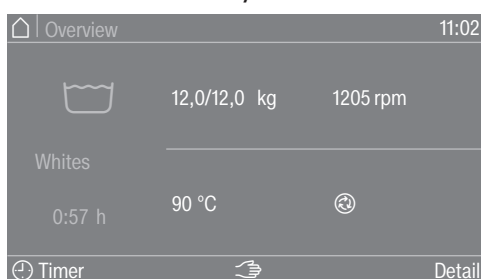

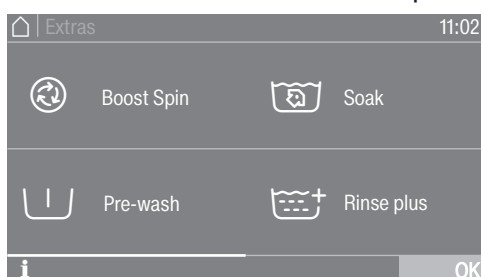

The Boost Spin function cannot be selected or deselected in the Options submenu. The symbol is displayed as active but cannot be changed.

- You can select additional options.



Information on BoostSpin can be found at .

If the  symbol is to be displayed, this setting can be adjusted at supervisor level. The options are then displayed under the  symbol.

- Open the Supervisor level (see “Supervisor level”).
- Open the Controls / Display menu.
- Select Visibility parameters and activate the BoostSpin parameter.

# Washing

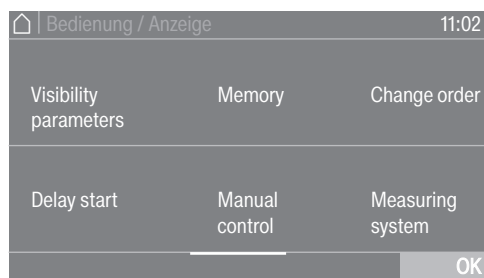

The BoostSpin visibility can be deactivated again in the order specified above.

If the BoostSpin visibility is deactivated, the text under the options is no longer displayed. The options are displayed again in the overview.

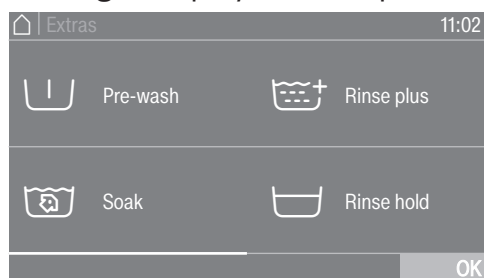



## Selecting Extras

### Selecting options

You can select options for some wash programs.

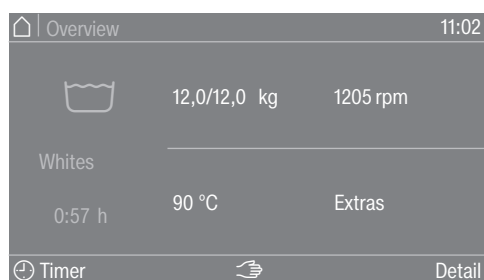
- Touch the Extras selection area.



If the Boost Spin function is active and visible, you can access the options by selecting the  symbol.

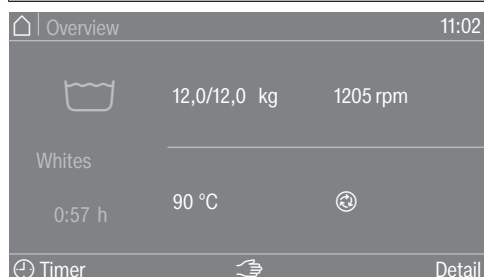

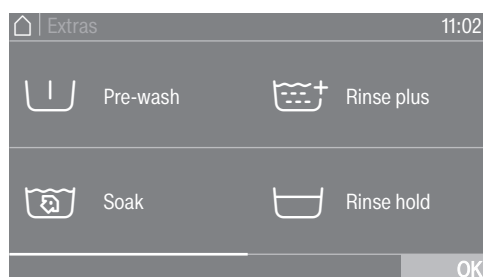

- Select one or more options.
- Press the OK symbol.

The display will change to the Overview menu.

## Pre-wash

A pre-wash can be added for heavily soiled laundry. Coarse soiling is loosened and removed before the main wash.

## Soak

For heavily soiled and stained items with protein stains. The soak duration is 10 minutes.

## Rinse plus

An extra rinse can be activated to achieve a more thorough wash result.

## Rinse hold

The laundry is not spun after the final rinse and remains in the rinse water. This helps prevent creasing if the laundry is not going to be removed from the washing machine drum immediately after the end of the program.

## Filling stop

Water is drained out of the machine before the final rinse and the program stops. The required starch, dye, proofing agent, etc. is added directly to the drum. The program is continued with the *Start/Stop* sensor control.

## Intensive

For hard-wearing laundry that is very heavily soiled. Extending the main wash increases cleaning efficiency.

## Water plus

The water level in the wash cycle will be increased.

## Program start – program end

**Starting a program** The program can be started as soon as the *Start/Stop* sensor control is flashing on and off.

- Touch the *Start/Stop* sensor control.

The door will lock ( symbol) and the wash program will start.

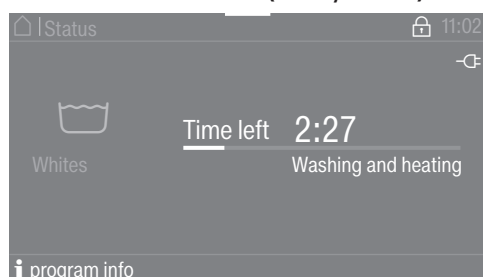

**Tip:** You can use the pull-down menu to display the selected temperature, spin speed, and any selected Extras.

If a delay start period ( Timer) has been selected, this will appear in the display at the bottom left.

# Washing

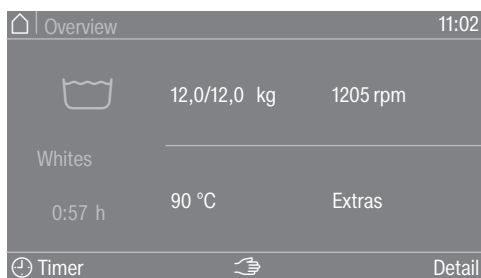

If you select the **i** program info selection area, all program-related information will be displayed.

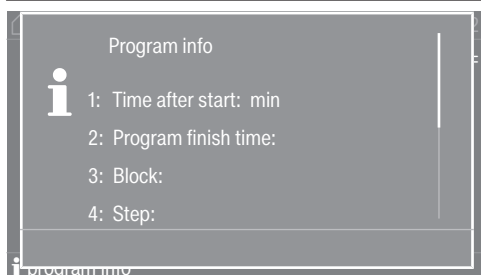

The program runtime will appear in the display either straight away or once the delay start period has elapsed. The program sequence is also shown in the display.

## End of the program

Depending on the setting selected in the supervisor level or in the program, the machine will switch to the anti-crease action cycle at the end of the program. The door remains locked. The door can be unlocked at any time by touching the *Start/Stop* sensor control.

## Removing the laundry

- Pull open the door.
- Remove the laundry.

Items left in the drum could discolor other items in the next wash or become discolored themselves.  
Remove all items from the drum.

- Check the door sealing ring for any foreign objects.
- Tip:** Leave the door slightly open to allow the drum to dry.
- Switch the washing machine to Standby with the  button.
- Tip:** Leave the detergent drawer slightly open to allow it to dry.

## Timer

The timer can be used to select a program start date, program start time, or program end time. This mode is also referred to as delay start.

### Setting the timer

- Touch the  Timer selection area.

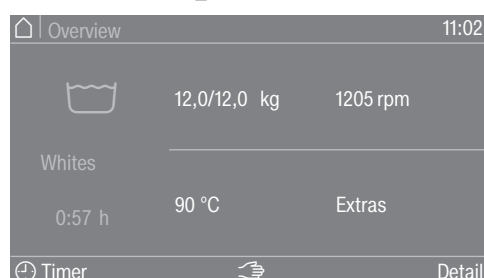

- Select option Finish at, Start date, or Start at.

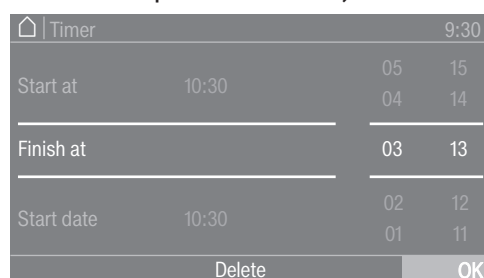

- Set the hours and the minutes or the date and confirm with the OK symbol.

### Deleting the timer

The selected delay start period can be canceled before the program starts.

- Touch the selection area with the selected settings in the timer field, e.g., 01.01. 11:00.

The selected delay start period will appear in the display.

- Touch the Delete selection area.

- Confirm with the OK symbol.

The selected delay start period is deleted.

### Starting the timer

- Touch the *Start/Stop* sensor control.

The door will lock and the time until the program starts will appear in the display.

After the program has started, the selected delay start period can only be changed or canceled by interrupting the program.

The program can be started immediately at any time.

- Touch the Start immediately selection area.

## Special features in the program sequence

### Spinning

#### Final spin speed

When a program is selected, the maximum spin speed for this wash program is shown in the display in the pre-start menu.

You can reduce the final spin speed.

Depending on the program, it may also be possible to increase the speed. The setting options are displayed when you tap the spin speed.

#### Rinse-spin

There is a spin cycle after the main wash and between the rinse cycles. A reduction in the final spin speed will also reduce the rinse-spin speed as appropriate.

### Anti-crease

At the end of the program, the drum continues to turn at intervals for up to 30 minutes to help prevent creasing.

The drum door cannot be opened until the program has ended.

Anti-crease is program-dependent. The option can be switched on or off in the supervisor level.

### Skip

The Skip function enables users to skip forward or backward in the program sequence. The program sequence is continued from the selected step.

If a program is interrupted using the *Start/Stop* sensor control, the Skip ⏩ function is available in the program stop screen.

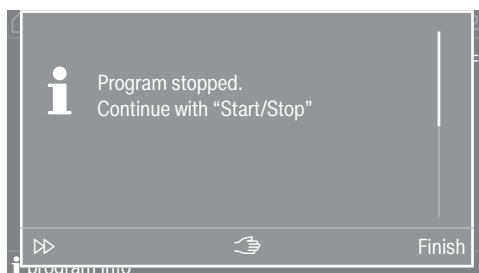

If the Skip ⏩ function is selected, the required program step can be selected via the display.

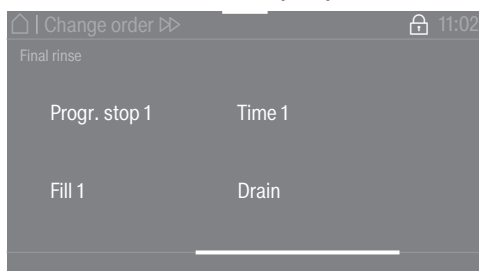

The program can then be continued with the *Start/Stop* sensor control.

## Manual control

Manual control is possible either before a program is started or when a program has been stopped.

### Switching to manual control

Manual control is possible before a program is started or when a program has been stopped.

- Press the  “Manual control” button to access the password entry screen.

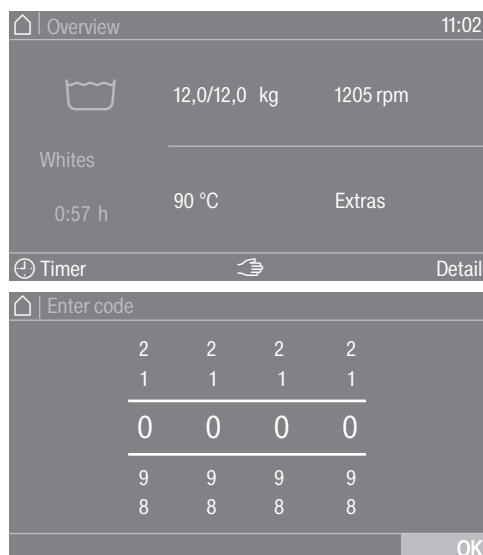

- Enter the password.
- Confirm the password entry with the OK sensor control.

The Manual control menu is displayed:

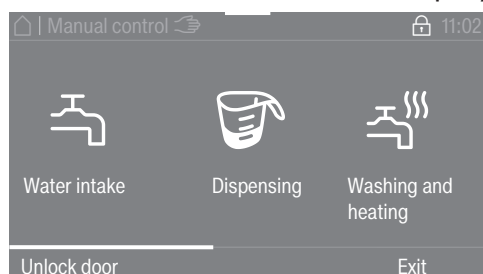

The current level, spin speed, and temperature statuses of the machine appear orange.

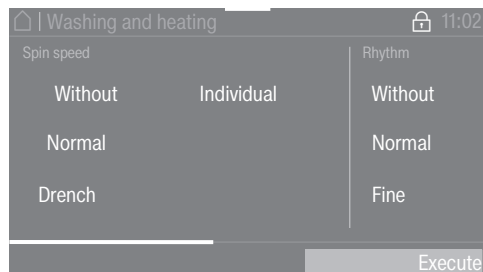





- Select the setting you want.
- Confirm the entry with the Execute sensor control.

The submenus appear in various operating modes. See “Examples of how to operate the machine” for an in-depth description.

## Special features in the program sequence

The function buttons are assigned with specific manual control functions:

- Water inlet 
- Dispensing 
- Washing and heating 
- Drain with drum rotation 
- Spin 

- Press the button again to end a selected function.

### Water intake

Water intake valves and the water level can be set.

- Press the  Water intake function button.
- Select the desired value.
- Confirm your selection with the Execute sensor control.

If a higher numerical value is set, the values below this will no longer be displayed.

The wash program will start or continue.

### Dispensing

The dispensing quantity for the various dispenser pumps can be set.

This function is only possible if the Connector Box, the dispenser pumps, and automatic dispensing have been selected in the supervisor level; see “Supervisor level” section.

- Press the  Dispensing function button.
- Select the desired dispenser pump and dispensing quantity, e.g., D1 50 mL.
- Confirm your selection with the Execute sensor control.

The wash program will start or continue.

### Washing and heating

Spin speed, rhythm, and temperature can be set.

- Press the  Washing and heating function button.
- Select the desired settings.

The selected setting will appear in orange in the multiple selection.

- Confirm your selection with the Execute sensor control.

The wash program will start or continue.

### Drain with agitation

Drain path, spin speed, and rhythm can be set.

- Press the  Drain with agitation function button.
- Select the desired settings.

The selected setting will appear in orange in the multiple selection.

- Confirm your selection with the Execute sensor control.

### Spin





The spin speed can be set.

- Press the  Spin function button.
- Select the desired value.
- Confirm your selection with the Execute sensor control.

The wash program will start or continue.

## Special features in the program sequence

**Function combinations** Water inlet, dispensing, washing and heating can be selected simultaneously in any combination\*.

 Water inlet	 Dispensing	 Washing and heating	 Drainage with agitation	 Spinning
<input checked="" type="checkbox"/>	<input checked="" type="checkbox"/>	<input type="checkbox"/>	<input type="checkbox"/>	<input type="checkbox"/>
<input type="checkbox"/>	<input checked="" type="checkbox"/>	<input checked="" type="checkbox"/>	<input type="checkbox"/>	<input type="checkbox"/>
<input checked="" type="checkbox"/>	<input type="checkbox"/>	<input checked="" type="checkbox"/>	<input type="checkbox"/>	<input type="checkbox"/>
<input checked="" type="checkbox"/>	<input checked="" type="checkbox"/>	<input checked="" type="checkbox"/>	<input type="checkbox"/>	<input type="checkbox"/>

\* possible function combinations

## Special features in the program sequence

### Weighing system

If the machine is equipped with a weighing base, the load size is displayed in 0.4 lb (0.2 kg) increments during loading. The maximum load size for the selected program is displayed beside it.

### Resetting the load display to zero

Do not place any items on the machine. Do not lean against the machine.

This can influence the result of the measurement.

If the load display does not show “0.0” with an empty drum, set the display to 0 using the Tare sensor control.

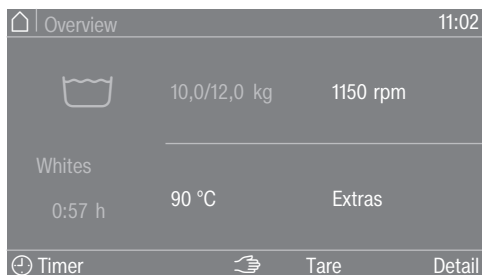

- If after resetting to 0 (taring), you discover an overlooked item in the drum, the following will appear in the display:

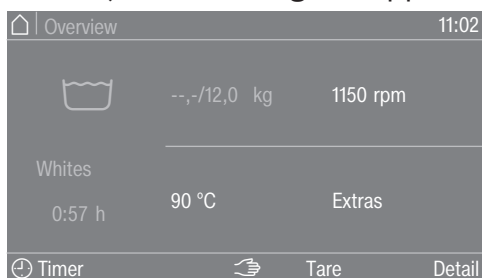

- Reset the display to 0 using the Tare sensor control.

**Tip:** If the machine is overloaded, for example when laundry is wet, it will operate in accordance with the nominal load after the program starts. This value is also saved in the operating data module.

If the weighing system is not working correctly, a message is displayed. The nominal load of the machine is assumed. The weight input can be entered manually.

## Changing a program

### Altering the wash program

You will need to cancel the current program before you can select a new one.

## Interrupting a program

You can interrupt a wash program at any time after it has started.

If the program is locked, the disinfection programs or payment programs can only be canceled by entering a code.

- Touch the *Start/Stop* sensor control.

The following will appear in the display:

**i** Program stopped. Continue with "Start/Stop"

The following will appear in the display:



- Select Finish.

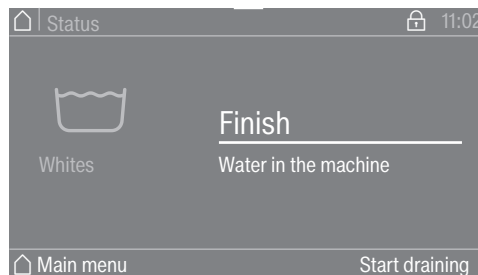

The suds are not drained so they can be used again in a subsequent program. Once the program has ended, the program end screen is displayed. It is possible to switch to the main menu while the suds are in the drum or to drain the suds by pressing the Start draining control. If permanent automatic water drainage is required, Automatic drainage can be activated at supervisor level.

The drum door remains locked while there is water in the machine.

The door can be opened under the condition Program end without water. If the temperature is too high, wait until it has cooled down so that the door can be opened.

- Wait until the door unlocks.
- Pull open the door.
- Remove the laundry.

## Switching on the washing machine after a power failure

If the washing machine is switched off with the  button during a wash program, the program will be interrupted.

- Switch the washing machine back on with the  button.

## Changing the program sequence

---

- Note the message in the display.
- Touch the *Start/Stop* sensor control.

The program continues.

### Adding or removing laundry

You can add or remove laundry for a short period immediately after the program has started.

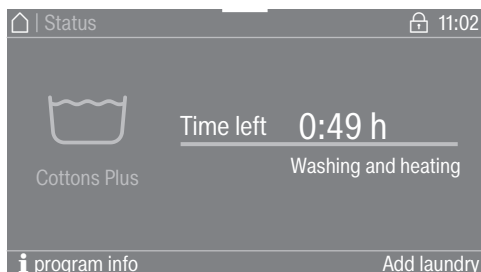

- Touch the *Add laundry* selection area.

If the message *Add laundry* is not visible in the display then it is no longer possible to add items of laundry.

The wash program will stop and the door will unlock.

 Risk of chemical burns from detergent.  
When adding or removing laundry, your skin may come into contact with detergent, particularly if the detergent is dispensed externally. Take care when placing your hands inside the drum. If suds have come into contact with the skin, rinse off immediately with plenty of lukewarm water.

- Pull open the door.
- Add laundry or remove individual items.
- Close the door.
- Touch the *Start/Stop* sensor control.

The wash program will continue.

### Troubleshooting

#### Power outage during the wash process

- Disconnect the machine from the power supply (see “Safety notes”).
- Close the on-site shut-off valves for water or steam.

If there is water in the machine, first open the drain valve manually and then manually unlock the drum door to remove the laundry.

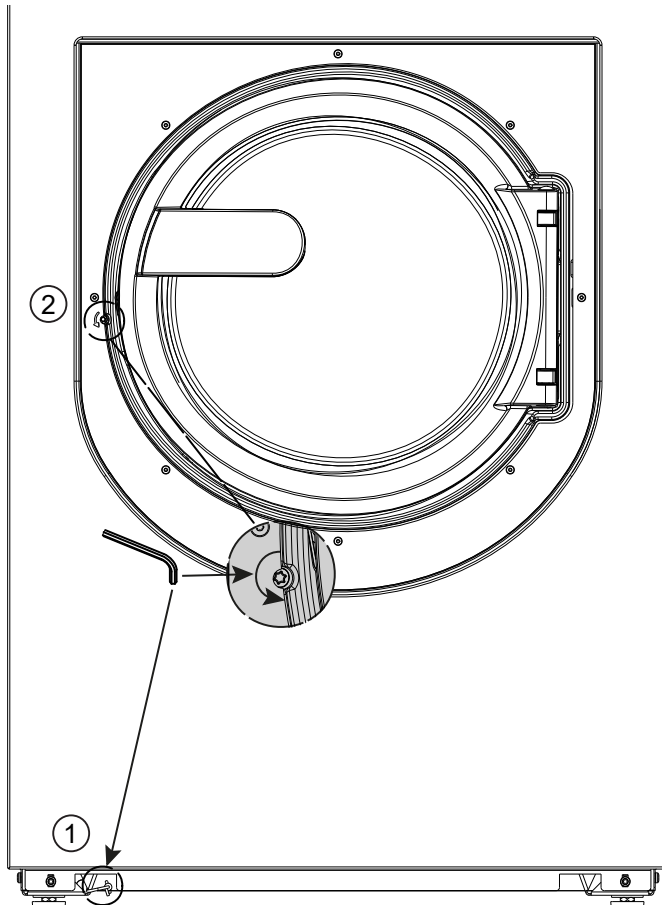

- Guide the T 40 Torx wrench for the emergency door release through the eye ① on the front of the machine.

On the washing machine with the weighing base option, the eye is located on the rear of the machine.

- Open the drain valve by pulling the eye ① using the Torx wrench.
- Keep pulling the eye until the suds have drained away completely.  
The suds will drain away.

The emergency drain closes automatically when the Torx wrench is removed from the eye.

- Push the eye ① back in as far as it will go.

#### Unlocking the door

The drum door cannot be opened during a power outage.

**⚠ Danger from rotating drum and danger of scalding.**  
Before inserting the Torx wrench, make sure that the machine is disconnected, the drum has stopped, and there is no water in the machine.

## Frequently asked questions

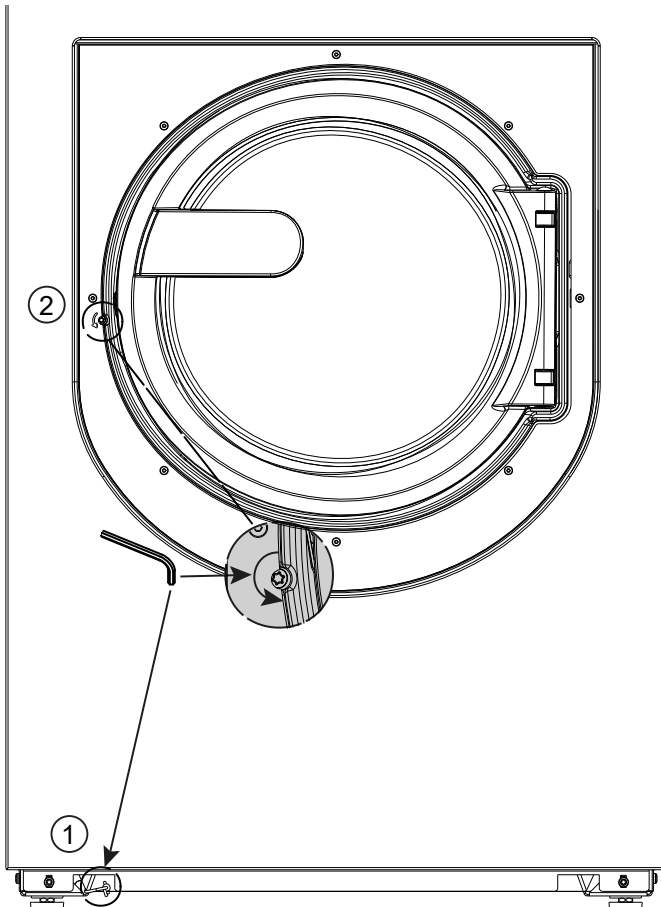

- Using a T 40 Torx wrench, turn the release element with the inner hexagon ② two whole revolutions **counterclockwise in the direction of the arrow**.

**Tip:** Pushing on the door at the same time makes it easier to turn the emergency release mechanism.

The release element is opposite the door hinge at the same height as the door handle (see diagram).

The release element must not be turned against the direction of the arrow.  
The door lock will be damaged.

The resistance will noticeably decrease. When the release element moves freely, the door is unlocked.

**Tip:** The release element does not need to be screwed back in.

The door can now be opened.

Suitable protective clothing must be worn when unloading the drum.

### Contact in case of fault

In the event of a fault which you cannot remedy yourself, please contact your Miele dealer or Miele Technical Service.

Contact information for Miele Technical Service can be found at the end of this document.

Please quote the model and serial number of your appliance when contacting Miele. Both pieces of information can be found on the data plate.

The data plate is on the back of the machine at the top and on the inside of the drum door.

### Frequently asked questions

The majority of faults and problems that arise during day-to-day use can be remedied without external assistance. You can save time and money in many cases, as you do not need to contact Miele Customer Service.

The following tables are designed to help you to find the cause of a malfunction or an error and to resolve it. However, please note:





 Repair work to electrical appliances must only be carried out by an authorized technician. Incorrect repairs can cause considerable danger to users.

### The wash program will not start



Problem	Possible cause and solution
<b>The display remains dark, and the <i>Start/Stop</i> sensor control does not light up or flash.</b>	There is no power to the washing machine. <ul style="list-style-type: none"> <li>■ Check whether the washing machine is switched on.</li> <li>■ Check whether the washing machine is connected to the power supply.</li> <li>■ Check whether the fuse has tripped.</li> </ul>
	The washing machine has switched off automatically to save energy. <ul style="list-style-type: none"> <li>■ Switch the washing machine back on with the  button.</li> </ul>
<b>The following appears in the display: F -Door lock fault.</b> You can continue by pressing the "Start/Stop" button	The door has failed to lock. <ul style="list-style-type: none"> <li>■ Close the door again.</li> <li>■ Start the program again.</li> </ul> If the fault message appears again, contact Miele Service.
<b>The display is dark and the <i>Start/Stop</i> sensor control is flashing slowly.</b>	If the Standby function has been activated at supervisor level, the display switches off automatically to save energy. <ul style="list-style-type: none"> <li>■ Touch any of the controls. The display switches back on.</li> </ul>
<b>The program is on the pre-start screen and the <i>Start/Stop</i> sensor control is not flashing.</b>	The drum door has been pushed to but is not closed correctly. <ul style="list-style-type: none"> <li>■ Check whether the drum door is closed correctly.</li> </ul>

# Frequently asked questions

## Program cancellation and fault message

Problem	Possible cause and solution
 F - Water drainage fault. If restart fails, contact Service.	The drain is blocked or restricted. <ul style="list-style-type: none"> <li>■ Check the drain paths and clean them if necessary.</li> </ul>
 F - Water intake fault. If restart fails, contact Miele.	The water inlet is blocked or restricted. <ul style="list-style-type: none"> <li>■ Check whether the water inlet is turned on properly.</li> <li>■ Check the water inlet hoses for leaks.</li> <li>■ Check whether the water connection pressure is sufficient.</li> <li>■ Check whether the water inlet hoses are kinked.</li> </ul>
	The water inlet filters are blocked. <ul style="list-style-type: none"> <li>■ Clean the filters.</li> </ul>
 Disinfection temperature not reached	The required temperature was not reached during the disinfection program. <ul style="list-style-type: none"> <li>■ The washing machine has not carried out the disinfection cycle correctly.</li> <li>■ Restart the program.</li> </ul>
 Fault F. If restart fails, contact Service.	There may be a fault. <ul style="list-style-type: none"> <li>■ Disconnect the washing machine from the power supply.</li> <li>■ Wait at least 2 minutes before reconnecting the washing machine to the power supply.</li> <li>■ Then switch the washing machine on again.</li> <li>■ Restart the program. If the fault message appears again, contact Miele Service.</li> </ul>
Emergency release. Program stopped. Please close the door and turn the machine off and then back on again.	The door emergency release has been activated. <ul style="list-style-type: none"> <li>■ Close the door and switch the machine off and on.</li> </ul> <p>The interrupted program can be continued once the machine has been restarted.</p>

## The display shows a message

Problem	Possible cause and solution
 Container empty	One of the liquid dispensing detergent containers is empty. <ul style="list-style-type: none"> <li>■ Refill the detergent containers.</li> </ul>
 Dispensing container empty. Continuing without automatic dispensing via "Start/Stop" possible.	One of the liquid dispensing detergent containers is empty; the program is stopped. <ul style="list-style-type: none"> <li>■ Refill the detergent container and press the Start/Stop button to continue the wash program.</li> <li>■ If it is not possible to refill the detergent container, press the Start/Stop button to continue the wash program without detergent.</li> </ul> <div style="border: 1px solid gray; padding: 5px; margin-top: 10px;"> <p>Insufficient disinfection  Disinfection programs must be canceled as no disinfectant can be added.</p> </div>

## Frequently asked questions

Problem	Possible cause and solution
<b>i</b> Hygiene info: run a program of at least 60°C	During the last wash, a wash program with a temperature below 140°F (60°C) was selected. <ul style="list-style-type: none"> <li>■ Start a program with a minimum temperature of 140°F (60°C) or the Clean MachineExtrasIntensive program.</li> </ul>
Weighing system defective. Please enter the weight manually.	The weighing system is faulty. <ul style="list-style-type: none"> <li>■ Enter the weight manually.</li> </ul>



### Insufficient wash results

Problem	Possible cause and solution
<b>Liquid detergent is not achieving the required results.</b>	Liquid detergents usually contain no bleaching agents. They do not remove fruit, coffee, or tea stains. <ul style="list-style-type: none"> <li>■ Use powder detergent containing a bleaching agent.</li> <li>■ Pour powder stain remover into drawer  in the dispenser compartment and liquid detergent into a dispenser ball.</li> <li>■ Never put powder stain remover and liquid detergent together in the detergent drawer.</li> </ul>
<b>White residues which look like powder detergent are seen on dark textiles after washing.</b>	The detergent contained compounds (zeolites) to aid water softening which are not soluble in water. These have ended up on the laundry. <ul style="list-style-type: none"> <li>■ Try and brush off the residues with a soft brush once the laundry is dry.</li> <li>■ In the future, wash dark textiles using a detergent which contains no zeolites. Liquid detergents do not usually contain zeolites.</li> </ul>
<b>Textiles that were very greasy are not properly clean.</b>	<ul style="list-style-type: none"> <li>■ Select a program with pre-wash. Use liquid detergent for the pre-wash.</li> <li>■ Continue to use universal powder detergent for the main wash.</li> </ul>
	The use of heavy-duty detergent is recommended in the main wash for very heavily soiled workwear. Please seek advice from the detergent and cleaning agent manufacturer.
<b>There are gray, oily particles clinging to washed laundry.</b>	Not enough detergent was dispensed. The laundry was heavily soiled with grease (oils, ointments). <ul style="list-style-type: none"> <li>■ Use more detergent or liquid detergent with this type of soiled laundry.</li> <li>■ Before washing the next load, run a 140°F (60°C) program with liquid detergent and no load.</li> </ul>

### General problems with the washing machine

Problem	Possible cause and solution
<b>The washing machine shakes during the spin cycle.</b>	The machine is not standing evenly. <ul style="list-style-type: none"> <li>■ The washing machine must be secured to the floor on site according to the instructions on the I-Plan.</li> </ul>

## Frequently asked questions

Problem	Possible cause and solution
<b>Large amounts of detergent residue remain in the detergent drawer.</b>	The water flow pressure is too low. ■ Clean the water inlet filters.
	Powder detergent used in conjunction with water softeners tends to become sticky. ■ Clean the detergent drawer and, in future, add detergent first and then the water softener.
<b>Fabric softener is not completely dispensed or too much water remains in the  compartment.</b>	The siphon is not correctly positioned or is clogged up. ■ Clean the siphon (see “Cleaning the detergent drawer” under “Cleaning and care”).
<b>The display is in a different language.</b>	A different language has been selected. ■ Switch the washing machine off and on again. The selected supervisor language appears in the display.
	The supervisor language has been changed. ■ Select the language you require (see “Supervisor level – Language”).
<b>The laundry has not been spun properly. The laundry is still wet.</b>	The machine detected a high level of imbalance during the final spin and reduced the spin speed automatically. ■ Include both large and small items in the load as this will achieve better distribution.
<b>The drum remains stationary but the program keeps running.</b>	Fault in the program sequence ■ Switch the washing machine off and then back on with the  button. ■ Note the message in the display. ■ Touch the <i>Start/Stop</i> sensor control. The drum continues to spin and the program continues.

### The door will not open or close

Problem	Possible cause and solution
<b>The door will not open.</b>	There is no power to the washing machine. <ul style="list-style-type: none"> <li>■ Check whether the washing machine is switched on.</li> <li>■ Check whether the washing machine is connected to the power supply.</li> <li>■ Check whether the fuse has tripped.</li> </ul>
	Power outage <ul style="list-style-type: none"> <li>■ Open the drum door as described in “Frequently asked questions”.</li> </ul>
	The water in the washing machine cannot be drained. <ul style="list-style-type: none"> <li>■ Check whether the drainage system is blocked. Clean the drainage system.</li> </ul>
	The door is locked during the wash process. <ul style="list-style-type: none"> <li>■ Touch the <i>Start/Stop</i> sensor control.</li> <li>■ Select Program abort or Add laundry.</li> </ul> The door will unlock and you will be able to pull it open.
	There is still water in the drum and the washing machine is unable to drain. <ul style="list-style-type: none"> <li>■ Empty the drainage system as described in “Frequently asked questions”.</li> </ul>
	To protect the user against scalding, the drum door cannot be opened if the suds temperature is higher than 122°F (50°C).
<b>The door cannot be opened.</b>	The door is locked during the wash process. <ul style="list-style-type: none"> <li>■ Touch the <i>Start/Stop</i> sensor control.</li> <li>■ Select Program abort or Add laundry.</li> </ul> The door will unlock and you will be able to pull it open.
	There is still water in the drum and the washing machine is unable to drain. <ul style="list-style-type: none"> <li>■ Empty the drainage system as described in “Frequently asked questions”.</li> </ul>
<b>The door will not close.</b>	Lint or foreign particles are trapped on the door ring. <ul style="list-style-type: none"> <li>■ Check the sealing points on the door ring.</li> <li>■ Remove lint or foreign particles using your fingers and damp hand towels.</li> </ul>
<b>At the end of a program or when a program is canceled, the following appears in the display:</b> Cooling down.	To protect the user against scalding, the door cannot be opened if the suds temperature is higher than 122°F (50°C). <ul style="list-style-type: none"> <li>■ Wait until the temperature in the drum has decreased and the message has gone out in the display.</li> </ul>
<b>The following appears in the display:</b> F - Door lock fault. Contact Service.	The door lock has jammed. <ul style="list-style-type: none"> <li>■ Contact Customer Service.</li> </ul>

## Frequently asked questions

---

### Continuing a program after a power failure

If a running program is interrupted, e.g., by a power outage, the program can be continued when power is restored.

- Switch on the washing machine with the  button.
- Then press the “START” button and follow the instructions on the display.

The program will then continue with the next stage of the last active program sequence.

- Carry out cleaning and maintenance of the washing machine after use if possible.

Do not use a pressure washer or water jet to clean the washing machine.

- Clean the **machine casing, control panel, and plastic parts** with a mild, non-abrasive cleaning agent or with a soft, damp cloth only. Wipe dry with a soft cloth.

Scouring agents will scratch the surface.

- Clean stainless steel parts of the casing with a standard commercial stainless steel cleaner.
- Remove any deposits from the door seal with a damp cloth.

Do not allow cleaning agents to penetrate the electrical components.

- When disinfecting the surfaces, use a moist cloth only to clean the front and around the door lock. Do not spray any liquids.

**Tip:** Heavy deposits of dust around the vents housing should be removed with a vacuum cleaner. The fan casing is located on the back of the machine.

### **Build-up of rust**

The drum is made of stainless steel. Water or foreign objects containing ferrous substances (e.g., paper clips, metal buttons, or metal swarf) which are placed in the machine with the laundry can cause a build-up of rust in the drum. Clean the drum regularly in this case and if rust occurs, remove it immediately with a proprietary stainless steel care product. Check the door seals for ferrous residues and clean thoroughly as described above. This must be carried out regularly.

## Cleaning and care

---

### Cleaning the detergent drawer, detergent compartments, and siphons

- Clean the detergent drawer and the detergent compartments thoroughly with hot water as required to remove detergent residues.
- If the machine is not going to be used for a long time, leave the flap of the detergent drawer open.
- Also clean the siphons in the compartments for cleaning agents.

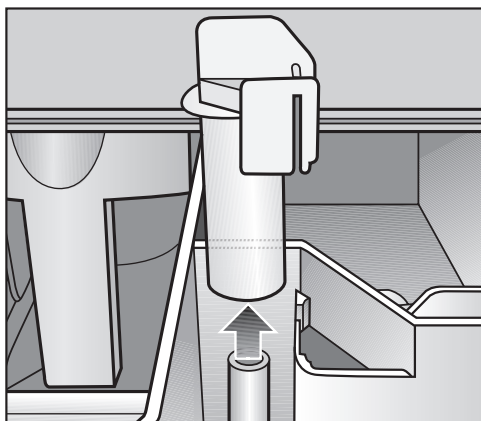

- Remove the siphon. Clean the siphon with hot water and reinsert it.
- Open the flap on the detergent drawer to an angle of 45° and lift out the flap of the detergent drawer on the right side.

### Cleaning the drip channel and siphon

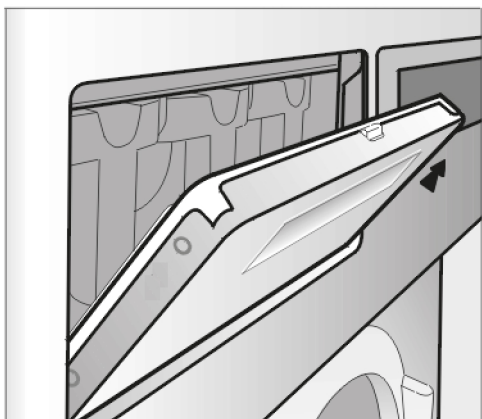

If the drip channel and associated drain connection are blocked, clean them.

- Check the vapor extraction grille on the rear of the machine for soiling from time to time and clean when necessary.

### Cleaning the water inlet filters

The washing machine has filters to protect the water intake valves. You should inspect the filters approximately every 6 months. Check the filters more often if there are frequent interruptions to the external water supply.

#### Cleaning the filters in the inlet hoses

- Turn off the faucet.
- Unscrew the inlet hose from the faucet.

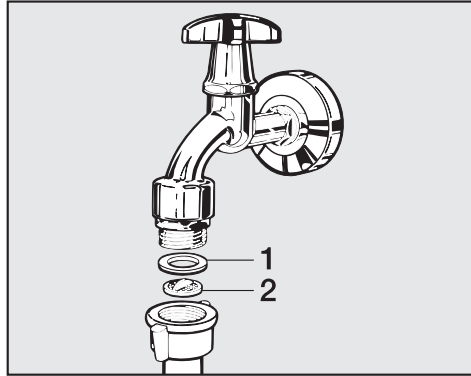

- Remove the rubber seal (1) from the recess.
- Using combination or needle-nose pliers, take hold of the plastic filter bar (2) and remove it.
- Clean the plastic filter.
- Re-assemble in reverse order.

Turn on the faucet and check that the connection is watertight. If water drips out, tighten the connection.

#### Cleaning the filters in the water intake valves

- Use needle-nose pliers to withdraw the filter by the bar and clean it. Re-assemble in reverse order.

#### Damage caused by dirty water

A filter is located in the open end of the inlet hose and another in the intake point to protect the water intake valves.

Neither filter may be removed.

### Cleaning the drum, suds container, and drainage system

By using wash programs with temperatures of 140°F (60°C) or higher on a regular basis and using a universal detergent, you can avoid a build-up of bacteria in the washing machine.

Use the *Clean Machine* program regularly, especially if you frequently use wash programs with low temperatures.

Optimum results can be achieved by using a machine cleaner. Alternatively, a universal detergent can be used.

- Start the Clean Machine/Extras/Intensive program.
- Dispense the machine cleaner or universal detergent directly into the drum.
- Do **not** load any laundry. The drum must be empty for the Clean Machine program.

## Cleaning and care

---

- At the end of the program, check the inner drum and remove any coarse residues.

Use the *Clean Machine* program regularly if you frequently use disinfection programs.

## Installing the washing machine

The washing machine must be installed by Miele Service or by an authorized dealer. Please observe the instructions in the installation plan.

This washing machine is only intended for items of laundry that have not been proofed with dangerous or inflammable substances.

- To avoid the risk of frost damage, the washing machine must not be located in rooms which may be subject to very low temperatures.
- Transport the machine on a pallet truck inside the room.

Machines with feet must not be pushed to move them. This could damage the machine feet.

- Remove the packaging carefully with a suitable tool.
- Lift the machine off the pallet using a lifting device.

## Securing the machine

- The feet of the washing machine must be secured to the floor using the fixtures and fastenings supplied.

The material provided is intended for use in bolting the machine to a concrete floor. If other floor types are present at the installation site, the fastening material must be ordered separately.

## General operating conditions

This washing machine is intended only for use in a commercial environment and must only be operated indoors.

Ambient temperature in installation room: 32°F (0°C) to 140°F (40°C)

Relative humidity: non-condensing

Depending on the nature of the installation site, sound emissions and vibration may occur.

**Tip:** Have the machine's installation site inspected and seek the advice of a specialist in instances where increased noise may cause a nuisance.

## Performing maintenance

To facilitate future maintenance and servicing by Miele Service, the minimum clearances and distance to the wall must be provided to enable access.

- You must observe the minimum clearances and distance from the wall.

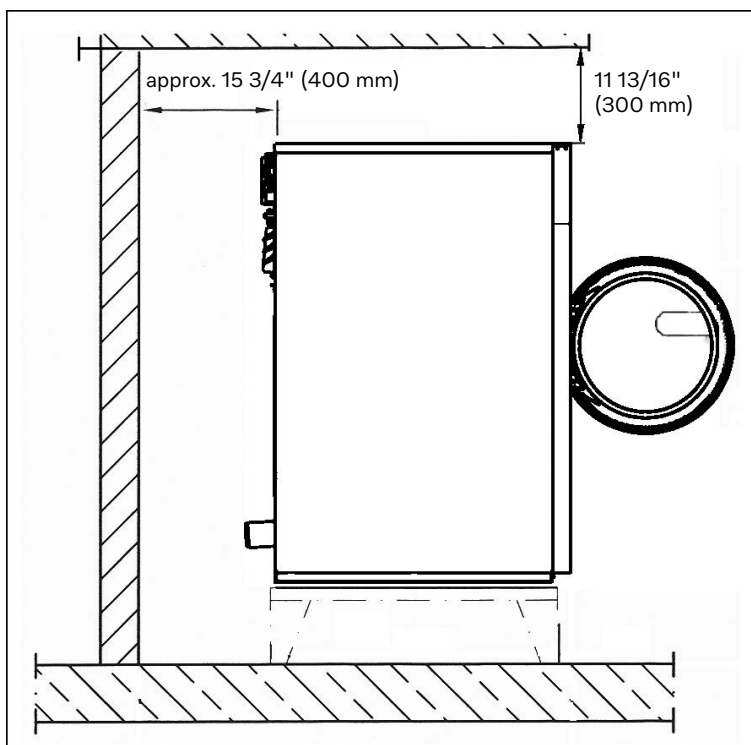

Minimum safety distance to the wall approx. 15 3/4" (400 mm) to allow for maintenance.

- Adjust the washing machine's adjustable feet until the machine is level.

The washing machine must be completely level to ensure smooth operation.

## Installation on a base

When installed on a raised base, the machine must be secured to the base and the base must be secured to the floor. When installed on a concrete base, the machine must be secured to the base.

## Transport safety devices

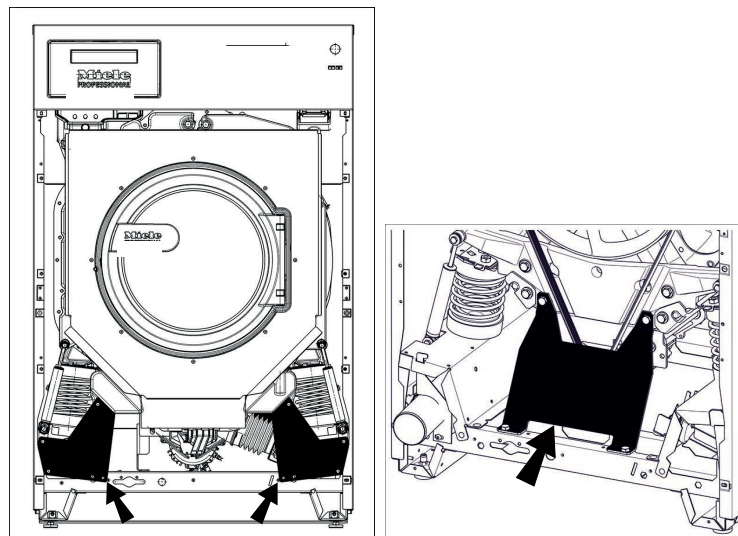

### Removing the transport safety devices

The 2 transport safety devices in the front are secured with 3 hexagonal screws each. The transport safety device in the back is secured with 4 hexagonal screws. The transport safety devices must only be removed at the installation site before the washing machine is commissioned.

- Remove the front and rear panel:
- Unscrew the screws at the bottom of the front panel and remove the panel.
- Unscrew the screws at the bottom of the rear panel and remove the panel.
- Loosen the hexagonal screws to remove the transport safety devices.

Keep the transport safety devices. They must be re-assembled before transporting the machine.

### Water connection

Water pressure (flow pressure) of a minimum of 14.5 psi (100 kPa)/ maximum of 145 psi (1,000 kPa) is required to guarantee a problem-free program sequence.

The machine must be connected to the water supply using the water inlet hoses provided.

## Installation

---

Hoses must be replaced with hoses tested for a burst pressure of at least 1,015 psi (7,000 kPa) overpressure and for water temperatures of a minimum of 194°F (90°C).

This also applies to the associated connection fittings. Original spare parts meet these requirements.

**Tip:** The hot water supply must not exceed a maximum temperature of 160°F (70°C). For machines with reduced heater rating and external heating, the incoming hot water must not exceed a temperature of 194°F (90°C). Special hot water connection hoses must be used for this purpose.

## Dispenser pump connections

Up to 12 dispenser pumps can be connected to the washing machine.

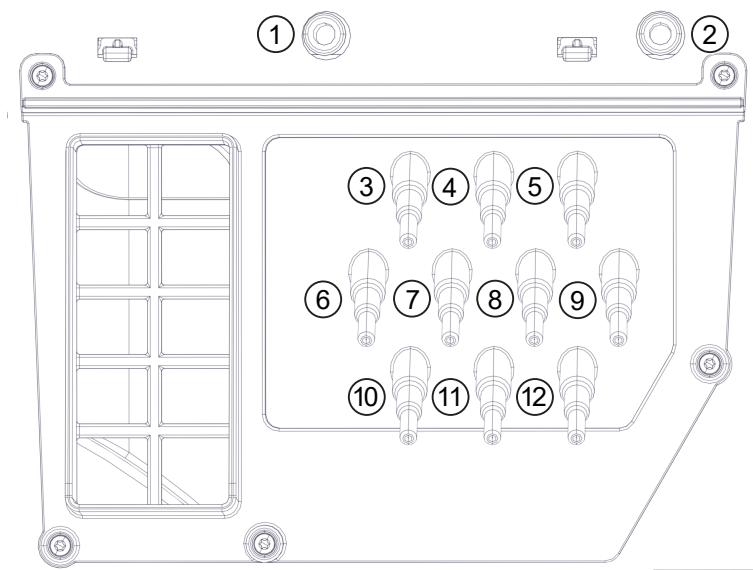

Dispenser pump connections on the back of the machine

Connections **1** and **2** are provided for viscous agents and can also be used for high-pressure dispensing systems with water injection. The dispensing systems must be equipped with a separate drinking water safety feature in accordance with local regulations. The maximum flow rate is 1,500 mL/min with a maximum flow pressure of 43.5 psi (300 kPa).

These connectors are sealed and need to be drilled open using an 8 mm drill bit before connecting.

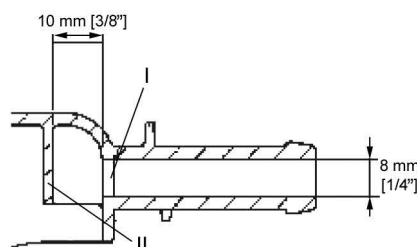

Care must be taken to drill through the first wall only (**I**) as there is a deflecting wall (**II**) 3/8" (10 mm) behind it.

Connections **3** to **12** are provided for liquid detergent. High-pressure dispensing systems with water injection must not be connected to these connections. The connectors are sealed and must be cut to the diameter of the hose with a small saw before they are connected.

If opened connectors are no longer required, they must be resealed using a suitable sealant (e.g., silicone).

External dispenser pumps are connected and calibrated via the Connector Box, which is available as an option.

Flowmeters or flow sensors can also be connected for precise monitoring of the dispensing quantity.

# Installation

---

Connections for level monitoring are available for every agent dispensed.

## Drainage

Drain valve **DV** on machine side DN 70, on-site socket DN 70. Flow rate temporary 200 l/min.

If the slope for drainage is extremely steep, the piping must be vented to prevent a vacuum from forming in the washing machine's drainage system.

## Electrical connection

The electrical connection must only be carried out by a suitably qualified electrician in accordance with local and national regulations.

**Tip:** The connection terminal is located behind the flap on the top rear panel (connecting strip).

If it is necessary to install a residual current device (RCD) in accordance with local regulations, a **residual current device type B** (sensitive to universal current) must be used.

The voltage is stated on the data plate.

For hard-wired machines, an all-pole means of deactivation must be provided on site. Switches with a minimum contact gap greater than 1/8" (3 mm) are suitable disconnectors.

Automatic switch-off devices (e.g., clocks/timers) must not be installed.

The plug connector or disconnector must be easily accessible at all times.

If the machine is disconnected from the power supply, the disconnector must be lockable or the point of disconnection must be monitored at all times.

## Optional accessories

Only use genuine Miele spare parts and accessories with this machine.

Using parts or accessories from other manufacturers may void the warranty, and Miele cannot accept liability.

## Connector Box

The Connector Box allows external hardware from Miele and other suppliers to be connected to the Miele Professional washing machine. The Connector Box is supplied with voltage by the Miele Professional washing machine.

The separately available set consists of the Connector Box and fasteners for installation on the machine or on the wall.

## Peak load/energy management

A peak-load or energy management system can be connected via the Connector Box.

Peak-load negotiation monitors the energy consumption of a system and deactivates individual pieces of equipment temporarily in order to ensure that certain total load limits are not exceeded. Monitoring is externally controlled.

When the peak-load function is activated, the heating is deactivated and the program stopped. A message appears in the display to inform you of this.

The program is resumed automatically when the peak-load function finishes.

## Liquid dispensing connection

External liquid dispensing pumps can be controlled by the Connector Box to dispense liquid detergents. An input for empty sensing is assigned to each dispensing pump output. These inputs can be used if required. In addition, flow sensors can be connected to each dispensing outlet to monitor the dispensing quantity.

It is particularly important to observe the manufacturer's instructions when using a combination of cleaning agents and special application products.

## Payment device

The washing machine can be equipped with a single-machine payment system as an optional accessory via the Connector Box.

The programming required for connecting a payment system can be carried out during the initial commissioning process. After initial commissioning, changes should only be carried out by Miele Service.

Please note that the status of the Connector Box must be set to "on" in the supervisor level as required. The payment system settings can be configured at the supervisor level.

The payment system is not activated via the supervisor level.

## Wi-Fi/LAN interface

The washing machine is equipped with a Wi-Fi/LAN interface for exchanging data.

The data interface provided on the LAN connection complies with SELV (Safety Extra Low Voltage). The LAN connection uses a RJ45 connector in accordance with EIA/TIA 568-B.

Connected machines must also comply with SELV.

## Base (APWM 031/035)

The washing machine can be installed on a machine base (open or box base, available as an optional Miele accessory).

Elevating the washing machine gives a better ergonomic working position when loading or unloading. At the same time it facilitates the installation of a drain connection.

 The washing machine must be secured to the base immediately after installation! The base must be secured to the floor!

There is a risk of the washing machine falling off a raised base during a spin cycle if it is not secured.

## Vapor and suds venting kit (APWM 063)

If excessive suds form, suds may escape from the vapor vent. An optional vapor and foam venting kit can be used to remove the foam.

## Supervisor level

---

### Opening the supervisor level

- Switch on the washing machine.

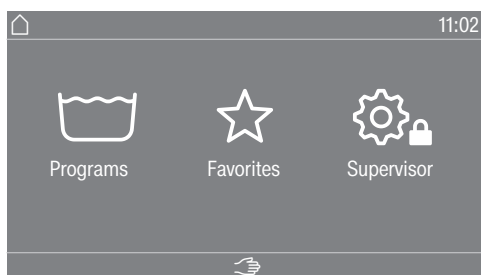

- Touch the Supervisor  sensor control.

The display will change to the Supervisor level menu.

### Opening the supervisor level (self-service)

- Switch on the washing machine and open the door.
- ① Touch the *Start/Stop* sensor control and hold it down whilst carrying out steps ②—③.
- ② Close the washing machine door.
- ③ The *Start/Stop* sensor control will now be flashing quickly; wait until it lights up constantly.
- ④ Release the *Start/Stop* sensor control when the *Start/Stop* sensor control lights up constantly.

### Code-based access

The supervisor level is accessed using a code.

The code is **8000** (factory default).

After entering the code, you will be in the supervisor level. The individual setting options are described in the following sections.

### Changing the code

You can alter the supervisor level access code to protect the washing machine from unauthorized access.

Please inform Miele Customer Service if you have forgotten your new code. Customer Service will have to reset the code. Make a note of your new code and store it in a safe place.

### Closing the Settings menu

- Touch the  symbol.

The display will then go back to the previous menu level.

- Touch the  symbol.

The display will change to the main menu.

## Controls / Display

### Language

The display contents can be displayed in a variety of languages. To select the permanent supervisor language you want, go to the Languages submenu.

When a program is running, you can change the user language using the  sensor control.

### Language entry

The display can be set to one of several different user languages. This setting allows you to determine how languages can be selected.

#### International

6 languages are available. The  sensor control is not active. Note the setting Set languages.

#### Language setting

The  sensor control can be used to select a language. All languages are available (factory default).

You can change the order of the first 4 languages. These slots are allocated to the most commonly used languages.

#### Default language

The user language cannot be changed. The user language is the same as the supervisor language. The  sensor control is not active.

### Set languages

The languages for the Language entry International setting can be changed.

6 languages can be selected. All languages are available.

If you wish to add a new language to the language menu:

- First select the language you want to replace.

All available languages are displayed.

- Select and confirm the language to replace the previous language.

The new language appears instead of the old one.

### Time

After selecting the clock format, you can set the time of day.

#### Clock format

- 24 h clock
- 12 h clock
- No clock

#### Set

- The time can be set.

### Date

The date can be set after selecting the date format.

#### Date format

- DD.MM.YYYY
- YYYY.MM.DD
- MM.DD.YYYY

#### Date

- The date can be set.

## Supervisor level

---

<b>Logo</b>	Different logos can be selected for the user interface.
<b>Start screen</b>	Different views can be selected for the start screen. The start screen is displayed after exiting a submenu.
<b>Mode</b>	Different supervisor modes can be selected.
<b>Display brightness</b>	<div style="border: 1px solid black; padding: 5px;">The brightness of the display can be altered. The setting depends on the various lighting conditions in the place of installation.</div> <p>It can be set to one of 10 different levels.</p>
<b>Display off status</b>	<div style="border: 1px solid black; padding: 5px;">In order to save energy, the display can be set to switch to standby mode automatically after the end of the program or if no further selection is made. In the default setting, the machine will not switch to standby mode automatically.</div> <p>Changing this factory default setting may lead to increased energy consumption.</p> <ul style="list-style-type: none"><li>- Off</li><li>- On (10 min.) Not curr.prog.</li><li>- Logo (10 min.) Not curr.prog.</li><li>- On after 10 min.</li><li>- On (30 min.) Not curr.prog.</li><li>- Logo (30 min.) Not curr.prog.</li><li>- On after 30 min.</li></ul>
<b>Machine off status</b>	<div style="border: 1px solid black; padding: 5px;">In order to save energy, the washing machine can be set to switch to standby mode automatically after the end of the program or if no further selection is made. In the default setting, the machine will not switch to standby mode automatically.</div> <p>Changing this setting may lead to increased energy consumption.</p> <ul style="list-style-type: none"><li>- No switch-off (factory default)</li><li>- Switch-off after 15 minutes</li><li>- Switch-off after 20 minutes</li><li>- Switch-off after 30 minutes</li></ul>
<b>Volume</b>	<div style="border: 1px solid black; padding: 5px;">The volume for various sounds can be changed.</div> <p>It can be set to one of 7 different levels or switched off altogether.</p> <ul style="list-style-type: none"><li>- Finish tone</li><li>- Keypad tone</li><li>- Welcome tone</li><li>- Fault tone</li></ul> <p>The fault tone can be activated or deactivated.</p>
<b>Visibility parameters</b>	<div style="border: 1px solid black; padding: 5px;">Various parameters, such as the temperature, spin speed, Extras, etc., are displayed when a program is selected. You can decide which parameters should not be displayed. The parameters cannot be changed/are no longer displayed.</div> <p>Factory default: all parameters are visible (marked in orange)</p>

<b>Sorting extra options</b>	<p>Under the setting <i>Visibility parameters</i>, <i>Sort Extras</i> appears in the bottom line. Touch the sensor control to change the sequence of extra options (see “Supervisor level – Arranging programs”).</p>
<b>Delay start</b>	<p>The delay start (timer) display can be switched on or off.</p> <p>Factory default: on</p>
<b>Memory</b>	<p>The washing machine will save the settings (temperature, spin speed, and some of the options) which have been selected for a wash program after the program has started.</p> <p>When the wash program is chosen again, the saved settings will appear in the display.</p> <p>Factory default: off</p>
<b>Manual control</b>	<p>The manual control function can be switched on or off. Switch-on can be carried out with or without identification.</p>
<b>Change order</b>	<p>The skip function can be switched on or off.</p>
<b>Measuring system</b>	<p>You can choose whether the temperature and weight are displayed in metric or imperial units.</p>
<b>Supervisor code</b>	<p>You can alter the access code to the supervisor level. The code supervisor is independent of the code expert.</p> <ul style="list-style-type: none"><li>■ Enter the current code.</li><li>■ Enter a new code.</li></ul> <p>When creating a new code, number sequences such as 1234 and four-digit numbers such as 2222 are not permitted.</p>
<b>Wi-Fi</b>	<p>In this menu, you control the networking of your washing machine (see “Networking”).</p>

# Supervisor level

---

## Program selection

### Controls

**Tip:** Start by configuring all necessary settings and changes to the washing machine before selecting any of the options below.

If “Laundromat, basic” or “Laundromat, Logo” is selected, the supervisor level can no longer be opened from the display after the *Supervisor level* is closed. Please follow the instructions below for special access to the supervisor level if you wish to change any other settings.

Standard (factory default).

All functions and programs can be displayed.

Laundromat, basic

Up to 24 programs are available. Go to Favorite programs to select which programs are to be listed.

Laundromat logo

Up to 24 programs are available. Go to Favorite programs to select which programs are to be listed.

External program selection

Programs are selected using a communication module with Ethernet, e.g., via an external terminal.

### Program packages

The selection of programs can be expanded by activating single programs from the target group program packages.

The programs selected from the program packages (marked in orange) are displayed during program selection.

### Favorite programs

After switching on, you can also select a program via: ☆ Favorites. 24 programs can be stored as favorites based on your own priorities and requirements.

These favorite programs will also be made available in the control options

- *Laundromat logo*

- *Laundromat, basic* control options.

You can specify the control option under Controls.

**Tip:** You can assign a separate colored frame to each program. In this case, the “Color assign. program setting must be set to *On*.

#### Changing favorite programs

- Select the program you wish to change or replace.
- Confirm the program or the setting to be changed.

Another menu opens, enabling you to select a new program or change the parameters.

- Confirm by touching the *Save* selection area.

Your selection is now active.

### Sort programs

Programs can be moved within the program list and in the favorites list.

Factory default: off

- Moving programs
- Touch the selection area for the program you want to move.
  - Press and hold the selection area until the frame changes.
  - Drag the program to the required place.

### Program color allocation

You can assign a frame to a favorite program. In the list of favorites, each favorite program is given a colored frame, which can be adjusted.

Factory default: on

### Expert code

A code has to be entered to cancel a disinfection program. The code can be modified.

The code expert is independent of the code supervisor level.

The code is: 8 0 0 0

Make a note of your new code if you ever change it.

## Process technology

### Anti-crease

The Anti-crease function helps prevent creasing after the end of the program. At the end of the program, the drum continues to turn for up to 30 minutes.

The washing machine door can be opened at any time during the Anti-crease phase.

Factory default: on

### Automatic drainage

Automatic water drainage can be switched on or off. Automatic water drainage means that the suds are always drained away after the end of a program. This is also the case for programs that reach the program end with water still in the drum.

Factory default: off

## Service

### Service interval

Service information can appear in the display. You can configure whether a date or the number of operating hours is displayed.

You can select up to 2 messages with their own text.

Your message is displayed at the end of the program and can be acknowledged with *OK*. The same message appears at the end of the next program.

#### Settings

This setting allows you to determine the interval (by hours or date) at which the message appears.

- Factory default: off

- By time

You can then select a time interval from 1–9,999 hours.

- By date

You can then enter a date.

#### Message text

Enter your message for your planned maintenance work.

#### Resetting the display

## Supervisor level

---

The message appears until the display is permanently reset. The message then appears again once the next interval is reached.

## External applications

<b>Payment system lock</b>	The payment device lock can be switched on or off. When the lock is switched on, the duration until locking can be selected from various time intervals.
<b>Connector box</b>	External hardware is connected via the Connector Box. This can be switched on or off. <div style="border: 1px solid black; padding: 5px; margin-top: 10px;">The Connector Box must be selected in order for settings to be made in the Dispensing menu.</div>
<b>Automatic dispensing</b>	Automatic dispensing can be switched on or off. Automatic dispensing can be activated via the Connector Box or the COM module.
<b>Dosage</b>	<div style="border: 1px solid black; padding: 5px; margin-bottom: 10px;">The Connector Box must be switched on in order for settings to be adopted in the Dispensing menu.</div> 1–12 dispenser pumps can be switched on. Additional settings can be made after activating the dispenser pump. - Deactivate disp. pump - Calibration - Flow rate (new): ml/min - Correction factor - Container size - Adv. warning level reminder - Reset adv. warning - Level reminder - Flow meter
<b>Peak load prevention</b>	The peak-load prevention function can be switched on or off. With this function, the execution of a wash program is not affected when a peak-load signal is in place. The heater stays switched on.

## Machine parameters

<b>Maximum spin speed</b>	The maximum spin speed can be set via a keypad.
<b>Max. adjust. temperature</b>	The maximum temperature can be set via a keypad.
<b>Legal Information</b>	<u>Open source licenses</u>

You can view information here (see WiFi data protection).

<b>Payment system</b>	<div style="border: 1px solid black; padding: 5px; margin-bottom: 10px;">The Miele Connector Box accessory unit or the COM module is required to connect a payment device.</div> - No payment system The next settings are skipped. - Timed operation CB The washing machine operates in time mode via the Connector Box. - COM reserve operation
-----------------------	---

## Supervisor level

---

The washing machine operates in booking mode based on IP via the COM module.

- Program control CB

The washing machine operates in program mode via the Connector Box.

- COM program control

The washing machine operates in program mode based on IP via the COM module.

Setting for payment systems

If you wish to make changes at a later date, please contact Miele Customer Service.

## Pairing instructions

Follow the steps below to connect the washing machine to your network.

### Network connection

Miele Professional washing machines can be integrated into local networks to utilize Miele's digital solutions or communicate with external systems. The washing machines are equipped with an integrated Wi-Fi module for this purpose. In addition, the washing machines each have an Ethernet connection at the rear for setting up wired interfaces.

⚠ Unauthorized access poses a health risk.  
 Settings in the washing machine, e.g., parameters for disinfection or dispensing process chemicals, may be changed as a result of unauthorized access via the network.  
 Under no circumstances should it be possible to access the washing machine via the Internet or other public or unsecured networks, either directly or indirectly (e.g., using port forwarding).

1. The washing machine should be operated only in a separate network segment which meets one of the following requirements:
  - It is physically separated from other network segments.
  - Access to the segment is restricted by a firewall or a router which has been configured accordingly.
2. Limit access to this separate network segment to persons requiring access in the course of their work.
3. Use strong passwords to protect access to systems that are connected to the washing machine.
4. Configure the Ethernet interface.

### Opening the supervisor level

- Select the Supervisor menu option in the machine display.
- Select the Access via code menu option.
- Enter the 4-digit supervisor code.

### Initial network setup

- Select the Supervisor level menu option from the External applications menu.
- Select WiFi / LAN.

The options in the WiFi / LAN menu vary depending on whether the Wi-Fi interface is already set up or needs to be set up.

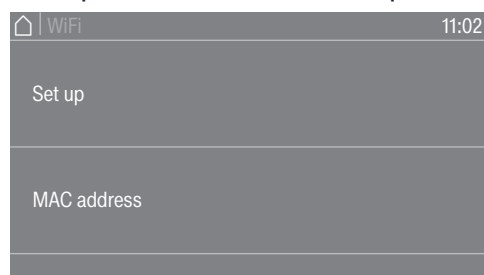

- Select Set up to connect the machine to a network.

The message Set up only appears if the washing machine has not yet been connected to a Wi-Fi network. Various options are available for setting up the Wi-Fi interface.

# Networking

---

- Select MAC address to read out the MAC addresses of the network adapters.

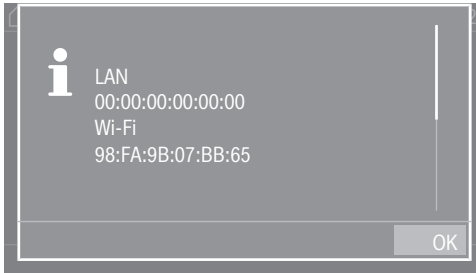

The MAC address of the network adapters is displayed. No settings can be made.

## Setting up a network connection manually

- Select the Supervisor level menu option from the External applications menu.
- Then select the WiFi / LAN menu option.
- Select Set up.
- Select the Manual connection method.

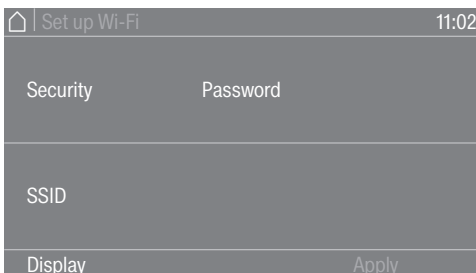
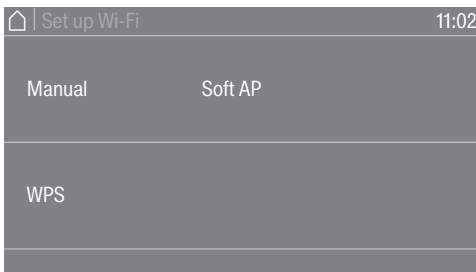

- Select Security to set the security standard for the wireless connection.
- Select Password to enter the Wi-Fi password.
- Select SSID to enter the network name (SSID).

You can view all settings for Security, Password, and SSID under Display.

- Save all settings with Apply.

## Establishing the network connection via WPS

- Select the Supervisor level menu option from the External applications menu.
- Then select the WiFi / LAN menu option.
- Select Set up.
- Select the Via WPS connection method.
- Now press the WPS button on your router and confirm with OK in the machine display.

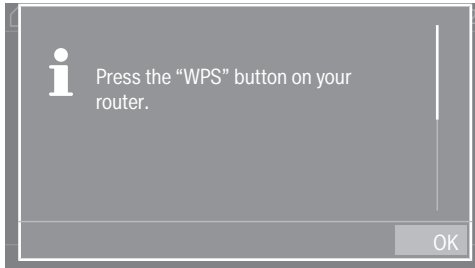

A timer starts. The network connection via WPS is being established.

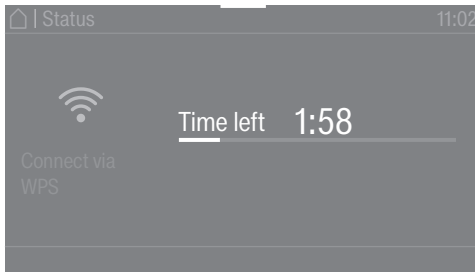

The machine is now successfully connected.

- Tap OK to confirm.

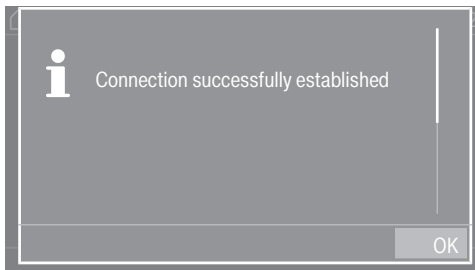

# Networking

---

## Establishing the network connection via soft AP

- Select the Supervisor level menu option from the External applications menu.
- Then select the WiFi / LAN menu option.
- Select Set up.
- Select the Via Soft AP connection method.
- Confirm by pressing OK and follow the instructions in the external application.

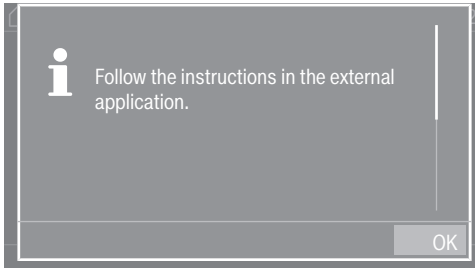

The display shows the message *Waiting for connection for approx. 10 minutes*. If the connection is successful, a message is then displayed. If the connection has failed, the message *Connection failed* is displayed.

- If the connection fails, confirm with OK and start a new connection attempt.

## Establishing the network connection using a LAN cable

- Connect the machine to your router/switch using the network cable.

The machine is now successfully connected.

## Wi-Fi/LAN interface configured

Once the network connection has been successfully set up, you can select additional options in the menu.

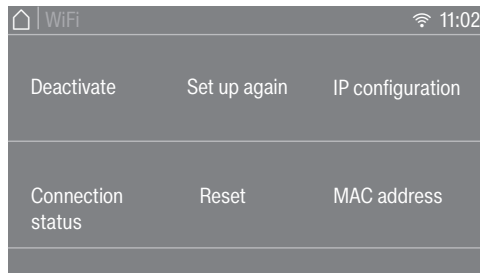

- The Wi-Fi function is switched off with Deactivate (visible when the network is activated). The network remains set up.
- The Wi-Fi function is reactivated with Activate (visible when the network is deactivated).
- All network parameters are displayed under Connection status.
- You can set up the Wi-Fi interface again under Set up again.
- Use Reset to disconnect the network setup. The Wi-Fi function is deactivated and the Wi-Fi connection will be reset to the factory default. A new connection has to be established in order to use the network again.
- You can configure the IP settings manually under IP configuration. The interface can be set up via a Dynamic Host Configuration Protocol (DHCP). If you deactivate the DHCP setting, you can configure the interface using the following parameters:
  - IP address
  - Subnet mask
  - Gateway
  - DNS Auto
  - DNS server 1
  - DNS server 2
- The address of the network adapters is displayed under MAC address.

## Technical data

### System requirements for WiFi

- WiFi 802.11b/g/n
- 2.4 GHz band
- WPA/WPA2 encryption
- DHCP activated
- MulticastDNS/Bonjour/IGMP snooping activated
- Ports 443, 80, 53, and 5353 open
- IP DNS server = IP standard gateway/router
- Mesh/repeater use: same SSID and password as standard gateway/router
- SSID must be permanently visible

### System requirements for LAN

- DHCP activated
- MulticastDNS/Bonjour/IGMP snooping activated
- Ports 443, 80, 53, and 5353 open
- IP DNS server = IP standard gateway/router



# Networking

---

## Wi-Fi signal strength – guide values

The Wi-Fi signal strength is only a rough guide. These details do not provide absolute certainty.

The Wi-Fi signal strength can be read directly on the machine.

Wi-Fi signal strength		Meaning
	 *	
76–100%	3/3**	Generally, reliable operation possible
51–75%	2/3	
26–50%	1/3	Generally, operation possible
1–25%	0/3	Generally, reliable operation not possible
0%		Operation not possible

\* Displayed on the machine

\*\* Number of bars  3/3–0/3

The signal strength can be adversely affected by many factors, including:

- people in the room
- open or closed doors
- moved objects
- varying radio signal sources or interference
- other machines with Bluetooth or Wi-Fi wireless technology

## PWM 912 machine data

### Electrical connection

Connection voltage	See data plate
Frequency	See data plate
Power rating	See data plate
Current	See data plate
Fuse rating	See data plate
Heater rating	See data plate

### Installation dimensions

Casing width	31 5/16" (795 mm)
Casing height	52 7/16" (1332 mm)
Casing depth	32 1/2" (825 mm)
Overall machine width	32 15/16" (837 mm)
Overall machine height	53 1/16" (1347 mm)
Overall machine depth	36 7/16" (926 mm)
Minimum width of transport opening	37" (940 mm)
Minimum distance between wall and front of machine	51 3/16" (1300 mm)
Door opening diameter	16 5/16" (415 mm)
Door opening angle	180°

### Weight and floor load

Net weight	see installation plan
Maximum floor load during operation	see installation plan

### Emission values

Emission sound pressure level in accordance with EN ISO 11204/11203	< 70 dB(A) re 20 µPa
Sound power level, EN ISO 9614-2	< 80 dB(A)

### Product safety

Product safety standards	See data plate
--------------------------	----------------

### WiFi

Frequency range of the WiFi module	2.400–2.4835 GHz
Maximum transmission power of the WiFi module	< 100 mW

# Technical data

---

## PWM 916 machine data

### Electrical connection

Connection voltage	See data plate
Frequency	See data plate
Power rating	See data plate
Current	See data plate
Fuse rating	See data plate
Heater rating	See data plate

### Installation dimensions

Casing width	36 1/4" (920 mm)
Casing height	57" (1447 mm)
Casing depth	29 11/16" (754 mm)
Overall machine width	37 7/8" (962 mm)
Overall machine height	57 1/16" (1450 mm)
Overall machine depth	33 5/16" (846 mm)
Minimum width of transport opening	42 1/8" (1070 mm)
Minimum distance between wall and front of machine	50 3/8" (1280 mm)
Door opening diameter	16 5/16" (415 mm)
Door opening angle	180°

### Weight and floor load

Net weight	see installation plan
Maximum floor load during operation	see installation plan

### Emission values

Emission sound pressure level in accordance with EN ISO 11204/11203	< 70 dB(A) re 20 µPa
Sound power level, EN ISO 9614-2	< 80 dB(A)

### Product safety

Product safety standards	See data plate
--------------------------	----------------

### WiFi

Frequency range of the WiFi module	2.400–2.4835 GHz
Maximum transmission power of the WiFi module	< 100 mW

## PWM 920 machine data

### Electrical connection

Connection voltage	See data plate
Frequency	See data plate
Power rating	See data plate
Current	See data plate
Fuse rating	See data plate
Heater rating	See data plate

### Installation dimensions

Casing width	36 1/4" (920 mm)
Casing height	56 3/8" (1431.5 mm)
Casing depth	33 3/4" (857 mm)
Overall machine width	37 7/8" (962 mm)
Overall machine height	57 1/16" (1450 mm)
Overall machine depth	36 13/16" (935 mm)
Minimum width of transport opening	42 1/8" (1070 mm)
Minimum distance between wall and front of machine	53 3/8" (1355 mm)
Door opening diameter	16 5/16" (415 mm)
Door opening angle	180°

### Weight and floor load

Net weight	see installation plan
Maximum floor load during operation	see installation plan

### Emission values

Emission sound pressure level in accordance with EN ISO 11204/11203	< 70 dB(A) re 20 µPa
Sound power level, EN ISO 9614-2	< 80 dB(A)

### Product safety

Product safety standards	See data plate
--------------------------	----------------

### WiFi

Frequency range of the WiFi module	2.400–2.4835 GHz
Maximum transmission power of the WiFi module	< 100 mW

## Technical data

---

ANY CHANGES OR MODIFICATIONS NOT EXPRESSLY APPROVED BY THE PARTY RESPONSIBLE FOR COMPLIANCE COULD VOID THE USER'S AUTHORITY TO OPERATE THE EQUIPMENT.

THIS DEVICE COMPLIES WITH PART 15 OF THE FCC RULES AND CONTAINS LICENSE-EXEMPT TRANSMITTER(S)/RECEIVER(S) THAT COMPLY WITH INNOVATION, SCIENCE AND ECONOMIC DEVELOPMENT CANADA'S LICENCE-EXEMPT RSS STANDARD(S). OPERATION IS SUBJECT TO THE FOLLOWING TWO CONDITIONS: (1) THIS DEVICE MAY NOT CAUSE HARMFUL INTERFERENCE, AND (2) THIS DEVICE MUST ACCEPT ANY INTERFERENCE RECEIVED, INCLUDING INTERFERENCE THAT MAY CAUSE UNDESIRE OPERATION.

Contains FCC ID: 2ACUWEK047

Contains IC: 5669C-EK047

RADIATION EXPOSURE STATEMENT: THIS EQUIPMENT COMPLIES WITH FCC AND WITH ICED RADIATION EXPOSURE LIMITS SET FORTH FOR AN UNCONTROLLED ENVIRONMENT. THIS EQUIPMENT SHOULD BE INSTALLED AND OPERATED WITH A MINIMUM DISTANCE OF 20CM BETWEEN THE RADIATOR AND YOUR BODY. THIS DEVICE AND ITS ANTENNA(S) MUST NOT BE CO-LOCATED OR OPERATION IN CONJUNCTION WITH ANY OTHER ANTENNA OR TRANSMITTER.

Miele hereby declares that this washing machine complies with Directive 2014/53/EU. The complete text of the EU declaration of conformity is available from one of the following Internet addresses:

- Or go to <http://www.miele.de/professional/gebrauchsanweisungen-177.htm> and enter the name of the product or the serial number

### **Data protection and data security**

When you activate the networking function and connect your machine to the Internet, your machine sends the following data to the Miele Cloud:

- machine serial number
- machine model and technical features
- machine status
- information about the software status of your machine

Initially, this data cannot be assigned to a specific user and is not saved permanently. Data cannot be saved permanently or assigned to a specific user until after you have linked your machine to a user. Data transmission and processing are governed by Miele's strict security standards.

### **Factory default settings for network configuration**

You can reset all of the settings on the communication module or your integrated WiFi module to the factory default settings. The network configuration should be reset whenever a machine is being disposed of or sold, or if a used machine is being put into operation. This is the only way to ensure that all personal data has been removed and the previous owner will no longer be able to access the machine.

### **Copyrights and licenses**

For the purpose of operating and controlling the communication module, Miele uses proprietary or third-party software that is not covered by open source licensing terms. This software/these software components are protected by copyright. The copyrights held by Miele and third parties must be respected.

This communication module contains software components which are distributed under open source licensing terms. The open source components contained in the machine along with the corresponding copyright notices, copies of the licensing terms valid at the time, and any additional information can be accessed locally by IP via a web browser (*https://<IP address>/Licenses*). The liability and warranty arrangements for the open source licenses displayed in this location only apply in relation to the respective rights holders.



Please have the model and serial number  
of your machine available when  
contacting Technical Service.

---

**U.S.A.**  
**Miele, Inc.**

**National Headquarters**

9 Independence Way  
Princeton, NJ 08540  
Phone: 800-991-9380  
[www.miele-professional.com](http://www.miele-professional.com)  
[prosales@mieleusa.com](mailto:prosales@mieleusa.com)

**Technical Service & Support**

Phone: 800-991-9380  
[proservice@mieleusa.com](mailto:proservice@mieleusa.com)

**Canada**  
**Importer**  
**Miele Limited**

**Professional Division**

161 Four Valley Drive  
Vaughan, ON L4K 4V8  
Phone: 1-888-325-3957  
[www.miele-professional.ca](http://www.miele-professional.ca)  
[professional@miele.ca](mailto:professional@miele.ca)

**Miele Professional Technical Service**

Phone: 1-888-325-3957  
[serviceprofessional@miele.ca](mailto:serviceprofessional@miele.ca)



Manufacturer: Miele & Cie. KG  
Carl-Miele-Straße 29, 33332 Gütersloh, Germany