



Operating instructions Dishwasher





To avoid the risk of accidents or damage to the appliance, it is **essential** to read these instructions as well as the installation plan before it is installed and used for the first time.

Warning and Safety instructions	7
Notes on the operating instructions	15
Notes on the layout.....	15
Items supplied	16
Guide to the appliance	17
Appliance overview	17
Lower basket	18
Control panel.....	19
Display functions	20
Caring for the environment	21
Using for the first time	22
Opening the door	22
Closing the door	23
Activating the safety lock	23
Miele@home	24
Standard settings	25
Setting the language	25
Setting up Miele@home	25
Setting the time of day.....	26
Setting the water hardness	26
Activating AutoDos.....	27
Dishwasher salt	28
Filling the salt reservoir	29
Replenishing salt.....	30
Rinse aid	31
Adding rinse aid.....	32
Refilling rinse aid.....	32
Settings	33
Opening the Settings menu.....	33
Changing settings.....	33
Closing the Settings menu.....	33
Language 	34
Time of day	34
Water hardness.....	35
AutoDos (automatic dispensing)	35
Rinse aid	36
Save Extras	36
Miele@home	36
Performing Scan & Connect.....	37
Remote control	39

Contents

RemoteUpdate	40
SmartStart.....	41
EcoStart	41
Display (EcoFeedback)	43
Display brightness.....	43
Volume	44
Refill reminders.....	44
AutoOpen	45
2nd interim rinse	45
Hygiene cycle.....	45
Water connection.....	46
System lock 	46
Deactivating the system lock.....	46
Information	47
Showroom programme.....	47
Factory default	47
Copyright and licences for the communication module.....	47
Caring for the environment	48
Economical dishwashing.....	48
EcoFeedback consumption display	49
Loading the dishwasher.....	50
General information	50
Upper basket.....	52
Adjusting the upper basket	55
Lower basket	56
Cutlery tray	60
Loading the 3D MultiFlex tray.....	60
Loading examples.....	61
Dishwashers with cutlery tray	61
Comparison tests.....	63
Normal height	63
XXL height	66
Detergents.....	69
Types of detergents	69
Detergent dispensing.....	70
Automatic dispensing/AutoDos.....	71
Activating AutoDos.....	71
Inserting a PowerDisk.....	72
Manual detergent dispensing.....	74
Detergent dispensing.....	74
Adding detergent	74

Operation	76
Switching on the dishwasher.....	76
Selecting a programme	76
Display of programme duration.....	77
Starting a programme.....	77
At the end of the programme	78
Energy management	78
Switching off the dishwasher	79
Unloading the dishwasher	79
Interrupting a programme	80
Cancelling or changing a programme	80
Options	81
⌚ Timer	81
Activating MobileStart 	85
Displaying the operating hours.....	85
Guide for selecting a programme	86
Programme chart	88
 Further programmes	90
Extras	91
Selecting Extras	91
 Selecting Quick	92
Cleaning and care	93
Cleaning the wash cabinet.....	93
Cleaning the door and the door seal	94
Cleaning the control panel	94
Cleaning the appliance front.....	95
Cleaning the AutoDos.....	96
Cleaning the spray arms.....	98
Checking the filters in the wash cabinet.....	102
Cleaning the filters	102
Cleaning the water inlet filter.....	104
Cleaning the drain pump	105
Problem solving guide	107
Technical problems	107
Fault messages	108
Door release.....	108
Water intake fault	109
Water drainage fault.....	109
Fault with the AutoDos (automatic dispensing)	110
Spray arm fault.....	112

Contents

General problems with the dishwasher	112
Noises	113
Unsatisfactory cleaning result	114
Service	118
Contact in case of fault.....	118
Warranty	118
Optional accessories	119
Installation	121
The Miele Waterproof system	121
Water inlet	121
Drainage.....	123
Electrical connection	124
Technical data	125

Warning and Safety instructions

This dishwasher complies with all current local and national safety requirements. However, inappropriate use can lead to personal injury and damage to property.

Please observe the installation sheet and read the operating instructions carefully before setting up the dishwasher and using it for the first time. They both contain important information on the installation, safety, use, and maintenance of the machine. This prevents both personal injury and damage to the dishwasher.

In accordance with standard IEC 60335-1, Miele expressly and strongly advises that you read and follow the instructions in "Installation" and in "Warning and Safety instructions".

Miele cannot be held liable for injury or damage caused by non-compliance with these instructions.

Keep the installation sheet and the operating instructions in a safe place and pass them on to any future owner.

Correct application

- ▶ This appliance is designed for domestic use and for use in similar environments by guests in hotel or motel rooms, bed & breakfasts and other typical living quarters. This does not include common/shared facilities or commercial facilities within hotels, motels or bed & breakfasts.
- ▶ This dishwasher is not suitable for outdoor use.
- ▶ The dishwasher is intended for use at altitudes of up to 4,000 m above sea level.
- ▶ The dishwasher must only be used for cleaning domestic crockery and cutlery. Any other use is not permitted.
- ▶ This appliance is not intended for use by persons (including children) with reduced physical, sensory or mental capabilities, or lack of experience and knowledge, unless they have been given supervision or instruction concerning its use by a person responsible for their safety, and are able to recognise the dangers of misuse.

Safety with children

- ▶ Young children must not be allowed to use this appliance.

Warning and Safety instructions

- ▶ Older children may only use the dishwasher if its operation has been clearly explained to them and they are able to use it safely. They must be able to understand and recognise the possible dangers of misuse.
- ▶ Cleaning work may only be carried out by older children under the supervision of an adult.
- ▶ Children should be supervised in the vicinity of the dishwasher. Keep small children away from the appliance at all times to avoid the risk of injury. Ensure that they do not play with the appliance. There is a risk that children may lock themselves in the dishwasher.
- ▶ If the automatic door opening mechanism is active, keep young children away from the area in which the door opens. There is a danger of injury in the unlikely event of a fault with the opening mechanism.
- ▶ Danger of suffocation! While playing, children may become entangled in packaging material (such as plastic wrapping) or pull it over their head with the risk of suffocation. Keep packaging material away from children.
- ▶ Keep detergents and other household cleaning agents out of reach of children. Some dishwasher detergents are strongly alkaline and contain irritants and corrosive ingredients. They can be extremely dangerous if swallowed, and can cause severe skin burns and eye damage. They can cause burning in the mouth, nose and throat, or inhibit breathing. Avoid contact with the skin and eyes. Keep children away from the dishwasher when the door is open. There could still be detergent residues in the cabinet or dispenser. Check that the dispenser is empty after the completion of a programme. Seek medical advice immediately if a child has swallowed or inhaled any detergent. Contact a Poisons Information Centre (Australia) or the National Poisons Centre (NZ).

Technical safety

- ▶ Unauthorised installation, maintenance and repairs can cause considerable danger for the user. Installation, maintenance, and repairs must only be carried out by a Miele authorised technician.
- ▶ Damage to the dishwasher can compromise your safety. Before using the dishwasher and in particular following transport, check it for any visible damage. Never use a damaged dishwasher.

Warning and Safety instructions

► The electrical safety of this dishwasher can only be guaranteed when continuity is complete between it and an effective earthing system. It is most important that this basic safety requirement is present. If in doubt, the electrical installation should be checked by a qualified electrician.

Miele cannot be held liable for the consequences of an inadequate earthing system (e.g. electric shock).

► Temporary or permanent operation with a self-sufficient or non-mains synchronous energy supply system (e.g. isolated networks, back-up systems) is possible. A requirement for the operation is that the energy supply system complies with all current local and national requirements that apply to stand-alone, solar and/or battery systems. The protective measures provided in the installation and in this Miele product must also be assured in their function and operation in isolated operation or in non-mains synchronous operation, or replaced with equivalent measures in the installation.

► The dishwasher must only be connected to the electricity supply via a suitable switched socket using a 3-pole plug with protective contact (it must not be hardwired). The socket must be easily accessible after the dishwasher is installed so that it can be disconnected from the electricity supply at any time.

► There must be no electrical sockets concealed behind the dishwasher because the building-in niche may be too small, creating a risk of overheating if the dishwasher were to be pushed up against the plug (fire hazard).

► The dishwasher must not be installed underneath a cooktop. The high temperatures radiated by cooktops could damage the dishwasher below. For the same reason, the dishwasher must not be installed next to open fires or other appliances that give off heat, such as heaters etc.

► Ensure that the connection data on the dishwasher's data plate (fuse rating, frequency and voltage) match the electricity supply to prevent damage to the dishwasher. Compare these before connecting the appliance to the mains electricity. If in any doubt, consult a qualified electrician.

► Do not connect the dishwasher to the electricity supply until it has been fully installed and any adjustment has been made to the door springs.

Warning and Safety instructions

- ▶ The dishwasher may only be operated if the door opening mechanism is working correctly. Otherwise, there could be a risk of danger while the automatic door opening mechanism is active. To check that the door opening mechanism is working correctly:
 - The door springs must be evenly adjusted on both sides. They are correctly adjusted when the door remains stationary when left half open (approx. 45° opening angle). The door must not fall open on its own beyond this point.
 - The door locking pin retracts automatically after the drying phase when the door is opened.
- ▶ Multi-socket adapters and extension leads do not guarantee the required safety of the appliance (e.g. danger of overheating). Do not connect the dishwasher to the electricity supply using a multi-socket adapter or an extension cord.
- ▶ The dishwasher must not be installed and operated in mobile locations (e.g. on a ship).
- ▶ Do not install the dishwasher in a room where there is a risk of frost. Frozen hoses can break or burst. The reliability of the electronic control unit may be impaired at temperatures below freezing point.
- ▶ To avoid any damage to the dishwasher, it must only be operated when it is connected to a fully vented plumbing system.
- ▶ The plastic housing of the water connection contains an electrical valve. The housing must not be dipped in water.
- ▶ There are live wires in the water inlet hose. Do not cut the hose, even if it is too long.
- ▶ The integrated Miele Waterproof system offers protection from water damage, provided that the following conditions are met:
 - Installation has been carried out correctly.
 - The dishwasher is properly maintained and parts are replaced where it can be seen that this is necessary.
 - The tap is turned off during longer absences from the home (e.g. whilst on holiday).

The Waterproof system will work even when the dishwasher is switched off. However, the dishwasher must remain connected to the electricity supply.

- ▶ The water connection pressure needs to be between 50 and 1000 kPa.

Warning and Safety instructions

- ▶ A damaged dishwasher could be dangerous. If the dishwasher gets damaged, switch it off at the mains immediately and contact Miele customer service.
- ▶ The manufacturer's warranty will be invalidated if the appliance is not repaired by a Miele authorised service technician.
- ▶ Defective components must be replaced with original parts. If original Miele parts are installed correctly, Miele ensures full compliance with safety requirements and the warranty remains valid.
- ▶ During installation, maintenance, and repair work, the dishwasher must be disconnected from the electricity supply (switch it off and withdraw the plug from the socket).
- ▶ If the mains connection cable is damaged, it must only be replaced with a specific mains connection cable of the same type (available Miele). For safety reasons, such replacement may only be carried out by a Miele authorised technician or by Miele in order to avoid a hazard.
- ▶ This dishwasher is supplied with a special lamp (depending on the model) to cope with particular conditions (e.g. temperature, moisture, chemical resistance, abrasion resistance and vibration). This lamp must only be used for the purpose for which it is intended. The lamp is not suitable for room lighting. Replacement lamps may only be fitted by a qualified electrician or a Miele authorised technician.
- ▶ In areas which may be subject to infestation by cockroaches or other vermin, pay particular attention to keeping the appliance and its surroundings in a clean condition at all times. Any damage which may be caused by cockroaches or other vermin will not be covered by the warranty.

Correct installation

- ▶ The dishwasher must be installed and connected in accordance with the installation instructions and the supplied installation plan.



- ▶ Be careful before and while installing the dishwasher. Some metal parts pose a risk of injury/cutting. Wear protective gloves.

- ▶ The way in which the dishwasher is installed must not cause doors to be blocked when the door is automatically opened (AutoOpen function).

Warning and Safety instructions

▶ The dishwasher must not be installed behind closed cabinet fronts (e.g. doors).

The cabinet units used must be sufficiently resistant to moisture.

The installation space must be well ventilated.

▶ The dishwasher must be correctly aligned horizontally to ensure trouble-free operation.

▶ In order to ensure stability, built-under and integrated dishwashers must only be installed under a continuous countertop which is secured to adjacent cabinetry.

▶ A sink in the adjacent cabinet of the dishwasher must be properly sealed. Regularly check for leaks to avoid damage to the dishwasher.

▶ The dishwasher must only be built into a tall unit if additional safety precautions are taken. In order to safely install the appliance in a tall unit, please use the "Tall unit installation kit" and observe the installation plan provided. Otherwise there is the danger of the unit tipping over.

▶ The door springs must be evenly adjusted on both sides. They are correctly adjusted when the door remains stationary when left half open (approx. 45° opening angle). The door must not fall open on its own beyond this point.

The appliance must only be operated with properly adjusted door springs.

If the door cannot be adjusted properly, contact Miele.

The minimum/maximum weight of the front panel is quoted in the technical data for your dishwasher on the Miele website.

Correct use

▶ Do not use solvents in the dishwasher. There is a danger of explosion.

▶ Do not inhale or ingest dishwasher detergent. Some dishwasher detergents are strongly alkaline and contain irritants or corrosive ingredients. They can be extremely dangerous if swallowed, and can cause burning in the eyes, nose, mouth, and throat, or inhibit breathing. Avoid contact with the skin and eyes. Do not inhale powder detergents. Do not swallow dishwasher detergents. Seek medical advice immediately if detergent has been swallowed or inhaled. Contact a Poisons Information Centre (Australia) or the National Poisons Centre (NZ).

Warning and Safety instructions

- ▶ Avoid leaving the dishwasher door open unnecessarily. You could injure yourself on the open door or trip over it.
- ▶ Do not sit, stand, or lean on the open door. The dishwasher can tip over. This could injure you or damage the dishwasher.
- ▶ Dishes may be very hot at the end of the programme. Allow the dishes to cool until they are comfortable enough to handle before unloading them.
- ▶ Only use detergent and rinse aid formulated for domestic dishwashers. Do not use washing-up liquid.
- ▶ Do not use any commercial or industrial detergents. These may cause material damage, and there is a risk of a severe explosive chemical reaction (such as an explosive oxyhydrogen gas reaction).
- ▶ Do not fill the rinse aid reservoir with powder or liquid detergent. This will cause serious damage to the rinse aid reservoir.
- ▶ Do not fill the AutoDos with powder or liquid detergent. Loose detergent will damage the AutoDos.
- ▶ Do not fill the salt reservoir with powder or liquid detergent. Dishwasher detergent will damage the water softener.
- ▶ Only use special coarse-grained dishwasher salt or other pure evaporated salts for reactivation. Other types of salt (such as cooking salt, rock salt, agricultural grade or gritting salt) may contain insoluble components which can impair the functioning of the water softener.
- ▶ In dishwashers with a cutlery basket (depending on model), knives and forks should be placed with the handles upwards in the basket for safety reasons. Knives and forks placed with the handles downwards pose a danger of injury.
- ▶ Plastic items which cannot withstand being washed in hot water, such as disposable plastic containers or plastic cutlery, should not be cleaned in the dishwasher. The high temperatures in the dishwasher may cause them to melt or lose shape.
- ▶ If you use the timer option, the detergent compartment must be dry. Wipe dry with a cloth first if necessary. The detergent will clump together if the detergent compartment is not dry, and it may not be fully rinsed out.
- ▶ Please observe the information listed under Technical data regarding the capacity of the dishwasher.

Warning and Safety instructions

Accessories and spare parts

- ▶ Only use original Miele accessories. If other parts are used, warranty, performance, and, if applicable, product liability claims will be invalidated.
- ▶ Miele will guarantee to supply functional spare parts for a minimum of 10 years and up to 15 years following the discontinuation of your dishwasher.

Transport

- ▶ Damage to the dishwasher can compromise your safety. Before using the dishwasher, check it for any visible transport damage. Never use a damaged dishwasher.
- ▶ Only transport the dishwasher in an upright position so that no water flows into the electrical controls, as this would cause faults.
- ▶ If you wish to transport the dishwasher, empty it and securely fasten all loose parts such as baskets, hoses and mains connection cables.

Disposal of your old dishwasher

- ▶ Make the door lock inoperative so that children cannot accidentally shut themselves in. Remove or destroy the locking bracket of the door lock, and make appropriate arrangements for the disposal of the appliance.

Notes on the operating instructions

These operating instructions apply to several different dishwasher models of different heights.

The different dishwasher models will be named as follows:

Standard = dishwasher measuring 80.5 cm high (built-in appliance) or 84.5 cm high (freestanding appliance)

XXL = dishwasher measuring 84.5 cm high (built-in appliance).

Notes on the layout

Warnings

 Information which is important for safety is highlighted in a thick framed box with a warning symbol. This alerts you to the potential danger of injury to people or damage to property.

Read these warning notes carefully and observe the procedural instructions and codes of practice they describe.

Notes

Notes contain information of particular importance that must be observed.

They are highlighted by a thick framed box.

Additional information and comments

Additional information and comments are highlighted in a box framed with a thin black line.

Instructions for the user

Instructions on how to operate the dishwasher are identified by marked operating steps. They explain the procedure step by step.

Operating steps are indicated by a black square bullet point.

Example:

■ Select the desired setting and press *OK* to confirm.

Display

Information given via the display appears in a special display font to match the font on the appliance.

Example:

When the message *Close the door* appears in the display ...

Items supplied

The following items are supplied:

- Dishwasher
- Operating instructions for operating the dishwasher
- Installation sheet for installing the dishwasher
- Other installation accessories for installing the dishwasher (see installation sheet)
- Funnel for filling the dishwasher salt
- Additional printed matter and add-ons if required

Appliance overview

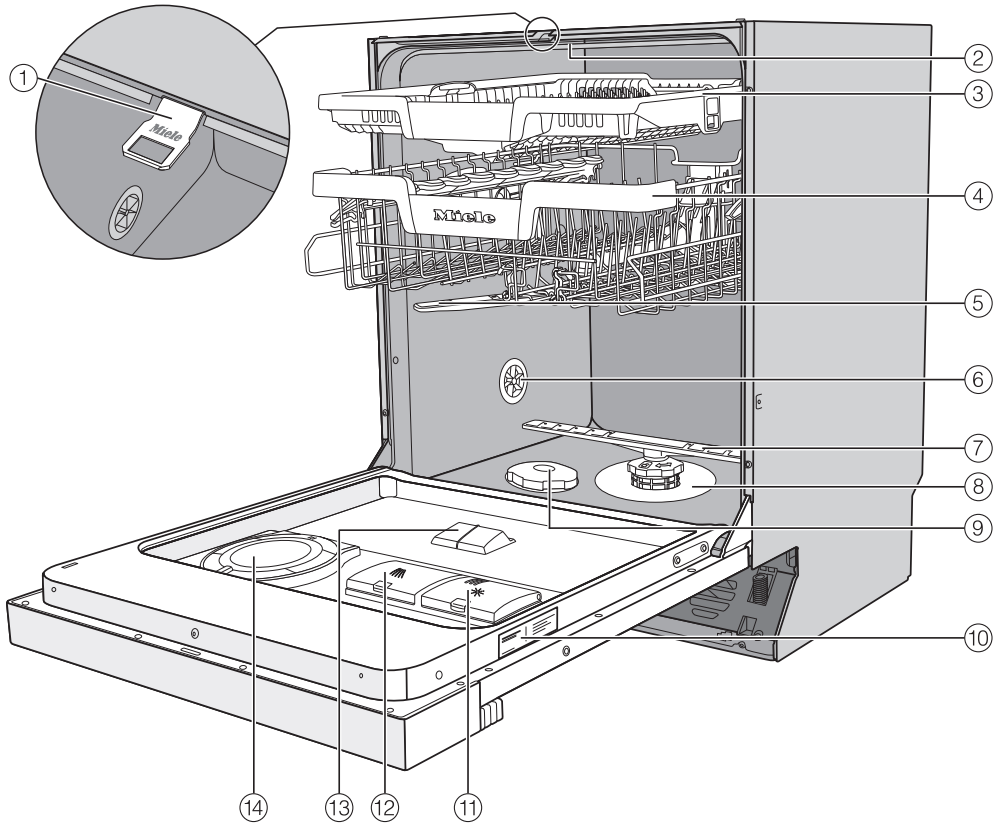

- ① Door locking pin
- ② Upper spray arm (not visible)
- ③ 3D MultiFlex cutlery tray
- ④ Upper basket
- ⑤ Middle spray arm
- ⑥ Aeration valve
- ⑦ Lower spray arm
- ⑧ Filter combination
- ⑨ Salt reservoir
- ⑩ Data plate
- ⑪ Rinse aid reservoir
- ⑫ Detergent compartment
- ⑬ AutoDos detergent outlet
- ⑭ AutoDos (automatic dispensing)
Lower basket (see next page)

Guide to the appliance

Lower basket

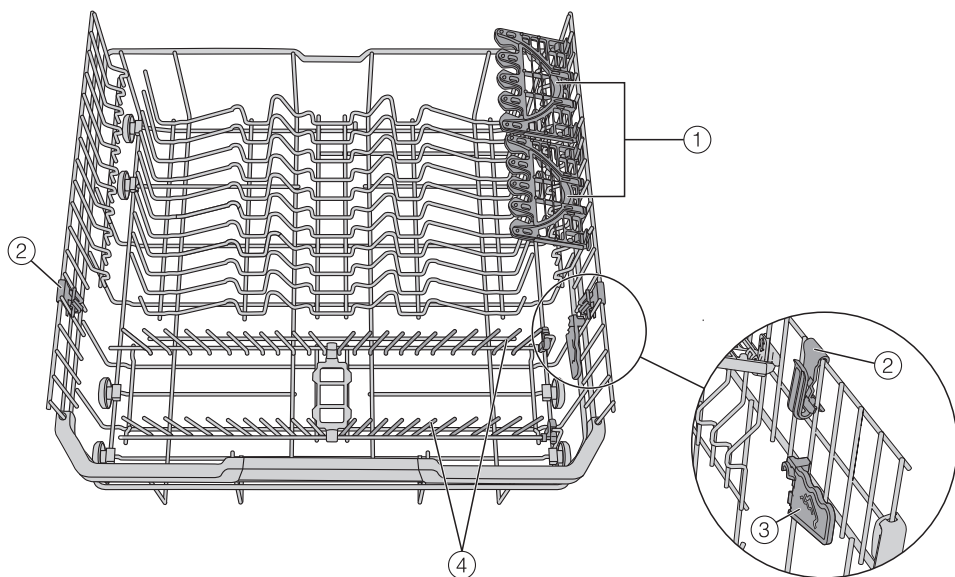

① FlexCare Glass & Bottle

② MultiClip

③ XL Assist

④ Hinged spikes

Control panel

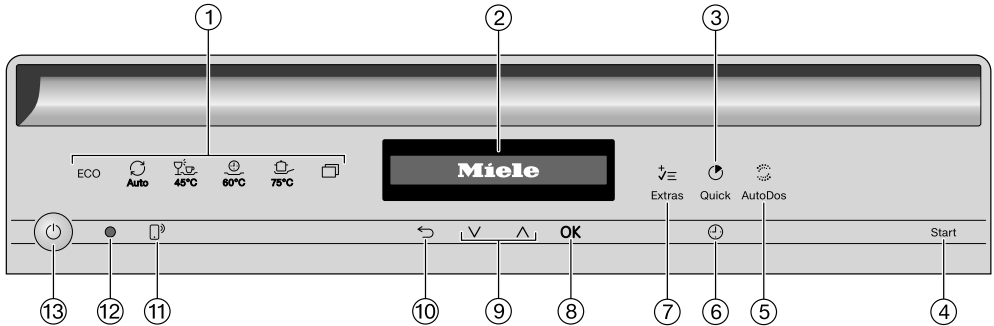

① Programme selection

- ECO = ECO
- Auto = Auto 45–60 °C
- 45 °C = ComfortWash 45 °C
- 60 °C = PowerWash 60 °C
- 75 °C = Intensive 75 °C
- = Further programmes/Settings

② Display

For further information, see “Guide to the appliance - Display functions” in the operating instructions..

③ Quick sensor

For reducing the programme running time.

④ Start sensor

For starting the selected programme.

⑤ AutoDos sensor

For activating/deactivating AutoDos.

⑥ Timer sensor

For selecting a later programme start.

⑦ Extras sensor

For selecting Extras.

⑧ OK sensor

For selecting menu options and values displayed.
For confirming messages.

⑨ √∧ sensors

For selecting “Further programmes”.
For changing the values displayed.
For scrolling to other menu pages.

⑩ Back sensor

For navigating back to the previous menu or deleting values which have been set previously.

⑪ MobileStart sensor

For activating/deactivating the MobileStart option.

⑫ Optical interface

For service technicians.

⑬ On/Off sensor

For switching the dishwasher on and off.

Guide to the appliance

Display functions

The display is used to select or set the following:

- the programme
- the timer
- the Settings 



The display can show the following:

- the programme stage
- the estimated time left for the programme to run
- the energy and water consumption (EcoFeedback)
- any relevant fault messages and information

To save energy, the dishwasher switches off after a few minutes if you do not touch any sensors during this time.

Touch the  sensor to switch the dishwasher back on.

The *OK* sensor is used to confirm a message, setting or programme and also to move to the next menu or another level.

Under  *Further programmes/Settings* a scroll bar  will appear in the right of the display. This offers further options. These options can be viewed using the \vee/\wedge sensors.

You can alter the dishwasher's controls to suit changing requirements in the Settings menu (see "Settings").

The option that is selected will have a tick  next to it.

To exit a sub-menu, use the  *Back* sensor.

If you do not press any sensors for several seconds, the display will revert to the previous menu. You will then have to enter your settings again.

Disposal of the packing material

The transport and protective packaging has been selected from materials which are environmentally friendly for disposal, and can normally be recycled.

Recycling the packaging reduces the use of raw materials in the manufacturing process and also reduces the amount of waste in landfill sites.

Ensure that any plastic wrappings, bags etc. are disposed of safely and kept out of the reach of babies and young children. Danger of suffocation.

Disposing of your old appliance

Electrical and electronic appliances often contain valuable materials. They also contain specific materials, compounds and components, which were essential for their correct function and safety. These could be hazardous to human health and to the environment if disposed of with your domestic waste or if handled incorrectly. Please do not, therefore, dispose of your old appliance with your household waste.



Please dispose of it at your local community waste collection / recycling centre for electrical and electronic appliances. You are also responsible for deleting any personal data that may be stored on the appliance prior to disposal. Please ensure that your old appliance poses no risk to children while being stored prior to disposal.

Using for the first time

Every dishwasher is tested at the factory. There will be residual water in the machine from this test. It is not an indication that the dishwasher has been used previously.

Opening the door

In some programmes the door automatically opens slightly to assist the drying process.

This function can be deactivated, if preferred (see “Settings - AutoOpen”).

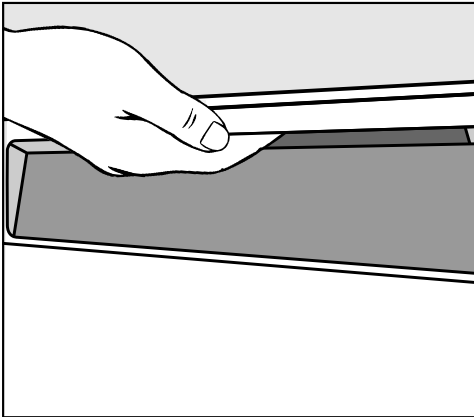

- To open the door, reach under the recessed grip and pull the handle firmly.
- Open the door fully to disengage the locking mechanism.

At the end of the programme, if the AutoOpen function is switched on, the door locking pin automatically retracts. The door locking pin must be fully retracted before you close the door again.

To prevent a technical fault, do not hold the door locking pin firmly when it is retracting.

If the door is opened during operation, all functions are automatically interrupted.

⚠ Risk of scalding due to hot water.

During operation, water in the dishwasher may be very hot. Only open the door if absolutely necessary and exercise extreme caution when doing so.

⚠ Risk of injury due to door opening automatically.

The door may open automatically at the end of a programme. Keep the area around the door free of obstructions.

⚠ Caution: Avoid blocking doors

The automatic door opening function could cause doors to be blocked. Install the dishwasher so that the door does not block any other doors or cabinet fronts when it opens automatically.

Closing the door

- Push the baskets right in.
- Raise the door upwards until the catch engages.

At the end of the programme, if the AutoOpen function switched is on, the door locking pin must be fully retracted before the door is closed. Otherwise, the door locking pin will hit the door.



Risk of crushing due to the door closing.

When closing the door, you are at risk of jamming your fingers in it.

Do not put your hand inside the door as it is closing.

Activating the safety lock

Use the safety lock to prevent children opening the dishwasher door. The door can then only be opened by using a lot of force.

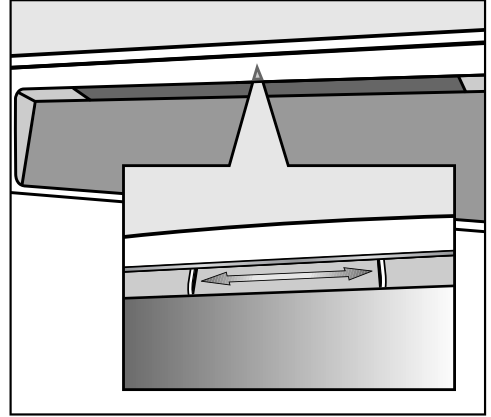

- To lock the door, push the slide underneath the door grip to the right.
- To unlock the door, push the slide to the left.

Using for the first time

Miele@home

Your dishwasher is equipped with an integrated Wi-Fi module.

To use this feature, you will need:

- a Wi-Fi network
- the Miele App
- a Miele user account. The user account can be created via the Miele App.

The Miele App will guide you as you connect your dishwasher to your home Wi-Fi network.

Once your dishwasher is connected to your Wi-Fi network, you can use the App to carry out the following tasks:

- Control your dishwasher remotely
- Call up information on the operating status of your dishwasher
- Call up information on the programme sequence of your dishwasher

Connecting the dishwasher to your Wi-Fi network will increase energy consumption, even when the dishwasher is switched off.

Make sure that your Wi-Fi network signal strength is strong enough at the installation site of your dishwasher.

Availability of the Wi-Fi connection

The Wi-Fi connection shares a frequency range with other appliances (including microwave ovens and remote control toys). This may result in sporadic or even complete connection failures. Therefore, a constant availability of featured functions cannot be guaranteed.

Miele@home availability

The ability to use the Miele App depends on the availability of the Miele@home service in your country.

The Miele@home service is not available in every country.

For information about availability, please visit www.miele.com.

Miele App

You can download the Miele App from the Apple App Store® or the Google Play Store™ free of charge (only functional in selected countries).



Standard settings

Switching on the dishwasher

- Switch the dishwasher on using the  sensor.

The welcome screen will appear when the dishwasher is switched on and the welcome melody will sound.

For further information about the display functionality, see “Guide to the appliance - Display functions”.

Setting the language

The display will change automatically to the screen for setting the language.

- Select the language and the country, if applicable, using the \vee/\wedge sensors, and confirm with *OK*.

For further information on setting the language, see “Settings - Language”.

A tick  will appear next to the language that has been set.

Setting up Miele@home

The message *Set up Miele@home* will appear in the display.

- To set up Miele@home now, confirm by touching *OK*.

Useful tip: To postpone setup until later, select the option *Skip* and confirm with *OK*.

There are two ways of connecting your dishwasher to your Wi-Fi network:

- Select the connection method you want and confirm your selection with *OK*.

1. Connect using App
2. Connect using WPS

You will then be guided by the display and the Miele App.

For further information on Miele@home, see “Settings - Miele@home”.

Using for the first time

Setting the time of day

The time is updated automatically if a connection is established to the Wi-Fi network.

The display will then change to the screen for setting the time.

The current time of day must be set before you can use the timer option.

- Use the \vee/\wedge sensors to enter the hour and confirm your entry with *OK*.
- Then set the minutes and confirm with *OK*.

Keeping the relevant \vee or \wedge sensor pressed will increase or decrease the time automatically.

Setting the water hardness

The display will change to the screen for setting the water hardness.

- The dishwasher needs to be programmed to the correct water hardness for your area.
- Your local water authority will be able to advise you of the water hardness level in your area.
- Where the water hardness fluctuates, e.g. between 1.8 and 2.7 mmol/l (10 - 15 °dH - German scale), always programme the dishwasher to the higher value (2.7 mmol/l or 15 °dH in this example).

In the event of a fault, it will help the service technician if you know the hardness of your local water supply.

Enter the water hardness below:

_____ mmol/l

The dishwasher is programmed at the factory for a water hardness level of 0.36 mmol/l (2 °dH - German scale).

- Set the water hardness level in your area and confirm with *OK*.

See “Settings - Water hardness” for more information.

Activating AutoDos

The display changes to the settings screen for AutoDos (see “Detergents - Automatic dispensing/AutoDos”).

Even if you do not wish to use AutoDos, you must remove the tag from the AutoDos lid before running the first programme sequence (see “Detergent – Activating AutoDos”).



You can activate AutoDos.

If you do not wish to use AutoDos, you can manually dispense the detergent via the detergent compartment (see “Detergents - Manual detergent dispensing”).

- Select the setting you want and confirm with *OK*.

This setting applies to all programmes and you can change it at any time using the  *AutoDos* sensor.

Finally, prompts will appear in the display.

After confirming these prompts with *OK*, the messages  Refill salt and  Refill rinse aid may appear.

- Add salt and rinse aid if necessary (see “Using for the first time - Dishwasher salt” and “Rinse aid”).
- Select *OK* to confirm the messages.

When a programme is selected, it will appear briefly in the display and the appropriate sensor will be illuminated. Next, the estimated energy and water consumption may be shown for the selected programme for several seconds.

Then the display will show the estimated programme running time for the programme selected.

Using for the first time

Dishwasher salt

In order to achieve good cleaning results, the dishwasher needs to operate with soft water. Hard water results in the build-up of calcium deposits on dishes and on the inner surfaces of the appliance.

Water with a hardness level higher than 0.9 mmol/l (5 °dH – German scale) must be softened. This occurs automatically in the integrated water softener. The water softener is suitable for a water hardness level of up to 12.5 mmol/l (70 °dH - German scale).

In order to maintain the functioning of the water softener, it must be reactivated regularly. Reactivation occurs automatically in every ninth programme sequence. At the start of the next programme, an additional 4.4 l of water is required for this process. Energy consumption increases by 0.015 kWh and the programme is extended by approx. 3 minutes.

The above applies to the ECO programme at a water hardness of 2.5 mmol/l (14 °dH – German scale). For other programmes and water hardness levels, only the frequency of reactivation will differ.

In order to be reactivated, the water softener requires dishwasher salt. Depending on the water hardness level (< 3.8 mmol/l, or < 21 °dH – German scale), dishwasher salt is not required if combination detergents are being used (see “Detergents - Types of detergents”).

If the water in your area is very soft and constantly **lower than 0.9 mmol/l (5 °dH - German scale)** you do **not** need to add dishwasher salt. The salt refill indicator will automatically switch off after the water hardness has been set accordingly (see “Settings - Water hardness”).

 Damage to the water softener from detergents.
Dishwasher detergent will damage the water softener.
Do not fill the salt reservoir with powder or liquid detergent.

 Damage caused by using unsuitable salts.
Some types of salt may contain insoluble components which can cause the water softener to malfunction.
Only use special coarse-grained dishwasher salt or other pure evaporated salts for reactivation.

If you only ever use combination detergent products in your dishwasher, you can switch off both refill reminders if you wish (see “Settings - Refill reminders”).

Please make sure that if you stop using combination detergents, you refill the dishwasher salt and rinse aid. Switch the refill reminders back on if required.

Filling the salt reservoir

Before filling the salt container for the first time, you must fill it with approx. 1.5 l of water to enable the salt to dissolve.

Once the dishwasher has been used, there is always sufficient water in the salt reservoir.

- Remove the lower basket from the wash cabinet and unscrew the salt container cap.

 Risk of corrosion due to saline solution.

Water or saline solution will run out of the reservoir when the cap is opened. Saline solution that runs out can cause corrosion in the wash cabinet and to the dishwasher load.

The salt reservoir should therefore only be opened to replenish the salt.

- Fill the salt reservoir with approx. 1.5 litres of water (first use only).

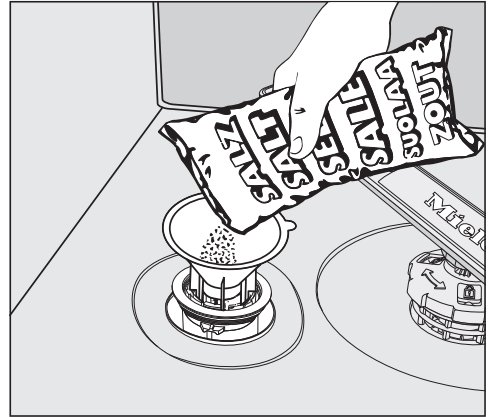

- Place the funnel provided over the salt container and carefully fill with dishwasher salt until the container is full. The salt reservoir holds up to 2 kg of salt, depending on the type of salt used.
- Clean off salt residues from around the salt reservoir opening. Next, screw the salt reservoir cap on again firmly.
- Immediately after filling the salt container and each time you remove the salt container cap, run the Rinse salt programme without load items in the dishwasher to dissolve and remove any traces of salt from the wash cabinet.

Using for the first time

Replenishing salt

- When  Refill salt appears in the display, wait until the end of the programme and then refill the salt reservoir.
- Confirm with *OK*.

The salt refill indicator will go out.



Risk of corrosion due to saline solution.

Saline solution that runs out can cause corrosion in the wash cabinet and to the dishwasher load.

Immediately after filling the salt container and each time you remove the salt container cap, run the *Rinse salt* programme without load items in the dishwasher to dissolve and remove any traces of salt from the wash cabinet.

After the salt reservoir has been filled, the salt refill indicator may still appear in the display if the salt concentration has not yet reached the correct level. In this case, confirm the message again with *OK*.

The salt refill indicator is deactivated if the dishwasher is set to a water hardness below 0.9 mmol/l (5 °dH - German scale).

Rinse aid

Rinse aid is necessary to ensure water does not cling to and leave marks on crockery during the drying phase, and it helps crockery dry faster after it has been washed.

Rinse aid is poured into the storage reservoir and the amount set is dispensed automatically.

 Damage caused by washing-up liquid or detergents.

Dishwasher detergent will destroy the rinse aid reservoir.

Only fill rinse aid designed for domestic dishwashers into the reservoir.

Alternatively, you can use liquid citric acid with up to 10% acid content. The dishes will be more moist and stained than with rinse aid.

 Damage caused by acids.

The dishwasher can be damaged by acids with a higher concentration.

Never use citric acid or vinegar with a higher acid content (e.g. vinegar essence 25% acid).

If you only ever use combination detergent products in your dishwasher, you do not need to fill the rinse aid reservoir. However, the best rinsing and drying results will be achieved by using a detergent together with separate dishwasher salt and rinse aid.

If you want to permanently use combination detergent products in your dishwasher, you can switch off the refill reminders for salt and rinse aid if you wish (see “Settings - Refill reminders”).

Please make sure that if you stop using combination detergents, you refill the dishwasher salt and rinse aid. Switch the refill reminders back on if required.

Using for the first time

Adding rinse aid

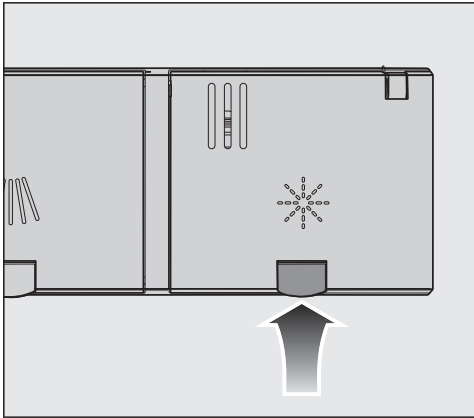

- Lift the yellow catch on the lid of the rinse aid container ☼.

The lid will spring open.

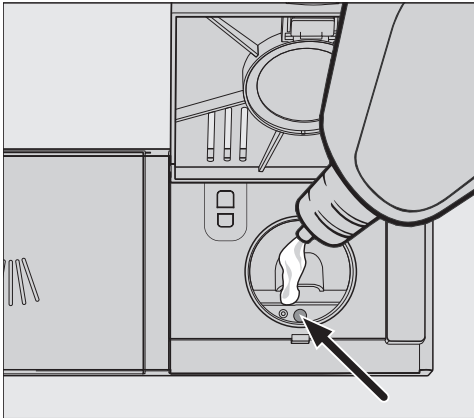

- Only add rinse aid until the fill level indicator (see arrow) turns dark when the door is open horizontally.

The rinse aid reservoir holds approx. 110 ml.

- Close the flap firmly so that it clicks into place. Otherwise water can enter the rinse aid reservoir during a programme.

- Wipe up any spilled rinse aid. This prevents over-foaming occurring during the next programme.

You can adjust the rinse aid dosage for best results (see "Settings - Rinse aid").

Refilling rinse aid

When the ☼ Refill rinse aid message appears, the reservoir only contains sufficient rinse aid for another 2 - 3 programmes.



- Add rinse aid in good time.
- Confirm with *OK*.

The refill rinse aid reminder will go out.

You can alter the dishwasher's controls to suit changing requirements by adjusting the settings.

Settings can be altered at any time.

Opening the Settings menu

- Switch the dishwasher on with the  sensor if it is switched off.
- Touch the  Further programmes/Settings sensor.

The first of the further programmes will appear in the display.

- Use the \vee/\wedge sensors to select the  menu option and confirm with *OK*.

The first option in the Settings menu will appear in the display.

For further information about the display functionality, see "Guide to the appliance - Display functions".

Changing settings

- Use the \vee/\wedge sensors to select the menu option you want to change and confirm your selection with *OK*.

Submenu options that have already been selected will have a tick  beside them.

- Select the setting you want using the \vee/\wedge sensors and confirm with *OK*.
- To exit a submenu use the  sensor.

The display will revert to the menu above.

Closing the Settings menu

- Touch the  sensor.



The display will change to the  menu.

Settings

Language

The display can be set to appear in one of several different languages.

You can change the language used in the display and also the country via the Language  submenu.

The flag after the word Language  serves as a guide if a language that you do not understand has been set. In this case keep selecting the menu option that has a flag after it until you reach the Language  submenu.

Time of day

The current time of day must be set before you can use the timer option.

Setting the clock format

You can select either a 24-hour or 12-hour clock.

- Select the Clock format menu option.
- Select the desired setting.

Setting the time of day

You can set the current time.

- Select the Set menu option.
- Use the \vee/\wedge sensors to enter the hour and confirm your entry with *OK*. Then set the minutes and confirm with *OK*.

The time of day has now been saved.

If connection is established to a Wi-Fi network, the time of day is set automatically.

Water hardness

Your dishwasher is fitted with a water softener.

- The dishwasher needs to be programmed to the correct water hardness for your area.
- Your local water authority will be able to advise you of the water hardness level in your area.
- Where the water hardness fluctuates, e.g. between 1.8 and 2.7 mmol/l (10 - 15 °dH - German scale), always programme the dishwasher to the higher value (2.7 mmol/l or 15 °dH in this example).

If the water hardness in your area is available in a unit other than °dH, you can convert the values as follows:
 $1\text{ °dH} = 0.18\text{ mmol/l} = 1.78\text{ °fH}$

Setting the water hardness

- Select the water hardness level in your area and confirm with *OK*.

AutoDos (automatic dispensing)

Automatic dispensing automatically adjusts the amount of detergent to the selected programme. In the *Auto* programme, the quantity is adjusted depending on the degree of soiling of the crockery.

If you want to extend the service life of the PowerDisk, you can reduce the dispensing quantity. The programme's cleaning performance may decrease as a result.

If you want to improve the cleaning performance, you can increase the dispensing quantity. This reduces the service life of the PowerDisk.

Setting the Dosage amount

For best results, you can adjust the dispensing quantity of the PowerDisk.

- Select the *Dosage amount* menu option.
- Select the desired setting.

Settings

Rinse aid

You can adjust the rinse aid dosage for best results.

The rinse aid dosage can be set from 0 to 6 ml.

3 ml is the factory default setting.

If spots appear on crockery and glassware:

- Increase the rinse aid dosage.

If clouding or smearing appears on crockery and glassware:

- Decrease the rinse aid dosage.

Save Extras

You can set whether the selected Extras are to remain permanently activated for the respective programme.

Miele@home

Your dishwasher is equipped with an integrated Wi-Fi module.

You can connect your dishwasher to your Wi-Fi network.

This will increase the energy consumption, even when the dishwasher is switched off.

Additional menu options will be added to the “Settings“ and “Miele@home” menus.

Make sure that your Wi-Fi network signal strength is strong enough at the installation site of your dishwasher.

There are a number of ways of connecting your dishwasher to your Wi-Fi network:

Performing Scan & Connect

Initial commissioning has been carried out without Miele@home having been set up.

- Scan the QR code.

If you have installed the Miele App and have a user account, you will be taken directly to the networking steps.

If you have not yet installed the Miele App, you will be taken to the Apple App Store® or the Google Play Store™.

- Install the Miele App and set up a user account.
- Scan the QR code again.

The Miele App will guide you through the set-up process.



Connect using App

The Miele App is available to download free of charge from the Apple App Store® or from the Google Play Store™.



- Select the Connect using App menu option and confirm with *OK*.
- Follow the instructions in the App.

Once the dishwasher is connected to your Wi-Fi network, you can use the App to carry out the following tasks:

- Control your dishwasher remotely

- Call up information on the operating status of your dishwasher
- Call up information on the programme sequence of your dishwasher
- Set up a Miele@home network with other Wi-Fi-enabled Miele appliances

Connect using WPS

As an alternative to networking via the Miele App, you can connect your dishwasher to your Wi-Fi network using WPS (Wireless Protected Setup).

Your Wi-Fi router must support WPS.

- Select the Connect using WPS menu option and confirm with *OK*.
- Confirm the message Press WPS button with *OK*.
- Activate the WPS function on your router within two minutes.
- Once the connection has been established, confirm the message with *OK*.

If the connection fails, you have probably not connected WPS on your router quickly enough. Repeat the steps above.

Settings

Deactivate

If you do not wish to use the Wi-Fi module of your dishwasher, you can switch it off.

- Select the *Deactivate* menu option.

In the *Miele@home* menu, the menu option *Activate* will now be displayed instead of *Deactivate*.

Activate

If you wish to connect your dishwasher to your Wi-Fi network, you can switch on the Wi-Fi module.

- Select the *Activate* menu option.

In the *Miele@home* menu, the menu option *Deactivate* will now be displayed instead of *Activate*.

Connection status

You can call up the current connection status of your dishwasher.

- Select the *Connection status* menu option and confirm with *OK*.
- Use the \vee/\wedge sensors to consecutively call up the Wi-Fi signal strength, the name of your router, and the associated IP address.
- Select *OK* to confirm the messages.

Set up again

This menu option only appears if you have connected your dishwasher to your Wi-Fi network before.

Connect using App

- Select the *Connect using App* menu option.
- Follow the instructions in the App.

Connect using WPS

- Select the *Connect using WPS* menu option.
- Follow the instructions in the display.

Reset

This menu option only appears if you have connected your dishwasher to your Wi-Fi network before.

You can use this menu option to reset all Wi-Fi module settings to the factory default settings.

The network configuration should be reset whenever a dishwasher is being disposed of or sold, or if a used dishwasher is being put into operation. This is the only way to ensure that all personal data has been removed and, in the case of the latter, a previous owner will no longer be able to access the dishwasher.

- Select the **Reset** menu option and confirm with *OK*.

Remote control

This menu option will only be displayed if you have connected your dishwasher to your Wi-Fi network (see “Settings - Miele@home”).

If you wish to permanently switch off the **Remote control** option, you can do this under this menu option. The  *MobileStart* sensor will then no longer be available to select until you change this setting again.

Even if the **Remote control** option is switched off, you can use the Miele App to call up information about your appliance. However, you cannot start any programmes or change any settings from it.

Settings

RemoteUpdate

The RemoteUpdate menu option is only displayed and can only be selected if the requirements for using Miele@home have been met (see "Using for the first time - Miele@home").

The RemoteUpdate function is used for updating the software in your dishwasher. If an update is available for your dishwasher, it will automatically download it. Updates will not be installed automatically. They must be initiated manually.

If you do not install an update, you can continue to use your dishwasher as usual. However, Miele recommends installing updates.

Activating/deactivating

The RemoteUpdate function is activated as standard. Available updates will be downloaded automatically but will only be installed if you initiate the installation manually.

Deactivate RemoteUpdate if you do not want any updates to be downloaded automatically.

Running a RemoteUpdate

Information about the content and scope of a RemoteUpdate will be provided in the Miele App.

A message will appear in your dishwasher display if a software update is available.

You can install the update immediately or postpone this until later. When the appliance is switched on again, you will be reminded about the update.

Deactivate RemoteUpdate if you do not want to install the update.

The update may take several minutes.

Please note the following information about the RemoteUpdate function:

- You will only receive a message when an update is available.
- Once an update has been installed, it cannot be undone.
- Do not switch the dishwasher off during the update. Otherwise, the update will be aborted and will not be installed.
- Some software updates can only be carried out by a Miele service technician.

SmartStart

This menu option will only be displayed if you have connected your dishwasher to your Wi-Fi network (see “Settings – Miele@home”).

The SmartStart function (only functional in selected countries) is used for starting your dishwasher automatically at a time when energy costs are most economical.

To use this function you may need further technical accessories.

If you have activated SmartStart Permitted, the Timer ⌚ menu of the selected programme will no longer show EcoStart but will instead show SmartStart (see “Options – Timer”). The dishwasher will then start within the timeframe specified when it receives a signal from the energy supplier.

If it has not received a signal from the energy supplier by the latest possible start time, the dishwasher will start automatically.

EcoStart

In order to run your dishwasher in the most economical way, you can use the EcoStart option to take advantage of your electricity supplier’s cheaper energy tariffs (see “Options - Timer”). With this option selected, your dishwasher will start automatically at your electricity supplier’s cheapest rate times.

To use this option, you must first set up to three electricity rate tariff times in which the dishwasher can start. You can allocate different priorities to these tariff times. The time with the cheapest electricity rate will be given Priority 1.

Contact your energy supplier to find out the times of the cheapest electricity rates.

Once the electricity rate times have been set, you can use the EcoStart option to set the latest finish time required for each programme. The dishwasher will then start automatically during the cheapest energy rate time period. The programme will end at the set finish time at the latest.

Settings

Setting the electricity tariff times

Before you can use the EcoStart option, you must set at least one electricity tariff time.

- Use the \vee/\wedge sensors to select an electricity tariff time T1 to T3 and confirm with *OK*.

The start of the electricity tariff time selected will appear in the display and the hour number block will be highlighted.

- Use the \vee/\wedge sensors to set the hour and minutes for the start time and confirm both with *OK*.

The end of the electricity tariff time selected will appear in the display and the hour number block will be highlighted.

- Use the \vee/\wedge sensors to set the hour and minutes for the finish time and confirm both with *OK*.

The electricity tariff time will be saved and its priority will appear in the display.

- Use the \vee/\wedge sensors to set the priority you want and confirm with *OK*.
- Confirm the message with *OK*.

The electricity tariff time will be activated.

Changing the electricity tariff times

You can change the start, finish, or priority of an electricity tariff time.

- Use the \vee/\wedge sensors to select an electricity tariff time T1 to T3 that you wish to change and confirm with *OK*.
- Select the setting you want to change and confirm with *OK*.
- Use the \vee/\wedge sensors to change the setting and confirm with *OK*.
- Confirm the message with *OK*.

The change will be saved.

Deleting the electricity tariff times

You can delete the settings for an energy tariff time and in doing so deactivate the *EcoStart* option for this time zone.

- Use the \vee/\wedge sensors to select an electricity tariff time T1 to T3 that you wish to delete and confirm with *OK*.
- For example, select *Delete T1* and confirm with *OK*.
- For example, select *Delete T1?* and confirm with *OK*.

The settings for the electricity tariff time selected will be reset.

- Confirm the message with *OK*.

The energy tariff time has been deleted.

Display (EcoFeedback)

You can set whether the energy and water consumption is displayed for the selected programme. This function shows the estimated consumption before a programme sequence and the actual consumption after the end of the programme (see “Caring for the environment – EcoFeedback consumption display”).

Display brightness

You can set the display brightness to one of seven different levels.

Settings

Volume

A sequence of signal tones will sound at the end of the programme or if there is a fault, provided that the acoustic signals are activated.

Signal tones in the event of a fault

In the event of a fault, the alarm tone will sound four times at intervals with a short pause between each set of tones.

The alarm tone that sounds when there is a fault cannot be deactivated.

Signal tones

The signal tones at the end of a programme will sound four times at intervals with a short pause between each tone.

The volume of the signal tones at the end of the programme can be set to one of seven different settings. If no volume is selected, the signal tones are switched off.

Keypad tone

An audible tone sounds each time a sensor is pressed.

The volume for the keypad tone can be set to one of seven different settings. If no volume is selected, the keypad tone is switched off (except for the  *On/Off* sensor).

Welcome melody

If you switch the dishwasher on or off, a brief melody will sound.

You can switch this melody off.

Refill reminders

If you only ever use combination detergent products or automatic dispensing using Miele PowerDisks (if available), you can switch off the refill reminders for dishwasher salt and rinse aid if you wish.

Please make sure that if you stop using combination detergents, you refill the dishwasher salt and rinse aid. Switch the refill reminders back on.

AutoOpen

In some programmes the door automatically opens slightly to assist the drying process.

This function can be deactivated if you wish. However, this negatively affects the drying process in most cases.

 Risk of injury due to door opening automatically.

The door may open automatically at the end of a programme.

Keep the area around the door free of obstructions.

 Risk of damage due to steam.

Steam from the dishwasher could damage delicate housing units and the edges of worktops when you open the door at the end of the programme if the fan is no longer running.

If you have deactivated the automatic door opening function but would still like to open the door at the end of the programme, make sure that you open the door fully.

2nd interim rinse

You can choose this function to increase the cleaning performance of the programmes with a second interim rinse.

When this function is activated, water consumption may increase.

If this function is switched on, it will be applied to all programmes until it is switched off again.

Hygiene cycle

If you mainly use low temperature programmes (< 50 °C), there is a risk of bacteria and unpleasant odours building up in the wash cabinet (see “Cleaning and care – Hygiene cycle”).

If this function is switched on, a message will be displayed recommending the use of a high temperature programme after several low temperature programmes have been run.

Settings

Water connection

You can set your water connection type.

- If you select *Automatic (default)*, the dishwasher detects which water connection is currently being used and automatically selects the right setting.
- Select *Cold water* if you are only using a cold water connection.
- Select *Warm water* if you are only using a hot water connection.

System lock

The system lock prevents your dishwasher being used without your knowledge.

If an attempt is made to switch the dishwasher on when the system lock is activated, the  symbol will appear in the display.

The lock must be deactivated before the dishwasher can be used.

The appliance will lock each time it is switched on as long as the system lock is activated.

The appliance is delivered with the system lock deactivated.

Deactivating the system lock

To unlock the dishwasher, proceed as follows:

- Switch the dishwasher on using the  sensor.

The  symbol appears in the display.

- Touch the *OK* sensor for 6 seconds.

After 6 seconds, the dishwasher will be unlocked and ready for use.

Information

You can display the following information about your dishwasher:

- Operating hours (see also "Options – Displaying the operating hours")
- Programme sequences
- Total consumption
- Fault memory
- Data plate
- Software version

Showroom programme

For demonstration purposes only.

The dishwasher is equipped with a demo mode for showroom use.

Factory default

You can reset all dishwasher settings to the factory default settings.

The settings of the Wi-Fi module (where applicable) have to be reset separately (see "Settings – Miele@home – Reset").

- Select **Reset** and confirm with **OK**.

Copyright and licences for the communication module

For the purpose of operating and controlling the communication module, Miele uses proprietary or third-party software that is not covered by open source licensing terms. These items of software/software components are protected by copyright. The copyright powers of Miele and third parties must be respected.

In addition, the communication module contains software components which are distributed under open source licensing terms. The open source components contained in the appliance along with the corresponding copyright notices, copies of the licensing terms valid at the time, and any further information can be accessed locally via IP using a web browser (*http://<IP address>/Licenses*), where <IP address> is the IP address of the appliance. The liability and warranty arrangements for the open source licences displayed in this location only apply in relation to the respective rights holders.

Caring for the environment

Economical dishwashing

This dishwasher is exceptionally economical in its use of water and electricity.

You can support the economical operation of your appliance by following these tips:

- Washing in a dishwasher generally uses less water and energy than washing dishes by hand.
 - Pre-rinsing dishes under running water is not necessary and unnecessarily increases water and energy consumption.
 - For the most economical dishwashing, make full use of the basket capacity without overloading the dishwasher. This results in the most economical use of the dishwasher in terms of energy and water consumption.
 - Choose the programme to suit the type of crockery being washed and the degree of soiling (see “Programme chart”).
 - Select the *ECO* programme for energy-saving dishwashing. This programme is the most efficient in terms of its combined energy and water consumption for cleaning dishes with a normal level of soiling.
 - If you have a hot water connection, select the *SolarSave* programme (see “Installation – Water inlet”). The wash water will not be heated up during this programme.
 - Follow the detergent manufacturer’s recommendations on detergent dosage.
- If you are manually dosing the detergent, reduce the amount of detergent by $\frac{1}{3}$ when using powder or liquid detergent if the baskets are only half full.

EcoFeedback consumption display

The "EcoFeedback" function is used for calling up information about the energy and water consumption of your dishwasher (see "Settings – Display (EcoFeedback)").

The following information can be viewed in the display:

- An estimate of the consumption before the programme begins
- The actual consumption at the end of the programme
- The total consumption of the dishwasher to date

1. Consumption estimate

After a programme has been selected, first the name of the programme and after a few seconds the estimated energy consumption $\text{--}\text{C}$ and water consumption δ will appear in the display.

The estimated consumption will be shown as a bar chart. The more bars that are shown (■■■), the higher the energy or water consumption.

The values are influenced by the programme, the Extras selected, the ambient conditions and the size of the load.

The display will change automatically from showing the estimated consumption to showing the time remaining.

The estimated consumption function is activated as standard. This function can be deactivated, though, if preferred (see "Settings – Display (EcoFeedback)").

2. Displaying consumption

At the end of the programme, you can call up the actual energy and water consumption for the programme that has just been run.

- Confirm the message Consumption (OK) with *OK*.

Switching the dishwasher off at the end of the programme will delete the actual consumption values for the programme that has just been run.

3. Total consumption

You can display the total consumption of energy and water for all previously used programmes of your dishwasher (see "Settings – Information").

Loading the dishwasher

General information

Remove coarse food residues from crockery.

There is no need to pre-rinse items under running water.



Damage can be caused by ash, sand, wax, lubricant, or paint.

These substances will contaminate the dishwasher and can then no longer be removed.

Do not wash items soiled with these substances in the dishwasher.

Dishes can be loaded anywhere in the baskets. However, please try to observe the following notes:

- Do not place dishware or cutlery inside other pieces. They will cover one another.
- Load the crockery so that water can access all surfaces. This ensures that they will get properly cleaned.
- Make sure that all items are securely positioned.
- Hollow items such as cups, glasses, and saucepans etc. must be inverted in the baskets.
- Tall and narrow, hollow items such as champagne flutes should be placed in the centre of the basket rather than in the corners. This ensures the hollow items are more easily accessed by the water jets.
- Wide based items should be placed at an angle so that water can run off them freely.
- The spray arms must not be blocked by items that are too tall or hang through the baskets. Test for free movement by manually rotating the spray arms.

- Make sure that small items cannot fall through the holders in the baskets. Small items such as lids should therefore be placed in the 3D MultiFlex tray.

Some foods such as carrots, tomatoes, or tomato sauce may contain natural dyes. These dyes can discolour plastic items in the dishwasher if large quantities of these foods are in contact with the crockery inside the machine. The stability of plastic items is not affected by this discolouration.

Washing silverware can also cause plastic items to discolour.

Loading the dishwasher

Items not suitable for washing in the dishwasher:

- Wooden cutlery and crockery or items with wooden parts. These may discolour and fade. Furthermore, the glue used in these items is not dishwasher safe. Wooden handles may come loose after being washed in the dishwasher.
- Craft items, antiques, valuable vases, and decorative glassware. Such items are not suitable for dishwashers.
- Plastic items that are not heat resistant. The high temperatures in the dishwasher may cause them to melt or lose shape.
- Copper, brass, tin, and aluminium items. These may discolour or become dull.
- Colours painted over a glaze: this type of decoration may fade after a number of cycles.
- Delicate glassware and glassware containing lead crystal. Clouding may occur over time.

Silverware

 Damage due to unsuitable detergents.

If silverware is cleaned using an unsuitable cleaning agent, it can be irreparably damaged.

Silverware that has been in contact with foods containing sulphur can discolour. These include egg yolk, onions, mayonnaise, mustard, pulses, fish, fish brine and marinades.

Silverware previously cleaned with a **silver polish** may still be damp or spotted at the end of a programme, as water has not run off smoothly.

Useful tip: Rub the silverware dry with a cloth.

 Damage due to caustic alkaline detergents.

Aluminium parts (e.g. the grease filters of rangehoods) can be damaged by caustic alkaline detergents. In extreme cases, there is a risk of an explosive chemical reaction (such as an explosive oxyhydrogen gas reaction).

Aluminium components must not be cleaned in the dishwasher with caustic alkaline commercial or industrial detergents.

Useful tip: When purchasing new crockery and cutlery, make sure they are dishwasher safe if you want to wash them in the dishwasher.

Glass care

- Clouding may occur on glasses after frequent washing in the dishwasher. When washing delicate glassware in the dishwasher, select a special glass care programme with a low temperature (see “Programme chart”). This will reduce the risk of clouding.
- Purchase glassware that is dishwasher safe (e.g. Riedel glassware).
- Use detergents with glass protective additives.

Loading the dishwasher

Upper basket

See “Loading the dishwasher - Loading examples” for examples of how to load crockery and cutlery.

Loading the upper basket

 **Damage due to leaking water.**

If you run the dishwasher without the upper basket, water can leak out of the dishwasher.

Only run the dishwasher with the upper basket in place (except with the programme Tall items, if available).

- Use the upper basket for small, lightweight, and delicate items such as cups, saucers, glasses, dessert bowls, etc.
Shallow pans or casserole dishes can also be placed in the upper basket.
- Long items such as ladles and mixing spoons should be placed lying down across the front of the upper basket.

Loading the FlexCare cup rack

You can put cups, small bowls, and flat dishes on the FlexCare cup rack. Glasses can be arranged along the cup rack so they sit securely during the programme.

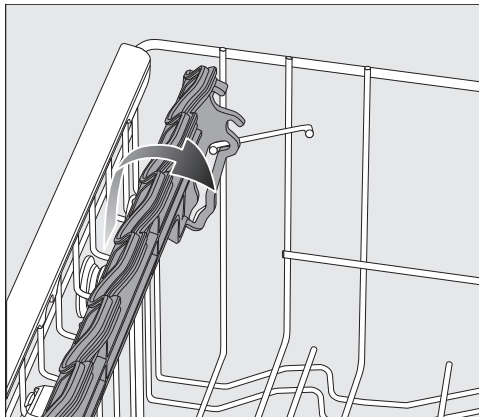

- Fold down the cup rack.
- Raise the cup rack upwards to make room for tall items.

Loading the dishwasher

Adjusting the FlexCare cup rack

You can set the height and depth of the cup rack at two different levels so that it can accommodate larger cups and so that taller items can be placed underneath it.

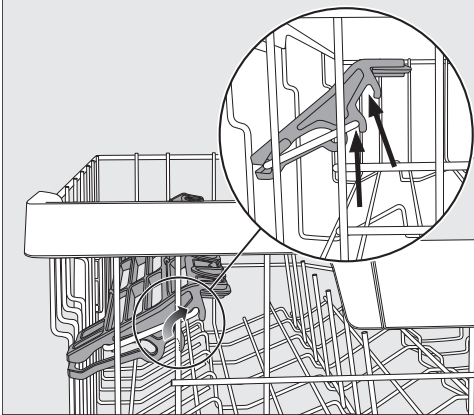

- Pull the cup rack upwards and click it into the desired position (see arrows).

Filling the openings of the FlexCare cup rack

The openings in the cup rack are specially designed to hold tall glasses with long stems securely.

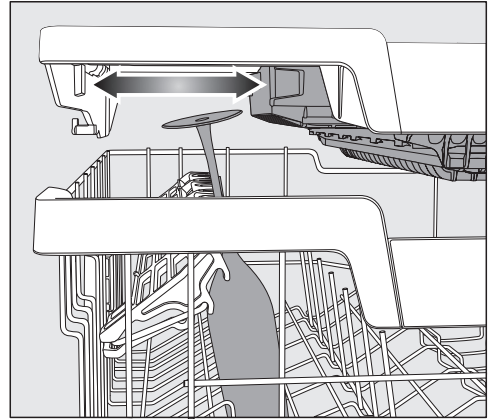

- Lower the cup rack and lean the glasses in the openings.
- If you wish you can adjust the left insert of the 3D MultiFlex tray to make space for taller glasses (see “Cutlery – 3D MultiFlex tray”).

Loading the dishwasher

Lowering the spikes

You can fold down every second spike in the two front right-hand rows of spikes to make it easier to arrange larger pieces of crockery, e.g. cereal bowls.

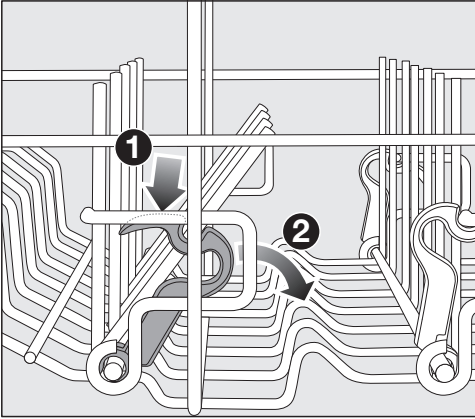

- Press the yellow lever downwards ① and then lower the dark gray spikes ②.
- Place the items vertically in the row of spikes.

Adjusting the upper basket

In order to gain more space for taller items, the upper basket can be adjusted on three levels with 2 cm between each level.

The upper basket can also be set at an angle so that water can run off freely from recesses. Make sure, however, that the basket can slide smoothly in and out of the wash cabinet.

- Pull out the upper basket.

Raise the upper basket:

- Lift the basket up until it clicks into place.

Lower the upper basket:

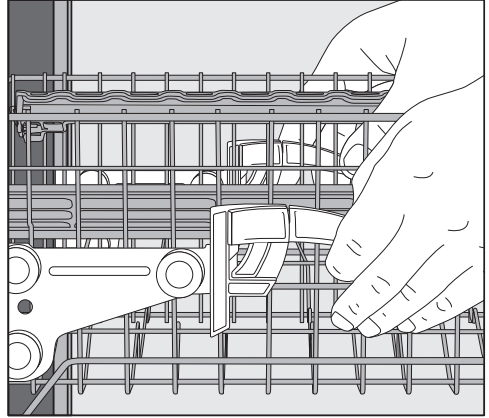

- Pull upwards on the levers at either side of the upper basket.
- Adjust the basket to the desired height and then push the levers securely back down into position.

When adjusting the upper basket, make sure that tall plates in the lower basket do not block the middle spray arm.

Loading the dishwasher

Lower basket

See “Loading the dishwasher - Loading examples” for examples of how to load crockery and cutlery.

Loading the lower basket

- Place larger and heavier items such as plates, serving platters, saucepans, serving bowls etc., in the lower basket.

Glasses, cups, small plates and saucers can also be placed in the lower basket.

Loading the MultiComfort area

The rear section of the lower basket is used for washing cups, glasses, plates, and saucepans.

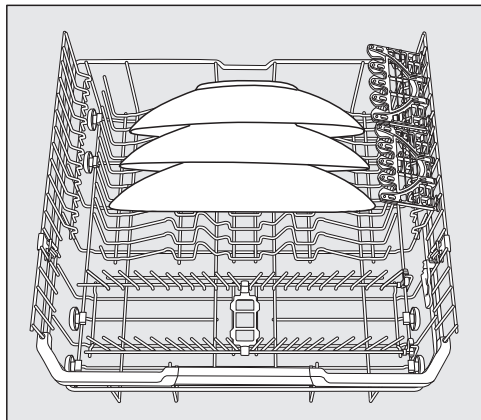

- Place large platters and dishes in the centre of the lower basket.

Useful tip: When tilted, plates up to 35 cm in diameter can be accommodated.

Lowering the spikes

The rows of spikes at the front are used for loading plates, soup bowls, platters, dessert bowls and saucers.

Both right-hand rows of spikes can be folded down to make more room for large items such as pots, pans, and serving dishes and bowls.

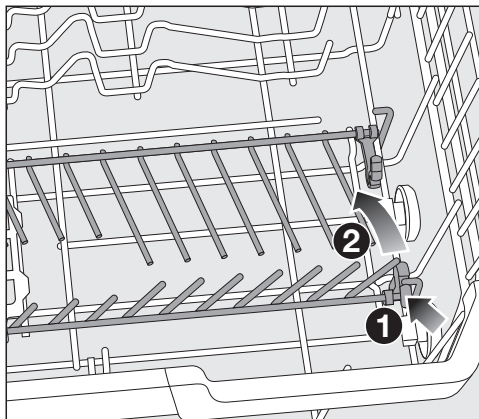

- Press the yellow lever downwards ① and then lower the spikes ②.

Loading the dishwasher

FlexCare Glass & Bottle

The glass and bottle holders are used to wash stemware, tall glasses, and bottles.

Adjusting the FlexCare Glass & Bottle

You can set the glass and bottle holders at 2 different heights.

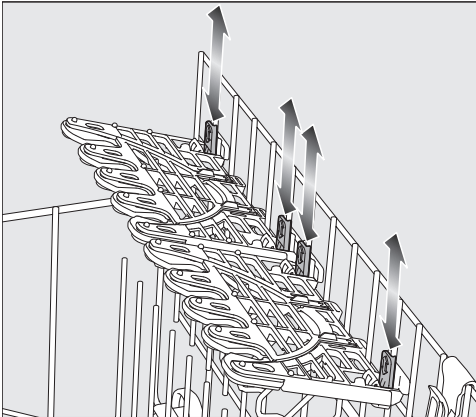

- Slide the glass and bottle holder to the desired height until the catches click into place at the top or the bottom.
- The glass and bottle holders can be raised to make more room for tall items.

Loading the glass holders

The silicone elements in the glass holders provide a stable and secure hold for delicate stemware.

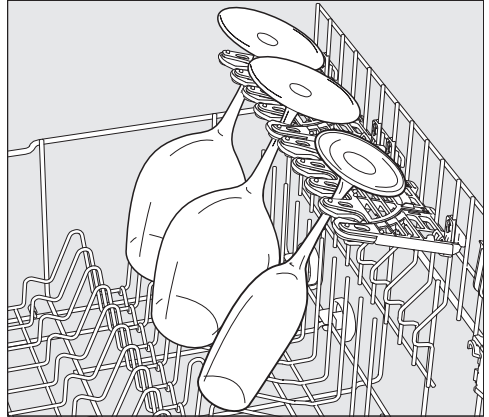

- Stemware such as wine glasses, champagne flutes and beer glasses can be pinned into the openings of the glass holders.

Loading the dishwasher

Loading the FlexCare Glass & Bottle

The glass and bottle holders can be used to keep tall, narrow and hollow containers, e.g. beer glasses, bottles, vases, secure during a programme.



- The inserts in the glass and bottle holders can be raised to make more room for tall glasses or bottles.

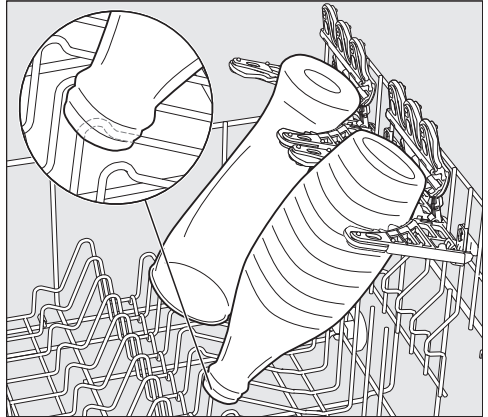

- Lean the containers into the holders.

Useful tip: For the best cleaning results, use the “BottleClean” Extra (see “Extras – BottleClean”).

Loading the dishwasher

MultiClip

The MultiClips enable you to fasten light load items such as those made from plastic.

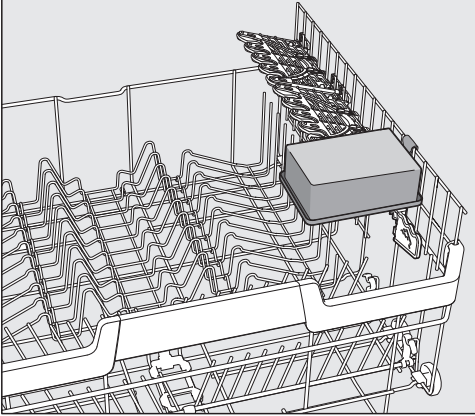

- Secure light items to the MultiClips.

Make sure that crockery does not obstruct the middle spray arm.

XL Assist

The XL Assist is used to secure large load items, e.g. pots and pans.

This allows the crockery to be tilted for better drying results. Smaller items of crockery can be positioned under the large items.

Loading the XL Assist

Unfold the XL Assist to support large items of crockery on it.

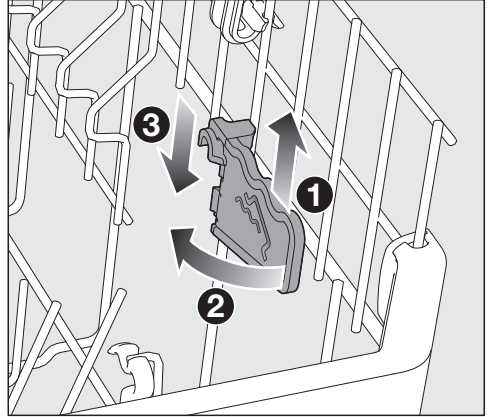

- Slightly lift the XL Assist **1**, fold it out **2** and hook it back in the new position **3**.

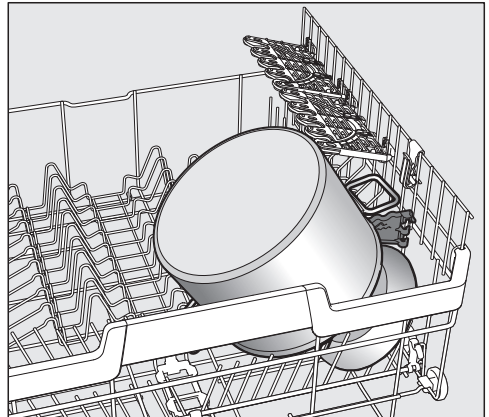

- Place the edges of large crockery on the XL Assist.

Loading the dishwasher

Cutlery tray

See “Loading the dishwasher - Loading examples” for examples of how to load crockery and cutlery.

- Load cutlery into the 3D MultiFlex tray.

Loading the 3D MultiFlex tray

To make unloading easier, cutlery should be grouped in zones: one for knives, one for forks, one for spoons, etc.

Spoon heads should be placed to rest on the serrated retainers on the base of the tray to ensure that water runs off them freely.

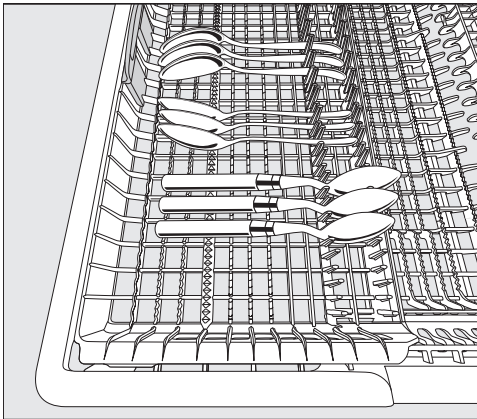

- If spoon handles do not fit between the holders, lay them the other way round.

You can push the left insert to the middle in order to accommodate tall items and long stemmed glasses in the upper basket.

You can put large and long cutlery in the recessed centre part of the tray.

Arrange tall items (such as cake servers) so that they do not block the upper spray arm.

You can adjust the height of the right-hand insert to create more space in the right-hand part of the tray for larger cutlery items or smaller pieces of crockery.

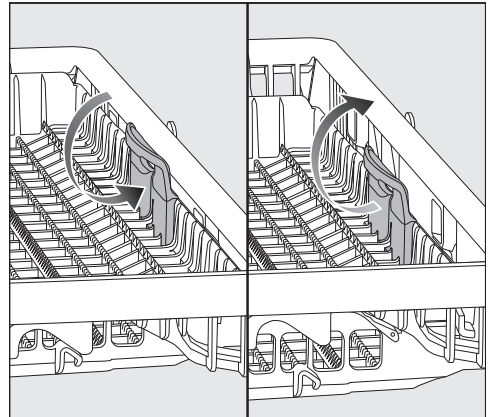

- Pull the insert inwards by the yellow handle and click it into place in one of the two positions.

Loading examples

Dishwashers with cutlery tray

Upper basket

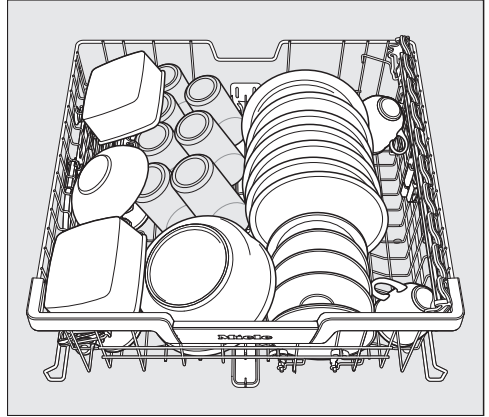
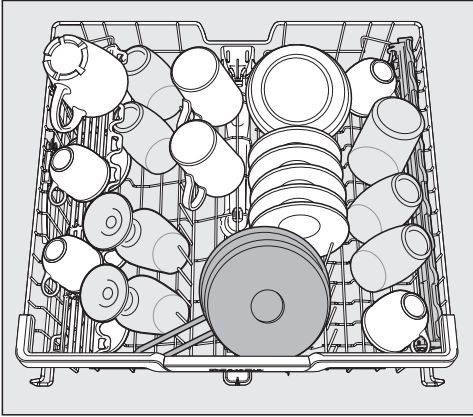

Lower basket

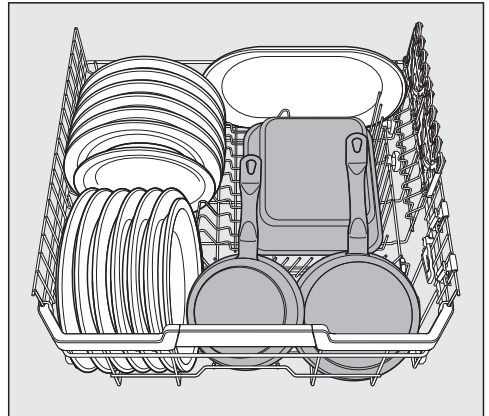
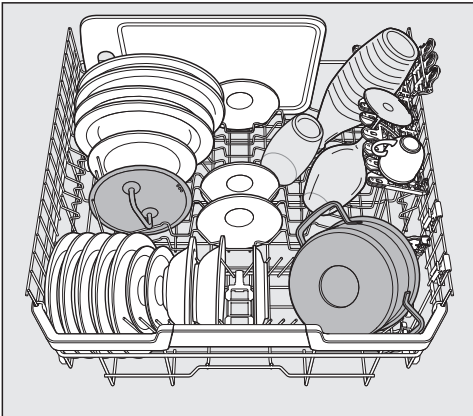

Loading the dishwasher

Cutlery tray

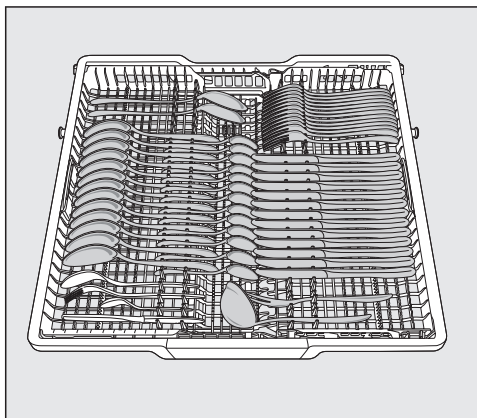
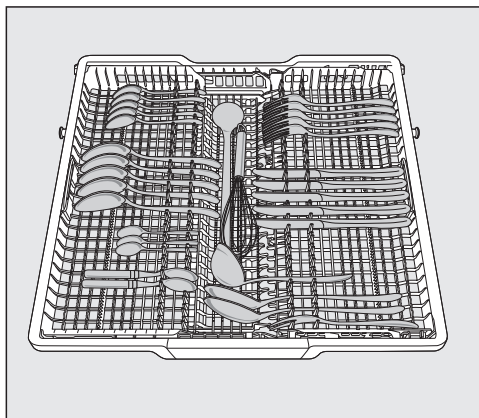

Heavily soiled items

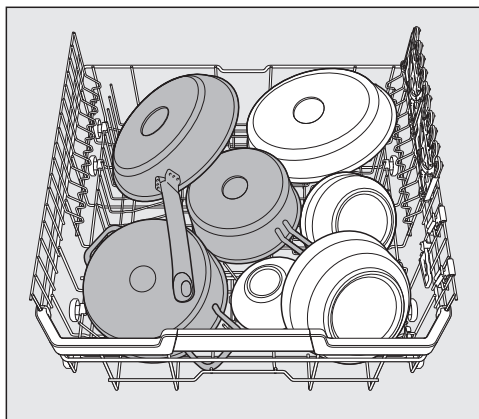

Normal height

Test standard:	AS/NZS 2007.1:2005, AS/NZS 2007.2:2005; AS/NZS 6400:2005
Standard programme (for energy label):	ECO
Capacity:	 14 place settings
Detergent amount:	27.5 g
Rinse aid dosage:	Setting 3

You can find information on adjusting the rinse aid dosage in the "Rinse aid" section of this booklet.

Water connection setting:	When testing the primary water connection mode, select Cold water. When testing the supplementary water connection mode, select Warm water.
----------------------------------	---

The door opens automatically during the drying phase.
Do not close the door until the drying test has finished.

Upper basket setting:

Position:	Bottom
FlexCare cup rack:	Left lower position, right upper position

Loading examples

Pictures illustrating how to load the dishwasher for each model (see data plate) are shown on the following pages.

Picture ①: Upper basket

Picture ②: Lower basket

Picture ③: Cutlery tray

Do not lower or remove the basket inserts.

Remove the drinking straw holder (StrawClean) from the lower basket (if available).

Comparison tests

Capacity

🗂️ 14

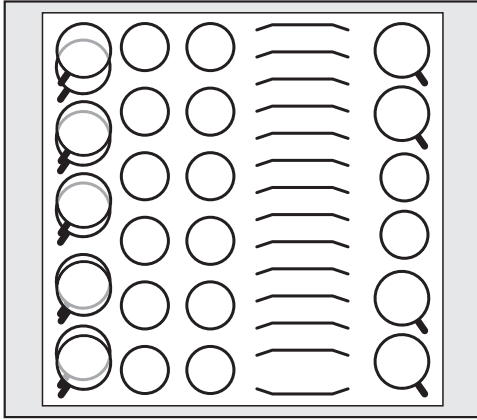

①

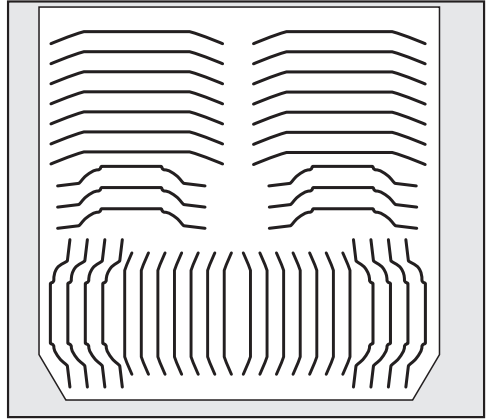

②

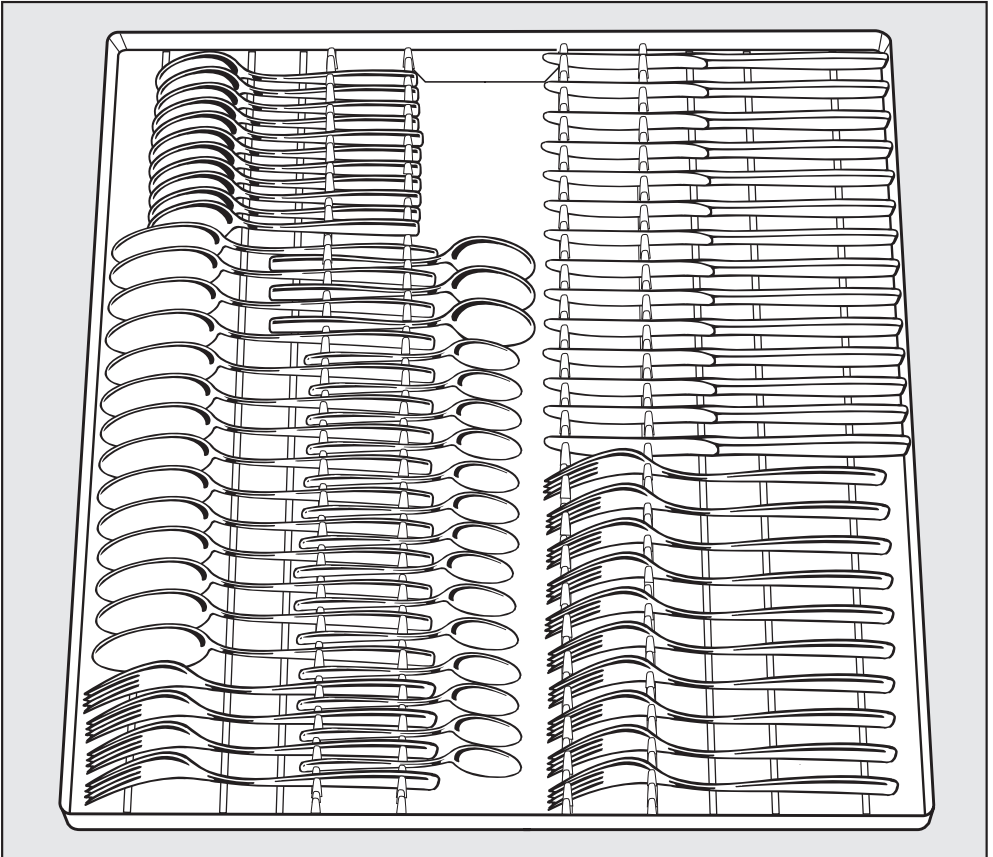

3

Comparison tests

XXL height

Test standard: AS/NZS 2007.1:2005, AS/NZS 2007.2:2005;
AS/NZS 6400:2005

Standard programme
(for energy label): ECO

Capacity: 🍽️ 15 place settings

Detergent amount: 33.7 g

Rinse aid dosage: Setting 3

You can find information on adjusting the rinse aid dosage in the "Rinse aid" section of this booklet.

Water connection setting: When testing the primary water connection mode, select Cold water. When testing the supplementary water connection mode, select Warm water.

The door opens automatically during the drying phase.
Do not close the door until the drying test has finished.

Upper basket setting:

Position: Bottom

FlexCare cup rack: Left lower position, right upper position

Loading examples

Pictures illustrating how to load the dishwasher for each model (see data plate) are shown on the following pages.

Picture ①: Upper basket

Picture ②: Lower basket

Picture ③: Cutlery tray

Do not lower or remove the basket inserts.

Remove the drinking straw holder (StrawClean) from the lower basket (if available).

Capacity

🍷 15

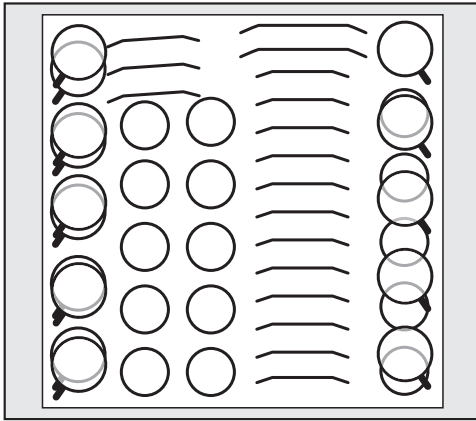

①

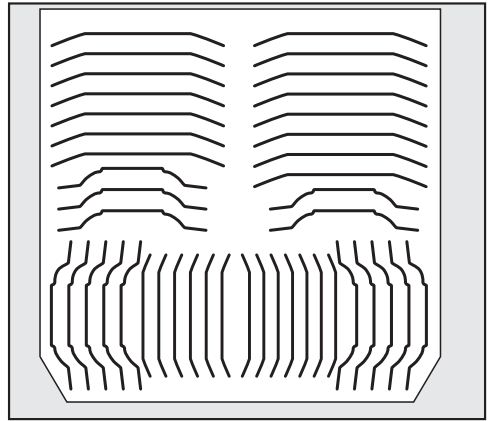

②

Comparison tests

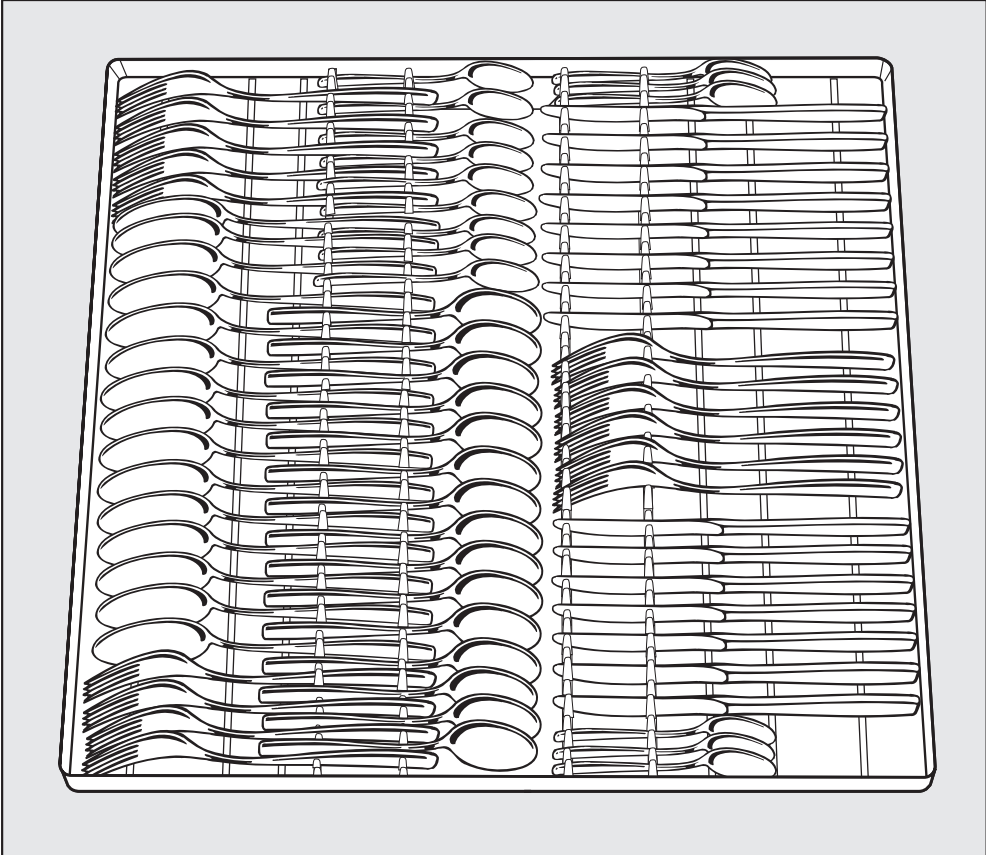

③

Types of detergents



Damage due to unsuitable detergents.

Detergents that are not suitable for domestic dishwashers can cause damage to the dishwasher or to the load.

Only use detergents formulated for domestic dishwashers.

Modern detergents contain various active ingredients, the most important of which are:

- Water softening complexing agents to prevent calcification.
- Alkalis to aid removal of dried-on soiling.
- Enzymes to break down starch and loosen protein.
- Oxygen-based bleaching agents to remove coloured stains (e.g. tea, coffee, tomato sauce).

Most dishwasher detergents are mildly alkaline and contain enzymes and oxygen-based bleaching agents.

There are different types of detergents:

- Powder and liquid gel detergents. These detergents allow you to adjust the amount dispensed according to the load size and the level of soiling.
- Detergent tabs. These are suitable for most levels of soiling.

As well as the usual detergents, combination products are also available. These contain rinse aid and water softener (dishwasher salt).

Only use these combination detergents for the water hardness levels recommended by the manufacturer on the packaging.

The cleaning and drying performance of these combination detergents can vary greatly.

Please make sure that if you stop using combination detergents, you refill the dishwasher salt and rinse aid. Switch the refill reminders back on if required.

For optimum cleaning and drying results, use dishwasher detergent and add salt and rinse aid separately.

Detergents

 Risk of chemical burns from detergent.

Dishwasher detergents can cause burning on the skin and in the eyes, nose, mouth, and throat.

Avoid contact with detergents.

Do not inhale powder detergent. Do not swallow dishwasher detergent.

Seek medical attention immediately if detergent has been swallowed or inhaled.

Keep detergents out of reach of children. Detergent residues could still be present in the dishwasher.

Keep children away from the dishwasher when the door is open.

Do not fill the detergent dispenser until just before starting the programme and activate the door safety lock.

Detergent dispensing

There are two ways of dispensing the detergent.

During automatic dispensing, the AutoDos function will automatically dispense the required amount of detergent for each programme once a PowerDisk has been inserted (see “Detergents - Automatic dispensing/ AutoDos”).

If you do not wish to use AutoDos, you can manually dispense the detergent into the detergent compartment. This means you will have to fill the required amount of detergent into the detergent compartment before each programme (see “Detergents - Manual detergent dispensing”).

Automatic dispensing/AutoDos

Before you can use AutoDos, you must insert a PowerDisk containing powder detergent into the PowerDisk compartment.

One PowerDisk contains enough detergent for approx. 20 cycles, depending on the selected programme.

PowerDisks are available to purchase from the Miele online store, Miele Customer Service or a Miele Experience Centre.

 Risk of chemical burns from residual detergent.

Detergents have a caustic effect. This can cause health problems and damage to surfaces. If the AutoDos is used incorrectly, residual detergent may drip onto the floor area in front of the dishwasher.

Always remove residual detergent from in front of the dishwasher immediately.

Activating AutoDos

- Switch the dishwasher on using the  sensor.
- Before you first use AutoDos, remove the tab from the AutoDos lid and dispose of the tab appropriately.
- Insert a PowerDisk (see “Automatic dispensing/AutoDos - Inserting a PowerDisk”).

The  *AutoDos* function will be activated automatically.

The message *AutoDos activated* will appear in the display.

This setting applies to all programmes and you can change it at any time using the  *AutoDos* sensor.

If no programme is started for 48 hours, the PowerDisk will automatically be rotated so that the detergent does not clump together. If this happens, the message *Powder refreshing* will appear in the display when the dishwasher is switched on. No detergent is dispensed during this refreshing process.

Detergents

Inserting a PowerDisk

Only replace the PowerDisk when the message PowerDisk empty. Deactivate AutoDos with OK. appears.

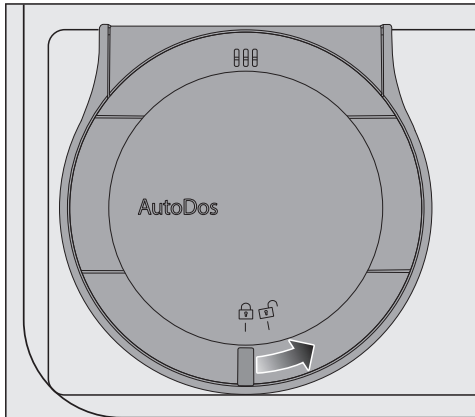

- Slide the yellow catch of the AutoDos lid to  and open it.

The message AutoDos lid open will appear in the display.

- Remove the empty PowerDisk.

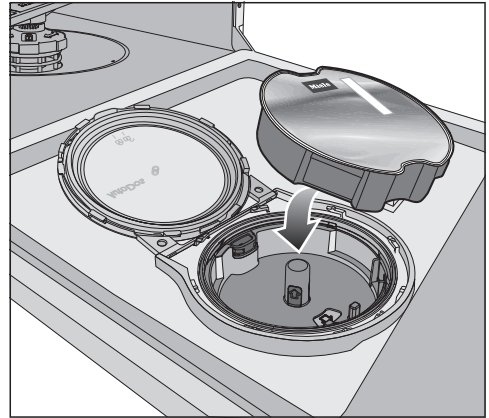

- Insert the new PowerDisk and press it evenly downwards until it sits flush.

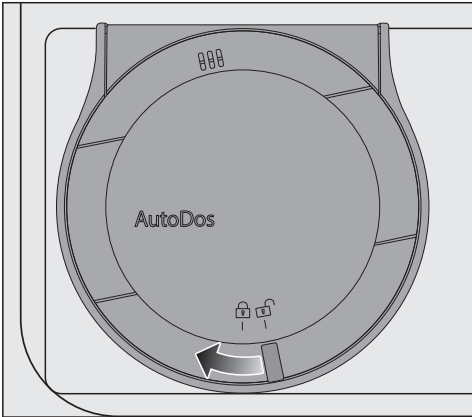

- Close the AutoDos lid and slide the yellow catch until it is aligned with the  symbol.

This activates the *AutoDos* function.

If the PowerDisk is not in the correct starting position, it will be rotated automatically.

Wait until this process is finished before you start a programme.

The AutoDos lid must be closed to prevent damage to the AutoDos. Always close the AutoDos lid before you close the dishwasher door. Otherwise, the AutoDos may be damaged.

Programmes cannot start when the AutoDos lid is open.

The detergent powder must be dry so that it does not clump together. Do not fill the AutoDos with any type of liquid.

It is not permitted to refill the PowerDisk with powder detergent. This will invalidate the warranty.

In order to ensure that the AutoDos works at its best, check it each time you replace the PowerDisk and clean it if needed (see "Cleaning and care - Cleaning the AutoDos").

Detergents

Manual detergent dispensing

Detergent must be manually dispensed if you have deactivated automatic dispensing using the  *AutoDos* sensor.

Detergent dispensing

The detergent compartment holds a maximum of 50 ml.

There are marks in the detergent compartment to aid with dispensing: 20, 30, max. When the door is opened to a horizontal position, they show the approximate fill level in ml and the maximum fill height.

- Follow the detergent dosage recommended by the manufacturer on the packaging.
- Unless directed otherwise, use one detergent tab or add 20 to 30 ml of detergent to the detergent compartment, depending on the degree of soiling of the crockery.

If you use less than the recommended amount of detergent, the dishes may not get properly clean.

Some tabs may not dissolve completely when the programme *QuickPowerWash* (*PowerWash* programme + *Quick Extra*) is used.

Adding detergent

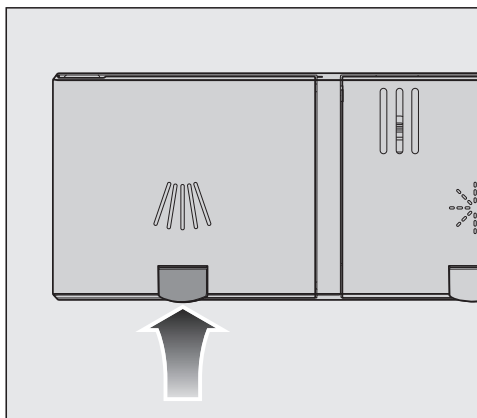

- Lift the yellow catch on the lid of the detergent compartment .

The lid will open.

The lid will also be open at the end of the programme.

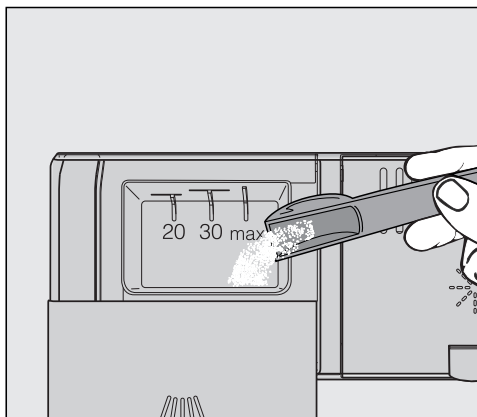

- Add the detergent to the detergent compartment.
- Push the lid shut until you hear it click into place.

The detergent must not cause the detergent compartment lid to get stuck. This can prevent the lid from opening during the programme sequence.

Do not overfill the detergent compartment.

- Automatic dispensing/AutoDos should be deactivated if detergent is manually dispensed.
- Ensure that the detergent packaging is properly closed after use. This prevents the detergent from getting damp and clumping together.

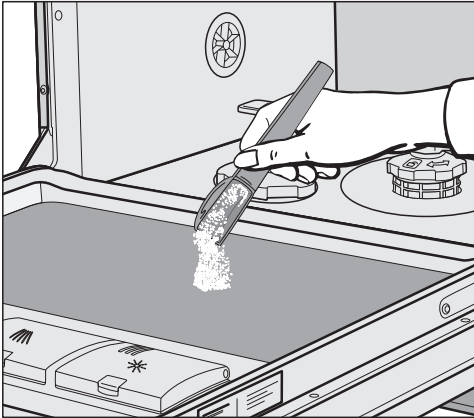

- You can also apply a small amount of detergent to the inner panel of the door in programmes that have a pre-wash stage (see “Programme chart”).

Operation

Switching on the dishwasher

- Turn on the tap if it is turned off.
- Make sure the spray arms can rotate freely.
- Close the door.
- Touch the  sensor.

If the dishwasher has been switched off for longer than 1 minute, you will need to touch the  sensor for slightly longer (wipe protection).

The most recently started programme will appear in the display and the corresponding sensor will be illuminated. If necessary, change the programme.

Next, the estimated energy and water consumption may be shown for the selected programme for several seconds.

Then the display will show the estimated duration for the selected programme.

The *Start* sensor flashes.

Selecting a programme

Choose your programme according to the type of crockery and the degree of soiling.

The different programmes and their uses are described in the **Programme chart** later on in this booklet.

- Touch the sensor for the required programme.

The sensor for the selected programme will light up.

Further programmes can be selected under .

- To do so, touch the  sensor.

The first of the further programmes will appear in the display.

- Use the \vee/\wedge sensors in the display to select the programme you want.







You can now select the Extras (see “Extras”).

If any Extras are selected, the appropriate sensors will also light up.

Display of programme duration

The estimated duration of the selected programme appears in the display before the programme begins. During the programme, the time left until the end of the programme is displayed.

Each programme stage is indicated by a symbol:

-  Pre-wash/Soak
-  Main wash
-  Interim rinse
-  Final rinse
-  Drying
-  Finish

The displayed duration may vary for the same programme. It is influenced by, for example, the temperature of the incoming water, the reactivation cycle of the water softener, the detergent type, and the amount of dishes and how soiled they are.

When a programme is selected for the first time, the display will show the average programme duration for a cold water connection.

The programme durations shown in the “Programme chart” refer to standard test loads and temperatures.

Each time a programme is run, the control module calculates the programme duration depending on the temperature of the water taken into the dishwasher and the size of the load.

Starting a programme

- If necessary, confirm the previously displayed message with *OK*.
- Touch the *Start* sensor.

The programme will start.

The *Start* sensor lights up.

During the programme sequence, you can use *OK* to display the name of the programme that is currently running.

 Risk of scalding due to hot water. During operation, water in the dishwasher may be very hot. Only open the door if absolutely necessary and exercise extreme caution when doing so. Before closing the door again, leave it ajar for approx. 20 seconds. This will enable the temperature in the wash cabinet to settle.

Operation

At the end of the programme

The signal tones may sound at the end of the programme.

The programme has finished when the display shows the message  Finished.

In some programmes, if the AutoOpen function is activated, the door will automatically open slightly (see “Settings – AutoOpen”). This improves the drying process.

If the Consumption programmable function is switched on, you can now call up the actual energy and water consumption of the programme that has just finished (see “Caring for the environment – EcoFeedback consumption display”).

The drying fan may continue to run for a few minutes at the end of the programme.

If you are not satisfied with the cleaning or drying results, you can activate the “Extra clean” or “Extra dry” functions to boost the performance of the programmes (see “Extra clean” or “Extra dry” under “Extras”).

 Risk of damage due to steam.

Steam from the dishwasher could damage delicate housing units and the edges of worktops when you open the door at the end of the programme if the fan is no longer running.

If you have deactivated the automatic door opening function (see “Settings – AutoOpen”), but would still like to open the door at the end of the programme, then make sure that you open the door fully.

Energy management

To save energy, the dishwasher will switch off automatically 10 minutes after the last time a sensor is pressed or after the end of a programme.

You can switch the dishwasher back on again with the  sensor.

If the dishwasher has been switched off for longer than 1 minute, you will need to touch the  sensor for slightly longer (wipe protection).

The dishwasher will not switch itself off while a programme is running or if there is a fault.

Switching off the dishwasher

- The dishwasher can be switched off at any time using the  sensor.

Switching the dishwasher off during a programme cancels the programme.

- Use the  sensor to select the Switch appliance off option.
- Confirm the query Switch appliance off with *OK*.

You can also do this to stop an ongoing timer.



Risk of damage from leaking water.

Overflowing water can cause damage.

If the dishwasher is not going to be used for a longer period of time, e.g. whilst on holiday, the tap should be turned off.

Unloading the dishwasher

Dishes tend to break and chip more easily when they are hot. Allow the dishes to cool until they are comfortable enough to handle before unloading them.

The dishes will cool much faster if you open the door when the programme has ended.

- First unload the lower basket, then the upper basket, and finally the 3D MultiFlex tray.

This will prevent water drops from the upper basket and 3D MultiFlex tray from falling onto the dishes in the lower basket.

Operation

Interrupting a programme

A programme will be interrupted as soon as the door is opened. If the door is closed again, the programme will continue from the point it was at before the door was opened.

 Risk of scalding due to hot water.



During operation, water in the dishwasher may be very hot. Only open the door if absolutely necessary and exercise extreme caution when doing so. Before closing the door again, leave it ajar for approx. 20 seconds. This will enable the temperature in the wash cabinet to settle.

Cancelling or changing a programme

If a programme is cancelled, important programme stages may be missed.

A programme should only be cancelled in the first few minutes of the programme sequence.

If a programme has already started and you wish to cancel it, proceed as follows:

- Switch the dishwasher off with the  sensor.
- Use the  sensor to select the Switch appliance off option.
- Confirm the query Switch appliance off with *OK*.

If you would like to select another programme:

- Switch the dishwasher back on using the  sensor.
- If you have dispensed detergent manually, check whether the detergent compartment is still closed. If the lid is already open, fill it with detergent again and close the lid.
- Select the programme you want and start it.

Timer

The timer  gives you several options for starting a programme at a later time. You can set the start time or the finish time of a programme. You also have the option of taking advantage of time variable electricity rates using the EcoStart or SmartStart functions.

With manual detergent dispensing, the detergent can clump together if the detergent compartment is not dry, and it may not be fully rinsed out. When using the timer function, make sure that the detergent compartment is dry before adding detergent. Wipe it dry with a cloth first if necessary. Do not use liquid detergents. These can leak out.

 **Danger to health due to detergent.**

To prevent children coming into contact with dishwasher detergent: Do not fill the detergent dispenser **until just before starting the programme**, i.e. before you activate the timer. Use the safety lock to secure the dishwasher door (see “Before using for the first time – Safety lock”).

Activating the timer

- Switch the dishwasher on using the  sensor.

The *Start* sensor flashes.

- Select the required programme.
- Touch the  sensor.

The  sensor lights up.

You can use the ∇/\wedge sensors to choose between the *Start at*, *Finish at* and *EcoStart* functions, or *SmartStart* if applicable.

- Confirm the selected function with *OK*.

The last time set for the timer will be displayed and the hour number block will be highlighted.

- Enter the required time for the timer using the ∇/\wedge sensors and confirm with *OK*.

If, while you are setting the time, you do not apply any settings for several seconds, the display will revert to the previous menu. You will then have to enter your settings again.

After you have activated the timer, the display and the indicator lights will switch off after a few minutes to save energy.

To switch the display back on for a few minutes, press the  sensor.

You can also activate a timer via the Miele app.

Options

Setting “Start at”

With the *Start at* function, you set the exact time at which you want the programme to start.

- Use the \vee/\wedge sensors to enter the hour and confirm your entry with *OK*.

The hour will be saved and the minute number block will be highlighted.

- Use the \vee/\wedge sensors to enter the minutes and confirm your entry with *OK*.

The saved start time for the selected programme will appear in the display for several minutes.

When the set time is reached, the selected programme will start automatically.

The time remaining will be shown in the display, the \oplus sensor will go out and the *Start* sensor will light up.

Setting “Finish at”

Use the *Finish at* function to set the latest time by which the selected programme has to be finished.

- Use the \vee/\wedge sensors to enter the hour and confirm your entry with *OK*.

The hour will be saved and the minute number block will be highlighted.

- Use the \vee/\wedge sensors to enter the minutes and confirm your entry with *OK*.

The estimated start time for the selected programme will appear in the display for several minutes.

A message will appear in the display if the programme cannot be completed by the set finish time because it has too long a running time.

- In this case confirm the message with *OK*.

The programme will start automatically when the estimated start time is reached.

The time remaining will be shown in the display, the \oplus sensor will go out and the *Start* sensor will light up.

Setting EcoStart

The EcoStart function enables you to benefit from time variable economy electricity rates. Before you can use this option, you need to set up to three electricity rate tariff times (see “Settings - EcoStart”).

Then set the time by which the selected programme should be finished.

The dishwasher will then start automatically in the most economical electricity rate zone within the time set.

- Use the \vee/\wedge sensors to enter the hour and confirm your entry with *OK*.

The hour will be saved and the minute number block will be highlighted.

- Use the \vee/\wedge sensors to enter the minutes and confirm your entry with *OK*.

The estimated start time for the selected programme will appear in the display for several minutes.

The programme will start automatically when the estimated start time is reached.

The time remaining will be shown in the display, the \oplus sensor will go out and the *Start* sensor will light up.

Setting SmartStart

The SmartStart function (only functional in selected countries) is used for starting your dishwasher automatically at a time when energy costs are most economical.

To use this function you may need further technical accessories.

If you have activated the SmartStart function in the Settings \blacksquare menu, the *Timer* \oplus menu will no longer show the EcoStart function but will instead show SmartStart (see “Settings – SmartStart”).

If your energy provider offers this service, they will send a signal to your dishwasher when energy costs are at their most economical.

This signal will start the dishwasher.

You can set the time by which the selected programme has to be finished. The dishwasher will then calculate the latest possible start time for the selected programme and will wait until this start time for the signal from the energy provider.

Options

Set the time by which the selected programme needs to be finished.

- Use the \vee/\wedge sensors to enter the hour and confirm your entry with *OK*.

The hour will be saved and the minute number block will be highlighted.

- Use the \vee/\wedge sensors to enter the minutes and confirm your entry with *OK*.

The message *Waiting for SmartStart* will appear in the display.

The *Start* sensor lights up for a few minutes.

The selected programme will start automatically as soon as the energy provider has sent the signal or when the latest possible calculated start time has been reached.

The time remaining will be shown in the display, the \oplus sensor will go out and the *Start* sensor will light up.

Changing or deleting the timer

You can change the time set for the timer or delete it.

- Touch the \oplus sensor.

The previously activated timer function is displayed.

- Confirm with *OK*.

- Use the \vee/\wedge sensors to select the *Change* or *Delete* function and confirm with *OK*.

After confirming the *Change* function with *OK*, you can change the time set for the timer.

After confirming the *Delete* function with *OK*, the duration of the selected programme will appear in the display. The \oplus sensor goes out and the *Start* sensor flashes.

You can now start a programme or switch the dishwasher off.

Switching the dishwasher off while a timer is running stops the timer.

You can also change or delete the time set for the timer using the Miele App.

Activating MobileStart

You can start your dishwasher remotely using the Miele App. To do this, you first need to install the App on your mobile device, connect the dishwasher to your Wi-Fi network (see “Settings – Miele@home”) and, if applicable, activate the “Remote control” setting (see “Settings – Remote control”).

- Switch the dishwasher on using the  sensor.

- Touch the  sensor.

The  sensor lights up.

- Switch the dishwasher off with the  sensor.

The dishwasher can now be operated remotely using the Miele App.

The MobileStart option will remain activated until you deactivate it again using the  sensor. The option will also remain active if you switch the dishwasher off and back on again in the meantime.

Even if the MobileStart option is not active, you can display the status of your dishwasher and apply settings using the Miele App.

If you start a programme using the *Start* sensor on the dishwasher, the MobileStart option will automatically be activated for the duration of the programme and the  sensor will light up.

Displaying the operating hours

You can display how many hours the dishwasher has been in operation so far.

- Switch the dishwasher on using the  sensor.

- If necessary, confirm the messages and refill reminders with *OK*.

- Touch the  sensor for 5 seconds.

The operating hours are displayed.





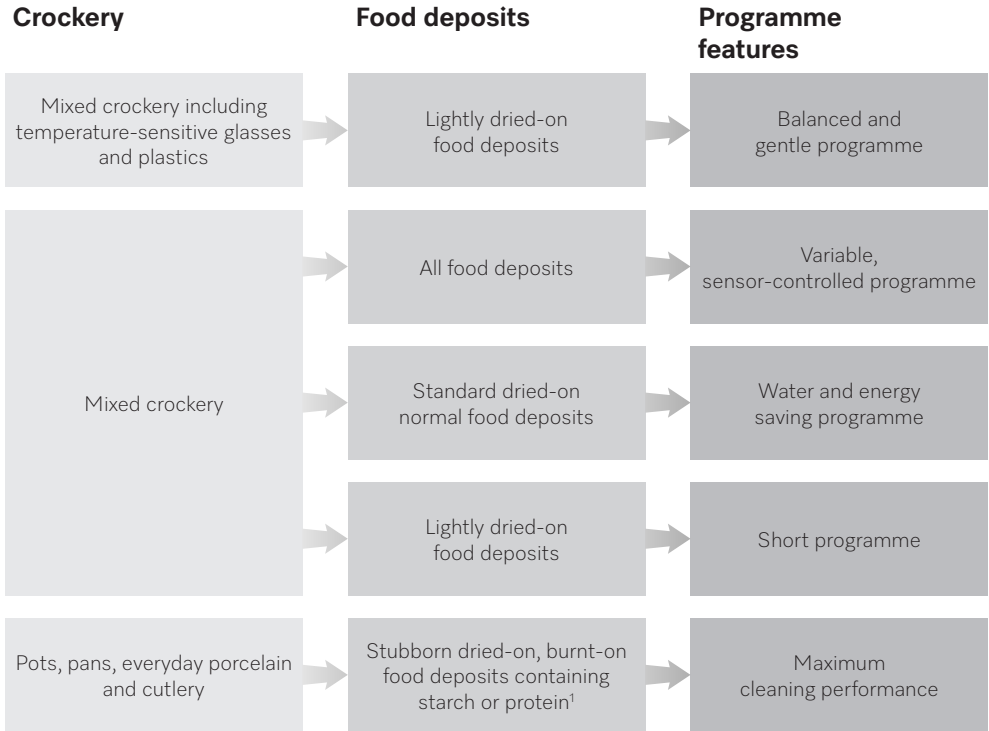

















































- Use the  or *OK* sensors to return to the programme menu.

Guide for selecting a programme



¹ Food such as potatoes, pasta, rice or stews can leave starchy deposits. Deposits containing protein can be left by food such as fried meat or fish.

Guide for selecting a programme

Programme ²	 ³	Consumption estimate ⁴						
 ComfortWash 45 °C 	30 ml	<table border="1"> <tr> <td>Energy consumption</td> <td></td> </tr> <tr> <td>Water consumption</td> <td></td> </tr> <tr> <td>Programme duration</td> <td></td> </tr> </table>	Energy consumption		Water consumption		Programme duration	
Energy consumption								
Water consumption								
Programme duration								
 Auto 	30 ml	<table border="1"> <tr> <td>Energy consumption</td> <td></td> </tr> <tr> <td>Water consumption</td> <td></td> </tr> <tr> <td>Programme duration</td> <td></td> </tr> </table>	Energy consumption		Water consumption		Programme duration	
Energy consumption								
Water consumption								
Programme duration								
 ECO	30 ml	<table border="1"> <tr> <td>Energy consumption</td> <td></td> </tr> <tr> <td>Water consumption</td> <td></td> </tr> <tr> <td>Programme duration</td> <td></td> </tr> </table>	Energy consumption		Water consumption		Programme duration	
Energy consumption								
Water consumption								
Programme duration								
 PowerWash 60 °C 	30 ml	<table border="1"> <tr> <td>Energy consumption</td> <td></td> </tr> <tr> <td>Water consumption</td> <td></td> </tr> <tr> <td>Programme duration</td> <td></td> </tr> </table>	Energy consumption		Water consumption		Programme duration	
Energy consumption								
Water consumption								
Programme duration								
 Intensive 75 °C 	35 ml	<table border="1"> <tr> <td>Energy consumption</td> <td></td> </tr> <tr> <td>Water consumption</td> <td></td> </tr> <tr> <td>Programme duration</td> <td></td> </tr> </table>	Energy consumption		Water consumption		Programme duration	
Energy consumption								
Water consumption								
Programme duration								

² You can use “Extras” to adjust the programmes (see “Extras”).
 You can also select the “2nd interim rinse” function (see “Settings”).

³ Recommended amount of detergent (see “Detergent”).

⁴ The estimated values may change due to the selected settings or Extras,
 or the conditions in which the appliance is being used.

Programme chart

Programme	Programme sequence				
	Pre-wash	Main wash °C	Interim rinse	Final rinse °C	Drying/ AutoOpen
ECO ¹	✓	47	-	✓	✓ / ✓
Auto 45–60 °C	Variable programme sequence, sensor-controlled adjustment to load size and level of soiling				
	As required	45–60	✓	55–70	✓ / ✓
ComfortWash 45 °C	✓	45	✓	55–70	✓ / ✓
PowerWash 60 °C	-	60	✓	60	✓ / ✓
Intensive 75 °C	✓	75	✓	55–70	✓ / ✓
ComfortWash+ 55 °C	✓	55	✓	55–70	✓ / ✓
Hygiene 75 °C	-	75	✓	75	✓ / ✓
ExtraQuiet 50 °C	-	50	✓	55–70	✓ / ✓
SolarSave	✓✓	✓	✓	✓	✓ / ✓
Gentle 45 °C	-	45	✓✓	56	✓ / ✓
Maintenance programme	-	75	✓✓	70	✓ / ✓
Rinse out salt	✓	-	-	-	- / -

¹ This programme is the most efficient in terms of its combined energy and water consumption for cleaning dishes with a normal level of soiling.

Programme chart

Consumption ²				
Electrical energy		Water	Duration	
Cold water	Hot water	Litres	Cold water	Hot water
kWh	kWh		h:min	h:min
0.51/0.54 ^{3,4}	0.34/0.36 ^{3,4}	9.3/9.6 ^{3,4}	3:48/3:45 ^{3,4}	3:47/3:42 ^{3,4}
0.70–1.00 ^{5,6}	0.55–0.65 ^{5,6}	6.0–13.0 ^{5,6}	2:02–2:59	1:59–2:49
0.85	0.45	12.5	2:37	2:28
1.00	0.65	9.5	1:24	1:15
1.25	0.85	13.5	3:07	2:44
0.95	0.50	12.5	2:30	2:19
1.60	1.20	10.0	2:27	2:15
1.00	0.75	9.0	3:59	3:54
-	0.07	27.0	-	2:47
0.85	0.50	11.5	1:55	1:38
1.80	1.15	19.0	2:10	1:50
0.01	0.01	8.5	0:13	0:13

² The values for the *ECO* programme were calculated under standardised testing conditions. Values for the remaining programmes were calculated under comparable testing conditions.

In practice, the selected settings, Extras or operating conditions may result in different values (see “Operation – Displaying the programme running time”).

³ Standard height dishwashers

⁴ XXL dishwashers

⁵ Minimum value: half load with light soiling

⁶ Maximum value: full load with heavy soiling

Programme chart

Further programmes

ComfortWash+ 55 °C

Programme for cleaning a mixed load with fresh food deposits which have begun to dry on.

Hygiene 75 °C

Special programme for robust items with lightly dried on food deposits, which need to be hygienically clean, e.g. baby bottles and cutting boards.

ExtraQuiet 50 °C

Very quiet programme with longer duration. This programme is suitable for a mixed load with lightly dried on food deposits.

SolarSave

Programme operating without heating when the dishwasher is connected to a hot water supply of at least 45 °C (see “Installation – Water inlet”). This programme is only sustainable when the water is heated using solar thermal energy. This programme is suitable for cleaning a mixed load with lightly dried on food deposits.

Gentle 45 °C

Programme for particularly gentle cleaning of temperature-sensitive crockery, glasses and plastics with household food residues that have slightly dried on.

Maintenance programme

The dishwasher wash cabinet is generally self-cleaning. However, if residues or deposits occur, use the Maintenance prog. programme to clean it. The dishwasher must not be loaded for this programme. This programme is designed for cleaning the wash cabinet using care products (dishwasher cleaner/dishwasher conditioner) (see “Optional accessories - Appliance care”). Follow the instructions on the packaging. When using dishwasher care products, no detergent should be added. For this reason, automatic dispensing (if available) is deactivated for this programme.

Rinse out salt

Programme for rinsing the wash cabinet after filling the salt reservoir. Each time you remove the salt reservoir cap, immediately start the *Rinse out salt* programme without load items and without detergent dispensing. This will dissolve and remove any traces of salt from the wash cabinet.

QuickPowerWash

Short programme under one hour for mixed crockery with household food residues that have dried on slightly. The programme can be selected via the *PowerWash* programme in conjunction with the *Quick Extra* (see “Extras – Quick”).

Selecting Extras

You can use Extras to adjust the programmes.

To do this, you can select or deselect the Extras before starting the selected programme.

- Touch the $\nabla \equiv$ *Extras* sensor.
- Select the Extra you want and confirm with *OK*.

Extras that cannot be combined with the selected programme or Extra are indicated by a  lock symbol.

If necessary, a corresponding message appears in the display.

- In this event, confirm the message with *OK*.
- Press the *Start* sensor to start the programme.

You can set whether the selected Extras are to remain permanently activated for the respective programme (see “Settings – Save Extras”).

BottleClean

You can select the *BottleClean* Extra to increase the cleaning performance of the programmes for tall, narrow hollow containers, e.g. beer glasses, drinking bottles. Load items that have been placed in the glass and bottle holders in the lower basket are cleaned particularly thoroughly (see “Loading the dishwasher – FlexCare Glass & Bottle”).

When this Extra is activated, the programme running time is extended and the cleaning temperature may increase. This will increase the water consumption and energy consumption.

IntenseZone

You can select the *IntenseZone* Extra to increase the cleaning performance of the programmes in the lower basket.

When this Extra is activated, the programme running time is extended and the cleaning temperature increases. This will increase the water consumption and energy consumption.

Extra clean

You can select this Extra to increase the cleaning performance of the programmes.

When this Extra is activated, the programme running time is extended and the cleaning temperature increases. This will increase the water consumption and energy consumption.

Extra dry

You can select this Extra to increase the programme's drying performance.

When this Extra is activated, the programme running time is extended and the final rinse temperature increases. This will increase energy consumption.

Extras

Selecting Quick

You can reduce the programme running time using the *Quick* Extra.

The time by which the programme duration is shortened varies according to the selected programme.

In order to achieve optimum wash results, the temperature, and therefore the energy consumption, will slightly increase with this option.

The *Quick* Extra may take precedence over other selected Extras.

You can select or deselect the Extra before running the programme.

- Touch the  *Quick* sensor.

The sensor will light up if the Extra is available for the programme selected.

If the Extra is not compatible with the selected programme, a message to this effect will appear in the display.

- In this event, confirm the message with *OK*.
- Press the *Start* sensor to start the programme.

You can set whether the selected Extra is to remain permanently activated for the respective programme (see “Settings – Save Extras”).

Combining the *PowerWash* programme with the *Quick* Extra results in the *QuickPowerWash* programme, a short programme for lightly dried-on food residues.

Check the condition of your dishwasher regularly (approx. every 4–6 months). This way, faults and problems can be avoided.

 Damage caused by unsuitable cleaning agents.

All surfaces of this appliance are susceptible to scratching. Contact with unsuitable cleaning agents can alter or discolour all surfaces.

Only use cleaning agents formulated for use on the relevant surfaces.

Cleaning the wash cabinet

The wash cabinet is largely self-cleaning, provided that the correct amount of detergent is always used.

The frequent use of low-temperature wash programmes (< 50 °C) increases the risk of contamination and odours inside the wash cabinet. Run the *Intensive 75 °C* programme once a month to clean the wash cabinet and prevent odours from developing.

However, if residues such as limescale or grease have been deposited, use the Maintenance prog. programme to clean the dishwasher (see “Programme chart –  Further programmes”) with dishwasher cleaner (see “Optional accessories – Maintenance”). Follow the instructions on the product packaging.

Miele cleaning and care products are available to order from Miele Service or from Miele’s online store.

- Clean the filters in the wash cabinet regularly.

Cleaning and care

Hygiene cycle

If you mainly use low temperature programmes, there is a risk of bacteria and unpleasant odours building up in the wash cabinet. If you repeatedly use low temperature programmes, you should regularly run a high temperature programme. This is to prevent the build-up of residues and odours.

You can activate or deactivate a Hygiene info message (see “Settings – Hygiene cycle”).

If you deactivate this message, run the *Intensive 75 °C* programme once per month to clean the wash cabinet and prevent odours from developing.

Cleaning the door and the door seal

The door seal and the sides of the dishwasher door are not accessed and cleaned by the spray arm jets. As a result, mould can develop here.

- Wipe the door seals regularly with a damp cloth to remove food deposits.
- Wipe off any food or drink residues which may have dripped onto the sides of the dishwasher door before closing it.

Cleaning the control panel

- The control field should **only** be wiped with a clean, damp cloth.

Cleaning the appliance front



Damage due to soiling.

Soiling that is left too long might become impossible to remove and could cause the external surfaces to alter or discolour.

Remove any soiling immediately.

- Clean the front with a soft sponge and a solution of warm water and a little washing-up liquid. After cleaning, wipe the front dry using a soft cloth. A clean, damp microfibre cloth (such as the Original Miele all purpose microfibre cloth) without detergent can also be used.

To avoid damaging the external surfaces of the appliance, do not use:

- cleaning agents containing soda, ammonia, acid or chloride
- cleaning agents containing descaling agents
- abrasive cleaning agents, e.g. powder cleaners and cream cleaners
- solvent-based cleaning agents
- stainless steel cleaning agents
- dishwasher cleaners
- oven cleaners or sprays
- glass cleaning agents
- hard, abrasive brushes, cloths, or sponges, e.g. pot scourers, brushes, or sponges which have been previously used with abrasive cleaning agents
- dirt eraser sponges
- sharp metal scrapers
- steel wool or metal scourers
- steam cleaners

Cleaning and care

Cleaning the AutoDos

If the Clean AutoDos message is displayed, check that the AutoDos is clean, and clean it if necessary, e.g. powder residues. This helps keep the AutoDos working properly.

In order to ensure that the AutoDos function works at its best, check it each time you replace the PowerDisk and clean it if needed.

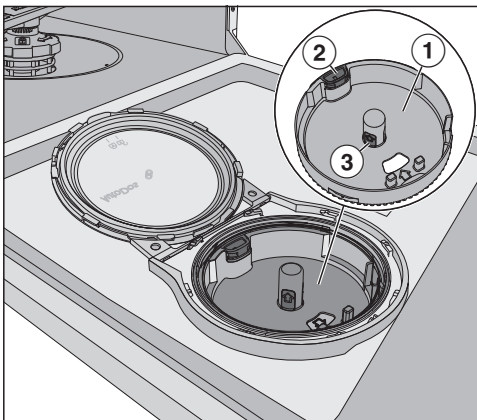

- ① PowerDisk holder
- ② Yellow opening tag for unlocking the PowerDisk holder
- ③ Yellow tabs on the PowerDisk holder

- Slide the yellow catch of the AutoDos lid to  and open it.
- Remove the PowerDisk if applicable.

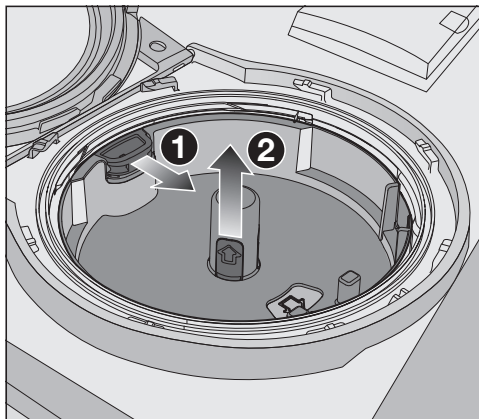

- Unlock the PowerDisk holder by pulling the yellow opening tag in the direction of the arrow ① and simultaneously pull the PowerDisk holder upwards ② using the yellow tabs.
- Clean the AutoDos housing and the PowerDisk holder with a damp cloth.
- Dry all parts well so that the detergent powder does not clump together.

It is very important that no moisture stays inside the AutoDos system during cleaning.

Cleaning and care



- Pull the yellow pull tab in the direction of the arrow ❶ and reinsert the PowerDisk holder ❷ at the same time. To do this, the arrows in the PowerDisk holder and in the viewing window must point towards each other. The holder must lie flat.

The AutoDos lid must close tightly so that the detergent powder does not get wet and clump together. Make sure that all seals are clean and clean them if necessary.

- Insert a filled PowerDisk and press it evenly downwards until it sits flush.
- Close the AutoDos lid and slide the yellow catch until it is aligned with the  symbol (see “Detergents - Inserting a PowerDisk”).

Regularly check the lower spray arm for any blockages to ensure that the detergent outlet of the AutoDos can be fully flushed out (see “Cleaning and care - Cleaning the spray arms”).

Cleaning and care

Cleaning the spray arms

Particles of food can get stuck in the spray arm jets and bearings. The spray arms should therefore be inspected regularly (approx. every 2–4 months).

Never run a wash programme without using the spray arms.

⚠ Damage due to soiling entering the circulation system.

Without filters, soiling can enter the circulation system and cause a blockage.

Do not run a wash programme without the lower spray arm or without the filters fitted.

When cleaning the filters and spray arms, make sure that coarse soiling cannot get into the circulation system.

- Switch the dishwasher off.

Removing the cutlery tray (if present)

In order to be able to remove the upper spray arm, you first have to remove the cutlery tray (if present).

- Pull out the cutlery tray.

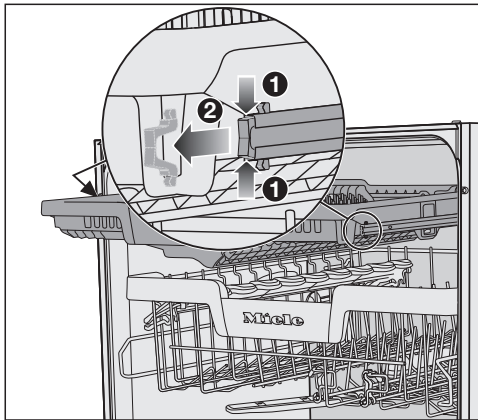

- Press the rail safety clips on both sides of the cutlery tray together **1** and remove the safety clips **2** at the same time.
- Take out the cutlery tray completely.

Removing the upper spray arm

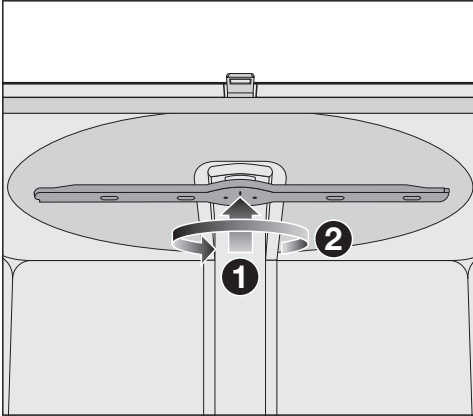

- Push the upper spray arm upwards **1** to engage the inner ratchet. Then unscrew the spray arm by rotating the screw thread anti-clockwise **2** (view from below).

Removing the middle spray arm

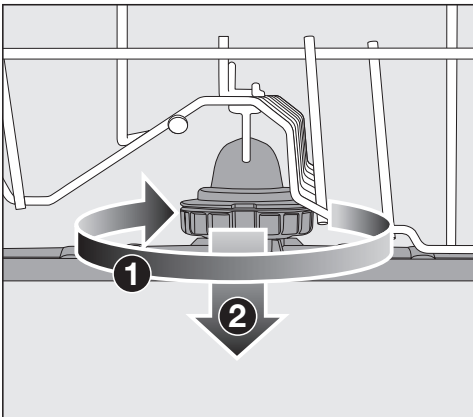

- Rotate the screw thread of the middle spray arm clockwise **1** (view from above) and remove the spray arm **2**.

Removing the lower spray arm

- Remove the lower basket.

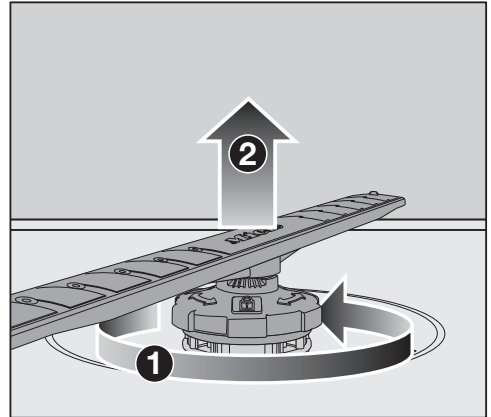

- Rotate the screw thread of the lower spray arm anti-clockwise **1** (view from above) and pull the spray arm upwards to remove **2**.

Cleaning and care

Cleaning the spray arms

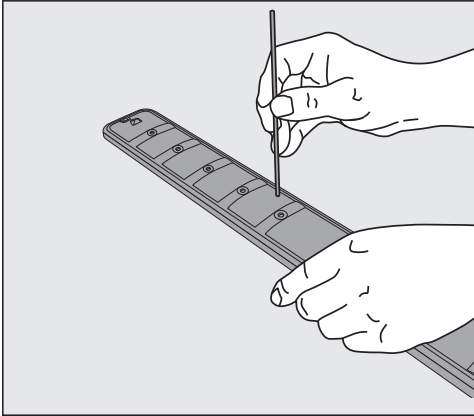

- Use a pointed object to push food particles stuck in the jets into the spray arm.
- Rinse the spray arm thoroughly under running water.

Refitting the upper spray arm

- Reinstall the upper spray arm and tighten it by hand.

Refitting the middle spray arm

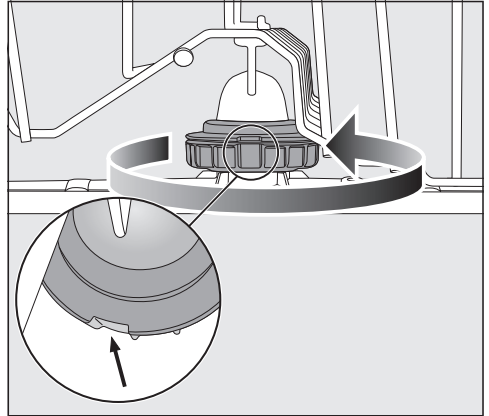



- Replace the middle spray arm and turn the screw thread anti-clockwise (view from above) until it engages. Make sure that the recesses in the lock line up.

Refitting the lower spray arm

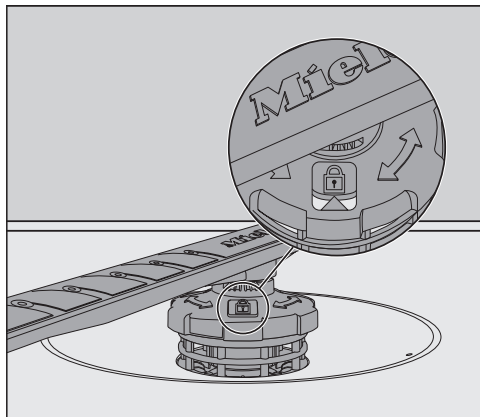
- Refit the lower spray arm and ensure that the filter combination lies flat in the base of the wash cabinet.



- Rotate the screw thread of the lower spray arm clockwise (view from above) until the arrow in the viewing window points to the lock symbol .
- Make sure the spray arms can rotate freely.

 Damage due to soiling entering the circulation system.

The lower spray arm is used to secure the filter combination. Without filters, coarse soiling can enter the circulation system and cause a blockage.

Do not run a wash programme without the lower spray arm or without the filters fitted.

Inserting the cutlery tray (if present)

- Slide the cutlery tray back onto the rails from the front.
- Replace the safety clips in the rails on both sides of the cutlery tray.

Cleaning and care

Checking the filters in the wash cabinet

The filter combination in the base of the wash cabinet retains coarse soiling from the suds solution. This prevents soiling getting into the circulation system and re-entering the wash cabinet through the spray arms.

 Damage due to soiling entering the circulation system.

Without filters, soiling can enter the circulation system and cause a blockage.

Do not run a wash programme without the lower spray arm or without the filters fitted.

When cleaning the filters and spray arms, make sure that coarse soiling cannot get into the circulation system.

The filters can become clogged by soiling that collects over time. The level of soiling and the time it takes before the filters need cleaning will vary depending on use.

The message *Check filters* will appear in the display after every 50 programme sequences.

- Check the filter combination.
- Clean the filter combination if necessary.
- Then confirm the message with *OK*.

Cleaning the filters

- Switch the dishwasher off.
- Remove the lower spray arm (see “Cleaning and care - Cleaning the spray arms”).
- Before removing the filter combination, remove any coarse soiling to prevent it from entering the circulation system.

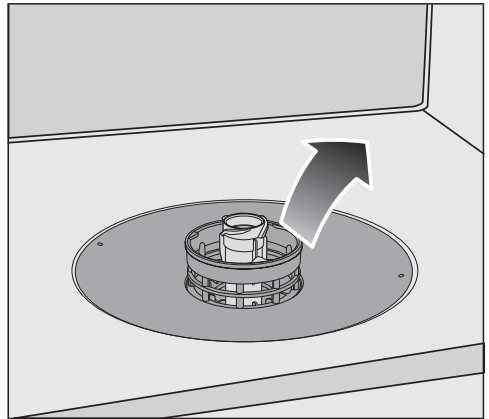

- Remove the filter combination.

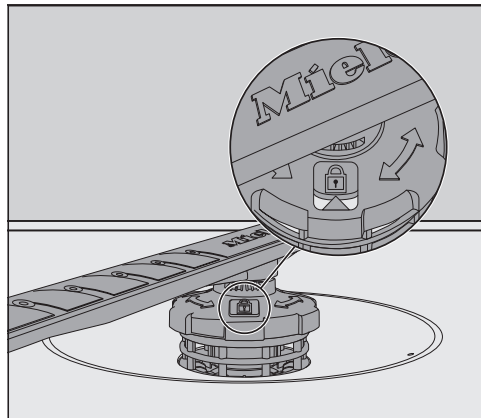
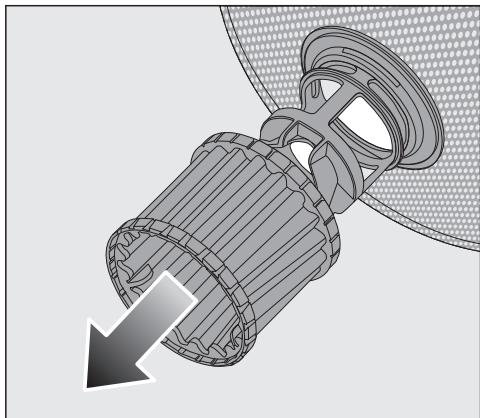

- In order to clean the inside of the filter, pull the microfilter downwards and away from the filter combination.
- Rinse all the parts under running water.
If necessary, use a soft cleaning brush to remove soiling.
- Push the microfilter back onto the filter combination.
- Refit the filter combination so that it lies flat in the base of the wash cabinet.
- Refit the lower spray arm to the filter combination using the screw thread.

- Rotate the screw thread clockwise until the arrow in the viewing window points to the lock symbol .

 Damage due to soiling entering the circulation system.

The lower spray arm is used to secure the filter combination. Without filters, coarse soiling can enter the circulation system and cause a blockage.

Do not run a wash programme without the lower spray arm or without the filters fitted.

Cleaning and care

Cleaning the water inlet filter

A filter is incorporated in the screw thread to protect the water inlet valve. If the filter is soiled, insufficient water flows into the wash cabinet.

 Risk of electric shock.

The plastic housing of the water connection contains an electrical valve.

The housing must not be dipped in water.

- Disconnect the dishwasher from the power supply.
To do this, switch off at the socket and withdraw the plug.
- Turn off the tap.
- Unscrew the water inlet valve.

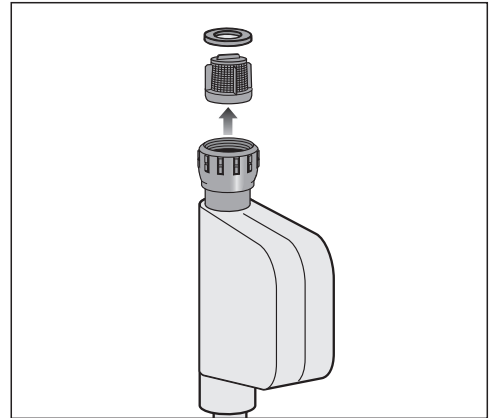

- Carefully remove the seal from the threaded union.
- Using combination or pointed pliers, take hold of the plastic filter bar and remove the filter.
- Rinse the filter under running water.
- Reassemble in reverse order.

Screw the threaded union securely back onto the tap. Slowly turn on the tap. If water drips out, tighten the connection.

Never forget to put the filter back in place after cleaning.

Cleaning the drain pump

If water remains in the wash cabinet after the end of a programme, the water has not been pumped away. The drain pump may be blocked by foreign objects. These foreign objects are easy to remove.

- Disconnect the dishwasher from the mains power supply.
To do this, switch off at the socket and withdraw the plug.
- Take the filter combination out of the wash cabinet (see “Cleaning and care - Cleaning the filters”).
- Scoop the water out of the wash cabinet using a small container.



- Press the catch of the drain pump cover inwards ①.
- Tip the cover inwards until it is released ②.
- Rinse the cover thoroughly under running water and remove all foreign objects.

Cleaning and care

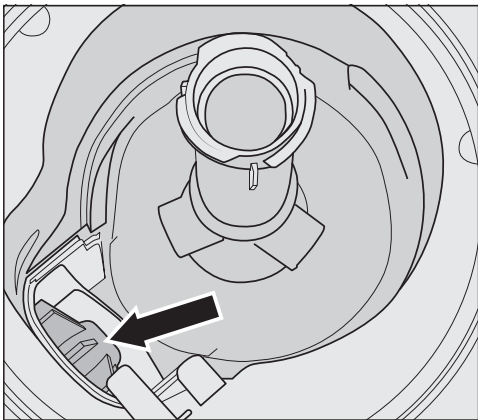

The drain pump (see arrow) is underneath the cover.

! Risk of injury from glass splinters.
It is especially difficult to see glass splinters in the drain pump.
Take care when cleaning the drain pump.

- Carefully remove all foreign objects from the drain pump. Turn the drain pump impeller by hand to check that there are no more obstructions. You will feel a little resistance when you turn the impeller.
- Refit the cover in the reverse order of removing it.

Ensure that the catch engages correctly.

! Damage caused by incorrect cleaning.
The components are delicate and can be damaged during cleaning.
Take care when cleaning the drain pump.

Problem solving guide





Many malfunctions and minor faults that can occur in daily operation can be corrected without contacting Miele. This will save you time and money because you will not need a service call.

You can find information on how to remedy faults yourself at www.miele.com.au/service or www.miele.co.nz/service and on the Miele website.

Please note, however, that a call-out charge will be applied to unnecessary service visits where the problem could have been rectified as described in these operating instructions.



This section only lists faults that you can remedy yourself. All other faults are shown in  Fault F.

Technical problems

Problem	Possible cause and remedy
The display remains dark after the  sensor has been pressed long enough.	The dishwasher is not plugged in or the socket is not switched on. ■ Insert the plug and switch on at the socket.
	The circuit breaker has tripped. ■ Reset the circuit breaker in the mains fuse box (see data plate for minimum fuse rating). ■ If the circuit breaker trips again, call Miele.
The  sensor does not respond or only responds once it has been touched several times.	Energy management: the door was opened or closed shortly before the  sensor was touched. As a result, the dishwasher was already switched on. The electronics require a few seconds to be ready for operation. ■ Wait a few seconds after opening or closing the door. ■ Then touch the  sensor.
The dishwasher stops during a programme.	The circuit breaker has tripped. The display is dark and the dishwasher cannot be switched on. ■ Reset the circuit breaker in the mains fuse box (see data plate for minimum fuse rating). ■ If the circuit breaker trips again, call Miele.

Problem solving guide



Fault messages

Problem	Possible cause and remedy
The alarm tone is sounding. One of the following faults appears in the display:	Before rectifying the problem, you must: <ul style="list-style-type: none">■ Switch the dishwasher off.
 Fault F	There may be a technical fault. <ul style="list-style-type: none">■ Switch the dishwasher back on after a few seconds.■ Restart the desired programme. If the fault message appears again, there is a technical fault. <ul style="list-style-type: none">■ Switch the dishwasher off.■ Turn off the tap.■ Call Miele.
 Waterproof	The Waterproof system has reacted. <ul style="list-style-type: none">■ Switch the dishwasher off.■ Turn off the tap.■ Call Miele.

Door release

Problem	Possible cause and remedy
The alarm tone is sounding. The following fault is indicated in the display:	Before rectifying the problem, you must: <ul style="list-style-type: none">■ Switch the dishwasher off.
 Door fault	The door does not open automatically. There may be a technical fault. <ul style="list-style-type: none">■ Open the door manually (see “Using for the first time – Opening the door”) and switch the dishwasher back on.■ If the same fault message appears again, call Miele. The door locking pin does not retract after the door is opened. There may be a technical fault. <ul style="list-style-type: none">■ Switch the dishwasher back on.■ If the same fault message appears again, call Miele.

Water intake fault





Problem	Possible cause and remedy
<p>The alarm tone is sounding. One of the following messages appears in the display:</p>	
<p> Turn on tap</p>	<p>The tap is turned off.</p> <ul style="list-style-type: none"> ■ Turn on the tap fully.
<p> Water intake</p>	<p>Before rectifying the problem, you must:</p> <ul style="list-style-type: none"> ■ Switch the dishwasher off. <p>Water intake is restricted.</p> <ul style="list-style-type: none"> ■ Turn on the tap fully and start the programme again. ■ Clean the filter in the water inlet (see “Cleaning and care – Cleaning the water inlet filter”). ■ The water connection pressure is lower than 50 kPa. Seek professional advice. ■ The on-site connection for the water drainage may be too low and you will need to vent the water drainage (see “Installation – Drainage”).
<p>The following fault message appears in the display during the SolarSave programme: Intake temperature too low</p>	<p>The intake water has not reached the required temperature of 45 °C (see “Installation – Water inlet”).</p> <ul style="list-style-type: none"> ■ Restart the programme. ■ If the fault message appears again, select a different programme.

Water drainage fault







Problem	Possible cause and remedy
<p>The alarm tone is sounding. The message  Drain appears in the display.</p>	<p>Before rectifying the problem, you must:</p> <ul style="list-style-type: none"> ■ Switch the dishwasher off. <p>Water drainage fault.</p> <p>There might be water in the wash cabinet.</p> <ul style="list-style-type: none"> ■ Clean the filter combination (see “Cleaning and care – Cleaning the filters”). ■ Clean the drain pump (see “Cleaning and care – Cleaning the drain pump”). ■ Remove any kink or loop in the drain hose.

Problem solving guide

Fault with the AutoDos (automatic dispensing)

Problem	Possible cause and remedy
<p>The following message appears in the display: Check PowerDisk</p>	<p>The  <i>AutoDos</i> function is activated. There is no PowerDisk or an empty PowerDisk has been inserted.</p> <ul style="list-style-type: none">■ Confirm the message Check PowerDisk with <i>OK</i>.■ Insert a full PowerDisk.■ Use the \vee/\wedge sensors to select the Available message and confirm with <i>OK</i> (see “Detergent – Automatic dispensing/<i>AutoDos</i>”).■ If you do not wish to use automatic dispensing, deactivate the function using the  <i>AutoDos</i> sensor or by confirming the Not available message with <i>OK</i>.
<p>The alarm tone is sounding. The programme does not start or a programme that has already started stops. The following message appears in the display: AutoDos lid open</p>	<p>The AutoDos lid has not been closed properly.</p> <ul style="list-style-type: none">■ Close the AutoDos lid and lock it fully (see “Detergents - Automatic dispensing/<i>AutoDos</i>”).■ If the lid cannot be fully closed, check whether the PowerDisk holder is lying flat (see “Detergents - Inserting a PowerDisk”).■ If the same fault message appears again, call Miele.
<p>The following message appears in the display: PowerDisk empty. Deactivate AutoDos with <i>OK</i>.</p>	<p>The  <i>AutoDos</i> function is active and the PowerDisk is empty.</p> <ul style="list-style-type: none">■ Replace the PowerDisk (see “Detergents - Automatic dispensing/<i>AutoDos</i>”). <p>If you do not wish to use automatic dispensing, deactivate the function using <i>OK</i> or the  <i>AutoDos</i> sensor.</p>

Problem solving guide

Problem	Possible cause and remedy
<p>At the end of the programme, the alarm tone sounds and the display shows the following message:  Fault F601</p>	<p>There is a fault with the AutoDos.</p> <ul style="list-style-type: none"> ■ Switch the dishwasher off and back on again. ■ Check whether the PowerDisk holder and the PowerDisk have been fitted correctly (see “Detergents – Automatic dispensing/AutoDos”). ■ Activate the  <i>AutoDos</i> function and start the programme again. <p>If the fault message appears again, there is a technical fault. You can continue to use your dishwasher by deactivating automatic dispensing with the  <i>AutoDos</i> sensor and manually dispensing the detergent via the detergent compartment.</p> <ul style="list-style-type: none"> ■ If you wish to use automatic dispensing again, contact Miele.
<p>At the end of the programme, the alarm tone might sound and the display shows the following message: AutoDos maintenance required The dishwasher does not switch off at the end of the programme. The dishes may not be clean because an insufficient amount of detergent was dispensed. The  <i>AutoDos</i> function is automatically deactivated during the programme sequence.</p>	<p>No PowerDisk or an empty PowerDisk has been inserted or the AutoDos is blocked by residual detergent. Detergent dosage is insufficient. The  <i>AutoDos</i> function was automatically deactivated.</p> <ul style="list-style-type: none"> ■ Switch the dishwasher off and back on again. <p>Multiple messages appear in the display.</p> <ul style="list-style-type: none"> ■ Clean the AutoDos (see “Detergent – Cleaning the AutoDos”). ■ Insert a full PowerDisk and close the AutoDos lid. ■ Clean the lower spray arm (see “Cleaning and care – Cleaning the spray arms”). ■ Confirm each message with <i>OK</i>. ■ Activate the  <i>AutoDos</i> function by confirming the message AutoDos available with <i>OK</i>. ■ Start the programme again.

Problem solving guide

Spray arm fault

Problem	Possible cause and remedy
<p>During the programme and at the end of the programme, the display shows the following message: Check spray arms The dishwasher does not switch off at the end of the programme. The crockery may not be clean because no detergent was dispensed.</p>	<p>The lower spray arm is blocked or the jets of the lower spray arm are clogged. The AutoDos detergent outlet may not be completely flushed out.</p> <ul style="list-style-type: none">■ Switch the dishwasher off and back on again. <p>A message will appear in the display.</p> <ul style="list-style-type: none">■ Perform a rotation check of the lower spray arm and rearrange the crockery if it is blocking the spray arm.■ Clean the lower spray arm (see “Cleaning and care – Cleaning the spray arms”).■ Confirm the message with <i>OK</i>.■ Start the programme again.

General problems with the dishwasher

Problem	Possible cause and remedy
<p>The indicator lights and the display are dark.</p>	<p>The dishwasher has switched off automatically to save energy.</p> <ul style="list-style-type: none">■ Switch the dishwasher back on using the  sensor.
<p>Detergent residue is left in the detergent compartment at the end of a programme.</p>	<p>The detergent compartment was still damp when detergent was added.</p> <ul style="list-style-type: none">■ Only add the detergent when the detergent compartment is dry.
<p>The detergent compartment lid cannot be closed.</p>	<p>Residual detergent is blocking the catch.</p> <ul style="list-style-type: none">■ Remove the residual detergent.
<p>At the end of a programme there is a film of moisture on the inside of the door and possibly on the interior walls.</p>	<p>This is part of the normal function of the drying system. The moisture will dissipate after a short while.</p>

Problem solving guide

Problem	Possible cause and remedy
Water remains in the wash cabinet at the end of a programme.	Before rectifying the problem, you must: <ul style="list-style-type: none"> ■ Switch the dishwasher off.
	The filter combination in the wash cabinet is clogged. <ul style="list-style-type: none"> ■ Clean the filter combination (see “Cleaning and care – Cleaning the filters”).
	The drain pump is blocked. <ul style="list-style-type: none"> ■ Clean the drain pump (see “Cleaning and care – Cleaning the drain pump”).
	The drain hose is kinked. <ul style="list-style-type: none"> ■ Remove any kinks from the drain hose.
Build-up of odours in the wash cabinet.	The frequent use of low-temperature wash programmes (< 50 °C) increases the risk of contamination and odours inside the wash cabinet. <ul style="list-style-type: none"> ■ Regularly run a high-temperature programme. This is to prevent the build-up of residues and odours.

Noises

Problem	Possible cause and remedy
Knocking noise in the wash cabinet.	A spray arm is knocking against a crockery piece. <ul style="list-style-type: none"> ■ Carefully open the door and rearrange the wash items that are obstructing the spray arm.
Rattling noise in the wash cabinet.	Items of crockery are not secure in the wash cabinet. <ul style="list-style-type: none"> ■ Carefully open the door and rearrange the wash items so that they sit securely.
	There is a foreign object (e.g. glass shard) in the drain pump. <ul style="list-style-type: none"> ■ Remove the foreign object from the drain pump (see “Cleaning and care - Cleaning the drain pump”).
Knocking noise in the water pipes.	This may be caused by the on-site installation or the cross-section of the piping. <ul style="list-style-type: none"> ■ However, this will not affect the functioning of the dishwasher in any way. If in doubt, contact a suitably qualified plumber.

Problem solving guide

Unsatisfactory cleaning result

Problem	Possible cause and remedy
The crockery is not clean.	The items were not loaded correctly. ■ See notes under “Loading the dishwasher”.
	The programme was not thorough enough. ■ Select a more intensive programme (see “Programme chart”). ■ Activate the “Extra clean” function (see “Extras – Extra clean”). ■ Activate the “2nd interim rinse” (see “Settings – 2nd interim rinse”).
	Not enough cleaning agent was dispensed. ■ Use more detergent during manual dispensing or change the detergent you are using. ■ Increase the dispensing quantity during automatic dispensing (if available) (see “Settings – AutoDos”).
	Items are blocking the path of the spray arms. ■ Carry out a rotation check and if needed rearrange the items so that the spray arms can rotate freely.
	The filter combination in the wash cabinet is not clean or was incorrectly installed. This may have caused the spray arm jets to become blocked. ■ Clean and/or fit the filter combination correctly. ■ Clean the spray arm jets if necessary (see “Cleaning and care – Cleaning the spray arms”).
There are smears on glassware and cutlery. There is a bluish sheen on the surface of glassware. The film can be wiped off.	The rinse aid dosage is set too high. ■ Reduce the dosage (see “Settings - Rinse aid”).

Problem solving guide

Problem	Possible cause and remedy
Dishes are not dry or cutlery and glasses are blotchy.	The rinse aid dosage is set too low or the rinse aid reservoir is empty. ■ Replenish the rinse aid, increase the dosage, or change the brand of rinse aid (see “Using for the first time - Rinse aid”).
	Dishes were taken out of the wash cabinet too soon. ■ Leave dishes in longer (see “Operation - Unloading the dishwasher”).
	The duration of the drying phase for the selected programme is not sufficient for the crockery (particularly for plastic crockery). ■ Select the "Extra dry" function (see “Extras - Extra dry”).
	You have used combination products that have insufficient drying performance. ■ Switch to another detergent or add rinse aid (see “Using for the first time - Rinse aid”).
Glassware has a brown or blue tinge. The film cannot be wiped off.	Ingredients from the detergent have formed a deposit. ■ Switch to another detergent straight away.
Glassware is dull and discoloured. The film cannot be wiped off.	The glassware is not dishwasher safe. The surface has altered. ■ There is no remedy. Purchase glassware which is dishwasher safe.
Tea or lipstick stains have not been completely removed.	The wash temperature of the selected programme was too low. ■ Select a programme with a higher wash temperature.
	The bleaching effect of the detergent is too low. ■ Change your detergent.
White residue is visible on the dishware. Clouding has occurred on glassware and cutlery. The film can be wiped off.	Not enough rinse aid was added. ■ Increase the dosage (see “Settings – Rinse aid”).
	The salt reservoir is empty. ■ Fill the salt reservoir (see “Using for the first time - Dishwasher salt”).
	The salt reservoir cap has not been screwed on correctly.

Problem solving guide

Problem	Possible cause and remedy
	<ul style="list-style-type: none"> ■ Replace it, making sure that it screws back on correctly.
	<p>Unsuitable combination detergents were used.</p> <ul style="list-style-type: none"> ■ Change your detergent. If using tabs or powder detergent, do not choose combination products and ensure you refill the dishwasher salt and rinse aid.
	<p>The water softener is programmed to a setting which is too low for the water hardness level.</p> <ul style="list-style-type: none"> ■ Programme the water softener to a higher water hardness level (see “Settings - Water hardness”).
	<p>Too much detergent was dispensed.</p> <ul style="list-style-type: none"> ■ Reduce the dispensing quantity during automatic dispensing (if available) (see “Settings – AutoDos”). ■ Activate the “Second interim rinse” function (see “Settings - 2nd interim rinse”).
	<p>Not enough combination detergent was dispensed. The water softener performance is not sufficient.</p> <ul style="list-style-type: none"> ■ Increase the dispensing quantity during automatic dispensing (if available) (see “Settings – AutoDos”). ■ Add more dishwasher salt.
<p>Plastic items are discoloured.</p>	<p>Natural dyes, e.g. from carrots, tomatoes or tomato sauce may be the cause. The amount of detergent used or its bleaching effect was not sufficient to deal with natural dyes.</p> <ul style="list-style-type: none"> ■ Use more detergent (see “Detergents”). Parts that are already discoloured will not revert to their original colour.

Problem solving guide

Problem	Possible cause and remedy
There are rust stains on cutlery.	<p>The affected items are not corrosion resistant.</p> <ul style="list-style-type: none">■ There is no remedy. Purchase cutlery which is dishwasher safe.
	<p>A programme was not run after dishwasher salt was added. Traces of salt have got into the normal wash cycle.</p> <ul style="list-style-type: none">■ Immediately after filling the salt container and each time you remove the salt container cap, run the Rinse salt programme without load items in the dishwasher to dissolve and remove any traces of salt from the wash cabinet.
	<p>The salt reservoir cap has not been screwed on correctly.</p> <ul style="list-style-type: none">■ Replace it, making sure that it screws back on correctly.

Service

You can find information on how to remedy faults yourself and about Miele spare parts at www.miele.com.au/service or www.miele.co.nz/service.

Contact in case of fault

In the event of any faults which you cannot remedy yourself, please contact Miele.

You can book a Miele customer service call-out online at www.miele.com.au/service or www.miele.co.nz/service.

Contact information for Miele can be found at the end of this booklet.

Please quote the model and serial number of your appliance when contacting Miele. This information can be found on the data plate.

The data plate is located on the right side of the door.

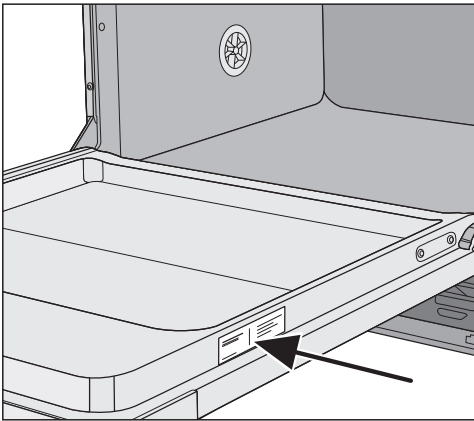

Warranty

The manufacturer's warranty for this appliance is 2 years.

For further information, please refer to your warranty booklet.

Dishwasher detergent, rinse aid, and cleaning and care products are available for this dishwasher, as are optional accessories.

All the products have been designed for Miele appliances.

These and many other useful products can be ordered from the Miele online store or a Miele Experience Centre.

Detergents

With your Miele dishwasher you have chosen excellent quality and performance. To achieve optimum results all the time, it is important to use the right dishwasher detergents. Not all off-the-shelf products deliver the same results in all dishwashers.

For this reason Miele offers dishwasher products specifically designed for Miele appliances.

PowerDisk

Special Miele formula – for outstanding cleaning results in Miele dishwashers with AutoDos automatic dispensing.

- exclusive Miele powder granulate
- with rinse aid and salt functions
- with components to protect glass
- with active oxygen for thorough cleaning
- with super-active enzymes – effective even at low temperatures

In hard water areas, we recommend using the complete Miele system: the PowerDisk, rinse aid, and salt perfectly match each other.

Detergent tablets

- sparkling results even with stubborn food deposits

- combination product with other functions such as rinse aid, salt, and glass protective additives
- phosphate-free – environmentally friendly
- water-soluble wrapping – no need to unwrap

Powder detergent

- with active oxygen for thorough cleaning
- with enzymes which are effective even at low-temperatures
- with glass protective formula against corrosion

Rinse aid

- for sparkling glasses
- helps dishes to dry
- with glass protective formula against corrosion
- specially designed cap for accurate and easy dispensing

Dishwasher salt

- Prevents limescale deposits on dishes and in the dishwasher
- Extra coarse-grained

Optional accessories

Appliance care

Miele cleaning and care products provide optimum care for your dishwasher.

IntenseClean

- for use with the Maintenance prog. programme (depending on model) without detergent dispensing
- cleans the dishwasher effectively and thoroughly
- removes grease, bacteria and associated unpleasant odours
- ensures excellent dishwashing results

Descaling agent

- removes heavy limescale deposits
- mild and gentle with natural citric acid

DishClean

- removes odours, limescale and light deposits
- maintains the elasticity and leak tightness of the seals

The Miele Waterproof system

Provided that your dishwasher has been installed correctly, the Miele Waterproof system will protect you from water damage throughout its lifetime.

Water inlet

 Danger to health due to wash water.

Water in the dishwasher must not be used as drinking water.

Do not drink any water from the dishwasher.

 Health risk and risk of damage due to contaminated incoming water.

The quality of the water used must correspond to the drinking water specification of the country in which the dishwasher is being operated.

Connect the dishwasher to a drinking water supply.

The dishwasher may be connected to cold or hot water (up to max. 60 °C). If energy-saving water-heating sources, such as a solar water heating system, are used, we recommend connecting to the hot water supply. This saves both time and electricity costs. Hot water is used in all programmes.

The SolarSave programme (if available) requires a hot water connection of between a minimum of 45 °C and a maximum of 60 °C (intake temperature).

The higher the water intake temperature, the better the cleaning and drying results.

The water inlet hose is approximately 1.5 m long.

A tap with a $\frac{3}{4}$ " male thread must be provided on site. If this type of tap is not available, only a qualified plumber may connect the dishwasher to the household water supply.

The dishwasher must be connected to a mains water supply in accordance with current local and national safety regulations.

The water connection pressure needs to be between 50 and 1000 kPa. If the water pressure is too high, a pressure reducing valve must be fitted.

Installation

 Risk of damage from leaking water.

The threaded union is subject to water pressure. Water leaking from it can cause damage.

Turn on the tap slowly and check for leaks. Correct the position of the seal and union if necessary. Check the screw connections regularly to make sure they are still tight.

 Risk of damage due to excessive pressure.

A brief increase in the water pressure can damage components of the dishwasher.

This dishwasher must only be operated when it is connected to a fully vented plumbing system.

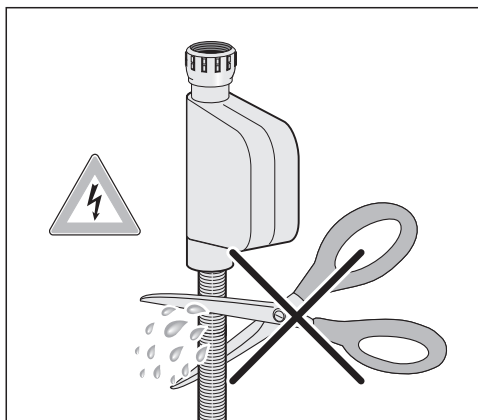

 Risk of electric shock from mains voltage.

There are live electrical components in the water inlet hose.

The water inlet hose must not be shortened or damaged in any way (see illustration).

Drainage

The appliance drainage system is fitted with a non-return valve, which prevents dirty water from flowing back into the dishwasher via the drain hose.

The dishwasher is supplied with approx. 1.5 m of flexible drain hose with an internal diameter of 22 mm.

The hose can be extended using a connection piece to attach a further length of hose. The drainage length must not be longer than 4 m and the delivery head no higher than 1 m.

If the hose is to be directly connected to the drainage outlet on site, use the supplied hose clip (see the installation plan).

The hose can be directed to the left or the right of the appliance.

The on-site connector for the drain hose can be adapted to different hose diameters. If the connector extends too far into the drain hose, it must be shortened. Otherwise, the drain hose can become clogged.

The drain hose must not be shortened.

Lay the drain hose so that it does not kink and is not being subjected to pressure or being tugged.

 Risk of damage from leaking water.

Overflowing water can cause damage.

After using the appliance for the first time, make sure that the water drain does not leak.

Venting the water drainage

If the on-site drainage connection is situated lower than the guide for the rollers of the lower basket in the door, the drainage system must be vented. Otherwise, a siphoning effect during a programme can cause the appliance to empty itself of water.

- Open the dishwasher door fully.

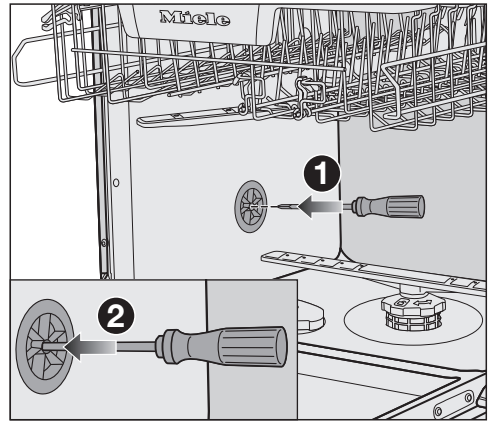

- Remove the lower basket.
- Insert a screwdriver into the middle opening of the vent valve in the left wash cabinet wall ①.
- Press the screwdriver further into the opening and push it through the membrane ② behind.

The vent opening for the water drain is now open.

Installation

Electrical connection

The dishwasher is supplied with a mains connection cable with moulded plug ready for connection to an earthed socket.

The socket must be easily accessible after the dishwasher has been installed. If the switch is not accessible after installation, an additional means of disconnection must be provided for all poles.

 Risk of fire from overheating. Connecting the dishwasher to a multi-socket plug adapter or to an extension lead can overload the cable. Do not use an extension lead or multi-socket plug adapter.

The electrical installation and all electrical work must be carried out by a suitably qualified and competent person in strict accordance with national and local safety regulations. For extra safety, it is advisable to install a residual current device (RCD) with a trip current of 30 mA. Ensure power is not supplied to the appliance until after the installation has been completed. Connection should be made via a suitable switched socket.

If the mains connection cable is damaged, it must only be replaced with a specific mains connection cable of the same type (available Miele). For safety reasons, such replacement may only be carried out by a suitably qualified and competent technician or by a Miele authorised service technician, in order to avoid a hazard.

For technical data, see the data plate located on the right side of the door. Compare this information with the data of the on-site electrical connection. If in any doubt, consult a qualified electrician.

Temporary or permanent operation with a self-sufficient or non-mains synchronous energy supply system (e.g. isolated networks, back-up systems) is possible. A requirement for the operation is that the energy supply system complies with all current local and national requirements that apply to stand-alone, solar and/or battery systems.

The protective measures provided in the domestic installation and in this Miele product must also be assured in their function and operation in isolated operation or in non-mains synchronous operation, or replaced with equivalent measures in the installation.

Technical data

Dishwasher model	Normal	XXL
Height of freestanding appliance	84.5 cm (adjustable by +3.5 cm)	-
Height of built-in appliance	80.5 cm (adjustable by +6.5 cm)	84.5 cm (adjustable by +6.5 cm)
Niche height	min. 80.5 cm (+6.5 cm)	min. 84.5 cm (+6.5 cm)
Width	59.8 cm	59.8 cm
Niche width	60 cm	60 cm
Depth of freestanding appliance	60 cm	-
Depth of built-in appliance	57 cm	57 cm
Weight	max. 58 kg	max. 49 kg
Voltage	see data plate	
Rated load	see data plate	
Fuse rating	see data plate	
Test certifications awarded	see data plate	
Water pressure	50–1000 kPa	50–1000 kPa
Hot water connection	up to max. 60 °C	up to max. 60 °C
Delivery head	max. 1 m	max. 1 m
Drainage length	max. 4 m	max. 4 m
Mains connection cable	approx. 1.7 m	approx. 1.7 m
Capacity	14/15 place settings*	14/15 place settings*

* depending on model

Technical data

Dishwasher model	Normal	XXL
Frequency band of the Wi-Fi module	2.4000 GHz – 2.4835 GHz	
Maximum transmission power of the Wi-Fi module	< 100 mW	

Miele Australia Pty. Ltd.

ACN 005 635 398

ABN 96 005 635 398

Level 4, 141 Camberwell Road
Hawthorn East, VIC 3123

1300 464 353 (1300 4 MIELE)

info@miele.com.au

www.miele.com.au

Miele New Zealand Limited

IRD 98 463 631

8 College Hill
Freemans Bay, Auckland 1011

0800 464 353 (0800 4 MIELE)

customercare@miele.co.nz

www.miele.co.nz

Miele Global Headquarters

Germany

Miele & Cie. KG

Carl-Miele-Straße 29

33332 Gütersloh

Federal Republic of Germany

G 7604, G 7609

en-AU, NZ

M.-Nr. 12 779 150 / 00