









## Operating and installation Instructions Washing machine



It is **essential** to read these operating instructions before installing and using the appliance. This prevents both personal injury and damage to the appliance.

# Contents

---

<b>Caring for the environment</b> .....	<b>7</b>
<b>Warning and Safety instructions</b> .....	<b>8</b>
<b>Operating the washing machine</b> .....	<b>15</b>
Control panel.....	15
Sensor controls and touch display with sensor controls.....	16
Main menu .....	16
Examples on how to operate the appliance .....	17
Operating the launderette version .....	19
<b>Using for the first time</b> .....	<b>20</b>
Setting the brightness of the display.....	21
Setting the date .....	21
Selecting programme packages .....	22
<b>1. Preparing the laundry</b> .....	<b>26</b>
<b>2. Loading the washing machine</b> .....	<b>27</b>
<b>3. Selecting a programme</b> .....	<b>28</b>
<b>4. Selecting programme settings</b> .....	<b>29</b>
<b>5. Adding detergent</b> .....	<b>30</b>
Adding fabric softener or liquid starch separately .....	31
Adding starch separately .....	31
<b>6. Starting the programme - the end of the programme</b> .....	<b>34</b>
<b>Timer</b> .....	<b>35</b>
<b>Programme chart</b> .....	<b>36</b>
<b>Extras</b> .....	<b>52</b>
Pre-wash  .....	52
Pre-rinse  .....	52
Rinse plus  .....	52
Soak  .....	52
Intensive  .....	52
Water plus  .....	52
Pre-ironing  .....	52
Rinse hold  .....	52
Starch stop  .....	52
<b>Special features in the programme sequence</b> .....	<b>53</b>
Spinning .....	53
Anti-crease .....	53
<b>Changing the programme sequence</b> .....	<b>54</b>
Changing a programme .....	54

Cancelling a programme.....	54
Switching on the washing machine after an interruption to the power supply.....	54
Adding or removing laundry .....	55
<b>Cleaning and care .....</b>	<b>56</b>
Cleaning the external casing and fascia panel .....	56
Cleaning the detergent dispenser drawer .....	56
Cleaning the drum, suds container and drainage system .....	58
Cleaning the sealing ring .....	58
Cleaning the filters in the water inlet.....	59
<b>Problem solving guide .....</b>	<b>60</b>
The programme does not start.....	60
Programme cancellations and fault messages .....	60
A fault message appears in the display.....	61
An unsatisfactory wash result .....	62
General problems with the washing machine.....	63
The door will not open .....	65
Opening the door in the event of a blocked drain outlet and/or power cut.....	66
<b>After sales service.....</b>	<b>69</b>
Contact in case of fault.....	69
Optional accessories .....	69
<b>Installation.....</b>	<b>70</b>
Front view .....	70
Rear view .....	71
Installation locations.....	72
Installation notes .....	72
Transporting the washing machine to its installation site .....	73
Installation surface.....	74
Removing the transit bars .....	74
Fitting the transit bars .....	76
Aligning the washing machine .....	77
Fixing bracket for plinth .....	78
External control equipment.....	80
Payment system .....	80
Water connection.....	81
Cold water connection .....	81
Hot water connection* .....	82
Drainage.....	83
Drain valve .....	83
Drain pump .....	83
Electrical connection .....	84
<b>Technical data .....</b>	<b>85</b>

# Contents

---

<b>Supervisor level</b> .....	<b>86</b>
Opening the Supervisor level.....	86
Code-based access .....	86
Changing the code .....	86
Closing the settings menu .....	86
Operation/display.....	87
Language .....	87
Language menu .....	87
Set languages .....	87
Display brightness .....	87
Time .....	88
Date.....	88
Volume .....	88
Visibility parameters.....	88
“Display” off status .....	89
“Machine” off status .....	89
Delay start .....	89
Memory.....	89
Temperature unit.....	90
Weight unit .....	90
Logo .....	90
Supervisor code .....	90
Programme selection.....	90
Controls.....	90
Programme packages.....	91
Favourite programmes .....	91
Special programmes .....	92
Sort programmes.....	92
Prog. colour allocation.....	93
Hygiene .....	93
Expert code.....	93

Process technology.....	93
Anti-crease .....	93
Water level Cottons.....	93
Water level Minimum iron .....	93
Pre-wash temp. Cottons .....	94
Wash time.....	94
Pre-rinse Cottons .....	94
Pre-rinse Minimum iron .....	94
Pre-wash Cotton/M.iron .....	94
Cottons rinses .....	95
Minimum iron rinses .....	95
Disinfection rinse.....	95
Auto load control.....	95
Controlled energy cons.....	95
Service .....	95
Clean drain pump.....	95
Service interval.....	96
External applications.....	96
Availability of Miele digital products .....	96
Empty sensor .....	96
Early warning counter.....	97
Automatic dispensing .....	97
Adjustment value dosage 1–6.....	97
Peak load signal .....	97
Peak load prevention .....	97
COM module selection .....	98
Wi-Fi .....	98
Network time.....	99
Remote.....	99
RemoteUpdate.....	99
SmartGrid .....	100
Machine parameters.....	101
Suds cooling .....	101
Water intake .....	101
Temperature reduction.....	102
Low water pressure .....	102
CapDosing .....	102
Legal information .....	103

# Contents

---

Payment system .....	103
Settings for payment systems .....	103
Payment system lock .....	104
Programme cancellation .....	104
F-back signal to pay system .....	104
FOC programmes .....	105
Clear paid signal .....	105
Debounce time .....	105

### Disposal of the packing material

The transport and protective packaging has been selected from materials which are environmentally friendly for disposal, and can normally be recycled.

Recycling the packaging reduces the use of raw materials in the manufacturing process and also reduces the amount of waste in landfill sites.

Ensure that any plastic wrappings, bags etc. are disposed of safely and kept out of the reach of babies and young children. Danger of suffocation.

### Disposing of your old appliance

Electrical and electronic appliances often contain valuable materials. They also contain specific materials, compounds and components, which were essential for their correct function and safety. These could be hazardous to human health and to the environment if disposed of with your domestic waste or if handled incorrectly. Please do not, therefore, dispose of your old appliance with your household waste.



Please dispose of it at your local community waste collection / recycling centre for electrical and electronic appliances. You are also responsible for deleting any personal data that may be stored on the appliance prior to disposal. Please ensure that your old appliance poses no risk to children while being stored prior to disposal.

## Warning and Safety instructions

---

This washing machine complies with all current local and national safety requirements. However, inappropriate use can lead to personal injury and damage to property.

Read the operating instructions carefully before using the washing machine. They contain important information on safety, installation, use and maintenance of the appliance. This prevents both personal injury and damage to the washing machine.

In accordance with standard IEC 60335-1, Miele expressly and strongly advises that you read and follow the instructions in “Installation”, as well as in the “Warning and Safety instructions”.

Miele cannot be held liable for injury or damage caused by non-compliance with these instructions.

Keep these operating instructions in a safe place and pass them on to any future owner.

When instructing other people how to use the washing machine, they must be made aware of these Warning and Safety instructions.

### Correct application

- ▶ The washing machine is only suitable for washing fabrics with a care label stating that they are suitable for machine washing. Any other applications may be dangerous. The manufacturer cannot be held liable for damage resulting from incorrect or improper use or operation of the machine.
- ▶ This washing machine must be used as described in the operating instructions and must be checked on a regular basis to make sure it is functioning correctly. Maintenance must be carried out when necessary.
- ▶ The washing machine is not suitable for outdoor use.
- ▶ This washing machine is intended for commercial use in small businesses, care homes, sports clubs, hospitals and other similar commercial environments. This machine may also be operated by lay persons in public areas such as laundrettes, communal laundry rooms or similar commercial environment.
- ▶ The PWM908DP is also intended for use in domestic households and in similar residential environments, for example by customers in hotels, motels, bed and breakfasts and other related establishments.



## Warning and Safety instructions

---

- ▶ This washing machine is not intended for use by persons (including children) with reduced physical, sensory or mental capabilities, or lack of experience and knowledge, unless they have been given supervision or instruction concerning its use by a person responsible for their safety.
- ▶ Young children must not be allowed to use this appliance.
- ▶ Older children may only use the appliance when its operation has been clearly explained to them and they are able to use it safely. They must be able to understand and recognise the possible dangers caused by incorrect operation.
- ▶ Cleaning or maintenance on the washing machine may only be carried out by older children under the supervision of an adult.
- ▶ Always supervise any children in the vicinity of the washing machine. Never allow children to play with the washing machine.
- ▶ Disinfection programmes must not be interrupted, as this can have a limiting effect on the disinfection result. It is the operator's responsibility to ensure that the standard of disinfection in thermal as well as chemo-thermal procedures is maintained by carrying out suitable validation tests.

# Warning and Safety instructions

---

## Technical safety

▶ Before installing and operating the washing machine, check it for any visible exterior damage. Do not set up or use a damaged washing machine.

▶ The electrical safety of this washing machine can only be guaranteed when continuity is complete between it and an effective earthing system which complies with current local and national safety regulations.

It is most important that this basic safety requirement is present and regularly tested and, when there is any doubt, the on-site wiring system should be inspected by a qualified electrician.

Miele cannot be held liable for the consequences of an inadequate earthing system (e.g. electric shock).

▶ Unauthorised repairs could result in unforeseen dangers for the user, for which the manufacturer cannot accept liability. Repairs must only be carried out by a Miele authorised service technician, otherwise any subsequent damage will not be covered by the warranty.

▶ Do not make any alterations to the machine, unless authorised to do so by Miele.

▶ In the event of a fault or for cleaning purposes, the washing machine must be isolated from the electricity supply. It is only completely isolated if:

- it is switched off at the wall socket and the plug is withdrawn, or
- the mains fuse is disconnected, or
- it is switched off at the mains circuit breaker.

For further information see “Installation - Electrical connection”.

## Warning and Safety instructions

---

- ▶ If the electrical connection cable is faulty, it must only be replaced by a Miele authorised service technician to protect the user from danger.
- ▶ The washing machine must be connected to the water supply using the new hose set supplied with the appliance. Old hose sets should not be re-used. Check the hose regularly for signs of wear. Replace it in good time to avoid the risk of leaks and water damage.
- ▶ Faulty components must only be replaced by genuine Miele original spare parts. Miele can only guarantee the safety standards of the machine when Miele replacement parts are used.
- ▶ Do not connect the machine to the mains electricity supply by a multi-socket adapter, extension lead or similar. These do not guarantee the required safety of the machine (fire hazard due to the risk of overheating).
- ▶ The machine must not be installed and operated in mobile locations (e.g. on a ship).
- ▶ Please observe the instructions in “Installation” and “Technical data”.
- ▶ If the washing machine is equipped with a mains plug, it must be easily accessible after installation so that the machine can be disconnected from the electricity supply if necessary.

## Warning and Safety instructions

---

- ▶ If the appliance is hard wired, an on-site dual circuit breaker must be accessible at all times in order to disconnect the washing machine from the mains supply. The means of disconnection must be incorporated in the fixed wiring in accordance with the wiring rules.
- ▶ This washing machine is supplied with a special lamp to cope with particular conditions (e.g. temperature, moisture, chemical resistance, abrasion resistance, and vibration). This special lamp must only be used for the purpose for which it is intended. It is not suitable for room lighting. Replacement lamps may only be installed by a Miele authorised technician or by Miele.
- ▶ Temporary or permanent operation with a self-sufficient or non-mains synchronous energy supply system (e.g. isolated networks, back-up systems) is possible. A requirement for the operation is that the energy supply system complies with all current local and national requirements that apply to stand-alone, solar and/or battery systems. The protective measures provided in the building installation and in this Miele product must also be assured in their function and operation in isolated operation or in non-mains synchronous operation, or replaced with equivalent measures in the installation. For example, as described in the current publication of VDE-AR-E 2510-2.

### Correct use

- ▶ The maximum load is 8.0 kg (dry laundry). See the “Programme chart” for the maximum recommended loads for individual programmes.
- ▶ Do not install your washing machine in a room where there is a risk of frost. Frozen hoses may burst or split, and the reliability of the electronic control unit may be impaired at temperatures below freezing point.
- ▶ Before using the machine for the first time, check that the transit bars at the rear of the washing machine have been removed (see “Installation and connection – Removing the transit bars”). During spinning, transit bars which are still in place can cause damage to both the machine and adjacent furniture or appliances.
- ▶ Turn off the tap if the machine is to be left for any length of time (e.g. while on holiday), especially if there is no floor drain (gully) in the immediate vicinity.
- ▶ If the ventilation openings are in the base of the washing machine, ensure that they are not obstructed by deep-pile carpet or similar.

## Warning and Safety instructions

---

- ▶ **Danger of flooding!** If hooking the drain hose into a laundry washtub, check that the water can drain away fast enough to prevent the laundry tub from overflowing. Secure the drain hose against slipping. The force of the water flowing out of the hose can dislodge it.
- ▶ Make sure that no foreign objects (e.g. nails, pins, coins, paper clips) find their way into the machine with the laundry. Foreign objects can damage components of the machine (e.g. suds container, drum). Damaged components can, in turn, result in damage to the laundry.
- ▶ If the correct amount of detergent is dispensed, the machine should not need to be descaled. If, however, you do wish to descale it, only use special non-corrosive descaling agents and strictly observe the instructions on the packaging. Special descaling agent is available from your Miele dealer or from Miele. Strictly observe the instructions for the packaging.
- ▶ For textiles that have been treated with solvent-based cleaning agents, always check whether they can be washed in a washing machine. To check whether this is possible, refer to safety notes, information concerning the product's environmental compatibility, and other information.
- ▶ Never use solvent-based detergents, e.g. those containing benzene, in this washing machine. This may result in damage to component parts and create toxic fumes. Risk of fire and explosion!
- ▶ Gasoline, petroleum, kerosene, paraffin, or any easily flammable liquid must not be stored or used near the washing machine. Risk of fire and explosion!
- ▶ Only use dyes suitable for use in a washing machine. Always observe the manufacturer's instructions carefully.
- ▶ Dye removers contain sulphur compounds which can cause damage such as corrosion. Dye removers must not be used in the washing machine.
- ▶ Avoid contact between stainless steel surfaces (front, lid, casing) and liquid detergents or disinfecting agents which contain chlorine or sodium hypochlorite. These agents can cause corrosion on stainless steel. Aggressive vapours containing chlorine can also be corrosive. Do not store open containers of these agents near the machine.
- ▶ Do not use a high-pressure cleaner or water jet to clean the washing machine.

## Warning and Safety instructions

---

- ▶ It is particularly important to observe the manufacturer's instructions when using a combination of cleaning agents and special application products. Products must only be used for applications approved by the manufacturer to avoid any material damage or the occurrence of strong chemical reactions.
- ▶ If detergent has come into contact with the eyes, rinse out immediately with plenty of lukewarm water. If detergent has accidentally been ingested, seek medical advice immediately. People with damaged or sensitive skin should avoid contact with detergent.
- ▶ When adding or removing laundry during the main wash, your skin may come into contact with detergent, particularly if the detergent is dispensed externally. Take care when placing your hands inside the drum. If suds have come into contact with the skin, rinse off immediately with lukewarm water.

### Accessories

- ▶ Only use genuine Miele spare parts and accessories with this machine. Using spare parts or accessories from other manufacturers will invalidate the warranty, and Miele cannot accept liability.
- ▶ Miele tumble dryers and Miele washing machines can be installed as a washer-dryer stack. This requires a Miele washer-dryer stacking kit which can be purchased separately. Please ensure that the washer-dryer stacking kit is suitable for your Miele tumble dryer and your Miele washing machine.
- ▶ If installing the machine on a Miele plinth (available as an optional accessory), please make sure you order the correct one for this washing machine.
- ▶ Miele will guarantee to supply functional spare parts for a minimum of 10 years and up to 15 years following the discontinuation of your washing machine.

Miele cannot be held liable for damage caused by non-compliance with these Warning and Safety instructions.

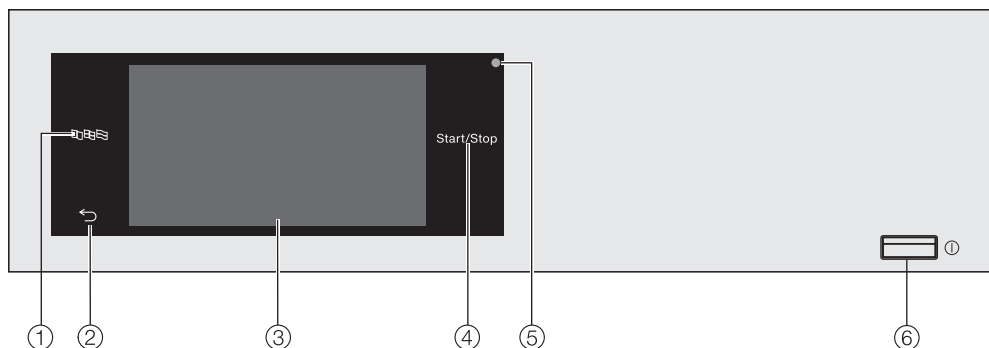

## Control panel



- ① **Language sensor**  
For selecting the current user language.  
The operator language is displayed again at the end of the programme.
- ② **↶ sensor**  
Takes you back one level in the menu.
- ③ **Touch display**
- ④ **Start/Stop sensor control**  
For starting the selected programme and cancelling a programme that has already started. The programme selected can be started as soon as the sensor starts flashing.
- ⑤ **Optical interface**  
For service technicians.
- ⑥ **⏻ Button**  
For switching the washing machine on and off. To save energy, the washing machine will switch off automatically. This occurs 15 minutes after the end of a programme/anti-crease phase, or after being switched on if no further selection is made.

# Operating the washing machine

## Sensor controls and touch display with sensor controls

The ,  and *Start/Stop* sensors and the sensor controls in the display react to finger contact. Every touch of a sensor is confirmed by an audible tone. You can adjust the volume of the keypad tone or switch it off (see “Supervisor level”).

The control panel with the sensor controls and the touch display can be scratched by pointed or sharp objects, e.g. pens.  
Only touch the display with your fingers.

## Main menu

After switching on the washing machine, the main menu will appear in the display.

You can access all important submenus from the main menu.

Touch the  sensor at any time to return to the main menu. Values that have not yet been confirmed with the OK sensor are not saved when you return to the main menu.

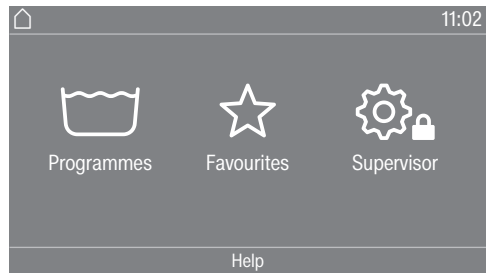

### Programmes

For selecting wash programmes.

### Favourites

For selecting one of 12 favourite wash programmes which can be set up and saved by the operator (see “Supervisor level - Favourite programmes”).

### Supervisor

At the Supervisor level you can alter the washing machine's electronics to suit changing requirements (see “Supervisor level”).



# Operating the washing machine

## Examples on how to operate the appliance

### Selection lists

#### Programme menu (single selection list)

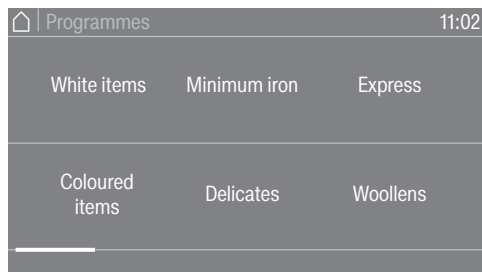

You can scroll to the right or the left by swiping your finger across the screen. To do this, place your finger on the touch display and swipe it in the direction you want.

The orange bar under the pictures shows that there are further options to choose from.

Touch a programme name to select a wash programme.

The display will change to the standard display for that programme.

#### Extras menu (multiple selection)

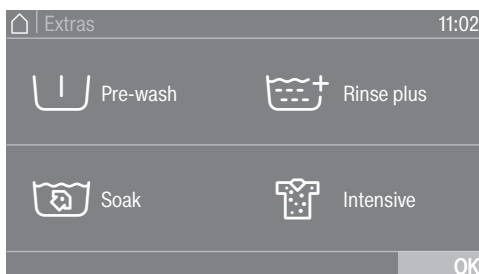

Touch one or several *Extras* to select them.

Currently selected *Extras* are marked orange.

To deselect an *Extra*, simply touch the *Extra* again.

Use the *OK* sensor to activate the selected *Extras*.

### Setting numerical values

You can set numerical values in some menus.

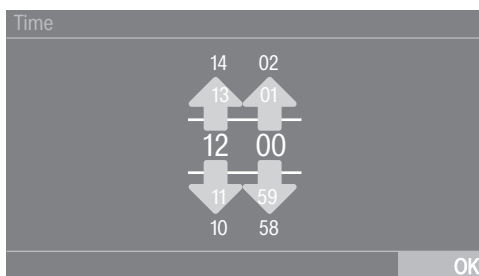

Enter the numbers by swiping upwards or downwards. Place your finger on the number that you want to change and move your finger in the desired direction. Use the *OK* sensor to accept the set numerical value.

**Useful tip:** With some settings, a value can also be entered using a numerical keypad.

# Operating the washing machine

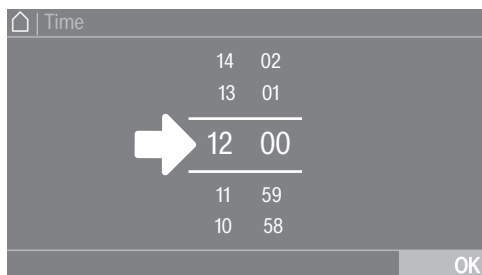

Briefly touching the number between the two lines will bring up the numerical keypad.

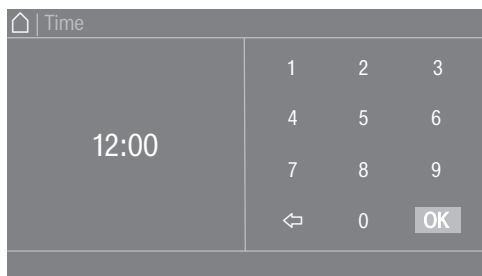

Once a valid number has been entered, the *OK* sensor will be highlighted green.

## Pull-down menu

The pull-down menu can be used to display information, e.g. about a wash programme.

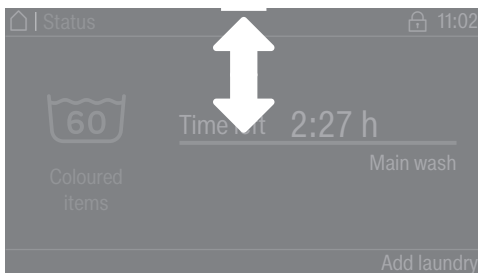

If an orange bar appears at the top of the screen in the middle of the display, you can open the pull-down menu. Touch the bar and drag it down with your finger on the display.

## Exiting a menu

- Touch the  sensor to return to the previous screen.

Entries you have made before this which have not yet been confirmed with *OK* will not be saved.

## Help display

With some menus *Help* appears in the bottom line of the display.

- Touch the *Help* sensor to display the text.
- Touch the *Close* sensor to return to the previous screen.

## Operating the launderette version

The entry menu will vary depending on the programming status (see "Supervisor level - Controls").

Shortcuts are the easiest way to operate the machine. Operators cannot change the preset programmes.

### Launderette, basic

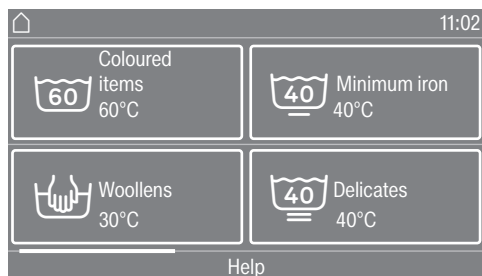

A maximum of 12 programmes can be selected.

Depending on the setting at Supervisor level, the programmes can be displayed with or without a border.

### Launderette Logo

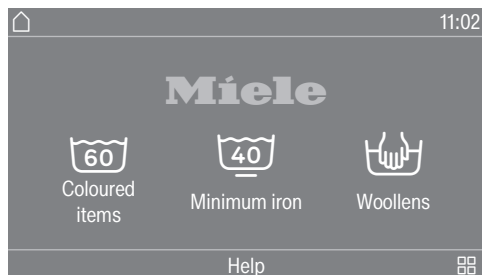

The first 3 programmes can be selected directly. Up to 9 more programmes can be selected from the list .

## Using for the first time

 Damage resulting from incorrect installation and connection. Installing and connecting the washing machine incorrectly will cause serious damage to property. Please observe the instructions in “Installation and connection”.

### Emptying the drum

A swivel elbow for the drain hose and/or assembly material may be stored in the drum.

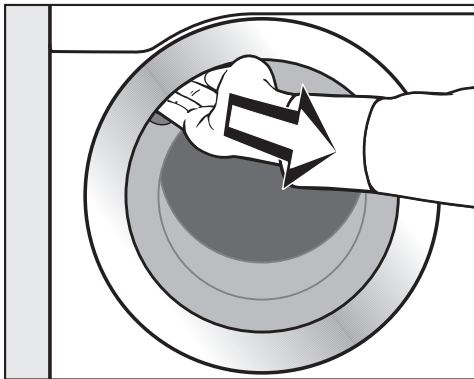

- Pull open the door.
- Remove the swivel elbow and assembly material.
- Shut the door with a gentle swing.

### Switching on the washing machine

- Press the  button.

The welcome screen will light up.

When commissioning the washing machine for the first time, you will have to define the settings for the daily use of the appliance. Some settings can only be configured during the initial commissioning process. After that, they must be changed by Miele.

Complete the initial commissioning process.

These settings are also described in “Supervisor level”.

**Useful tip:** During initial commissioning, you can go back to the previous screen if you need to correct an entry you have already made.

- Touch the  sensor to return to the previous screen.

### Setting the display language

You will be asked to select the language for the display. You can change the language at any time (see “Supervisor level - Language”).

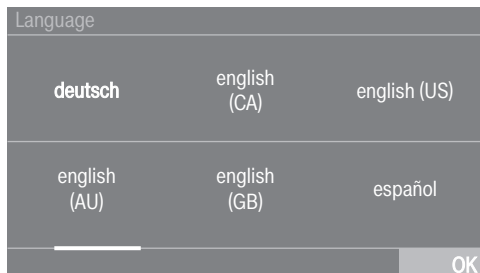

- Scroll to the left or the right until the language you want appears.
- Touch the sensor for the required language.

The selected language will be highlighted in orange and the display will change to the next setting.

## Reference to external appliances

A reference to external hardware appears.

- Confirm with the OK sensor.

Before initial commissioning, connect the XCI box or adapter or slide a communication module into the slot on the back of the machine. The washing machine must be disconnected from the mains for this purpose. Then start the commissioning process.

## Setting the brightness of the display

You will be asked to set the brightness of the display.

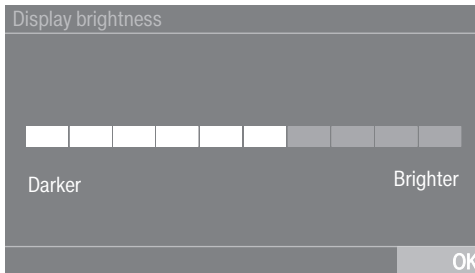

- Touch the segment bar until you reach the required level of brightness.

The selected brightness level will be highlighted orange.

- Confirm with *OK*.

The display will change to the next setting.

## Setting the date

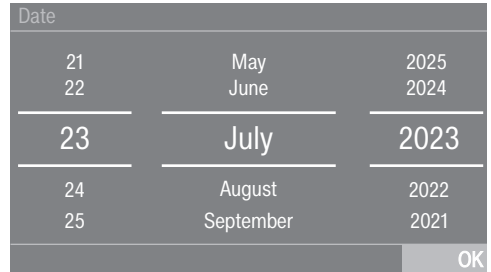

- Place your finger on the number to be changed and move your finger in the desired direction.
- When all values have been set, confirm with the *OK* sensor.

The display will change to the next setting.

## Confirming the time query

The following query will appear in the display:

Should the clock display not be shown?

- Touch the *yes* or *no* sensor.

If you select *yes*, the system will skip the Time setting.

If you select *no*, the display will switch to the Time setting.

# Using for the first time

## Setting the time of day

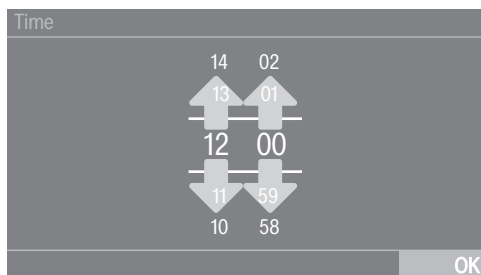

- Place your finger on the number that you want to change and move your finger in the desired direction.
- Confirm with the *OK* sensor.

The display will change to the next setting.

## Selecting programme packages

You can select various programmes from the programme packages. Any programmes already active are marked in orange.

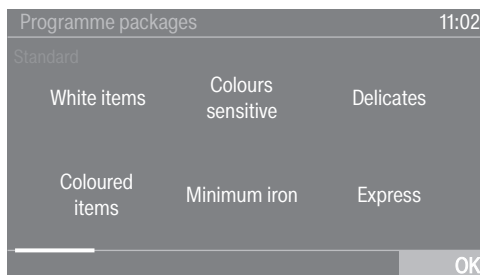

- Scroll right until you reach a programme that is not marked in orange.
- Touch the sensor for the desired programme.

The selected programme will be marked in orange.

- You can select further programmes.

**Useful tip:** You can deactivate a selected programme by touching the programme's sensor again.

- If you do not want to select any more programmes, confirm with the *OK* sensor.

The display will change to the next setting.

## Switching on automatic dispensing

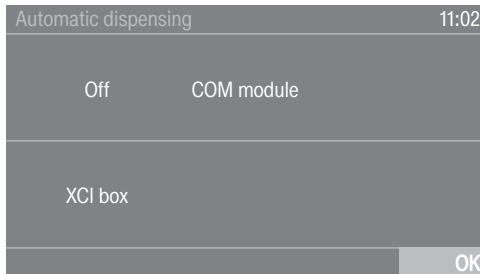

- Touch the COM module or XCI box sensor if you want to dispense detergent externally.
- Confirm with the *OK* sensor.

The display will change to the next setting.

## Setting up a payment system

If you wish to set up a payment system, read the chapter “Supervisor level - Payment system”.

These settings can only be changed during the initial commissioning process. If you wish to change the settings later, please contact Miele.

If you do not wish to set up a payment system, you can skip this step.

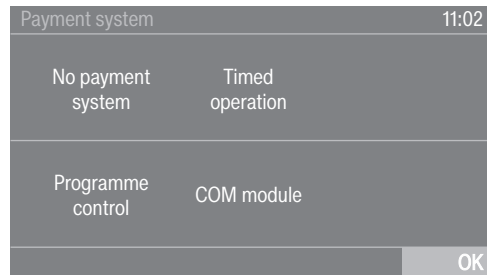

- Touch the No payment system sensor.

The display will change to the next setting.

## Using for the first time

### Selecting pre-wash water

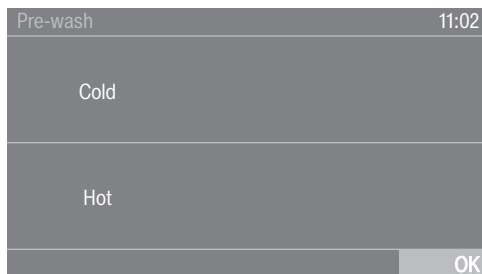

- Touch the **Cold** sensor if the washing machine is only connected to the cold water supply, or touch **Hot** if the washing machine is connected to both cold and hot water.

The display will change to the next setting.

### Selecting main wash water

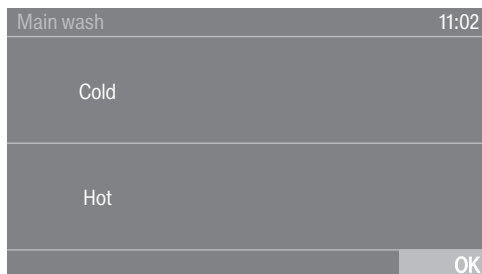

- Touch the **Cold** sensor if the washing machine is only connected to the cold water supply, or touch **Hot** if the washing machine is connected to both cold and hot water.

Further information will appear in the display.

### Removing the transit bars.

The display will remind you to remove the transit bars.

 **Damage resulting from failure to remove the transit bars.**  
Failure to remove the transit bars can result in damage to the washing machine and to adjacent cabinetry or appliances.  
Remove the transit bars as described in “Installation”.

- Confirm that the transit bars have been removed with the **OK** sensor.

The following appears in the display: To complete commissioning, start the “Commissioning” programme without laundry

- Confirm the message with the **OK** sensor.



### Completing the commissioning process

To complete commissioning, the commissioning programme must be run without laundry and without detergent.

If the power is interrupted (e.g. if the machine is switched off with the ① control), the initial commissioning process can be carried out again. If the commissioning programme has run through to the end, the initial commissioning process does not have to be performed again.

- Turn on the water taps.
- Touch the flashing *Start/Stop* sensor.
- Once the programme has finished, switch the washing machine off briefly and then switch it back on again.

The appliance is now ready for use.

# 1. Preparing the laundry

## Emptying all pockets

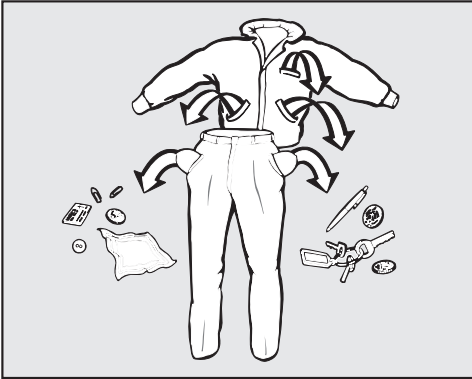

- Empty all pockets.

⚠ Damage due to foreign objects.

Foreign objects (e.g. nails, coins, paper clips etc.) can cause damage to garments and to components in the machine.

Check the laundry before washing and remove any foreign objects.

## Sorting the laundry

- Sort the laundry by colour and by care label. Most garments have a textile care label in the collar or side seam.

## Pre-treating stains

- Clean badly soiled areas and stains on the textiles before washing. Spillages should be carefully dabbed off using a soft, colourfast cloth.

⚠ Damage due to solvent-based cleaning agents.

Cleaning agents containing benzene, stain remover, etc., can damage plastic parts.

When pre-treating garments, make sure that any plastic parts (e.g. buttons) do not come into contact with cleaning agent.

⚠ Risk of explosion due to solvent-based cleaning agents.

If solvent-based cleaning agents are used, an explosive mixture can form. Never use solvent-based cleaning agents in the washing machine.

## General tips

- Do not wash any items in this machine which are specified by the manufacturer as **not washable** on the care label (☒ symbol).
- Curtains: Remove lead weights first or place in a laundry bag.
- Remove or sew in any loose underwiring in bras or shirt collar stiffeners.
- Turn garments inside out, if recommended by the manufacturer.
- Close any zips and Velcro fasteners before washing.
- Fasten duvet covers and pillow cases to prevent small items from being rolled up inside them.
- Please refer to the Programme chart for more tips.

## 2. Loading the washing machine

### Opening the door

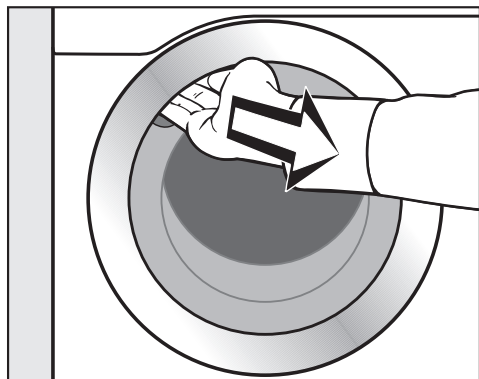

- Reach under the door grip and pull the door open.

Check the drum for pets or foreign objects before loading it with laundry.

- Unfold the laundry and load loosely in the drum.

Mixing both large and small items gives better wash results and helps distribute the load evenly during spinning.

The most efficient use of energy and water is achieved when a full load is washed. However, do not overload as this reduces cleaning efficiency and causes creasing.

### Closing the door

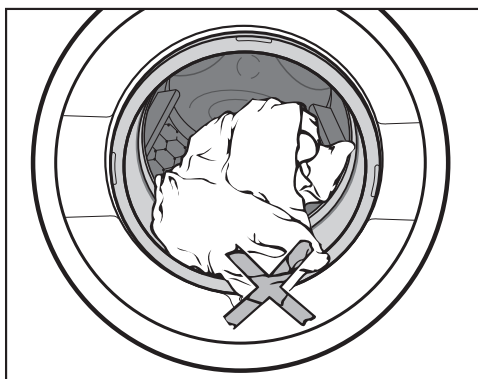

- Make sure that no items are caught between the door and the seal.

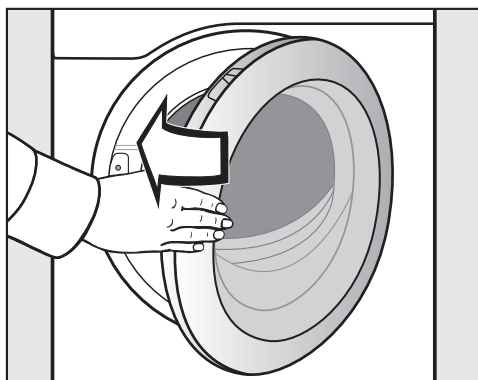

- Shut the door with a gentle swing.

### 3. Selecting a programme

#### Switching on the washing machine

- Press the ⓘ button.

The interior drum lighting will come on.

The drum lighting will go out automatically after five minutes or after the programme start.

#### Selecting a programme

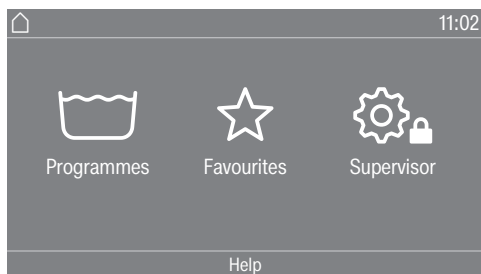

There are different ways to select a programme.

You can select a programme from the Programmes menu.

- Touch the Programmes sensor.

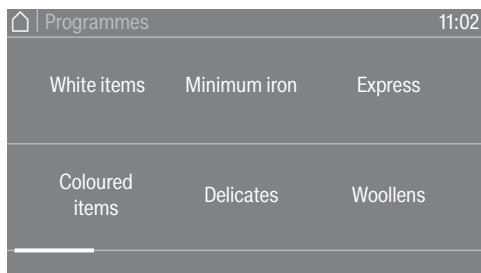

- Scroll to the right of the display until the programme you want appears.
- Touch the sensor for that programme.

The display will change to the standard menu for that wash programme.

Alternatively, you can select a programme from the Favourites menu.

The programmes under Favourites can be changed by the operator (see “Supervisor level - Favourite programmes”).

- Touch the Favourites sensor.

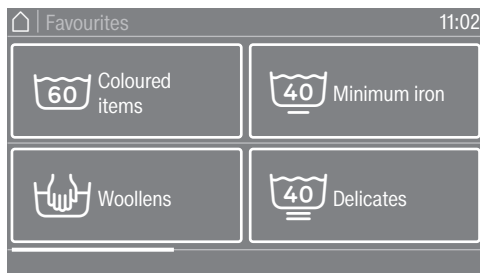

- Scroll to the right of the display until the programme you want appears.
- Touch the sensor for that programme.

The display will change to the standard menu for that wash programme.

With Favourite programmes, the majority of the programme settings are preset and cannot be changed.

## 4. Selecting programme settings

### Selecting the load

To enable load specific dispensing, you can specify the load for some programmes.

- Touch the *Weight* sensor.
- Enter a valid value for the load quantity.

The display will change to show the *Overview* menu.

### Selecting the temperature

You can alter the preset temperature of the wash programme.

- Touch the *Temperature* sensor.
- Select the desired temperature.

The display will change to show the *Overview* menu.

### Selecting a spin speed

You can alter the preset spin speed of the wash programme.

- Touch the *Spin speed* sensor.
- Select the desired spin speed.

The display will change to show the *Overview* menu.

### Selecting Extras

You can select Extras for some wash programmes.

- Touch the *Extras* sensor.
- Select one or more Extras.
- Confirm with the *OK* sensor.

The display will change to show the *Overview* menu.

See “Extras” for further information.

### Activating CapDosing

You can use CapDosing for some wash programmes.

- Touch the *CapDosing* sensor.

The types of capsules which can be used with the programme will be shown in the display.

- Select the type of capsule you want to use.

CapDosing is now active.

The display will change to show the *Overview* menu.

See “5. Adding detergent - CapDosing” for more information.

## 5. Adding detergent

There are several options for adding detergent.

### Detergent dispenser drawer

Any detergent suitable for automatic front loading washing machines can be used with this appliance.

### Detergent dispensing

Please follow the detergent manufacturer's instructions in relation to dosage.

Adding too much detergent will lead to excessive foaming.  
Avoid adding excess detergent.

The amount to dispense will depend on:

- the amount of laundry
- the degree of soiling of the laundry
- the water hardness



Water hardness range	Hardness in mmol/l	German scale °dH
soft (I)	0-1.5	0-8.4
medium (II)	1.5-2.5	8.4-14
hard (III)	above 2.5	above 14

Check with your local water supplier if you do not know the water hardness in your area.

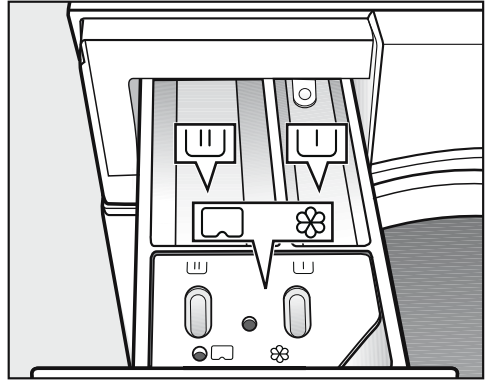

### Adding detergent





- Pull out the detergent dispenser drawer and add detergent to the compartments.

 Detergent for the pre-wash (divide the total recommended amount as follows:  $\frac{1}{3}$  to compartment  and  $\frac{2}{3}$  to compartment )

 Detergent for the main wash

 /  Fabric softener, liquid starch or capsules

For disinfection programmes, the  and  compartments can be filled with detergent for the main wash if you have not selected Pre-wash.

## 5. Adding detergent

### Adding fabric softener or liquid starch separately

- Select the *Separate rinse* programme.
- Change the spin speed if necessary.

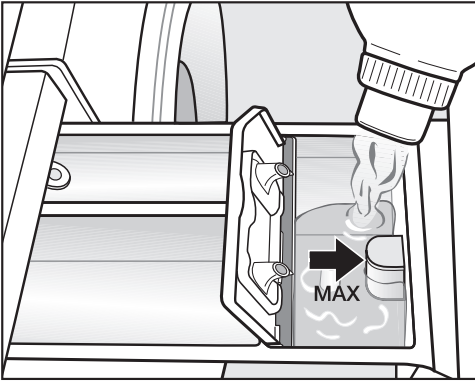

- Add the fabric softener or the liquid starch to the ☼ compartment. **Do not exceed the maximum level mark.**
- Touch the *Start/Stop* sensor.

This will be automatically dispensed in the final rinse. At the end of the wash programme a small amount of water remains in the ☼ compartment.

### Adding starch separately

- Prepare the starch solution in accordance with the manufacturer's instructions on the packaging.
- Select the *Starch* programme.
- Add the prepared starch to the ☼ compartment.
- Touch the *Start/Stop* sensor.

**Useful tip:** If starching separately or automatically, thoroughly clean the detergent dispenser compartment, especially the siphon, regularly.

### Dye removers and dyes

⚠ Damage due to colour run/dye removers.

Colour run and dye removers can cause corrosion in the washing machine.



Do not use colour run or dye removers in this washing machine.

Only use dyes suitable for use in a washing machine. The manufacturer's instructions on the packaging must be observed.

## 5. Adding detergent

### CapDosing

Three different types of capsules are available:

-  = Fabric care (e.g. fabric softener, proofing agent)
-  = Additives (e.g. detergent enhancers)
-  = Detergent (for the main wash only)

Only one capsule can be selected per wash programme.

Depending on the setting selected, the detergent, additive, or fabric care agent will be dispensed via the capsule for this wash programme.

Each capsule contains the correct amount for one wash cycle.

Capsules are available to order from Miele or from the Miele online shop (see the end of this booklet for contact details).

-  Capsules pose a health risk. The ingredients of capsules can be hazardous to health if they are swallowed or come into contact with skin. Keep capsules out of the reach of children.

### Activating CapDosing

- Touch the CapDosing sensor.

The types of capsules that can be used with the programme will appear in the display.

- Select the type of capsule you want to use.



CapDosing is now active.

The display switches to the default display and shows the selected capsule.

### Inserting a capsule

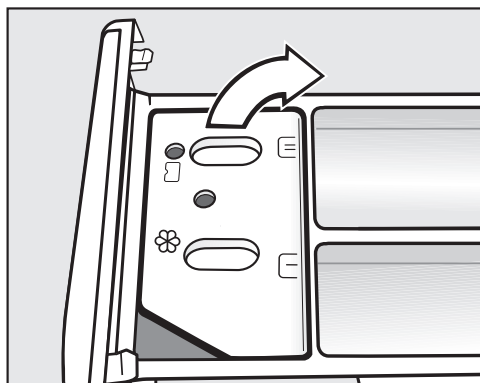
- Open the detergent dispenser drawer.



- Open the lid of the /  compartment.

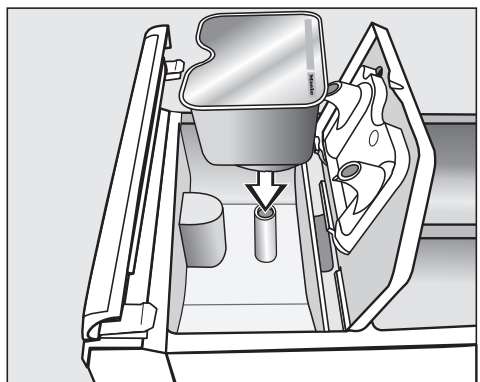

- Press the capsule in firmly.



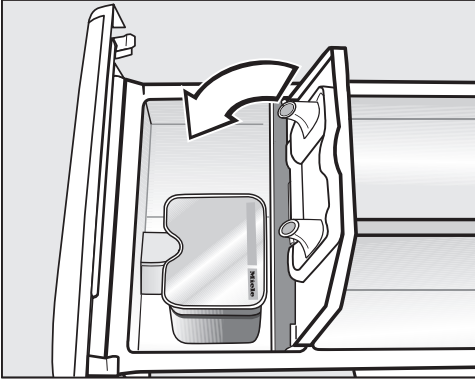

## 5. Adding detergent



- Close the lid and press it firmly shut.
- Close the detergent dispenser drawer.

The capsule is opened by the act of inserting it in the detergent dispenser compartment. The contents can run out of the capsule if you remove it before it has been used. Dispose of opened capsules.

The wash programme will dispense the contents of the capsule at the correct time.

Water intake to the  compartment is solely via the capsule. When using capsules do not add fabric softener to the  compartment.

- Remove the empty capsule at the end of the wash programme.

For technical reasons a small amount of water will remain in the capsule.

### Deactivating or changing CapDosing

CapDosing can only be deactivated or changed prior to programme start.

- Touch the CapDosing sensor control and disable the selected capsule option.

### External dispensing

The washing machine is pre-equipped for connection to an external detergent dispensing system. A separate conversion kit for external dispensing systems is required. This must be fitted by a Miele authorised service technician.

## 6. Starting the programme - the end of the programme

### Payment system

If your machine is connected to a payment system, the amount of payment required will appear in the display.

Do not cancel the programme once it has started. Depending on the settings, credit added in the payment system may be lost when the programme is cancelled.

### Starting a programme

The programme can be started once the *Start/Stop* sensor is flashing on and off.

- Touch the *Start/Stop* sensor.

The door will lock (🔒 symbol) and the wash programme will start.

If a delay start time has been selected, this will count down in the display until the programme starts.

At the end of the delay start time or immediately after the programme has started, the programme duration will appear in the display. The programme sequence is also shown in the display.

**Useful tip:** You can use the pull-down menu to display the selected temperature, spin speed, and any selected Extras.

### At the end of the programme

The door remains locked during the anti-crease phase. However, the door can be unlocked at any time by touching the *Start/Stop* sensor.

### Removing the laundry

- Pull open the door.
- Remove the laundry.

Items left in the drum could discolour other items in the next wash or become discoloured themselves. Remove all items from the drum.

- Check the folds in the door seal for any small articles, e.g. buttons, which might be lodged there.

**Useful tip:** For safety reasons, close the door when the washing machine is not in use. Otherwise there is a danger of objects being placed inadvertently in the drum. If these remain unnoticed and were washed in the next load, they could damage the laundry. An open door is also a danger to pets and children.

- Switch the washing machine off with the Ⓜ button.
- If applicable, remove the used capsule from the detergent dispenser drawer.

**Useful tip:** Leave the detergent dispenser drawer slightly open to allow it to dry.



The Timer can be used to select the time at which a programme starts or finishes.

## Setting the Timer

- Touch the  Timer sensor.
- Select the Finish at, Start in or Start at option.
- Set the hours and the minutes and confirm your entry with the *OK* sensor.



## Changing the Timer

The selected delay start time can be changed before the programme starts.

- Touch the ,  or  sensor.
- Change the time set and confirm with the *OK* sensor.

## Deleting the Timer

The selected delay start time can be cancelled before the programme starts.

- Touch the ,  or  sensor.

The selected delay start time will appear in the display.

- Touch the *Delete* sensor.
- Confirm with the *OK* sensor.

The selected delay start time is deleted.

## Starting the Timer

- Touch the *Start/Stop* sensor.





The door will lock and the time remaining until the programme starts will appear in the display.

After the programme has started, the selected time can only be changed or cancelled by interrupting the programme.

The programme can be started immediately at any time.

- Touch the *Start immediately* sensor.

# Programme chart

<b>Cottons</b>   <b>Max. load 8.0 kg</b>		
Items	Normally soiled cotton garments	
Notes	- These settings are the most efficient in terms of energy and water consumption for washing cottons.	
1600 rpm	Extras: Pre-wash, Rinse hold	Rinse cycles: 3
Energy labelling programme according to AS/NZS 2040.1 & AS/NZS 2040.2 for the PWM908DP.		
<b>Cottons</b>   <b>Max. load 8.0 kg</b>		
Items	Cottons, linens or cotton mix fabrics, e.g. table linen, towelling, underwear, T-shirts etc.	
Notes	- With  , the actual wash temperature reached is lower than 60°C although the wash performance is the same as with the standard Cottons 60°C programme.	
1600 rpm	Extras: Pre-wash, Rinse hold	Rinse cycles: 2
<b>Cottons PRO</b> <b>60°C</b> <b>Max. load 8.0 kg</b>		
Items	Mixed fibre textiles (50% cotton and 50% polyester)	
Notes	- Extra energy-efficient wash programme for commercial cotton or cotton/synthetic blend textiles with moderate levels of soiling, e.g. workwear	
1600 rpm	Extras: Pre-wash	Rinse cycles: 2

## Programme packages

You can select various programmes from the programme packages. The programmes will be displayed in the programme list.

### Standard programmes

<b>Cottons</b>			<b>65°C to 90°C</b>			<b>Max. load 8.0 kg</b>		
Items	Cottons and linens, e.g. bed linen, table linen, towelling, underwear, baby clothes							
Tip	An additional pre-rinse can be programmed.*							
1600 rpm	Extras: Pre-wash, Intensive, Water plus, Rinse hold, Starch						Rinse cycles: 1-5*	
<b>Cottons</b>			<b>Cold to 60°C</b>			<b>Max. load 8.0 kg</b>		
Items	Cotton or mixed fibre textiles, e.g. T-shirts, trousers							
Notes	<ul style="list-style-type: none"> <li>- For dark coloured fabric use a colour detergent or liquid detergent.</li> <li>- An additional pre-rinse can be programmed.*</li> </ul>							
1600 rpm	Extras: Pre-wash, Intensive, Water plus, Rinse hold, Starch						Rinse cycles: 1-5*	
<b>Colours sensitive</b>			<b>Cold to 90°C</b>			<b>Max. load 8.0 kg</b>		
Items	Cotton or mixed fibre textiles							
Tip	Coloured items programme for all temperature ranges with particularly good rinsing efficiency.							
1600 rpm	Extras: Pre-wash, Intensive, Water plus, Rinse hold, Rinse plus, Starch stop						Rinse cycles: 2	
<b>Minimum iron</b>			<b>Cold to 60°C</b>			<b>Max. load 4.0 kg</b>		
Items	Synthetic, mixed fibre and easy care cotton fabrics							
Notes	<ul style="list-style-type: none"> <li>- Reduce the final spin speed for fabrics which crease easily.</li> <li>- An additional pre-rinse can be programmed.*</li> </ul>							
1200 rpm	Extras: Pre-wash, Intensive, Water plus, Pre-ironing, Rinse hold						Rinse cycles: 2-4*	

\* Settings can be altered in the Supervisor level.

## Programme chart

<b>Delicates</b>		<b>Cold to 60°C</b>	<b>Max. load 3.0 kg</b>
Items	Delicate garments made from synthetic fibre, mixed fibre, rayon and viscose		
Tip	- Deselect the final spin speed for fabric that creases easily.		
600 rpm	Extras: Pre-wash, Rinse plus, Pre-Ironing, Rinse hold	Rinse cycles: 2	
<b>Express</b>		<b>Cold to 60°C</b>	<b>Max. load 4.0 kg</b>
Items	Cotton garments that have hardly been worn or are only very lightly soiled		
1400 rpm	Extras: Rinse plus	Rinse cycles: 1	
<b>Woollens</b>		<b>Cold to 40°C</b>	<b>Max. load 3.0 kg</b>
Items	Machine-washable woollens and woollen blends		
Notes	Use detergent formulated for woollens.		
1200 rpm	Extras: Rinse hold	Rinse cycles: 2	
<b>Bedding and towelling</b>		<b>40°C to 60°C</b>	<b>Max. load 8.0 kg</b>
Items	Towels and bathrobes made from terrycloth		
Notes	Use a colour detergent for dark textiles.		
1400 rpm	Extras: Pre-wash, Rinse hold	Rinse cycles: 2	
<b>Shirts</b>		<b>Cold to 60°C</b>	<b>Max. load 3.0 kg</b>
Items	Shirts and blouses		
Notes	<ul style="list-style-type: none"> <li>- Pre-treat collars and cuffs if necessary.</li> <li>- Wash silk shirts and blouses in the Silks programme.</li> <li>- Reduce the maximum load quantity by half if you have selected the <i>Pre-ironing</i> Extra.</li> </ul>		
800 rpm	Extras: Soak, Rinse plus, Pre-ironing, Rinse hold, Starch	Rinse cycles: 2	
<b>Dark garments</b>		<b>30°C to 60°C</b>	<b>Max. load 4.0 kg</b>
Items	Black and dark garments made from cotton or mixed fibres		
Notes	Wash inside out.		
1000 rpm	Extras: Soak, Rinse plus, Pre-ironing, Rinse hold	Rinse cycles: 3	

## Programme chart

<b>Denim</b>		<b>30°C to 60°C</b>	<b>Max. load 4.0 kg</b>
Items	Denim shirts, blouses, trousers, skirts and jackets		
Notes	<ul style="list-style-type: none"> <li>- Wash denim inside out.</li> <li>- Denim often contains excess dye and may run during the first few washes. Wash light and dark coloured items separately.</li> </ul>		
1000 rpm	Extras: Rinse hold	Rinse cycles: 3	
<b>Silks</b>		<b>Cold to 30°C</b>	<b>Max. load 3.0 kg</b>
Items	Silks and hand-washable textiles which do not contain wool		
Notes	<ul style="list-style-type: none"> <li>- Observe the instructions on the care label.</li> <li>- Place stockings and bras in a laundry bag.</li> </ul>		
600 rpm	Extras: Rinse plus, Rinse hold	Rinse cycles: 2	
<b>Separate rinse</b>		<b>Max. load 8.0 kg</b>	
Items	Fabrics that only need to be rinsed and spun		
Tip	- Reduce the spin speed for items which crease easily.		
1400 rpm	Extras: Rinse hold	Rinse cycles: 2	
<b>Starch</b>		<b>Cold to 40°C</b>	<b>Max. load 4.0 kg</b>
Items	For starching table cloths, serviettes and workwear		
Notes	<ul style="list-style-type: none"> <li>- Laundry that is to be starched should be washed but not treated with fabric softener.</li> <li>- Reduce the spin speed for items which crease easily.</li> </ul>		
1200 rpm		Rinse cycles: 1	
<b>Clean machine</b>		<b>70°C</b>	<b>No load</b>
	For cleaning the suds container and the drainage system. <ul style="list-style-type: none"> <li>- Add universal detergent to the  compartment.</li> <li>- Use the <i>Clean machine</i> programme regularly if you frequently use disinfection programmes.</li> </ul>		
<b>Drain/Spin</b>		<b>Max. load 8.0 kg</b>	
Notes	<ul style="list-style-type: none"> <li>- Make sure you select the appropriate spin speed.</li> <li>- Drain only: Select 0 rpm for the spin speed.</li> <li>- Select the <i>Rinse plus</i> Extra for one rinse.</li> </ul>		
1600 rpm	Extras: Rinse plus		

## Programme chart

Machine hygiene		No load
	<ul style="list-style-type: none"> <li>- If a programme at a temperature below 60°C has been used, the prompt to start the Maintenance wash hygiene programme will appear in the display. The Hygiene setting must be switched on for this purpose (see “Supervisor level”).</li> <li>- Add universal detergent to the  compartment.</li> </ul>	

### Sport

Sportswear		30°C to 60°C	Max. load 3.5 kg
Items	Sports and leisure wear, such as jersey shirts and trousers made from synthetic fibres or mixed blends		
Notes	<ul style="list-style-type: none"> <li>- If you wish to proof the items at the same time, add the proofing agent to the  compartment in the detergent dispenser drawer.</li> <li>- Do not use fabric softener.</li> <li>- Observe the instructions on the care label.</li> </ul>		
1000 rpm	Extras: Pre-wash, Soak, Rinse hold	Rinse cycles: 2	
SportMicrofibre		30°C to 60°C	Max. load 3.5 kg
Items	Clothing for sport and fitness such as jersey shirts, trousers and base layers made from microfibre		
Notes	<ul style="list-style-type: none"> <li>- Do not use fabric softener.</li> <li>- Observe the instructions on the care label.</li> </ul>		
800 rpm	Extras: Rinse plus, Rinse hold	Rinse cycles: 2	
Trainers		30°C to 60°C	Max. 2 pairs
Items	Trainers (no leather shoes), shin pads, elbow protectors and similar items		
Notes	<ul style="list-style-type: none"> <li>- Do not use fabric softener.</li> <li>- Coarse soiling should be brushed off first.</li> <li>- Observe the instructions on the care label.</li> <li>- Use the drying basket for tumble drying.</li> <li>- Close Velcro fasteners.</li> </ul>		
400 rpm	Extras: Pre-wash, Pre-rinse	Rinse cycles: 3	



# Programme chart

<b>Hard items</b>		<b>Cold to 40°C</b>	<b>Max. load 3.5 kg</b>
Items	Washable plastic items, e.g. toy building blocks or casino chips, or even chain link safety gloves, etc.		
Notes	<ul style="list-style-type: none"> <li>- Use the <i>Soak</i> Extra to loosen dirt.</li> <li>- Use detergent for delicates.</li> </ul>		
–	Extras: Pre-rinse, Pre-wash, Rinse plus	Rinse cycles: 2	

## Outdoor

<b>Down Items</b>		<b>30°C to 60°C</b>	<b>Maximum 1 item</b>
Items	Outdoor jackets, sleeping bags, and other down-filled items		
Notes	<ul style="list-style-type: none"> <li>- Observe the instructions on the care label.</li> <li>- Do not use fabric softener.</li> <li>- Remove any air before washing. To do this, either push the items into a narrow laundry bag to compress them or tie the items together with a washable strap.</li> <li>- The items are spun after wetting to remove any air.</li> </ul>		
1000 rpm	Extras: Pre-rinse, Rinse plus, Rinse hold	Rinse cycles: 2	
<b>Outerwear</b>		<b>Cold to 40°C</b>	<b>Max. load 3.5 kg</b>
Items	Performance outerwear (e.g. outdoor jackets and pants) made from membrane fabrics such as Gore-Tex®, SYMPATEX®, WINDSTOPPER® etc.		
Notes	<ul style="list-style-type: none"> <li>- Close any zips and Velcro fasteners before washing.</li> <li>- Do not use fabric softener.</li> <li>- Use the <i>Proofing</i> programme to treat outerwear textiles occasionally. Proofing after each wash cycle is not recommended.</li> <li>- Wash down-filled items with the <i>Down Items</i> programme</li> </ul>		
1000 rpm	Extras: Pre-rinse, Soak, Rinse plus, Rinse hold	Rinse cycles: 2	

## Programme chart

<b>Proofing</b>		<b>Cold to 40°C</b>	<b>Max. load 3.5 kg</b>
Items	Treating microfibre fabric, ski wear, and table linens/drapes made from mainly synthetic fibres		
Notes	<ul style="list-style-type: none"> <li>- Add proofing agent to the ☒ compartment.</li> <li>- The items should be freshly laundered and spun or dried before proofing.</li> <li>- For best results, the items should be heat-treated afterwards either in a tumble dryer or by ironing.</li> </ul>		
1000 rpm	Extras: Rinse hold	Rinse cycles: 1	

### Wellness/Hair salons

<b>Towels</b>		<b>Cold to 40°C</b>	<b>Max. load 6.0 kg</b>
Items	Lightly soiled cotton towelling		
Notes	Use a colour detergent for dark textiles.		
1400 rpm		Rinse cycles: 2	
<b>Towels plus</b>		<b>40°C to 80°C</b>	<b>Max. load 6.0 kg</b>
Items	Heavily soiled cotton towelling		
Notes	Use a colour detergent for dark textiles.		
1400 rpm	Extras: Pre-wash	Rinse cycles: 2	
<b>Capes</b>		<b>Cold to 30°C</b>	<b>Max. load 2.5 kg</b>
Items	Lightly soiled hairdressers' capes made from synthetic fibres		
Notes	Select the <i>Rinse plus</i> Extra for particularly good wash results		
600 rpm	Extras: Rinse plus	Rinse cycles: 2	

# Programme chart

## Hotel

<b>Bed linen</b>		<b>40°C to 90°C</b>	<b>Max. load 8.0 kg</b>
Items	Cotton or mixed fibre bed linen		
Tip	<ul style="list-style-type: none"> <li>- The items are always soaked after the start.</li> <li>- Use a colour detergent for coloured textiles.</li> </ul>		
1400 rpm	Extras: Pre-wash, Soak, Rinse plus, Pre-ironing	Rinse cycles: 2	
<b>Table linen</b>		<b>40°C to 75°C</b>	<b>Max. load 4.0 kg</b>
Items	Tablecloths and napkins made from cotton, linen, and mixed fibres		
Tip	<ul style="list-style-type: none"> <li>- Select Pre-wash for stubborn stains. Use detergent with enzymes for the pre-wash.</li> <li>- The items are always soaked after the start.</li> </ul>		
1000 rpm	Extras: Pre-wash, Rinse plus, Soak, Intensive, Pre-ironing, Rinse hold, Starch stop	Rinse cycles: 2	
<b>Kitchen laundry</b>		<b>60°C to 85°C</b>	<b>Max. load 8.0 kg</b>
Items	Cotton or linen kitchen laundry, e.g. chef's jackets and pants, chef's hats, cleaning cloths		
Tip	<ul style="list-style-type: none"> <li>- Select Pre-wash for stubborn stains. Use detergent with enzymes for the pre-wash.</li> <li>- A pre-rinse cycle is carried out before the main wash.</li> </ul>		
1200 rpm	Extras: Pre-wash, Soak, Intensive	Rinse cycles: 3	

## Home textiles

<b>Lightweight curtains</b>		<b>Cold to 40°C</b>	<b>Max. load 3.0 kg</b>
Items	Curtains specified as machine-washable by the manufacturer		
Notes	For curtains which crease easily, deselect the spin speed.		
600 rpm	Extras: Pre-wash, Rinse plus, Rinse hold	Rinse cycles: 3	
<b>Curtains</b>		<b>Cold to 40°C</b>	<b>Max. load 3.0 kg</b>
Items	Curtains and drapes specified as machine-washable by the manufacturer		
Notes	For curtains which crease easily, reduce the spin speed or deselect the spin.		
800 rpm	Extras: Pre-wash, Pre-rinse, Rinse hold	Rinse cycles: 3	

## Programme chart

<b>Down bedding</b>			<b>40°C to 75°C</b>	<b>1 duvet</b>
Items	Down-filled duvets			
Tip	<ul style="list-style-type: none"> <li>- Observe the instructions on the care label.</li> <li>- Remove any air before washing. To do this, either push the items into a narrow laundry bag to compress them or tie the items together with a washable strap.</li> <li>- The items are spun after wetting to remove any air.</li> </ul>			
1400 rpm	Extras: Rinse hold		Rinse cycles: 3	
<b>Synthetic bedding</b>			<b>40°C to 75°C</b>	<b>Max. 8.0 kg or 1 duvet</b>
Items	Bed linen made from microfibre and duvets with a synthetic filling			
Notes	<ul style="list-style-type: none"> <li>- Observe the instructions on the care label.</li> <li>- Use liquid detergent.</li> </ul>			
800 rpm	Extras: Pre-wash, Soak, Rinse plus, Rinse hold		Rinse cycles: 2	
<b>Pillows</b>			<b>Cold to 60°C</b>	<b>1–2 pillows*</b>
Items	Washable pillows with a down or synthetic filling			
Notes	<ul style="list-style-type: none"> <li>- Observe the instructions on the care label.</li> <li>- Remove any air before washing. To do this, either push the items into a narrow laundry bag to compress them or tie the items together with a washable strap.</li> <li>- The items are spun after wetting to remove any air.</li> </ul>			
1400 rpm	Extras: Pre-wash		Rinse cycles: 3	
<b>Bedspreads</b>			<b>40°C to 75°C</b>	<b>Max. load 4.0 kg</b>
Items	Synthetic or woollen bedspreads, e.g. day blankets			
Notes	Gentle wash programme for covers with delicate fillings.			
800 rpm	Extras: Pre-rinse, Rinse hold		Rinse cycles: 3	

\* 1 pillow (80 x 80 cm) or 2 pillows (40 x 80 cm)

# Programme chart

## Workwear

<b>Oil/fat special</b>		<b>60°C to 90°C</b>	<b>Max. load 8.0 kg</b>
Items	Work coats, work jackets, hats, cleaning cloths made from cotton or mixed fibres		
Notes	<ul style="list-style-type: none"> <li>- Activate <i>Pre-wash</i> for heavy soiling.</li> <li>- Use special detergent to improve the wash results.</li> </ul>		
1400 rpm	Extras: Pre-wash, Soak, Intensive, Rinse plus, Rinse hold	Rinse cycles: 3	
<b>Dust/flour special</b>		<b>40°C to 90°C</b>	<b>Max. load 8.0 kg</b>
Items	Cotton or mixed fibre workwear, table cloths, or cleaning cloths soiled with dust or flour		
Notes	<ul style="list-style-type: none"> <li>- Select <i>Pre-rinse</i> for very heavy levels of soiling.</li> <li>- Activate <i>Pre-wash</i> for stubborn soiling.</li> </ul>		
1400 rpm	Extras: Pre-wash, Pre-rinse, Soak, Intensive, Rinse plus, Rinse hold	Rinse cycles: 2	
<b>Intensive wash</b>		<b>40°C to 90°C</b>	<b>Max. load 8.0 kg</b>
Items	Heavily soiled workwear made from cotton, linen, and mixed fibres		
Notes	A particularly good wash and rinse result is achieved by a high water level.		
1400 rpm	Extras: Pre-wash, Soak, Rinse plus, Rinse hold	Rinse cycles: 2	

## Disinfection/Robert Koch Institute

<b>Dis. RKI</b>		<b>85°C/15 min</b>	<b>Max. load 8.0 kg</b>
Items	Cotton, linen, and mixed fibre textiles		
Notes	<ul style="list-style-type: none"> <li>- Thermal disinfection with a 15-minute holding time at 85°C.</li> <li>- Single-bath disinfection process.</li> <li>- No water intake via the fabric softener compartment.</li> </ul>		
1400 rpm	Extras: Soak	Rinse cycles: 3	

# Programme chart

☞ Dis. RKI		70°C/10 min	Max. load 8.0 kg
Items	Cotton or mixed fibre textiles, sorted by colour, provided they are suitable for disinfection.		
Notes	<ul style="list-style-type: none"> <li>- Chemo-thermal disinfection with a 10-minute holding time at 70°C.</li> <li>- Single-bath disinfection process.</li> <li>- Use a detergent approved by the Robert Koch Institute.</li> <li>- No water intake via the fabric softener compartment.</li> </ul>		
1400 rpm	Extras: Soak	Rinse cycles: 3	
☞ Dis. RKI		60°C/20 min	Max. load 8.0 kg
Items	Cotton or mixed fibre textiles, sorted by colour, provided they are suitable for disinfection.		
Notes	<ul style="list-style-type: none"> <li>- Chemo-thermal disinfection with a 20-minute holding time at 60°C.</li> <li>- Single-bath disinfection process.</li> <li>- Use a detergent approved by the Robert Koch Institute.</li> <li>- No water intake via the fabric softener compartment.</li> </ul>		
1400 rpm	Extras: Soak	Rinse cycles: 3	
☞ Dis. RKI		40°C/20 min	Max. load 8.0 kg
Items	Cotton or mixed fibre textiles, sorted by colour, provided they are suitable for disinfection.		
Notes	<ul style="list-style-type: none"> <li>- Chemo-thermal disinfection with a 20-minute holding time at 40°C.</li> <li>- Single-bath disinfection process.</li> <li>- Use a detergent approved by the Robert Koch Institute.</li> <li>- No water intake via the fabric softener compartment.</li> </ul>		
1400 rpm	Extras: Soak	Rinse cycles: 3	

# Programme chart

## Sluice (HTM 01-04)



This programme packet is only available on washing machines with drain valve)

<b>Sluice high</b>		<b>71 °C</b>	<b>Max. load 4.5 kg</b>
Items	Heavily soiled laundry made from cotton, linen, and mixed fibres, e.g. nappies		
Tip	<ul style="list-style-type: none"> <li>- Two pre-wash cycles remove any coarse soiling.</li> <li>- Due to a pre-wash, further soiling is loosened and removed before the main wash.</li> <li>- The spin speed cannot be modified.</li> </ul>		
1400 rpm		Rinse cycles: 3	
<b>Sluice low</b>		<b>65 °C</b>	<b>Max. load 4.5 kg</b>
Items	Heavily soiled laundry made from cotton, linen, and mixed fibres, e.g. nappies		
Tip	<ul style="list-style-type: none"> <li>- Two pre-wash cycles remove any coarse soiling.</li> <li>- Due to a pre-wash, further soiling is loosened and removed before the main wash.</li> <li>- The spin speed cannot be modified.</li> </ul>		
1400 rpm		Rinse cycles: 3	



## Disinfection I

<b>Disinfection</b>		<b>85°C/15 min</b>	<b>Max. load 8.0 kg</b>
Items	Cotton, linen, and mixed fibre textiles		
Notes	<ul style="list-style-type: none"> <li>- Thermal disinfection with a 15-minute holding time at 85°C.</li> <li>- No water intake via the fabric softener compartment.</li> </ul>		
1400 rpm	Extras: Pre-wash, Pre-rinse, Rinse plus	Rinse cycles: 2	
<b>Disinfection</b>		<b>70°C/10 min</b>	<b>Max. load 8.0 kg</b>
Items	Cotton or mixed fibre textiles, sorted by colour, provided they are suitable for disinfection.		
Notes	<ul style="list-style-type: none"> <li>- Chemo-thermal disinfection with a 10-minute holding time at 70°C.</li> <li>- No water intake via the fabric softener compartment.</li> </ul>		
1400 rpm	Extras: Pre-wash, Pre-rinse, Rinse plus	Rinse cycles: 2	

# Programme chart

 <b>Disinfection</b>		<b>60°C/20 min</b>	<b>Max. load 8.0 kg</b>
Items	Cotton or mixed fibre textiles, sorted by colour, provided they are suitable for disinfection.		
Notes	<ul style="list-style-type: none"> <li>- Chemo-thermal disinfection with a 20-minute holding time at 60°C.</li> <li>- No water intake via the fabric softener compartment.</li> </ul>		
1400 rpm	Extras: Pre-wash, Pre-rinse, Rinse plus	Rinse cycles: 2	
 <b>Disinfection</b>		<b>40°C/20 min</b>	<b>Max. load 8.0 kg</b>
Items	Cotton or mixed fibre textiles, sorted by colour, provided they are suitable for disinfection.		
Notes	<ul style="list-style-type: none"> <li>- Chemo-thermal disinfection with a 20-minute holding time at 40°C.</li> <li>- No water intake via the fabric softener compartment.</li> <li>- Due to the particularly gentle washing process, even more delicate textiles can be washed in this programme.</li> </ul>		
1400 rpm	Extras: Pre-wash, Pre-rinse, Rinse plus	Rinse cycles: 2	

## Disinfection II

 <b>Disinfection</b>		<b>80°C/10 min</b>	<b>Max. load 8.0 kg</b>
Items	Cotton, linen, and mixed fibre textiles		
Notes	<ul style="list-style-type: none"> <li>- Thermal disinfection with a 10-minute holding time at 80°C.</li> <li>- No water intake via the fabric softener compartment.</li> </ul>		
1400 rpm	Extras: Pre-wash, Pre-rinse	Rinse cycles: 2	
 <b>Disinfection</b>		<b>75°C/10 min</b>	<b>Max. load 8.0 kg</b>
Items	Cotton, linen, and mixed fibre textiles		
Notes	<ul style="list-style-type: none"> <li>- Thermal disinfection with a 10-minute holding time at 75°C.</li> <li>- No water intake via the fabric softener compartment.</li> </ul>		
1400 rpm	Extras: Pre-wash, Pre-rinse, Rinse plus	Rinse cycles: 2	
 <b>Disinfection</b>		<b>70°C/17 min</b>	<b>Max. load 8.0 kg</b>
Items	Cotton or mixed fibre textiles		
Notes	<ul style="list-style-type: none"> <li>- Thermal disinfection with a 17-minute holding time at 70°C.</li> <li>- No water intake via the fabric softener compartment.</li> </ul>		
1400 rpm	Extras: Pre-wash, Pre-rinse, Rinse plus	Rinse cycles: 2	





## Programme chart

<b>Dental surgery garments 60°C/60 min</b>			<b>Max. load 8.0 kg</b>
Items	Cotton or mixed fibre textiles, sorted by colour, provided they are suitable for disinfection.		
Notes	<ul style="list-style-type: none"> <li>- Chemo-thermal disinfection with a 60-minute holding time at 60°C.</li> <li>- No water intake via the fabric softener compartment.</li> </ul>		
1400 rpm	Extras: Pre-wash, Pre-rinse, Rinse plus	Rinse cycles: 2	
<b>Disinfection 71°C</b>			<b>71°C</b>
			<b>Max. load 4.5 kg</b>
Items	Cotton or mixed fibre textiles, sorted by colour, provided they are suitable for disinfection.		
Notes	<ul style="list-style-type: none"> <li>- Disinfection with a 3-minute holding time at 71°C.</li> <li>- The spin speed cannot be modified.</li> <li>- No water intake via the fabric softener compartment.</li> </ul>		
1400 rpm	Extras: Pre-wash, Pre-rinse	Rinse cycles: 3	
<b>Disinfection 65°C</b>			<b>65°C</b>
			<b>Max. load 4.5 kg</b>
Items	Cotton or mixed fibre textiles, sorted by colour, provided they are suitable for disinfection.		
Notes	<ul style="list-style-type: none"> <li>- Disinfection with a 10-minute holding time at 65°C.</li> <li>- The spin speed cannot be modified.</li> <li>- No water intake via the fabric softener compartment.</li> </ul>		
1400 rpm	Extras: Pre-wash, Pre-rinse	Rinse cycles: 3	
<b>MRSA</b>			<b>40°C</b>
			<b>Max. load 4.5 kg</b>
Items	Minimum-iron textiles, sorted by colour, provided they are suitable for disinfection.		
Notes	<ul style="list-style-type: none"> <li>- Add MRSA disinfectants to the fabric softener compartment.</li> <li>- The spin speed cannot be modified.</li> </ul>		
1000 rpm		Rinse cycles: 3	

# Programme chart

## WetCare

<b>WetCare sensitive</b>		<b>Cold to 30°C</b>	<b>Max. load 4.5 kg</b>
Items	Non-washable outerwear, e.g. suits, smart dresses, that are marked with the care symbol 		
Notes	<ul style="list-style-type: none"> <li>- A finishing bath is applied after washing.</li> <li>- Use a liquid finishing agent for impregnation; add the detergent to the fabric softener compartment.</li> </ul>		
1100 rpm	Extras: Rinse hold	Rinse cycles: 1	
<b>WetCare silks</b>		<b>Cold to 30°C</b>	<b>Max. load 3.5 kg</b>
Items	Textiles or silk items that cannot be washed and are prone to creasing		
Notes	<ul style="list-style-type: none"> <li>- A finishing bath is applied after washing.</li> <li>- Use a liquid finishing agent for impregnation; add the detergent to the fabric softener compartment.</li> </ul>		
600 rpm	Extras: Rinse hold	Rinse cycles: 1	
<b>WetCare intensive</b>		<b>30°C to 40°C</b>	<b>Max. load 4.5 kg</b>
Items	Heavily soiled non-washable outerwear		
Notes	<ul style="list-style-type: none"> <li>- A finishing bath is applied after washing.</li> <li>- Use a liquid finishing agent for impregnation; add the detergent to the fabric softener compartment.</li> </ul>		
1100 rpm	Extras: Pre-wash, Rinse hold	Rinse cycles: 2	
<b>WetCare disinfection</b>		<b>40°C</b>	<b>Max. load 4.5 kg</b>
Items	Non-washable outerwear that is marked with the care symbol 		
Notes	- Textiles are washed and disinfected (40°C for 20 minutes).		
1100 rpm	Extras: Pre-wash	Rinse cycles: 2	
<b>WetCare hygiene</b>		<b>20°C to 30°C</b>	<b>Max. load 4.5 kg</b>
Items	Sensitive textiles, e.g. outerwear		
Notes	- Textiles are washed and disinfected by the addition of a disinfectant during the rinse phase.		
1100 rpm	Extras: Rinse hold	Rinse cycles: 2	

## Special programmes

You can put together 5 special programmes and assign your own programme names. Enter these into the tables.

Load: max. 8.0 kg

### Example: *Intensive Plus*

- Pre-wash intensive
- Intensive wash, 90°C
- Rinse 1
- Rinse 2
- Rinse 3
- Pre-treat
- Spin, 1400 rpm

(1)

- 
- 
- 
- 
- 
- 
- 

(2)

- 
- 
- 
- 
- 
- 
- 

(3)

- 
- 
- 
- 
- 
- 
- 

(4)

- 
- 
- 
- 
- 
- 
- 

(5)

- 
- 
- 
- 
- 
- 
-

## Extras

---

You can supplement the wash programmes with Extras.

Not all Extras can be selected with every programme. If an Extra is not listed, it is not permitted for use with this wash programme.

### Selecting Extras

- Touch the **Extras** sensor.
- Select one or more of the Extras available.
- Confirm with the **OK** sensor.

### Pre-wash

A pre-wash can be added for heavily soiled laundry. Coarse soiling is loosened and removed before the main wash.

### Pre-rinse

The laundry is rinsed before the main wash to remove larger quantities of soiling, e.g. dust, sand.

### Rinse plus

An additional rinse cycle can be activated to achieve a particularly good wash result.

### Soak

For heavily soiled fabrics with protein stains. The soaking time is 10 minutes.

### Intensive





For hard-wearing laundry that is very heavily soiled. Cleaning efficiency is increased through more intense mechanical action and the application of more heat energy.

### Water plus

The water level in the main wash and the rinse cycles is increased.

### Pre-ironing

In order to reduce creasing, the laundry undergoes a smoothing process at the end of the programme. For optimal smoothing reduce the maximum load by 50%. Small loads achieve a better result.

The textiles must be suitable for drying in a tumble dryer   and suitable for ironing  .

### Rinse hold

The laundry is not spun after the final rinse and remains in the rinse water. This helps prevent creasing if the laundry is not going to be removed from the drum immediately after the end of the programme.

### Starch stop

Water is drained out of the machine before the last rinse and the programme stops. The prepared starch is added directly to the drum. The programme is continued by touching the *Start/Stop* sensor.

# Special features in the programme sequence

---

## Spinning

### Final spin speed

When a programme is selected, the maximum spin speed for this wash programme is shown in the display.

You can reduce the final spin speed.

However, you cannot select a final spin speed higher than that shown in the chart.

### Interim spin

There is a spin cycle after the main wash and between the rinses. A reduction in the final spin speed will also reduce the interim spin speed accordingly.

### Deselecting the interim spin and the final spin

- Select the programme setting *Spin speed 0*.

After the last rinse cycle, the water will be pumped away and the anti-crease phase will switch on.

## Anti-crease

At the end of the programme, the drum continues to turn at intervals for up to 30 minutes to help prevent creasing. The door can be opened at any time during the anti-crease phase.

There is no anti-crease phase at the end of some programmes.
--

## Changing the programme sequence

---

A programme cannot be cancelled or changed when operating a payment system.

### Changing a programme

After the successful start of a programme it is no longer possible to select a different programme.

You will need to cancel the current programme before you can select a different one.

### Cancelling a programme

You can cancel a programme at any time after it has started.

- Touch the *Start/Stop* sensor.

The following will appear in the display:

**i** Cancel the programme?

- Select yes.

The following will appear in the display:

Programme cancelled.

The suds will be pumped away.

- Wait until the door unlocks.
- Pull open the door.
- Remove the laundry.

### Switching on the washing machine after an interruption to the power supply

If the washing machine is switched off with the Ⓛ button during a wash programme, the programme will be interrupted.

- Switch it back on with the Ⓛ button.
- Note the message in the display.
- Touch the *Start/Stop* sensor.

The programme will also be interrupted if power is interrupted by a power cut.

- When power is restored, confirm the message in the display with *OK*.
- Touch the *Start/Stop* sensor.

The programme will continue.

## Changing the programme sequence

### Adding or removing laundry

You can add or remove items during the first few minutes after the programme has started.

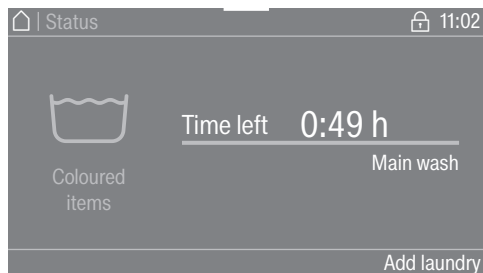

- Touch the *Add laundry* sensor.

If the message *Add laundry* is not visible in the display, then it is no longer possible to add items of laundry.

The programme will stop and the door will unlock.

 Risk of chemical burns from detergent.

When adding or removing laundry during the main wash, your skin may come into contact with detergent, particularly if the detergent is dispensed externally.

Take care when placing your hands inside the drum.

If suds have come into contact with the skin, rinse off immediately with lukewarm water.

- Pull open the door.
- Add laundry or remove individual items.
- Close the door.
- Touch the *Start/Stop* sensor.

The wash programme will continue.

The safety lock will remain activated if the temperature in the drum is above 55°C. The lock will not deactivate until the temperature has dropped to below 55°C.

## Cleaning and care

### Risk of electric shock!

Only ever perform cleaning and maintenance work when the appliance is disconnected from the power.

Disconnect the washing machine from the mains electricity supply.

### Cleaning the external casing and fascia panel

### Damage caused by cleaning agents.

Solvent based cleaning agents, abrasive cleaners, glass cleaners or multi-purpose cleaning agents can cause damage to plastic surfaces and other parts.

Do not use any of these cleaning agents.

### Risk of damage due to ingress of water.

The pressure of a water jet can cause water to get into the washing machine, resulting in damage to components.

Do not spray the washing machine with a water jet.

- Clean the casing and control panel with a mild cleaning agent or soap and water and dry both with a soft cloth.
- The drum and other stainless steel parts can be cleaned using a suitable stainless steel cleaning agent.

### Cleaning the detergent dispenser drawer

Washing at low temperatures and the use of liquid detergent can lead to a build-up of mould and bacteria in the detergent dispenser drawer.

- For hygiene reasons, clean the entire drawer at regular intervals.

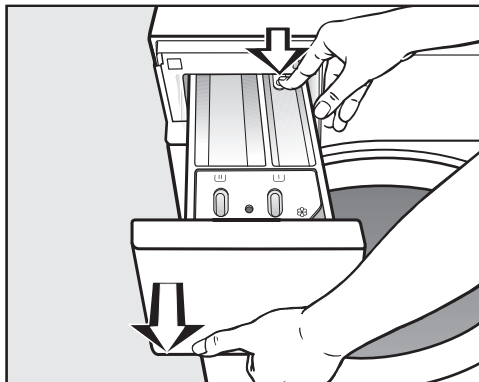

- Pull out the detergent dispenser drawer until a resistance is felt. Press down the release button and at the same time pull the drawer right out of the machine.
- Clean the detergent dispenser drawer with warm water.



## Cleaning the siphon and the channel

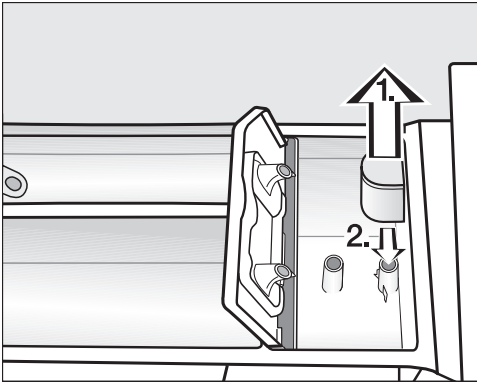

- Pull the siphon out of the ☒ compartment. Clean the siphon under warm running water. Clean the siphon tube in the same way.
- Refit the siphon.

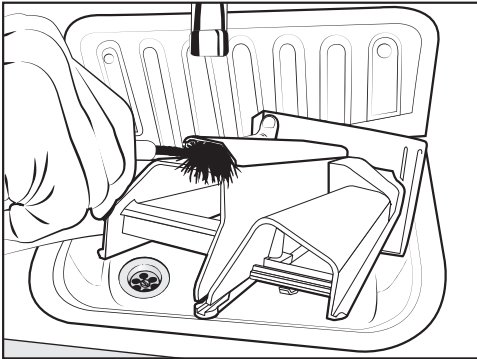

- Clean the fabric softener channel using a brush and warm water.

## Cleaning the detergent dispenser drawer housing

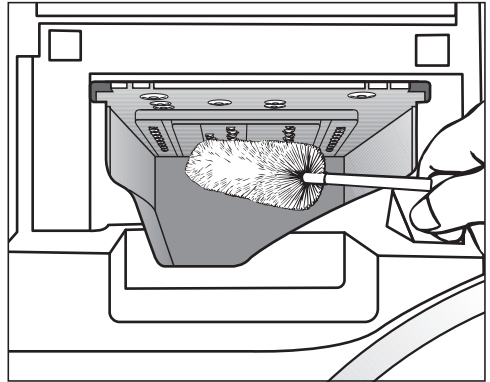

- Use a bottle brush to remove detergent residues and limescale from the jets inside the detergent dispenser drawer housing.
- Replace the detergent dispenser drawer.

**Useful tip:** Leave the detergent dispenser drawer slightly open to allow it to dry.

## Cleaning and care

### Cleaning the drum, suds container and drainage system

By using wash programmes of 60°C or more on a regular basis and using a multi-purpose detergent, you can avoid the build-up of bacteria in the washing machine.

Regularly use the *Clean machine* programme, especially if you frequently use wash programmes with low temperatures.

Optimum results can be achieved by using a machine cleaner. Alternatively, a multi-purpose powder detergent can be used.

- Start the *Clean machine* programme.
- Dispense the machine cleaner or multi-purpose detergent directly into the drum.
- Do **not** load any laundry. The drum must be empty for the cleaning process.
- At the end of the programme, check the inner drum and remove any coarse residues.

Use the *Clean machine* programme regularly if you frequently use disinfection programmes.

### Cleaning the sealing ring

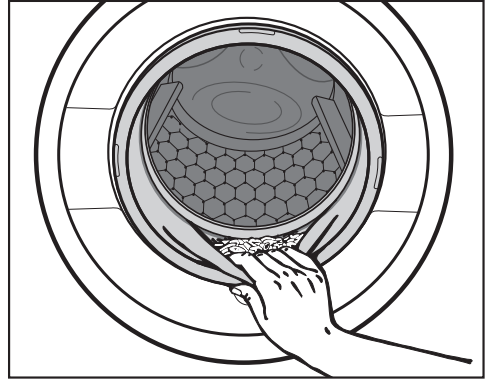

- Check the fold in the sealing ring for foreign objects.
- Clean the sealing ring and the inner fold of the sealing ring with a damp cloth.

**Useful tip:** For safety reasons, close the door when the machine is not in use. Otherwise there is a danger of objects being placed inadvertently in the drum. If these remain unnoticed and were washed in the next load, they could damage the laundry. An open door is also a danger to pets and children.

### Cleaning the filters in the water inlet

The washing machine has filters to protect the water inlet valves. Check these filters about every 6 months or more often if there are frequent interruptions to the external water supply.

### Cleaning the filters in the inlet hoses

- First turn off the tap.
- Unscrew the inlet hose.
- Remove the rubber seal from the recess.
- Using combination or pointed pliers, take hold of the plastic filter bar and remove the filter.
- Clean the plastic filter.
- Reassemble the filter and seal in the reverse order and reconnect the hose.

Make sure there is no water leaking from the threaded union.  
Tighten the threaded union.

### Cleaning the filters in the water inlet valves

- Using pliers, carefully loosen the ribbed plastic nut on the inlet valve and unscrew.

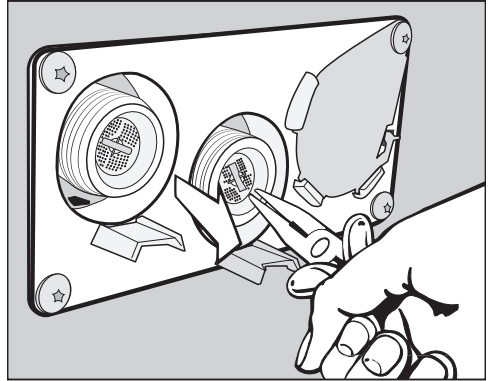

- Withdraw the filter at the bar with pointed pliers and rinse it clean under running water. Reassemble the filter and seal in the reverse order and reconnect the hose.



Replace the filters after cleaning.

## Problem solving guide

With the help of the following guide, minor faults in the performance of the appliance, some of which may result from incorrect operation, can be remedied without contacting Miele. This will save you time and money because you will not need a service call.

Please note, however, that a call-out charge will be applied to unnecessary service visits where the problem could have been rectified as described in these operating instructions.





### The programme does not start

Problem	Possible cause and remedy
<b>The display remains dark and the Start/Stop sensor does not light up or flash.</b>	<p>There is no power to the machine.</p> <ul style="list-style-type: none"><li>■ Check whether the washing machine is switched on.</li><li>■ Check whether the washing machine is connected to the electricity supply.</li><li>■ Check whether the circuit breaker has tripped.</li></ul>
	<p>The washing machine has switched off automatically to save energy.</p> <ul style="list-style-type: none"><li>■ Switch it back on with the  button.</li></ul>
<b>The following appears in the display:</b>  Door will not lock. Call Miele.	<p>The door is not closed properly. The door lock could not engage.</p> <ul style="list-style-type: none"><li>■ Close the door again.</li><li>■ Start the programme again.</li></ul> <p>If the fault message appears again, contact Miele.</p>
<b>The programme does not start when Spin is selected.</b>	<p>You have not yet completed the initial commissioning process.</p> <ul style="list-style-type: none"><li>■ Follow the instructions in the section <i>Completing the commissioning process</i> in these instructions.</li></ul>
<b>The display is dark and the Start/Stop sensor is flashing slowly.</b>	<p>The display has switched off automatically to save energy.</p> <ul style="list-style-type: none"><li>■ Touch any sensor. The display will switch on again.</li></ul>



### Programme cancellations and fault messages

Problem	Possible cause and remedy
 Drainage fault. Clean drain filter and pump. Check the drain hose.	<p>The water outlet is blocked or restricted.</p> <p>The drain hose has been fixed too high.</p> <ul style="list-style-type: none"><li>■ Clean the filters and the drain pump.</li><li>■ The maximum drain height is 1 m.</li></ul>

## Problem solving guide

Problem	Possible cause and remedy
 Water intake fault. Turn on the tap.	The water inlet is blocked or restricted. <ul style="list-style-type: none"> <li>■ Check whether the tap is turned on properly.</li> <li>■ Check whether the inlet hose is kinked.</li> </ul>
	The water pressure is too low. <ul style="list-style-type: none"> <li>■ Switch on the Low water pressure setting (see “Supervisor level - Low water pressure”).</li> </ul>
	The filters in the water inlet are blocked. <ul style="list-style-type: none"> <li>■ Clean the filters (see “Cleaning and care - Cleaning the filters”).</li> </ul>
 Waterproof system activated	The water protection system has reacted. <ul style="list-style-type: none"> <li>■ Turn off the tap.</li> <li>■ Call Miele.</li> </ul>
 Disinfection temperature not reached	The required temperature was not reached during the disinfection programme. <ul style="list-style-type: none"> <li>■ The washing machine has <b>not</b> carried out the disinfection cycle correctly.</li> <li>■ Start the programme again.</li> </ul>
 Fault F. If restart fails, call Miele.	There is a fault. <ul style="list-style-type: none"> <li>■ Disconnect the washing machine from the mains electricity supply.</li> <li>■ Wait <b>at least 2 minutes</b> before reconnecting the washing machine to the mains.</li> <li>■ Then switch the washing machine on again.</li> <li>■ Start the programme again.</li> </ul> If the fault message appears again, contact Miele.

### A fault message appears in the display<sup>1</sup>

Problem	Possible cause and remedy
 Dispenser container empty	One of the detergent containers for external dosing is empty. <ul style="list-style-type: none"> <li>■ Refill the detergent containers.</li> </ul>
 Hygiene info: run the “Maintenance wash hygiene” programme, or a programme of at least 60°C	During the last wash, a wash programme with a temperature below 60°C or the <i>Drain/Spin</i> programme was selected. <ul style="list-style-type: none"> <li>■ Start a programme with a minimum temperature of 60°C or the Maintenance wash hygiene programme.</li> </ul>

## Problem solving guide

Problem	Possible cause and remedy
<b>i</b> Check hot water intake	The hot water supply is blocked or restricted. <ul style="list-style-type: none"> <li>■ Check whether the hot water tap is turned on properly.</li> <li>■ Check whether the inlet hose is kinked.</li> </ul>
<b>i</b> Align the machine. Laundry not properly spun.	The selected spin speed was not reached during the final spin due to excessive imbalance. <ul style="list-style-type: none"> <li>■ Check that the washing machine is standing level.</li> <li>■ Start the spin cycle again.</li> </ul>
<b>i</b> Machine is leaking	The washing machine or the drain valve is leaking. <ul style="list-style-type: none"> <li>■ Turn off the tap.</li> <li>■ Call Miele.</li> </ul>

<sup>1</sup> The messages will appear at the end of the programme and when the washing machine is switched on and need to be confirmed with the *OK* sensor.

### An unsatisfactory wash result

Problem	Possible cause and remedy
<b>Liquid detergent does not give the required result.</b>	Liquid detergents usually contain no bleaching agents. They do not remove fruit, coffee and tea stains. <ul style="list-style-type: none"> <li>■ Use a general purpose powder detergent containing a bleaching agent.</li> <li>■ Add stain removers to compartment <b>III</b> of the detergent dispenser drawer and fill liquid detergent into a dispenser ball.</li> <li>■ Never put stain removers and liquid detergent together in the dispenser drawer.</li> </ul>
<b>White residues which look like powder detergent are seen on dark textiles after washing.</b>	The detergent contains compounds (zeolites) to aid water softening which are not soluble in water. These have ended up on the laundry. <ul style="list-style-type: none"> <li>■ Try to brush off the residues with a soft brush once the laundry is dry.</li> <li>■ Wash dark textiles using a detergent which contains no zeolites. Liquid detergents do not usually contain zeolites.</li> </ul>

## Problem solving guide

Problem	Possible cause and remedy
<b>Textiles that were very greasy are not properly clean.</b>	<ul style="list-style-type: none"> <li>■ Select a programme with pre-wash. Use liquid detergent for the pre-wash.</li> <li>■ Continue to use universal powder detergent for the main wash.</li> </ul>
	The use of heavy-duty detergent is recommended in the main wash for very heavily soiled work clothing. Please seek advice from the detergent manufacturer.
<b>Grey, greasy particles cling to washed laundry.</b>	<p>Insufficient amounts of detergent were used. The laundry was heavily soiled with grease (oils, ointments).</p> <ul style="list-style-type: none"> <li>■ Use more detergent or liquid detergent with this type of soiled laundry.</li> <li>■ Before washing the next load, run a 60°C programme with liquid detergent but without a load.</li> </ul>

### General problems with the washing machine

Problem	Possible cause and remedy
<b>The machine shakes during the spin cycle.</b>	<p>The machine feet are not level.</p> <ul style="list-style-type: none"> <li>■ Level the machine and adjust the feet correctly.</li> </ul>
<b>The pump makes strange noises.</b>	This is not a fault. Slurping noises occur at the end of the pump sequence as a normal part of operation.
<b>Large amounts of detergent residue remain in the detergent dispenser drawer.</b>	<p>The water pressure is too low.</p> <ul style="list-style-type: none"> <li>■ Clean the filters in the water inlet.</li> </ul>
	<p>Powder detergent used in conjunction with water softeners tends to become sticky.</p> <ul style="list-style-type: none"> <li>■ Clean the detergent dispenser drawer and, in the future, add washing powder to the dispensing drawer first, and then add the water softener.</li> </ul>
<b>Fabric softener is not completely dispensed or too much water remains in the  compartment.</b>	<p>The siphon tube is not correctly positioned or clogged.</p> <ul style="list-style-type: none"> <li>■ Clean the siphon (see “Cleaning and care - Cleaning the detergent dispenser drawer”).</li> </ul>

## Problem solving guide

Problem	Possible cause and remedy
<p><b>The display is in a different language.</b></p>	<p>A different language has been selected.</p> <ul style="list-style-type: none"> <li>■ Switch the washing machine off and then on again.</li> </ul> <p>The set operator language will appear in the display.</p>
	<p>The operator language has been changed.</p> <ul style="list-style-type: none"> <li>■ Select the language you require (see “Supervisor level - Language”).</li> </ul>
<p><b>The washing machine did not spin the laundry as usual. The laundry is still wet.</b></p>	<p>The machine detected an imbalance during the final spin and reduced the spin speed automatically.</p> <ul style="list-style-type: none"> <li>■ Include both large and small items in the load as this will give better distribution.</li> </ul>
<p><b>At the end of the programme there is still liquid in the capsule.</b></p>	<p>The small pipe in the detergent dispenser drawer onto which the capsule is placed is blocked.</p> <ul style="list-style-type: none"> <li>■ Clean the small pipe.</li> </ul>
	<p>This is not a fault. For technical reasons a small amount of water will remain in the capsule.</p>
<p><b>There is water next to the capsule in the fabric softener compartment.</b></p>	<p>The <i>CapDosing</i> sensor was not activated or an empty capsule was not removed at the end of the last wash programme.</p> <ul style="list-style-type: none"> <li>■ Activate the <i>CapDosing</i> sensor when a capsule is used the next time.</li> <li>■ Remove and dispose of the empty capsule at the end of each programme.</li> </ul>
	<p>The small pipe in the detergent dispenser drawer onto which the capsule is placed is blocked.</p> <ul style="list-style-type: none"> <li>■ Clean the small pipe.</li> </ul>
<p><b>The drum remains stationary but the programme keeps running.</b></p>	<ul style="list-style-type: none"> <li>■ Switch the washing machine off and then back on with the  button.</li> <li>■ Note the message in the display.</li> <li>■ Touch the <i>Start/Stop</i> sensor.</li> </ul> <p>The programme will continue and the drum will spin.</p>



### The door will not open

Problem	Possible cause and remedy
<p><b>The door cannot be pulled open during a programme.</b></p>	<p>The door is locked during the washing process.</p> <ul style="list-style-type: none"> <li>■ Touch the <i>Start/Stop</i> sensor.</li> <li>■ Select Cancel programme or Add laundry.</li> </ul> <p>The door will unlock and you will be able to pull it open.</p> <hr/> <p>There is still water in the drum and the machine is unable to drain.</p> <ul style="list-style-type: none"> <li>■ Clean the drain system as described in “Opening the door in the event of a blocked drain outlet and/or power cut”.</li> </ul>
<p>Programme cancelled <b>appears in the display at the end of a programme or after a programme has been cancelled.</b></p>	<p>For safety reasons, the door cannot be opened if the suds temperature is higher than 55°C.</p> <ul style="list-style-type: none"> <li>■ Wait until the temperature in the drum has decreased and the message has gone out in the display.</li> </ul>
<p><b>The following appears in the display:</b>   The door lock is jammed.            Call Miele.</p>	<p>The door lock has jammed.</p> <ul style="list-style-type: none"> <li>■ Call Miele.</li> </ul>

## Problem solving guide

### Opening the door in the event of a blocked drain outlet and/or power cut

**⚠ Risk of electric shock!**  
Only ever perform cleaning and maintenance work when the appliance is disconnected from the power.  
Disconnect the washing machine from the mains electricity supply.

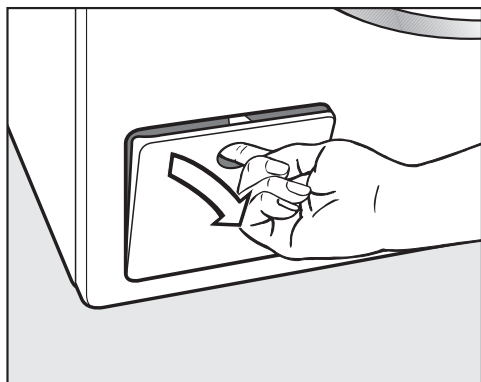

- Open the access panel to the drain system.

### Blocked drain outlet

If the drain outlet is blocked, a larger quantity of water (max. 30 l) can remain in the washing machine.

**⚠ Risk of scalding due to hot suds.**  
Escaping suds will be hot if laundry has been washed at high temperatures shortly before.  
Drain the suds carefully.

### Emptying the drum

#### ....in machines with a drain pump

- Place a suitable container under the access flap.

Remove the drain filter, though not completely.

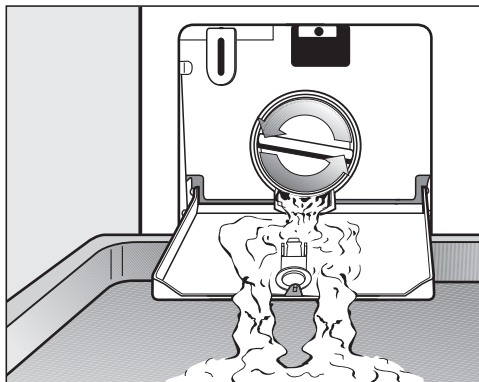

- Slowly and carefully unscrew the filter to let the water out. Be careful not to release too much water at once. If the flow of water is too strong, some water can seep into the washing machine base and activate the water protection float switch. This will prevent the washing machine from functioning.
- Tighten the drain filter back up again if you need to interrupt the flow of water.

## Cleaning the drain filter

Once the flow of water ceases:

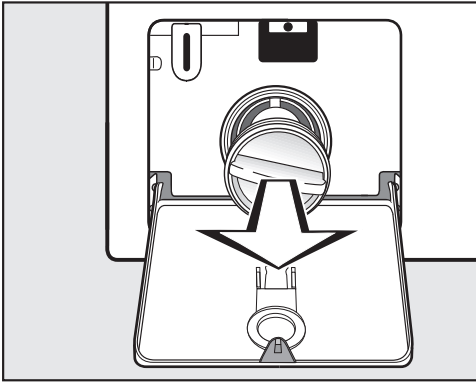

- Remove the drain filter completely.
- Clean the drain filter thoroughly.

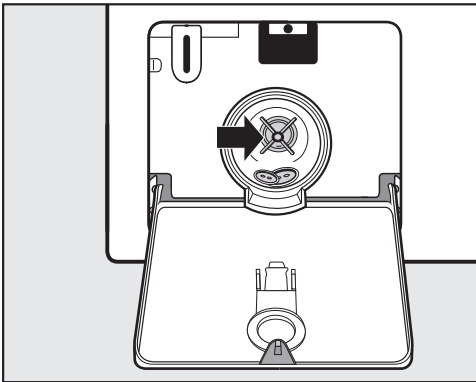

- Check the drain pump impellers to make sure they can rotate freely.
- Remove any foreign objects (e.g., buttons, coins etc.) and clean the interior.
- Put the drain filter back in place and secure it.

 Risk of water damage.

Make sure the drain filter is securely tightened. Otherwise there is a risk of water leakage during use.

Replace the drain filter correctly and tighten it securely.

## Opening the door

 Danger of injury due to rotating drum!

Reaching into a moving drum is extremely dangerous. Danger of injury!

Always make sure that the drum is stationary before reaching in to remove laundry.

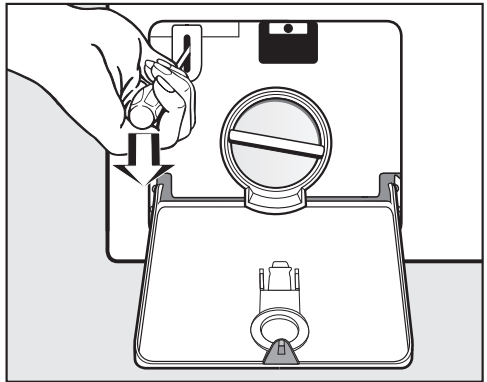

- Use a screwdriver to unlock the door of the washing machine as shown.
- Pull open the door.

# Problem solving guide

## Emptying the drum

...in machines with a drain valve

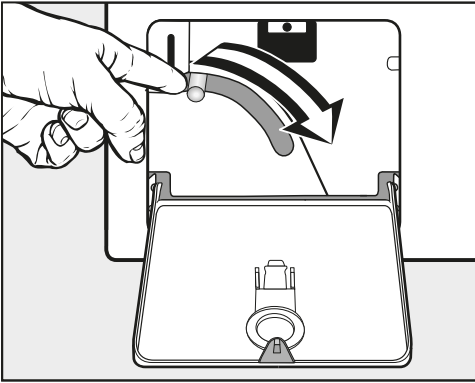

- Push the emergency drain lever downwards and hold until no more water runs out.

## Opening the door

 Danger of injury due to rotating drum!

Reaching into a moving drum is extremely dangerous. Danger of injury!

Always make sure that the drum is stationary before reaching in to remove laundry.

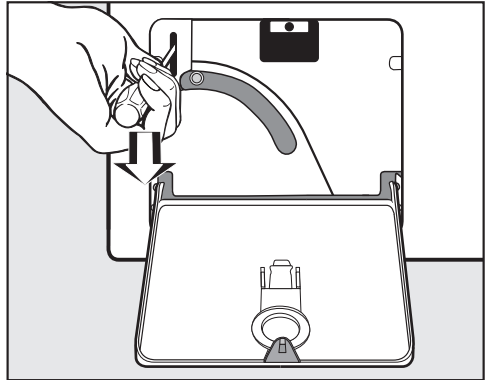

- Use a screwdriver to unlock the door of the washing machine as shown.
- Pull open the door.

### Contact in case of fault

In the event of any faults which you cannot remedy yourself, please contact Miele.

Contact information for Miele can be found at the end of this booklet.

Please quote the model and serial number of your appliance when contacting Miele. This information can be found on the data plate.

The data plate is found above the porthole glass when the washing machine door is opened:

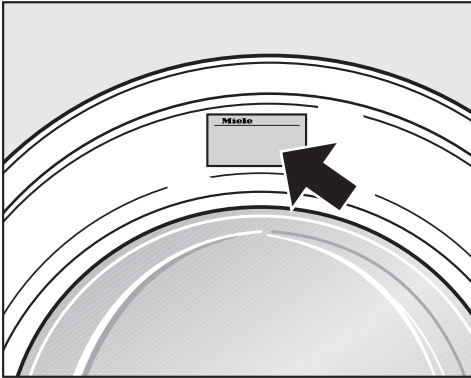

### Optional accessories

Optional spare parts and accessories for this washing machine are available from Miele.

# Installation

## Front view

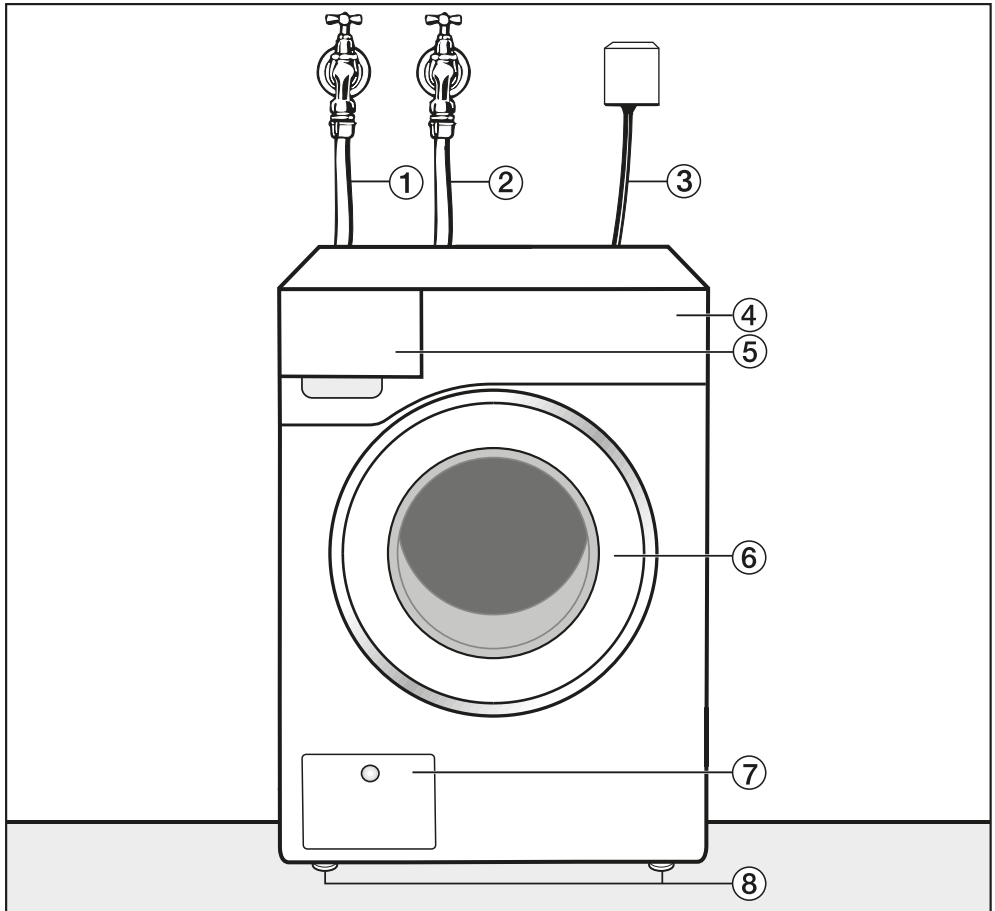

① Cold water inlet hose

② Hot water inlet hose

③ Electrical connection

④ Control panel

⑤ Detergent dispenser drawer

⑥ Door

⑦ Access to drain filter, drain pump or valve and emergency release

⑧ Height-adjustable feet

## Rear view

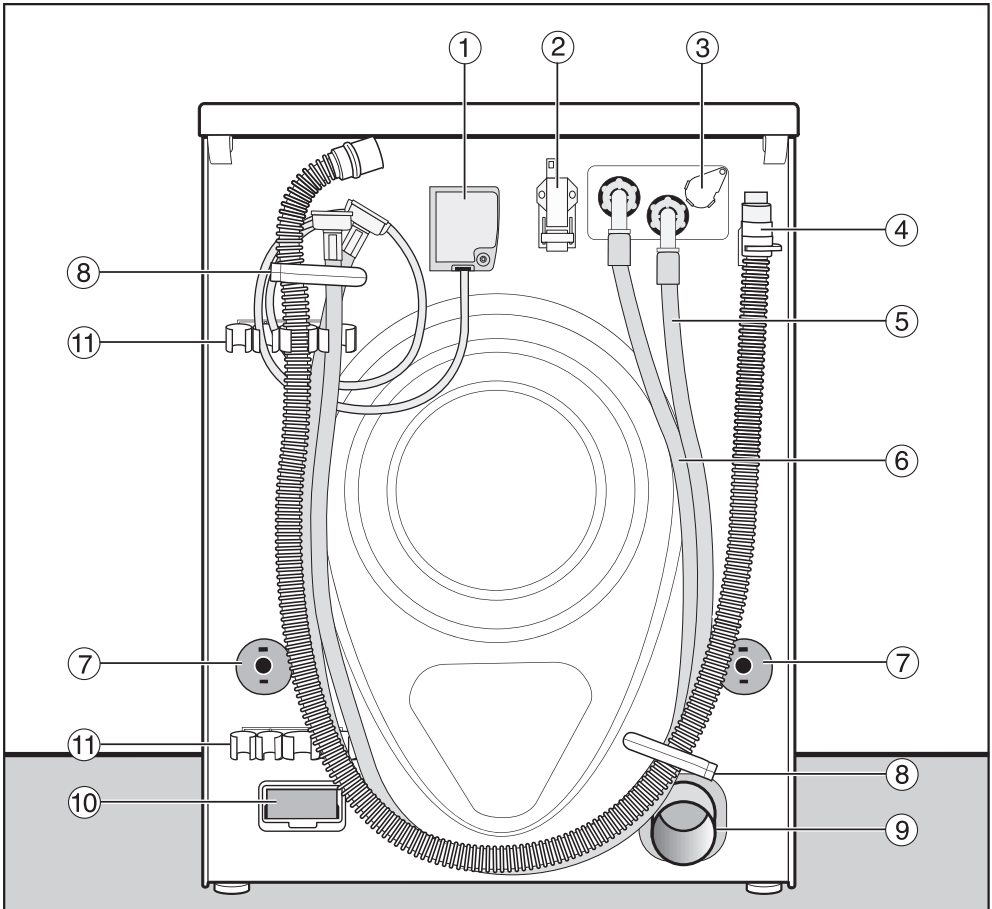

- |   |   |
|---|---|
| ① Electrical connection                             | ⑦ Safety caps for transit bars                    |
| ② Interface for communicating with external devices | ⑧ Transport clips for hoses                       |
| ③ Socket for external dispensing system             | ⑨ Drain pipe (DV version)                         |
| ④ Drain hose (DP version)                           | ⑩ Module slot (for external communication module) |
| ⑤ Inlet hose (cold water)                           | ⑪ Holder for removed transit bars                 |
| ⑥ Inlet hose (hot water), if fitted                 |   |

# Installation

## Installation locations

### Side view

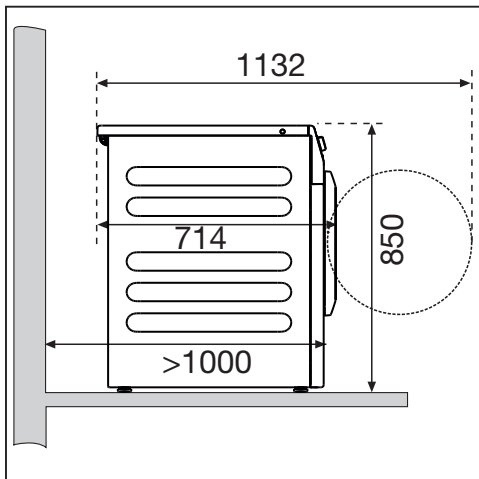

⚠ Installing the washer-dryer stack on a Miele plinth is not permitted.

### Installation on a raised plinth

The washing machine can be installed on a steel plinth (open or closed, available as an optional Miele accessory) or on a concrete plinth.

⚠ Injury can occur if the washing machine has not been adequately secured.

When installed on a plinth, there is a risk that the washing machine will move and fall from the plinth during spinning.

Secure the washing machine using the clamps supplied.

### Washer-dryer stack

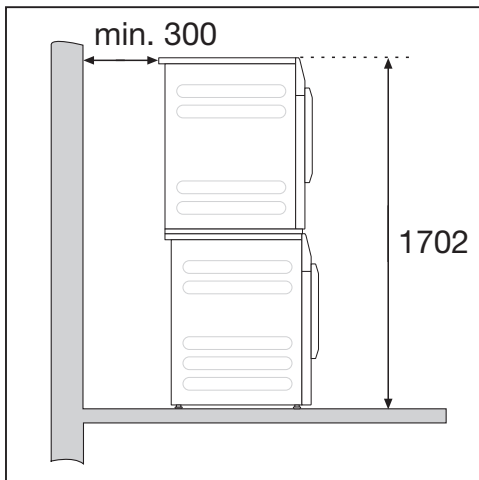

### Installation notes

The distances between the machine and the wall are recommended for making service work easier. If installation space is limited, the washing machine can also be pushed up against the wall.

This washing machine is not suitable for building under.

⚠ Risk of damage due to moisture ingress.

Moisture can damage electrical components.

Do not install the washing machine near or directly above an open gully or floor drain.

This washing machine can be installed with a Miele tumble dryer on top of it. This requires a Miele washer-dryer stacking kit which can be purchased separately.



## Transporting the washing machine to its installation site

**⚠** Danger of injury from incorrect transport.

If the washing machine tips over, there is a danger of injury to people and damage to property.

When transporting the machine, make sure that it is stable.

## Transporting the washing machine with a hand trolley

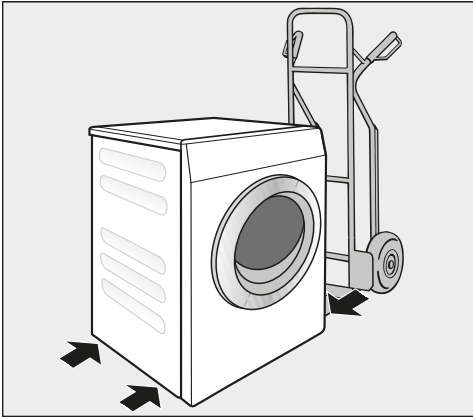

- If transporting the washing machine with a hand trolley, make sure only its left or right side is resting on the trolley.

**⚠** Risk of damage from incorrect transport.

The front or back of the washing machine may be damaged if the machine is transported on a hand trolley.

Always transport the washing machine on its side on a hand trolley.

## Transporting the washing machine to its installation site

The protruding lid can be used for holding the machine during transport.

**⚠** Danger of injury due to unsecured lid.

Make sure the fixings at the back of the lid are secure. They may become brittle due to external circumstances. There is a danger of the lid being pulled off when carrying the appliance.

Before carrying the appliance, check that the lid is secure where it protrudes at the back.

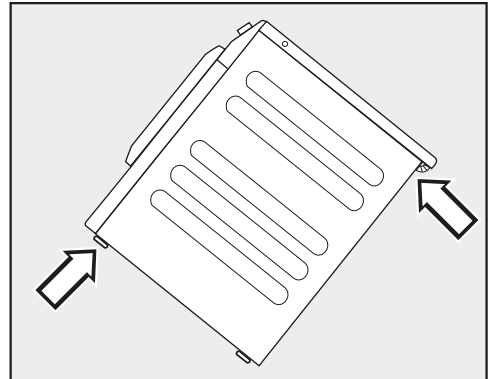

- Carry the washing machine by the front feet and by the lid where it protrudes at the back of the appliance.

# Installation

## Installation surface

A concrete floor is the most suitable installation surface. It is far less prone to vibration during the spin cycle than wooden floorboards or a carpeted surface.

- The machine must be level and securely positioned.
- To avoid vibrations during spinning, the machine should not be installed on soft floor coverings.

### If installing on a wooden joist floor:

- Install the machine on a plywood base (at least 70 x 60 x 3 cm). The base should span several joists and be bolted to the joists and not only to the floorboards.

**Useful tip:** If possible, install the machine in a corner of the room. This is usually the most stable part of the floor.

## Removing the transit bars

### Removing the left transit bar

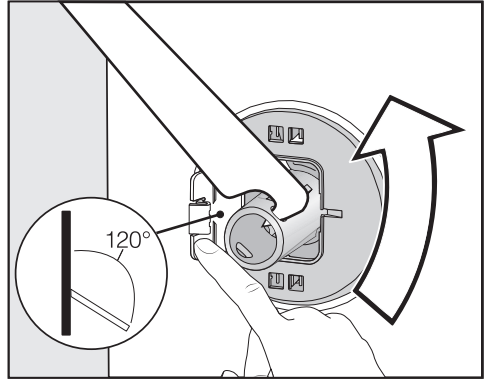

- Push the cover out and turn the transit bar 90° using the open spanner supplied.

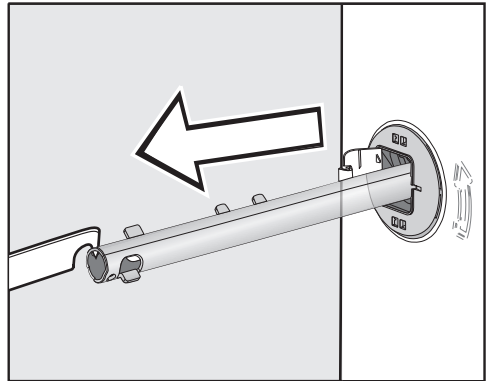

- Then pull the transit bar out.

## Removing the right transit bar

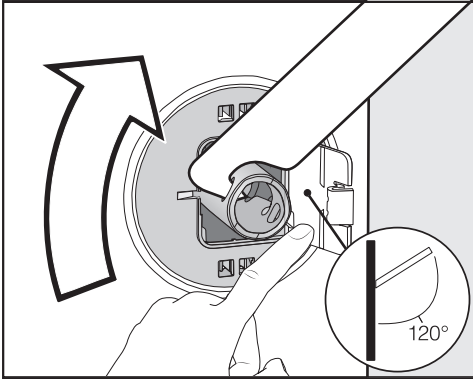

- Push the cover out and turn the transit bar 90° using the open spanner supplied.

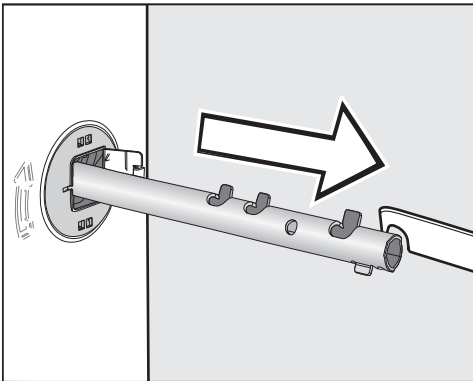

- Then pull the transit bar out.

## Covering the holes

 Risk of injury from sharp edges!  
There is a risk of injury from reaching into holes that are not covered.  
The holes for the transit bars must be covered after the transit bars have been removed.

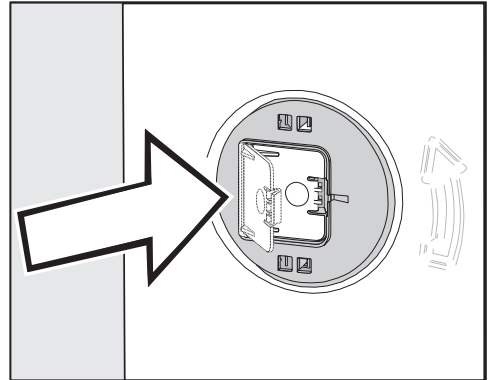

- Press the covers firmly shut until they click into place.

# Installation

## Securing the transit bars

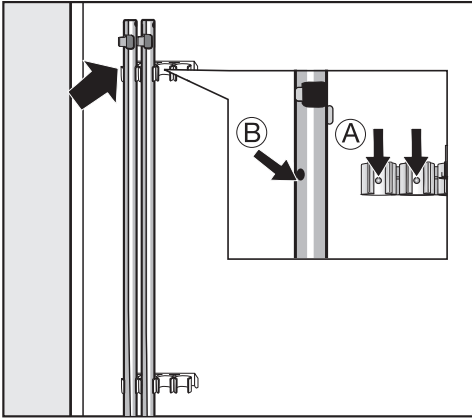

- Secure the transit bars to the back of the washing machine.

**Useful tip:** Make sure that the holes (B) are fitted over the retainers (A).

 Risk of damage from incorrect transport.

The washing machine may be damaged if moved without the transit bars in place.

Keep the transit bars in a safe place. Fit them again if the washing machine is to be moved (e.g. when moving house).

## Fitting the transit bars

### Opening the flaps

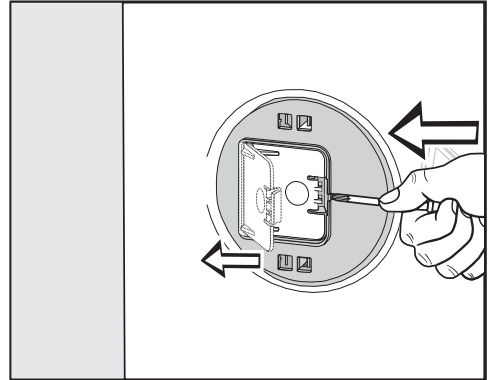

- Push against the catch with a pointed object, e.g. a narrow screwdriver.

The flap will open.

### Fitting the transit bars

- Install the transit bars in reverse order to their removal.

**Useful tip:** If you lift the drum slightly, the transit bars can be pushed in more easily.

## Aligning the washing machine

The washing machine must stand perfectly level on all four feet to ensure safe and proper operation.

Incorrect installation may increase electricity and water consumption and may cause the machine to move about.

## Screwing out and adjusting the feet

The four adjustable screw feet are used for levelling the washing machine. All four feet are screwed in when the appliance is delivered.

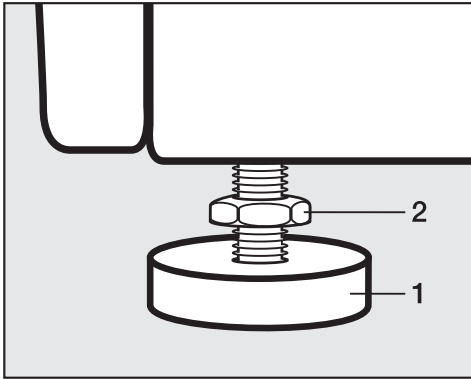

- Using the spanner supplied, turn counter nut **2** in a clockwise direction. Then turn counter nut **2** together with foot **1** to unscrew.

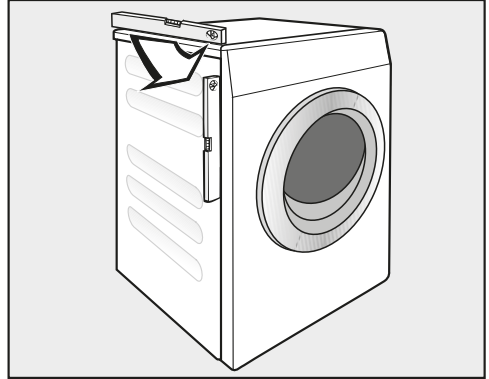

- Use a spirit level to check that the washing machine is standing level.
- Hold foot **1** securely with a pipe wrench. Turn counter nut **2** again using the spanner supplied until it sits firmly up against the housing.

 Risk of damage due to incorrectly aligned washing machine.

There is a danger of the washing machine moving about if the feet are not secured.

Turn all four counter nuts for the feet until they sit firmly up against the housing. Please also check this for the feet which did not need adjustment.

# Installation

## Fixing bracket for plinth

The fixing bracket prevents the washing machine from falling off a plinth during operation.

Fastening with the fixing bracket is only intended for plinths made from concrete. The plinth must be flat and level. The surface below the plinth must be able to withstand the physical loads. Prior to installation, ensure the plinth complies with the minimum dimensions.

Height 6 cm

:

Width: 60 cm

Depth: 65 cm

## Positioning the fixing bracket



**Risk of injury from sharp edges!**

The fixing bracket has sharp edges. You could cut yourself on the edges. Take care when handling the fixing bracket.

Wear gloves while installing the fixing bracket.

The front appliance feet must protrude by at least 3 mm from the bottom of the locknut. The washing machine must already be aligned (see “Installation – Aligning the washing machine”).

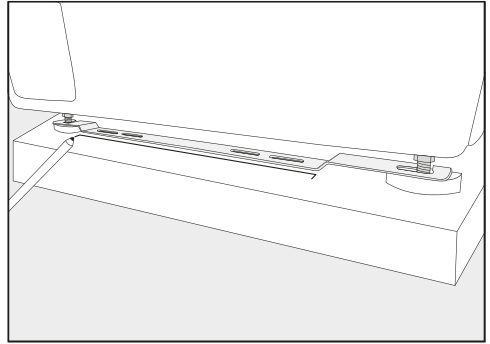

- Place the fixing bracket on the front appliance feet.
- Mark the position of the front edge of the fixing bracket with a pencil.
- Remove the fixing bracket from the feet.
- Carefully move the washing machine until you have enough space to install the fixing bracket.

## Installing the fixing bracket

- Place the fixing bracket on the marking on the plinth.
- In the middle of the two outer slotted holes, mark a point for each drill hole.
- Drill 2 holes (8 mm) with a depth of approx. 55 mm.
- Insert the plugs in the holes.

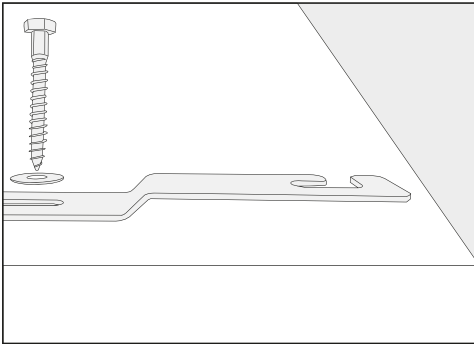

- Install the fixing bracket with the hexagonal screws and the washers.

Do not tighten the screws yet – this will allow the fixing bracket to be moved sideways.

## Securing the washing machine with the fixing bracket

- Push the washing machine back on to the installed fixing bracket.

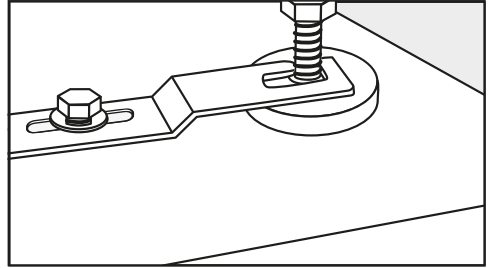

- Insert the appliance feet (the part between the foot and the locknut) into the openings in the fixing bracket.
- Push the fixing bracket to the right as far as it will go.
- Tighten the hexagonal screws using a spanner.

The washing machine is secured in the fixing bracket.

# Installation

---

## External control equipment

The XCI box accessory is needed to connect external control equipment, such as payment systems, dispensing systems or peak load control units.

## Payment system

This machine can be fitted with a payment system (optional accessory).

The necessary reprogramming must be carried out by Miele.

Coins/tokens must be removed from the coin box regularly. Otherwise, the payment system will become blocked.



## Water connection

### Cold water connection

The washing machine must be connected to a mains water supply in accordance with current local and national safety regulations.

The flow pressure must amount to a minimum of 100 kPa (1 bar) and must not exceed an overpressure of 1000 kPa (10 bar). If it is higher than 1000 kPa, a pressure reduction valve must be installed.

Connection to the mains water supply should incorporate a water tap with a  $\frac{3}{4}$ " threaded union. If this is not available, only a qualified plumber may connect the washing machine to the mains water supply.

The connection point is subject to mains water pressure.

Turn on the tap slowly and check for leaks. Correct the position of the washer and union if necessary.

The inlet hose for cold water is not intended to be used for a hot water connection.

A filter is located in the open end of the inlet hose and another in the intake point to protect the inlet valve. Neither filter may be removed.

### Hose extension

Longer hoses with a length of 2.5 m or 4.0 m are available from Miele as optional accessories (depending on country).

## Switching to cold water operation

If the washing machine is not connected to a hot water tap, you will have to configure the settings *Main wash water*, *Pre-wash water* and *Rinse water* to cold (see "Supervisor level").

- Unscrew the hot water hose.
- Screw on the stopper provided.

## Maintenance

Only use a genuine Miele hose should you ever need a replacement.

# Installation

## Hot water connection\*

The hot water temperature must not exceed 70°C.

To minimise energy consumption during operation with hot water, the washing machine should be connected to a suitable hot water ring circuit. So-called “transmission pipes” (single pipes to hot water generators) can result in cooling down of the water remaining in the pipes if not in constant use. More energy would then be consumed to heat the suds up again.

The same connection requirements as for cold water also apply to hot water.

The inlet hose (hot = red stripes) is connected to the water tap.

It is not possible to connect the washing machine to a hot water connection only.

\* Some machine versions do not come with a hot water hose.

## Switching to hot water operation

If the washing machine is to be connected to hot water, you will have to configure the settings *Main wash water*, *Pre-wash water* and *Rinse water* to warm (see “Supervisor level”).

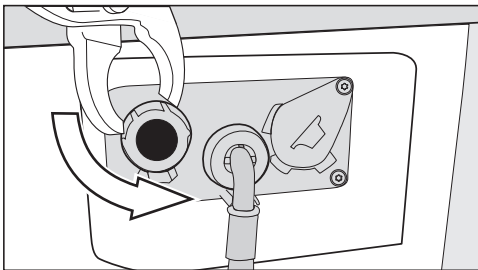

- Unscrew the stopper from the hot water valve.
- Screw on the hot water hose.

## IMPORTANT Australia and New Zealand

This appliance must be connected to the water supply in strict accordance with local and national requirements (e.g. Plumbing Code of Australia (PCA)).

This appliance must be installed according to AS/NZS 3500.1 and AS/NZS 3500.2. This washing machine has been supplied with a separate backflow prevention device.

- Disconnect mains power (switch off or unplug the plug).
- Turn off the water tap.
- Place the seals on both sides of the non-return valve.
- Connect the female end of the non-return valve to the water tap.
- Connect the hose to the male end of the non-return valve.
- Turn on the tap gradually to test for leaks.

If there is a leak, the connection might not be on securely, or it may have been screwed on at an angle. Unscrew and reconnect the water correctly before tightening it.

## Drainage

### Drain valve

The washing machine is drained using a motorised drain valve. A DN 70 angle connector can be used for draining the machine via an on-site floor drain (gully with odour trap).

### Drain pump

The suds are drained through a drain pump with a 1 m delivery head. For the water to drain freely, the hose must be free of kinks. An elbow piece (accessory) can be hooked onto the end of the hose.

### Drain hose connection options

1. Connected securely to a trapped waste pipe.
2. Connected over the rim of the laundry trough or into the sud-saver pipe of the laundry trough.
3. Connected securely to a floor drain (gully).

If required, the hose can be extended to a length of up to 5 m. The necessary parts can be ordered from Miele (depending on country).

For a delivery head of more than 1 m (up to a max. of 1.6 m) a replacement drain pump will need to be fitted. Please contact Miele for advice.

Waste water discharge from commercial clothes washing machines may require pre-treatment as determined by the utility operator.

# Installation

## Electrical connection

This description applies to washing machines both with and without a mains plug.

The following applies to washing machines with a mains plug:

- The washing machine is ready to be connected.
- The electrical socket must be easily accessible after installation so that the machine can be disconnected from the electricity supply if necessary.

 Damage caused by incorrect supply voltage.

The data plate indicates the nominal power consumption and the appropriate fuse rating.

Compare the specifications on the data plate with those of the mains electricity supply.

The washing machine may only be connected to a permanent electrical system that conforms to the national and local codes and regulations.

Do not connect the machine to an extension lead or multi-socket adapter as they do not guarantee the required safety of the appliance (e.g. danger of overheating).

If the appliance is hard wired, a dual circuit breaker must be provided on site. When switched off, there must be an all-pole contact gap of at least 3 mm in the isolator switch (including circuit breakers, fuses, and relays according to AS/NZS 3000). This connection must be carried out by a qualified and competent electrician.

The plug connector or isolator switch should be easily accessible at all times.

 Risk of electric shock!

If the washing machine is disconnected from the power supply, protective measures must be taken to ensure that the point of disconnection cannot accidentally be switched on again.

Make sure the isolator is lockable or the point of disconnection is monitored at all times.

New connections, modifications to the system, or servicing of the protective earthing conductor, including determining the correct fuse rating, must be carried out by a qualified and competent electrician, as they are familiar with the pertinent regulations and the specific requirements of the electric utility company.

If converting the washing machine to an alternative voltage, ensure that the connection data on the data plate (voltage, frequency and fuse rating) match the mains electrical supply. Observe the instructions in the wiring diagram. Conversion may only be performed by Miele or a Miele authorised service technician.

## Technical data

Height	850 mm
Width	596 mm
Width (for appliances with a stainless steel lid)	605 mm
Depth	714 mm
Depth with door open	1,132 mm
Weight	Approx. 100 kg
Maximum floor load in operation	3,000 Newton
Capacity	8.0 kg dry laundry
Supply voltage	See data plate on back of machine
Rated load	See data plate on back of machine
Fuse rating	See data plate on back of machine
A-rated sound emissions $L_{pA}$ in accordance with EN ISO 11204/11203	< 70 dB re 20 $\mu$ Pa
Minimum water flow pressure	100 kPa (1 bar)
Maximum water flow pressure	1,000 kPa (10 bar)
Intake hose length	1.55 m
Power cord length	1.80 m
Maximum drain height (drain pump)	1.00 m
LEDs	Class 1
Product safety standard	AS/NZS 60335
Test certificates awarded	See data plate
Frequency band of the Wi-Fi module	2.4000 GHz – 2.4835 GHz
Maximum transmission power of the Wi-Fi module	< 100 mW

# Supervisor level

---

## Opening the Supervisor level

- Switch on the washing machine.

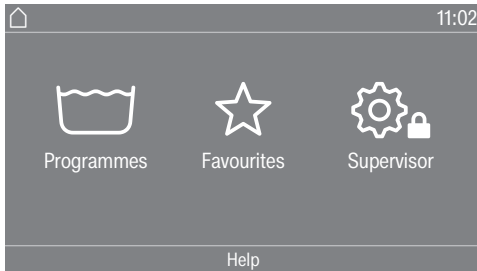

- Touch the Supervisor  sensor.

The display will change to show the Supervisor level menu.

## Code-based access

The Supervisor level is accessed using a code.

The code is **000** (factory default).

## Changing the code

You can change the Supervisor level access code to protect the washing machine from unauthorised access.

Please inform Miele if you have forgotten your new code. Miele will have to reset the code.  
Make a note of your new code and store it in a safe place.

## Closing the settings menu

- Touch the  sensor control.

The display will go back to the previous menu level.

- Touch the  sensor control.

The display will change to the main menu.

## Operation/display

### Language

The display can be set to appear in one of several different languages. You can selected the permanent operator language via the Language submenu.

When a programme is running, you can change the user language using the  sensor control.

### Language menu

The display can be set to one of several different user languages. This setting allows you to determine how languages can be selected.

#### International

6 languages are available. The  sensor control is not active. Note the setting [Set languages](#).

#### Language setting

The  sensor control can be used to select a language. All languages are available (factory setting).

You can change the order of the first 4 languages. These slots are allocated to the most commonly used languages.

#### Standard language

The user language cannot be changed. The user language is the same as the operator language. The  sensor control is not active.

### Set languages

The languages for the setting [Language](#) entry [International](#) can be changed.

6 languages can be selected. All languages are available.

If you wish to add a new language to the language menu:

- First select the language you want to replace.

All available languages are displayed.

- Select and confirm the language that is to replace the previous language.

The new language will appear in the place of the old one.

### Display brightness

The brightness of the display can be altered. The setting depends on the various lighting conditions in the place of installation.

It can be set to one of 10 different levels.

# Supervisor level

---

## Time

After selecting the clock format, you can set the time of day.

### Clock format

- 24 h clock
- 12 h clock
- No clock

### Set

- The time can be set.

## Date

The date can be set after selecting the date format.

### Date format

- DD.MM.YYYY
- YYYY.MM.DD
- MM.DD.YYYY

### Date

- The date can be set.

## Volume

The volume for various signal tones can be changed.

- Finish tone
- Keypad tone
- Welcome tone

The tones can be set to one of 7 different levels or switched off altogether.

- Fault alarm

The fault alarm can be activated or deactivated.

## Visibility parameters

Various parameters, such as the temperature, spin speed, Extras, etc., are displayed when a programme is selected. You can decide which parameters should not be displayed. These parameters can then not be edited during programme selection.

Factory setting: all parameters are visible (marked in orange)

### Sorting Extras

In the setting Visibility parameters, Sort "Extras" appears in the bottom line. Touch the sensor control to change the sequence of Extras (see "Supervisor level - Arranging programmes").



## “Display” off status

The display switches off to save energy. The *Start/Stop* sensor flashes slowly.

Changing this setting leads to increased energy consumption.

Off

The display does not switch off.

On (10 min.) Not curr.prog.

The display will remain on while the programme is running but will go out 10 minutes after the end of the programme.

Logo (10 min.) Not curr.prog.

The display stays switched on while the programme is running. The logo lights up 10 minutes after the end of the programme.

On after 10 min.

The display will go out after 10 minutes.

On (30 min.) Not curr.prog.

The display will remain on while the programme is running but will go out 30 minutes after the end of the programme.

Logo (30 min.) Not curr.prog.

The display stays switched on while the programme is running. The logo lights up 30 minutes after the end of the programme.

On after 30 min.

The display will go out after 30 minutes.

## “Machine” off status

In order to save energy, the washing machine will switch off automatically after the end of the programme or if no further selection is made. This can be changed.

Changing this setting leads to increased energy consumption.

- not switching off
- switching off after 15 minutes (factory default)
- switching off after 20 minutes
- switching off after 30 minutes

## Delay start

The delay start (Timer) display can be switched on or off.

Factory setting: On

## Memory

The washing machine will save the latest settings (temperature, spin speed and some of the options) which have been selected for a programme after the programme has started.

When the programme is selected again, the saved settings will appear in the display.

Factory setting: Off

# Supervisor level

---

## Temperature unit

You can select the unit for the temperature display.

Factory setting: °C/Celsius

## Weight unit

You can choose whether load quantities are displayed in “kg” or “lbs”. You can also switch this information off altogether.

Factory setting: kg

## Logo

You can choose whether the “Miele Professional” logo or your own logo appears in the display.

The option *Lauderette Logo* must be selected for the setting *Controls*.

## Supervisor code

You can change the Supervisor level access code to protect the washing machine from unauthorised access.

- Enter the current code.
- Then enter your new code.

## Programme selection

### Controls

You can select whether the machine is operated as a laundrette machine. Shortcuts are the easiest way to operate the machine. Operators cannot change the preset programmes.

**Useful tip:** Start by configuring all necessary settings and changes to the washing machine before adjusting any of the options below.

If “Lauderette, basic” or “Lauderette Logo” is selected, the supervisor level can no longer be opened from the display after the *Supervisor level* is closed. Please follow the instructions below if you wish to change any other settings.

### Opening the Supervisor level (laundrette mode)

- Switch on the washing machine and open the door.
- ① Touch the *Start/Stop* sensor and hold it down during steps ②–③.
- ② Close the washing machine door.
- ③ Wait until the *Start/Stop* sensor, which is now flashing rapidly, lights up constantly.
- ④ Release the *Start/Stop* sensor when the *Start/Stop* sensor lights up constantly.

## Control options

Standard (factory default setting).

All functions and programmes can be displayed.

## Launderette, basic

Up to 12 programmes are available. Go to Favourite programmes to select which programmes are to be listed.

## Launderette Logo

Up to 12 programmes are available. Go to Favourite programmes to select which programmes are to be listed.

## External programme selection

Programmes are selected using a communication module, e.g. an external terminal.

## **Programme packages**

The selection of programmes can be extended by activating single programmes from the target group programme packages.

The programmes selected from the programme packages (marked in orange) are displayed during programme selection.

## **Favourite programmes**

You can save up to 12 of your own customised wash programmes as Favourite programmes.

The saved programmes will be displayed under *Favourites*.

All programmes from the Favourites list are displayed with the control option Launderette, basic and Launderette Logo.

You can specify the control options under Controls.

**Useful tip:** You can assign a different colour to each programme. In this case, the Prog. colour allocation setting must be set to *On*.

## Changing favourite programmes

- Select the programme you wish to change or replace.
- Touch the programme icon or setting to be changed.

Another menu opens, enabling you to select a new programme or change the parameters.

- Touch the *Save* sensor.

Your selection is now active.

## Reducing the number of Favourite programmes

You can reduce the number of Favourite programmes by “deactivating” each one individually.

- Select the programme you wish to deactivate.
- Confirm the programme.
- Select <empty> from the list instead of a programme.

## Supervisor level

---

The selection in the ☆ Favourites and the selection in the Launderette, basic and Launderette Logo control option is reduced.

Once a programme has been deactivated, ∅ is displayed in its place. You can re-add a programme at any time.

The number of Favourite programmes can be reduced to 0 if you "deactivate" all programmes. In this case, the ☆ Favourites selection is no longer displayed in the main menu.

Do not reduce the number of Favourites to 0 if you want to set the Launderette, basic or Launderette Logo control option afterwards.

### Changing the sequence of Favourite programmes

You can change the sequence of Favourite programmes by moving the programmes around.

- Touch the programme that you wish to move.

An orange border appears around the selected programme.

- Touch the programme with your finger and keep your finger pressed down.
- Drag the programme to the required position.

### Special programmes

You can put together 5 special programmes and save them as washing programmes with your own programme names.

You must have already activated Special programmes under *Programme packages*.

Enter the names of your special programmes and their basic settings into the "Special programmes" table under the "Programme chart".

- Temperature: You can select a temperature in multiple increments from cold to 90°C.
- Wash block: You can select one or more wash blocks.
- Spin speed: You can select a spin speed in increments from 0 rpm to 1,400 rpm.

### Sort programmes

Programmes can be moved within the programme list and in the Favourites list.

Factory setting: Off

### Moving programmes

- Touch the sensor control for the programme you want to move.
- Press and hold the sensor until the frame changes.
- Drag the programme to the required position.

## Prog. colour allocation

You can assign a colour to a Favourite programme. In the Favourites list, each Favourite programme is given a coloured frame, which can be adjusted.

Factory setting: On

## Hygiene

The Maintenance wash hygiene programme is shown in the list of special programmes.

If a programme at a temperature below 60°C has been used, the prompt to start the Maintenance wash hygiene programme will appear in the display.

Factory setting: Off

## Expert code

A code needs to be entered to cancel a disinfection programme. The code can be changed.

The code is: 0 0 0

Make a note of your new code if you ever change it.

## Process technology

### Anti-crease

The anti-crease function helps prevent creasing if laundry is not going to be removed immediately after the end of the programme. The drum continues to turn at intervals for up to 30 minutes after the end of the programme.

The door can be opened at any time during the anti-crease phase.

Factory setting: Off

### Water level Cottons

In the *Cottons* programme, you can increase the water level of the main wash.

- + 0 mmWS (factory setting)
- + 10 mmWS
- + 20 mmWS
- + 30 mmWS

### Water level Minimum iron

In the *Minimum iron* programme, you can increase the water level of the main wash.

- + 0 mmWS (factory setting)
- + 10 mmWS
- + 20 mmWS
- + 30 mmWS

# Supervisor level

---

## Pre-wash temp. Cottons

In the *Cottons* programme, you can select the temperature of the pre-wash.

- 30°C (factory setting)
- 35°C
- 40°C
- 45°C

## Wash time

### Cottons pre-wash

In the *Cottons* programme, you can select the duration of the pre-wash.

- + 0 min (factory setting)
- + 6 min
- + 9 min
- + 12 min

### Cottons

In the *Cottons* programme, you can select the duration of the main wash.

- + 0 min (factory setting)
- + 10 min
- + 20 min
- + 30 min
- + 40 min

## Minimum iron

In the *Minimum iron* programme, you can select the duration of the main wash.

- + 0 min (factory setting)
- + 5 min
- + 10 min
- + 15 min
- + 20 min

## Pre-rinse Cottons

In the *Cottons* programme, a pre-rinse can be activated.

Factory setting: Off

## Pre-rinse Minimum iron

In the *Minimum iron* programme, a pre-rinse can be activated.

Factory setting: Off

## Pre-wash Cotton/M.iron

In the programmes *Cottons* and *Minimum iron*, you can choose whether a pre-wash is permanently activated or whether it can be selected during programme selection.

Factory setting: Menu selection

## Cottons rinses

In the *Cottons* programme, you can change the number of rinse cycles that are carried out.

- 1 rinse cycle
- 2 rinse cycles (factory setting)
- 3 rinse cycles
- 4 rinse cycles
- 5 rinse cycles

## Minimum iron rinses

In the *Minimum iron* programme, you can change the number of rinse cycles that are carried out.

- 2 rinse cycles (factory setting)
- 3 rinse cycles
- 4 rinse cycles

## Disinfection rinse

Additional rinses can be activated in disinfection programmes with a temperature of at least 60°C.

Rinsing is carried out with hot water.  
The programme duration is extended.

The laundry may feel hot at the end of the programme.  
Take care when removing items.

Factory setting: Off

## Auto load control

The washing machine is equipped with an automatic load control. In some programmes, the water levels and the programme cycle times are adapted to the load.

If the automatic load control is deactivated, the machine will always carry out the programme sequence based on a full load.

Factory setting: On

## Controlled energy cons.

With this option selected, the machine will optimise its energy consumption in the *White items*, *Coloured items* and *Minimum iron* programmes.

Factory setting: On

## Service

### Clean drain pump

The user sees a message when the drain pump filter has to be cleaned.

The message is displayed every 500 operating hours.

The message appears at the end of the programme.

Factory setting: Off

# Supervisor level

---

## Service interval

Service information can appear in the display. You can configure whether a date or the number of operating hours is displayed.

You can select up to 3 messages with your own text.

Your message is displayed at the end of the programme and can be acknowledged with *OK*. The same message appears at the end of the next programme.

### Settings

This setting allows you to determine the interval (by hours or date) at which the message appears.

- Factory setting: Off
- by time  
You can then select a time interval between 1-9999 hours.
- by date  
You can then select a date.

### Message text

Enter your individual message text for your planned maintenance work.

### Reset display

The message will appear until the display is permanently reset. The message then only appears again when the next interval is reached.

## External applications

### Availability of Miele digital products

The ability of Miele digital products depends on the availability of the services in your country.

The different services are not available in all countries.

For information about availability, please visit [www.miele.com](http://www.miele.com).

### Empty sensor

External hardware is connected via the Miele XCI box.

A suction lance contact can be used to detect whether external liquid detergent containers are empty. A message appears if a container is empty.

- Off (factory setting)
- Make contacts  
The suction lances have a normally open contact.
- Opener  
The suction lances have a normally closed contact.



## Early warning counter

External hardware is connected via the Miele XCI box.

An internal counter reports when an external dispenser container is almost empty. The counter in question then has to be reset.

## Automatic dispensing

Automatic dispensing via an external dispensing system can be activated

Factory setting: Off

## Adjustment value dosage 1–6

To address the tolerances that occur in the pump system over time, the dosage amount (ml/min) for the pumps can be corrected.

The calibration value can be reduced in 3 increments or increased in 3 increments.

The calibration value is increased or reduced by 1, 2 or 3 times the adjustment value based on the selected incremental setting.

The calibration value and the adjustment value must be added to the data for the dispenser pumps by Miele Customer Service.

## Peak load signal

External hardware is connected via the Miele XCI box.

The peak load cut-off function enables the washing machine to be connected to an energy management system. When a signal is registered, the washing machine's heater is switched off for a short period.

The washing machine may only be operated with a peak load system if this system is connected to the washing machine via the Miele XCI box.

- No function (factory setting)
- Peak load with 230 V
- Peak load with 0 V
- COM module

## Peak load prevention

The peak load cut-off function can be deactivated with disinfection programmes. When a signal is registered, the washing machine's heater is not switched off.

Factory setting: Off

# Supervisor level

---

## COM module selection

Your washing machine is equipped with an integrated Wi-Fi module. However, the machine can also be fitted with an external module.

- Off
- Internal module (factory setting)  
The internal Wi-Fi module is used.
- External module  
An XKM module or RS232 module is inserted into the module slot.

## Wi-Fi

Control the networking of your washing machine.

- Setup  
This message only appears if the washing machine has not yet been connected to a Wi-Fi network.
- Deactivate (visible when the network is activated)  
The network remains set up, the Wi-Fi function is switched off.
- Activate (visible if the network is deactivated)  
The Wi-Fi function is reactivated.
- Connection status (visible when the network is activated)
  - the quality of Wi-Fi reception
  - the network name
  - the IP address
- New setup (visible if set up)  
Resets the Wi-Fi login (network) to immediately re-establish a new connection.
- Reset (visible if set up)

The network is no longer set up. To use the network again, a new connection must be established.

- The Wi-Fi is switched off.
- The Wi-Fi connection will be reset to the factory default setting.

## Wi-Fi setup

There are 2 possible connection methods.

### WPS

- Activate the WPS function on your router within 2 minutes.

**Useful tip:** If the connection has not been set up when the timeout has finished counting down, repeat the process.

### Soft AP

- Activate the function with the Miele App on your smart device within 10 minutes.

**Useful tip:** The App will guide you through the remaining steps.

## Network time

The date and time can be synchronised via the network.

### - Off

The date and time are not synchronised via the network.

### - as a master

The machines are in a network but are not connected to the internet. One machine is declared as the master and sends data to the *slave* devices.

### - as a slave

The machines are in a network with internet connection. All machines are configured as *slaves*. Data is synchronised over the Internet.

## Remote

Programmes are selected on an external terminal.

Factory setting: On

## RemoteUpdate

The RemoteUpdate function is used for updating the software in your washing machine.

Factory setting: On

If you do not install a RemoteUpdate, you can continue to use your washing machine in the usual way. However, Miele recommends installing RemoteUpdates.

## Activation

The RemoteUpdate menu option is only displayed and can only be selected if you have integrated your washing machine into your Wi-Fi network.

Some software updates can only be carried out by a Miele service technician.

# Supervisor level

---

## Running a RemoteUpdate

If a RemoteUpdate is available for your washing machine, it will be displayed automatically in the open Supervisor level.

You can choose to start the RemoteUpdate immediately or wait until later. If you select “Start later”, the prompt to run the RemoteUpdate will be displayed again the next time you switch on your washing machine.

The RemoteUpdate can take several minutes.

Please note the following information about the RemoteUpdate function:

- You will only receive a message when a RemoteUpdate is available.
- Once a RemoteUpdate has been installed, it cannot be undone.
- Do not switch off the washing machine during a RemoteUpdate. Otherwise, the RemoteUpdate will be aborted and will not be installed.

## SmartGrid

The SmartGrid setting (available depending on country) is only visible if a Wi-Fi network is set up and activated. This function can be used for starting your washing machine automatically at a time when your energy supplier's energy costs are most economical.

Activating SmartGrid gives the Timer sensor a new function. Use the “Timer” sensor to set SmartStart. The washing machine will then start within the timeframe specified by you when it receives a signal from your energy supplier. If it has not received a signal from the energy supplier by the latest start time set, the washing machine will start automatically.

Factory setting: Off

## Machine parameters

### Suds cooling

Additional water flows into the drum at the end of the main wash to cool the suds down.

Suds cooling takes place when a programme with a temperature of 70°C or higher is selected.

Suds cooling should be activated:

- to prevent the danger of scalding if the drain hose is hooked over the edge of a laundry tub or trough.
- where the drainage pipes are rated less than 70°C.

Factory setting: On

### Water intake

#### Pre-wash

You can select the type of water for the pre-wash.

- cold

Only cold water is used for the pre-wash.

- hot

Hot water is also added for the pre-wash.

Hot water can only be added if the wash temperature is above 30°C.

#### Main wash

You can select the type of water for the main wash.

- cold

Only cold water is used for the main wash.

- hot

Hot water is also added for the main wash.

Hot water can only be added if the wash temperature is above 30°C.

If the washing machine is not connected to hot water, programme durations will be longer and may deviate from the remaining runtimes displayed.

#### First rinse

You can select the water type for the first rinse in some programmes.

- cold (factory setting)

Only cold water is used for the first rinse.

- hot

Hot water is also added to the first rinse.

# Supervisor level

---

## Final rinse

You can select the water type for the final rinse in some programmes.

- cold (factory setting)  
Only cold water is used for the final rinse.
- hot  
Hot water is also added for the final rinse (only possible for programmes with a temperature of at least 60°C).

## Temperature reduction

The suds temperature can be reduced to prevent the suds from boiling too early in high-altitude locations.

Factory setting: Off

## Low water pressure

If the water pressure is below 100 kPa (1 bar), the programme will be cancelled and the fault message **Check water inlet** will appear.

If the on-site water pressure cannot be increased, activating the **Low water pressure** setting will prevent the programme from being cancelled.

Factory setting: No

## CapDosing

You can choose whether **CapDosing** is displayed in the programme settings.

Factory setting: On

## Legal information

### Open source licences

You can view information at this point.

### **Copyright and licences for operating and control software**

For the purpose of operating and controlling the machine, Miele uses proprietary or third-party software that is not covered by open source licensing terms. These items of software/software components are protected by copyright. The copyright powers of Miele and third parties must be respected.

In addition, the machine contains software components which are distributed under open source licensing terms. You can access these open source components along with the associated copyright notices, copies of the valid licensing terms and any further information in the machine under the menu option **Settings | Machine parameters | Legal information | Open source licences**. The liability and warranty arrangements for the open source licences displayed at this location only apply in relation to the respective rights holders.

## Payment system

The XCI-AD or XCI box accessory unit is required to connect a payment system.

If you wish to change the settings later, please contact Miele.

### **Settings for payment systems**

You would like to connect a payment system.

- No payment system  
The next settings are skipped and initial commissioning can be completed.
- Programme operation  
The machine is operated using a payment system. The user purchases a wash programme.
- Time operation  
The machine is operated using a payment system. The user purchases a time-controlled programme.
- Timed operation with pulse counter  
For payment systems where the usage period is increased each time a coin is inserted.
- COM module  
The machine is operated by a central control unit.

# Supervisor level

---

## Payment system lock

To avoid tampering, a programme lock can be set up in programme operation. If the lock is applied, the programme is interrupted and payment credit is lost as soon as the door is opened.

To offer the possibility to add laundry, the time when the lock activates can be adjusted.

- Off
- As soon as the programme starts
- 1 minute after the start of the programme
- 2 minutes after the start of the programme
- 3 minutes after the start of the programme (factory setting)
- 4 minutes after the start of the programme
- 5 minutes after the start of the programme

## Programme cancellation

A programme that is currently running can be interrupted even if it is locked.

- On, without code (factory default setting)
- On, with code  
(code from Expert code setting)
- Do not cancel

## F-back signal to pay system

Setting the feedback signal for the payment system.

- Factory setting: Off
- At the end of the programme  
The feedback signal is sent at the end of the programme.
- Release of the start button  
The feedback signal is sent when the start button is released.
- Start and end of the programme  
The feedback signal is sent at the start and the end of the programme.
- During the running programme  
The feedback signal is sent continuously from the start until the end of the programme.



## FOC programmes

In payment system mode, you can decide whether the Drain/Spin programme can be used for free.

Factory setting: Off

## Clear paid signal

The “Paid” signal in payment system mode can be applied until the end of the programme or discarded if the programme is not started after 5 minutes.

Factory setting: Off

## Debounce time

The debounce time for the payment signal can be adjusted.

- Short  
For coin boxes. (factory default setting)
- Long  
For central control units.



**Miele Australia Pty. Ltd.**

ACN 005 635 398

ABN 96 005 635 398

Melbourne:

Level 4, 141 Camberwell Road

Hawthorn East, VIC 3123

Telephone: 1300 731 411

service.prof@miele.com.au

**[www.miele.com.au/professional](http://www.miele.com.au/professional)  
[professional.sales@miele.com.au](mailto:professional.sales@miele.com.au)**

**Miele New Zealand Limited**

IRD 98 463 631

8 College Hill

Freemans Bay

Auckland 1011

New Zealand

Telephone: 0800 4 MIELE

(0800 464 353)

[www.miele.com.au/professional](http://www.miele.com.au/professional)

[professional.sales@miele.com.au](mailto:professional.sales@miele.com.au)



Miele Global Headquarters: Miele & Cie. KG  
Carl-Miele-Straße 29, 33332 Gütersloh, Germany

PWM 908

en-AU, NZ

M.-Nr. 12 716 490 / 00