

Miele



Operating and installation instructions
Commercial tumble dryer
PDR 910 G
Gas-heated

To avoid the risk of accidents or damage to the machine, it is **essential** to read these instructions before it is installed and used for the first time.

en-GB

M.-Nr. 12 143 500

Contents

Caring for the environment	6
Warning and Safety instructions	7
Take these safety precautions if you smell gas	7
Installation site	8
Appropriate use	8
Foreseeable misuse	9
Technical safety	9
Correct use.....	11
Accessories	12
Description of the machine	14
Operating the tumble dryer	15
Control panel.....	15
Sensor controls and touch display with sensor controls.....	16
Main menu	16
“☐ Programmes” menu.....	16
“☆ Favourites” menu.....	16
“⚙ Supervisor” menu	16
Operating examples	16
Selection lists.....	16
Setting numerical values	17
Pull-down menu.....	18
Exiting the menu	18
Help display.....	19
Initial commissioning	20
Switching on the tumble dryer	20
Reference to optional external devices	20
Setting the display brightness	21
Setting the date	21
Confirming the time of day display query	21
Selecting programme packages	22
Completing the initial commissioning process.....	22
Drying	24
1. Notes on correct laundry care	24
Washing before drying	24
Removing foreign objects	24
Care symbols.....	24
2. Loading the tumble dryer.....	25
3. Selecting a programme	25
Switching on the tumble dryer	25
4. Selecting programme settings.....	26
Select the drying level.....	26
Selecting extra options	26
5. Starting a programme	28
Payment device (optional).....	28
Calling up current programme parameters	28
Programme running time/Time left estimation	28
End of the programme	29
End of programme	29
Removing the laundry	29
Care notes	29

Timer	30
Prerequisite for setting the timer	30
Setting the timer	30
Programme overview	31
“Label” programme package	31
“Standard” programme package	32
“Sport” programme package	35
“Flatwork” programme package	36
“Bedding” programme package	37
“Buildings maintenance” programme package	38
“Fire brigade” programme package	39
“WetCare” programme package	40
“Equestrian” programme package	41
“Special programmes” programme package	42
“Individual programmes” programme package	43
Changing the programme sequence	44
Changing a programme once it has started	44
Cancelling the current programme	44
Reselecting a cancelled programme	44
Time left	45
Supervisor level	46
Opening the Supervisor level	46
Access via code	46
Change code	46
Closing the settings menu	46
Controls / Display	46
Language	46
Language entry	46
Set languages	47
Display brightness	47
Clock display	47
Date	47
Volume	47
Res. moisture display	48
Visibility parameters	48
Display off status	48
Machine off status	49
Delay start	49
Memory	49
Temperature unit	49
Weight unit	49
Change code	49
Programme selection	49
Controls	49
Programme packages	50
Favourite programmes	51
Special programmes	51
Sort programmes	52
Prog. colour allocation	53

Contents

Process technology.....	53
Anti-crease	53
Drying levels	53
Further cooling.....	53
Cooling down temperature.....	53
Door opening status.....	53
Service	54
Clean out the airways	54
Clean the filters.....	54
Service interval.....	54
External applications.....	55
External exhaust flap.....	55
Additional fan	55
Pressure sensor	55
Peak load signal	55
Peak load prevention.....	56
COM module selection	56
Availability of Miele digital products	56
WiFi / LAN	56
Remote.....	57
Remote update	57
Machine parameters.....	57
Legal information	57
Payment system.....	58
Setting for payment systems.....	58
Connectivity	59
Pairing instructions	59
Opening the supervisor level	59
Establishing the network connection via WPS	59
Establishing the network connection via soft AP	59
Establishing the network connection using a LAN cable.....	59
Technical data	60
Cleaning and care	61
Cleaning the fluff filter	61
Removing the fluff filter	61
Dismantling the fluff filter.....	61
Cleaning the fluff filter parts (dry)	62
Cleaning the fluff filter parts (wet)	62
Inserting the fluff filter	62
Cleaning the air supply area.....	63
Rapid cleaning.....	63
Additional cleaning.....	63
Removing the cover.....	65
Securing the cover.....	65
Problem solving guide.....	67
Fault diagnosis	67
Customer Service Department.....	69
Contact in case of malfunction	69
Optional accessories	69

Installation	70
Installation locations.....	70
Front view	70
Side view.....	70
Rear view	70
View from above	71
Installation on a plinth.....	71
Installation.....	72
Transporting the tumble dryer	72
Levelling	73
Securing the tumble dryer against slipping	73
Electrical connection	74
Supply air and exhaust air management.....	75
Ventilation.....	75
Design of the exhaust air management system.....	75
Calculating the total ducting length	76
Exhaust duct dimensions	77
Exhaust air management with plug-in pipes.....	78
Exhaust air management with flexible aluminium hose.....	79
Shared exhaust air ducts	79
Gas	81
Connection and conversion instructions	81
Tables.....	83
Optional accessories	86
Communication box.....	86
XKM 3200 WL PLT.....	86
Payment systems	87
Technical data	88
UK declaration of conformity.....	88

Caring for the environment

Disposal of the packing material

The packaging is designed to protect the appliance from damage during transportation. The packaging materials used are selected from materials which are environmentally friendly for disposal and should be recycled.

Recycling the packaging reduces the use of raw materials in the manufacturing process and also reduces the amount of waste in landfill sites.

Disposing of your old machine

Old electrical and electronic appliances often contain valuable materials. However, they also contain harmful substances which were essential for their correct functioning and safety. These could be hazardous to human health and to the environment if disposed of with household waste or if handled incorrectly. Please do not, therefore, dispose of your old machine with household waste.

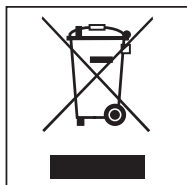

Please dispose of it at your local community waste collection/recycling centre for electrical and electronic appliances. Consult your dealer if necessary.

Please ensure that your old machine poses no risk to children while being stored for disposal.

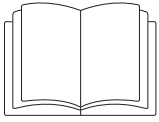

- ▶ It is essential to read these instructions.

This tumble dryer complies with all current local and national safety requirements. However, inappropriate use can lead to personal injury and damage to property.

Read the operating instructions carefully before using the tumble dryer. They contain important information on safety, installation, use and maintenance. This prevents both personal injury and damage to the tumble dryer.

In accordance with standard IEC 60335-1, Miele expressly and strongly advises that you read and follow the instructions in the chapter on installing the tumble dryer as well as the safety instructions and warnings.

Miele cannot be held liable for damage caused by non-compliance with these instructions.

Keep these operating instructions in a safe place and pass them on to any future owner.

When instructing other people how to use the tumble dryer, they must be made aware of these safety and warning instructions.

During installation, the technical regulations for gas installations as well as national and regional building regulations, fire regulations and specifications from the relevant gas supply companies must be adhered to.

When planning a gas-heated system, contact the relevant gas supply company and a building regulations inspector.

- ▶ In the event of a fault or when carrying out cleaning and maintenance, the on-site manual gas shut-off valve and the shut-off device on the gas meter must be closed.
- ▶ Before completing commissioning, maintenance, conversion and repair work, all gas-conducting components – from the manual shut-off valve to the burner jet – must be checked for leaks. Particular attention must be paid to the measurement connections on the gas valve and on the burner. Checks must be performed when the burner is both switched on and switched off.
- ▶ Carry out an annual visual inspection of the gas supply and gas products in the property. This inspection must comply with applicable national regulations.

Take these safety precautions if you smell gas

- Extinguish all flames immediately.
- Close the on-site gas shut-off device, the gas shut-off device on the gas meter or the main gas shut-off device immediately.
- Open all windows and doors immediately.
- Do not light any naked flames (e.g. matches or lighters).
- Do not smoke.
- If there is the smell of gas in a room, never enter the room with a naked flame.
- Do not carry out any actions that will create electrical sparks (such as pulling out electrical plugs or pressing electrical switches or bells).
- If you cannot find the cause of the gas smell and all gas valves have been shut off, please call the gas supply company immediately.

If other persons are being shown how to operate the appliance, they must be given and/or made aware of these important safety precautions.

Warning and Safety instructions

Installation site

Gas-heated tumble dryers must **not** be operated in a room where cleaning machines operate with solvents containing perchloroethylene or CFCs. During combustion, any vapours that are emitted will break down into hydrochloric acid, leading to consequential damage affecting laundry and the appliance. Air exchange must not take place if appliances are set up in separate rooms.

Rooms with fuel-burning installations must be adequately aerated and ventilated. Any gas-heated appliance must be considered to be a fuel-burning installation (regardless of its gas flow rate).

If no low pressure occurs when a full fire is burning in all fuel-burning installations, this means that the room ventilation is working properly, even if the exhaust gases from the installations are being extracted mechanically. This ensures that the gas is being combusted correctly and that the exhaust gases are being evacuated completely.

It must not be possible to seal off aeration and ventilation openings.

⚠ Before completing commissioning, maintenance, conversion and repair work, all gas-conducting components – from the manual shut-off valve to the burner jet – must be checked for leaks.

Particular attention must be paid to the measuring stubs on the gas valve. Checks must be performed when the burner is both switched on and switched off.

Appropriate use

- ▶ The tumble dryer is intended for installation in a commercial environment.
- ▶ This tumble dryer is only intended for drying fabrics which have been washed in a water solution, and marked on the manufacturer's care label as being suitable for tumble drying. "Dry cleaning kits" for freshening up garments in a tumble dryer are increasingly available on the market. If using, do so at your own risk, and follow the instructions provided on the packaging. Any other applications may be dangerous. Miele cannot be held liable for damage resulting from incorrect or improper use or operation.
- ▶ The tumble dryer is not intended for outdoor use.
- ▶ The tumble dryer must not be used in a non-stationary location (e.g. on a ship).
- ▶ Do not install the tumble dryer in a room where there is a risk of frost. At temperatures around freezing point, the tumble dryer may not be able to operate properly. The permitted room temperature is between 2 °C and 40 °C.
- ▶ If the machine is used in a commercial environment it may only be operated by instructed/trained personnel. If the machine is used in a publicly accessible area, the supervisor must ensure that it can be operated safely without risk of danger.
- ▶ This appliance can only be used by people with reduced physical, sensory or mental capabilities, or lack of experience or knowledge, if they are supervised whilst using it or have been shown how to use it in a safe way and understand and recognise the consequences of incorrect operation.
- ▶ Children under 8 years of age must be kept away from the tumble dryer unless they are constantly supervised.
- ▶ Children 8 years and older may only use the tumble dryer unsupervised if they have been shown how to use it safely and recognise and understand the consequences of incorrect operation.
- ▶ Children must not be allowed to clean or maintain the tumble dryer unsupervised.
- ▶ Please supervise children in the vicinity of the tumble dryer and do not let them play with it.
- ▶ This tumble dryer may also be operated in public areas.

Warning and Safety instructions

▶ Any uses other than those listed above are prohibited. The manufacturer accepts no liability in such cases.

Foreseeable misuse

- ▶ Do not make any alterations to the tumble dryer, unless authorised to do so by Miele.
- ▶ Do not lean on the tumble-dryer door. Otherwise, the tumble dryer may tip over, causing injury to yourself or others.
- ▶ Do not use a pressure washer or water jet to clean the tumble dryer.
- ▶ The tumble dryer must be serviced in a timely and professional manner. Otherwise, there is a potential risk of loss in performance, faults and fire.
- ▶ Benzene, petrol, paraffin, or any easily flammable liquid must not be stored or used near the machine. Danger of explosion.
- ▶ Do not expose the dryer to air which is contaminated with vapour of chlorine, fluorine or other solvents. Danger of fire.
- ▶ To prevent the risk of fire, the following items must not be dried in this tumble dryer:
 - Items which have not been washed.
 - Items which have not been thoroughly cleaned and are still soiled with grease, oil or other deposits (such as kitchen linens or cosmetics cloths with cooking oils, grease, lotions, etc). If items have not been thoroughly cleaned, there is a danger that they might ignite when heated, even after they have been removed from the tumble dryer at the end of the programme.
 - Items (e.g. mops and floor cloths) that have been treated with inflammable cleaning agents or which contain residues of acetone, alcohol, benzene, petrol, kerosene, stain remover, turpentine, wax and wax remover or other chemicals.
 - Items which have been splashed with hair lacquer, hair spray, nail varnish remover or similar substances.

Wash heavily soiled items thoroughly by increasing the amount of detergent and selecting a high washing temperature. If in doubt, wash the items several times.

- ▶ Danger of squashing or cutting fingers etc. around the drum door hinges and the fluff filter cover. Use the appropriate handles and release catches only.
- ▶ Always make sure that the drum is stationary before reaching in to remove laundry. Do not touch the drum whilst it is still rotating.
- ▶ In many programmes, the heating phase is followed by a cooling down phase to ensure that the items are not too hot to handle when you remove them (this also avoids the danger of the laundry self-igniting). The programme is not finished until the cooling down phase is complete. Ensure that you always wait until the end of the programme before removing the laundry.

Technical safety

- ▶ This tumble dryer must only be set up and commissioned by a Miele Service technician or authorised Miele Service Dealer.
- ▶ Before installation check the tumble dryer for any obvious damage. A damaged tumble dryer must not be installed and/or used.
- ▶ Do not make any alterations to the tumble dryer, unless authorised to do so by Miele.
- ▶ Do not connect the tumble dryer to the power supply by an extension lead (fire hazard due to overheating).
- ▶ Do not operate the tumble dryer in a room where cleaning machines operate with solvents containing CFCs. During combustion, any vapours that are emitted will break down into hydrochloric acid, leading to consequential damage affecting laundry and the machine. Air exchange must not take place between rooms if machines are set up in separate rooms.

Warning and Safety instructions

- ▶ Fire hazard due to controllable socket. This tumble dryer must not be connected to a controllable socket (e.g. a timer). There is a risk of the laundry self-igniting if the tumble dryer's cooling phase is interrupted.
- ▶ The electrical safety of this tumble dryer can only be guaranteed when correctly earthed. It is essential that this standard safety requirement is met. If in any doubt, please have the on-site wiring system tested by a qualified electrician. Miele cannot be held liable for the consequences of an inadequate earthing system (e.g. electric shock).
- ▶ The tumble dryer is only electrically disconnected from the power supply, if
 - the plug has been disconnected from the socket.
 - it is switched off at the main switch, or the mains electrical fuse is disconnected (on site).
- ▶ The plug must be easily accessible so that the tumble dryer can be disconnected from the power supply at any time. The operator must be able to check from any access point that the plug is still removed.
- ▶ If the appliance is hard wired, adequate provision must be made on site to switch off all poles to disconnect the tumble dryer from the power supply.
- ▶ If the mains connection cable is faulty it must always be replaced by a Miele authorised technician to protect the user from danger.
- ▶ Tumble dryers with damage to the control panel or wire insulation must not be used until they have been repaired.
- ▶ Unauthorised repairs could result in unforeseen dangers for the user, for which Miele cannot accept liability. Repairs should only be undertaken by a Miele authorised technician, otherwise any subsequent damage will not be covered by the warranty.
- ▶ Faulty components may only be replaced by genuine Miele spare parts. Miele can only guarantee the safety standards of the appliance when Miele replacement parts are used.
- ▶ Only operate the tumble dryer when all removable outer panels are in place so that it is impossible to touch an electrical component or moving part.
- ▶ During the drying process, the door glass and the frame around the drum door will get hot. Please be aware that the laundry may also be hot if it is removed from the tumble dryer before the end of the drying programme.
- ▶ To ensure the correct performance of the tumble dryer and to prevent the risk of faults and fire, it is important to carry out maintenance on a regular basis.
- ▶ In the event of a fault and for cleaning and maintenance purposes, the tumble dryer must be disconnected from the power supply. The tumble dryer is only disconnected from the power supply, if:
 - It is switched off at the wall socket or the plug is withdrawn.
 - The mains fuse is disconnected.
 - The mains fuses have been completely removed.
- ▶ The tumble dryer must not be used in non-stationary installation sites (e.g. on a ship).
- ▶ Follow the instructions in "Installation" and "Technical data".
- ▶ The tumble dryer may only be operated when the ducting has been installed and the room is sufficiently ventilated.
- ▶ The vent ducting must never be installed in any of the following flues or shafts:
 - Chimneys or smokestacks that are in use.
 - Shafts that are used to ventilate installation rooms with fireplaces.
 - Flues that are used by third parties.

Smoke or exhaust gas that is fed back into the flue or shaft may be toxic.

Warning and Safety instructions

► Regularly check all components in the vent ducting (e.g. wall pipe, external grille, bends, elbows, etc.) to make sure air can move through them and to ensure that they are working properly. Clean components when necessary. Fluff deposits in the vent ducting system will prevent the air from being extracted properly and, as a result, will stop the tumble dryer from working properly.

If existing vent ducting is due to be used, it must be checked before being connected to the tumble dryer.

Low pressure must not occur in the vent ducting.

► There is a risk of suffocation and poisoning due to exhaust gases being sucked back if gas-powered flow heaters, gas-powered room heaters, coal-burning stoves with a flue connection, etc., are installed in the same room, in the same flat or in neighbouring rooms and the negative pressure is 4 Pa or more.

The following measures for suitable room ventilation (examples) can help to prevent negative pressure in the installation area:

- Install suitably sized vents that cannot be closed in the exterior walls.

Please always seek approval from your building regulations inspector to confirm that the appliance can be operated without risk and that negative pressure of over 4 Pa can be prevented.

► If multiple tumble dryers are to be connected to one vent ducting, a non-return flap must be installed directly on the duct for each tumble dryer.

If this requirement is not observed, the tumble dryers may be damaged and their electrical safety could be affected.

► Follow the instructions in “Installation of the ducting”.

► Do not block the gap between the bottom of the tumble dryer and the floor with plinth facings, deep pile carpet etc.

► Ensure that no closeable door, sliding door or an oppositely hinged door is installed that would hinder the drum door being opened in any way.

► This tumble dryer is supplied with a special lamp to cope with particular conditions (e.g. temperature, moisture, chemical resistance, abrasion resistance and vibration). This special lamp must only be used for the purpose for which it is intended. It is not suitable for room lighting. Replacement lamps may only be fitted by a Miele authorised technician or by the Miele Customer Service Department.

► Installing thermal shut-off equipment on site is recommended.

► If gas-heated appliances are accessible to anyone, it is also necessary to check whether a gas flow monitor needs to be used.

Correct use

► Do not lean on the tumble-dryer door. Otherwise, the tumble dryer may tip over, causing injury to yourself or others.

► Always close the drum door after each drying cycle. This will prevent:

- Children climbing into the tumble dryer or hiding things in it.
- Pets or other small animals climbing into the tumble dryer.

► Do not use a pressure washer or water jet to clean the tumble dryer.

► Keep the room where the tumble dryer is located free from dust and fluff. If the air that is taken into the machine contains dirt particles, this can cause blockages. A fault may then occur and there is a risk of fire.

► Never operate the tumble dryer without the fluff filter or with a damaged fluff filter. This could lead to malfunctions. Fluff can clog the air channels, heating elements and vent ducting, which could result in a fire. In this case, stop the tumble dryer immediately and replace the damaged fluff filter.

► The fluff filter must be cleaned on a regular basis.

Warning and Safety instructions

- ▶ To ensure problem-free operation of the tumble dryer:
 - Clean the surface of the fluff filter after each drying cycle.
 - In addition, the fluff filter and the air passages must be cleaned when prompted by the display.
- ▶ To prevent the risk of fire, the following items must not be dried in this tumble dryer:
 - Items which have not been washed.
 - Items which have not been thoroughly cleaned and are still soiled with grease, oil or other deposits (such as kitchen linens or cosmetics cloths with cooking oils, grease, lotions, etc). If items have not been thoroughly cleaned, there is a danger that they might ignite when heated, even after they have been removed from the tumble dryer at the end of the programme.
 - Items (e.g. mops and floor cloths) that have been treated with inflammable cleaning agents or which contain residues of acetone, alcohol, benzene, petrol, kerosene, stain remover, turpentine, wax and wax remover or other chemicals.
 - Items which have been splashed with hair lacquer, hair spray, nail varnish remover or similar substances.

Wash heavily soiled items thoroughly by increasing the amount of detergent and selecting a high washing temperature. If in doubt, wash the items several times.

- ▶ Do not install the tumble dryer in a room where there is a risk of frost. At temperatures around freezing point, the tumble dryer may not be able to operate properly. The permitted room temperature is between 2 °C and 40 °C.
- ▶ Remove all items from the pockets of the laundry to be dried (e.g. lighters, matches, keys).
- ▶ In many programmes, the heating phase is followed by a cooling down phase to ensure that the items are not too hot to handle when you remove them (this also avoids the danger of the laundry self-igniting). The programme is not finished until the cooling down phase is complete. Ensure that you always wait until the end of the programme before removing the laundry.
- ▶ Fire hazard due to controllable socket. This tumble dryer must not be connected to a controllable socket (e.g. a timer). There is a risk of the laundry self-igniting if the tumble dryer's cooling phase is interrupted.
- ▶ The programme ends when the cooling phase starts. Many programmes are followed by the cooling phase to ensure that the items of laundry are kept at a temperature that will not cause them damage (for instance to prevent the risk of the laundry self-igniting). Always remove all items of laundry from the tumble dryer immediately after the cooling phase.
- ▶ Fabric conditioner and similar products must be used according to the instructions on the manufacturer's packaging.
- ▶ Benzene, petrol, paraffin, or any easily flammable liquid must not be stored or used near the machine. Danger of explosion.
- ▶ Do not expose the dryer to air which is contaminated with vapour of chlorine, fluorine or other solvents. Danger of fire.
- ▶ For tumble dryers with stainless steel surfaces:
The stainless steel surfaces must not come into contact with liquid cleaning and disinfecting agents which contain chlorine or sodium hypochlorite. These agents can have a corrosive effect on stainless steel.
Aggressive vapours containing chlorine can also be corrosive.
Do not store containers of these agents near the tumble dryer.

Accessories

- ▶ Accessory parts may only be fitted when expressly approved by Miele. If other parts are used, warranty, performance and product liability claims will be invalidated.

Warning and Safety instructions

- ▶ Make sure that you order the correct plinth for this tumble dryer (available from Miele as an optional accessory).

 Miele cannot be held liable for damage caused by non-compliance with these Warning and Safety instructions.

Decommissioning the tumble dryer

- ▶ Before disposing of a tumble dryer, render the door lock inoperable so that children cannot lock themselves in the machine by mistake and endanger their lives.

Description of the machine

PDR 910 (gas-heated)

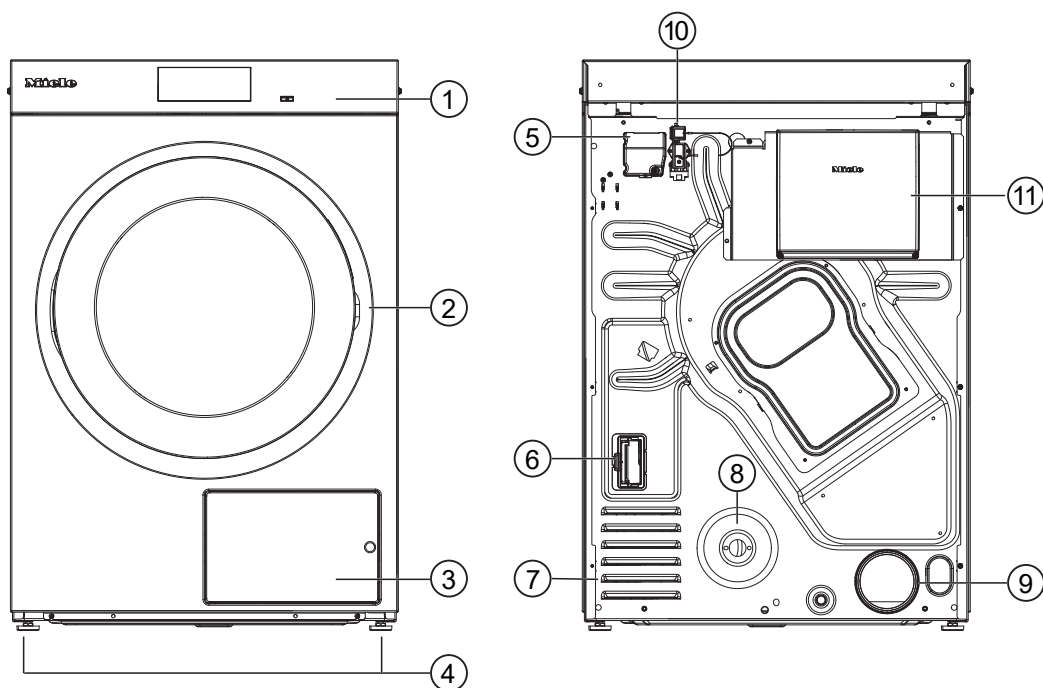

- ① Control panel with touch display
- ② Door
- ③ Fluff filter flap
- ④ 4 height-adjustable screw feet
- ⑤ Electrical connection
- ⑥ Communication module slot
- ⑦ Intake vents for drying air
- ⑧ Gas connection 1/2" acc. to ISO 7-1
- ⑨ Exhaust duct Ø 100 mm
- ⑩ Connection for communication box
- ⑪ Communication box (optional)
For setting up a connection with external systems

Control panel

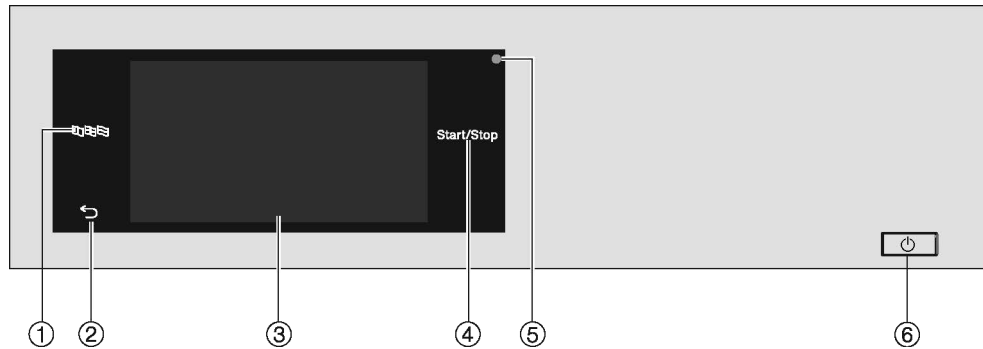

①  **Language sensor control**

For selecting the current user language

At the end of the programme, the language is automatically reset to the language set at the supervisor level.

② **Back sensor control** 

Takes you back one level in a menu.

③ **Touch display**

④ **Start/Stop sensor control**

For starting the selected drying programme and cancelling a programme once it has started. The programme selected can be started as soon as the sensor control starts flashing.

⑤ **Optical interface**

































Used for data transfer by the Customer Service Department.

⑥  **button**

For switching the tumble dryer on and off. Depending on the programming at supervisor level, the tumble dryer switches off automatically to save energy. It is switched off an adjustable time after the end of the programme/Anti-crease phase, or after being switched on if no further selection is made.

Operating the tumble dryer

Sensor controls and touch display with sensor controls

The sensor controls , , , , , , , , , , , , , , , , , , , , , , , , , , , , , , , , , ,

The orange scroll bar in the bottom display area shows that there are further options to choose from.

- To select the required drying programme, touch the programme name with your finger.

The display will now change to the standard menu for that programme.

“Extras” menu (multiple selection)

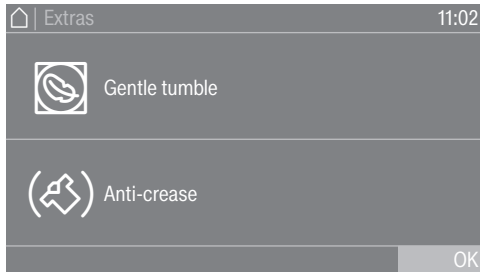

To select one or more *Extras*, touch the required *Extras* with your finger.

Currently selected *Extras* are marked orange. To deselect an *Extra* simply touch the *Extra* again.

Setting numerical values

You can set numerical values in some menus. You can set the numerical values by swiping your finger up and down on the display.

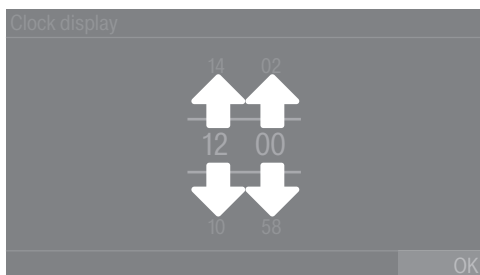

- Place your finger on the number that you want to change.
- To set the required number, swipe your finger up or down on the display.
- Confirm the set numerical value by touching the OK sensor control.

Tip: For some settings, depending on the value range and increments, the value can also be set using a numerical keypad. Briefly touching the numbers will bring up the numerical keypad. Once a valid number has been entered, the OK sensor control will be highlighted green.

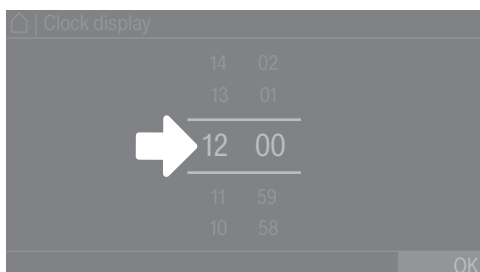

- Briefly touch a number between the two lines with your finger. The numeric block will appear.

Operating the tumble dryer

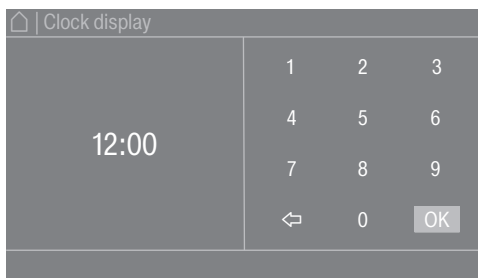

- To enter the numerical value, touch the numbers on the right-hand side and then confirm with OK.

Pull-down menu

The pull-down menu can be used to display information (e.g. about a drying programme).

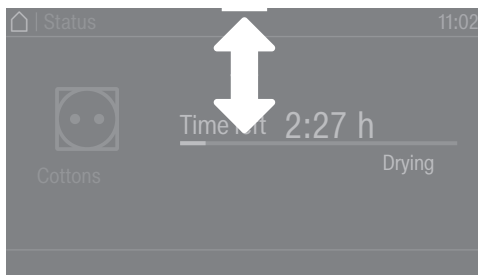

If an orange bar appears at the top of the screen in the middle of the display, you can open the pull-down menu. Touch the bar and drag it down with your finger on the display.

To close the pull-down menu again, touch the orange bar and drag it up with your finger on the display.

Exiting the menu

- Touch the ↶ sensor control to return to the previous screen.

Entries made before this which have not been confirmed with OK will not be saved.

Help display

With some menus, Help appears along the bottom line of the display.

- If you need more information about the current menu, touch the Help sensor control. The additional information is shown in the display.
- Touch the ↩ sensor control to return to the previous screen.

Initial commissioning

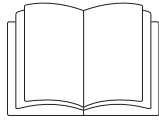

⚠ Risk of injury or damage to property due to improper installation. Incorrect installation of the tumble dryer can lead to personal injury or damage to property.
Before commissioning the tumble dryer for the first time, make sure it has been installed.
Connect the tumble dryer correctly.
Please observe the instructions in “Installation”.

Complete the initial commissioning process. During the initial commissioning process, you will need to define the settings for daily use of the tumble dryer. Some settings can only be modified during the initial commissioning process. After that, they can only be changed by the Miele Customer Service Department.

These settings are also described under “Supervisor level”.

Switching on the tumble dryer

- Press the  button.

The welcome screen will light up.

Setting the display language

You will be asked to select the display language. You can change the language at any time (see “Language” under “Supervisor level”).

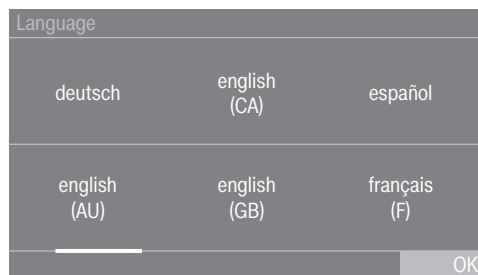

- Swipe left or right across the display with your finger until the language you want appears.
- Briefly touch the required language with your finger.

The selected language will be highlighted in orange and the display will change to the next setting.

Reference to optional external devices

If there are external devices (e.g. peak-load systems or payment devices), connect the communication box and/or slide a communication module into the slot on the back of the tumble dryer before initial commissioning. For this purpose, the tumble dryer must be disconnected from the power supply. Then start the commissioning process.

A reference to optional external hardware appears. Confirm the information with the  sensor control.

Setting the display brightness

You will be asked to select the brightness of the display.

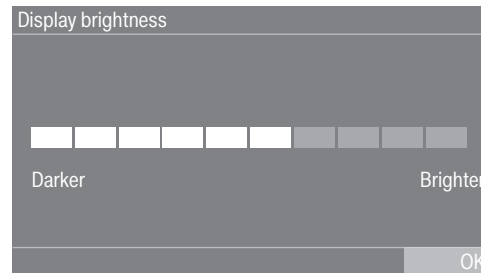

- Touch the segment bar for the required level of brightness. The selected level of brightness is represented by the length of the segment bar.
- Confirm with the OK sensor control. The display will change to the next setting.

Setting the date

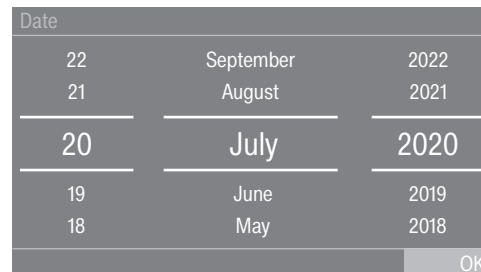

- Place your finger on the value that you want to change and move your finger upwards or downwards.
- Once all values have been selected, confirm your entry with the OK sensor control.

The display will now change to the next setting.

Confirming the time of day display query

The following question appears in the display: Should the time of day display not be shown?

- Touch the Yes or No sensor control.

If you select Yes, the system will skip the Time settings menu.

If you select No, the display will switch to the Time settings menu.

Setting the time

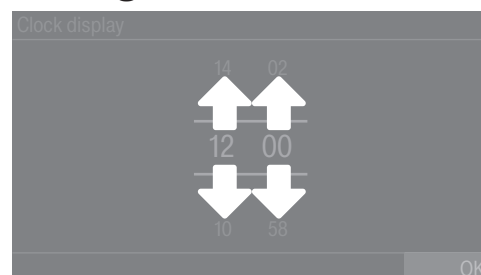

- Place your finger on the number that you want to change and move your finger upwards or downwards.

Initial commissioning

- Confirm with the OK sensor control.

The display will change to the next setting.

Selecting programme packages

You can select various programmes from the programme packages. Any programmes already active are highlighted in orange.

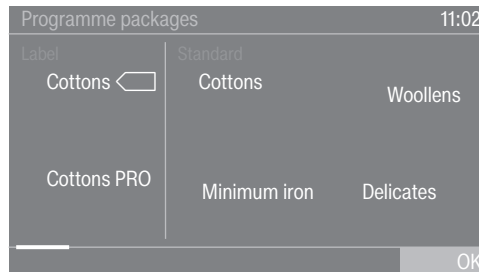

- Swipe to the left with your finger until you reach a programme that is not highlighted in orange.
- Touch the programme to be activated.

The selected programme is now active and highlighted in orange.

You can select further programmes if required.

- If you do not want to select any more programmes, confirm with OK.

The display will change to the next setting.

Tip: You can disable a selected programme by touching the programme again. Exception: The Cottons  and Cottons PRO programmes cannot be disabled.

Setting up a payment device

If you wish to set up a payment device, read the “Payment system” section of the “Supervisor level” chapter. You can only make these settings during initial commissioning. If you wish to change the settings after the commissioning process, please contact the Miele Customer Service Department.

If you do not wish to set up a payment device, you can skip this step.

Skipping payment device set-up

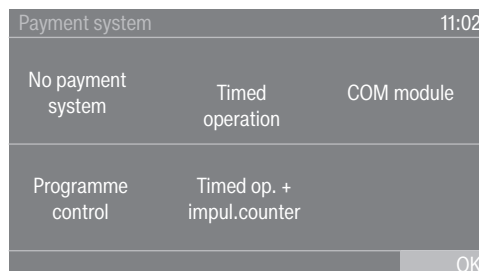

- Touch the No payment system sensor control.
- Touch OK to confirm.

The display will change to the next setting.

Completing the initial commissioning process

The commissioning process is complete when a programme lasting longer than 10 minutes has been carried out in full.

If the power is interrupted prior to the start of the first drying programme (e.g. if the machine is switched off with the  button), the initial commissioning process can be completed again. Once a drying programme has been running for over 10 minutes, the initial commissioning process cannot be performed again.

- In the main menu, touch the  Programmes sensor control.

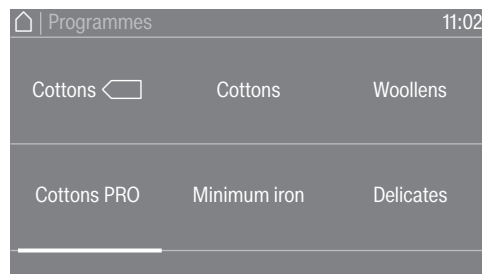

- Swipe to the left with your finger until the Timed drying cool air programme is displayed.

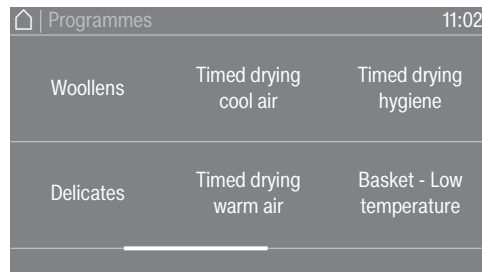

- Touch the Timed drying cool air programme.
- Touch the flashing *Start/Stop* sensor control.

After this programme has finished, the tumble dryer is ready for use.

Drying

1. Notes on correct laundry care

Washing before drying

Heavily soiled laundry must be washed particularly thoroughly. Use sufficient detergent and select a high wash temperature. If in doubt, wash the items several times.

The tumble dryer must not be used for drying items of laundry which have been cleaned using industrial chemicals.

New and coloured items must be washed thoroughly and separately. Do not dry new and coloured items with light coloured garments. There is the risk of colours running and discolouring other garments or even plastic components in the tumble dryer. Dark coloured fluff can also settle on light coloured garments and vice versa.

Removing foreign objects

Before drying, ensure that there are no foreign objects in the laundry.

 Damage due to foreign objects which were not removed from the laundry.

Foreign objects in the laundry can melt, burn or explode.

Ensure that any foreign objects (e.g. detergent dispensing aids, lighters, etc.) have been removed from the laundry.







Check seams and stitching to ensure that the items of laundry are intact. This way you will avoid the danger of fillings coming out and causing a fire. Sew in or remove underwiring from bras.

 Risk of fire due to incorrect use and operation.

The laundry can burn and destroy the tumble dryer and the surroundings.

See the section on “Warnings and safety notes” for further information.

Care symbols

Drying	
	Normal/higher temperature
	Low temperature*
* Select Low temperature.	
	Do not tumble dry
Ironing	
	Very hot
	Hot
	Warm
	Do not iron

2. Loading the tumble dryer

Loading laundry into the tumble dryer

Textiles may be damaged.
Before loading, read chapter “1. Notes on correct laundry care” first.

- Open the door.
- Load laundry into the tumble dryer.

Risk of damage with laundry getting trapped.
Laundry can be damaged by getting trapped when closing the door.
When closing the door, make sure that laundry does not get trapped in the door opening.

Do not overload the drum. Overloading can cause unnecessary wear and tear to the laundry and cause a disappointing drying result. It can also cause more creasing.

Closing the door

⚠ Damage caused by laundry getting trapped.
Laundry can be damaged by getting trapped when closing the door.
When closing the door, make sure that laundry does not get trapped in the door opening.

- Shut the door gently.

3. Selecting a programme

Switching on the tumble dryer

- Press the  button.

The welcome screen will light up.

There are different ways to select a drying programme in the main menu.

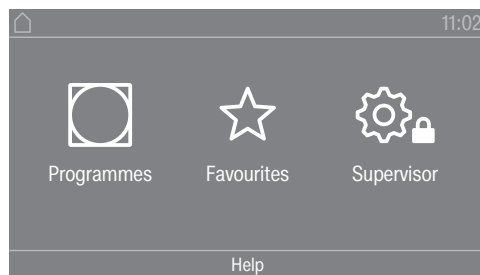

- Touch the  Programmes sensor control.

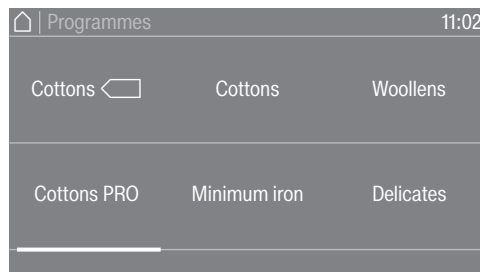

- With your finger, swipe to the left until you reach the required programme.
- Touch the sensor control for that programme.

The display will change to the standard menu for that drying programme.

Alternatively, you can select a programme from the Favourites list. The preset programmes under ☆ Favourites cannot be changed via the Supervisor level.

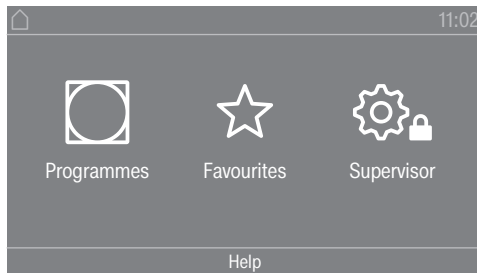

- Touch the ☆ Favourites sensor control.

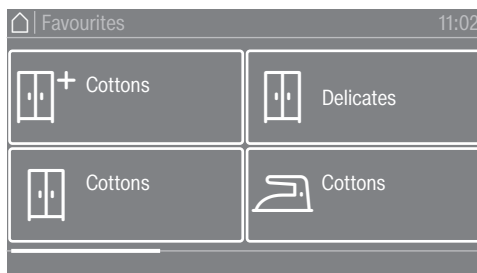

- With your finger, swipe to the left until you reach the required programme.
- Touch the required programme.

The display will change to the standard menu for that drying programme.

4. Selecting programme settings

Select the drying level

With many programmes, you can change the preset drying level. Depending on the programme, you can select different drying levels.

Selecting extra options

The drying programmes can be augmented with various Extras. Some Extras can only be selected for certain drying programmes.

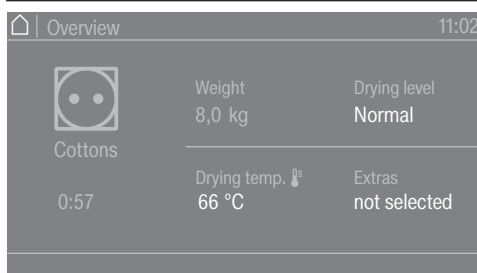

- Touch the Extras sensor control.

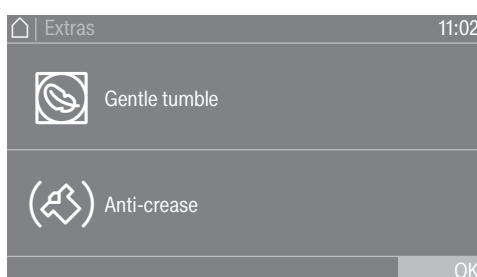

- Touch the sensor control for the extra you want.

- Only press OK when the extra appears on the display.

The relevant symbol for the required extra (☺ or ☹) lights up.

☺ Gentle tumble

Sensitive items are dried with fewer drum rotations and a lower drying temperature.

☹ Anti-crease

At the end of the programme, the drum will continue to rotate in a certain rhythm, depending on the selected programme. This helps to prevent creasing at the end of the programme.

The Anti-crease function is switched off as the factory default setting. The Anti-crease function can be switched on in the supervisor level with a variable duration of up to 12 hours. You can find this setting in the supervisor level under the Process technology/Anti-crease menu.

Drying

5. Starting a programme

Payment device (optional)

If your machine is connected to a payment device, the amount of payment required will appear in the display.

Money may be lost if the drum door is opened or the programme is cancelled.

Depending on the settings, money may be lost in the payment device if the drum door is opened or the programme is cancelled.

Do not open the door once the programme has started.

Do not cancel a drying programme while it is running.

Starting the programme

The programme can be started as soon as the *Start/Stop* sensor control is flashing on and off.

- Touch the *Start/Stop* sensor control.

If a delay start period has been selected, this will appear in the display.

The drying programme will start either straight away or once the delay start period has elapsed. The programme time left is shown in the display.

Calling up current programme parameters

During the programme running time, you can use the pull-down menu to view the parameters of the current drying programme (e.g. drying level, load size, selected extras, drying temperature).

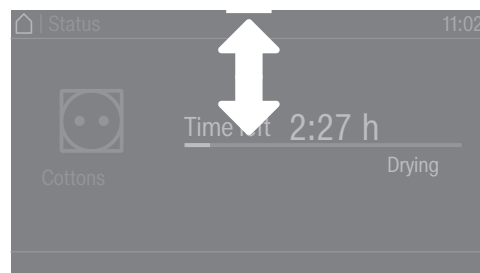

- To call up the pull-down menu, swipe your finger from top to bottom during the programme running time.



The pull-down menu displays the parameters of the drying programme.

- To close the pull-down menu again, swipe your finger from bottom to top or press the ↶ sensor control.

Programme running time/Time left estimation

The programme running time depends on the quantity of laundry, the type of fabric and the residual moisture in the laundry. The displayed programme running time for drying level programmes can therefore vary or “jump”. The tumble dryer’s electronic module adapts during the ongoing drying programme. The displayed programme running time becomes more and more accurate.

When using the programmes for the first time, the displayed time sometimes deviates significantly from the real time left. The difference between the estimated and achieved time becomes smaller if the corresponding programme is run more often. If different load sizes are dried in one programme, the time left display can only show an approximate time.

End of the programme

End of programme The laundry will be cooled down after the end of the programme. The message *Finish/Cool down* will appear on the display during the cooling phase. The laundry can now be removed.

If necessary, the control can be programmed so that a message indicating the end of the programme is only displayed once the cooling phase has ended (Supervisor level/Process technology/Cooling phase status).

After the cooling phase and the drying programme are completed, the message *Finish* is displayed.

The tumble dryer will switch off automatically after the set time after the end of the programme.

If the Anti-crease (🌀)* extra has been selected, the drum continues to rotate in intervals after the end of the programme. This reduces creasing if the laundry cannot be removed straight away.

* The Anti-crease function is switched off as the factory default setting and can be activated in the supervisor level.

Removing the laundry

- Open the door.
- Remove everything from the drum.

Items left in the tumble dryer could be damaged by overdrying when the tumble dryer is used the next time.
Always remove all items from the drum.

- Switch the tumble dryer off by pressing the ⏻ button.

Care notes

This tumble dryer requires regular maintenance, particularly if it is used on a continuous basis. Please see “Cleaning and care” for details.

Drying





Timer

Prerequisite for setting the timer The Delay start must be activated in the Supervisor level in the Controls / Display menu so that the Timer can be selected. Before the programme starts, the Timer can be used to select a programme start time or programme end time.

Setting the timer

- Touch the Timer sensor control.
- Select the Finish at, Start in or Start at option.
- Set the hours and the minutes and confirm your entry with the OK sensor control.









“Label” programme package

Programme name	Suitable fabrics	Selectable drying levels (residual moisture in %)	Selectable extras	Load size
 Cottons 	Cotton items with normal residual moisture	<ul style="list-style-type: none"> - Machine iron (40 %) - Hand iron (25 %) - Hand iron plus (15 %) - Slightly dry (2 %) - Normal (0 %) - Normal plus (-2 %) - Extra dry (-4 %) 	-  Anti-crease*	10 kg
 Cottons PRO	Cotton items with normal residual moisture	<ul style="list-style-type: none"> - Machine iron (40 %) - Hand iron (25 %) - Hand iron plus (15 %) - Slightly dry (2 %) - Normal (0 %) - Normal plus (-2 %) - Extra dry (-4 %) 	-  Anti-crease*	



















* Can only be selected if the extra is activated in the programmable function at supervisor level.

Programme overview







“Standard” programme package

Programme name	Suitable fabrics	Selectable drying levels (residual moisture in %)	Selectable extras	Load size
 Cottons	Single and multi-layer cotton/linen items	<ul style="list-style-type: none"> - Machine iron (40 %) - Hand iron (25 %) - Hand iron plus (15 %) - Slightly dry (2 %) - Normal (0 %) - Normal plus (-2 %) - Extra dry (-4 %) 	<ul style="list-style-type: none"> -  Gentle tumble -  Anti-crease* 	10 kg
 Minimum iron	Minimum iron fabrics made of synthetic, cotton or mixed fibre	<ul style="list-style-type: none"> - Hand iron (20 %) - Hand iron plus (10 %) - Normal (2 %) - Normal plus (0 %) 	<ul style="list-style-type: none"> -  Gentle tumble -  Anti-crease* 	4 kg
 Woollens	Woollen items	-	-	2 kg
 Delicates	Delicate synthetic, cotton or mixed fibre fabrics	<ul style="list-style-type: none"> - Hand iron (20 %) - Normal (2 %) - Normal plus (0 %) 	<ul style="list-style-type: none"> -  Anti-crease* 	

Programme overview





Programme name	Suitable fabrics	Selectable drying levels (residual moisture in %)	Selectable extras	Load size
 Timed drying cool air	Fabrics that need airing	-	-  Anti-crease*	
 Timed drying warm air	For drying small loads or for airing individual items	-	-  Gentle tumble -  Anti-crease*	
 Timed drying hygiene	For drying small loads or for airing individual items	-	-  Anti-crease*	
 Basket -Low temperature	Items suitable for tumble drying for which mechanical stress should be avoided.	-	-	
 Basket programme	Items suitable for tumble drying for which mechanical stress should be avoided.	-	-	
 Towelling	Particularly absorbent fabrics (e.g. hand towels, flannels or bathrobes)	- Machine iron (20 %) - Hand iron (12 %) - Hand iron plus (8 %) - Slightly dry (2 %) - Normal (0 %) - Normal plus (-2 %) - Extra dry (-4 %)	-  Anti-crease*	4 kg
 Denim	Items made from hard-wearing denim	- Machine iron (40 %) - Hand iron plus (8 %) - Normal (2 %)	-  Gentle tumble -  Anti-crease*	
 Shirts	Shirts	- Machine iron (40 %) - Hand iron (20 %) - Slightly dry (8 %) - Normal (2 %) - Normal plus (0 %)	-  Anti-crease*	1 kg
 Silks	Silk items	- Machine iron (40 %) - Hand iron (20 %) - Hand iron plus (16 %) - Slightly dry (8 %) - Normal (0 %)	-  Anti-crease*	

Programme overview

Programme name	Suitable fabrics	Selectable drying levels (residual moisture in %)	Selectable extras	Load size
 Automatic plus	Mixed loads of garments suitable for the "Cottons" and "Minimum iron" programmes	<ul style="list-style-type: none"> - Machine iron (40 %) - Hand iron (25 %) - Hand iron plus (15 %) - Slightly dry (2 %) - Normal (0 %) - Normal plus (-2 %) - Extra dry (-4 %) 	<ul style="list-style-type: none"> -  Gentle tumble -  Anti-crease* 	10 kg
 Smoothing	<ul style="list-style-type: none"> - Cotton and linen fabric - Minimum iron items made of cotton, synthetic or mixed fibre, e.g. trousers, jackets, shirts 	-	<ul style="list-style-type: none"> -  Gentle tumble -  Anti-crease* 	2 kg

* Can only be selected if the extra is activated in the programmable function at supervisor level.

















“Sport” programme package

Programme name	Suitable fabrics	Selectable drying levels (residual moisture in %)	Selectable extras	Load size
 Sportswear	Polyester or polyamide with and without spandex	<ul style="list-style-type: none"> - Machine iron (40 %) - Hand iron (20 %) - Hand iron plus (8 %) - Slightly dry (2 %) - Normal (0 %) - Normal plus (-2 %) - Extra dry (-4 %) 	- (☞) Anti-crease*	4 kg
 Outerwear	Polyamide and membrane items Outdoor clothing which is suitable for tumble drying	<ul style="list-style-type: none"> - Machine iron (40 %) - Hand iron (20 %) - Slightly dry (8 %) - Normal (2 %) - Normal plus (0 %) 	- (☞) Anti-crease*	
 Proofing	<p>Fabrics suitable for tumble drying, e.g. microfibre fabrics, skiwear, outdoor clothing, fine, close-weave cotton garments (poplin), tablecloths.</p> <p>Caution: fire hazard! Fabrics proofed with paraffinic agents must not be tumble dried.</p> <p>This programme includes an additional proofing fixing phase. Only use proofing agents that are stated by the manufacturer as being “suitable for use on membrane fabrics”.</p>	<ul style="list-style-type: none"> - Machine iron (40 %) - Hand iron (20 %) - Slightly dry (8 %) - Normal (0 %) 	- (☞) Anti-crease*	
 Reactivation	<p>Polyamide and membrane items</p> <p>The drying process revitalises the fibres, which improves the water-repelling effect.</p>	<ul style="list-style-type: none"> - Machine iron (40 %) - Hand iron (20 %) - Slightly dry (8 %) - Normal (0 %) 	- (☞) Anti-crease*	

* Can only be selected if the extra is activated in the programmable function at supervisor level.









Programme overview

“Flatwork” programme package

Programme name	Suitable fabrics	Selectable drying levels (residual moisture in %)	Selectable extras	Load size
 Cottons, dry plus	Single and multi-layer cotton/linen items	- Extra dry (-4 %)	-  Anti-crease*	10 kg
 Cottons, dry	Single and multi-layer cotton/linen items	- Normal (0 %)	-  Anti-crease*	
 Cottons 20% res. moisture	Single and multi-layer cotton/linen items	- Hand iron plus (20 %)	-  Anti-crease*	
 Cottons 25% res. moisture	Single and multi-layer cotton/linen items	- Hand iron (25 %)	-  Anti-crease*	
 Cottons 40% res. moisture	Single and multi-layer cotton/linen items	- Machine iron (40 %)	-  Anti-crease*	
 Minimum iron, dry	Minimum iron fabrics made of synthetic, cotton or mixed fibre	- Normal plus (0 %)	-  Anti-crease*	4 kg
 Min. iron 10% res. moisture	Minimum iron fabrics made of synthetic, cotton or mixed fibre	- Hand iron plus (10 %)	-  Anti-crease*	
 Min. iron 20% res. moisture	Minimum iron fabrics made of synthetic, cotton or mixed fibre	- Hand iron (20 %)	-  Anti-crease*	

* Can only be selected if the extra is activated in the programmable function at supervisor level.







“Bedding” programme package

Programme name	Suitable fabrics	Selectable drying levels (residual moisture in %)	Selectable extras	Load size
 Down bedding	Down duvets and pillows	- Normal (0 %)	-  Anti-crease*	8 kg
 Synthetic bedding	Synthetic duvets and pillows	- Normal (0 %)	-  Anti-crease*	
 Natural hair bedding	Natural fibre duvets and blankets Natural fibre duvets must not be fully dried in the tumble dryer, as otherwise there is a risk of the fibres becoming matted. We recommend only partial drying.	-	-  Anti-crease*	
 Pillows	Pillows	- Normal (0 %)	-  Anti-crease*	

* Can only be selected if the extra is activated in the programmable function at supervisor level.

Programme overview

“Buildings maintenance” programme package

Programme name	Suitable fabrics	Selectable drying levels (residual moisture in %)	Selectable extras	Load size
 Mops	Cotton mops	<ul style="list-style-type: none"> - Machine iron (20 %) - Hand iron (15 %) - Hand iron plus (10 %) - Slightly dry (2 %) - Normal (0 %) - Normal plus (-2 %) - Extra dry (-4 %) 	-  Anti-crease*	8 kg
 Microfibre mops	Microfibre mops	<ul style="list-style-type: none"> - Machine iron (40 %) - Hand iron (20 %) - Normal (2 %) - Normal plus (0 %) 	-  Anti-crease*	
 Cloths	Microfibre cloths, dusters	<ul style="list-style-type: none"> - Machine iron (40 %) - Hand iron (20 %) - Normal (2 %) - Normal plus (0 %) - Extra dry (-2 %) 	-  Anti-crease*	4 kg

* Can only be selected if the extra is activated in the programmable function at supervisor level.

“Fire brigade” programme package

Programme name	Suitable fabrics	Selectable drying levels (residual moisture in %)	Selectable extras	Load size
☎ Masks	Breathing masks with head straps Breathing masks may only be tumble dried if they are held in place in the drum by special holders (optional accessories).	-	-	2 pieces
👤 Protective clothing	Protective suits (e.g. Nomex® fire-fighting apparel), overalls, jackets, trousers For an optimised drying result, turn the fabrics inside out.	- Normal (2 %)	- (☑) Anti-crease*	4.5 kg
👤 Proof protect. clothing	Fabrics treated with a proofing agent. Proofed fabrics may only be used with proofing agents that are suitable for membrane fabrics and are based on fluorochemical compounds. Close velcro fasteners or cover with Floorband. Caution: fire hazard! Fabrics proofed with paraffinic agents must not be tumble dried.	- Normal (2 %)	- (☑) Anti-crease*	
👤 Rescue clothing	Synthetic fibres and cottons Close velcro fasteners or cover with Floorband. For an optimised drying result, turn the fabrics inside out.	- Normal (2 %)	- (☑) Anti-crease*	

* Can only be selected if the extra is activated in the programmable function at supervisor level.

Programme overview





“WetCare” programme package

Programme name	Suitable fabrics	Selectable drying levels (residual moisture in %)	Selectable extras	Load size
Ⓜ WetCare sensitive	Non-washable outerwear	-	- (☞) Anti-crease*	4 kg
Ⓜ WetCare silks	Non-washable outerwear which creases easily	- Machine iron (40 %) - Hand iron (20 %) - Hand iron plus (16 %) - Slightly dry (8 %) - Normal (0 %)	- (☞) Anti-crease*	
Ⓜ WetCare intensive	Washable outerwear	- Machine iron (40 %) - Hand iron (25 %) - Hand iron plus (15 %) - Slightly dry (2 %) - Normal (0 %) - Normal plus (-2 %) - Extra dry (-4 %)	- (☞) Anti-crease*	

* Can only be selected if the extra is activated in the programmable function at supervisor level.

“Equestrian” programme package

 Risk of damage due to metal buckles, hooks and eye fasteners.
 Metal buckles, hooks and eye fasteners may damage fabrics and the dryer drum.
 Remove all metal buckles, hooks and eye fasteners before tumble drying.
 If the metal buckles, hooks and eye fasteners cannot be removed, they must be covered with suitable protective bags (optional Miele accessories).

Programme name	Suitable fabrics	Selectable drying levels (residual moisture in %)	Selectable extras	Load size
 Horse blankets	Horse blankets, saddle-cloths, gaiters, hoof boots, bandages, textile halters	<ul style="list-style-type: none"> - Machine iron (40 %) - Normal (2 %) - Normal plus (0 %) 	-  Anti-crease*	8 kg (approx. 5 saddle-cloths or 1 summer blanket)
 Woollen horse blankets	Horse blankets containing a high proportion of wool	-	-  Anti-crease*	

* Can only be selected if the extra is activated in the programmable function at supervisor level.

Programme overview

“Special programmes” programme package

You can put together 5 special programmes on the appliance and assign your own programme names. Enter the programme names in the table.

Programme name	Suitable fabrics	Selectable drying levels (residual moisture in %)	Selectable extras	Load size
☆ Special programme 1				≤ 10 kg
☆ Special programme 2				
☆ Special programme 3				
☆ Special programme 4				
☆ Special programme 5				

“Individual programmes” programme package

You can put together 20 individual programmes in the Miele Benchmark Programming Tool (see “Miele Benchmark Programming Tool Manual”) and assign your own programme names. Enter the programme names in the table.

Programme name	Suitable fabrics	Selectable drying levels (residual moisture in %)	Selectable extras	Load size
☺ 1 Individual programme 1				≤ 10 kg
☺ 2 Individual programme 2				
☺ 3 Individual programme 3				
☺ 4 Individual programme 4				
☺ 5 Individual programme 5				
☺ 6 Individual programme 6				
☺ 7 Individual programme 7				
☺ 8 Individual programme 8				
☺ 9 Individual programme 9				
☺ 10 Individual programme 10				
☺ 11 Individual programme 11				
☺ 12 Individual programme 12				
☺ 13 Individual programme 13				
☺ 14 Individual programme 14				
☺ 15 Individual programme 15				
☺ 16 Individual programme 16				
☺ 17 Individual programme 17				
☺ 18 Individual programme 18				
☺ 19 Individual programme 19				
☺ 20 Individual prog. 20				

Changing the programme sequence

Changing a programme once it has started

You cannot change to another programme once a programme has started (this prevents unintentional alterations). You will need to cancel the current programme before you can select a new one.

 Risk of fire due to incorrect use and operation.
The laundry can burn and destroy the tumble dryer and the surroundings.
See the section on “Warning and safety” for further information.

Cancelling the current programme

- Touch the *Start/Stop* sensor control.

The following message appears in the display: Cancel programme?

- Touch the *Yes* sensor control to cancel the current programme.

 Risk of burns by touching hot laundry or the tumble dryer drum.
Touching the hot laundry or the tumble dryer drum may cause burns.
Let the laundry cool down and remove it carefully.

Opening the door of the tumble dryer during the programme sequence will cancel the current programme.

If the Door opening status/Interrupt programme function is selected in the supervisor level, the current programme will be interrupted when the door is opened. In the case of an interruption, the tumble dryer will remain in the current programme.

The interrupted programme will be continued when the door is closed and the *Start/Stop* sensor control is pressed.

Reselecting a cancelled programme

- Open and close the door.
- Select and start a new programme.

Adding laundry during ongoing Delay start period

You can open the door to add or remove laundry.

- All programme settings will be saved.
- You can change the drying level, if required.
- Open the door.
- Add or remove laundry.
- Close the door.
- Touch the *Start/Stop* sensor control so that the Delay start period continues.

Time left

Altering the programme sequence can cause the programme duration shown in the display to be adjusted.

Supervisor level

Opening the Supervisor level

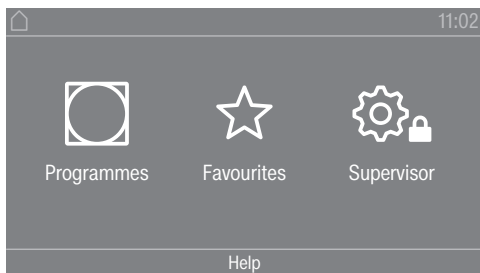

Touching the  sensor control takes you to the Supervisor level.

Access via code

Supervisor level is accessed using a code.

Factory default: The code is **000**.

Change code

You can alter the Supervisor level access code to protect the dryer from unauthorised access.

Be careful when entering a new code.

You will need to inform Miele Service if you forget your new code. Miele Service will have to reset the code.

Make a note of your new code and store it in a safe place.

Closing the settings menu

- Touch the  sensor.

The display will then go back to the previous menu level.

- Touch the  sensor.

The display will change to the main menu.

Controls / Display

Language

The display can be set to appear in one of several different languages. To select the language you want, go to the *Languages* sub-menu.

You can change the language as follows:

- Permanently using the supervisor level (= “Supervisor language”).
- For the duration of the current programme only using the  sensor control. The supervisor language is displayed again at the end of the programme.

Language entry

The display can be set to one of several different user languages. This setting allows you to determine how languages can be selected.

You can change the language as follows:

International

6 languages are available. The  sensor control is not active. Note the setting Set languages.

Language setting

The  sensor control can be used to select a language. All languages are available (factory default).

You can change the order of the first 4 languages. These slots are allocated to the most commonly used languages.

Standard language

The user language cannot be changed. The user language is the same as the supervisor language. The  sensor control is not active.

Set languages

The languages for the International lang. entry setting can be changed.

Six languages can be selected. All languages are available.

If you wish to add a new language to the language menu:

Six languages can be selected. All languages are available.

If you wish to add a new language to the language menu:

- First select the language you want to replace.

All available languages are displayed.

- Select and confirm the language to replace the previous language.

The new language appears instead of the old one.

Display brightness

The brightness of the display can be altered. The setting depends on the various lighting conditions in the place of installation.

- It can be set to one of 10 different levels.

Clock display

After selecting the clock format, you can set the time of day.

Clock format

- Factory default: 24-hour display

- 12-hour display

- No clock

Set

- The time can be set.

Date

The date can be set after selecting the date format.

- Date format

The date can be shown starting with the day, month or year.

- Date

The date is set.

Volume

The volume for various sounds can be changed.

The volume can be changed for the following tones:

Supervisor level

- Finish tone
The finish tone signals the end of the drying programme.
- Keypad tone
- Welcome tone
- Fault alarm
The fault tone signals a fault and can be switched off. The volume of the fault tone cannot be adjusted.

Res. moisture display

In addition to displaying the drying level, the residual moisture can also be indicated as a percentage.

- Factory default: Without % value
- With % value

Visibility parameters

Various parameters are offered/displayed when a programme is selected. You can decide which parameters should not be displayed. These parameters can then not be edited during programme selection.

- Residual moisture
- Duration
- Low temperature
- Anti-crease
- Load size
- Drying temperature

Display off status

The display switches off to save energy; only the *Start/Stop* sensor flashes slowly. You can change this setting.

Changing this setting leads to increased energy consumption.

- Off
No switching off
- On (10 min.) Not curr.prog.
The display will remain on during the programme sequence but will go out 10 minutes after the end of the programme.
- Logo (10 min.) Not curr.prog.
The display will remain on during the programme sequence but the logo will light up 10 minutes after the end of the programme.
- Factory default: On after 10 min.
The display is switched off after 10 minutes.
- On (30 min.) Not curr.prog.
The display will remain on during the programme sequence but will go out 30 minutes after the end of the programme.
- Logo (30 min.) Not curr.prog.
The display will remain on during the programme sequence but the logo will light up 30 minutes after the end of the programme.
- On after 30 min.
The display will go out after 30 minutes.

Machine off status

In order to save energy, the tumble dryer will switch off automatically after the end of the programme or if no further selection is made. You can change this setting.

Changing this setting leads to increased energy consumption.

- No switch off
- Factory default: Switch off after 15 minutes
- Switch off after 20 minutes
- Switch off after 30 minutes

Delay start

The delay start (timer) can be activated or deactivated.

- Factory default: Off
- On

Memory

The tumble dryer saves the settings that were last selected for a drying programme (drying stage and/or extra option, or the duration for some programmes).

- Factory default: Off
- On

Temperature unit

You can select the unit for the temperature display.

- Factory default: °C
- °F

Weight unit

You can decide whether load quantities are displayed in “kg” or “lbs”.

- Factory default: kg
- lb

Change code

You can alter the access code to the Supervisor level.

- Enter the current code.
- Enter a new code.

Programme selection

Controls

You can select whether the tumble dryer is operated as a “laundrette” machine. Short-cuts are the easiest way to operate the machine. Operating staff are unable to change pre-set programmes.

Tip: Start by configuring all necessary settings and changes to the tumble dryer before adjusting any of the options below.

Supervisor level

Caution: When activating any of these options, the Supervisor level will no longer be available.

You will no longer be able to access the Supervisor level via the display. Please follow the instructions below if you wish to change any other settings.

Opening the Supervisor level (laundrette version)

■ Switch the tumble dryer on and open the dryer door.

① Touch the *Start/Stop* sensor and hold it down whilst carrying out steps ②-③.

② Close the dryer door.

③ Wait until the *Start/Stop* sensor, which will now be flashing quickly, lights up constantly ...

④ ... and then release the *Start/Stop* sensor.

- Standard

Factory default: all (selected) programmes are available.

- Laundrette, basic

12 programmes are available.

Under Favourite programmes, you can set which of the 12 programmes to select or modify.

- Laundrette Logo

12 programmes are available.

Under Favourite programmes, you can set which 12 programmes to select/modify.

- Laundrette Logo ext. time

4 timed drying programmes* with different temperature levels are time-controlled via an external payment system.

The set value indicates the programme running time and cannot be modified by the user.

* The maximum programme running time is specified during initial commissioning.

- Laundrette Logo int. time

4 timed drying programmes* with different temperature levels are time-controlled via the tumble dryer electronic module.

The set value indicates the maximum programme running time and can be modified by the user.

* The maximum programme running time is specified during initial commissioning.

- External prog. selection

A communication module can be used to select the programme from an external terminal.

Programme packages

This allows you to specify the scope of the tumble dryer programme. You can select all of the programmes or individual programmes from the relevant programme packages.

The tumble dryer's additional scope of programmes can be configured. The programmes are listed under "Programme chart".

Favourite programmes

After switching on, you can also select a programme via: ☆ Favourites.
12 programmes can be stored as favourites based on your own priorities and requirements.

These favourites will also be made available in the control options

- *Launderette ext. (12 prog)*
- *Launderette, basic (4 prog)* (the first 4 of the 12 favourites).

You can specify the control option under Controls.

Tip: You can assign a different colour to each programme. In this case, the Prog. colour allocation setting must be set to *On*.

Changing Favourite programmes

- Select the programme you wish to change or replace.
- Confirm the programme or the setting to be changed.

Another menu opens, enabling you to select a new programme or change the parameters.

- Confirm with the *Save sensor control*.

Your selection is now active.

Special programmes

You can put together 5 special residual moisture or time-controlled programmes and assign your own programme names.

First, enter the programme name.

- Select the special programme you want to change.

The *Save as* menu opens.

- Use the letters and symbols below the line to enter the name.
- Touch the *Save sensor control*.

You can now enter the parameters for a Res. moisture programme or Timed drying.

The 5 special programmes are pre-programmed at the factory. You can change these special programmes.

The special programmes are added to the programme packages. Enter the name and settings of your special programme into the “Special programmes” table in the “Programme overview” chapter.

Res. moisture programme:

- Final residual moisture:
-6 % (dry) – 40 % (damp)
- Extra drying time:
0–60 minutes
- Temperature (Process air):
cold – 65 °C
- Cooling down temperature (Process air):
40–55 °C
 - Drum rotation, main direction:
45–300 seconds

Supervisor level

- Pause:
2–5 seconds
- Drum reversal:
15–120 seconds
- Anti-crease
 - Drum rotation, main direction:
0–500 seconds
 - Pause:
100–3000 seconds
 - Drum reversal:
0–500 seconds

Timed drying:

- Running time:
5–180 minutes
- Temperature (Process air):
cold – 65 °C
- Cooling down temperature (Process air):
40–55 °C
 - Drum rotation, main direction:
45–300 seconds
 - Pause:
2–5 seconds
 - Drum reversal:
15–120 seconds
- Anti-crease
 - Drum rotation, main direction:
0–500 seconds
 - Drum reversal:
0–500 seconds
 - Pause:
100–300 seconds

Sort programmes

Programmes can be moved within the programme list and in the Favourites list.

- Factory default: Off
- On

Moving programmes/favourites

You can move/change the order of the programmes (programme menu – single option list). You can also move and change the order of the favourites that you edit in the *Supervisor level* under *Favourite programmes*.

- Touch the programme that you wish to move.
- Press and hold the sensor until the frame changes.
- Drag the programme to the required place.

Prog. colour allocation

You can assign a specific colour to a favourite programme. In the list of favourites, each favourite programme is given a coloured frame, which can be adjusted.

- Factory default: Off
- On

Process technology

Anti-crease

At the end of the programme, the drum will continue to rotate at intervals if the laundry is not removed immediately.

Changing this setting leads to increased energy consumption.

The setting for Anti-crease (🌀) can either be switched off or a time between 1 and 12 hours can be selected.

Factory default: 2 hours

Drying levels

Changing this setting leads to increased energy consumption.

You can alter the drying levels for the Cottons, Minimum iron and Automatic plus programmes.

Drying levels Cottons, Minimum iron and Automatic plus can be set to one of 7 different levels.

Factory default: normal

Further cooling

If extended cooling is activated, the drum temperature is checked approx. 1 minute before the machine goes into standby mode at the end of the programme. If the temperature is above 55 °C, the dryer will carry out cooling until it is below 55 °C.

Changing this setting leads to increased energy consumption.

- Factory default: off
- On

Cooling down temperature

The laundry will be cooled down automatically after the end of the programme. The automatic cooling phase can be set at a cooler level for all programmes. This means that the cooling phase is extended.

Changing this setting leads to increased energy consumption.

The setting can be changed from 40 °C–55 °C.

Factory default: 55 °C

Door opening status

If programme interruption in the event of door opening is activated, the tumble dryer remains in the current programme when the door is opened and the programme continues once the door has been closed and the Start/Stop button has been pressed.

- Factory default: Cancel programme
- Interrupt programme

Supervisor level

Service

Clean out the airways

The tumble dryer's electronic module calculates the degree to which fluff or detergent residues in the fluff filters and vent ducting are impairing performance. A message to check the contamination appears. You can decide at what level of fluff this reminder should be emitted.

If the message appears on the display even though the fluff filter is clean, the vent ducting is regarded as borderline. Miele recommends improving the vent ducting. Poor vent ducting will result in longer programme running times and greater energy consumption.

This reminder, which you can configure, is displayed: Clean out the airways

- Off
The reminder does not appear. However, if there is a very severe blockage in the ducting, the programme will be cancelled regardless of this option.
- Heavy
The reminder only appears when there is a heavy build-up of fluff.
- Factory default: normal
- Light
The reminder appears when there is only a small build-up of fluff.

Clean the filters

The fluff filter in the air duct area must be cleaned on a regular basis. You can set an hourly interval for the reminder.

The selected hourly interval depends on how much fluff tends to build up and how often you wish to clean the filter, e.g. for hygiene purposes.

You can adjust this reminder: Clean the filters

- Time interval of 5–55 hours
- Factory default: after 55 hours
- Off

Service interval

The tumble dryer shows a custom message at a selected interval to prompt you to undertake specific maintenance tasks.

Three different messages can be created: 1/2/3. Each message is created in the language and alphabet of the current supervisor language.

Your message is displayed at the end of the programme and can be acknowledged with OK. The same message appears at the end of the next programme.

Settings

This setting allows you to determine the interval (by hours or date) at which the message appears.

- Factory default: Off
- By time
You can then select a time interval from 1–9999 hours.
- By date
You can enter a date.

Message text

Enter your message for your planned maintenance work. You can edit one, two or all three of the 1/2/3 messages.

Reset display

The message appears until the display is permanently reset. The message then appears again once the next interval is reached.

External applications

External exhaust flap

External hardware is connected via the Miele Connector Box.

The time delay between the external exhaust air flap's activation point and the switch-on time for the drum/fan motor is regulated.

A message appears in the display while the exhaust air flap is open.

- Factory default: off

This option must always be selected if there is no exhaust air flap to activate. This prevents the programme from being cancelled.

- On (1 second to 5 minutes)

Additional fan

External hardware is connected via the Miele Connector Box.

The additional fan is switched on by the dryer (via Connector Box) in parallel with the internal fan.

- Off

- On

Pressure sensor

External hardware is connected via the Miele Connector Box.

When using a shared exhaust air duct, one tumble dryer may have to be switched off or suppressed from the outset if certain pressure levels have built up in the ducting. The external pressure sensor is only checked if the external exhaust air flap and/or the external additional fan is set to "on".

A message appears in the display while the exhaust air flap is open.

- Off = Not active

- NO contact = Active

Responds to **high potential**

- NC contact = Active

Responds to **low potential**

Peak load signal

External hardware is connected via the Miele Connector Box.

The peak-load negotiation function enables the tumble dryer to be connected to an energy management system. When a signal is registered, the tumble dryer's heater is switched off for a short period or the machine is prevented from being switched on.

A peak-load signal can be issued via the Connector Box or via the COM module.

- Factory default: No function

Supervisor level

- Peak load with 230 V
- Peak load with 0 V
- COM module

Peak load prevention

- Factory default: Off
- On

COM module selection

This tumble dryer is equipped with an integrated WiFi module. However, the dryer can also be equipped with an external module.

- Factory default:
 - Off
- Internal mod. Domestic
 - The internal WiFi module is used.
- External mod. Professional
 - An XKM module is inserted into the module slot.

Availability of Miele digital products

The ability of Miele digital products depends on the availability of the services in your country.

The different services are not available in all countries.

For information about availability, please visit www.miele.com.

WiFi / LAN

Control the networking of your tumble dryer.

Networking of the tumble dryer for use with the digital Professional tools is only possible with the external module. The internal module can only be used by the Miele Customer Service Department.

- Deactivate (visible when the network is activated)
 - The network remains set up; the WiFi function is switched off.
- Activate (visible when the network is deactivated)
 - The WiFi function is reactivated.
- Connection status (visible when the network is activated)
 - The following values are displayed:
 - the quality of WiFi reception
 - the network name
 - the IP address
- Set up again (visible when set up)
 - Resets the WiFi login (network) to immediately re-establish a new connection.
- Reset (visible when set up)
 - The network is no longer set up. A new connection has to be established in order to use the network again.
 - The WiFi is switched off.
 - The WiFi connection will be reset to the factory default setting.

Remote

External programme selection is possible via an external terminal (programme may only be started on the machine). However, programmes may also be selected and started on the machine.

Factory default: on

Remote update

The RemoteUpdate function is used for updating the software in your tumble dryer.

RemoteUpdate is activated by default.

If you do not install a RemoteUpdate, you can continue to use your tumble dryer in the usual way. However, Miele recommends installing RemoteUpdates.

Miele's RemoteUpdate function can only be used if the tumble dryer is connected to a WiFi/LAN network and you have an account in the Miele Professional app. The tumble dryer must be registered in the app.

See the Miele Professional app for terms of use.

If a RemoteUpdate is available for your washing machine, it will be displayed automatically when the Operator level is open.

You can choose to start the RemoteUpdate immediately or wait until later. If you select "Start later", the prompt to run the RemoteUpdate will be displayed again the next time you switch on your washing machine.

The RemoteUpdate can take a few minutes.

Please note the following information about the RemoteUpdate function:

- You will only receive a message when a RemoteUpdate is available.
- Once a RemoteUpdate has been installed, it cannot be undone.
- Do not switch off the tumble dryer during a RemoteUpdate. Otherwise, the RemoteUpdate will be aborted and will not be installed.

Machine parameters

Legal information

Open source licences

You can view information here.

Copyright and licences

For the purpose of operating and controlling the machine, Miele uses proprietary or third-party software that is not covered by open source licensing conditions. This software/these software components are protected by copyright. The copyrights held by Miele and third parties must be respected.

Furthermore, this machine contains software components which are distributed under open source licensing conditions. You can access these open source components along with the corresponding copyright notices, copies of the licensing conditions valid at the time and any further information. This information can be found under the menu option Settings/ Machine parameters/Legal information/Open source licences. The liability and warranty arrangements for the open source licences displayed in this location only apply in relation to the respective rights holders.

Supervisor level

Payment system

The Miele Connector Box accessory unit or the COM module is required to connect a payment device.

Setting for payment systems

If you wish to change the settings after the commissioning process, please contact Miele Service.

- No payment system

The next settings are skipped.

- Programme control

The machine is operated using a coin box. The user purchases a programme.

- Timed operation

The tumble dryer is coin-operated using a time meter. The user purchases a time-controlled programme.

- Timed op. + impul.counter

For payment devices where the usage time is increased each time a coin is inserted.

- COM module

Operation is IP-based.

Pairing instructions

Follow the steps below to connect the tumble dryer to your network.

Opening the supervisor level

- Select the Supervisor menu option in the appliance display.
- Select the Access via code menu option.
- Enter the 3-digit supervisor code.

Establishing the network connection via WPS

- Select the Supervisor level menu option from the External applications menu.
- Then select the COM module selection menu option.
- If you are using an external communication module, select the External mod. Professional menu option.
Otherwise, select the Internal mod. Domestic menu option.
- Select WiFi.
- Select Set up.
- Select the connection method Via WPS.
- Now press the WPS button on your router and confirm with OK in the appliance display. A timer starts. The network connection via WPS is being established. The appliance is now successfully connected.
- Touch OK to confirm.

Establishing the network connection via soft AP

- Select the External applications menu option from the Supervisor level menu.
- Then select the COM module selection menu option.
- If you are using an external communication module, select the External mod. Professional menu option.
Otherwise, select the Internal mod. Domestic menu option.
- Select WiFi.
- Select Set up.
- Select the connection method Via Soft AP.
- Confirm pressing OK and follow the instructions in the external application.

Establishing the network connection using a LAN cable

- Select the External applications menu option from the Supervisor level menu.
- Then select the COM module selection menu option.
- If you are using an external communication module, select the External mod. Professional menu option.
Otherwise, select the Internal mod. Domestic menu option.
- Connect the appliance to your router/switch using the network cable. The router/switch must be connected to the Internet.

The appliance is now successfully connected.

Connectivity

Technical data

System requirements for WiFi

- WiFi 802.11b/g/n
- 2.4 GHz band
- WPA/WPA2 encryption
- DHCP activated
- Multicast DNS / Bonjour / IGMP snooping activated
- Ports 443, 80, 53 and 5353 open
- IP DNS server = IP standard gateway/router
- Mesh/repeater use: same SSID and password as standard gateway/router
- SSID must be permanently visible



System requirements for LAN

- DHCP activated
- Multicast DNS / Bonjour / IGMP snooping activated
- Ports 443, 80, 53 and 5353 open
- IP DNS server = IP standard gateway/router

WiFi signal strength – Guide values

The WiFi signal strength is only a rough guide. These details do not provide absolute certainty.

The WiFi signal strength can be read via the MDU or directly on the appliance.

WiFi signal strength		Meaning
MDU	 *	
76–100 %	3/3**	Generally, reliable operation possible
51–75 %	2/3	
26–50 %	1/3	Generally, operation possible
1–25 %	0/3	Generally, reliable operation not possible
0 %		Operation not possible

* Displayed on the appliance

** Number of bars  3/3–0/3

The signal strength can be adversely affected by many factors:

- People in the room
- Open or closed doors
- Moved objects
- Varying radio signal sources or interference
- Other appliances with Bluetooth or WiFi wireless technology

Cleaning the fluff filter

A two-part fluff filter in the air supply area collects fluff released by textiles. Remove and dismantle the fluff filter for cleaning.

Check and clean the fluff filter at the latest when the *Clean out airways* message appears.

Tip: You can also use a vacuum cleaner so that you can remove the fluff without touching it.

Removing the fluff filter

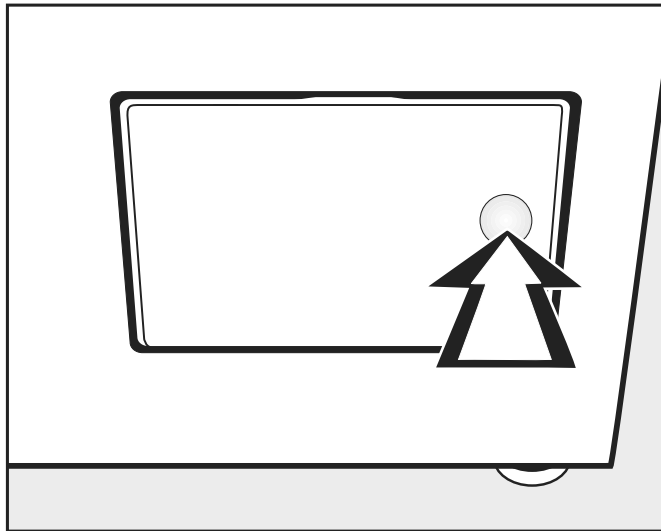

- To open, press against the right side of the fluff filter flap.

When pulling out the fluff filter, do not rotate the handle (see below) as this will dismantle the filter.

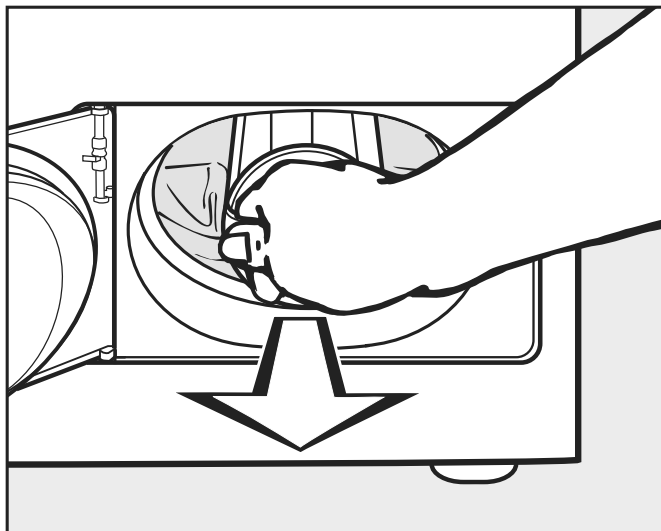

- Use the handle to pull out the fluff filter.

Cleaning and care

Dismantling the fluff filter

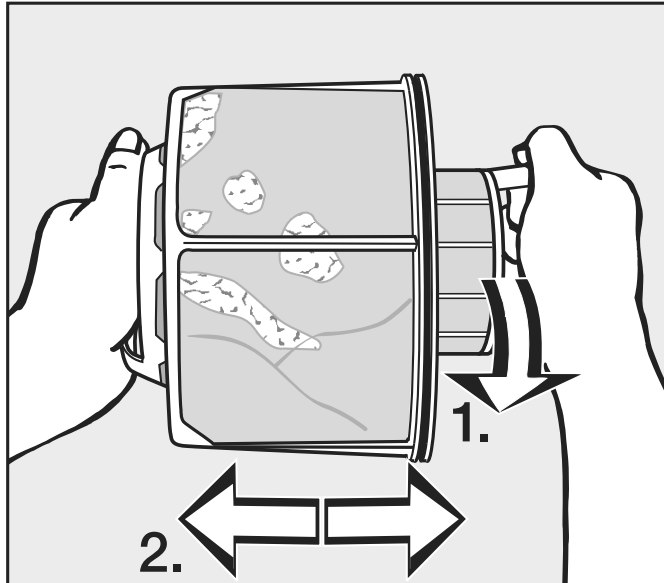

- Hold the fluff filter by the handles.
- 1. Rotate the inner part of the fluff filter (1).
- 2. Pull the two parts of the fluff filter apart (2).

Cleaning the fluff filter parts (dry)

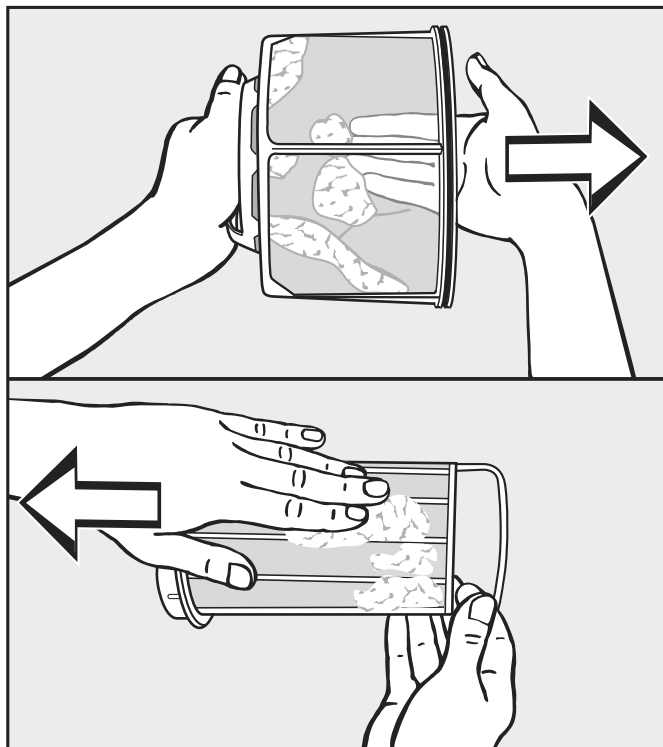

- Shake out the fluff and/or pick it off with your fingers.

Cleaning the fluff filter parts (wet)

- Only clean the fluff filter parts under warm running water if there is a lot of compacted fluff on them.

Dry the fluff filter parts before reassembling them. A wet fluff filter could cause operational faults while drying.

Inserting the fluff filter

If there is a lot of visible fluff, clean the air supply area before reinserting the cleaned fluff filter. See next page.

- Insert the inner fluff filter part into the outer part.
- Turn the inner part of the fluff filter clockwise slightly until you feel it engage.
- Hold the fluff filter by its handle and push it as far as it will go into the lower air supply area.

Do not rotate the handle as this will dismantle the filter.

- Close the fluff filter flap.

Cleaning the air supply area

Check the air supply area from time to time and clean it if there is a lot of fluff present.

Rapid cleaning

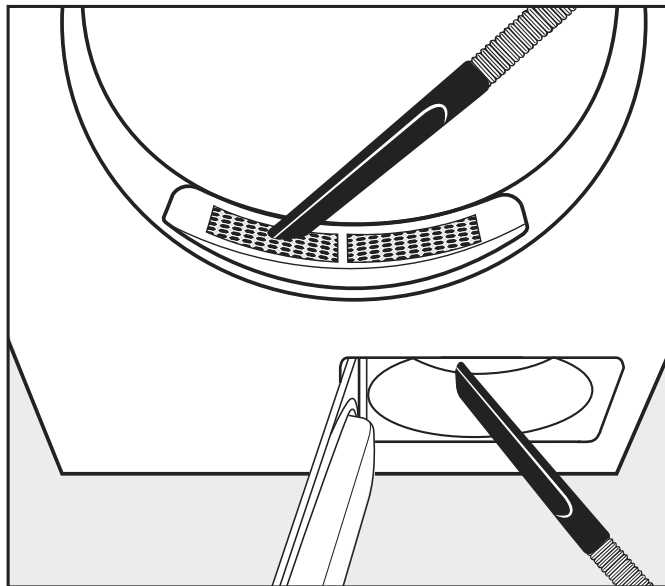

- Use a vacuum cleaner to remove fluff.
 - From cover in door area (top).
 - From air supply area in front of the fan impeller (bottom) after first removing and cleaning the fluff filter.

Additional cleaning

Cleaning the drum and the outside of the casing

⚠ Risk of death due to electric shock.
The tumble dryer must be completely disconnected from the power supply before performing cleaning or maintenance work.
Before starting cleaning or maintenance work, always switch off the tumble dryer at the main switch (on site).
Do not use a pressure washer or water jet to clean the tumble dryer.

Cleaning and care

⚠ Risk of damage due to solvent-based cleaning agents and abrasive cleaners.

Solvent based cleaning agents, abrasive cleaners, glass cleaners or all-purpose cleaners can cause damage to plastic surfaces and other parts.

Clean the tumble dryer with a slightly damp cloth and a mild non-abrasive cleaning agent or soapy water.

- Clean the seal around the inside of the door with a damp cloth.
- The tumble dryer drum must be wiped clean with a soft, damp cloth after drying items that have been starched.
- Dry all parts with a soft cloth.
- The drum and other stainless steel parts can be cleaned with a suitable stainless steel cleaner if you wish.

The air intake vent is located on the rear of the tumble dryer.

This vent must never be covered or blocked with objects.

Keep the area around the tumble dryer – in particular the air intake – clear of fluff.

- Fan impeller

The fan impeller behind the fluff filter flap may be clogged with detergent residues and fluff.

Check the fan impeller from time to time and clean it if it is heavily soiled.

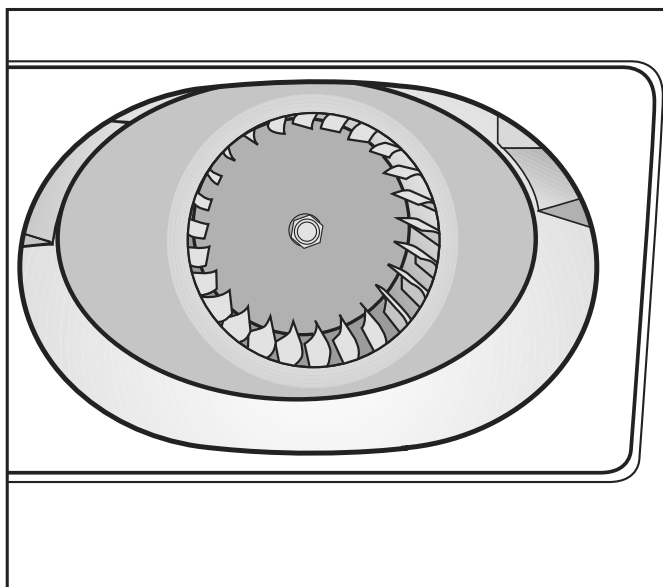

- Using a damp cleaning cloth, carefully remove the coating on the fan impeller.
- Also clean the area in front of the fan impeller.
- Use a vacuum cleaner to remove fluff.
- Remove any fluff from the inside of the open fluff filter flap and the rubber seal. Make sure that you do not damage the rubber seal when doing this.

- Cover in door area

Only remove the cover in the door area in the event of a major blockage.

Removing the cover

- Look in the drum.

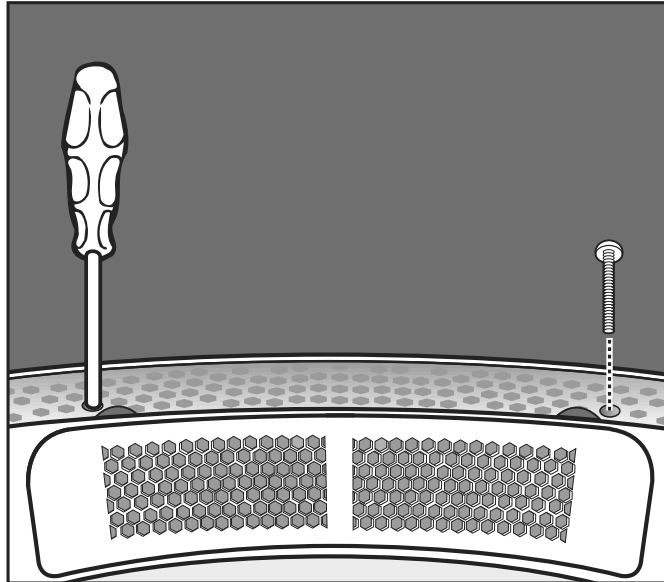

- Underneath the cover on the left and right, unscrew the Torx screws through the round holes.

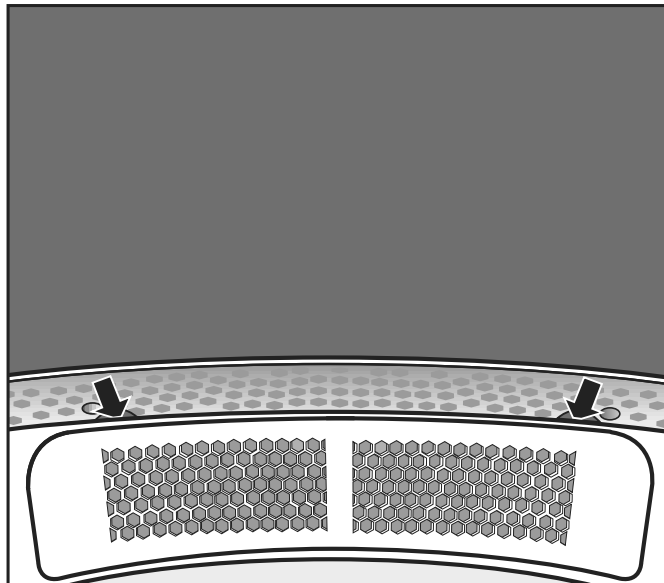

- Reach under the edge of the cover (see arrows) and lift off the cover.
- Clean the air supply area underneath the cover with a vacuum cleaner.
- Clean the cover.
- Clean the air supply area in front of the fan impeller (open the fluff filter flap).

Refitting

- Carefully position the cover on the left or right side of the opening.
- Press down the cover until it engages on the opposite side.

Securing the cover

- Look in the drum.

Cleaning and care

- Underneath the cover on the left and right, screw in the Torx screws through the round holes.

Fault diagnosis

Message	Cause and remedy
The display remains dark.	<p>There is no power to the tumble dryer.</p> <ul style="list-style-type: none"> ■ Check the mains plug, main switch and fuses (on site).
Problem	Cause and remedy
The efficiency of the tumble dryer decreases.	<p>The fluff filter in the tumble dryer is dirty.</p> <ul style="list-style-type: none"> ■ Check the fluff filter in the tumble dryer for contamination and clean it if necessary.
	<p>Insufficient ventilation</p> <ul style="list-style-type: none"> ■ Make sure that the air intake vent and the tumble dryer ducting are not covered or blocked by objects.
	<p>Room temperature too high (>45 °C)</p> <ul style="list-style-type: none"> ■ Ensure adequate ventilation of the installation site. ■ If necessary, connect the tumble dryer to external fresh air and exhaust air ducting.
Feather-filled pillows smell after drying.	<p>Feathers tend to develop a build-up of their own smell or smells from other sources when they are heated.</p> <ul style="list-style-type: none"> ■ Smells can be reduced through natural ventilation after drying.
Items made of synthetic fibres are charged with static electricity after drying.	<p>Synthetic fibres tend to attract static charge.</p> <ul style="list-style-type: none"> ■ Static charge can be reduced by adding a fabric softener to the final rinse in the washing programme.
There is a build-up of fluff.	<p>Fluff is principally the result of friction when garments are being worn and to some extent when they are being washed. Machine drying hardly causes any fluff to form and has no appreciable effect on the lifetime of the fabric.</p> <p>Fluff is collected by the fluff filters and fine filter and can be easily removed</p> <ul style="list-style-type: none"> ■ (see “Cleaning and care”).
The drying process goes on too long or even switches off.	<p>In some circumstances, you may be asked to clean the air channels/air guide.</p> <ul style="list-style-type: none"> ■ Please check all the possible causes described below.
	<p>The fluff filter is clogged with fluff.</p> <ul style="list-style-type: none"> ■ Remove the fluff.
	<p>The air guide area is clogged with hair and fluff, for example.</p> <ul style="list-style-type: none"> ■ Clean the air guide area. ■ You can remove the cover in the loading area to clean the air guide area underneath.
	<p>The vent ducting or its openings are clogged with hair and fluff, for example.</p>

Problem solving guide

Problem	Cause and remedy
	<ul style="list-style-type: none"> ■ Check and clean all components in the vent ducting (e.g. wall pipe, external grille, bends, elbows, etc.). <p>The flow of air is insufficient (e.g. because it is installed in a small room).</p> <ul style="list-style-type: none"> ■ When drying, open a door or window to ensure sufficient ventilation. <p>The laundry has not been spun sufficiently.</p> <ul style="list-style-type: none"> ■ Make sure that your laundry is thoroughly spun at the appropriate spin speed in the washing machine. <p>The tumble dryer has been overloaded.</p> <ul style="list-style-type: none"> ■ Do not exceed the maximum load size for the drying programme selected. <p>Metallic components, e.g. zips, have prevented the tumble dryer from registering the correct laundry moisture level.</p> <ul style="list-style-type: none"> ■ Open any zips next time. ■ If the problem occurs again, dry garments with long zips using the hot air drying programme.
<p>Condensation is forming in the drum.</p>	<p>The tumble dryer is installed on a shared exhaust air duct.</p> <ul style="list-style-type: none"> ■ The tumble dryer must always be installed with a non-return flap when using a combined line. ■ Check the non-return flap for possible defects on a regular basis and replace the flap if necessary.

Contact in case of malfunction

In the event of any faults which you cannot remedy yourself, please contact your Miele Dealer or Miele Service.

Contact information for Miele Service can be found at the end of this document.

Please note that telephone calls may be monitored and recorded for training purposes and that a call-out charge will be applied to service visits where the problem could have been resolved as described in this booklet.

Please quote the model and serial number of your appliance when contacting Miele. This information can be found on the data plate.

Optional accessories

Optional accessories for this tumble dryer are available from your Miele dealer or from the Miele Customer Service Department.

Installation locations

Front view

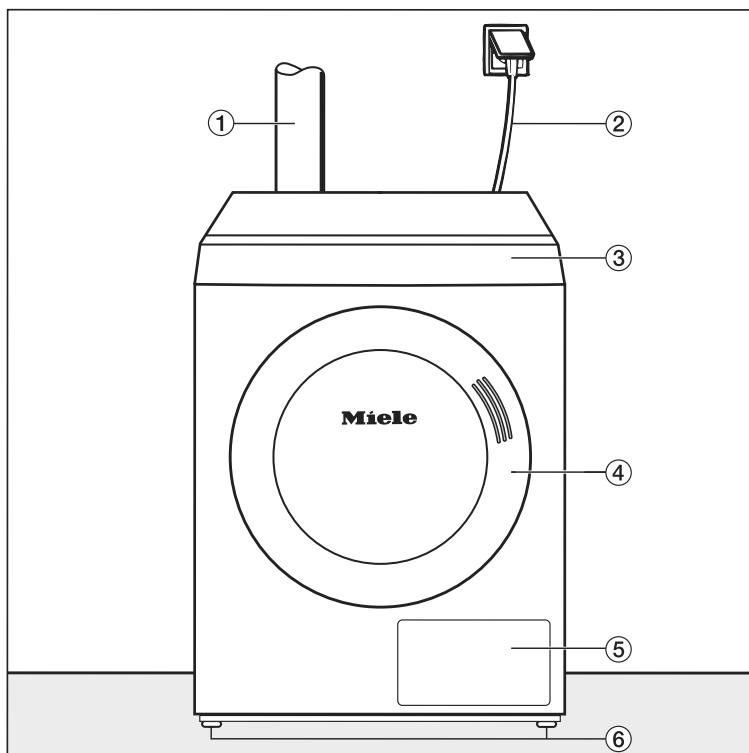

- | | |
|------------------------------------|-------------------------------------|
| ① Vent ducting | ④ Door |
| ② Electrical connection cable | ⑤ Fluff filter flap |
| ③ Control panel with touch display | ⑥ Four height-adjustable screw feet |

Side view

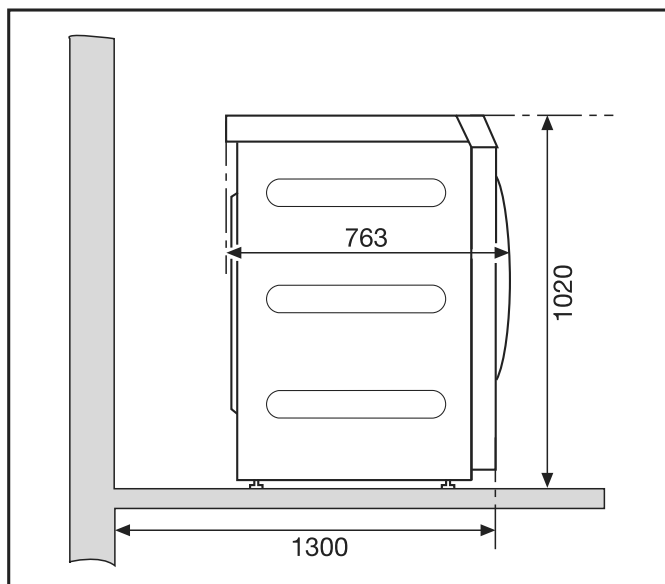

Rear view

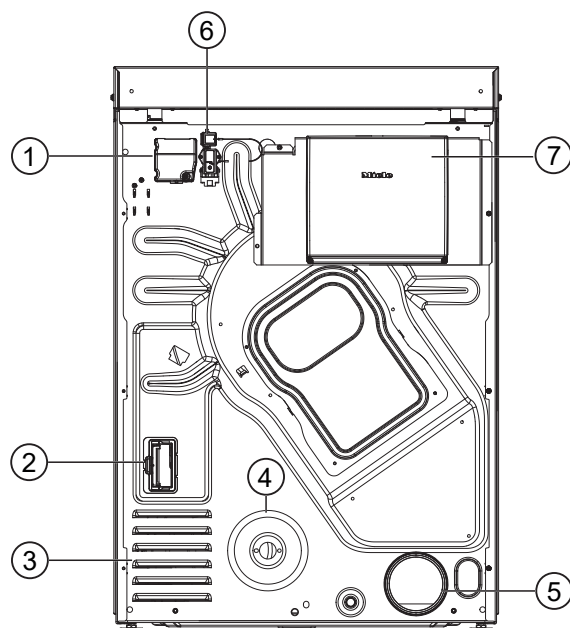

- ① Electrical connection
- ② Communication module slot
- ③ Intake vents for drying air
- ④ Gas connection 1/2" acc. to ISO 7-1
- ⑤ Exhaust duct Ø 100 mm
- ⑥ Connection for communication box
- ⑦ Communication box (optional)
For setting up a connection with external systems

View from above

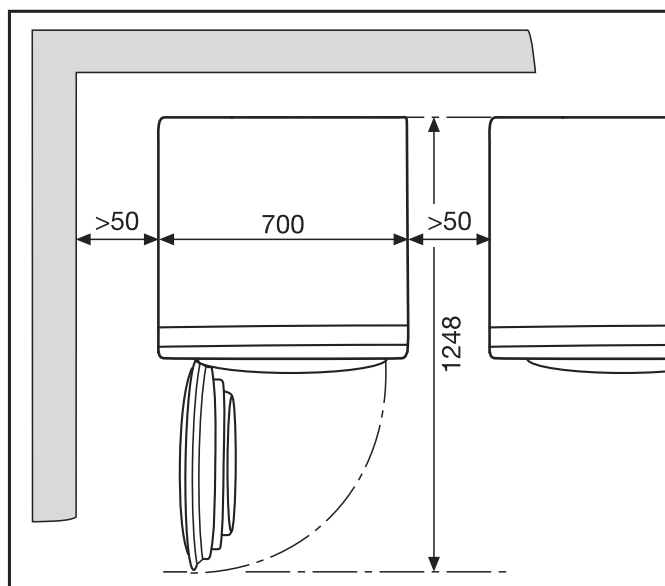

Installation on a plinth

Various Miele plinths are available as optional accessories.

Installation

⚠ Risk of injury and damage due to missing tumble dryer fastenings.
When installing on a plinth, an unsecured tumble dryer can slip and fall off the plinth.
If the tumble dryer is installed on a plinth, it must be secured.
The plinth must be secured to the floor.

Installation

Transporting the tumble dryer

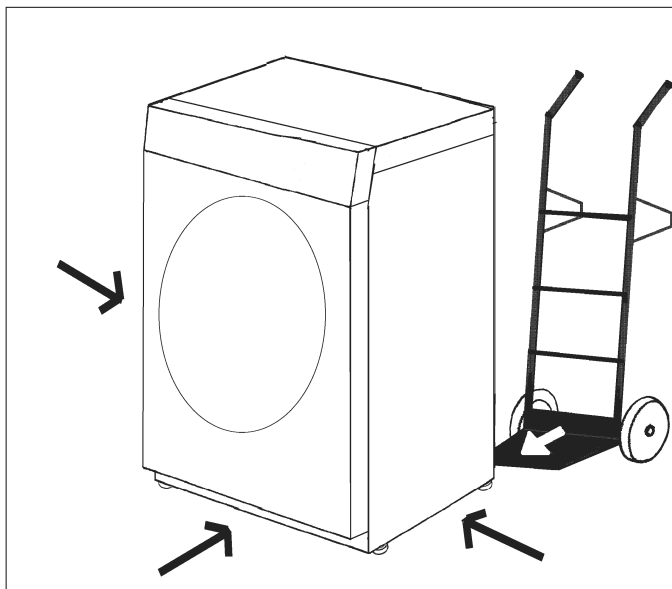

Transport the tumble dryer to its installation site using a suitable transport base (e.g. sack truck).

⚠ Risk of injury caused by the tumble dryer tipping over.
When transporting the tumble dryer, there is the risk of the tumble dryer tipping over.
Ensure that the tumble dryer is stable during transportation.

Levelling



Ensure that no closeable door, sliding door or oppositely hinged door is installed that could hinder opening of the tumble dryer door in any way.

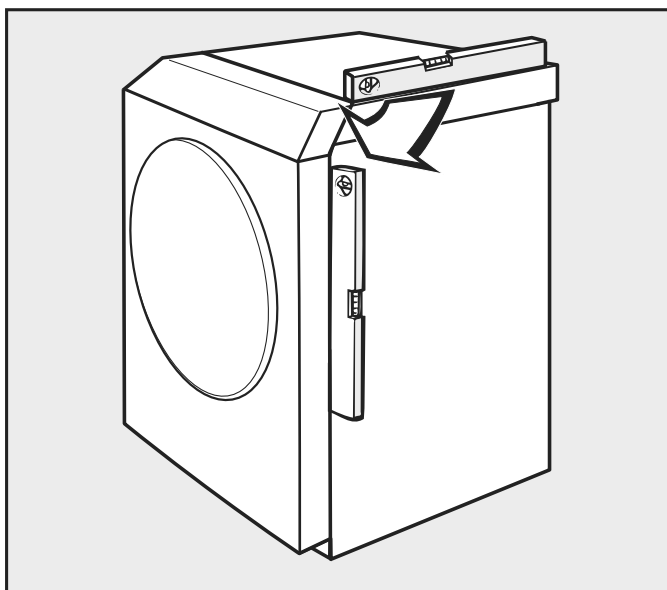

The tumble dryer must stand perfectly level on all four feet to ensure safe and proper operation.

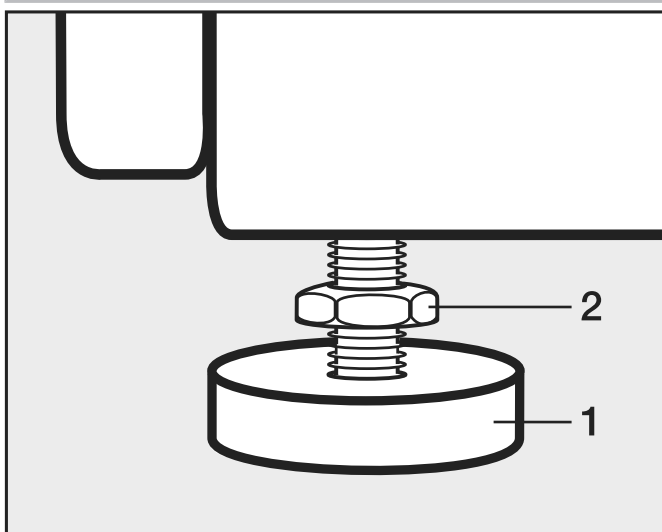

- Undo the screws (2).
- The screw feet (1) can be adjusted to compensate for any unevenness in the floor.
- Tighten the screws (2) against the housing.

Installation

Securing the tumble dryer against slipping

⚠ Danger of gas leakage from gas-heated tumble dryers due to lack of floor fastening.
Accidental displacement of a gas-heated tumble dryer can damage the gas line and cause gas to leak.
After installation, always secure gas-heated tumble dryers to the floor using suitable fastening material.

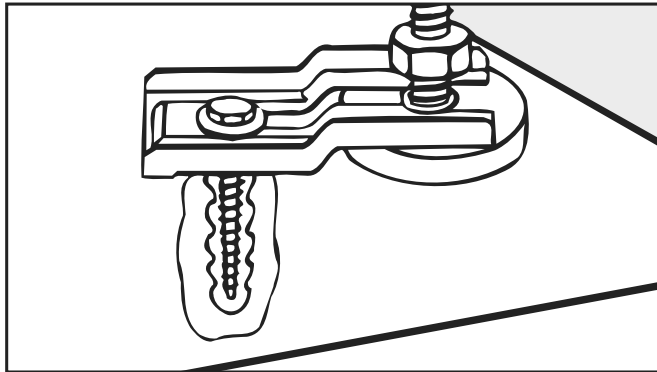

The screw feet of the tumble dryer must be secured with tensioning strips (accessories).

Electrical connection

The tumble dryer has a mains cable without a plug.

⚠ The data plate indicates the nominal power consumption and the appropriate fuse rating. Compare the specifications on the data plate with those of the electricity supply and make sure that they match.

The appliance may only be connected to an electrical system designed in accordance with VDE 0100 and that conforms to the national and local codes and regulations.

This connection process must be performed by a qualified electrician.

Tip: We recommend connecting the tumble dryer to the power supply via a plug and socket so that it is easier to conduct electrical safety checks (e.g. during maintenance or repair work).

It is advisable to connect the product via a suitably rated plug and socket in accordance with IEC-60309, otherwise for a hardwired connection an all pole means of isolation must be installed at the site.

If the appliance is hard-wired, a dual circuit breaker must be provided on site. When switched off there must be an all-pole contact gap of at least 3 mm in the isolator switch (e.g. circuit breakers, fuses and relays according to IEC/EN 60947).

When connecting to the mains electricity supply, phase L of the tumble dryer must be connected to phase L of the mains. The neutral conductor N of the tumble dryer must be connected to the neutral conductor N of the mains.

If the connections are mixed up, the flame detection function will not work. When heating, the tumble dryer issues fault message *F98*.

The plug connector or isolator switch should be easily accessible at all times.

⚠ If the tumble dryer is disconnected from the electricity supply, the isolator must be lockable or the point of disconnection must be monitored at all times.

New connections, modifications to the system or servicing of the earthing conductor, (including determining the correct fuse rating), must only be carried out by a qualified electrician.

If more than one voltage is specified on the data plate, the tumble dryer can be converted for connection to the relevant input voltage. This conversion must be performed by the Miele Customer Service Department or by an authorised dealer. During the conversion, the wiring instructions given on the wiring diagram must be followed.

► If it is necessary to install a residual current device (RCD) in accordance with local regulations, a residual current device type B (sensitive to universal current) must be used.

Supply air and exhaust air management

Ventilation

The air required for drying is taken from the room where the tumble dryer is installed.

Ensure sufficient room ventilation, e.g. by means of ventilation openings that cannot be closed in the exterior wall.

- It must not be possible to seal off ventilation openings.
- The room ventilation is only working properly if no low pressure occurs. Avoid low pressure, e.g. by means of ventilation openings in the exterior wall. This will ensure that:
 - The exhaust air is fully discharged from this tumble dryer.
 - The gas demonstrates the required combustibility.
- For each tumble dryer, there must be a minimum cross section of 237 cm^2 per ventilation opening.

The tumble dryer draws in air at the back. Therefore, there must be a sufficiently large gap between the back of the machine and the wall.

This would otherwise hinder a sufficient flow of air as well as the operational performance of the tumble dryer.

Observe the necessary spacing between the machine and the wall.

Do not reduce the gap between the bottom of the tumble dryer and the floor (e.g. plinth facings, deep pile carpet).

This tumble dryer is classified as a type B22 gas fuel-burning installation without flow safeguarding equipment, and with a fan behind the heater.

Installation

Design of the exhaust air management system

The mixtures of exhaust gas and air that are emitted by gas-heated tumble dryers must be discharged into the atmosphere individually via the roof.

In the case of combined lines, each gas-heated dryer must have a non-return flap.

Exceptions regarding the design of the exhaust air management system must be designed in accordance with the applicable local building regulations. Seek approval from the relevant building inspector.

- The connections between exhaust air ducts and the exhaust gas system must be kept as short as possible.
- When connecting the vent ducting to the exhaust duct on a machine, particular care must be taken to make sure the connection is secure and air-tight.
- Only use heat-resistant materials with a temperature resistance of at least 80 °C.
- Condensation will form in the exhaust air management system. A condensate drain must therefore be placed at the lowest point in the system.

Calculating the total ducting length

The friction of the vent ducting with its bends and various components provides resistance to the flow of air. This friction resistance is expressed as a relative pipe length. The **relative pipe length** indicates how much greater the resistance of a bend is, for example, when compared to 1 metre of a straight plastic waste water pipe (table I).

Adding together the relative pipe lengths for all of the components gives the **total ducting length**. The total ducting length expresses the resistance of the entire exhaust air system.

As a larger **duct diameter** has a lower flow resistance, a longer duct requires a greater duct diameter (table II).

Procedure

1. Measure the length needed for the straight sections of ducting. Multiply this value by the corresponding relative pipe length from **table I**.
2. Calculate the number of bends and components needed. Use **Table I** to help you add together their relative pipe lengths.
3. Add together all of the relative pipe lengths calculated above in order to calculate the total ducting length.
4. Refer to **Table II** for the pipe diameter needed for the total ducting length.

Table I	
Components	Relative pipe length
Exhaust air hose (flexible aluminium)* / pipe (temperature resistance min. 80 °C)	
– 1 m laid straight or 1 m straight pipe	1.0 m
– 45° bend (radius of bend = 0.25 m)	0.6 m
– 90° bend (radius of bend = 0.25 m)	0.8 m
Non-return flap*	14.3 m
* optional accessories	

Table II	
Maximum permissible total ducting length	Required diameter
20 m	100 mm
40 m	125 mm
80 m	150 mm

Sample calculation

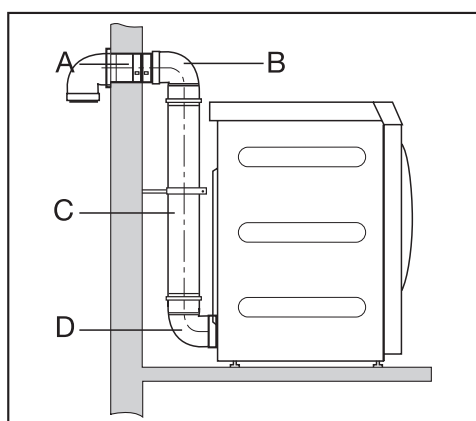

A	1 bend, 90° = 1 x 0.8 m relative pipe length	= 0.8 m
B/D	2 bends, 90° = 2 x 0.8 m relative pipe length	= 1.6 m
C	0.5 m pipe = 0.5 x 1 m relative pipe length	= 0.5 m
Total ducting length		= 2.9 m

Result: the total ducting length is less than 20 m (as per Table II). A pipe diameter of 100 mm will therefore suffice.

Exhaust duct dimensions

View from above

Installation

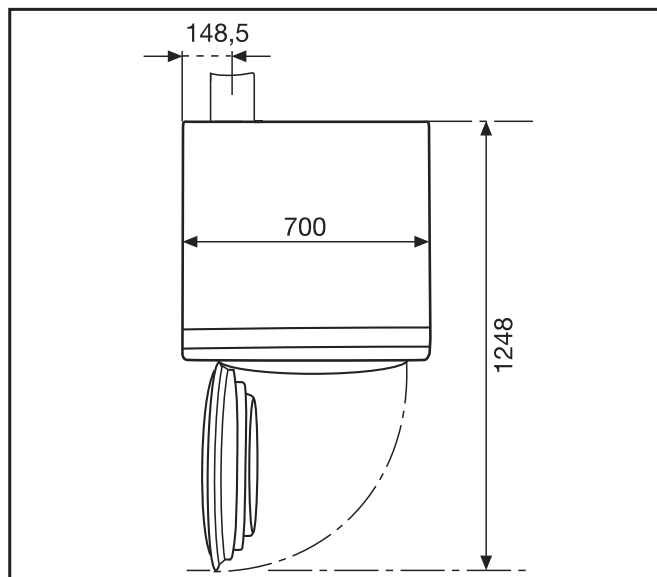

Rear view

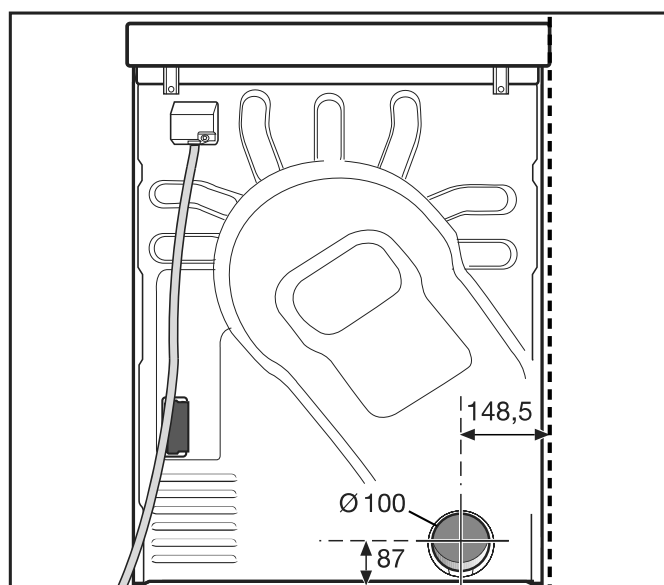

Exhaust air management with plug-in pipes

You will need

- the connector (supplied).
- pipes and connecting pieces from a suitable retailer.

Only use heat-resistant materials with a temperature resistance of at least 80 °C.

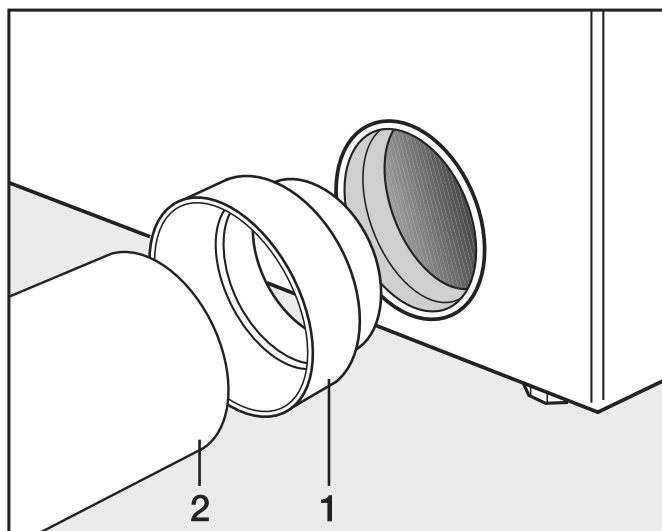

- Install the connector (1) and the pipe (2).

⚠ Wrap heat-resistant metallic tape around plug connections.

Exhaust air management with flexible aluminium hose

You will need

- the adapter (supplied).
- Flexible aluminium exhaust air hose (optional accessory).

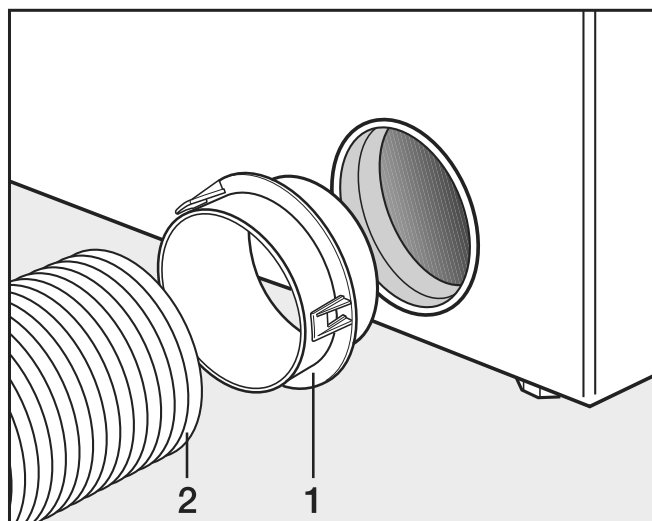

- Install the adapter (1) and the flexible aluminium exhaust air hose (2).

⚠ Wrap heat-resistant metallic tape around plug connections.

Shared exhaust air ducts

A shared exhaust air duct is only permitted in exceptional cases. The shared exhaust air duct must be approved by the relevant building inspector.

⚠ A non-return flap must be installed for each tumble dryer. Otherwise, the tumble dryers may be damaged by a backflow of condensation and their electrical safety could be affected.

Installation

If 3–5 tumble dryers are installed on one shared exhaust air duct, the pipe diameter **D** must be increased.

Number of tumble dryers	Factor for increasing the pipe diameters from Table II
3	1.25
4–5	1.5

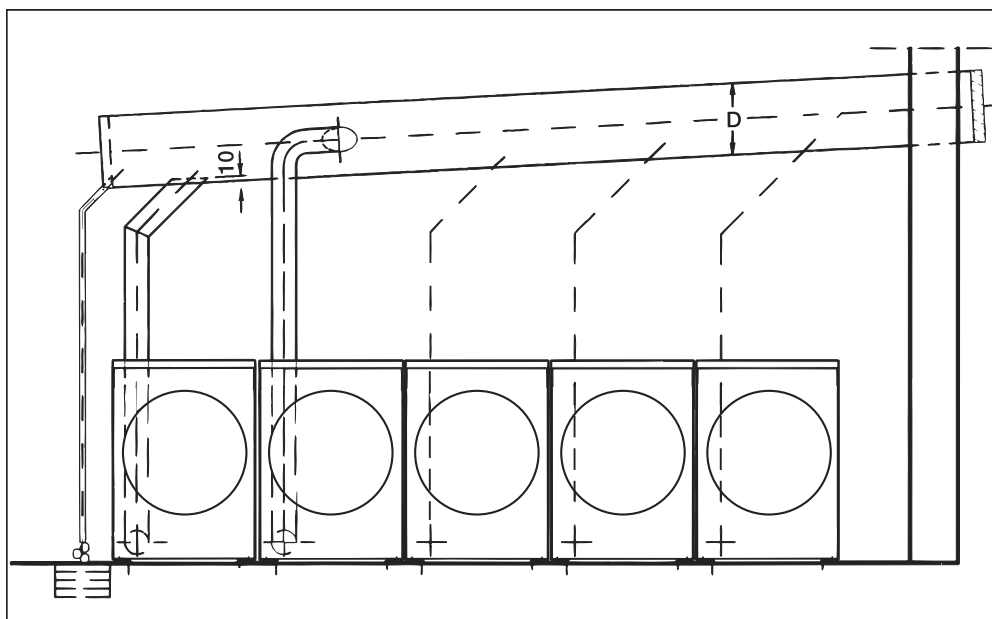

Gas

Connection and conversion instructions

Shut-off equipment and connection hose for the gas connection must be fitted by the customer on site.
A suitable connection hose can be purchased from Miele as an optional accessory.

Initial connection

The initial connection must be carried out by a licensed specialist company according to specific national regulations.

 The configuration ex works must allow the tumble dryer to be operated with the relevant gas family, gas group and connection pressure.

This tumble dryer is configured ex works for operation with **natural gas E (H), G 20**.

The data plate provides information about the gas inlet pressure and the corresponding jet pressure. Compare the specifications on the data plate with those of the gas network operator.

The required gas valve settings are described in the accompanying setting and conversion instructions.

Converting to another gas type

 Danger if conversion work is not performed correctly.
Conversion work must be performed by authorised specialists only.

If the dryer is to be converted to a gas type other than the one specified on the data plate, refer to the accompanying setting and conversion instructions.

 Risk of explosion if gas-heated tumble dryers have leaks.
Once the work has been completed, there is a risk that the gas-heated tumble dryer may have a leak and gas may escape.
After completing any commissioning, maintenance, conversion or repair work, check the tumble dryer for leaks. Particular attention must be paid to the measurement connections on the gas valve. Checks must be performed when the burner is both switched on and switched off.

Order of steps for commissioning or conversion work

 Check that the points listed in “Supply air and exhaust air management” have been taken into consideration.

The steps below should be followed in the given order when commissioning or converting the machine.

1. Ask the gas supply company what the gas family, gas group and connection pressure are. Compare this information with the values specified on the machine (see data plate).
2. Check and correct the factory-set jet pressure based on the tables “Settings with natural gas” and “Settings with liquid gas”.

Installation

3. If the gas family, gas group or connection pressure is different, it must be converted as instructed in the connection and conversion instructions (“Setting and conversion instructions for gas”). You must then change the data plate.
Follow the accompanying setting and conversion instructions when changing the gas family. If there is no setting and conversion kit available, you can request one from the Miele Customer Service Department. Please quote the following:
 - the model
 - the number of the tumble dryer
 - the gas family
 - the gas group
 - the gas connection pressure
 - the country where the machine has been installed

Set the jet pressure at the machine’s gas regulating valve (see “Settings with natural gas/liquid gas” section and the accompanying setting and conversion instructions).
4. Switch on all gas consumers that are present, including the installed tumble dryer.
5. Measure the connection pressure. **The connection pressure must correspond to the data plate information and the accompanying setting and conversion instructions.**

Tables

Required flow rate

	Rated heat load Hi	Flow rate
Natural gas E	8 kW	0.847 m ³ /h
Natural gas LL	8 kW	0.985 m ³ /h
Liquid gas	7.5 kW	0.571 kg/h

Consumption calorific values

The rated load is based on the following calorific values (gas reference values: temperature 15 °C; absolute pressure: 1013 mbar):

Natural gas E (G 20)	34.02 MJ/m ³ (Hi)
Natural gas LL (G 25)	29.25 MJ/m ³ (Hi)
Liquid gas (G 31)	46.3 MJ/kg (Hi) Density ratio: 1.55 Air density: 1.2 kg/m ³

Settings with natural gas / liquid gas

In the case of natural gas G25, up to 3 mbar of pressure loss may occur when checking the inlet pressure.

⚠ Danger! The jet pressure is checked/adjusted while the gas-heated tumble dryer is operating. Caution: mains voltage!

Servicing, modification, testing and maintenance of electrical appliances must be carried out in accordance with all appropriate legal requirements, accident prevention regulations and valid standards.

The jet pressure is checked/adjusted with the side panel removed.

- Fit the front panel and the control panel.
- Connect the gas-heated tumble dryer to the gas and electricity supplies for testing.

Installation

Gas type		Nom- inal heater rating	Re- stricted heater rating	Jet dia- meter	Jet pres- sure ± 0.2 m bar	Jet pres- sure ± 0.2 m bar	Gas inlet pressure (mains pressure)			
							Nom- inal heater rating HI	Re- stricted heater rating LO	P _{min}	P _n
Designation		Test gas	kW	kW	mm	mbar	mbar	mbar	mbar	mbar
Natural gas	Natural gas H (E)	G20	8.0	6.6	2.6	8.3	4.9	17	20	25
	Natural gas L (LL)	G25	8.0	6.6	2.6	12.0	7.1	20	25	30
Liquid gas	3B/P	G30	7.5	6.0	1.8	9.0	6.0	25 42.5	29 50	35 57.5
	3P	G31	7.5	6.0	1.8	12.0	8.0	25 42.5	29 50	35 57.5

Gas setting values

 Risk of electric shock and injury due to using the tumble dryer without the complete casing.
If the casing is dismantled, it is possible to come into contact with live or rotating machine parts.
Once the tumble dryer has been installed, replace all the casing parts that were removed.

Optional accessories

► Accessory parts may only be fitted when expressly approved by Miele. If other parts are used, warranty, performance and product liability claims will be invalidated.

Communication box

The optional communication box allows external hardware from Miele and other suppliers to be connected to the Miele Professional machine. External hardware includes, e.g. payment system, peak-load system, pressure sensor or an external vent flap.

The communication box is supplied with mains voltage by the Miele Professional machine. The separately available set consists of the communication box and fasteners for installation on the machine or on the wall.

XKM 3200 WL PLT

The optional Miele communication module can be used to establish a data connection between a Miele Professional machine and a data processor in accordance with the Ethernet or WiFi standard.

This communication module fits into the communication slot which is a standard feature on all machines. The communication module offers the option of intelligent app-based communication with external systems (such as central smart payment terminals or payment systems). In addition, it can display detailed machine and programme status information. This module forms the basis for wired communication with Miele MOVE.

It is not possible to integrate the machine into the “Miele@home” app for domestic installations.

The communication module is intended exclusively for commercial use and is supplied with mains voltage directly via the Miele Professional machine. No additional power connection is required. The Ethernet interface provided via the communication module complies with SELV (safety extra low voltage) requirements in accordance with EN 60950. Connected external machines must also comply with SELV.

Data protection and data security

When you activate the networking function and connect your machine to the Internet, your machine sends the following data to the Miele Cloud:

- Machine serial number
- Machine model and technical features
- Machine status
- Information about the software status of your machine

Initially, this data cannot be assigned to a specific user and is not saved permanently. Data cannot be saved permanently or assigned to a specific user until after you have linked your machine to a user. Data transmission and processing are governed by Miele's strict security standards.

Factory default settings for network configuration

You can reset all of the settings on the communication module or your integrated WiFi module to the factory default settings. The network configuration should be reset whenever a machine is being disposed of or sold, or if a used machine is being put into operation. This is the only way to ensure that all personal data has been removed and the previous owner will no longer be able to access the machine.

Copyright and licences

For the purpose of operating and controlling the communication module, Miele uses proprietary or third-party software that is not covered by open source licensing terms. This software/these software components are protected by copyright. The copyrights held by Miele and third parties must be respected.

Furthermore, this communication module contains software components which are distributed under open source licence conditions. The open source components contained in the machine along with the corresponding copyright notices, copies of the licensing terms valid at the time and any further information can be accessed locally by IP using a web browser (<https://<IP address>/Licenses>). The liability and warranty arrangements for the open source licences displayed in this location only apply in relation to the respective rights holders.

Payment systems

This tumble dryer can be fitted with a payment system (optional Miele accessory). In this case, a Miele Customer Service technician must programme the relevant settings in the tumble dryer's electronics and connect the payment system.

The Miele Connector Box accessory unit or the COM module is required to connect a payment device.

Technical data

Height	1020 mm
Width	700 mm
Depth	763 mm
Depth with door open	1248 mm
Weight	75 kg
Drum volume	180 l
Maximum load size	10 kg (weight of dry laundry)
Length of supply lead	1600 mm
Supply voltage	See data plate
Rated load	See data plate
Fuse rating	See data plate
Lamp wattage	See data plate
Test certifications awarded	See data plate
Max. floor load in operation	883 N
Product safety standard	EN 10472, EN 60335
Emission sound pressure level in accordance with EN ISO 11204/11203	< 70 dB re 20 µPa
Frequency range	2.4000–2.4835 GHz
Maximum transmission power	< 100 mW

UK declaration of conformity

UKCA mark (UK only)

The Supply of Machinery (Safety) Regulations 2008

This **Statement of Compliance** confirms this Miele product fully complies with the **Product Security and Telecommunications Infrastructure (Security Requirements for Relevant Connectable Products) Regulations 2023**.

- 1) Professional Appliance – *Tumble Dryer, commercial PT011, PT012, PT016, PT018*
- 2) Manufactured by: Miele & Cie KG, *PT013, PT014, PT015, PT017*
Carl Miele Street 29, 33332 Gutersloh Germany
Imported by and contact point: Miele Company Ltd, Fairacres, Marcham Road, Abingdon, Oxon, OX14 ITW Great Britain
- 3) The defined support period at the time of first supply is 10 years
- 4) To report vulnerabilities and cybersecurity issues please contact: psirt@miele.com
- 5) Signature 
Name: **Paul Wright**
Company Position: **Head of Technical Management**
Date of signature: **19th March 2024**
Place of signature: **Abingdon, Oxfordshire**

United Kingdom

Miele Co. Ltd., Fairacres, Marcham Road
Abingdon, Oxon, OX14 1TW
Professional Sales, Tel: 0845 365 6608
E-mail: professional@miele.co.uk
Internet: www.miele.co.uk/professional

Australia

Miele Australia Pty. Ltd.
ACN 005 635 398, ABN 96 005 635 398
Level 4, 141 Camberwell Road, Hawthorn East, VIC 3123
Tel: 1300 731 411
Internet: www.miele.com.au/professional
E-mail: professional.sales@miele.com.au

China Mainland

Miele Electrical Appliances Co., Ltd.
1-3 Floor, No. 82 Shi Men Yi Road
Jing' an District, 200040 Shanghai, PRC
Tel: +86 21 6157 3500, Fax: +86 21 6157 3511
E-mail: info@miele.cn, Internet: www.miele.cn

Hong Kong, China

Miele (Hong Kong) Ltd.
41/F - 4101, Manhattan Place
23 Wang Tai Road, Kowloon Bay, Hong Kong
Tel: (852) 2610 1025, Fax: (852) 3579 1404
Email: customerservices@miele.com.hk
Website: www.miele.hk

India

Miele India Pvt. Ltd.
1st Floor, Copia Corporate Suites,
Commercial Plot 9, Mathura Road, Jasola,
New Delhi - 110025
E-mail: customercare@miele.in, Website: www.miele.in

Ireland

Miele Ireland Ltd.
2024 Bianconi Ave., Citywest Business Campus,
Dublin 24
Tel: (01) 461 07 10, Fax: (01) 461 07 97
E-Mail: info@miele.ie, Internet: www.miele.ie

Malaysia

Miele Sdn Bhd
Suite 12-2, Level 12
Menara Sapura Kencana Petroleum
Solaris Dutamas No. 1, Jalan Dutamas 1
50480 Kuala Lumpur, Malaysia
Phone: +603-6209-0288
Fax: +603-6205-3768

New Zealand

Miele New Zealand Limited
IRD 98 463 631
8 College Hill
Freemans Bay, Auckland 1011, NZ
Tel: 0800 464 353
Internet: www.miele.com.au/professional
E-mail: professional.sales@miele.com.au

Singapore

Miele Pte. Ltd.
29 Media Circle, #11-04 ALICE@Mediapolis
Singapore 138565
Tel: +65 6735 1191, Fax: +65 6735 1161
E-Mail: info@miele.com.sg
Internet: www.miele.sg

South Africa

Miele (Pty) Ltd
63 Peter Place, Bryanston 2194
P.O. Box 69434, Bryanston 2021
Tel: (011) 875 9000, Fax: (011) 875 9035
E-mail: info@miele.co.za
Internet: www.miele.co.za

United Arab Emirates

Miele Appliances Ltd.
Showroom 1, Eiffel 1 Building
Sheikh Zayed Road, Umm Al Sheif
P.O. Box 114782 - Dubai
Tel. +971 4 3044 999, Fax. +971 4 3418 852
800-MIELE (64353)
E-Mail: info@miele.ae
Website: www.miele.ae



Manufacturer: Miele & Cie. KG, Carl-Miele-Straße 29, 33332 Gütersloh, Germany