

Operating Instructions Countertop Coffee Machine



To prevent accidents and machine damage, you **must** read these instructions before installation or use.

Caring for the environment

Packaging material

The packaging material used protects the machine during transportation. Please retain the original box and polystyrene pieces so that you can pack the appliance securely, should you need to transport it in the future.

Disposal of your old appliance

Electrical and electronic appliances contain valuable materials. They also contain certain substances, compounds and components which were essential for the proper functioning and safe use of the equipment. Handling these materials improperly by disposing of them in your household waste can be harmful to your health and the environment. Therefore, please do not dispose of your old appliance with regular household waste and follow local regulations on proper disposal.



Consult with local authorities, dealers or Miele in order to dispose of and recycle electrical and electronic appliances. Miele assumes no responsibility for deleting any personal data left on the appliance being disposed. Please ensure that your old appliance is kept away from children until removal. Observe safety requirements for appliances that may tip over or pose an entrapment hazard.

Caring for the environment	2
IMPORTANT SAFETY INSTRUCTIONS	7
Important instructions for use	10
Machine description	17
The milk flask.....	18
Connecting piece for milk siphon and milk flask.....	18
Controls and indicators	19
Drink button symbols.....	20
Symbols in the display.....	21
Operation	22
Miele@home	23
Before first use	24
Filling the water tank	26
Filling the coffee bean container	27
Switching on and off	28
Switching the coffee machine on.....	28
Preparing for an extended period of inactivity	28
Cup heating	29
Adjusting the coffee dispensers to the cup height	30
Preparing beverages	31
Coffee.....	31
Coffee drinks made with and without milk	31
The milk.....	31
Preparing the milk flask.....	32
Using a milk carton with the milk siphon	33
Making a coffee drink.....	34
Canceling a drink.....	34
DoubleShot.....	34
Making 2 portions (☐ sensor button).....	35
Coffee pot	35
Making coffee drinks from ground coffee	35
Tea	36
Making tea	37
Dispensing warm or hot water	38

Contents

Changing the portion size	38
Expert Mode	39
Switching Expert mode on and off.....	39
Grinder setting	40
Identifying the ideal grinder setting.....	40
Adjusting the fineness of grind.....	40
Parameters	41
Displaying and changing parameters	41
Portion size.....	41
Amount of coffee	41
Pre-brewing ground coffee	41
Brewing temperature	42
Profiles	43
Creating profiles	43
Making drinks stored in a profile	43
Changing drinks within a profile	43
Editing profiles	43
Setting when the profile should change.....	44
Changing the name	44
Deleting the profile	44
MobileStart	45
Settings	46
Displaying and changing Settings.....	46
Language.....	46
Timer: switch off after.....	46
TeaTimer	46
Volume	46
Display brightness.....	46
Lighting.....	46
Info (display information)	46
Altitude.....	47
Performance Mode	47
Eco Mode.....	47
Barista Mode.....	47
Latte Mode	47
Party Mode.....	47
Water hardness.....	47
System lock 	48
Miele@home	49

Remote control	49
RemoteUpdate	49
Software version.....	50
Showroom program (Demo mode).....	50
Factory default settings.....	50
Cleaning and care	51
Overview of cleaning intervals.....	51
Clean by hand or in dishwasher	52
Unsuitable cleaning agents.....	53
Cleaning the drip tray and grounds container	53
Cleaning the drip tray cover.....	54
Cleaning the water container.....	54
Cleaning the water container filter.....	55
Cleaning the main dispenser	55
Cleaning the steam jet.....	56
Cleaning the milk pipework and rinse valve.....	56
Cleaning the milk siphon	58
Cleaning the milk flask.....	58
Cleaning the bean container and ground coffee chute	58
Cleaning the casing.....	59
Accessing the Maintenance menu	59
Rinse appliance.....	59
Rinsing the milk pipework	59
Cleaning the milk pipework (maintenance program)	60
Degreasing the brew unit and cleaning the interior	60
Descaling the appliance	62
Frequently asked questions.....	65
Messages in the display	65
Unusual performance of the coffee system	68
Unsatisfactory results.....	76
Transport.....	78
Evaporating the coffee machine.....	78
Packaging.....	78
Service and warranty.....	79
Contact in the event of a fault	79
Appliance warranty and product registration	79
Accessories	80
Saving energy.....	81

Contents

Electrical connection	82
Installation	83
Appliance dimensions	84
Technical data	86

IMPORTANT SAFETY INSTRUCTIONS

This coffee machine complies with all current safety requirements. Inappropriate use can, however, lead to personal injury and material damage.

Read the operating instructions carefully before using the coffee machine. They contain important information on the installation, safety, use and maintenance of the appliance. This prevents both personal injury and damage to the coffee machine.

Miele strongly advises you to read and follow the instructions in the chapter on installing and connecting the coffee machine as well as the IMPORTANT SAFETY INSTRUCTIONS.

Miele cannot be held liable for injury or damage caused by non-compliance with these instructions.

Keep these operating instructions in a safe place and pass them on to any future owner.

IMPORTANT SAFETY INSTRUCTIONS

Appropriate use

- ▶ Do not use appliance for other than intended use.
- ▶ Do not use the coffee machine outdoors.
- ▶ This coffee machine must not be used at altitudes above 6560 ft (2000 m).
- ▶ Persons who lack physical, sensory or mental abilities or experience with the machine should not use it without supervision or instruction by a responsible person.

Safety with children

 Danger of burning and scalding at the dispensers.

Children's skin is far more sensitive to high temperatures than that of adults.

Ensure children do not touch hot surfaces of the coffee machine or place parts of their body under the dispensers.

- ▶ Keep the coffee system out of reach of children.
- ▶ Keep children away from the coffee machine and the power cord.
- ▶ Children must be aware of the potential dangers caused by incorrect operation.
- ▶ Children should be supervised when they are near the coffee system. Do not allow them to play with it or to use the controls.
- ▶ Children must not be allowed to clean the coffee machine unsupervised.

IMPORTANT SAFETY INSTRUCTIONS

Technical safety

- ▶ Do not operate any appliance with a damaged cord or plug or after the appliance malfunctions, or has been damaged in any manner. Return appliance to the nearest authorized service facility for examination, repair or adjustment.
- ▶ Ensure that the power cord will not be pinched or damaged by any sharp edges.
- ▶ The power cord should not hang down. Someone could trip over it with the risk of injury and the appliance could be damaged.
- ▶ Do not let cord hang over edge of table or counter, or touch hot surfaces.
- ▶ Always attach plug to appliance first, then plug cord into the wall outlet. To disconnect, turn any control to “off”, then remove plug from wall outlet.
- ▶ Do not place on or near a hot gas or electric burner, or in a heated oven.
- ▶ Protect the coffee system from water and water spray. Do not immerse the appliance in water.
- ▶ To protect against fire, electric shock and injury to persons do not immerse cord, plugs, or coffee machine in water or other liquid.
- ▶ The use of accessory attachments not recommended by the appliance manufacturer may result in fire, electric shock or injury to persons.
- ▶ Unplug from outlet when not in use and before cleaning. Allow to cool before putting on or taking off parts, and before cleaning the appliance.

SAVE THESE INSTRUCTIONS

Important instructions for use

Appropriate use

- ▶ This coffee machine is intended for household use.
- ▶ The machine is intended only for household use and for the preparation of drinks such as espresso, cappuccino, latte macchiato, tea, etc. All other types of use are not permitted.

Safety with children

- ▶ Remember that coffee and espresso are not suitable drinks for children.
- ▶ Danger of suffocation. While playing, children may become entangled in packaging material (such as plastic wrapping) or pull the packaging material over their head, presenting the risk of suffocation. Keep packaging material away from children.

Technical safety

- ▶ Before installing the coffee system, check for externally visible damage. If the coffee system is damaged, it may pose a safety hazard and must not be used under any circumstances.
- ▶ Before connecting the coffee system, check the voltage and frequency indicated on the data plate against the voltage and frequency of the household electrical supply. This data must correspond in order to prevent damage to the coffee system. If in doubt, consult a qualified electrician.
- ▶ Be certain your appliance is properly installed and grounded by a qualified technician. To guarantee the electrical safety of this appliance, continuity must exist between the appliance and an effective grounding system. It is imperative that this basic safety requirement be met. If there is any doubt, have the electrical system of the house checked by a qualified electrician.

Important instructions for use

▶ Temporary or permanent operation on an autonomous power supply system or a power supply system that is not synchronized with the grid power supply (e.g., island networks, back-up systems) is possible. A prerequisite for operation is that the power supply system complies with national and local codes.

The function and operation of the protective measures provided in the domestic electrical installation and in this Miele product must also be maintained in isolated operation or in operation that is not synchronized with the grid power supply, or these measures must be replaced by equivalent measures in the installation.

▶ Do not connect the machine to the electrical supply using an extension cord or power bar.

▶ The coffee machine may not be used in mobile installations such as ships.

▶ Unplug the coffee machine from the power supply immediately if you notice any damage or smell burning.

▶ Only use the coffee system in rooms where the ambient temperature is between +60°F (10°C) and +100°F (38°C).

▶ Position the coffee machine at a height of at least 34" (850 mm) from the floor.

▶ Danger of overheating. Please ensure that there is adequate ventilation around the coffee machine. Do not cover the coffee machine with dish towels, etc. while it is in use.

▶ If the coffee machine is installed behind a closed cabinet front, it may only be used with the cabinet door open (see "Installation" for the minimum niche size). Heat and moisture can build up behind the cabinet front when closed. This can result in damage to the machine and/or cabinetry. Do not close the cabinet door while the coffee machine is in use. Leave the cabinet door open until the coffee machine has cooled down completely.

Important instructions for use

▶ Repairs and other work by unqualified persons to the appliance and the power cord could be dangerous. The manufacturer cannot be held liable for unauthorized work. Repairs may only be carried out by a Miele-authorized service technician.

▶ No user serviceable parts are contained in this appliance. Repairs should be carried out by a qualified technician using genuine Miele Parts. Failure to do so may create a hazardous condition and can result in voiding the warranty.

▶ The manufacturer's warranty may be invalidated if the appliance is not repaired by a Miele approved service technician from Technical Service.

▶ For repairs, the coffee system must be disconnected from the electrical power supply.

The coffee system is only disconnected from the power supply if

- The power cord has been unplugged.
Unplug the cord by pulling on the plug, not on the cord.
- The fuses to the household power supply are turned off.
- Any screw-in fuses in the household supply are fully unscrewed.

▶ Never open the outer casing of the machine. Tampering with electrical connections or components and mechanical parts is highly dangerous to the user and can cause operational faults or electric shock.

▶ This device complies with Industry Canada licence-exempt RSS standard(s) and part 15 of the FCC Rules. Operation is subject to the following two conditions:

- (1) This device may not cause harmful interference, and
- (2) this device must accept any interference received, including interference that may cause undesired operation.

The construction of the device assures that the FCC exposure limits are verifiably met using the integrated WiFi module EK037.

Contains:

FCC ID: 2ACUWEK037

IC ID: 5669C-EK037

Correct use

 Danger of burning and scalding at the dispensers.
The liquids and steam dispensed are very hot.

Keep away from the area underneath the dispensers when hot liquids and steam are being dispensed.

Do not touch hot components.

Hot liquid or steam could spatter from the spouts. Ensure that the central spout is clean and installed correctly.

Water in the drip tray can also be very hot. Take care when emptying it.

 Risk of injury to the eyes!

Never look at the lighting directly or using optical instruments (e.g. magnifying glass).

▶ Please note the following regarding water:

- The water quality must conform to the requirements for drinking water in the country in which the coffee machine is being used.
- Only use cold, fresh tap water to fill the water container. Hot or warm water or other liquids can damage the coffee machine.
- Change the water every day to prevent a build-up of bacteria.
- Do not use sparkling water.

▶ Only fill the bean container with roasted espresso or coffee beans. Do not fill the bean container with coffee beans that have been treated with additives or with ground coffee.

▶ Do not pour liquids into the bean container.

▶ Do not use green (unroasted) coffee beans or mixtures of coffee beans which contain green coffee beans. Green coffee beans are very hard and still contain residual moisture. These can damage the coffee machine grinder as soon as grinding begins.

Important instructions for use

- ▶ Do not use oily beans or beans that have been treated with caramel, sugar, or other substances. Sugar and oil will damage the coffee system.
- ▶ Only fill the coffee chute with ground coffee beans.
- ▶ Do not use any flavored ground coffee. The sugar in the coffee will stick to and block the brew unit of the coffee system. The cleaning tablets for degreasing the brew unit will not remove this type of deposit.
- ▶ Only use plain milk. Most sugary additives can clog the milk lines and damage the machine.
- ▶ If using dairy milk make sure that it has been pasteurized.
- ▶ When making tea, please follow the instructions on the tea packaging.
- ▶ Do not place flaming alcohol mixtures underneath the central spout. The flames could ignite plastic components and cause them to melt.
- ▶ Do not use open flames, such as a candle, on or near the coffee machine. The coffee machine could catch fire with the risk of the fire spreading.
- ▶ Do not use the coffee system to clean objects.

Cleaning and maintenance

- ▶ See “Cleaning and care” for more information.
- ▶ Clean the coffee machine and the milk flask (supplied as standard, depending on model) daily, particularly before using for the first time.
- ▶ All parts of the milk system need to be cleaned thoroughly and regularly.
- ▶ Do not use a steam cleaner to clean this machine. Steam could reach electrical components and cause a short circuit.

Important instructions for use

- ▶ Descale the coffee system regularly depending on the water hardness level in your area. Descale the machine more frequently in areas with very hard water. Miele cannot be held liable for damage arising from insufficient descaling, the use of incorrect descaling agent or the use of descaling agent that is not of the appropriate concentration.
- ▶ Degrease the brew unit regularly with Miele cleaning tablets. Depending on the natural oil content of the coffee used, the brew unit can become blocked quite quickly.
- ▶ Rinsing coffee grounds down the drain can cause the sink to clog. Instead, dispose of your coffee grounds appropriately as biodegradable waste (where facilities exist) or by composting.

Important instructions for use

Accessories and parts

- ▶ Only use genuine Miele accessories. If other parts are used, warranty, performance, and/or product liability claims may be invalidated.
- ▶ Miele can only guarantee the safety of the appliance when genuine Miele replacement parts are used. Faulty components should only be replaced by genuine Miele replacement parts.

For machines with stainless steel surfaces:

- ▶ Do not use sticky notes, transparent adhesive tape, masking tape, or other types of adhesive on the stainless steel surfaces.
- ▶ Stainless steel surfaces are susceptible to scratching. Even magnets can cause scratches.

SAVE THESE INSTRUCTIONS

Machine description

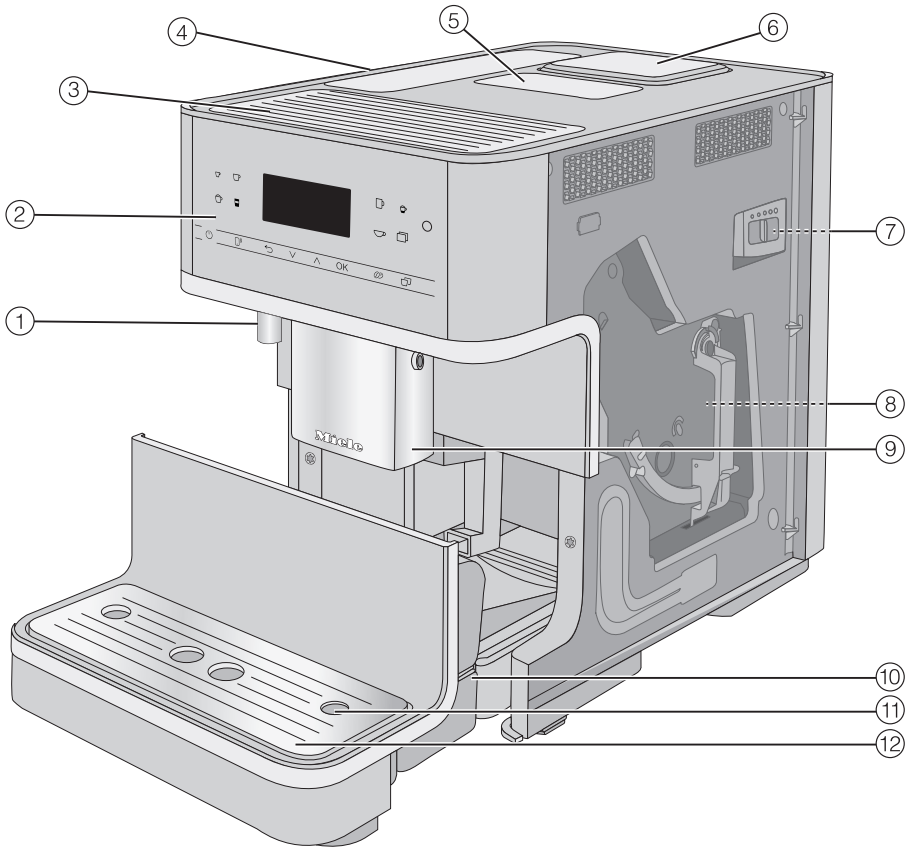

- ① Hot water dispenser
- ② Control panel
- ③ Cup heating*
- ④ Water container
- ⑤ Ground coffee chute
- ⑥ Bean container
- ⑦ Grinder setting (behind the service panel)
- ⑧ Brew unit (behind the service panel)
- ⑨ Height-adjustable main dispenser

- ⑩ Drip tray with lid and grounds container
- ⑪ Milk pipework opening
- ⑫ Lower panel with drip tray cover

* depending on model: CM 6360, CM 6560

Machine description

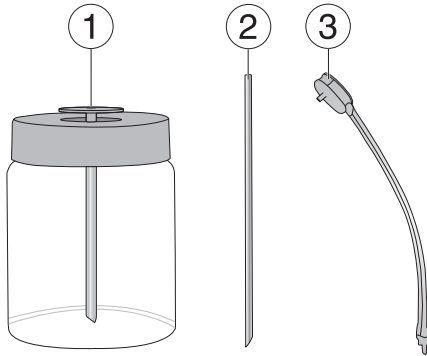

- ① Milk flask*
- ② Milk siphon
- ③ Milk pipework with rinse valve

* depending on model: CM 6360,
CM 6560

The milk flask

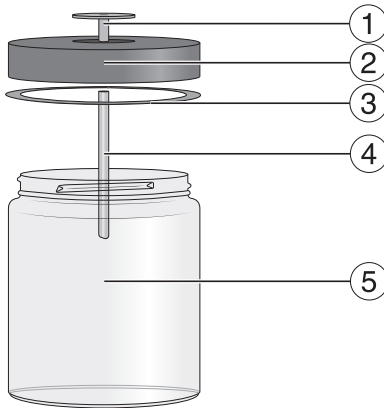

- ① Connection piece
- ② Lid
- ③ Sealing ring
- ④ Stainless steel tube
- ⑤ Glass

Connecting piece for milk siphon and milk flask

You can prepare milk with the milk siphon or milk flask (included, depending on the model).

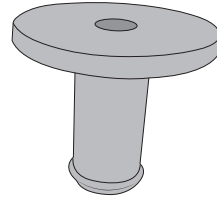



There is one connecting piece (included) which can be inserted either into the milk siphon or into the milk flask lid.

The appliance is supplied with the connecting piece either enclosed separately or inserted into the milk flask lid (depending on the model).

The connecting piece is easy to push out from the inside of the milk flask lid.

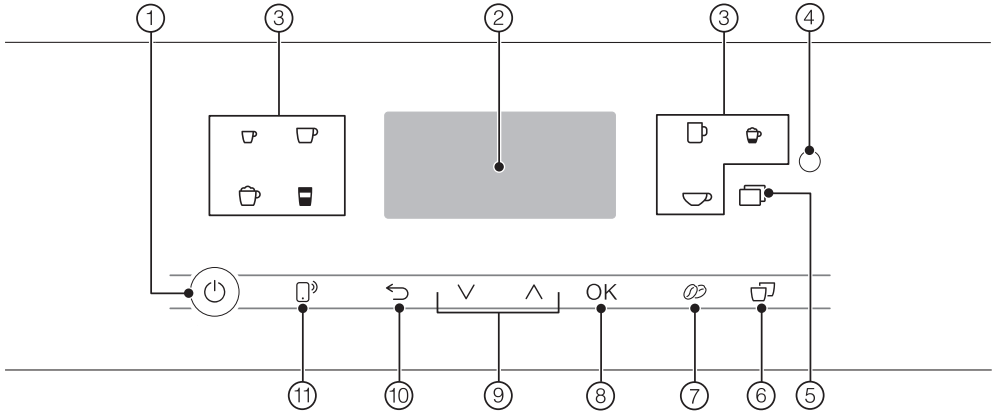

Controls and indicators



- ① **On/Off button** 

For switching coffee machine on and off
- ② **Display**

For showing information about the current action or status
- ③ **Drink buttons**

For making drinks
- ④ **Optical interface**
(for Miele Technical Service only)
- ⑤ ** sensor button**
 - For making other drinks: ristretto, capuccino italiano, flat white, café au lait, hot milk and milk froth, hot water, warm water, coffee pot function
 - Maintenance programs
 - Profiles
 - Settings
- ⑥ **“2 portions”**  **sensor button**

For dispensing 2 portions of a drink at once
- ⑦ **“DoubleShot”**  **sensor buttons**

For making a particularly strong and aromatic coffee by using twice as much ground coffee but the same amount of water
- ⑧ **OK sensor button**

For confirming display messages and saving settings
- ⑨ **Arrow buttons** 







For scrolling through lists, selecting entries, or changing values
- ⑩ **“Back”**  **sensor button**

For returning to the previous menu and canceling unwanted actions
- ⑪ **MobileStart sensor button** 

For activating the Remote start option for making drinks via the Miele app







Controls and indicators

Drink button symbols

-  Espresso
-  Coffee
-  Long coffee
-  Capuccino
-  Latte macchiato
-  Espresso macchiato
-  Tea water

Symbols in the display

The following symbols may also appear in the display in addition to the text:

Symbol	Explanation
	This symbol indicates the Settings menu and the Language menu option.
	This symbol indicates that there is additional information and advice about using the coffee machine. Select <i>OK</i> to confirm the information.
	This symbol appears if the system lock is activated. Operation is locked.
	The TeaTimer kitchen timer has been started (see “TeaTimer” in the “Tea” chapter). The remaining brewing time is shown next to the symbol.
	This symbol appears while the appliance is being descaled. (This symbol can also be found on the water container: fill up to this mark).
	If Miele@home has been activated for the coffee machine, these symbols represent the quality of the Wi-Fi connection. They indicate the strength of the W-iFi connection in increments from strong to not connected.

Operation

Sensor buttons

To operate the coffee machine, tap the sensor buttons with your finger.

An audible signal is generated each time a button is tapped. You can adjust the volume of the signal tones or switch the tones off (see “Settings – Volume”).

Drinks menu

When the following appears in the display, you are in the drinks menu: Select drink.

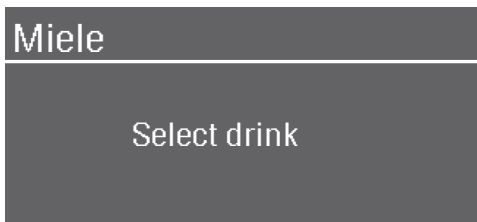

You can find more drinks in the Additional menu (☐ sensor button).

Selecting a menu and navigating within a menu

To select a menu, tap the relevant sensor button, e.g., the ☐ sensor button.

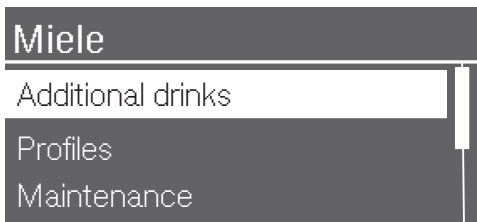

You will then be able to start an action or change settings in the menu. A scroll bar at the right of the display shows that additional options or text are available.

To select a menu option, keep pressing the arrow buttons \wedge \vee until the option you want is highlighted.

As soon as you reach a confirmable value, message, or setting, the *OK* sensor button will light up orange.

Tap *OK* to confirm your selection.

The setting which is currently selected in a list will have a checkmark \checkmark beside it.

Exiting a menu or canceling an action

To exit the current menu, tap the \leftarrow sensor button.

Alternatively, tap the lit orange sensor button again to return to the drinks menu.

Your coffee machine is equipped with an integrated Wi-Fi module.

Before installing the coffee machine at its installation site, ensure that the signal from your Wi-Fi network is strong enough.

To use this feature, you will need:

- a Wi-Fi network
- the Miele app
- a Miele user account (this can be created from the Miele app)

The Miele app will guide you through the process of connecting your coffee machine to your home Wi-Fi network.

Once your coffee machine is connected to your Wi-Fi network, you can use the app to carry out activities such as the following:

- calling up information on the operating status of your coffee machine
- changing settings on your coffee machine
- controlling your coffee machine remotely

Connecting your coffee machine to your Wi-Fi network will increase energy consumption, even when the machine is switched off.

Availability of the Wi-Fi connection

The Wi-Fi connection shares a frequency range with other appliances (including microwave ovens and remote control toys). This can cause sporadic or

even complete connection failures. Therefore, the availability of featured functions cannot be guaranteed.

Miele@home availability

The ability to use the Miele app depends on the availability of the Miele@home service in your country.

The Miele@home service is not available in every country.

For information about availability, please visit www.miele.com.

Miele App

The Miele App is available to download free of charge from the Apple App Store® or from the Google Play Store™.



Before first use

Before using for the first time

- Remove any notices from the machine.

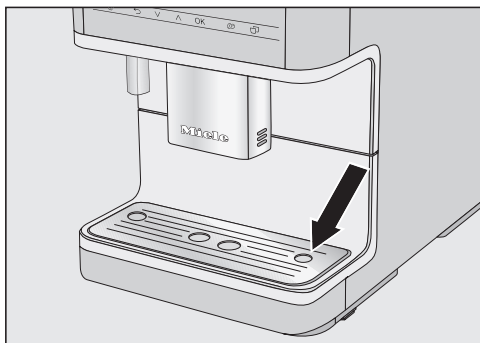

- Remove the protective film from the drip tray cover and place it into the lower panel.
- Place the coffee machine on a level flat surface that is not sensitive to water (see “Installation”).

Clean the appliance before filling it with water and coffee beans. Refer to the relevant instructions in “Cleaning and care”; for example, clean the bean container with a soft, dry cloth.

- Clean the water container, the bean container, and the main dispenser.
- Remove the water container and fill it with fresh, cold tap water. Only fill the container up to the “max.” mark and then reinsert the water container.
- Take the lid off the coffee bean container, fill the container with roasted coffee beans, and replace the lid.
- Insert the electrical plug of the coffee machine into the outlet.

Turning on for the first time

- Press the On/Off button  if nothing is visible in the display.

Selecting the display language

- Select the desired display language.

You might also be asked for your location.

Setting up the network (Miele@home)

You can connect your coffee machine to your Wi-Fi network.

The following appears in the display during commissioning: Set up “Miele@home”

Tip: You can also choose to set up Miele@home for your coffee machine at a later point. In this case, select *Skip*.

- Make sure that your Wi-Fi network signal is sufficiently strong in the coffee machine's installation site.
 - Tap *Continue*.
 - Select the connection method you wish to use.
 - Follow the instructions provided in the coffee machine display and in the Miele app.
- Connection successfully established appears in the display.
- Touch *OK* to proceed with commissioning.

Setting the water hardness

Your local water authority will be able to tell you the hardness of the water in your area.

More information can be found under “Settings – Water hardness”.

- Enter your local water hardness (in °dH) and confirm with *OK*.

Selecting the Performance Mode

You can select the appropriate mode to suit your personal preferences (see “Settings – Performance Mode”).

- **Eco Mode:** This is an energy-saving mode.
 - **Barista Mode:** This mode has been optimized for unadulterated coffee enjoyment.
 - **Latte Mode:** In this mode, milk-based drinks can be prepared within a much shorter space of time.
- Select the mode you want.
 - Confirm with *OK*.

Your machine has been successfully set up and is ready for use.

- Confirm with *OK*.

The coffee machine heats up and rinses the pipework. The water used for rinsing will run out of the main dispenser.

- Before preparing milk for the first time, rinse the milk pipework (see “Cleaning and care – Rinsing the milk pipework”).

Please note that the coffee aroma and the characteristic crema only develops after the first few coffees have been made.

Switch the coffee machine off with the On/Off button . Do not unplug the power cord to switch off the coffee machine. If you unplug the coffee machine from the power supply while using it for the first time, you will have to set it up for use again.

A larger quantity of coffee beans is ground for the first coffee drinks and powder from the coffee grounds may adhere to the lid of the drip tray.

To ensure that any coffee residues from the factory testing process are removed from the brewing system, please throw away the first 2 cups of coffee when using the coffee machine for the first time.

Filling the water tank

⚠ Risk to health due to contaminated water.

Bacteria can develop in water which has been sitting in the water container for too long and is a risk to your health.

Change the water in the water container **every day**.

If the water container sits a little too high or at an angle, check whether the surface under the water container is soiled. This will prevent the dispenser valve from attaching correctly and water can leak out. Clean the surface underneath the water container if necessary.

⚠ Risk of damage due to incorrect operation.

Unsuitable liquids such as hot or warm water or other liquids can damage the coffee machine.

Carbonated water leaves too much limescale in the coffee machine.

Only use cold, fresh tap water to fill the water container.

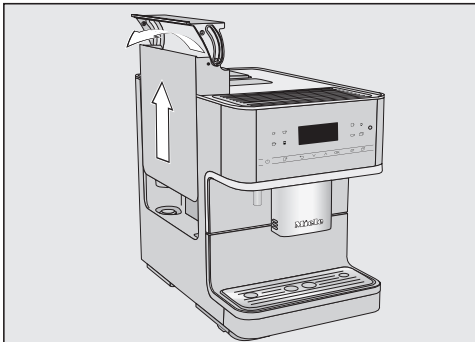

- Press the lid on the right-hand side.
- Pull the water container up by its lid to remove it.
- Fill the water container with fresh, cold tap water up to the *max.* mark.
- Reinsert the water container.

Filling the coffee bean container

Coffee or espresso can be made from whole roasted coffee beans which are freshly ground for each cup. This requires the coffee bean container to be filled with coffee beans.

Alternatively, you can make coffee drinks with ready ground coffee.

 Risk of damage to the grinder due to incorrect operation.

The coffee machine will be damaged if the bean container is filled with unsuitable substances such as liquids, ground coffee, or coffee beans treated with sugar, caramel, or similar.

In addition, green (unroasted) coffee beans or mixtures of coffee beans which contain green coffee beans can damage the grinder. Green coffee beans are very hard and still contain residual moisture. These can damage the coffee machine grinder as soon as grinding begins.

Only put roasted coffee beans in the bean container.

Tip: You can use a nut or seed grinder to grind green coffee beans. These grinders generally have a rotating stainless steel blade. You can then add the ground green coffee **one portion at a time** to the ground coffee chute and make the desired coffee drink.

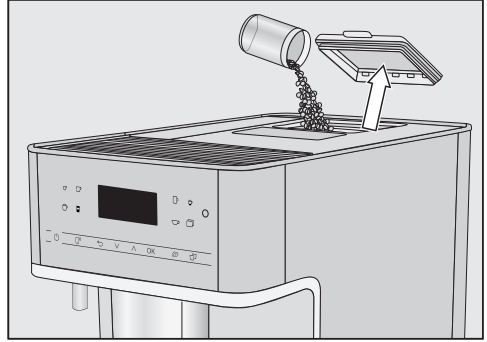

- Take the lid off the coffee bean container.
- Fill the bean container with roasted coffee beans.
- Replace the lid.

Tip: Only add enough beans to last for a few days. Contact with air causes coffee beans to lose their aroma.

Switching on and off

Switching the coffee machine on

- Tap the On/Off button .

The coffee machine heats up and rinses the pipework. Hot water will run out of the main dispenser.

When *Select drink* appears on the display, you can make drinks.

If the coffee machine is already at operating temperature, rinsing will not take place when the appliance is switched on.

If no buttons are tapped or maintenance programs carried out, the display will turn off after approx. 7 minutes to save energy. The *OK* button will flash on and off as long as the coffee machine is switched on.

- Tap any one of the sensor buttons to wake the coffee machine up again to make a drink.

Switching the coffee machine off

- Tap the On/Off button .

If coffee has been dispensed, the coffee machine will rinse the pipework automatically before switching off.

Preparing for an extended period of inactivity

If the coffee machine is not going to be used for a while, e.g., if you are going on vacation, remember to do the following:

- Empty the drip tray, the grounds container, and the water container.
- Clean all parts thoroughly, including the brew unit.
- Unplug the coffee machine's electrical plug to disconnect it from the power supply.



(depending on model: CM 6360, CM 6560)

Cups should always be pre-heated to allow the flavor of the coffee to develop and its temperature to be retained.

You can pre-heat cups or glasses on the cup heater on the top of the coffee machine.

If cup heating is activated, the cup heating surface will be heated continually until the coffee machine is switched off.

Switching the cup heater on or off

- Tap the  sensor button.
- Select Settings  | Cup heating.
- Select the option you want and confirm with *OK*.

The setting is now saved.

Pre-heating cups

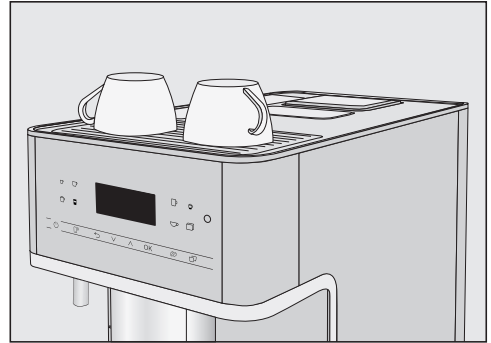

- Arrange the cups or glasses on the cup heating surface on the top of the coffee system.

Adjusting the coffee dispensers to the cup height

You can adjust the main dispenser to suit the height of the cup you are using so that the coffee or espresso will not cool down as quickly and the crema will have a better consistency.

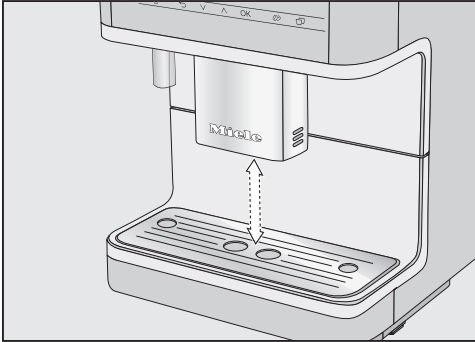

- Pull the main dispenser down until it is at the same level as the rim of the cup.
Alternatively, push the main dispenser up until there is enough room to fit a larger cup or mug underneath.

 Danger of burning and scalding at the dispensers.

The liquids and steam dispensed are very hot and can cause scalding.

Keep away from the area underneath the dispensers when hot liquids and steam are being dispensed.

Do not touch hot components.

Coffee

Coffee drinks made with and without milk

You can use the coffee machine to prepare the following coffee-based drinks:

- **Ristretto** is a concentrated, stronger espresso. It is prepared with the same amount of coffee as for an espresso but with a lot less water.
- **Espresso** is a strong aromatic coffee with a thick hazelnut-brown colored froth – known as the crema – on top. We recommend using espresso-roasted coffee beans to make an espresso.
- **Coffee** differs from espresso by the increased amount of water and the roast of the beans. We recommend using coffee beans of the correct roast to make the coffee.
- **Long Coffee** is a coffee with significantly more water.
- **Cappuccino** consists of approx. 2 thirds milk froth and 1 third espresso.
- **Latte macchiato** consists of 1 third each of hot milk, milk froth, and espresso.

- **Caffè latte** consists of espresso and hot milk.
- **Cappuccino Italiano** has the same proportions of milk froth and espresso as a cappuccino. The difference is that the espresso is added first and then the milk froth.
- **Espresso macchiato** is an espresso with a small amount of milk froth on top.
- **Flat white** is a special variety of capuccino that contains significantly more espresso than milk froth for an intensive coffee aroma.
- **Café au lait** is a French style of coffee consisting of coffee and milk froth. Café au lait is usually served in a bowl.

Hot milk and **milk froth** can also be made.

The milk

Cow's milk or alternative plant-based dairy products (e.g., soy milk) containing added sugar can clog up the milk pipe and milk pipework. Residues from unsuitable liquids can interfere with milk preparation. The milk used must not contain any additives.

Dairy milk naturally contains bacteria. If using dairy milk make sure that it has been pasteurized, e.g., pasteurized cow's milk.

Once the appliance has heated up, the milk will be drawn up into the central spout where it is heated by steam and also frothed for drinks requiring milk froth.

Preparing beverages

You can prepare hot milk and milk froth using cow's milk or alternative plant-based dairy products. However, the consistency of the milk froth will vary greatly depending on the type of milk used. Not all types of milk are suitable for milk froth.

Tip: Using cold cow's milk (< 50°F/10°C) with a protein content of at least 3% will produce the perfect milk froth. You can select milk with a fat content according to your personal preference. With whole milk (at least 3.5% fat), the milk froth will be slightly creamier than with low-fat milk.

Alternative plant-based dairy products – hereafter referred to as “alternative dairy products” – contain different ingredients than cow's milk, for example. Due to natural settling, dairy products tend to thicken. When preparing hot milk or milk froth, this thicker consistency can prevent the alternative dairy products from being drawn into the milk pipework.

Stir alternative dairy products well immediately before preparation.

Do not shake alternative dairy products. Shaking causes foam to form in the packaging and impairs the preparation process.

Tip: Rinse the milk pipework manually immediately after preparation.

Preparing the milk flask

Milk is **not** cooled in the milk flask. Milk may spoil if it is left in the milk flask for an extended period without being cooled (depending on the type of milk).

In particular, do not leave cow's milk in the milk flask for an extended period without cooling it.

Please follow the manufacturer's instructions regarding the shelf life of the milk used.

If you have not made any milk drinks for a while, rinse the milk pipework thoroughly before making the first drink.

Tip: For high-quality milk froth, always use cold milk (< 50°F/10°C).

- Insert the connecting piece into the lid from above until everything sits flush.
- Connect the stainless steel tube to the inside of the lid. Make sure that the slanted end of the stainless steel tube is pointing downward.
- If you use alternative dairy products, make sure that you stir it well. To ensure the best preparation, alternative dairy products must be stirred and not shaken.
- Fill the milk flask with milk up to a maximum of 3/4" (2 cm) below the rim. Seal the milk flask with the lid.

Preparing beverages

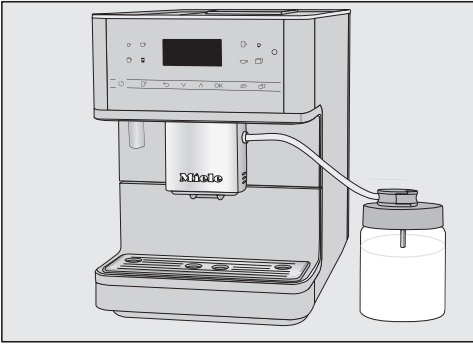

The milk siphon enables you to prepare milk directly from milk cartons or other suitable containers. The milk siphon is made up of a connecting piece and a long stainless steel tube.

Tip: For high-quality milk froth, always use cold milk (< 50°F/10°C).

- Place the milk flask to the right next to the coffee machine.
- Attach the milk pipework rinse valve to the milk flask lid.
- Connect the milk flask to the coffee machine by attaching the milk pipework to the aperture in the central spout.

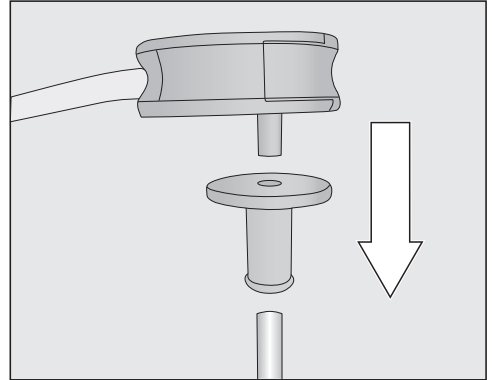

The “seam” on the milk pipework and on the central spout makes it easier to assemble it correctly.

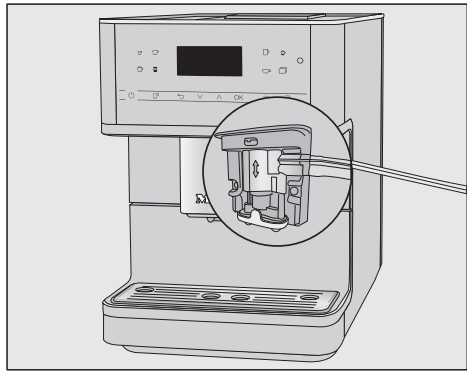

- First attach the connecting piece to the long stainless steel tube. Make sure that the slanted end of the stainless steel tube is pointing downward.
- Attach the rinse valve to the connecting piece.

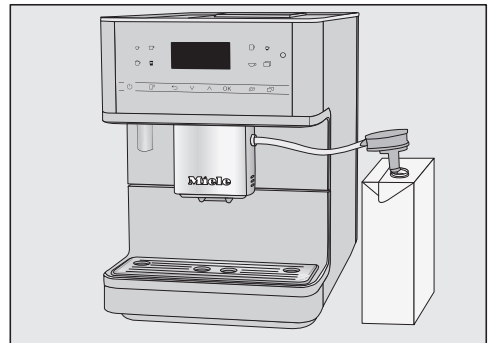

Using a milk carton with the milk siphon

If you have not made any milk drinks for a while, rinse the milk pipework thoroughly before making the first drink.

Preparing beverages

- If you use alternative dairy products, make sure that you stir it well. To ensure the best preparation, alternative dairy products must be stirred and not shaken.
- Place the milk carton to the right next to the coffee machine.
- Dip the milk siphon into the milk.
- Connect the milk pipework to the aperture in the central spout.

The “seam” on the milk pipework and on the central spout makes it easier to assemble it correctly.

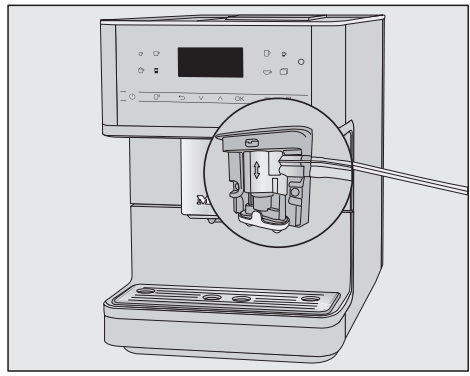

Tip: Rinse the milk siphon under running water after use.

Making a coffee drink



- Place a cup under the central spout.

- If you want to make a coffee with hot milk or milk froth, prepare the milk carton with the milk siphon or the milk flask.
- Select a drink: tap the sensor control for the drink you want. Or select a drink from the *Additional | Additional drinks* menu (sensor control .

Dispensing will start.

Canceling a drink

- Tap the lit orange symbol on the control panel again.

When preparing drinks with several ingredients (e.g., latte macchiato) you can cancel each of the individual components prematurely.

- Tap *OK* when *Stop* appears on the display.

DoubleShot

Select the DoubleShot  function if you would like a particularly strong and aromatic coffee. In this case, more coffee beans will be ground and brewed halfway through brewing.

The shorter extraction time means that fewer unwanted aromas and bitter compounds will be released.

DoubleShot can be activated for all drinks apart from “Ristretto”.

Making a DoubleShot of coffee

- Tap the  sensor button immediately before or after you start making a drink.

Dispensing starts and the  sensor button lights up. 2 portions of coffee beans will be ground and brewed.

Making 2 portions (☐ sensor button)

You can dispense 2 portions of a drink into 1 large cup or into 2 cups at the same time.



- Place a cup under each of the main coffee dispenser spouts.
- Tap the ☐ sensor button immediately before or after you start making a drink.

The ☐ sensor button lights up.

The dispensing starts and 2 portions of the desired drink will be dispensed.

Coffee pot

You can make several cups of coffee one after the other automatically with the Coffee Pot function (maximum of 1 liter).

The drinks menu is displayed.

Tip: Make sure that the bean and water containers have enough beans and water inside them before starting the Coffee Pot function.

- Place a sufficiently large container under the main dispenser.
- Tap the ☐ sensor button.
- Select **Additional | Additional drinks | Coffee Pot** and confirm with **OK**.
- Select the number of cups you want (3 to 8).

Each portion of coffee will be ground, brewed, and dispensed individually. You can follow the process on the display.

Canceling a drink

- Tap the ☐ sensor button.

Making coffee drinks from ground coffee

To make drinks using ready ground coffee, add a portion of ground coffee to the ground coffee chute.

This allows you to make a decaffeinated coffee even if the bean container is already filled with regular coffee beans, for example.

Only **1** portion of coffee or espresso can be made at a time when using ready ground coffee.

Place a **maximum of 0.4 oz (12 g)** in the ground coffee chute. If too much ground coffee is added, the brew unit will not be able to process the coffee.

Adding ground coffee

The coffee machine will use all the ground coffee that has been added to make the next coffee.

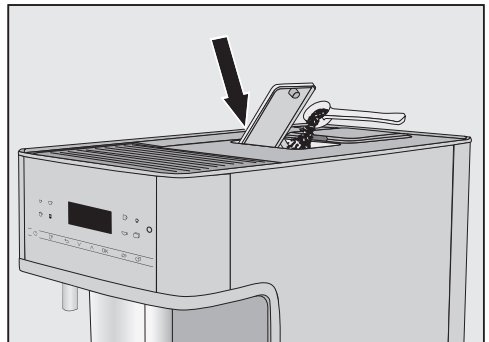

- Open the ground coffee chute.

Preparing beverages

Place a maximum of **0.4 oz (12 g)** in the ground coffee chute.

- Add ready ground coffee to the chute.
- Close the coffee chute.

Making coffee with ground coffee

The following will appear in the display:
Use ground coffee?

- Select **Yes** and confirm with **OK**.

You can now select which type of drink you would like to make with ground coffee.

- Place a cup under the main dispenser.
- Select a drink.

The coffee will now be made.

If you select **No** and confirm this with **OK**, the ground coffee will be disposed of in the waste container without being brewed. The appliance rinses.

Tea

The coffee machine is not intended for commercial or scientific purposes. Temperatures given are approximate and can vary depending on the ambient conditions.

When making tea, you can select from the following options:

- **Japanese Tea** is a high-quality green tea which boasts a fine, fresh, "green" taste.
Dispensed temperature:
approx. 150°F (65°C), brewing time:
approx. 1.5 minutes
- **White Tea** is a green tea where only the young buds of the tea plant are used and processed very gently.

White tea has a particularly mild taste.

Dispensed temperature:
approx. 160°F (70°C), brewing time:
approx. 2 minutes

- **Green Tea** gets its green color from the leaves of the tea plant. The tea leaves are either roasted or steamed depending on the region. Green tea can be infused multiple times.
Dispensed temperature:
approx. 170°F (77°C), brewing time:
approx. 2.5 minutes
- **Black Tea** gets its dark color and characteristic taste from the fermentation of tea leaves. Black tea can be enjoyed with a little lemon or milk.
Dispensed temperature:
approx. 188°F (87°C), brewing time:
approx. 3 minutes
- **Herbal Tea** is an aromatic infusion drink made up of dried leaves or fresh parts of plants.
Dispensed temperature:
approx. 188°F (87°C), brewing time:
approx. 8 minutes
- **Fruit Tea** is made from dried pieces of fruit and/or parts of plants, e.g., rose hip. The taste of the drink varies according to which plants are used and how they are blended. Lots of fruit teas are also flavored.
Dispensed temperature:
approx. 188°F (87°C), brewing time:
approx. 8 minutes

The type of tea determines the preset temperature for the dispenser. The respective dispensing temperatures are the ones that Miele recommends for making the types of tea concerned.

Preparing beverages

You can adjust the dispensing temperatures used for the individual teas by customizing the brewing temperature (see “Parameters – Brewing temperature”). A temperature increment of approximately 35°F (2°C) makes a noticeable difference.

Whether you use loose tea leaves, blended tea, or tea bags depends on your own personal preference.

Follow the instructions for making tea on the tea packaging.

The amount of tea required varies from one type of tea to another. Always follow the recommendations of the manufacturer on the packaging or of the retailer. You can adjust the amount of water according to the type of tea and the size of the cup (see “Portion size”).

Making tea

Tap the ☞ sensor button to access the menu containing the various types of tea.

The drinks menu is displayed.

- Pour loose tea into a tea filter or similar or take a tea bag out of the packet.
- Place the tea filter or the tea bag in the tea cup.

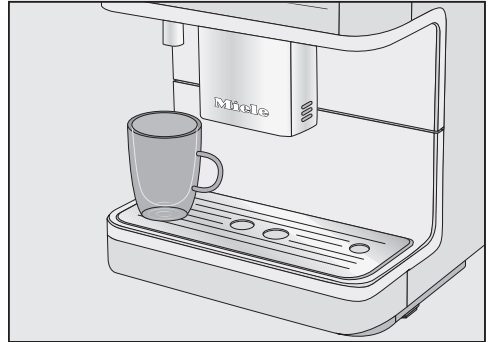

- Place the cup under the hot-water dispenser.
- Tap the ☞ sensor button.
- Select the type of tea you want and confirm your choice with *OK*.

Hot water will be dispensed into the cup.

If the TeaTimer | Automatic setting has been selected, the kitchen timer for the brewing time will start running once the water has been dispensed.

Starting the TeaTimer manually

TeaTimer appears in the display as soon as the water has been dispensed.

- Tap *OK*.

The editor will open with a suggested time.

- Change the brewing time if required and confirm with *OK*.

After the brewing time has elapsed, an audible signal will sound and the ☞ symbol will flash.

- Remove the tea filter or tea bag when the desired brewing time has elapsed.

Preparing beverages

Dispensing warm or hot water

 Danger of burning and scalding on the hot water dispenser. The liquids and steam dispensed are very hot and can cause scalding. Keep away from the area underneath the dispensers when hot liquids and steam are being dispensed. Do not touch hot components.

You can choose between the following options:

- hot water at approx. 175°F (80°C)
- warm water at approx. 140°F (60°C)

The drinks menu is displayed.

- Place a suitable container underneath the hot water dispenser.
- Tap the  sensor button.
- Select *Additional drinks* and choose between warm or hot water.
- Confirm with *OK*.

Dispensing will start.

Changing the portion size

- Place a cup under the central spout.
- Select *Portion size*.
- Confirm with *OK*.

The desired drink will be made and *Save* will appear in the display.

- When the container is filled to the desired level, tap *OK*.

If you want to change the portion size for coffee with milk, the ingredients of the drink are saved one after the other during preparation.

- When the quantity for each ingredient reaches the desired level, tap *OK*.



The programmed portion size will now be dispensed every time that particular drink is selected.

Tip: For the drinks pictured on the control panel, you can change the portion size by pressing and holding the button down while the drink is being dispensed. To do this, keep the drinks button pressed until the machine starts dispensing. During dispensing, *Save* appears in the display.

The Expert Mode function allows you to change the portion size while the drink is being made. The setting will **not** be saved and will only apply to the current drink.

Switching Expert mode on and off

The drinks menu is displayed.



- Touch the  sensor control.
- Select Settings  | Expert Mode.
- Select the option you want.
- Confirm with *OK*.

The setting is now saved.

Expert Mode: changing the portion size

The drinks menu is displayed.

The portion size can only be changed during the individual preparation stages.

If you select DoubleShot  or 2 portions , Expert mode cannot be used to change the portion size.

- Select a drink.

Dispensing will start. You can adjust the portion size while it is being dispensed, e.g., individually change the amount of hot milk, milk froth, and espresso for a latte macchiato.

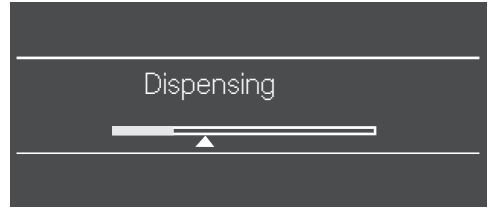

- Use the \wedge and \vee arrow buttons to move the indicator (small triangle) as you wish.

Grinder setting

The grinder setting determines the contact time between the ground coffee and the water, known as the extraction time. Only when the ideal grinder setting is selected can the appliance dispense a perfect cup of coffee with a fine, hazelnut-brown crema.

Identifying the ideal grinder setting

There are various ways to tell whether the coffee grinder is set correctly.

The coffee has been **too coarsely** ground if:

- The espresso or coffee flows into the cup very quickly.
- The espresso or coffee tastes sour.
- The crema is very pale and uneven.

The coffee has been **too finely** ground if:

- The espresso or coffee flows into the cup very slowly.
- The espresso or coffee tastes too bitter.
- The crema is dark brown.

Adjusting the fineness of grind

If the grinder setting is adjusted by more than one level, the grinder may be damaged.

Only adjust the grinder one setting at a time.

Each time you adjust the setting, start making a new drink so that the beans are ground. Adjust the grinder setting one setting at a time again.

- Open the appliance door.

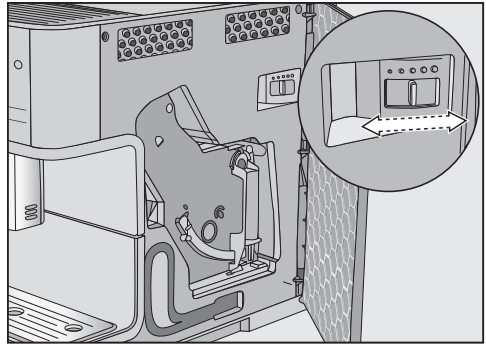

- Push the slide control one setting to the left (for finer grinding) or one setting to the right (for coarser grinding).

The grinder setting you select will be used for all coffee drinks.

- Close the service panel.
- Empty the drip tray **and** grounds container.
- Make one cup of coffee.

After this, you can adjust the grinder setting again.

The altered grinder setting will not be used until after the second coffee has been dispensed.

The grinder will naturally wear out slightly over time. Set the grinder to a finer setting if necessary.

Displaying and changing parameters

You can change the portion size for all drinks.

In addition, you can set the amount of coffee, brew temperature, and pre-brewing parameters for each coffee drink individually.

- Tap  and select Parameters.
- Select a drink and confirm with *OK*.

The parameters that can be changed for this drink are displayed.

Once you have selected a drink, the current settings for the following appear: Amount of coffee, Brew temperature, and Pre-brewing.

The Portion size menu option is displayed in the first line. If you select Portion size and confirm with *OK*, the drink will be dispensed immediately.

- Select the parameter you want.
- Change the setting as required and confirm with *OK*.

The setting is now saved.

Portion size

The flavor of the coffee produced depends not only on the type of coffee, but also on the amount of water used. You can program the amount of water for all drinks (apart from the Coffee Pot function) to suit the size of your cups and/or the type of coffee you are using.

For coffee drinks that use milk, you can also set the amount of milk or milk froth to be dispensed with these drinks, as well as the amount of coffee or espresso.

A maximum portion size can be programmed for each type of drink. Dispensing stops once this has been reached. The maximum possible portion size is then saved by the appliance for this type of drink.

If the water container becomes empty while making a drink, the coffee machine will stop programming the portion size. The portion size will **not** be saved.

Amount of coffee

The coffee machine can grind and brew 6-14 g of coffee beans per cup. The greater the amount, the stronger the coffee.

The amount of coffee is **too low** if the espresso or coffee lacks body.

Increase the amount of coffee to brew more ground coffee.

The amount of coffee is **too high** if the espresso or coffee tastes bitter.

Decrease the amount of coffee to brew less ground coffee.

Tip: If the coffee is too strong for you or it tastes bitter, try a different type of bean.

Pre-brewing ground coffee

When the pre-brewing function is turned on, the ground coffee is first moistened with a little hot water. The ground coffee swells a little. Then the remaining water is forced through the moistened coffee at high pressure. If your coffee tastes too bland and you want to add some spice and richness, try the “Pre-brewing” function. Depending on the type of coffee used, pre-brewing can intensify the taste.

Parameters

You can set a short or long duration for pre-brewing or turn the “Pre-brewing” function off completely.

Tip: It is particularly recommended to use the “Pre-brewing” function to make coffee.

Brewing temperature

The brewing temperature must be adapted to the roast of the beans you are using. This is crucial whether you are making espresso or coffee.

Several types are sensitive to high brewing temperatures, resulting in an impaired taste. If your coffee tastes bitter, the brewing temperature you have selected might be too high.

Espresso is usually brewed at higher temperatures.

In addition to the Miele drinks menu (Miele profile), you can create individual profiles to cater for different tastes and preferences.

Within the profile, you can adjust the portion sizes and parameters individually for all drinks.

The name of the current profile is shown in the top left of the display.

Creating profiles

■ Tap the  sensor button and select Profiles. Confirm with *OK*.

The Profiles menu opens.

■ Select Create profile.

The editor will open in the display.

Entering a name

Letters and numbers are entered using the \wedge and \vee arrow buttons. You can choose between upper and lower case letters.

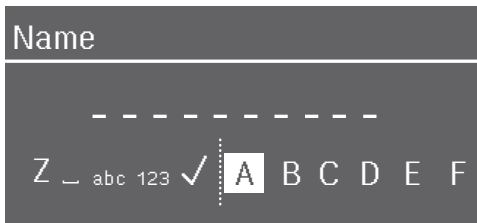

- To enter a character, highlight the one you want and confirm your choice with *OK*.

- To delete a character, tap the  sensor button.

- To save the name, select the checkmark  and confirm with *OK*.

■ Enter the profile name.

Tip: It is best to select short names.

The profile is created.

Making drinks stored in a profile

■ Tap the  sensor button and select Profiles. Confirm with *OK*.

■ Select the profile you want.

■ Select the drink you want.

The machine starts dispensing the drink.

Changing drinks within a profile

When you change the parameters of a drink within a profile, these settings only apply to the active profile. The settings for drinks contained within other profiles remain unaffected.

■ Select the profile you want.

The name of the selected profile is shown in the top left of the display.

You can now change the drinks individually.

Editing profiles

Once you have created at least one profile, you can edit the profiles in the Profiles menu.

■ Touch the  sensor control.

The Profiles menu opens.

■ Select Edit.

■ Confirm with *OK*.

You can now edit the following settings for the selected profile:

- setting when the profile should change

- changing the profile name

- deleting the profile

Profiles

Setting when the profile should change

- Touch the  sensor control.

The Profiles menu opens.

- Select Edit.
- Confirm with *OK*.
- Select Change profile.
- Confirm with *OK*.

You have the following options:

- **Manual:** The selected profile will remain active until you select another one.
 - **After each use:** The machine will revert to the Miele profile whenever a drink is dispensed.
 - **When turned on:** The Miele profile will be displayed whenever the coffee machine is switched on, regardless of which profile was selected before the machine was last switched off.
- Select the option you want.
 - Confirm with *OK*.

Changing the name

This option can only be selected if a profile has been allocated in addition to the Miele standard profile.

- Select Change name and confirm with *OK*.
- Change the name as required (see also “Creating profiles”).

Deleting the profile

This selection is only possible if a user profile has been allocated in addition to the Miele standard user profile.

- Touch the  sensor control.
- The Profiles menu opens.
- Select Edit.
 - Confirm with *OK*.
 - Select Delete profile.
 - Confirm with *OK*.
 - Select the profile you wish to delete.
 - Select Yes.
 - Confirm with *OK*.

The profile will be deleted.

With MobileStart you can, for example, start making a drink via the Miele app.

You will only be able to use MobileStart if Miele@home has been set up for your coffee machine.

 Danger of burning and scalding at the dispensers.

If liquids or steam are dispensed while the machine is unsupervised, persons may burn themselves if they place body parts under the main dispenser or touch hot components.

Ensure that no one, especially children, can be harmed if the machine is operated without supervision.

Milk is not cooled in the milk flask. If you want to start making a drink with milk using the app, make sure that the milk is sufficiently cold (< 50°F/10°C).

If the coffee machine is being operated manually, it cannot be operated via the app. Operation on the machine takes precedence.

To start making drinks remotely, Mobile Start must be activated. Make sure that the coffee machine is ready to use (check that the water container is sufficiently filled, for example). Place a sufficiently large, empty cup under the main dispenser.

If you are making a drink with MobileStart, you will be notified of drink dispensing with acoustic and optical signals. These warning signals cannot be changed or switched off.

Switching MobileStart on and off

If you want to use MobileStart , the option must be switched on.

The drinks menu is displayed.



■ Tap the  sensor button.

The  sensor button lights up. You can now start making a drink via the app. Follow the prompts to do this.

Settings

Displaying and changing Settings

The drinks menu is displayed.

- Tap the  sensor button.
- Select **Settings**  and tap *OK*.
- Select the menu option that you want to display or change.
- Confirm with *OK*.
- Change the setting as required and confirm with *OK*.

Some settings which can be found in the **Settings** menu are described in separate sections of the operating instructions.

Language

You can select the language and, if applicable, your location for all display text.

Tip: If you select the wrong language by mistake, you can find the **Language** option again via the  symbol.

Timer: switch off after

If none of the buttons have been pressed or no drink has been prepared, the coffee machine will turn itself off after 20 minutes to save energy.

You can change this to another time (can be set between 20 minutes and 9 hours).

TeaTimer

You can use the **TeaTimer** function to start a kitchen timer when making tea. There is a preset brewing time for the type of tea selected. You can adjust the

preset brewing time (up to a maximum of 14:59 minutes). The changed brewing time is saved.

You can choose between the following options:

- **Automatically:** The **TeaTimer** starts automatically once the water has been dispensed.
- **Manual:** Once the water has been dispensed, you have the option of starting the **TeaTimer**.

While the brewing time is counting down, you can continue to use the coffee machine as normal. After the brewing time has elapsed, an audible signal will sound and the  symbol will flash.

Volume

You can set the volume of the audible signal and keypad tones (segment bar).

Display brightness

You can set the display brightness (segment bar).

Lighting

You can change the brightness of the lighting while the coffee machine is switched on or off.

You can also specify how long the lighting should stay on for when the machine is switched off (adjustable between 15 minutes and 9 hours).

Info (display information)

You can display the number of drinks dispensed so far and how many more can be dispensed until the maintenance programs have to be run.

Altitude

If the coffee machine is installed at high altitudes, the lower air pressure will cause the water to boil at a correspondingly lower temperature.

You can set the local altitude to ensure the ideal drink preparation temperatures.

Performance Mode

You can select the appropriate Performance Mode for how you use your machine. Eco Mode is set by default.

Eco Mode

Eco Mode is an energy-saving mode. The system does not heat up until someone starts making a drink.

Barista Mode

This Performance Mode has been optimized for unadulterated coffee enjoyment. Users can enjoy coffee-based drinks without any delay as the coffee machine remains heated to the brewing temperature. This mode consumes more energy than Eco Mode.

Latte Mode

This Performance Mode has been optimized for preparing milk. Milk-based drinks can be prepared within a much shorter space of time. This mode consumes more energy than Eco Mode and Barista Mode.

Party Mode

This Performance Mode has been configured for the **occasional** intensive use of the coffee machine, e.g., for family get-togethers.

Clean the coffee machine thoroughly after intensive use, particularly the milk pipework. It may be necessary to descale the coffee machine and degrease the brew unit.

Please note the following information about Party Mode:

- Cleaning status messages or cleaning prompts are suppressed and delayed until the machine is next switched on.
- The Turn off after timer is deactivated. The coffee machine switches off 6 hours after the last sensor button was pressed.
- The cup light remains permanently switched on at the maximum brightness level for as long as the coffee machine stays switched on.

Water hardness

Program the coffee machine to the water hardness level of your area so that it functions correctly and does not get damaged.

Your local water authority will be able to tell you the hardness of the water in your area.

If you are using bottled drinking water, e.g., mineral water, select settings according to the calcium content. The calcium content is given on the label of the bottle in mg/l Ca^{2+} or ppm (mg Ca^{2+} /l).

Do not use carbonated water.

The hardness level is set to 21.8 gpg (21°dH) by default.

Settings

Water hardness		Calcium content mg/l Ca ²⁺ or ppm (mg Ca ²⁺ /l)	Setting
°dH	gpg		
1	1	7	1
2	2	14	2
3	3	21	3
4	4	29	4
5	5	36	5
6	6	43	6
7	7	50	7
8	8	57	8
9	9	64	9
10	10	71	10
11	11	79	11
12	12	86	12
13	14	93	13
14	15	100	14
15	16	107	15
16	17	114	16
17	18	121	17
18	19	129	18
19	20	136	19
20	21	143	20
21	22	150	21
22	23	157	22
23	24	164	23
24	25	171	24
25	26	179	25
26	27	186	26
27	28	193	27
28	29	200	28
29	30	207	29

Water hardness		Calcium content mg/l Ca ²⁺ or ppm (mg Ca ²⁺ /l)	Setting
°dH	gpg		
30	31	214	30
31	32	221	31
32	33	229	32
33	34	236	33
34	35	243	34
35	36	250	35
36	37	257	36
37–45	38–47	258–321	37–45
46–60	48–62	322–429	46–60
61–70	63–73	430–500	61–70

Tip: If your water hardness is > 21.8 gpg (21°dH), we recommend using bottled drinking water instead (< 150 mg/l Ca²⁺). This will mean your coffee machine will need to be descaled less often and there will be less impact on the environment because less descaling agent will be used.

System lock

You can lock the coffee machine to prevent it from being used by unauthorized persons, such as children.

Temporarily deactivating the system lock

- Press and hold *OK* for 6 seconds.

The system lock is reactivated when the coffee machine is next switched off.

Miele@home

The following points may appear under Miele@home:

- **Set up**: This option only appears if the coffee machine has never been connected to a Wi-Fi network or if the network configuration has been reset.
- **Deactivate*/Activate***: The settings for the Wi-Fi network are retained, but the network is switched on or off.
- **Connection status***: Information about the Wi-Fi connection is displayed. The symbols indicate the strength of the connection.
- **Set up again***: The settings for the current Wi-Fi network will be reset. The Wi-Fi connection will be set up again.
- **Reset***: The Wi-Fi is switched off and the settings for the current Wi-Fi network will be reset.

The network configuration should be reset whenever the coffee machine is being disposed of or sold, or if a used coffee machine is being put into operation. This is the only way to ensure that all personal data has been removed and the previous owner will no longer be able to access the coffee machine.

* This menu option appears if Miele@home has been set up and the coffee machine has – where applicable – been connected to a Wi-Fi network.

Remote control

The remote-control option appears when the coffee machine is connected to a Wi-Fi network.

You can change the coffee-machine settings, for example, in the Miele app when remote control is switched on. To start making a drink via the app, MobileStart also needs to be activated.

The remote-control function is switched on by default.

RemoteUpdate

The RemoteUpdate menu option is only displayed and can only be selected if the requirements for using Miele@home have been met.

The RemoteUpdate function allows the software on your coffee machine to be updated. If an update is available for your coffee machine, it will automatically download it. Updates will not be installed automatically. They must be initiated manually.

If you do not install an update, you can continue to use your coffee machine in the usual way. However, Miele recommends installing updates.

Activating/deactivating

The RemoteUpdate function is activated by default. Available updates will be downloaded automatically but will only be installed if you initiate installation manually.

Deactivate RemoteUpdate if you do not want any updates to be downloaded automatically.

Settings

Running a RemoteUpdate

Information about the content and scope of an update is provided in the Miele app.

A message will appear in your coffee machine display if a software update is available.

You can install the update immediately or postpone this until later. When the coffee machine is switched on again, you will be reminded about the update.

Deactivate RemoteUpdate if you do not want to install the update.

The update may take several minutes.

Please note the following information about the RemoteUpdate function:

- You will only receive a message when an update is available.
- Once an update has been installed, it cannot be undone.
- Do not switch the coffee machine off during the update. Otherwise, the update will be aborted and will not be installed.
- Some software updates can only be carried out by Miele Customer Service.

Software version

The “Software version” menu option is intended for Miele Technical Service. You do not need this information for domestic use.

Showroom program (Demo mode)

Do not activate this setting for domestic use.

The Demo Mode | Demo Mode function enables the coffee machine to be demonstrated in shops or showrooms. In this mode, the machine lights up but no drinks can be prepared and no maintenance programs can be run.

You can activate demo mode without commissioning the appliance for the first time. Switch the coffee machine on and off again. Press the ↵ / *Back* button for 5 seconds straight away. Demo mode is activated.

Factory default settings

You can reset the coffee machine to its factory default settings.

The following will **not** be reset:

- The number of drinks dispensed and the appliance status (No. of portions until appliance needs descaling, ... brew unit needs degreasing)
- Language
- Profiles and the associated drinks
- Miele@home



Risk to health due to inadequate cleaning.

Heat and moisture inside the coffee machine can cause coffee residues to become moldy and/or milk residues to go off and pose a risk to health.

Carefully clean the coffee machine regularly.

Overview of cleaning intervals

Recommended frequency	What do I have to clean/maintain?
Daily (at the end of the day)	Water container
	Grounds container
	Drip tray and drip-tray cover
	Milk flask
	Milk siphon
Once a week (more often if heavily soiled)	Main dispenser
	Milk pipework rinse valve and connecting pieces (with cleaning brush)
	Brew unit
	Interior area underneath the brew unit
	Housing (particularly important immediately after descaling the appliance)
Once a month	Bean container and ground coffee chute
	Water container filter
	Steam jet (with cleaning brush)
When prompted	Degrease the brew unit (1 cleaning tablet)
	Descale the appliance (1 descaling tablet)

Cleaning and care

Clean by hand or in dishwasher

The brew unit is **not** dishwasher safe. Only clean the brew unit by hand with warm water. **Do not use any cleaning agents.**

The following components must be cleaned **by hand only**:

- Central spout stainless steel cover
- Brew unit
- Water reservoir lid
- Bean container lid
- Lower panel

 Risk of damage as a result of excessively high dishwasher temperatures.

Components may be ruined (e.g., may become warped) if washed in a dishwasher at temperatures higher than 130°F (55°C).

For dishwasher-safe components, always select dishwasher programs with a maximum temperature of 130°F (55°C).

Contact with natural dyes, such as those found in carrots, tomatoes, and ketchup, may discolor the plastic parts in the dishwasher. This discoloration does not affect the stability of the parts.

The following parts are **dishwasher-safe**:

- Drip tray and lid
- Drip tray cover
- Waste unit
- Water container

- Central spout (without stainless steel cover)
- Milk pipework with rinse valve
- Milk siphon
- Milk flask with lid (included depending on model)

 Danger of burning and scalding on hot components or by hot liquids. Components can become very hot during operation. Touching hot components can cause burning. The liquids and steam dispensed are very hot and can cause scalding. Keep away from the area underneath the dispensers when hot liquids and steam are being dispensed. Always allow the coffee machine to cool down before cleaning it. Please be aware that water in the drip tray can also be very hot.

 Risk of damage due to moisture ingress.

The steam from a steam cleaning appliance could reach electrical components and cause a short circuit.

Do not use a steam cleaner to clean the coffee machine.

It is important to clean the appliance regularly. Milk residues can go off and can block the milk pipe.

Unsuitable cleaning agents

Contact with unsuitable cleaning agents can alter or discolor the external surfaces. All surfaces are susceptible to scratching.

Remove any residual cleaning agent immediately. Make sure you remove any spillages or splashes of descaling agent immediately.

To avoid damaging the surfaces of your appliance, do not use:

- cleaning agents containing soda, ammonia, acids, or chlorides
- solvent-based cleaning agents
- cleaning agents containing descaling agents (unsuitable for cleaning the housing)
- stainless steel cleaning agents
- dishwasher cleaners (unsuitable for cleaning the housing)
- glass cleaners
- cleaning agents for ceramic glass cooktops
- oven cleaners
- abrasive cleaning agents, such as scouring powder, scouring liquid, or pumice stones
- scouring pads, such as pot scrubbers and brushes, or used sponges that still contain abrasive cleanser residue
- eraser sponges
- sharp metal scrapers
- steel wool or stainless steel wire scourers

Cleaning the drip tray and grounds container

Clean the drip tray and grounds container **every day** to avoid unpleasant smells and mildew.

The grounds container is located in the drip tray. Water from rinsing also collects in the grounds container.

A prompt will appear in the coffee machine display when the drip tray and/or the grounds container is full and needs to be emptied. Empty the drip tray **and** the grounds container.

 **Danger of burning!**
If the rinsing process has just finished, wait a while before removing the drip tray from the coffee machine. The water used for rinsing will continue to run out of the coffee spouts for a while.

Remove the drip tray and the grounds container while the coffee machine is switched on. Otherwise, the message Empty the drip tray and the waste container will appear in the display, even though the drip tray and/or the grounds container are not filled to the maximum level.

- Push the main dispenser up as far as it will go.

Cleaning and care

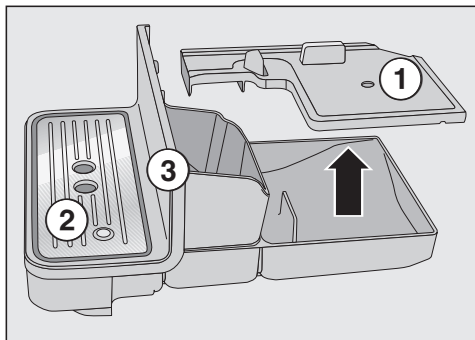

- Pull the drip tray carefully out of the coffee machine. Take the lid ① off.
- Empty the drip tray **and** grounds container.
- Remove the drip tray cover ② and the lower panel ③.
- Clean all parts thoroughly.

Clean the lower panel by hand only using warm water and liquid dish soap.

All other parts are dishwasher-safe.

- Clean the inside of the appliance underneath the drip tray.
- Reassemble all parts and place the drip tray back in the coffee machine.

Make sure the drip tray has been pushed into the appliance as far as it will go.

Cleaning the drip tray cover

- Remove the drip tray cover.
- Clean the drip tray cover by hand using a mild solution of warm water and liquid dish soap.
- Dry the drip tray cover.

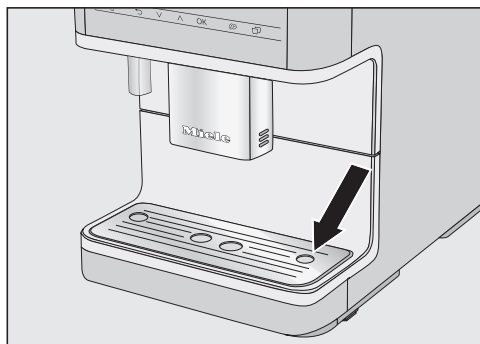

- Reinstall the drip tray cover. Make sure that the drip tray cover is correctly installed (see illustration).

Tip: To give the drip tray cover an extra thorough clean, clean it in the dishwasher from time to time.

Cleaning the water container

Clean the water container lid **by hand only** using warm water and liquid dish soap.

Clean the water container every day. You can clean the water container in the dishwasher once a week.

- Press on the mark on the water container lid.
- Pull the water container up by its lid to remove it.

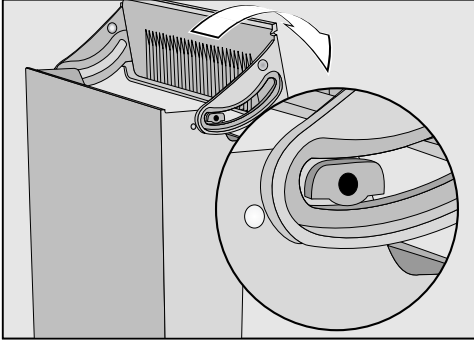

- Take the lid off the water container and wash it by hand.
- The water container can be cleaned in the dishwasher, or by hand using warm water and liquid dish soap. Dry the water container after cleaning.
- Carefully clean the surface the water container sits on, particularly the slots.
- Install the lid back on the water container.

Make sure that the valve, the underside of the water container, and the surface the water container sits on are clean. Otherwise, the water container will not sit correctly.

Cleaning the water container filter

Clean the water container filter once a month.

The water container filter is located under the water container.

- Remove the water container.

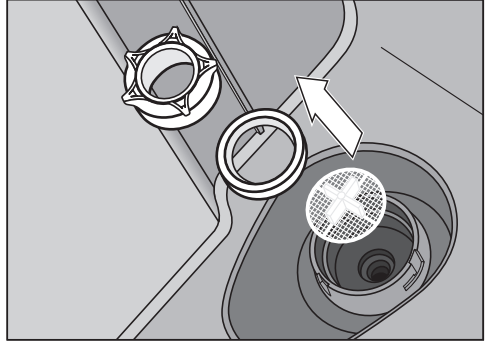

- Unscrew the cap. Remove the seal and the filter.
- Rinse all parts carefully under running water.
- Then replace the water container filter (with the cross facing upward) and then the seal. Finally screw the cap back on tightly.
- Replace the water container.

Cleaning the main dispenser

Clean the main dispenser's stainless steel cover **by hand only**, using warm water and a little liquid dish soap.

All other parts are dishwasher-safe.

- Use the supplied cleaning brush for parts that are difficult to reach, e.g., in the dispensing unit.
- Stubborn soiling is easier to clean if you soak the individual components overnight in water and liquid dish soap. Rinse the components under running water afterward.
- Push the main dispenser down completely and remove the stainless steel cover by pulling it off toward you.

Cleaning and care

- Remove the dispensing unit toward the front.
- Pull off the upper silicone section with the aperture for the milk pipework ①.
- The gray silicone section contains a black, cylindrical component ②. Pull out the black component.
- Remove the dispensing spouts ③.
- Clean all parts thoroughly.
- Clean the surfaces of the main dispenser with a damp cloth.

To effectively remove coffee deposits, clean the coffee pipework with the cleaning brush once a month.

- Angle the cleaning brush slightly and clean both spouts from above and below.

Reassembling the main dispenser

The dispensing unit is easier to reassemble if the individual parts are dampened with water.

- Reassemble the dispensing unit. Push the spouts ③ firmly all the way round so that the dispensing unit is firmly seated in the groove.
- Reinstall the dispensing unit onto the main dispenser.
- Replace the stainless steel cover and connect the milk pipework if required.

Cleaning the steam jet

Clean the steam jet once a month.

- Push the main dispenser down completely and remove the stainless steel cover by pulling it off toward you.

- Remove the dispensing unit toward the front.

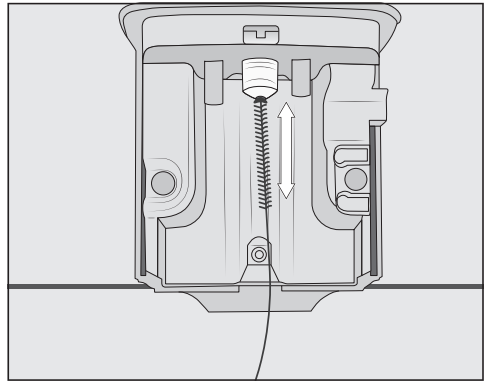

Push the cleaning brush a maximum of 1/2" (1 cm) into the steam jet.

- Clean the steam jet with the cleaning brush.
- Push the dispensing unit back into the main dispenser and replace the stainless steel cover.

Cleaning the milk pipework and rinse valve

Risk of damage due to incorrect cleaning.

The silicone plug can be damaged by pointed objects, e.g., also the cleaning brush, and stop working.

Do **not use** pointed objects, e.g., a needle, for cleaning.

Only clean the silicone plug under running water and/or in the dishwasher. **Do not use** the cleaning brush supplied with the appliance.

Clean the rinse valve and milk pipework once a week.

Cleaning and care

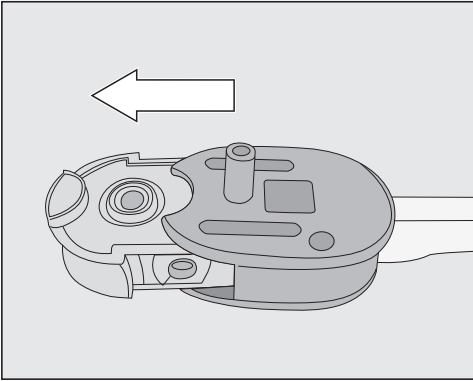

- Pull the silicone plug out of the rinse valve body.
- Rinse the silicone plug under running water before placing the component in the dishwasher.

Risk of damage to the silicone plug
Be sure to remove the silicone plug before cleaning the rinse valve body with a cleaning brush or similar utensil.

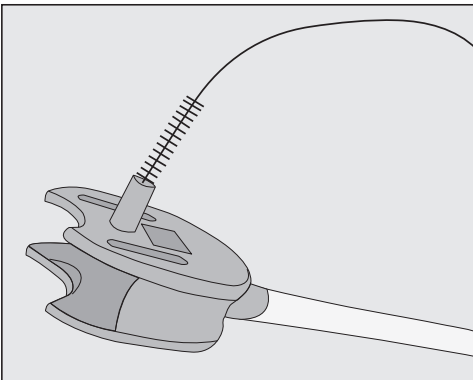

- Use the brush to clean the rinse valve body under running water to remove any milk residues.

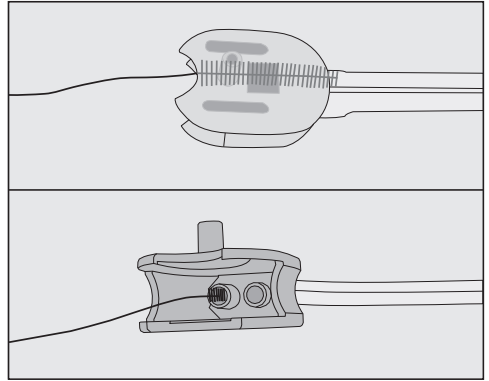

- Clean also the hose connections in the rinse valve body. To do this, insert the cleaning brush into both openings and move the brush back and forth.

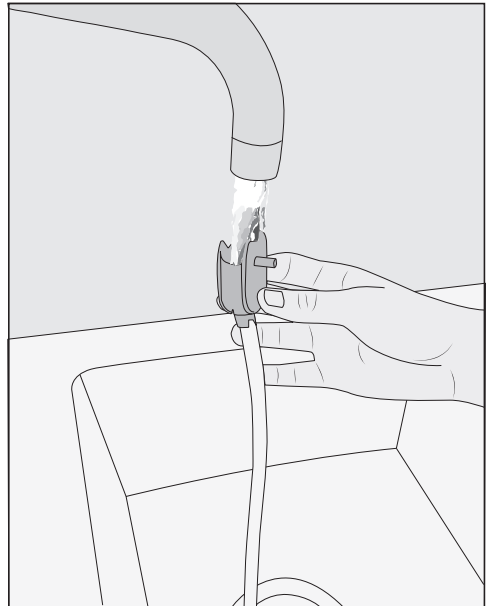

- Rinse the milk pipework and the rinse valve body under running water.
- Clean all components in a dishwasher.

Cleaning and care

Tip: Alternatively, you can soak the individual components overnight in water and liquid dish soap. Rinse the components under running water afterwards.

- Reassemble the rinse valve.

Cleaning the milk siphon

Clean the milk siphon every day.

- Rinse the milk siphon under running water.
- Remove the connecting piece from the stainless steel tube.
- Clean the parts by hand under running water with a little liquid dish soap.
- If necessary, soak the parts overnight in water and a little liquid dish soap.
- Rinse the parts under running water afterward.
- Dry the parts.

Tip: To give the individual parts an extra thorough clean, clean them in the dishwasher from time to time.

Cleaning the milk flask

Clean the milk flask every day.

- Unscrew the lid from the milk flask glass.
- Remove the stainless steel tube.

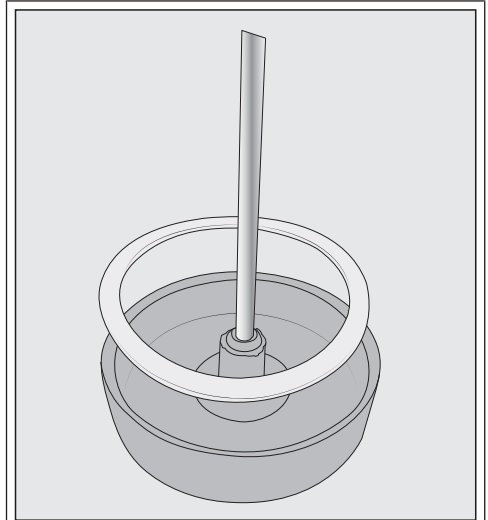

If necessary, you can remove the connecting piece and seal from the milk flask lid. Once you have removed the stainless steel tube, the connecting piece is easy to push out from the inside of the lid.

- Clean all parts of the milk flask by hand using hot water and a little liquid dish soap.
- Dry all parts.

Tip: To give the individual parts of the milk flask an extra thorough clean, clean them in the dishwasher from time to time.

Cleaning the bean container and ground coffee chute

⚠ Danger of injury from the grinder!
Switch off and unplug the machine to disconnect the machine from the power supply before cleaning the bean container.

Coffee beans contain oils which can deposit on the walls of the bean container and hinder the flow of the beans. Therefore, clean the bean container regularly with a soft, dry cloth.

- Open the bean container.
- Remove any coffee beans.
- Clean the bean container with a dry, soft cloth.

The coffee bean container can now be refilled.

If necessary, clean the ground coffee chute:

- Open the ground coffee chute and remove any ground coffee residue.

Tip: Use a vacuum cleaner to remove any coffee residues from the bean container and the ground coffee chute.

Cleaning the casing

If soiling is allowed to stay for a long time or there is contact with unsuitable cleaning agents, surfaces can alter or discolor.

Remove any soiling immediately.

Ensure that any splashes of descaling solution are wiped up immediately.

- Switch the coffee machine off.
- Clean the appliance front with a clean soft sponge and a solution of warm water and liquid dish soap.
- Dry all surfaces with a soft cloth.

Tip: You can also clean the casing with the Miele All-Purpose Microfiber Cloth.

Accessing the Maintenance menu

You can find the maintenance programs in the Maintenance menu. Carry out the relevant maintenance program when the prompt to do so appears in the display.

Tip: To save you having to empty the drip tray too often and to catch any splashes, you can place the a container under the main dispenser.

- Tap .
- Select Maintenance and confirm with *OK*.

You can now select a maintenance program.

Rinse appliance

If you have made a coffee, the coffee machine will rinse the coffee pipework automatically before switching off.

You can also start the Rinse appliance function manually.

Rinsing the milk pipework

If you have not made any milk drinks for a while, rinse the milk pipework thoroughly before making the first drink.

- Tap .
- Select Maintenance | Rinse milk pipework and confirm with *OK*.

Place valve in drip tray will appear on the display.

Cleaning and care

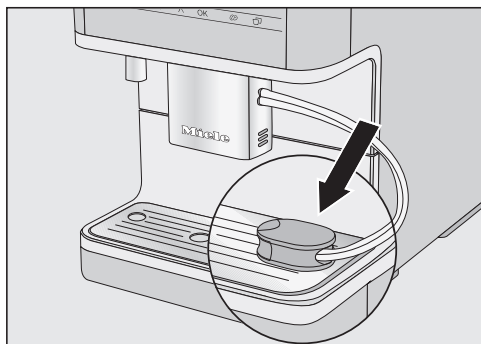

- Insert the rinse valve into the right aperture in the drip tray cover and confirm with *OK*.

The milk pipework will now be rinsed.

Cleaning the milk pipework (maintenance program)

The Clean milk pipework maintenance program lasts for approx. 15 minutes.

You need 1 stick of cleaning agent for milk pipework for the maintenance program.

- Tap .
- Select Maintenance | Clean milk pipework.
- Confirm with *OK*.

The process will start.

- Follow the instructions in the display.

Remove the water container. Fill it with cleaning solution (see Operating Instructions) and replace it. **will** appear in the display.

Preparing the cleaning solution

For optimum cleaning results, we recommend using the Miele Cleaning Agent for milk pipework.

The cleaning agent has been specially developed for use with Miele Coffee Machines and prevents damage to the appliance from unsuitable cleaning agents.

It is available to order from the Miele online shop, from Miele Customer Service, or from your Miele dealer.

- Place 1 stick of milk pipework cleaning agent in a container and add **10 fl oz** (300 ml) of lukewarm water. Stir the solution with a spoon until the cleaning agent powder has fully dissolved.
- Remove and empty the water container.
- Pour the prepared cleaning solution into the water container. Replace the water container.
- Follow the additional instructions given in the display.
- If prompted to do so in the display, rinse the water container thoroughly with clean water. Make sure that **no** cleaning agent is left in the water container. Fill the water container with water.

The cleaning process is complete when the drinks menu appears.

Degreasing the brew unit and cleaning the interior

Depending on the natural oil content of the coffee used, the brew unit can become blocked quite quickly. The brew unit must be degreased regularly in order to ensure aromatic coffee and trouble-free operation of the coffee machine.

It is recommended to use Miele Cleaning Tablets to clean the brew unit. These have been specially developed for degreasing the brew unit in Miele Coffee Machines and prevent subsequent damage.

The cleaning tablets are available to order from the Miele online shop, from Miele Customer Service, or from your Miele dealer.

After 200 portions have been dispensed, a message prompting you to degrease the brew unit will appear in the display.

- Confirm the message with *OK*.

This message will keep being displayed until the brew unit has been degreased.

Degreasing the brew unit

- Tap the  sensor control.
- Select Maintenance | Degrease the brew unit.
- Confirm with *OK*.

The maintenance program will then start.

- Follow the instructions in the display.

Cleaning the brew unit and interior

Clean the brew unit **by hand only** with warm water. **Do not use liquid dish soap or any cleaning agents.**

The moving parts of the brew unit are lubricated. Cleaning agents will damage the brew unit.

To ensure good tasting coffee and to prevent a build-up of bacteria in the machine, remove and clean the brew unit under running water once a week.

Remove the brew unit. Clean the interior of the machine. Rinse the brew unit by hand and refit it with a cleaning tablet in it. **will** appear on the display.

- Open the appliance door.

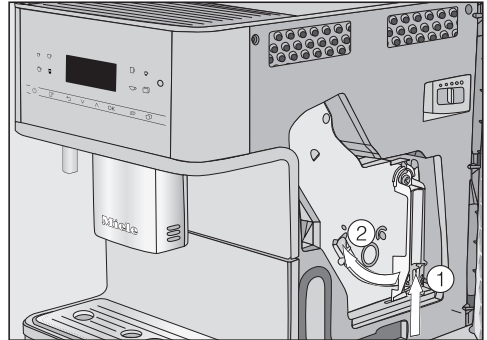

- Press and hold the button under the brew unit handle ① and, while doing so, turn the handle to the left ②.
- Carefully pull the brew unit out of the coffee machine.

Once you have removed the brew unit, do **not** change the position of the handle on the brew unit.

- Clean the brew unit **by hand under warm running water** without using cleaning agent or liquid dish soap.

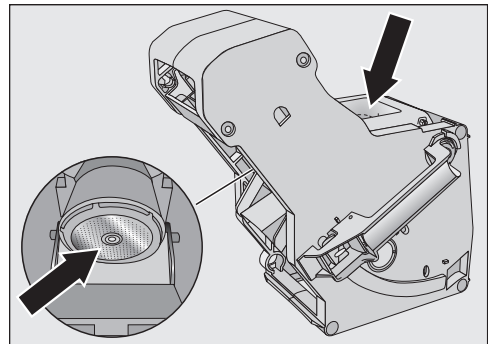

- Clean any coffee remnants off the brew unit filter.

Cleaning and care

- Dry the funnel to prevent ground coffee from sticking to it the next time a coffee is made.

Make sure to remove moist ground coffee remnants regularly to prevent bacteria from forming.

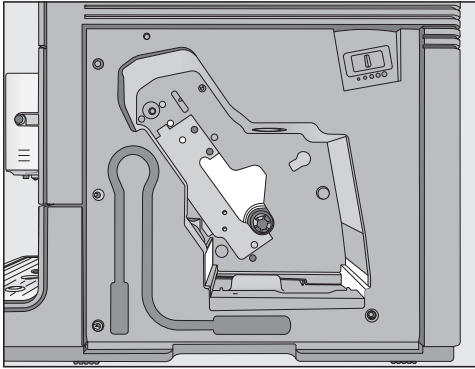

- Clean the interior of the coffee machine. Make sure that the areas highlighted in the illustration are cleaned especially well.

Tip: Use your vacuum cleaner to remove dry coffee grounds.

Dropping a cleaning tablet into the brew unit

Insert the brew unit containing tablet. Close the door. will appear on the display.

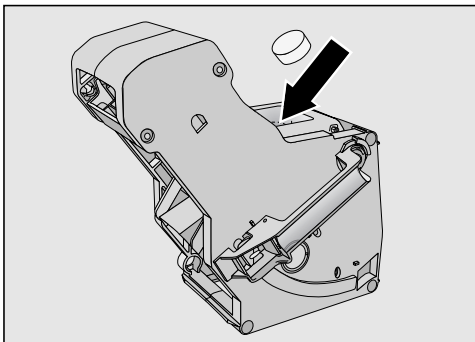

- Drop a cleaning tablet into the top of the brew unit (arrow).

- Push the brew unit containing the cleaning tablet back into the coffee machine.

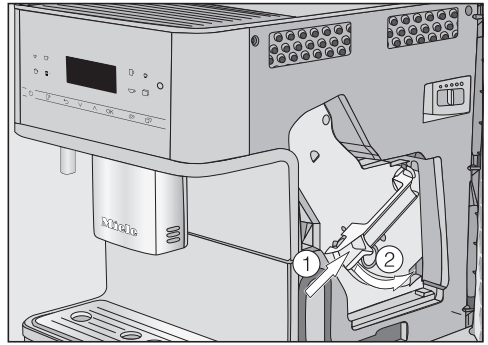

- Press the button on the end of the handle of the brew unit ① and while doing so turn the handle clockwise ②.
- Close the service panel.
- Follow the additional instructions given in the display.

The cleaning process is complete when the drinks menu appears.

Descaling the appliance

Risk of damage from splashes from the descaling solution.

Sensitive surfaces and/or natural floors can suffer damage.

Wipe up any spillages immediately when descaling.

Limescale builds up in the coffee machine through use. How often the machine needs to be descaled will depend on the water hardness level in your area. Limescale must be removed regularly.

The machine will guide you through the descaling process. Various messages will appear in the display, e.g., you will be prompted to empty the drip tray or fill the water container.

Descaling **must be carried out**. The process takes approx. 15 minutes.

The coffee machine prompts you in the display when it needs to be descaled. The remaining number of drinks that can be made before descaling will show in the display after each drink.

■ Confirm the message with *OK*.

When the number of remaining portions reaches 0, the coffee machine will lock.

You can switch the coffee machine off if you do not want to carry out the descaling program at this point. You cannot make any drinks until the machine has been descaled.

Descal the appliance will appear in the display.

■ Confirm with *OK*.

The process will start.

■ Follow the instructions in the display.

If the operating temperature is too high for the descaling process, the coffee machine cools down. No separate message is shown on the display during the cooling phase.

When Fill the water container with descaling agent and lukewarm water up to the S symbol and replace. appears in the display, proceed as follows.

Preparing the descaling solution

For optimum descaling results, it is recommended to use the Miele Descaling Tablets.

The descaling tablets have been specially developed for Miele Coffee Machines.

Other descaling agents, which contain other acids besides citric acid and/or other undesirable substances, such as chlorides, may cause damage to the product. Moreover, the descaling result required cannot be guaranteed if the descaling solution was not of the appropriate concentration.

The descaling tablets are available to order from the Miele online shop, from Miele Customer Service, or from your Miele dealer.

You will need **1** descaling tablet to descale the machine.

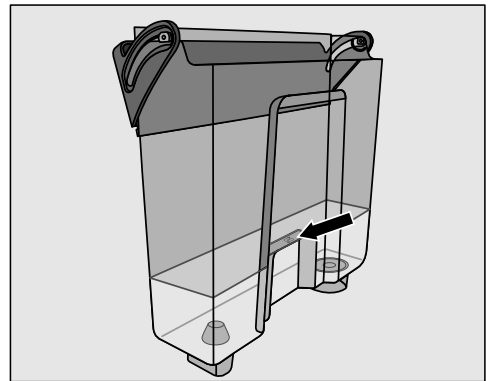

■ Fill the water container to the S mark with lukewarm water.

■ Add **1** descaling tablet to the water container.

Follow the instructions for the mixing ratio carefully. Do not fill the water container with too much or too little water. Otherwise the descaling process will be canceled prematurely.

Cleaning and care

Carrying out descaling

- Reinsert the water container.
- Follow the additional instructions given in the display.

When Fill the water container up to the  symbol and insert. Close the door. **appears** in the display:

- Remove the water container and rinse it thoroughly with clean water. Ensure that **no** descaling solution residue remains in the water container. Fill the water container at least up to the  mark with fresh tap water.

The descaling process is complete when the drinks menu appears.

Frequently asked questions

Many malfunctions and faults that can occur in daily operation can be easily remedied. You can save time and money in many cases, as you do not need to contact Miele Customer Service.

Information to help you rectify faults yourself can be found at www.miele.com/service.



The following tables are designed to help you to find the cause of a malfunction or a fault and to resolve it.

Messages in the display



Error messages must be confirmed with *OK*, otherwise the message may reappear in the display even though the problem has been remedied.

To address the fault, follow the instructions on the display.

If the error message appears in the display again, contact Miele Technical Service.

Problem	Possible cause and solution
F1, F2, F80, F82	There is an internal fault. ■ Switch the coffee machine off with the On/Off button  . Wait for approximately one hour before switching the machine back on again.
F41, F42, F74, F77, F235, F236	There is an internal fault. ■ Switch the coffee machine off with the On/Off button  . Wait for approximately 2 minutes before switching the machine back on again.
F10, F17	No water or very little water is being drawn in. ■ Remove the water container. Fill the water container with fresh tap water and reinsert the water container. ■ Remove and clean the water container filter (see “Cleaning and care – Removing and cleaning the water container filter”).

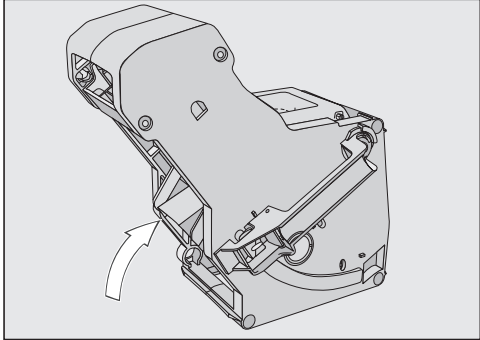
Frequently asked questions



Problem	Possible cause and solution
<p>F73 or Check the brew unit</p>	<p>The brew unit cannot be positioned correctly.</p> <ul style="list-style-type: none">■ Switch the coffee machine off with the On/Off button .■ Unplug the coffee machine. Wait for two minutes before inserting the electrical plug back in the socket.■ Remove the brew unit and rinse under running water.  <ul style="list-style-type: none">■ Push the coffee ejector of the brew unit into the correct position.■ Do not insert the brew unit. Close the service panel and switch the coffee machine on with the On/Off button . <p>This will initialize the brew unit motor and put it back into the start position.</p> <ul style="list-style-type: none">■ When Insert the brew unit appears in the display, ut the brew unit back in the appliance. Close the service panel.

Frequently asked questions



Problem	Possible cause and solution
Too much ground coffee	<p>There is too much ground coffee in the ground coffee chute.</p> <p>The brew unit cannot compact ground coffee if more than 12 g (2 level spoonfuls) of ground coffee are added to the coffee chute. The ground coffee will be emptied into the grounds container and the fault message will appear in the display.</p> <ul style="list-style-type: none"> ■ Switch the coffee machine off with the On/Off button . ■ Remove and clean the brew unit (see “Removing the brew unit and cleaning it by hand”). ■ Remove the ground coffee inside the coffee machine, e.g., with a vacuum cleaner. ■ Place a maximum of 12 g of coffee in the ground coffee chute.
	<p>There is too much ground coffee in the ground coffee chute.</p> <p>Certain types of coffee produce a lot of coffee when they are ground. Usually the grinder is set too coarse and the amount is set to maximum.</p> <ul style="list-style-type: none"> ■ Set the grinder to a finer setting. ■ Select a smaller amount of coffee. <p>If the coffee is still not to your taste, e.g., too weak, try another type of bean.</p>

Frequently asked questions

Unusual performance of the coffee system

Problem	Possible cause and solution
The display remains dark when the coffee machine is turned on using the On/Off button .	The On/Off button  was not held for long enough. ■ Tap and hold the On/Off button  for at least 3 seconds.
	The electrical plug is not properly plugged into the socket. ■ Insert the electrical plug into the socket.
	The breaker has tripped because the coffee machine, voltage, or another appliance is defective. ■ Unplug the coffee machine. ■ Contact a qualified electrician or Miele Service.
The lighting remains off after the coffee machine has been switched on.	The lighting has been switched off. ■ Switch the lighting on (see “Lighting” in the “Settings” chapter).
	The lighting is faulty. ■ Contact Technical Service.
The coffee machine turns off suddenly.	The factory-set switch-off time (20 minutes) or the switch-off time you have programmed has been reached. ■ If required, you can select a new switch-off time (see “Settings – Timer”).
	The plug is not properly plugged into the electrical socket. ■ Insert the plug into the electrical socket.
The sensor buttons do not respond. The machine can no longer be operated.	There is an internal fault. ■ Disconnect power by unplugging the power cord from the electrical outlet and or switching off the circuit breaker.
The display is hard to see or not legible.	The display brightness has been set too low. ■ Change this setting (see “Settings”).

Frequently asked questions

Problem	Possible cause and solution
<p>Fill and replace the water container appears in the display even though the water container is full and in the machine.</p>	<p>The water container is not in the correct position.</p> <ul style="list-style-type: none"> ■ Remove the water container and push it back in again. ■ Remove and clean the water container filter (see “Cleaning and care – Removing and cleaning the water container filter”). <p>The water container was not correctly filled up and inserted during descaling.</p> <ul style="list-style-type: none"> ■ Fill the water container to the descaling symbol  and restart the descaling program.
<p>Fill and replace the water container appears after switching on even though the container is filled and installed in the machine. The appliance does not rinse.</p>	<p>The coffee machine needs descaling.</p> <ul style="list-style-type: none"> ■ Switch the coffee machine off with the On/Off button . Wait approx. one hour. ■ Switch the appliance back on again. As soon as Heating-up appears, tap the  sensor button and then select Descale. ■ Descale the coffee machine.
<p>After switching on the machine, the message Empty the drip tray and the waste container appears even though they are both empty.</p>	<p>This is not a fault. When the drip tray and grounds container are emptied, the internal counter is not reset after the coffee machine has been switched off. Empty the drip tray and the waste container appears in the display even though the drip tray and the grounds container are not filled to the maximum.</p>

Frequently asked questions

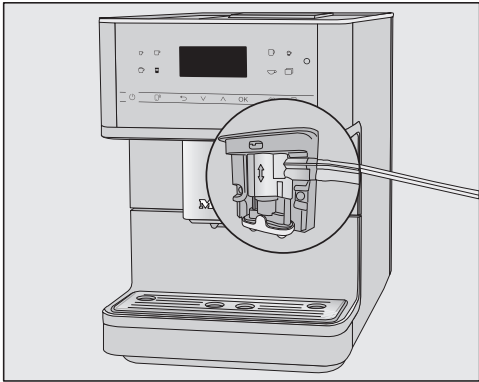
Problem	Possible cause and solution
<p>Neither milk nor milk froth comes out of the main dispenser.</p>	<p>The milk pipework was connected incorrectly to the main dispenser.</p>  <p>The seam on the milk pipework, main dispenser, and on the rinse valve makes it easier to assemble.</p> <ul style="list-style-type: none"> ■ Check whether the milk pipework is correctly connected to the main dispenser. <p>The milk pipework is blocked.</p> <ul style="list-style-type: none"> ■ Clean the main dispenser and milk pipework carefully with the brush.
<p>Empty the drip tray and the waste container appears in the display, even though the drip tray has been emptied.</p>	<p>This is not a fault. The drip tray was not properly removed and/or replaced too quickly.</p>
<p>Insert the drip tray and the waste container appears in the display even though both are installed.</p>	<p>The drip tray is not correctly installed and is therefore not detected.</p> <ul style="list-style-type: none"> ■ Empty the drip tray and grounds container. Reassemble all parts and push the drip tray back as far as it will go in the coffee machine.

Frequently asked questions

Problem	Possible cause and solution
<p>The grounds container is overflowing even though the drip tray and grounds container have been emptied following each reminder.</p>	<p>The drip tray has probably been removed without the grounds container being emptied. Removing the drip tray resets the internal counter for emptying the grounds container.</p> <ul style="list-style-type: none"> ■ Always empty the grounds container if you remove the drip tray. <p>Certain types of beans produce a lot of coffee when they are ground, meaning that larger coffee pucks are pressed.</p> <ul style="list-style-type: none"> ■ Adjust the quantity of coffee and grinder setting if necessary. ■ Empty the grounds container more often than indicated in the display.
<p>Fill the bean container appears in the display even though the bean container has just been filled.</p>	<p>This is not a fault.</p> <ul style="list-style-type: none"> ■ Confirm the message with <i>OK</i>. <p>Insufficient coffee beans are getting into the grinder. Have you used a dark roast? This type of coffee bean is often oily. These oils can cling to the inside of the coffee bean container and hinder the flow of beans.</p> <ul style="list-style-type: none"> ■ Make a coffee and observe whether the coffee beans drop into the coffee bean container. ■ Clean the coffee bean container more often if you are using a darker, more oily bean. <p>Try other types of coffee bean which are less oily.</p>
<p>The coffee machine does not rinse itself when turned on.</p>	<p>This is not a fault. If the coffee machine is already at operating temperature, rinsing will not take place when the appliance is switched on.</p>

Frequently asked questions

Problem	Possible cause and solution
<p>Coffee dispensing is repeatedly interrupted and the message <i>Fill the bean container</i> appears in the display.</p>	<p>This is not a fault. The brew unit has not detected the ground coffee. Certain types of coffee produce a small amount of coffee when they are ground. Usually the grinder is set too fine and the amount is set to minimum.</p> <ul style="list-style-type: none"> ■ Confirm the message with <i>OK</i>. <p>If the coffee is too strong for you or tastes bitter, try a different type of coffee bean.</p> <p>If the display appears with all types of coffee:</p> <ul style="list-style-type: none"> ■ Set the grinder to a coarser setting (see “Grinder setting”). ■ Select a larger amount of coffee. <p>Don't forget to check any drinks changed in “User profiles”.</p> <hr/> <p>If the message only appears when dispensing certain drinks:</p> <ul style="list-style-type: none"> ■ Check the amount of coffee set for this drink (see “Amount of coffee”). Select a larger amount of coffee. ■ You may also need to set a coarser grinder setting.
<p>The descaling process was started inadvertently.</p>	<p>The descaling program cannot be stopped once <i>OK</i> has been tapped. It must now be completed through to the end. This is a security setting to fully descale the coffee machine. It ensure a long service life and that your coffee machine is functioning correctly.</p> <ul style="list-style-type: none"> ■ Descal the coffee machine (see “Descaling the machine”).

Frequently asked questions

Problem	Possible cause and solution
Coffee is not flowing out of the main dispenser. Or coffee is only being dispensed via one spout.	<p>The main dispenser has a blockage.</p> <ul style="list-style-type: none">■ Rinse the coffee pipework (see “Cleaning and care – Rinsing the appliance”). <p>Is there still no coffee flowing out of the main dispenser or is it only dispensed via one side?</p> <ul style="list-style-type: none">■ Dismantle the main dispenser and clean all parts carefully. Use the supplied cleaning brush for parts that are difficult to reach.■ Make sure all parts are reassembled correctly.
	<p>The brew unit is blocked.</p> <ul style="list-style-type: none">■ Degrease the brew unit (see “Cleaning and care – Degreasing the brew unit and cleaning the interior”).

Frequently asked questions

Problem	Possible cause and solution
<p>The milk sputters when it is dispensed. Hissing noises can be heard when milk is being heated up or frothed. Although the milk should be frothed, only hot milk comes out of the main dispenser.</p>	<p>The milk pipework was not correctly inserted.</p> <ul style="list-style-type: none"> ■ Pay attention to the seam on the double hose when you connect the milk pipework into the main dispenser. ■ If you have disconnected the milk pipework from the rinse valve: the double hose has different diameters. Make sure all parts are assembled correctly.
	<p>The milk temperature is too high. Good milk froth can only be achieved when cold milk (below 50°F/10°C) is used.</p> <ul style="list-style-type: none"> ■ Check the temperature of the milk.
	<p>The main dispenser is not correctly mounted and is taking in air. Or the spouts are blocked.</p> <ul style="list-style-type: none"> ■ Check whether the main dispenser is correctly assembled. Make sure that all parts are tightly connected to one another. ■ Clean the main dispenser. Rub the spouts under running water to remove any dirt.
	<p>The milk pipework, connecting pieces, the stainless steel tube of the milk flask, or the milk siphon are blocked.</p> <ul style="list-style-type: none"> ■ Clean all parts carefully with the cleaning brush.
	<p>The steam jet on the main dispenser has a blockage.</p> <div data-bbox="400 1007 731 1270" data-label="Image"> </div> <ul style="list-style-type: none"> ■ Clean the steam jet with the cleaning brush (see illustration).

Frequently asked questions

Problem	Possible cause and solution
Coffee grounds have settled on the lid of the drip tray and in the interior around the brew unit.	This is not a fault. The movement of the brew unit during the brewing process can cause some ground coffee to fall around it. The type of beans used, the fineness of the ground coffee, and the amount of coffee ground also affect the amount. Important! Clean the interior of the coffee machine regularly to prevent bacteria, etc. Check whether the amount of coffee is set too high.
The display lights up but the coffee machine does not heat up and no drinks are made. The coffee machine cannot be turned off.	The Demo mode for demonstrating the coffee machine in stores and showrooms has been activated. ■ Deactivate Demo mode.

Frequently asked questions

Unsatisfactory results

Problem	Possible cause and solution
<p>The coffee is not hot enough.</p>	<p>The cup has not been pre-heated. The smaller the cup and the thicker its sides, the more important it is to pre-heat it.</p> <ul style="list-style-type: none"> ■ Pre-heat the cup, e.g. using the cup heater (depending on model).
	<p>The brewing temperature is set too low.</p> <ul style="list-style-type: none"> ■ Set a higher brewing temperature.
	<p>The filters in the brew unit are blocked.</p> <ul style="list-style-type: none"> ■ Remove the brew unit and clean it by hand. ■ Degrease the brew unit.
<p>Heating-up is taking longer. The amount of water is no longer correct and the coffee machine is not performing properly. Coffee flows into the cup very slowly.</p>	<p>The coffee machine needs to be descaled.</p> <ul style="list-style-type: none"> ■ Descale the coffee machine.
<p>The amount of coffee dispensed has changed.</p>	<p>The brew unit is blocked.</p> <ul style="list-style-type: none"> ■ Degrease the brew unit (see “Cleaning and care – Degreasing the brew unit and cleaning the interior”).
<p>The consistency of the milk froth is unsatisfactory.</p>	<p>The milk temperature is too high. Good milk froth can only be achieved when cold milk (below 50°F/10°C) is used.</p> <ul style="list-style-type: none"> ■ Check the temperature of the milk in the milk flask.
	<p>The milk pipe is blocked.</p> <ul style="list-style-type: none"> ■ Clean the central spout and milk pipework with the brush.
<p>The coffee grinder makes a louder noise than usual.</p>	<p>The coffee bean container has become empty during the grinding process.</p> <ul style="list-style-type: none"> ■ Fill the coffee bean container with fresh beans.
	<p>There may be foreign objects such as plastic or stones in amongst the coffee beans.</p> <ul style="list-style-type: none"> ■ Switch the coffee machine off immediately. Contact the Technical Service department.

Frequently asked questions

Problem	Possible cause and solution
The coffee flows too quickly into the cup.	The grind level is too coarse. ■ Set the grinder to a finer setting (see “Setting the coffee grinder”).
The coffee is dispensed too slowly into the cup.	The brew unit is blocked. ■ Degrease the brew unit (see “Cleaning and care – Degreasing the brew unit and cleaning the interior”).
The crema on the coffee or espresso is not as it should be.	The coffee beans are no longer fresh. If roasted coffee beans are stored open for too long, the carbon dioxide gradually escapes from the coffee beans. The crema is no longer formed during dispensing. Of course, you can still use the coffee beans.

Transport



If the coffee system will not be used for an extended period of time, e.g. vacation, or will be transported over a long distance, the appliance should be prepared as follows.

- Empty and clean the coffee bean container
- Empty and clean the water reservoir
- Evaporating the coffee system
- Clean the interior of the machine
- Pack the machine securely

Evaporating the coffee machine

The coffee machine should be evaporated before it is stored for a long period of time or transported any distance – particularly at temperatures below freezing.

Evaporating the machine involves removing all traces of water from the system to prevent the risk of water and frost damage.

- Tap the  sensor button.
- Select Additional | Settings  | Demo Mode | Evaporate.

The cleaning process cannot be canceled. It must be completed through to the end.

- Select Yes and confirm with *OK*.
- Follow the instructions on the display.

 **Caution!** Danger of burning and scalding at the dispensers. Hot steam is discharged.

When the display goes out, the machine has finished evaporating.

- Switch off the machine and remove the electrical plug from the outlet to disconnect the coffee machine from the power supply.
- Clean the drip tray and grounds container.

Packaging

Make sure the machine is clean and dry before packing the machine. Ground coffee residues can scratch the surfaces. In addition, coffee, milk, and water residues cause a build-up of bacteria.

Use the original packaging to pack the coffee machine.

Keep the operating instructions in the box. This means that you have them to hand if you want to reuse the coffee machine.

Contact in the event of a fault

In the event of a fault which you cannot remedy yourself, please contact your Miele dealer or Miele Customer Service.

You can book a Miele Service Call online at www.miele.com/service.

Contact information for Miele Customer Service can be found at the end of this document.

Please quote the model identifier and serial number of your appliance (SN) when contacting Miele Customer Service. Both pieces of information can be found on the data plate.

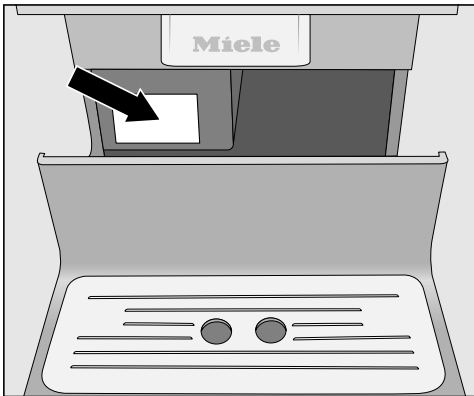

Appliance warranty and product registration

You can register your product and/or view the manufacturer's warranty terms and conditions for Miele appliances and vacuum cleaners at www.mieleusa.com.

Accessories

These products and other useful accessories can be ordered via the Miele Webstore, from Miele Service or from your Miele dealer.

Included accessories

- **Miele “Welcome Pack”**
Different cleaning products are supplied depending on model.
- **Cleaning brush**
for cleaning the milk pipework, for example.
- **Milk siphon**
For preparing milk directly from the sales packaging
- **Milk flask with lid**
For storing and preparing milk (supplied depending on model)

Optional accessories

Miele also offers a range of optional accessories, as well as cleaning and conditioning products for your coffee system.

- **Cleaning tablets**
for degreasing the brew unit
- **Descaling tablets**
for descaling the water pipework
- **Milk flask with lid**
For storing and preparing milk
- **CJ Jug 1.0 L**
Insulated flask for coffee or tea (pot function)
- **Miele Black Edition One for all**
perfect for making espresso, café crema, and speciality coffee with milk
- **Miele Black Edition Espresso**
Whole coffee beans – perfect for making espresso
- **Miele Black Edition Café Crema**
Whole coffee beans – perfect for making coffee
- **Miele Black Edition Decaf**
Whole coffee beans – perfect for making decaffeinated coffee specialties

The following tips can help you save energy and money as well as help the environment:

- Operate the coffee machine in Eco Mode.
- Switch the coffee machine off with the On/Off button  when it is not in use.
- Change the setting for the Turn off after timer to 20 minutes. Then the coffee machine will switch off 20 minutes after the last drink has been made or a sensor button has been tapped.
- If you only want to pre-heat your cups occasionally, you can switch the cup heating surface off. You can then use hot water to pre-heat the cups.

Electrical connection

Before connecting the coffee machine, make sure that the connection data on the data plate (voltage and frequency) matches the electrical supply.

This data must match to avoid the risk of damage to the coffee machine. If in any doubt, consult a qualified electrician.

The connection data is provided on the data plate. The data plate can be found on the left-hand side of the appliance when the drip tray is pulled out.

The appliance is supplied with a power cord ready for connection to an AC 220–240 V 50 Hz supply.

The coffee machine must be connected to the power supply via a correctly installed grounded plug. The machine must be connected to an electrical system designed in accordance with national regulations.

The fuse rating must be at least 10 A.

The socket should be next to the appliance and easily accessible where possible.

Do not connect the coffee machine to the power supply using a power bar or an extension cord. These do not guarantee the required safety of the appliance (risk of fire).

Do not connect the coffee machine to a stand-alone inverter. These devices are used for autonomous power supply, such as a solar power system. Power surges could cause a safety shut-off. This could damage the electronic.

The coffee machine must not be used with **energy saving plugs**. These reduce the energy supply to the appliance, which could generate excessive heat.

If the power cord is faulty, it must only be replaced by a qualified electrician.

 Danger of overheating due to insufficient ventilation.

If the coffee machine is not sufficiently ventilated, the appliance can overheat.

Please ensure that there is adequate ventilation around the coffee machine.

Do not cover the coffee machine with dish towels, etc. while it is in use.

If the coffee machine is installed behind a closed cabinet front, heat and moisture can build up behind the cabinet front when closed. This can result in damage to the coffee machine and/or cabinetry.

Do not close the cabinet door while the coffee machine is in use.

If the coffee machine is installed in a niche, the niche must provide the following minimum dimensions:

Height	20" (508 mm)
Width	21 7/8" (450 mm)
Depth	17 11/16" (555 mm)

When setting up the appliance: Make sure that the service panel can be fully opened so that the brew unit can be removed with ease when required.

- The coffee machine must be set up in the niche such that it sits flush with the front edge of the niche.

Please observe the following installation instructions:

- The location of the appliance must be dry and well ventilated.
- The ambient temperature of the room in which the appliance is used must be between +50°F and +100°F (+10°C and +38°C).
- The coffee system must be set up on a level surface. The surface must be water resistant.

Appliance dimensions

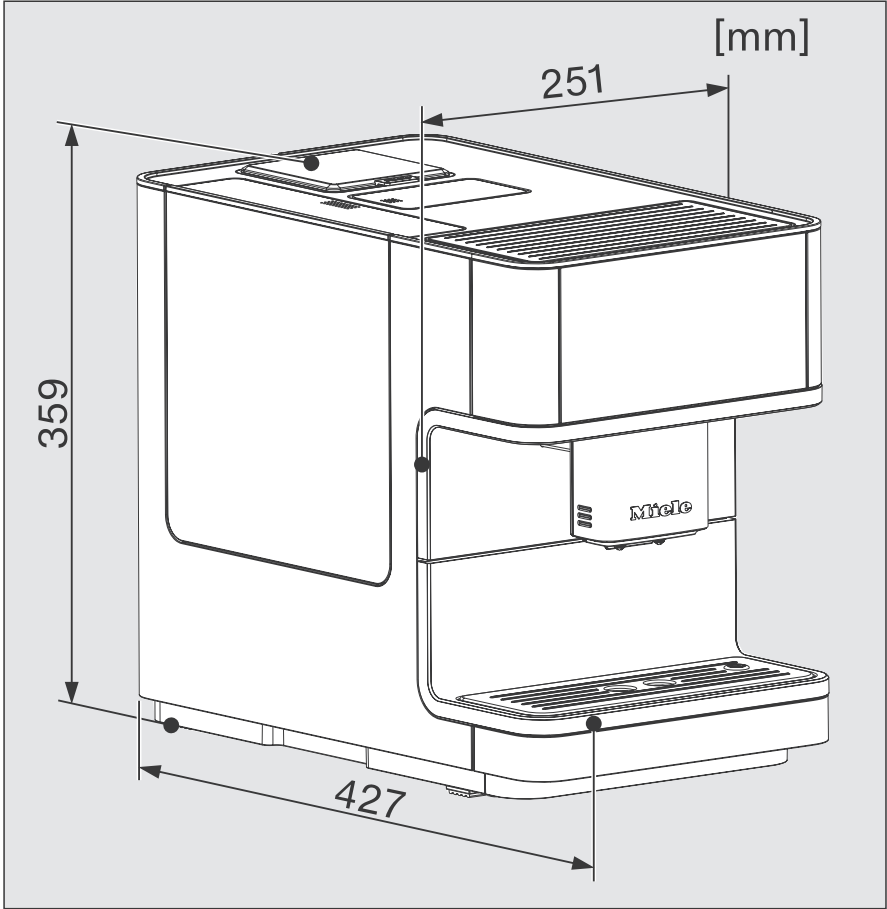

Appliance dimensions

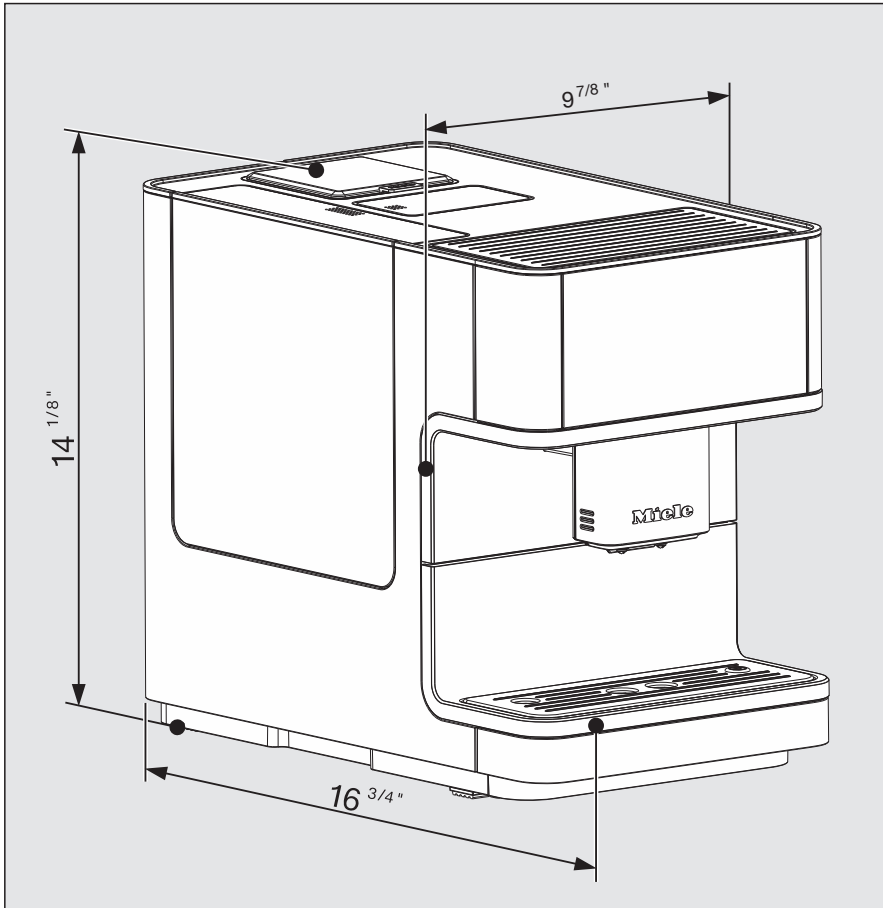

Technical data

Electricity consumption in standby:	< 0.1 W
Electricity consumption in networked standby:	< 0.5 W
Pump pressure:	max. 15 bar / 217 psi
Through-flow heater:	1 stainless-steel thermo block
Dimensions (W x H x D):	9 7/8" x 14 1/8" x 16 13/16" (251 x 359 x 427 mm)
Net weight:	21.8 lb (9.9 kg)
Power supply cord length:	55 1/8" (140 cm)
Water container capacity:	60.9 oz (1.8 l)
Coffee bean container capacity:	approx. 300 g
Milk flask capacity:	16.9 oz (0.5 l)
Drip tray capacity:	25.4 oz (0.8 l)
Grounds container capacity:	Max. 10 portions of coffee grounds
Main dispenser:	Height adjustable between 3 1/8"-5 1/2" (80-140 mm)
Grinder:	Conical steel grinder
Grinder setting:	Adjustable in 5 settings
Ground coffee amount:	Max. 0.4 oz (12 g)
Frequency band:	2.400–2.462 GHz
Max. transmission power	< 100 mW

(The milk flask is supplied with the CM 6360, CM 6560.)

Please have the model and serial number
of your appliance available when
contacting Customer Service.

U.S.A.

Miele, Inc.

National Headquarters

9 Independence Way
Princeton, NJ 08540
www.mieleusa.com

Customer Support

Phone: 888-99-MIELE (64353)
info@mieleusa.com

International Headquarters

Miele & Cie. KG
Carl-Miele-Straße 29
33332 Gütersloh
Germany

Canada

Importer
Miele Limited

Headquarters and Miele Centre

161 Four Valley Drive
Vaughan, ON L4K 4V8
www.miele.ca

Customer Care Centre

Phone: 1-800-565-6435
905-532-2272
customercare@miele.ca

CM 6160, CM 6360, CM 6560

en-US

M.-Nr. 11 675 690 / 04