





Operating and installation Instructions Washing machine



It is **essential** to read these operating instructions before installing and using the appliance. This prevents both personal injury and damage to the appliance.

Contents

Caring for the environment	5	Changing the programme sequence	46
Warning and Safety instructions ..	6	Changing a programme	46
Operating the washing machine ...	12	Cancelling a programme	46
Control panel.....	12	Switching on the washing machine after an interruption to the power supply.....	46
Symbols on the control panel.....	13	Adding or removing laundry.....	47
Symbols in the display.....	14	Detergent	48
Sensor controls and touch display with sensor controls	15	The correct detergent.....	48
Main menu	15	Cleaning and care	49
Examples on how to operate the appliance	16	Cleaning the external casing and fascia panel	49
Using for the first time	17	Cleaning the detergent dispenser drawer	49
Washing environmentally and economically	22	Cleaning the drum, suds container and drainage system.....	51
1. Preparing the laundry	23	Cleaning the sealing ring.....	51
2. Loading the washing machine ..	24	Cleaning the filters in the water inlet.....	52
3. Selecting a programme	25	Problem solving guide	53
4. Selecting programme settings .	26	The programme does not start	53
5. Adding detergent	28	Programme cancellations and fault messages	54
Adding fabric softener or liquid starch separately.....	28	A fault message appears in the display ¹	55
Adding starch separately	29	An unsatisfactory wash result.....	56
6. Starting the programme - the end of the programme	32	General problems with the washing machine	57
Delay start	33	The door will not open.....	59
Programme chart	34	Opening the door in the event of a blocked drain outlet and/or power cut.....	60
Special programmes	35	After sales service	63
Programme packages	37	Contact in case of fault	63
Extras	44	Optional accessories	63
Pre-wash 	44	Maintenance.....	63
Pre-rinse 	44	Installation	64
Pre-ironing 	44	Front view.....	64
Rinse plus 	44	Rear view	65
Special features in the programme sequence	45	Installation locations	66
Spinning	45	Installation notes.....	66
Anti-crease	45		

Transporting the washing machine to its installation site.....	67	Early warning counter.....	84
Installation surface.....	67	Water level Cottons.....	84
Removing the transit bars	68	Water level Minimum iron	84
Fitting the transit bars	70	Pre-wash temp. Cottons	84
Aligning the washing machine	71	Wash time pre-wash	84
Fixing bracket for plinth	72	Wash time Cottons.....	84
External control equipment.....	73	Wash time Minimum iron	84
Payment system	73	Pre-rinse Cottons	85
Water connection.....	74	Pre-rinse Minimum iron.....	85
Cold water connection	74	Pre-wash Cottons/Min. iron	85
Hot water connection*	75	Cottons rinses.....	85
Drainage.....	76	Minimum iron rinses.....	85
Drain valve	76	Disinfection rinse.....	85
Drain pump	76	Programme packages	85
Electrical connection	77	Disinfection prog. code.....	86
Technical data	78	Temperature reduction	86
Supervisor level.....	79	Auto load control	86
Code-based access	79	CapDosing	86
Changing the code	79	Pre-ironing.....	86
Opening the Supervisor level.....	79	Hygiene.....	86
Exiting the Supervisor level.....	79	Automatic dispensing	86
Language.....	80	Adjustment value dosage 1–6.....	87
Brightness.....	80	COM module selection.....	87
Clock display	80	Field of application	87
Finish tone volume	80	Availability of Miele digital products	87
Keypad tone	80	Wi-Fi/LAN	87
Welcome tone volume	80	Network time	88
Fault alarm.....	80	Peak load signal.....	89
Memory	80	Peak load prevention.....	89
Anti-crease	81	Remote	89
Suds cooling.....	81	RemoteUpdate	89
"Display" switch-off status	81	SmartGrid (only functional in selected countries)	90
Delay start	82	Clean drain pump	90
Programme name.....	82	Legal information.....	90
Visibility parameters	82	Copyright and licences for operating and control software ..	90
Pre-wash water.....	82		
Main wash water.....	83		
First rinse water	83		
Final rinse water	83		
Low water pressure.....	83		
Empty sensor	83		

Contents

Payment system	91
Settings for payment systems ...	91
Feedback signal to pay system .	91
Payment system lock	92
FOC programmes	92
Clear paid signal	92
Debounce time	92

Disposal of the packing material

The transport and protective packaging has been selected from materials which are environmentally friendly for disposal, and can normally be recycled.

Recycling the packaging reduces the use of raw materials in the manufacturing process and also reduces the amount of waste in landfill sites.

Ensure that any plastic wrappings, bags etc. are disposed of safely and kept out of the reach of babies and young children. Danger of suffocation.

Only for Australia: Note for installer: Expanded polystyrene (EPS) packaging included. Please retain and dispose of EPS packaging responsibly. For further information, please contact Miele.

Disposing of your old appliance

Electrical and electronic appliances often contain valuable materials. They also contain specific materials, compounds and components, which were essential for their correct function and safety. These could be hazardous to human health and to the environment if disposed of with your domestic waste or if handled incorrectly. Please do not, therefore, dispose of your old appliance with your household waste.



Please dispose of it at your local community waste collection / recycling centre for electrical and electronic appliances. You are also responsible for deleting any personal data that may be stored on the appliance prior to disposal. Please ensure that your old appliance poses no risk to children while being stored prior to disposal.

Warning and Safety instructions

This washing machine complies with all current local and national safety requirements. However, inappropriate use can lead to personal injury and damage to property.

Read the operating instructions carefully before using the washing machine. They contain important information on safety, installation, use and maintenance of the appliance. This prevents both personal injury and damage to the washing machine.

In accordance with standard IEC 60335-1, Miele expressly and strongly advises that you read and follow the instructions in “Installation”, as well as in the “Warning and Safety instructions”.

Miele cannot be held liable for injury or damage caused by non-compliance with these instructions.

Keep these operating instructions in a safe place and pass them on to any future owner.

When instructing other people how to use the washing machine, they must be made aware of these Warning and Safety instructions.

Correct application

- ▶ The washing machine is only suitable for washing fabrics with a care label stating that they are suitable for machine washing. Any other applications may be dangerous. The manufacturer cannot be held liable for damage resulting from incorrect or improper use or operation of the machine.
- ▶ This washing machine must be used as described in the operating instructions and must be checked on a regular basis to make sure it is functioning correctly. Maintenance must be carried out when necessary.
- ▶ The washing machine is not suitable for outdoor use.
- ▶ This washing machine is intended for commercial use in small businesses, care homes, sports clubs, hospitals and other similar commercial environments. This machine may also be operated by lay persons in public areas such as laundrettes, communal laundry rooms or similar commercial environment.

Warning and Safety instructions

- ▶ This washing machine is not intended for use by persons (including children) with reduced physical, sensory or mental capabilities, or lack of experience and knowledge, unless they have been given supervision or instruction concerning its use by a person responsible for their safety.
- ▶ Young children must not be allowed to use this appliance.
- ▶ Older children may only use the appliance when its operation has been clearly explained to them and they are able to use it safely. They must be able to understand and recognise the possible dangers caused by incorrect operation.
- ▶ Cleaning or maintenance on the washing machine may only be carried out by older children under the supervision of an adult.
- ▶ Always supervise any children in the vicinity of the washing machine. Never allow children to play with the washing machine.
- ▶ Disinfection programmes must not be interrupted, as this can have a limiting effect on the disinfection result. It is the operator's responsibility to ensure that the standard of disinfection in thermal as well as chemo-thermal procedures is maintained by carrying out suitable validation tests.

Technical safety

- ▶ Before installing and operating the washing machine, check it for any visible exterior damage. Do not set up or use a damaged washing machine.
- ▶ The electrical safety of this washing machine can only be guaranteed when continuity is complete between it and an effective earthing system which complies with current local and national safety regulations.
It is most important that this basic safety requirement is present and regularly tested and, when there is any doubt, the on-site wiring system should be inspected by a qualified electrician.
Miele cannot be held liable for the consequences of an inadequate earthing system (e.g. electric shock).
- ▶ Unauthorised repairs could result in unforeseen dangers for the user, for which the manufacturer cannot accept liability. Repairs must only be carried out by a qualified specialist or by Miele Customer Service, otherwise any subsequent damage will not be covered by the warranty.

Warning and Safety instructions

▶ Do not make any alterations to the machine, unless authorised to do so by Miele.

▶ In the event of a fault or for cleaning purposes, the washing machine must be isolated from the electricity supply. It is only completely isolated if:

- it is switched off at the wall socket and the plug is withdrawn, or
- the mains fuse is disconnected, or
- it is switched off at the mains circuit breaker.

For further information see “Installation - Electrical connection”.

▶ If the power supply cord is damaged, it must be replaced by a qualified specialist or by Miele Customer Service in order to protect the user from harm.

▶ The washing machine must be connected to the water supply using the new hose set supplied with the appliance. Old hose sets should not be re-used. Check the hose regularly for signs of wear. Replace it in good time to avoid the risk of leaks and water damage.

▶ We recommend replacing faulty components with original Miele parts. If original Miele parts are installed correctly, Miele guarantees full compliance with safety requirements and the warranty remains valid.

▶ Do not connect the machine to the mains electricity supply by a multi-socket adapter, extension lead or similar. These do not guarantee the required safety of the machine (fire hazard due to the risk of overheating).

▶ The machine must not be installed and operated in mobile locations (e.g. on a ship).

▶ Please observe the instructions in “Installation” and “Technical data”.

▶ If the washing machine is equipped with a mains plug, it must be easily accessible after installation so that the machine can be disconnected from the electricity supply if necessary.

▶ If the appliance is hard wired, an on-site dual circuit breaker must be accessible at all times in order to disconnect the washing machine from the mains supply. The means of disconnection must be incorporated in the fixed wiring in accordance with the wiring rules.

Warning and Safety instructions

▶ This washing machine is supplied with a special lamp to cope with particular conditions (e.g. temperature, moisture, chemical resistance, abrasion resistance and vibration). This lamp must only be used for the purpose for which it is intended. The lamp is not suitable for room lighting. Replacement lamps may only be installed by a qualified specialist or Miele Customer Service.

This washing machine contains 1 light source corresponding to energy efficiency class G.

▶ Temporary or permanent operation with a self-sufficient or non-mains synchronous energy supply system (e.g. isolated networks, back-up systems) is possible. A requirement for the operation is that the energy supply system complies with all current local and national requirements that apply to stand-alone, solar and/or battery systems. The protective measures provided in the building installation and in this Miele product must also be assured in their function and operation in isolated operation or in non-mains synchronous operation, or replaced with equivalent measures in the installation.

▶ The manufacturer's warranty will be invalidated if the washing machine is not repaired by a qualified specialist or Miele Customer Service.

Correct use

▶ The maximum load is 7.0 kg (dry laundry). See the "Programme chart" for the maximum recommended loads for individual programmes.

▶ Do not install your washing machine in a room where there is a risk of frost. Frozen hoses may burst or split, and the reliability of the electronic control unit may be impaired at temperatures below freezing point.

▶ Before using the machine for the first time, check that the transit bars at the rear of the washing machine have been removed (see "Installation and connection – Removing the transit bars"). During spinning, transit bars which are still in place can cause damage to both the machine and adjacent furniture or appliances.

▶ Turn off the tap if the machine is to be left for any length of time (e.g. while on holiday), especially if there is no floor drain (gully) in the immediate vicinity.

▶ If the ventilation openings are in the base of the washing machine, ensure that they are not obstructed by deep-pile carpet or similar.

Warning and Safety instructions

- ▶ **Danger of flooding!** If hooking the drain hose into a laundry washtub, check that the water can drain away fast enough to prevent the laundry tub from overflowing. Secure the drain hose against slipping. The force of the water flowing out of the hose can dislodge it.
- ▶ Make sure that no foreign objects (e.g. nails, pins, coins, paper clips) find their way into the machine with the laundry. Foreign objects can damage components of the machine (e.g. suds container, drum). Damaged components can, in turn, result in damage to the laundry.
- ▶ If the correct amount of detergent is dispensed, the machine should not need to be descaled. If, however, you do wish to descale it, only use special non-corrosive descaling agents and strictly observe the instructions on the packaging. Special descaling agent is available from your Miele dealer or from Miele. Strictly observe the instructions for the packaging.
- ▶ For textiles that have been treated with solvent-based cleaning agents, always check whether they can be washed in a washing machine. To check whether this is possible, refer to safety notes, information concerning the product's environmental compatibility, and other information.
- ▶ Never use solvent-based detergents, e.g. those containing benzene, in this washing machine. This may result in damage to component parts and create toxic fumes. Risk of fire and explosion!
- ▶ Gasoline, petroleum, kerosene, paraffin, or any easily flammable liquid must not be stored or used near the washing machine. Risk of fire and explosion!
- ▶ Only use dyes suitable for use in a washing machine. Always observe the manufacturer's instructions carefully.
- ▶ Dye removers contain sulphur compounds which can cause damage such as corrosion. Dye removers must not be used in the washing machine.
- ▶ Avoid contact between stainless steel surfaces (front, lid, casing) and liquid detergents or disinfecting agents which contain chlorine or sodium hypochlorite. These agents can cause corrosion on stainless steel. Aggressive vapours containing chlorine can also be corrosive. Do not store open containers of these agents near the machine.
- ▶ Do not use a high-pressure cleaner or water jet to clean the washing machine.

Warning and Safety instructions

- ▶ It is particularly important to observe the manufacturer's instructions when using a combination of cleaning agents and special application products. Products must only be used for applications approved by the manufacturer to avoid any material damage or the occurrence of strong chemical reactions.
- ▶ If detergent has come into contact with the eyes, rinse out immediately with plenty of lukewarm water. If detergent has accidentally been ingested, seek medical advice immediately. People with damaged or sensitive skin should avoid contact with detergent.
- ▶ When adding or removing laundry during the main wash, your skin may come into contact with detergent, particularly if the detergent is dispensed externally. Take care when placing your hands inside the drum. If suds have come into contact with the skin, rinse off immediately with lukewarm water.

Accessories

- ▶ We recommend using original Miele accessories. Using spare parts or accessories from other manufacturers will invalidate the warranty and Miele cannot accept liability.
- ▶ Miele tumble dryers and Miele washing machines can be installed as a washer-dryer stack. This requires a Miele washer-dryer stacking kit which can be purchased separately. Please ensure that the washer-dryer stacking kit is suitable for your Miele tumble dryer and your Miele washing machine.
- ▶ If installing the machine on a Miele plinth (available as an optional accessory), please make sure you order the correct one for this washing machine.
- ▶ Miele original spare parts are kept in stock for at least 10 years and up to 15 years after discontinuation of your washing machine.

Miele cannot be held liable for damage caused by non-compliance with these Warning and Safety instructions.

Operating the washing machine

Control panel

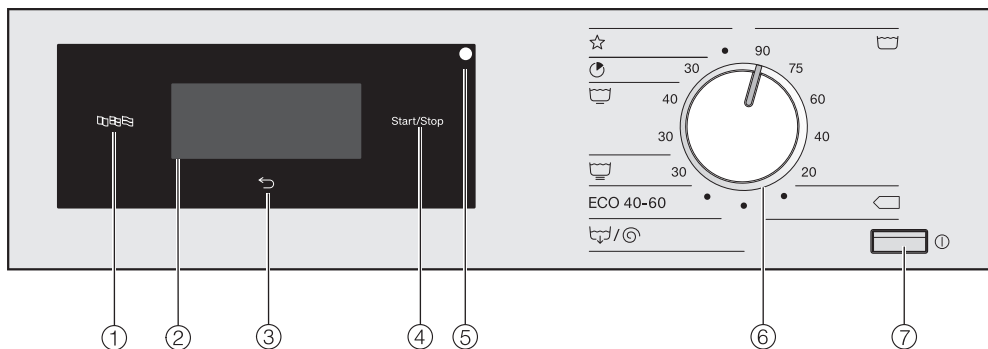

- ① **language sensor**
For selecting the current user language.
The operating language is displayed again at the end of the programme.
- ② **Touch display with sensors**
Displays the selected programme.
The programme settings are selected using the sensors in the touch display.
- ③ **back sensor**
Takes you back one level in the menu.
- ④ **Start/Stop sensor**
For starting the selected programme and cancelling a programme that has already started.
- ⑤ **Optical interface**
For service technicians.
- ⑥ **Programme selector**
For selecting the wash programme.
The programme selector can be turned clockwise or anti-clockwise.
- ⑦ **⏻ button**
For switching the washing machine on and off.
The washing machine switches itself off automatically to save energy. It is switched off 15 minutes after the end of the programme/Anti-crease phase, or after being switched on if no further selection is made.

Operating the washing machine

Symbols on the control panel

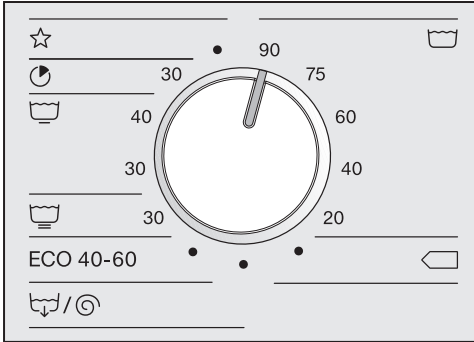

Cottons



Cottons <40°C> / <60°C>



Special programmes



Express



Minimum iron



Delicates

ECO 40-60

Cottons ECO 40-60



Drain/Spin

Operating the washing machine

Symbols in the display



Temperature: Use the *Temperature* sensor to set the temperature of the wash programme.



Spin speed: Use the *Spin speed* sensor to set the spin speed of the wash programme.



Extras: Use the *Extras* sensor to add Extras to a wash programme.



Pre-wash: Use the *Pre-wash* sensor to select the *Pre-wash* Extra for a wash programme.



Pre-ironing: Use the *Pre-ironing* sensor control to select the *Pre-ironing* Extra for a wash programme.



Rinse plus: Use the *Rinse plus* sensor to add an additional rinse cycle to a wash programme.



Further selections: Use the *Further selections* sensor to select further options.



CapDosing: Use the *CapDosing* sensor control to dispense detergent via a capsule.



Supervisor level: Use the *Supervisor level* sensor to alter the washing machine's settings.



Delay start: Use the *Delay start* sensor to set the start time of a wash programme ...





... or the finish time



... or the time until the programme starts.

Operating the washing machine

Sensor controls and touch display with sensor controls

The ,  and *Start/Stop* sensors and the sensor controls in the display react to finger contact. Every touch of a sensor is confirmed by an audible tone. You can adjust the volume of the keypad tone or switch it off (see “Supervisor level”).

The control panel with the sensor controls and the touch display can be scratched by pointed or sharp objects, e.g. pens.

Only touch the display with your fingers.

Main menu

The main menu of a wash programme displays different values depending on the programme.

For programmes with a fixed temperature setting:

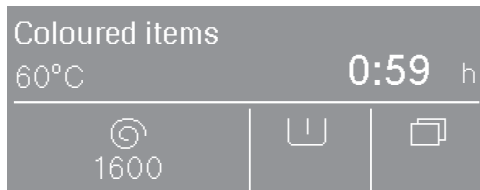

- the selected programme with the set temperature
- the programme duration
- the spin speed set
- the selectable Extras
- further options available and the settings in the Supervisor level

For programmes with a variable temperature setting:

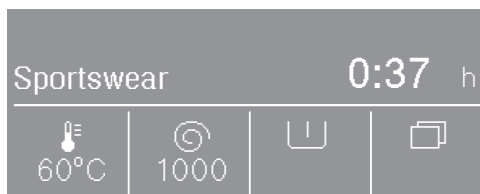

- the selected programme
- the programme duration
- the temperature set
- the spin speed set
- the selectable Extras
- further options available and the settings in the Supervisor level

Operating the washing machine

Examples on how to operate the appliance

Selection lists

The \wedge and \vee arrows on the right of the display indicate that further choices are available.

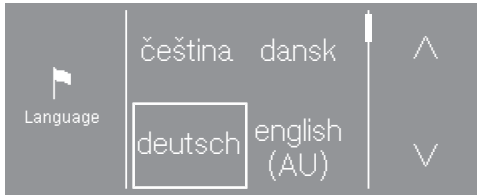

The list scrolls down when the \vee sensor control is touched. The list scrolls up when the \wedge sensor control is touched.

The scroll bar indicates that further options follow.

The currently selected value is marked with a frame.

Touch the required value to select it.

Single selection

If there are no arrows, the selection is limited to the displayed values.

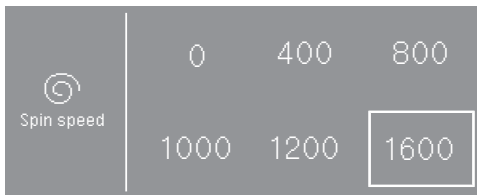

The currently selected value is marked with a frame.

Touch the required value to select it.

Setting numerical values

To change a numerical value, use the \wedge and \vee arrows above or below the numbers you want to change.



Touch the \wedge and \vee arrows and confirm with the *OK* sensor.

Exiting a submenu

Select the back \leftarrow sensor to exit a submenu.

If a value is selected in a submenu but not confirmed with *OK*, this value is discarded by selecting the \leftarrow sensor control.

 Damage resulting from incorrect installation and connection. Installing and connecting the washing machine incorrectly will cause serious damage to property. Please observe the instructions in “Installation and connection”.

Emptying the drum

A swivel elbow for the drain hose and/or assembly material may be stored in the drum.

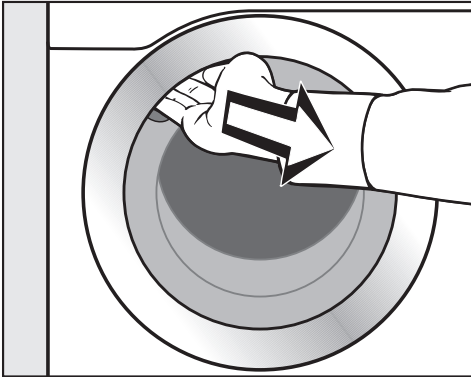

- Pull open the door.
- Remove the swivel elbow and assembly material.
- Shut the door with a gentle swing.

Switching on the washing machine

- Press the  button.

The welcome screen will light up.

When commissioning the washing machine for the first time, you will have to define the settings for the daily use of the appliance. Some settings can only be configured during the initial commissioning process. After that, they must be changed by Miele. Complete the initial commissioning process.

These settings are also described in “Supervisor level”.

Useful tip: During initial commissioning, you can go back to the previous screen if you need to correct an entry you have already made.

- Touch the  sensor to return to the previous screen.

Setting the display language

You will be asked to select the language for the display. You can change the language at any time (see “Supervisor level - Language”).

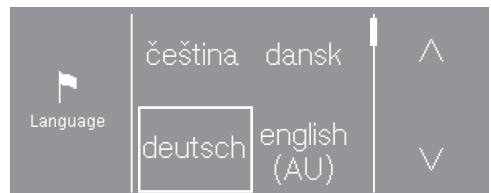

Using for the first time

- Touch the \wedge or \vee sensor until the language you want appears in the display.
- Touch the sensor for the required language.

The selected language is marked with a frame and the display will change to the next setting.

Reference to external appliances

A reference to external hardware appears.

- Confirm with the OK sensor.

Before initial commissioning, connect the XCI box or adapter or slide a communication module into the slot on the back of the machine. The washing machine must be disconnected from the mains for this purpose. Then start the commissioning process.

Setting the display brightness

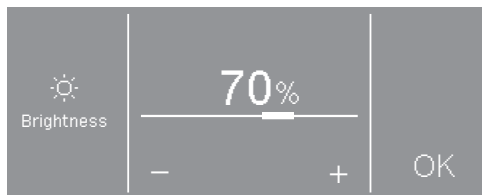

- Set the desired brightness with the $-$ and $+$ sensors and confirm your selection with the OK sensor.

The display will change to the next setting.

Confirming the time query

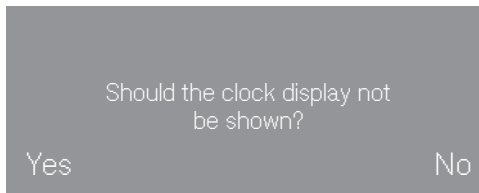

- Touch the Yes or No sensor.

If you select Yes, the system will skip the Clock display setting.

If you select No, the display will switch to the Clock display setting.

Setting the time of day

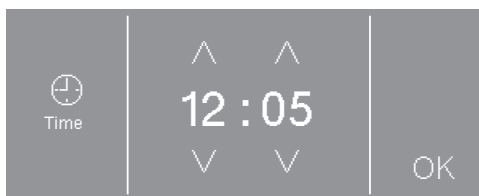

- Use the \vee and \wedge sensor controls to enter the time and confirm your entry with the OK sensor.

The display will change to the next setting.

Selecting programme packages

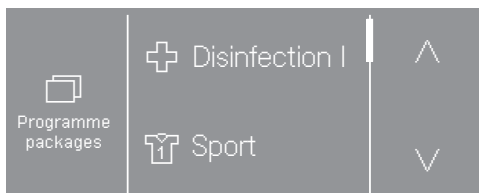

- Touch the \wedge or \vee sensor control until the programme package you want appears in the display.
- Touch the sensor control of the programme package.

The display will show the associated programmes.

The activated programmes are marked with a frame.

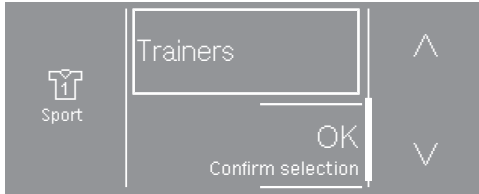

- Touch the sensors for the programmes.

The programmes are activated (framed) or deactivated (no frame).

- Confirm with the *OK* sensor.

The display switches back to the programme packages.



- Select other programme packages or confirm your selection with the Next sensor control.

The display will change to the next setting.

Switching on automatic dispensing

Automatic dispensing can be activated via the XCI box or the COM module.

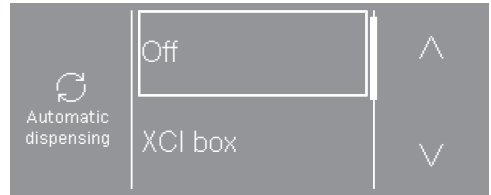

- Touch the \wedge or \vee sensor until the option you want appears in the display.
- Touch the sensor for the option.
- If you do not want to switch on automatic dispensing, touch the Off sensor.

The display will change to the next setting.

Setting up a payment system

If you wish to set up a payment system, read the chapter “Supervisor level - Payment system”.

If you do not wish to set up a payment system, you can skip this step.

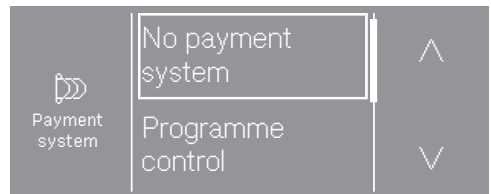

- Touch the No payment system sensor.

The display will change to the next setting.

Using for the first time

Selecting the communication module

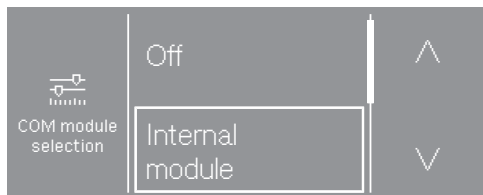

- Touch the \wedge or \vee sensor until the option you want appears in the display.
- Touch the Internal module sensor if you want to use the internal communication module.
- Touch the External module sensor if you want to use the external communication module.

The display will change to the next setting.

Selecting the field of application

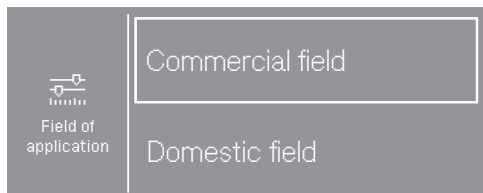

- Touch the Commercial field sensor if you want to connect to Miele MOVE.
- Touch the Domestic field sensor if you want to connect to the Miele App.

Setting successfully accepted appears in the display.

- Confirm the message with the OK sensor.

The display will change to the next setting.

Selecting pre-wash water

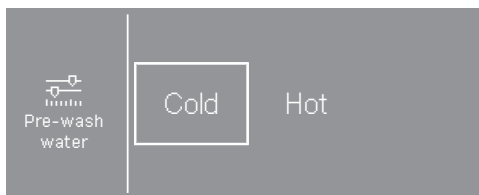

- Touch the Cold sensor if the washing machine is only connected to the cold water supply, or touch Hot if the washing machine is connected to both cold and hot water.

The display will change to the next setting.

Selecting main wash water

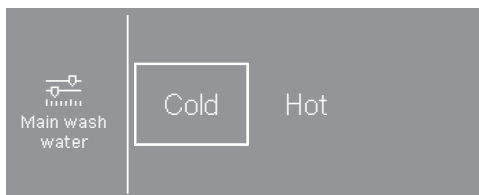

- Touch the Cold sensor if the washing machine is only connected to the cold water supply, or touch Hot if the washing machine is connected to both cold and hot water.

Further information will appear in the display.

Removing the transit bars.

The display will remind you to remove the transit bars.

 Damage resulting from failure to remove the transit bars.

Failure to remove the transit bars can result in damage to the washing machine and to adjacent cabinetry or appliances.

Remove the transit bars as described in "Installation and connection".

- Confirm that the transit bars have been removed with the *OK* sensor.

The following appears in the display: To complete commissioning, start the "Commissioning" programme without laundry

- Confirm the message with the *OK* sensor.

Completing the commissioning process

To complete commissioning, the commissioning programme must be run without laundry and without detergent.

If the power is interrupted (e.g. if the machine is switched off with the  control), the initial commissioning process can be carried out again. If the commissioning programme has run through to the end, the initial commissioning process does not have to be performed again.

- Turn on the water taps.
- Touch the flashing *Start/Stop* sensor.
- Once the programme has finished, switch the washing machine off briefly and then switch it back on again.

The appliance is now ready for use.

Washing environmentally and economically

Energy and water consumption

- Use the maximum load size for the current programme. The energy and water consumption will then be the lowest in relation to the size of the load.
- Programmes that are more efficient with regard to energy and water consumption generally have a longer programme running time. By extending the programme running time, the wash temperature that is actually reached can be reduced while still providing the same wash results.

For example, the *ECO 40-60* programme has a longer running time than the *Cottons 40°C* or *60°C* programme. The *ECO 40-60* programme, however, is more efficient in terms of energy and water consumption.

- Use the *Express* programme for small, lightly soiled loads.
- Modern detergents make it possible to wash at lower temperatures (e.g. 20°C). Using lower temperature settings will save energy.
- Washing at low temperatures and/or using liquid detergents can cause bacteria and odours to build up in the washing machine. To maintain the hygiene of the machine, carry out a hot wash (above 60°C) at regular intervals.

Detergent consumption

- Do not exceed the amounts of detergent recommended by the manufacturer on the packaging.
- Adjust the dosage to the degree of soiling of the laundry.
- Reduce the amount of detergent with smaller loads (e.g. reduce the amount of detergent by $\frac{1}{3}$ when washing a half load).

Information about subsequent tumble drying

The spin speed selected affects the residual moisture in the laundry and the sound emissions of the washing machine.

The higher the spin speed, the lower the residual moisture in the laundry. However, the sound emissions of the washing machine will increase.

Select the highest possible spin speed for the wash programme to save energy in the subsequent tumble dryer cycle.

1. Preparing the laundry

Emptying all pockets

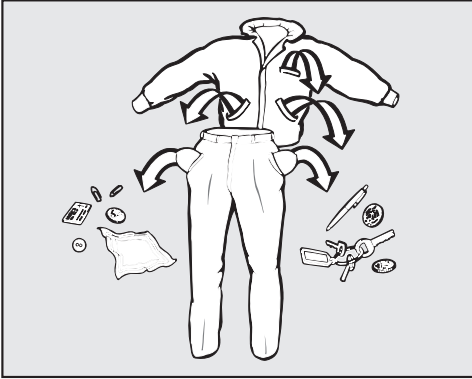

- Empty all pockets.

⚠ Damage due to foreign objects.

Foreign objects (e.g. nails, coins, paper clips etc.) can cause damage to garments and to components in the machine.

Check the laundry before washing and remove any foreign objects.

Sorting the laundry

- Sort the laundry by colour and by care label. Most garments have a textile care label in the collar or side seam.

Pre-treating stains

- Clean badly soiled areas and stains on the textiles before washing. Spillages should be carefully dabbed off using a soft, colourfast cloth.

⚠ Damage due to solvent-based cleaning agents.

Cleaning agents containing benzene, stain remover, etc., can damage plastic parts.

When pre-treating garments, make sure that any plastic parts (e.g. buttons) do not come into contact with cleaning agent.

⚠ Risk of explosion due to solvent-based cleaning agents.

If solvent-based cleaning agents are used, an explosive mixture can form. Never use solvent-based cleaning agents in the washing machine.

General tips

- Do not wash any items in this machine which are specified by the manufacturer as **not washable** on the care label (☒ symbol).
- Curtains: Remove lead weights first or place in a laundry bag.
- Remove or sew in any loose underwiring in bras or shirt collar stiffeners.
- Turn garments inside out, if recommended by the manufacturer.
- Close any zips and Velcro fasteners before washing.
- Fasten duvet covers and pillow cases to prevent small items from being rolled up inside them.
- Please refer to the Programme chart for more tips.

2. Loading the washing machine

Opening the door

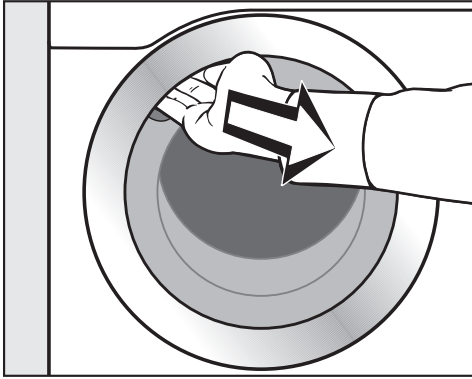

- Reach under the door grip and pull the door open.

Check the drum for pets or foreign objects before loading it with laundry.

- Unfold the laundry and load loosely in the drum.

Mixing both large and small items gives better wash results and helps distribute the load evenly during spinning.

The most efficient use of energy and water is achieved when a full load is washed. However, do not overload as this reduces cleaning efficiency and causes creasing.

Closing the door

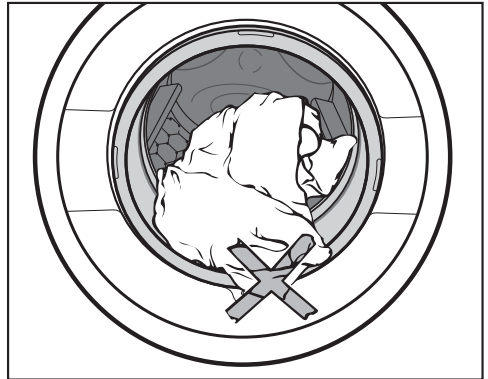

- Make sure that no items are caught between the door and the seal.

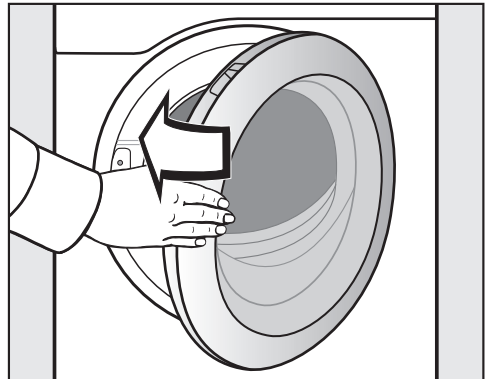

- Shut the door with a gentle swing.

3. Selecting a programme

Switching on the washing machine

- Press the  button.

The interior drum lighting will come on.

The drum lighting will go out automatically after five minutes or after the programme start.

Selecting a programme

Selecting standard programmes with the programme selector

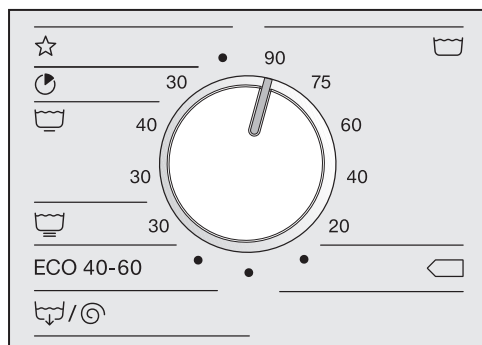

- Turn the programme selector to the required programme.

The selected programme will be shown in the display. The display will then change to the main menu for that programme.

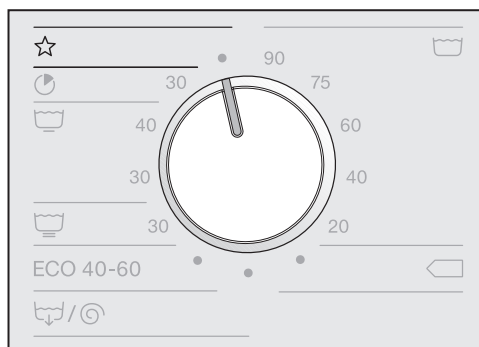

Selecting special programmes via the programme selector position

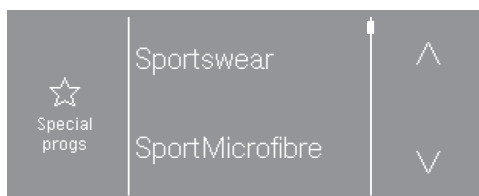

- Turn the programme selector to the  position.

You can select the required programme via the display.



- Touch the  or  sensor until the programme you want appears in the display.
- Touch the sensor for that programme.

The display will change to the main menu for that programme.

4. Selecting programme settings

Selecting the temperature

You can alter the preset temperature of certain programmes.

- Touch the *Temperature*  sensor.

The following will appear in the display:

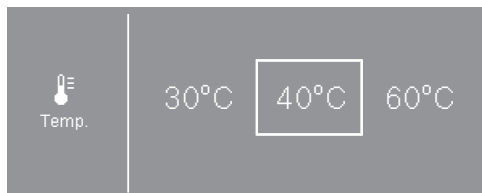

- Select the desired temperature.

The selected temperature is marked with a frame.

Selecting the spin speed

You can alter the preset spin speed.

- Touch the *Spin speed*  sensor.

The following will appear in the display:

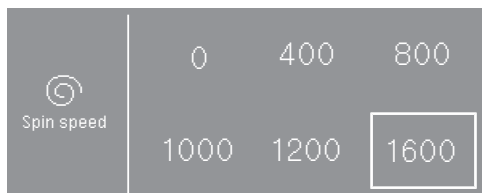

- Select the desired spin speed.

The selected spin speed is marked with a frame.

Selecting Extras

You can select Extras for the wash programmes.

For some programmes, an Extra is offered directly in the main menu.

- Touch the sensor of the Extra to activate it.

For some programmes, you select Extras in the *Extras* submenu.

- Touch the *Extras*  sensor.

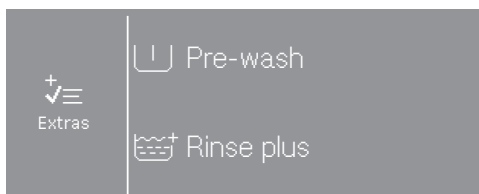

- Select one or two of the available Extras in succession.

Not all Extras can be selected with every programme. If an Extra is not listed, it is not permitted for use with this wash programme.

Selecting further options

You can activate CapDosing, select a Delay start time or change the settings of the washing machine.

- Touch the  sensor.

The following will appear in the display:

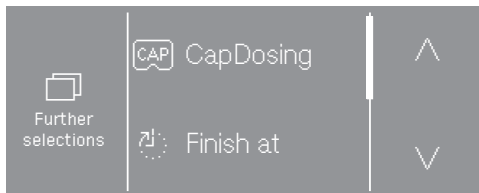

- Select the desired option.

The display will change to the submenu for that option.

4. Selecting programme settings

Delay start and *CapDosing* are not possible for some programmes.

5. Adding detergent

There are several options for adding detergent.

Detergent dispenser drawer

Any detergent suitable for automatic front loading washing machines can be used with this appliance.

Detergent dispensing

Please follow the detergent manufacturer's instructions in relation to dosage.

Adding too much detergent will lead to excessive foaming.
Avoid adding excess detergent.

The amount to dispense will depend on:

- the amount of laundry
- the degree of soiling of the laundry
- the water hardness



Water hardness range	Hardness in mmol/l	German scale °dH
soft (I)	0-1.5	0-8.4
medium (II)	1.5-2.5	8.4-14
hard (III)	above 2.5	above 14

Check with your local water supplier if you do not know the water hardness in your area.

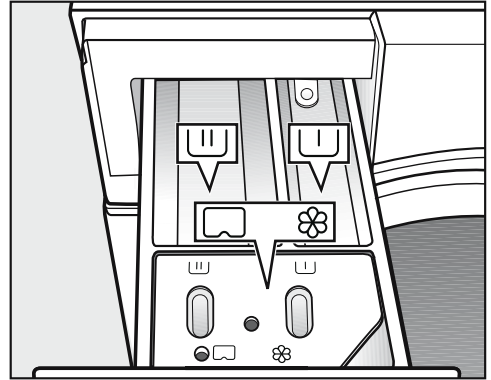

Adding detergent





- Pull out the detergent dispenser drawer and add detergent to the compartments.

 Detergent for the pre-wash (divide the total recommended amount as follows: $\frac{1}{3}$ to compartment  and $\frac{2}{3}$ to compartment )

 Detergent for the main wash

/  Fabric softener, liquid starch or capsules

For disinfection programmes, the  and  compartments can be filled with detergent for the main wash if you have not selected Pre-wash.

Adding fabric softener or liquid starch separately

- Select the *Separate rinse* programme.
- Change the spin speed if necessary.

5. Adding detergent

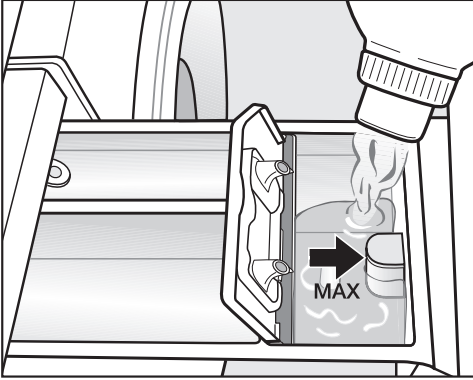

- Add the fabric softener or the liquid starch to the  compartment. **Do not exceed the maximum level mark.**
- Touch the *Start/Stop* sensor.

This will be automatically dispensed in the final rinse. At the end of the wash programme a small amount of water remains in the  compartment.

Adding starch separately

- Prepare the starch solution in accordance with the manufacturer's instructions on the packaging.
- Select the *Starch* programme.
- Add the prepared starch to the  compartment.
- Touch the *Start/Stop* sensor.

Useful tip: If starching separately or automatically, thoroughly clean the detergent dispenser compartment, especially the siphon, regularly.

Dye removers and dyes

 Damage due to colour run/dye removers.

Colour run and dye removers can cause corrosion in the washing machine.

Do not use colour run or dye removers in this washing machine.

Only use dyes suitable for use in a washing machine. The manufacturer's instructions on the packaging must be observed.

5. Adding detergent

CapDosing

Three different types of capsules are available:

- ☼ = Fabric care (e.g. fabric softener, proofing agent)
- ⚗ = Additives (e.g. detergent enhancers)
- 💧 = Detergent (for the main wash only)

Only one capsule can be selected per wash programme.



Depending on the setting selected, the detergent, additive, or fabric care agent will be dispensed via the capsule for this wash programme.

Each capsule contains the correct amount for one wash cycle.

Capsules are available to order from Miele or from the Miele online shop (see the end of this booklet for contact details).

⚠ Capsules pose a health risk. The ingredients of capsules can be hazardous to health if they are swallowed or come into contact with skin. Keep capsules out of the reach of children.

Activating CapDosing

- Touch the *Further selections*  sensor control.
- Touch the CapDosing  sensor.

The types of capsules which can be used with the programme will appear in the display.



- Select the type of capsule you want to use.

The display switches to the main menu and shows the selected capsule.

Inserting a capsule

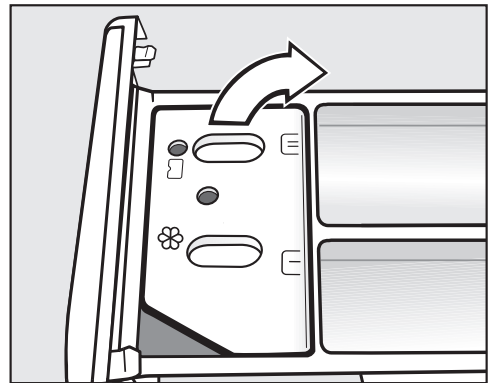
- Open the detergent dispenser drawer.



- Open the lid of the /  compartment.

5. Adding detergent

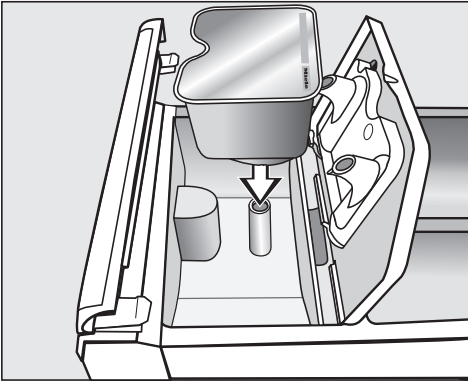

- Press the capsule in firmly.

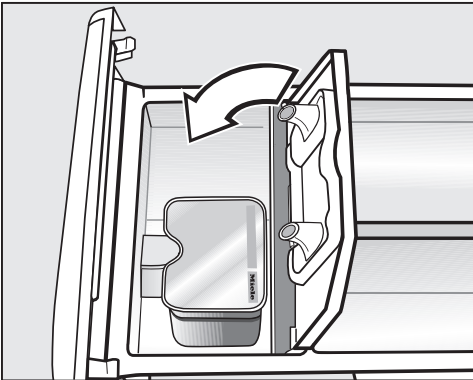

- Close the lid and press it firmly shut.
- Close the detergent dispenser drawer.

The capsule is opened by the act of inserting it in the detergent dispenser compartment. The contents can run out of the capsule if you remove it before it has been used.
Dispose of opened capsules.

The wash programme will dispense the contents of the capsule at the correct time.

Water intake to the  compartment is solely via the capsule.

When using capsules do not add fabric softener to the  compartment.

- Remove the empty capsule at the end of the wash programme.

For technical reasons a small amount of water will remain in the capsule.

Deactivating or changing CapDosing

CapDosing can only be deactivated or changed prior to programme start.

- Touch the  sensor.
- Select CapDosing and disable the selected capsule.

External dispensing

The washing machine is pre-equipped for connection to an external detergent dispensing system. A separate conversion kit for external dispensing systems is required. This must be fitted by a Miele authorised service technician.

6. Starting the programme - the end of the programme

Payment system

If your machine is connected to a payment system, the amount of payment required will appear in the display.

Do not cancel the programme once it has started. Depending on the settings, credit added in the payment system may be lost when the programme is cancelled.

Starting a programme

The programme can be started once the *Start/Stop* sensor is flashing on and off.

- Touch the *Start/Stop* sensor.

The door will lock (🔒 symbol) and the wash programme will start.

If a delay start time has been selected, this will count down in the display until the programme starts.

At the end of the delay start time or immediately after the programme has started, the programme duration will appear in the display. The programme sequence is also shown in the display.

Useful tip: Touch the **i** sensor control to display the set temperature, spin speed and any set Extras.

At the end of the programme

The door remains locked during the anti-crease phase. However, the door can be unlocked at any time by touching the *Start/Stop* sensor.

Removing the laundry

- Pull open the door.
- Remove the laundry.

Items left in the drum could discolour other items in the next wash or become discoloured themselves. Remove all items from the drum.

- Check the folds in the door seal for any small articles, e.g. buttons, which might be lodged there.





Useful tip: For safety reasons, close the door when the washing machine is not in use. Otherwise there is a danger of objects being placed inadvertently in the drum. If these remain unnoticed and were washed in the next load, they could damage the laundry. An open door is also a danger to pets and children.

- Switch the washing machine off with the ⏻ button.
- If applicable, remove the used capsule from the detergent dispenser drawer.

Useful tip: Leave the detergent dispenser drawer slightly open to allow it to dry.

The Delay start function can be used to set the time until the programme starts or the programme finish time (see “Supervisor level - Delay start”).

Selecting Delay start

- Touch the *Further selections*  sensor.
- Select the Finish at , Start at  or Start in  option.
- Use the \wedge and \vee sensors to enter the hours and minutes and confirm your entry with the *OK* sensor.

The minutes entry moves to the next “full quarter of an hour” and can then be adjusted in 15-minute increments.

Starting Delay start

- Touch the *Start/Stop* sensor.

The door will lock and the time remaining until the programme starts will appear in the display.

Cancelling or changing Delay start

- Touch the *Start/Stop* sensor.

The following will appear in the display:

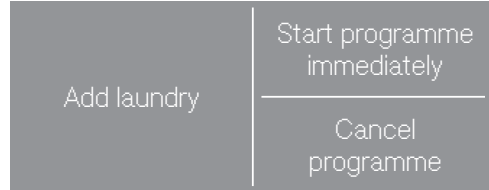

- Touch the Start programme immediately sensor.

The wash programmes starts immediately.













or

- Touch the Cancel programme sensor.

The programme start is cancelled and the *Start/Stop* button flashes on and off.





Programme chart

Standard programmes



 Cottons		20°C to 90°C	Max. load 7.0 kg
Items	Cotton, linen, and mixed fibre textiles		
Notes	<ul style="list-style-type: none"> - Select the temperature according to the instructions on the care label, the detergent, the type of soiling and the hygiene requirements. - For dark coloured fabrics use a colour detergent or liquid detergent. 		
1600 rpm	Extras: Pre-wash 		Rinse cycles: 1-5*
 Cottons		 / 	Max. load 7.0 kg
Items	Moderately soiled cotton garments.		
Notes	- With  , the actual wash temperature reached is lower than 60°C although the wash performance is the same as with the standard Cottons 60°C programme.		
1600 rpm	Extras: Pre-wash 		Rinse cycles: 2
 Express		30°C	Max. load 3.5 kg
Items	Cotton garments that have hardly been worn or are only very lightly soiled		
1400 rpm	Extras: Rinse plus 		Rinse cycles: 1
 Minimum iron		30°C to 40°C	Max. load 3.5 kg
Items	Synthetic, mixed fibre and easy care cotton fabrics		
Notes	- Reduce the final spin speed for fabrics which crease easily.		
1200 rpm	Extras: Pre-wash  , Pre-ironing 		Rinse cycles: 2-4*

* You can alter the number of rinse cycles carried out via the Supervisor level.



Programme chart

 Delicates		30°C	Max. load 2.5 kg
Items	Delicate garments made from synthetic fibres, mixed fibre, rayon and viscose		
Notes	- Deselect the final spin speed for fabrics which crease easily.		
600 rpm	Extras: Pre-wash  , Pre-ironing 	Rinse cycles: 2	
ECO 40-60		Max. load 7.0 kg	
Items	Normally soiled cotton garments		
Notes	<ul style="list-style-type: none"> - A laundry load consisting of mixed cottons that are intended for washing at 40°C or 60°C can be washed in the same wash cycle. - This programme is the most efficient in terms of energy and water consumption for washing cottons. 		
1600 rpm		Rinse cycles: 2	
 Drain/Spin		Max. load 7.0 kg	
Notes	<ul style="list-style-type: none"> - Make sure you select the appropriate spin speed. - Select the <i>Rinse plus</i> Extra for an additional rinse cycle. - Drain only: Select 0 rpm for the spin speed. 		
1600 rpm	Extras: Rinse plus 		



Special programmes

Towelling		40°C to 60°C	Max. load 7.0 kg
Items	Towels and bathrobes made from terrycloth		
Notes	- Use a colour detergent for dark textiles.		
1400 rpm	Extras: Pre-wash 	Rinse cycles: 2	
Shirts		20°C to 60°C	Max. load 2.5 kg
Items	Shirts and blouses		
Notes	<ul style="list-style-type: none"> - Pre-treat collars and cuffs if necessary. - Wash silk shirts and blouses in the <i>Silks</i> programme. - Reduce the maximum load quantity by half if you have selected the <i>Pre-ironing</i> Extra. 		
800 rpm	Extras: Pre-ironing 	Rinse cycles: 2	

Programme chart

Dark garments		30°C to 60°C	Max. load 3.5 kg
Items	Black and dark garments made from cotton or mixed fibres		
Notes	- Wash inside out.		
1000 rpm			Rinse cycles: 3
Denim		30°C to 60°C	Max. load 3.5 kg
Items	Denim shirts, blouses, trousers, skirts and jackets		
Notes	<ul style="list-style-type: none"> - Wash denim inside out. - Denim often contains excess dye and may run during the first few washes. Wash light and dark coloured items separately. 		
1000 rpm			Rinse cycles: 3
Woollens		Cold to 30°C	Max. load 2.5 kg
Items	Machine-washable woollens and woollen blends		
Notes	- Use detergent formulated for woollens.		
1200 rpm			Rinse cycles: 2
Silks		Cold to 30°C	Max. load 2.5 kg
Items	Silks and hand-washable textiles which do not contain wool		
Notes	<ul style="list-style-type: none"> - Observe the instructions on the care label. - Place stockings and bras in a laundry bag. 		
600 rpm	Extras: Rinse plus 		Rinse cycles: 2
Cottons PRO		60°C	Max. load 7.0 kg
Items	Mixed fibre textiles (50% cotton and 50% polyester)		
Notes	- Extra energy-efficient wash programme for commercial cotton or cotton/synthetic blend textiles with moderate levels of soiling, e.g. workwear.		
1400 rpm	Extras: Pre-wash 		Rinse cycles: 2
Separate rinse			Max. load 7.0 kg
Items	Fabrics that only need to be rinsed and spun		
Notes	- Reduce the spin speed for items which crease easily.		
1400 rpm	Extras: Rinse plus 		Rinse cycles: 2

Programme chart

Starch		Cold to 40°C	Max. load 3.5 kg
Items	For starching table cloths, serviettes and workwear		
Notes	<ul style="list-style-type: none"> - Laundry that is to be starched should be washed but not treated with fabric softener. - Reduce the spin speed for items which crease easily. 		
1400 rpm		Rinse cycles: 1	
Clean machine 70°C		No load	
	For cleaning the suds container and the drainage system. <ul style="list-style-type: none"> - Add universal detergent to the  compartment. - Use the <i>Clean machine</i> programme regularly if you frequently use disinfection programmes. 		
Machine hygiene		No load	
	For cleaning the suds container and the drainage system. <ul style="list-style-type: none"> - If a programme at a temperature below 60°C has been used, the prompt to start the Maintenance wash hygiene programme will appear in the display. The Hygiene setting must be switched on for this purpose (see “Supervisor level”). - Add universal detergent to the  compartment. 		



Programme packages

You can select various programmes packages. The programmes selected from the programme packages are displayed under the *Special programmes* list.



Sport

Sportswear		30°C to 60°C	Max. load 3.0 kg
Items	Sports and leisure wear, such as jersey shirts and trousers made from synthetic fibres or mixed blends		
Notes	<ul style="list-style-type: none"> - Do not use fabric softener. - Observe the instructions on the care label. 		
1000 rpm	Extras: Pre-wash 		Rinse cycles: 2



Programme chart

SportMicrofibre		30°C to 60°C	Max. load 3.0 kg
Items	Clothing for sport and fitness such as jersey shirts, trousers and base layers made from microfibre		
Notes	<ul style="list-style-type: none"> - Do not use fabric softener. - Observe the instructions on the care label. 		
800 rpm	Extras: Rinse plus 	Rinse cycles: 2	
Trainers		30°C to 60°C	Max. 2 pairs
Items	Trainers (no leather shoes), shin pads, elbow protectors and similar items		
Notes	<ul style="list-style-type: none"> - Do not use fabric softener. - Coarse soiling should be brushed off first. - Observe the instructions on the care label. - Use the drying basket for tumble drying. - Close Velcro fasteners. 		
400 rpm	Extras: Pre-wash  , Pre-rinse 	Rinse cycles: 3	



Outdoor

Down Items		30°C to 60°C	Maximum 1 item
Items	Outdoor jackets, sleeping bags, pillows and other down-filled items		
Notes	<ul style="list-style-type: none"> - Do not use fabric softener. - Remove any air before washing. To do this, either push the items into a narrow laundry bag to compress them or tie the items together with a washable strap. - Observe the instructions on the care label. - The items are spun after wetting to remove any air. 		
1400 rpm	Extra options: Pre-wash  , Rinse plus 	Rinse cycles: 2	

Programme chart





Outerwear		Cold to 40°C	Max. load 3.0 kg
Items	Performance outerwear (e.g. outdoor jackets and pants) made from membrane fabrics such as Gore-Tex [®] , SYMPATEX [®] , WINDSTOPPER [®] etc.		
Notes	<ul style="list-style-type: none"> - Close any zips and Velcro fasteners before washing. - Do not use fabric softener. - To maintain the water repellency of the textiles, it may be necessary to proof them again after washing. Select the <i>Proofing</i> programme for this purpose. - Wash down-filled items with the <i>Down Items</i> programme. 		
1000 rpm	Extra options: Pre-wash  , Rinse plus 	Rinse cycles: 2	
Proofing		30°C to 40°C	Max. load 3.0 kg
Items	To refresh the proofing of water-repellent textiles, e.g. rainwear, ski wear or other textiles.		
Notes	<ul style="list-style-type: none"> - Add proofing agent to the  compartment. - The items should be freshly laundered and spun or dried before proofing. - For best results, the items should be heat-treated afterwards either in a tumble dryer or by ironing. 		
800 rpm		Rinse cycles: 1	

Wellness/Hair salons

Towels		40°C	Max. load 5.5 kg
Items	Lightly soiled cotton towelling		
Notes	- Use a colour detergent for dark textiles.		
1400 rpm		Rinse cycles: 2	
Towels plus		40°C to 80°C	Max. load 5.5 kg
Items	Heavily soiled cotton towelling		
Notes	- Use a colour detergent for dark textiles.		
1400 rpm	Extras: Pre-wash 	Rinse cycles: 2	
Capes		Cold to 30°C	Max. load 2.0 kg
Items	Lightly soiled hairdressers' capes made from synthetic fibres		
Notes	- Select the <i>Rinse plus Extra</i> for particularly good wash results		
600 rpm	Extras: Rinse plus 	Rinse cycles: 2	





Programme chart

Hotel

Bed linen		40°C to 90°C	Max. load 7.0 kg
Items	Cotton or mixed fibre bed linen		
Notes	<ul style="list-style-type: none"> - The items are always soaked after the start. - Use a colour detergent for coloured textiles. 		
1200 rpm	Extras: Pre-wash  , Pre-ironing 	Rinse cycles: 2	
Table linen		40°C to 75°C	Max. load 3.5 kg
Items	Tablecloths and napkins made from cotton, linen, and mixed fibres		
Notes	<ul style="list-style-type: none"> - Select <i>Pre-wash</i> for stubborn stains. Use detergent with enzymes for the pre-wash. - The items are always soaked after the start. 		
1200 rpm	Extras: Pre-wash  , Pre-ironing 	Rinse cycles: 2	
Kitchen laundry		60°C to 85°C	Max. load 7.0 kg
Items	Cotton or linen kitchen laundry, e.g. chef's jackets and trousers, chef's hats, cleaning cloths		
Notes	<ul style="list-style-type: none"> - Select <i>Pre-wash</i> for stubborn stains. Use detergent with enzymes for the pre-wash. - The pre-wash cycle removes any coarse soiling. 		
1400 rpm	Extras: Pre-wash 	Rinse cycles: 3	

Programme chart





Home textiles

Lightweight curtains		Cold to 40°C	Max. load 3.5 kg
Items	Curtains specified as machine-washable by the manufacturer		
Notes	- For curtains which crease easily, deselect the spin speed.		
600 rpm	Extras: Pre-wash  , Rinse plus 		Rinse cycles: 2
Down bedding		40°C to 75°C	1 duvet or 1–2 pillows*
Items	Down-filled pillows and duvets		
Notes	<ul style="list-style-type: none"> - Remove any air before washing. To do this, either push the items into a narrow laundry bag to compress them or tie the items together with a washable strap. - Observe the instructions on the care label. - The items are spun after wetting to remove any air. 		
1400 rpm	Extra options: Rinse plus 		Rinse cycles: 2
Synthetic bedding		40°C to 75°C	Max. 7.0 kg or 1 duvet or 1–2 pillows*
Items	Bed linen made from microfibre, pillows and duvets with a synthetic filling		
Notes	<ul style="list-style-type: none"> - Observe the instructions on the care label. - Use liquid detergent. 		
800 rpm	Extras: Pre-wash  , Rinse plus 		Rinse cycles: 2



* 1 pillow (80 x 80 cm) or 2 pillows (40 x 80 cm)

Programme chart







Workwear

Oil/fat special		60°C to 90°C	Max. load 7.0 kg
Items	Work coats, work jackets, hats, cleaning cloths made from cotton or mixed fibres		
Notes	<ul style="list-style-type: none"> - Activate <i>Pre-wash</i> for heavy soiling. - Use liquid detergent. 		
1400 rpm	Extras: Pre-wash 		Rinse cycles: 3
Dust/flour special		40°C to 90°C	Max. load 7.0 kg
Items	Cotton or mixed fibre workwear, table cloths, or cleaning cloths soiled with dust or flour		
Notes	<ul style="list-style-type: none"> - The automatic pre-rinse removes any coarse soiling. Add a second pre-rinse for very heavy levels of soiling. - Select <i>Pre-wash</i> for stubborn stains. 		
1400 rpm	Extras: Pre-wash  , Pre-rinse 		Rinse cycles: 3
Intensive wash		40°C to 90°C	Max. load 7.0 kg
Items	Heavily soiled workwear made from cotton, linen, and mixed fibres		
Notes	- A particularly good wash and rinse result is achieved by a high water level.		
1400 rpm	Extras: Pre-wash 		Rinse cycles: 2

Disinfection I

Disinfection		85 °C/15 min	Max. load 7.0 kg
Items	Cotton or mixed fibre textiles		
Tip	<ul style="list-style-type: none"> - Thermal disinfection with a 15-minute holding time at 85 °C. - A second disinfection rinse can be activated via the supervisor level. - No water inlet via the fabric softener compartment 		
1400 rpm	Extras: Pre-wash  , Rinse plus 		Rinse cycles: 2

Programme chart

 Disinfection		60°C/20 min	Max. load 7.0 kg
Items	Workwear or disinfection clothing, sorted by colour, provided the items are suitable for disinfection.		
Notes	<ul style="list-style-type: none"> - Chemo-thermal disinfection with a 20-minute holding time at 60°C. - A second disinfection rinse can be activated via the Supervisor level. - No water inlet via the fabric softener compartment. 		
1400 rpm	Extras: Pre-wash  , Rinse plus 	Rinse cycles: 2	
 Disinfection		40°C/20 min	Max. load 7.0 kg
Items	Workwear or disinfection clothing, sorted by colour, provided the items are suitable for disinfection.		
Notes	<ul style="list-style-type: none"> - Chemo-thermal disinfection with a 20-minute holding time at 40°C. - No water inlet via the fabric softener compartment. - Due to the particularly gentle washing process, even more delicate textiles can be washed in this programme. 		
1400 rpm	Extras: Pre-wash  , Rinse plus 	Rinse cycles: 2	

Extras

You can supplement the wash programmes with Extras.

Not all Extras can be selected with every programme. If an Extra is not listed, it is not permitted for use with this wash programme.

Selecting Extras

For some programmes, an Extra is offered directly in the main menu.

- Touch the sensor of the Extra to activate it.

For some programmes, Extras are selected in the *Extras* submenu.

- Touch the *Extras*  sensor.
- Select one or two of the Extras available.

Pre-wash





A pre-wash can be added for heavily soiled laundry. Coarse soiling is loosened and removed before the main wash.

Pre-rinse

The laundry is rinsed before the main wash to remove larger quantities of soiling, e.g. dust, sand.

Pre-ironing

In order to reduce creasing, the laundry undergoes a smoothing process at the end of the programme. For optimal smoothing reduce the maximum load by 50%. Small loads achieve a better result.

The textiles must be suitable for drying in a tumble dryer   and suitable for ironing  .

Rinse plus

An additional rinse cycle can be activated to achieve a particularly good wash result.

Special features in the programme sequence

Spinning

Final spin speed

When a programme is selected, the maximum spin speed for this wash programme is shown in the display.

You can reduce the final spin speed.

However, you cannot select a final spin speed higher than that shown in the chart.

Interim spin

There is a spin cycle after the main wash and between the rinses. A reduction in the final spin speed will also reduce the interim spin speed accordingly.

Deselecting the interim spin and the final spin

- Select the programme setting *Spin speed 0*.

After the last rinse cycle, the water will be pumped away and the anti-crease phase will switch on.

Anti-crease

At the end of the programme, the drum continues to turn at intervals for up to 30 minutes to help prevent creasing. The door can be opened at any time during the anti-crease phase.

There is no anti-crease phase at the end of some programmes.
--

Changing the programme sequence

A programme cannot be cancelled or changed when operating a payment system.

Changing a programme

After the start of a programme, it is no longer possible to select a different programme.

You will need to cancel the current programme before you can select a different one.

If the programme selector is changed, Programme change not possible will appear in the display. The text disappears when the programme selector is set to the original programme.

Cancelling a programme

You can cancel a programme at any time after it has started.

Disinfection programmes can only be cancelled with a PIN code.

- Touch the *Start/Stop* sensor.
- Select Cancel programme.

The suds will be pumped away. The programme is cancelled. The door lock is released.

- Pull open the door.
- Remove the laundry.

If you want to select a different programme:

- Close the door.
- Select the required programme.
- Add detergent to the detergent dispenser drawer, if necessary.
- Touch the *Start/Stop* sensor.

The new programme will start.

Switching on the washing machine after an interruption to the power supply

If the washing machine is switched off with the Ⓛ button during a wash programme, the programme will be interrupted.

- Switch it back on with the Ⓛ button.
- Note the message in the display.
- Touch the *Start/Stop* sensor.

The programme will also be interrupted if power is interrupted by a power cut.

- When power is restored, confirm the message in the display with *OK*.
- Touch the *Start/Stop* sensor.

The programme will continue.

Changing the programme sequence

Adding or removing laundry

You can add or remove items during the first few minutes after the programme has started.

- Touch the *Start/Stop* sensor.

The following will appear in the display:



- Touch the *Add laundry* sensor.

The programme will stop and the door will unlock.

 Risk of chemical burns from detergent.

When adding or removing laundry during the main wash, your skin may come into contact with detergent, particularly if the detergent is dispensed externally.

Take care when placing your hands inside the drum.

If suds have come into contact with the skin, rinse off immediately with lukewarm water.

- Pull open the door.
- Add laundry or remove individual items.
- Close the door.
- Touch the *Start/Stop* sensor.

The wash programme will continue.

Once a programme has started successfully, the washing machine cannot recognise any adjustment to the load.

For this reason, if laundry is added or removed after the start of a programme, the machine will always complete the programme cycle assuming a full load.

The door cannot be opened, if:

- The suds temperature is above 55°C.



The safety lock will remain activated if the temperature in the drum is above 55°C. The lock will not deactivate until the temperature has dropped to below 55°C.

Detergent

The correct detergent

Any detergent suitable for automatic front loading washing machines can be used with this appliance. Follow the manufacturer's instructions and dosage recommendations on the packaging.

The recommendations apply to the temperature ranges given in the Programme chart.

	Universal	Colour	Delicates and woollens	Special
	Detergent			
Cottons	✓	✓	–	–
Cottons 	✓	✓	–	–
Express	–	✓ ¹	–	–
Minimum iron	–	✓	–	–
Delicates	–	–	✓	–
ECO 40-60	✓	✓	–	–
Bedding and towelling	✓	✓ ¹	–	–
Shirts	✓	✓	–	–
Dark garments	–	✓ ¹	–	–
Denim	–	✓ ¹	–	–
Woollens 	–	–	✓	✓
Silks 	–	–	–	✓

✓ Recommended

– not recommended

¹ Liquid detergent

⚠ Risk of electric shock!
Only ever perform cleaning and maintenance work when the appliance is disconnected from the power.
Disconnect the washing machine from the mains electricity supply.

Cleaning the external casing and fascia panel

⚠ Damage caused by cleaning agents.
Solvent based cleaning agents, abrasive cleaners, glass cleaners or multi-purpose cleaning agents can cause damage to plastic surfaces and other parts.
Do not use any of these cleaning agents.

⚠ Risk of damage due to ingress of water.
The pressure of a water jet can cause water to get into the washing machine, resulting in damage to components.
Do not spray the washing machine with a water jet.

- Clean the casing and control panel with a mild cleaning agent or soap and water and dry both with a soft cloth.
- The drum and other stainless steel parts can be cleaned using a suitable stainless steel cleaning agent.

Cleaning the detergent dispenser drawer

Washing at low temperatures and the use of liquid detergent can lead to a build-up of mould and bacteria in the detergent dispenser drawer.

- For hygiene reasons, clean the entire drawer at regular intervals.

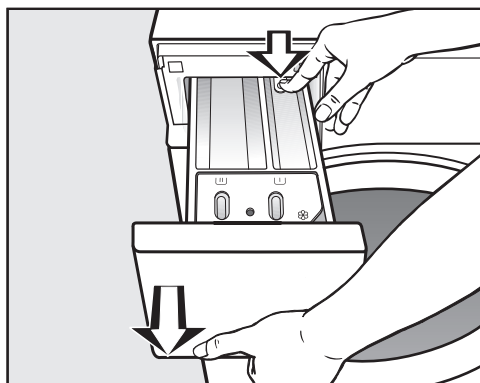

- Pull out the detergent dispenser drawer until a resistance is felt. Press down the release button and at the same time pull the drawer right out of the machine.
- Clean the detergent dispenser drawer with warm water.

Cleaning and care

Cleaning the siphon and the channel

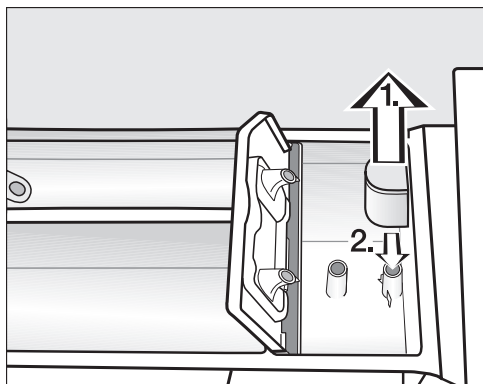

- Pull the siphon out of the ☒ compartment. Clean the siphon under warm running water. Clean the siphon tube in the same way.
- Refit the siphon.

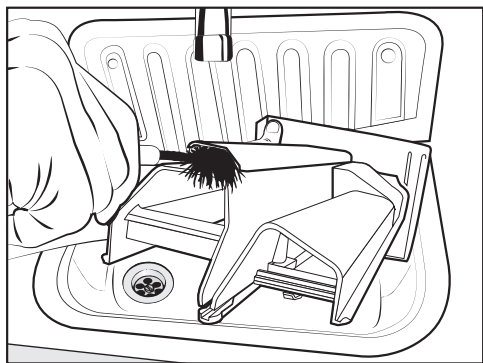

- Clean the fabric softener channel using a brush and warm water.

Cleaning the detergent dispenser drawer housing

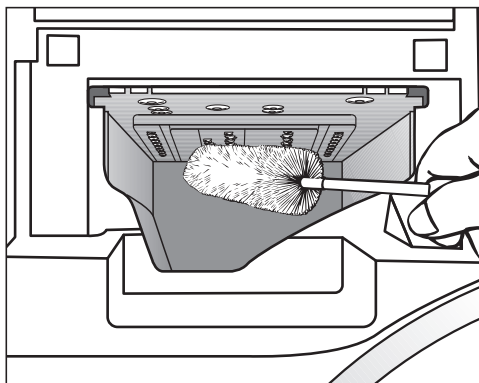

- Use a bottle brush to remove detergent residues and limescale from the jets inside the detergent dispenser drawer housing.
- Replace the detergent dispenser drawer.

Useful tip: Leave the detergent dispenser drawer slightly open to allow it to dry.

Cleaning the drum, suds container and drainage system

By using wash programmes of 60°C or more on a regular basis and using a multi-purpose detergent, you can avoid the build-up of bacteria in the washing machine.

Regularly use the *Clean machine* programme, especially if you frequently use wash programmes with low temperatures.

Optimum results can be achieved by using a machine cleaner. Alternatively, a multi-purpose powder detergent can be used.

- Start the *Clean machine* programme.
- Dispense the machine cleaner or multi-purpose detergent directly into the drum.
- Do **not** load any laundry. The drum must be empty for the cleaning process.
- At the end of the programme, check the inner drum and remove any coarse residues.

Use the *Clean machine* programme regularly if you frequently use disinfection programmes.

Cleaning the sealing ring

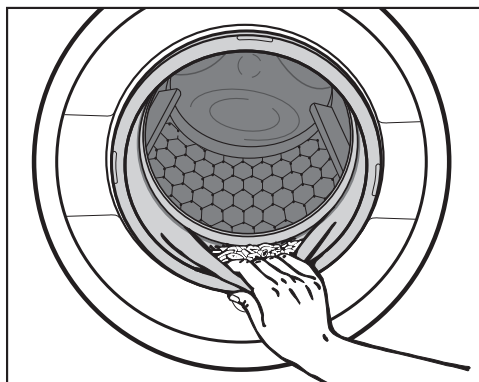

- Check the fold in the sealing ring for foreign objects.
- Clean the sealing ring and the inner fold of the sealing ring with a damp cloth.

Useful tip: For safety reasons, close the door when the machine is not in use. Otherwise there is a danger of objects being placed inadvertently in the drum. If these remain unnoticed and were washed in the next load, they could damage the laundry. An open door is also a danger to pets and children.

Cleaning and care

Cleaning the filters in the water inlet

The washing machine has filters to protect the water inlet valves. Check these filters about every 6 months or more often if there are frequent interruptions to the external water supply.

Cleaning the filters in the inlet hoses

- First turn off the tap.
- Unscrew the inlet hose.
- Remove the rubber seal from the recess.
- Using combination or pointed pliers, take hold of the plastic filter bar and remove the filter.
- Clean the plastic filter.
- Reassemble the filter and seal in the reverse order and reconnect the hose.

Make sure there is no water leaking from the threaded union.
Tighten the threaded union.

Cleaning the filters in the water inlet valves

- Using pliers, carefully loosen the ribbed plastic nut on the inlet valve and unscrew.

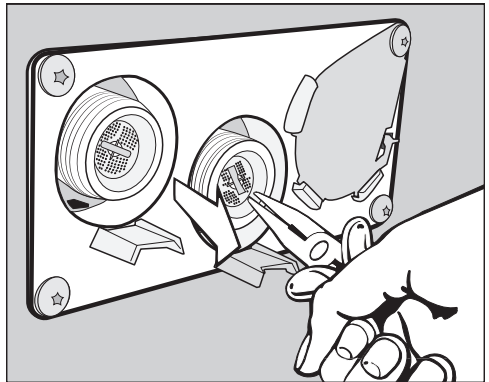



- Withdraw the filter at the bar with pointed pliers and rinse it clean under running water. Reassemble the filter and seal in the reverse order and reconnect the hose.

Replace the filters after cleaning.

With the help of the following guide, minor faults in the performance of the appliance, some of which may result from incorrect operation, can be remedied without contacting Miele. This will save you time and money because you will not need a service call.





Please note, however, that a call-out charge will be applied to unnecessary service visits where the problem could have been rectified as described in these operating instructions.

The programme does not start

Problem	Possible cause and remedy
The display remains dark and the <i>Start/Stop</i> sensor does not light up or flash.	There is no power to the machine. <ul style="list-style-type: none"> ■ Check whether the washing machine is switched on. ■ Check whether the washing machine is connected to the electricity supply. ■ Check whether the circuit breaker has tripped.
	The washing machine has switched off automatically to save energy. <ul style="list-style-type: none"> ■ Switch it back on with the  button.
The following appears in the display:  Door will not lock. Call Miele.	The door is not closed properly. The door lock could not engage. <ul style="list-style-type: none"> ■ Close the door again. ■ Start the programme again. If the fault message appears again, contact Miele.
The programme does not start when <i>Spin</i> is selected.	You have not yet completed the initial commissioning process. <ul style="list-style-type: none"> ■ Follow the instructions in the section <i>Completing the commissioning process</i> in these instructions.
The display is dark and the <i>Start/Stop</i> sensor is flashing slowly.	The display has switched off automatically to save energy. <ul style="list-style-type: none"> ■ Touch any sensor. The display will switch on again.

Problem solving guide

Programme cancellations and fault messages

Problem	Possible cause and remedy
 Drainage fault. Clean drain filter and pump. Check the drain hose.	The water outlet is blocked or restricted. The drain hose has been fixed too high. <ul style="list-style-type: none"> ■ Clean the filters and the drain pump. ■ The maximum drain height is 1 m.
 Water intake fault. Turn on the tap.	The water inlet is blocked or restricted. <ul style="list-style-type: none"> ■ Check whether the tap is turned on properly. ■ Check whether the inlet hose is kinked.
	The water pressure is too low. <ul style="list-style-type: none"> ■ Switch on the Low water pressure setting (see “Supervisor level - Low water pressure”).
	The filters in the water inlet are blocked. <ul style="list-style-type: none"> ■ Clean the filters (see “Cleaning and care - Cleaning the filters”).
 Waterproof system activated	The water protection system has reacted. <ul style="list-style-type: none"> ■ Turn off the tap. ■ Call Miele.
 Disinfection temperature not reached	The required temperature was not reached during the disinfection programme. <ul style="list-style-type: none"> ■ The washing machine has not carried out the disinfection cycle correctly. ■ Start the programme again.
 Fault F. If restart fails, call Miele.	There is a fault. <ul style="list-style-type: none"> ■ Disconnect the washing machine from the mains electricity supply. ■ Wait at least 2 minutes before reconnecting the washing machine to the electricity. ■ Then switch the washing machine on again. ■ Start the programme again. If the fault message appears again, contact Miele.

A fault message appears in the display¹

Problem	Possible cause and remedy
i Dispenser container empty	One of the detergent containers for external dosing is empty. ■ Refill the detergent containers.
i Container 1 empty	External detergent container 1 is almost empty. The message can refer to containers 1 to 6. ■ Refill the detergent container. ■ Reset the container's early-warning counter (see "Supervisor level - Early-warning counter").
i Check hot water intake	The hot water supply is blocked or restricted. ■ Check whether the hot water tap is turned on properly. ■ Check whether the inlet hose is kinked.
i Align the machine. Laundry not properly spun.	The selected spin speed was not reached during the final spin due to excessive imbalance. ■ Check that the washing machine is standing level. ■ Start the spin cycle again.
i Machine is leaking	The washing machine or the drain valve is leaking. ■ Turn off the tap. ■ Call Miele.
i Machine can no longer be net-worked. Please call Miele.	Miele@home is not available. ■ Switch off the washing machine. ■ Then switch the washing machine on again. ■ If the message appears again, contact Miele. The washing machine can continue to be used. ■ Touch the <i>OK</i> sensor.

¹ The messages will appear at the end of the programme and when the washing machine is switched on and need to be confirmed with the *OK* sensor.

Problem solving guide

An unsatisfactory wash result

Problem	Possible cause and remedy
Liquid detergent does not give the required result.	<p>Liquid detergents usually contain no bleaching agents. They do not remove fruit, coffee and tea stains.</p> <ul style="list-style-type: none">■ Use a general purpose powder detergent containing a bleaching agent.■ Add stain removers to compartment  of the detergent dispenser drawer and fill liquid detergent into a dispenser ball.■ Never put stain removers and liquid detergent together in the dispenser drawer.
White residues which look like powder detergent are seen on dark textiles after washing.	<p>The detergent contains compounds (zeolites) to aid water softening which are not soluble in water. These have ended up on the laundry.</p> <ul style="list-style-type: none">■ Try to brush off the residues with a soft brush once the laundry is dry.■ Wash dark textiles using a detergent which contains no zeolites. Liquid detergents do not usually contain zeolites.
Textiles that were very greasy are not properly clean.	<ul style="list-style-type: none">■ Select a programme with pre-wash. Use liquid detergent for the pre-wash.■ Continue to use universal powder detergent for the main wash.
	<p>The use of heavy-duty detergent is recommended in the main wash for very heavily soiled work clothing. Please seek advice from the detergent manufacturer.</p>
Grey, greasy particles cling to washed laundry.	<p>Insufficient amounts of detergent were used. The laundry was heavily soiled with grease (oils, ointments).</p> <ul style="list-style-type: none">■ Use more detergent or liquid detergent with this type of soiled laundry.■ Before washing the next load, run a 60°C programme with liquid detergent but without a load.



General problems with the washing machine

Problem	Possible cause and remedy
The machine shakes during the spin cycle.	The machine feet are not level. <ul style="list-style-type: none"> ■ Level the machine and adjust the feet correctly.
The pump makes strange noises.	This is not a fault. Slurping noises occur at the end of the pump sequence as a normal part of operation.
Large amounts of detergent residue remain in the detergent dispenser drawer.	The water pressure is too low. <ul style="list-style-type: none"> ■ Clean the filters in the water inlet.
	Powder detergent used in conjunction with water softeners tends to become sticky. <ul style="list-style-type: none"> ■ Clean the detergent dispenser drawer and, in the future, add washing powder to the dispensing drawer first, and then add the water softener.
Fabric softener is not completely dispensed or too much water remains in the  compartment.	The siphon tube is not correctly positioned or clogged. <ul style="list-style-type: none"> ■ Clean the siphon (see “Cleaning and care - Cleaning the detergent dispenser drawer”).
The display is in a different language.	A different language has been selected. <ul style="list-style-type: none"> ■ Switch the washing machine off and then on again. The set operator language will appear in the display.
	The operator language has been changed. <ul style="list-style-type: none"> ■ Select the language you require (see “Supervisor level - Language”).
The washing machine did not spin the laundry as usual. The laundry is still wet.	The machine detected an imbalance during the final spin and reduced the spin speed automatically. <ul style="list-style-type: none"> ■ Include both large and small items in the load as this will give better distribution.
At the end of the programme there is still liquid in the capsule.	The small pipe in the detergent dispenser drawer onto which the capsule is placed is blocked. <ul style="list-style-type: none"> ■ Clean the small pipe.
	This is not a fault. For technical reasons a small amount of water will remain in the capsule.

Problem solving guide

Problem	Possible cause and remedy
There is water next to the capsule in the fabric softener compartment.	<p>The <i>CapDosing</i> sensor was not activated or an empty capsule was not removed at the end of the last wash programme.</p> <ul style="list-style-type: none">■ Activate the <i>CapDosing</i> sensor when a capsule is used the next time.■ Remove and dispose of the empty capsule at the end of each programme. <p>The small pipe in the detergent dispenser drawer onto which the capsule is placed is blocked.</p> <ul style="list-style-type: none">■ Clean the small pipe.
The drum remains stationary but the programme keeps running.	<ul style="list-style-type: none">■ Switch the washing machine off and then back on with the ⏻ button.■ Note the message in the display.■ Touch the <i>Start/Stop</i> sensor. <p>The programme will continue and the drum will spin.</p>

The door will not open

Problem	Possible cause and remedy
<p>The door cannot be pulled open during a programme.</p>	<p>The door is locked during the washing process.</p> <ul style="list-style-type: none"> ■ Touch the <i>Start/Stop</i> sensor. ■ Select Cancel programme or Add laundry. <p>The door will unlock and you will be able to pull it open.</p> <hr/> <p>There is still water in the drum and the machine is unable to drain.</p> <ul style="list-style-type: none"> ■ Clean the drain system as described in “Opening the door in the event of a blocked drain outlet and/or power cut”.
<p> Programme cancelled appears in the display at the end of a programme or after a programme has been cancelled.</p>	<p>For safety reasons, the door cannot be opened if the suds temperature is higher than 55°C.</p> <ul style="list-style-type: none"> ■ Wait until the temperature in the drum has decreased and the message has gone out in the display.
<p>The following appears in the display:  The door lock is jammed. Call Miele.</p>	<p>The door lock has jammed.</p> <ul style="list-style-type: none"> ■ Call Miele.

Problem solving guide

Opening the door in the event of a blocked drain outlet and/or power cut

⚠ Risk of electric shock!
Only ever perform cleaning and maintenance work when the appliance is disconnected from the power.
Disconnect the washing machine from the mains electricity supply.

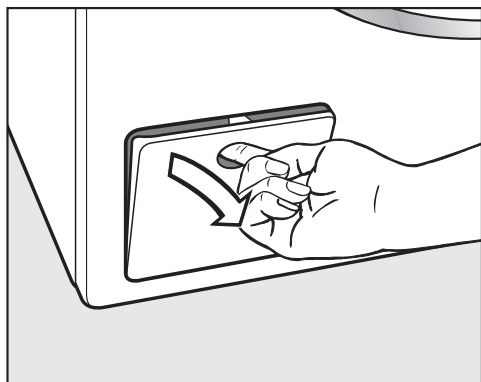

- Open the access panel to the drain system.

Blocked drain outlet

If the drain outlet is blocked, a larger quantity of water (max. 30 l) can remain in the washing machine.

⚠ Risk of scalding due to hot suds.
Escaping suds will be hot if laundry has been washed at high temperatures shortly before.
Drain the suds carefully.

Emptying the drum

....in machines with a drain pump

- Place a suitable container under the access flap.

Remove the drain filter, though not completely.

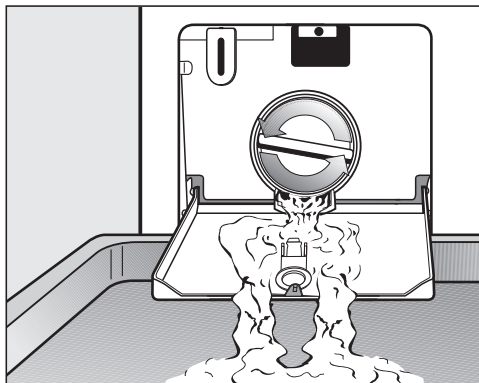

- Slowly and carefully unscrew the filter to let the water out. Be careful not to release too much water at once. If the flow of water is too strong, some water can seep into the washing machine base and activate the water protection float switch. This will prevent the washing machine from functioning.
- Tighten the drain filter back up again if you need to interrupt the flow of water.

Cleaning the drain filter

Once the flow of water ceases:

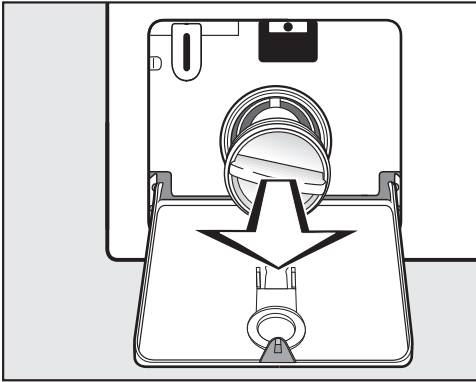

- Remove the drain filter completely.
- Clean the drain filter thoroughly.

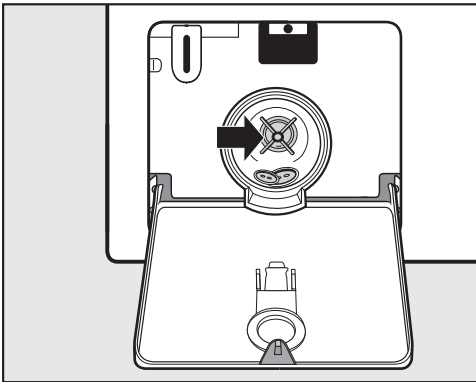

- Check the drain pump impellers to make sure they can rotate freely.
- Remove any foreign objects (e.g., buttons, coins etc.) and clean the interior.
- Put the drain filter back in place and secure it.

 Risk of water damage.

Make sure the drain filter is securely tightened. Otherwise there is a risk of water leakage during use.

Replace the drain filter correctly and tighten it securely.

Opening the door

 Danger of injury due to rotating drum!

Reaching into a moving drum is extremely dangerous. Danger of injury!

Always make sure that the drum is stationary before reaching in to remove laundry.

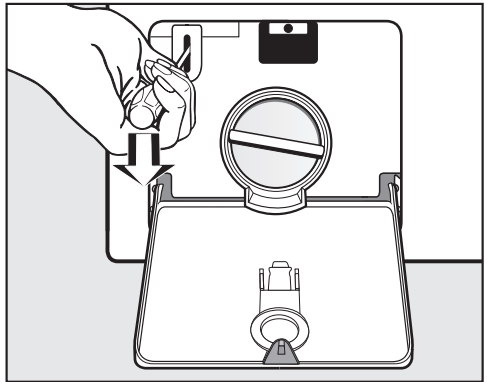

- Use a screwdriver to unlock the door of the washing machine as shown.
- Pull open the door.

Problem solving guide

Emptying the drum

...in machines with a drain valve

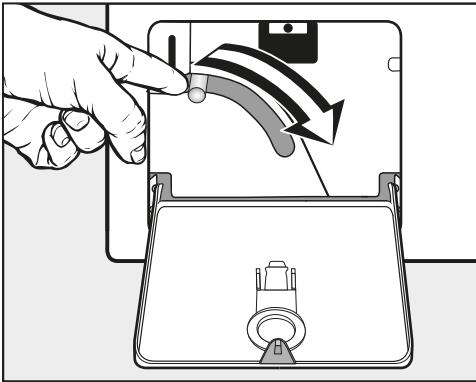

- Push the emergency drain lever downwards and hold until no more water runs out.

Opening the door

⚠ Danger of injury due to rotating drum!

Reaching into a moving drum is extremely dangerous. Danger of injury!

Always make sure that the drum is stationary before reaching in to remove laundry.

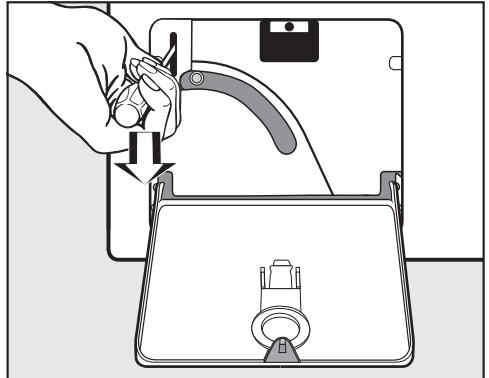

- Use a screwdriver to unlock the door of the washing machine as shown.
- Pull open the door.

Contact in case of fault

In the event of any faults which you cannot remedy yourself, please contact Miele.

Contact information for Miele can be found at the end of this booklet.

Please quote the model and serial number of your appliance when contacting Miele. This information can be found on the data plate.

The data plate is found above the porthole glass when the washing machine door is opened:

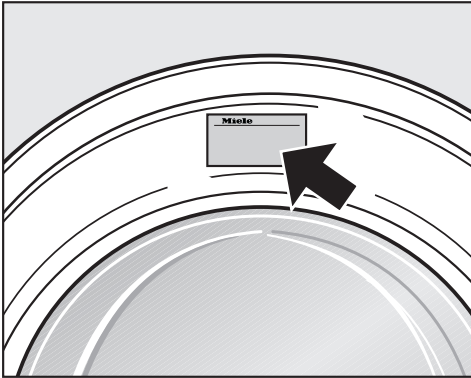

Optional accessories

Optional spare parts and accessories for this washing machine are available from Miele.

Maintenance

Preventive maintenance supports fault-free operation and prevents unnecessary repairs.

Miele recommends regular maintenance by Miele Customer Service.

Installation

Front view

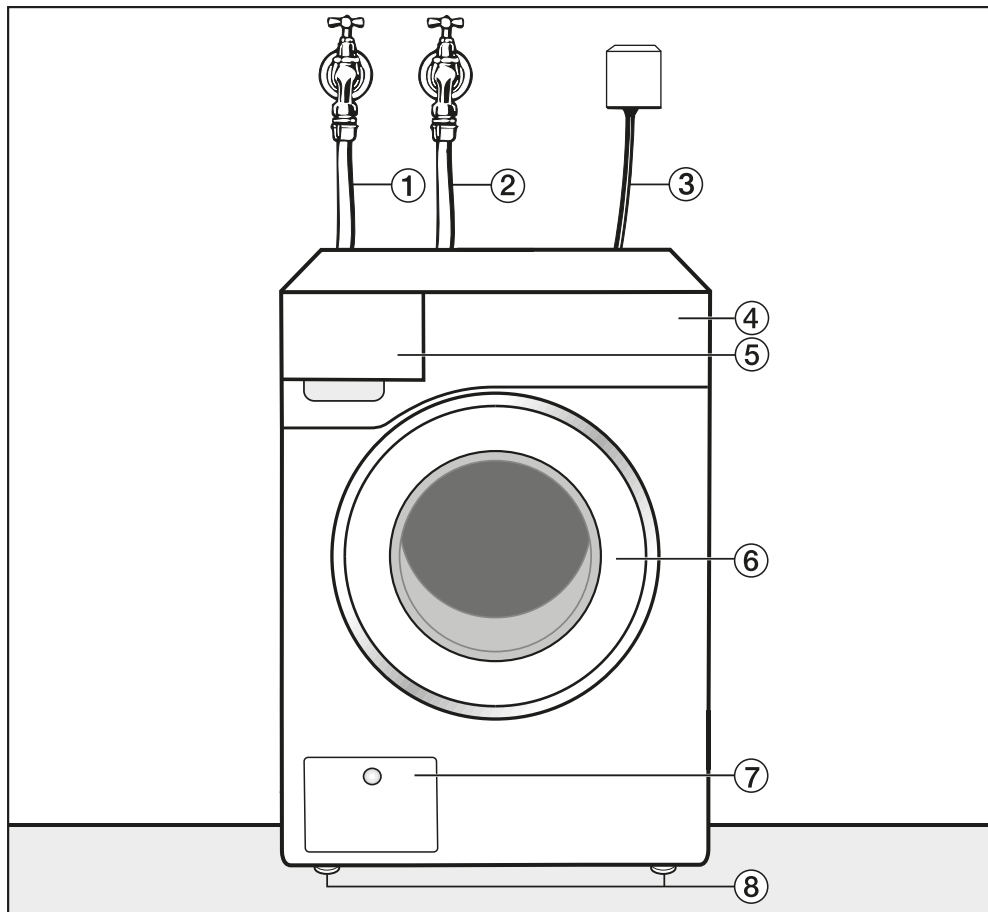

① Cold water inlet hose

② Hot water inlet hose

③ Electrical connection

④ Control panel

⑤ Detergent dispenser drawer

⑥ Door

⑦ Access to drain filter, drain pump or valve and emergency release

⑧ Height-adjustable feet

Rear view

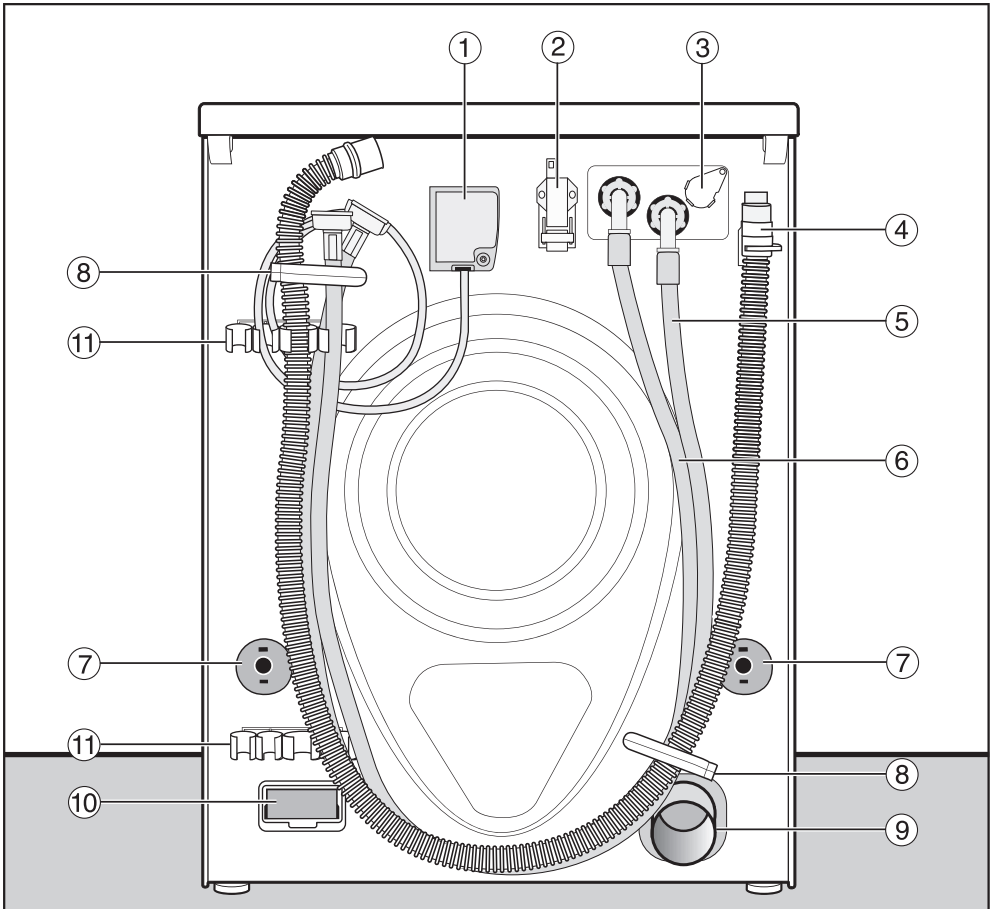

- | | |
|---|---|
| ① Electrical connection | ⑦ Safety caps for transit bars |
| ② Interface for communicating with external devices | ⑧ Transport clips for hoses |
| ③ Socket for external dispensing system | ⑨ Drain pipe (DV version) |
| ④ Drain hose (DP version) | ⑩ Module slot (for external communication module) |
| ⑤ Inlet hose (cold water) | ⑪ Holder for removed transit bars |
| ⑥ Inlet hose (hot water), if fitted | |

Installation

Installation locations

Side view

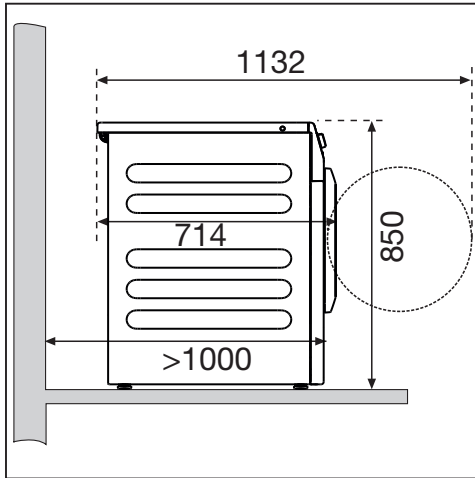

⚠ Installing the washer-dryer stack on a Miele plinth is not permitted.

Installation on a raised plinth

The washing machine can be installed on a steel plinth (open or closed, available as an optional Miele accessory) or on a concrete plinth.

⚠ Injury can occur if the washing machine has not been adequately secured.

When installed on a plinth, there is a risk that the washing machine will move and fall from the plinth during spinning.

Secure the washing machine using the clamps supplied.

Washer-dryer stack

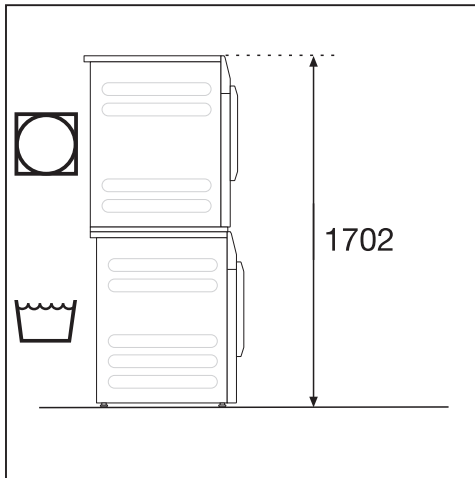

This washing machine can be installed with a Miele tumble dryer on top of it. This requires a Miele washer-dryer stacking kit which can be purchased separately.

Installation notes

The distances between the machine and the wall are recommended for making service work easier. If installation space is limited, the washing machine can also be pushed up against the wall.

This washing machine is not suitable for building under.

⚠ Risk of damage due to moisture ingress.

Moisture can damage electrical components.

Do not install the washing machine near or directly above an open gully or floor drain.

Transporting the washing machine to its installation site

⚠ Danger of injury from incorrect transport.

If the washing machine tips over, there is a danger of injury to people and damage to property.

When transporting the machine, make sure that it is stable.

Transporting the washing machine with a hand trolley

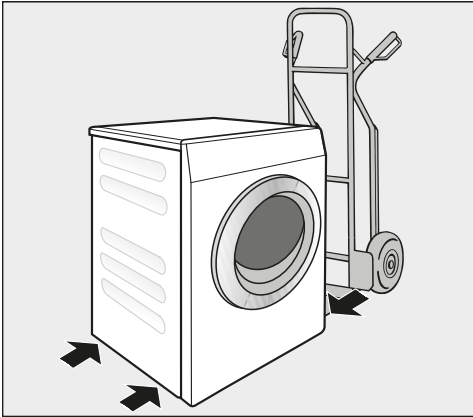

- If transporting the washing machine with a hand trolley, make sure only its left or right side is resting on the trolley.

⚠ Risk of damage from incorrect transport.

The front or back of the washing machine may be damaged if the machine is transported on a hand trolley.

Always transport the washing machine on its side on a hand trolley.

Transporting the washing machine to its installation site

The protruding lid can be used for holding the machine during transport.

⚠ Danger of injury due to unsecured lid.

Make sure the fixings at the back of the lid are secure. They may become brittle due to external circumstances. There is a danger of the lid being pulled off when carrying the appliance.

Before carrying the appliance, check that the lid is secure where it protrudes at the back.

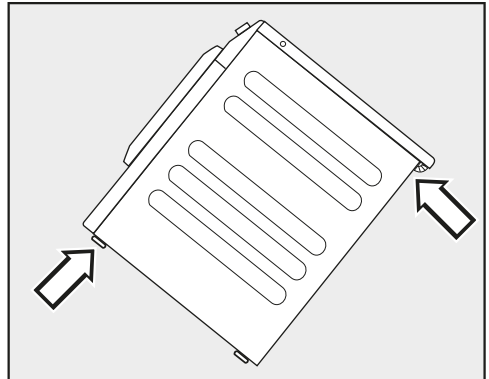

- Carry the washing machine by the front feet and by the lid where it protrudes at the back of the appliance.

Installation surface

A concrete floor is the most suitable installation surface. It is far less prone to vibration during the spin cycle than wooden floorboards or a carpeted surface.

Installation

- The machine must be level and securely positioned.
- To avoid vibrations during spinning, the machine should not be installed on soft floor coverings.

If installing on a wooden joist floor:

- Install the machine on a plywood base (at least 70 x 60 x 3 cm). The base should span several joists and be bolted to the joists and not only to the floorboards.

Useful tip: If possible, install the machine in a corner of the room. This is usually the most stable part of the floor.

Removing the transit bars

Removing the left transit bar

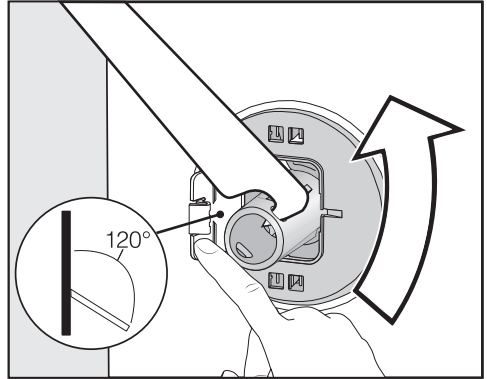

- Push the cover out and turn the transit bar 90° using the open spanner supplied.

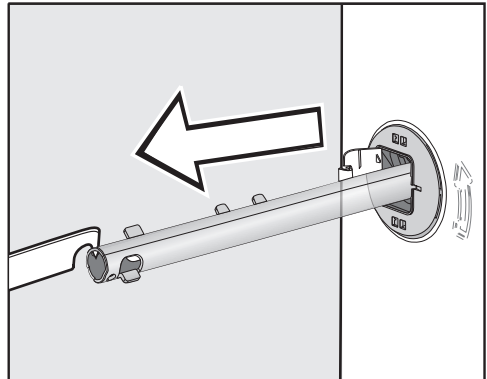

- Then pull the transit bar out.

Removing the right transit bar

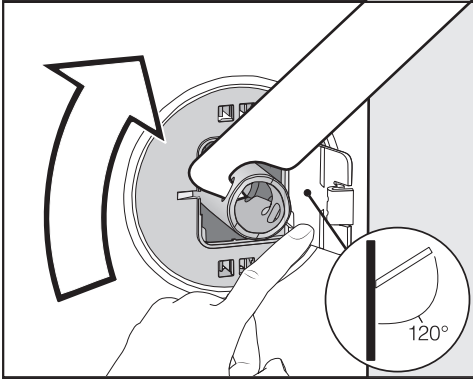

- Push the cover out and turn the transit bar 90° using the open spanner supplied.

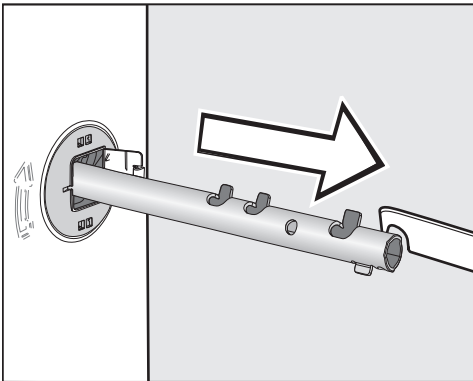

- Then pull the transit bar out.

Covering the holes

⚠ Risk of injury from sharp edges!
There is a risk of injury from reaching into holes that are not covered.
The holes for the transit bars must be covered after the transit bars have been removed.

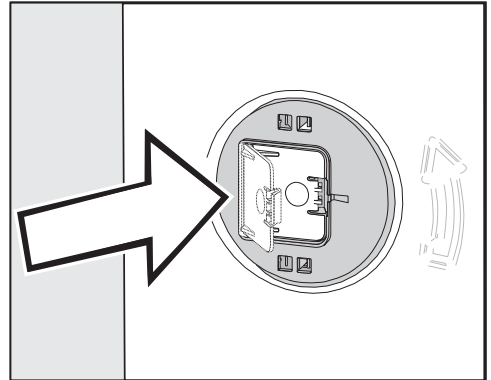

- Press the covers firmly shut until they click into place.

Installation

Securing the transit bars

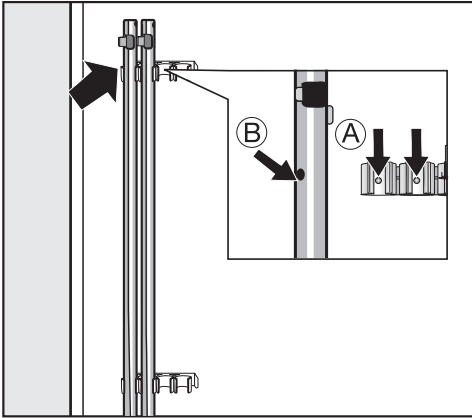

- Secure the transit bars to the back of the washing machine.

Useful tip: Make sure that the holes (B) are fitted over the retainers (A).

 Risk of damage from incorrect transport.

The washing machine may be damaged if moved without the transit bars in place.

Keep the transit bars in a safe place. Fit them again if the washing machine is to be moved (e.g. when moving house).

Fitting the transit bars

Opening the flaps

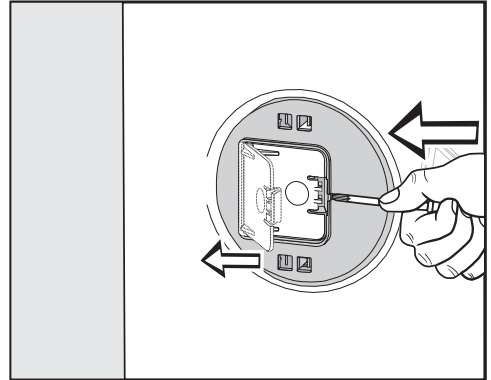

- Push against the catch with a pointed object, e.g. a narrow screwdriver.

The flap will open.

Fitting the transit bars

- Install the transit bars in reverse order to their removal.

Useful tip: If you lift the drum slightly, the transit bars can be pushed in more easily.

Aligning the washing machine

The washing machine must stand perfectly level on all four feet to ensure safe and proper operation.

Incorrect installation may increase electricity and water consumption and may cause the machine to move about.

Screwing out and adjusting the feet

The four adjustable screw feet are used for levelling the washing machine. All four feet are screwed in when the appliance is delivered.

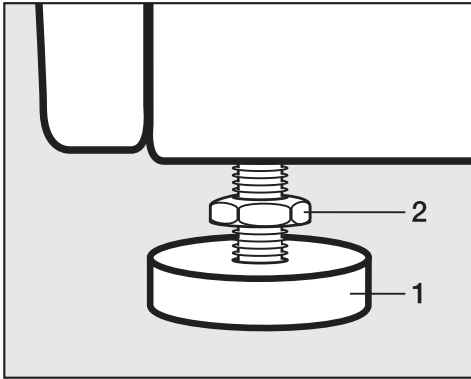

- Using the spanner supplied, turn counter nut **2** in a clockwise direction. Then turn counter nut **2** together with foot **1** to unscrew.

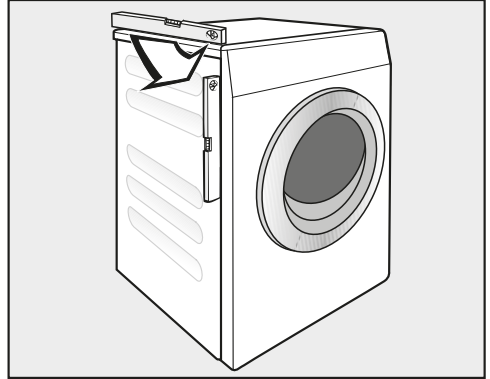

- Use a spirit level to check that the washing machine is standing level.
- Hold foot **1** securely with a pipe wrench. Turn counter nut **2** again using the spanner supplied until it sits firmly up against the housing.

⚠ Risk of damage due to incorrectly aligned washing machine.

There is a danger of the washing machine moving about if the feet are not secured.

Turn all four counter nuts for the feet until they sit firmly up against the housing. Please also check this for the feet which did not need adjustment.

Installation

Fixing bracket for plinth

The fixing bracket prevents the washing machine from falling off a plinth during operation.

Fastening with the fixing bracket is only intended for plinths made from concrete. The plinth must be flat and level. The surface below the plinth must be able to withstand the physical loads. Prior to installation, ensure the plinth complies with the minimum dimensions.

Height: 6 cm

Width: 60 cm

Depth: 65 cm

Positioning the fixing bracket



Risk of injury from sharp edges!

The fixing bracket has sharp edges. You could cut yourself on the edges. Take care when handling the fixing bracket.

Wear gloves while installing the fixing bracket.

The front appliance feet must protrude by at least 3 mm from the bottom of the locknut. The washing machine must already be aligned (see “Installation – Aligning the washing machine”).

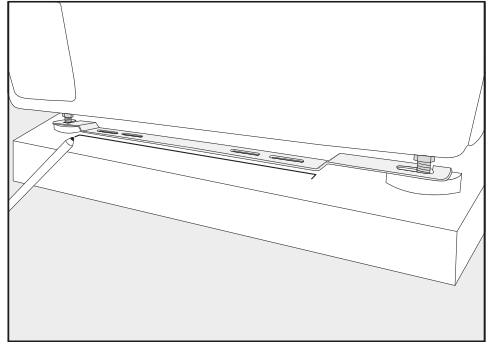

- Place the fixing bracket on the front appliance feet.
- Mark the position of the front edge of the fixing bracket with a pencil.
- Remove the fixing bracket from the feet.
- Carefully move the washing machine until you have enough space to install the fixing bracket.

Installing the fixing bracket

- Place the fixing bracket on the marking on the plinth.
- In the middle of the two outer slotted holes, mark a point for each drill hole.
- Drill 2 holes (8 mm) with a depth of approx. 55 mm.
- Insert the plugs in the holes.

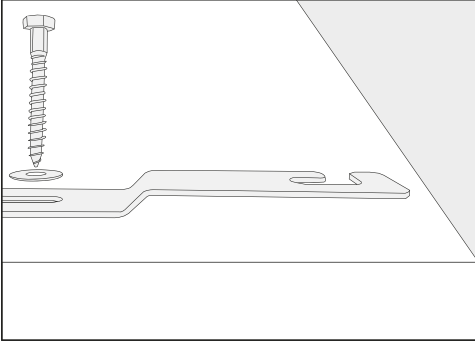

- Install the fixing bracket with the hexagonal screws and the washers.

Do not tighten the screws yet – this will allow the fixing bracket to be moved sideways.

Securing the washing machine with the fixing bracket

- Push the washing machine back on to the installed fixing bracket.

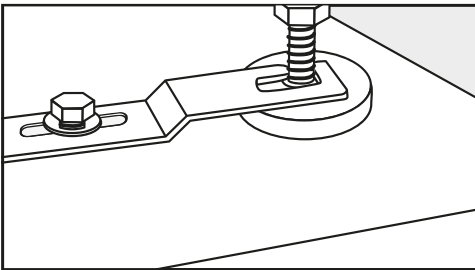

- Insert the appliance feet (the part between the foot and the locknut) into the openings in the fixing bracket.
- Push the fixing bracket to the right as far as it will go.
- Tighten the hexagonal screws using a spanner.

The washing machine is secured in the fixing bracket.

External control equipment

An optional accessory unit has to be purchased to set up a connection with external systems:

- XCI box communication module (e.g for dispenser systems, peak load control units or payment systems)
- XCI-AD communication adapter (for payment systems only)

Payment system

This machine can be fitted with a payment system (optional accessory).

The necessary reprogramming must be carried out by Miele.

Coins/tokens must be removed from the coin box regularly. Otherwise, the payment system will become blocked.

Installation

Water connection

Cold water connection

The washing machine must be connected to a mains water supply in accordance with current local and national safety regulations.

The flow pressure must amount to a minimum of 100 kPa (1 bar) and must not exceed an overpressure of 1000 kPa (10 bar). If it is higher than 1000 kPa, a pressure reduction valve must be installed.

Connection to the mains water supply should incorporate a water tap with a $\frac{3}{4}$ " threaded union. If this is not available, only a qualified plumber may connect the washing machine to the mains water supply.

The connection point is subject to mains water pressure.

Turn on the tap slowly and check for leaks. Correct the position of the washer and union if necessary.

The inlet hose for cold water is not intended to be used for a hot water connection.

Switching to cold water operation

If the washing machine is not connected to a hot water tap, you will have to configure the settings *Main wash water*, *Pre-wash water* and *Rinse water* to cold (see "Supervisor level").

- Unscrew the hot water hose.
- Screw on the stopper provided.

Maintenance

Only use a genuine Miele hose should you ever need a replacement.

A filter is located in the open end of the inlet hose and another in the intake point to protect the inlet valve. Neither filter may be removed.

Hose extension

Longer hoses with a length of 2.5 m or 4.0 m are available from Miele as optional accessories (depending on country).

Hot water connection*

The hot water temperature must not exceed 70°C.

To minimise energy consumption during operation with hot water, the washing machine should be connected to a suitable hot water ring circuit. So-called “transmission pipes” (single pipes to hot water generators) can result in cooling down of the water remaining in the pipes if not in constant use. More energy would then be consumed to heat the suds up again.

The same connection requirements as for cold water also apply to hot water.

The inlet hose (hot = red stripes) is connected to the water tap.

It is not possible to connect the washing machine to a hot water connection only.

* Some machine versions do not come with a hot water hose.

Switching to hot water operation

If the washing machine is to be connected to hot water, you will have to configure the settings *Main wash water*, *Pre-wash water* and *Rinse water* to *warm* (see “Supervisor level”).

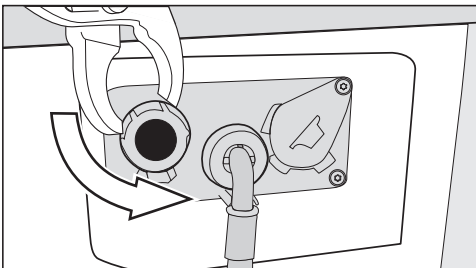

- Unscrew the stopper from the hot water valve.
- Screw on the hot water hose.

IMPORTANT Australia and New Zealand

This appliance must be connected to the water supply in strict accordance with local and national requirements (e.g. Plumbing Code of Australia (PCA)).

This appliance must be installed according to AS/NZS 3500.1 and AS/NZS 3500.2. This washing machine has been supplied with a separate backflow prevention device.

- Disconnect mains power (switch off or unplug the plug).
- Turn off the water tap.
- Place the seals on both sides of the non-return valve.
- Connect the female end of the non-return valve to the water tap.
- Connect the hose to the male end of the non-return valve.
- Turn on the tap gradually to test for leaks.

If there is a leak, the connection might not be on securely, or it may have been screwed on at an angle. Unscrew and reconnect the water correctly before tightening it.

Installation

Drainage

Drain valve

The washing machine is drained using a motorised drain valve. A DN 70 angle connector can be used for draining the machine via an on-site floor drain (gully with odour trap).

Drain pump

The suds are drained through a drain pump with a 1 m delivery head. For the water to drain freely, the hose must be free of kinks. An elbow piece (accessory) can be hooked onto the end of the hose.

Drain hose connection options

1. Connected securely to a trapped waste pipe.
2. Connected over the rim of the laundry trough or into the sud-saver pipe of the laundry trough.
3. Connected securely to a floor drain (gully).

If required, the hose can be extended to a length of up to 5 m. The necessary parts can be ordered from Miele (depending on country).

For a delivery head of more than 1 m (up to a max. of 1.6 m) a replacement drain pump will need to be fitted. Please contact Miele for advice.

Waste water discharge from commercial clothes washing machines may require pre-treatment as determined by the utility operator.

Electrical connection

This description applies to washing machines both with and without a mains plug.

The following applies to washing machines with a mains plug:

- The washing machine is ready to be connected.
- The electrical socket must be easily accessible after installation so that the machine can be disconnected from the electricity supply if necessary.

 Damage caused by incorrect supply voltage.

The data plate indicates the nominal power consumption and the appropriate fuse rating.

Compare the specifications on the data plate with those of the mains electricity supply.

The washing machine may only be connected to a permanent electrical system that conforms to the national and local codes and regulations.

Do not connect the machine to an extension lead or multi-socket adapter as they do not guarantee the required safety of the appliance (e.g. danger of overheating).

If the appliance is hard wired, a dual circuit breaker must be provided on site. When switched off, there must be an all-pole contact gap of at least 3 mm in the isolator switch (including circuit breakers, fuses, and relays according to AS/NZS 3000). This connection must be carried out by a qualified and competent electrician.

The plug connector or isolator switch should be easily accessible at all times.

 Risk of electric shock!

If the washing machine is disconnected from the power supply, protective measures must be taken to ensure that the point of disconnection cannot accidentally be switched on again.

Make sure the isolator is lockable or the point of disconnection is monitored at all times.

New connections, modifications to the system, or servicing of the protective earthing conductor, including determining the correct fuse rating, must be carried out by a qualified and competent electrician, as they are familiar with the pertinent regulations and the specific requirements of the electric utility company.

If converting the washing machine to an alternative voltage, ensure that the connection data on the data plate (voltage, frequency and fuse rating) match the mains electrical supply. Observe the instructions in the wiring diagram. Conversion may only be performed by Miele or a Miele authorised service technician.

Technical data

Height	850 mm
Width	596 mm
Width (for appliances with a stainless steel lid)	605 mm
Depth	714 mm
Depth with door open	1,132 mm
Weight	Approx. 100 kg
Maximum floor load in operation	3000 newtons
Capacity	7.0 kg dry laundry
Supply voltage	See data plate on back of machine
Rated load	See data plate on back of machine
Fuse rating	See data plate on back of machine
A-rated sound emissions L_{pA} in accordance with EN ISO 11204/11203	< 70 dB re 20 μ Pa
Minimum water flow pressure	100 kPa (1 bar)
Maximum water flow pressure	1000 kPa (10 bar)
Water inlet hose length	1.55 m
Mains connection cable length	1.80 m
Maximum delivery head (drain pump)	1.00 m
LEDs	Class 1
Product safety standard	EN 50571, AS/NZS 60335
Power consumption when switched off	0.50 W
Networked standby	2.00 W
Frequency band of the Wi-Fi module	2.4000 GHz – 2.4835 GHz
Maximum transmission power of the Wi-Fi module	< 100 mW

Supervisor level

The settings menu in the  Supervisor level is locked against unauthorised access. The menu can be unlocked with a code.

Code-based access

The Supervisor level is accessed using a code.

The code is **000** (factory default).

Changing the code

You can change the Supervisor level access code to protect the washing machine from unauthorised access.

Please inform Miele if you have forgotten your new code. Miele will have to reset the code. Make a note of your new code and store it in a safe place.

Opening the Supervisor level

- Touch the  sensor.

The  symbol appears in the display e.g. if you turn the programme selector to the *Drain/Spin* programme.

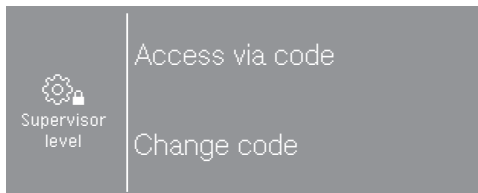

- Select Access via code.

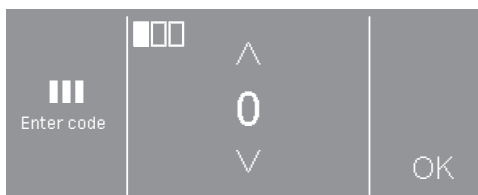

- Enter the individual numbers and confirm each selection with OK.

The Supervisor level settings are opened.

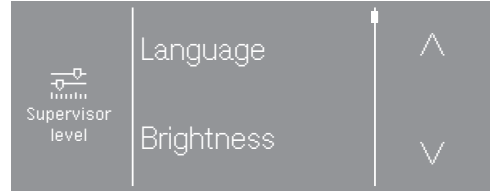

- Select the desired setting.

Some settings are only visible if external devices are connected via the XCI box.

Exiting the Supervisor level

- Touch the  sensor or switch off the washing machine.

Supervisor level

Language

The display can be set to appear in one of several different languages. You can select the permanent operator language via the Language submenu.

When a programme is running, you can change the user language using the  sensor control.

Brightness

The brightness of the display can be set in intervals of ten from 10% to 100%.

Factory setting: 70%

Clock display

After selecting the clock format, you can set the time of day.

Clock format

- 24 h clock (factory setting)
- 12 h clock
- Clock off

Set

- The time can be set.

Finish tone volume

The volume for the signal tone that sounds at the end of the programme can be changed.

The tones can be set to one of 7 different levels or switched off altogether.

Factory setting: Off

Keypad tone

The volume of the tone that sounds when a sensor is touched can also be changed.

The tones can be set to one of 7 different levels or switched off altogether.

Factory setting: Normal

Welcome tone volume

The volume of the welcome tone that sounds when the washing machine is switched on can be changed.

The tones can be set to one of 7 different levels or switched off altogether.

Factory setting: Normal

Fault alarm

The signal tone that sounds in the event of a fault can be switched on or off.

Factory setting: Off

Memory

The washing machine will save the latest settings (temperature, spin speed and some of the options) which have been selected for a programme after the programme has started.

When the programme is selected again, the saved settings will appear in the display.

Factory setting: Off

Anti-crease

The anti-crease function helps prevent creasing if laundry is not going to be removed immediately after the end of the programme.

The drum continues to turn at intervals for up to 30 minutes after the end of the programme. The door can be opened at any time during the anti-crease phase.

Factory setting: On

Suds cooling

Additional water flows into the drum at the end of the main wash to cool the suds down.

Suds cooling takes place when a programme with a temperature of 70°C or higher is selected.

Suds cooling should be activated:

- to prevent the danger of scalding if the drain hose is hooked over the edge of a sink or basin.
- where the drainage pipe is rated less than 70°C.

Factory setting: On

"Display" switch-off status

To save energy, the display goes out and the *Start/Stop* sensor flashes slowly.

Changing this setting leads to increased energy consumption.

- Off
The display will remain on.
- On after 10 min, not in current programme (factory setting)
The display will remain on while the programme is running but will go out 10 minutes after the end of the programme.
- On after 30 min, not in current programme
The display will remain on while the programme is running but will go out 30 minutes after the end of the programme.
- On after 10 min
The display will go out after 10 minutes.
- On after 30 min
The display will go out after 30 minutes.

Supervisor level

Delay start

The type of time input for the Delay start function can be changed or switched off.

- Off
The Delay start function is not available for selection.
- End of programme (factory setting)
With the Delay start function, you specify at what time the wash programme should finish.
- Start of programme
With the Delay start function, you specify at what time the wash programme should start.
- Time until start
With the Delay start function, you specify after how many hours a programme should start.

SmartStart (only functional in selected countries)

The function of the  sensor changes when the *SmartGrid* setting is activated and the *Time until start* option is selected in the *Delay start* setting. The period of time in which the wash programme will start automatically is then shown in the display: *SmartStart*

The programme is started via an external signal.

The time period can be defined up to 24 hours. During this period, the washing machine waits for the external signal. If no signal is sent during the defined period, the washing machine starts the drying programme once the defined period of time has elapsed.

Programme name

When selecting a standard programme, the name of the selected programme is shown in the display.

- On (factory setting)
When a programme is selected, the programme name is displayed for a few seconds before the display shows the main menu.
- Off
The main menu is displayed immediately.

Visibility parameters

Various parameters are offered/ displayed when a programme is selected. You can decide which parameters should not be displayed. These parameters can then not be edited during programme selection.

Factory default: all parameters are visible.

Pre-wash water

You can select the type of water for the pre-wash.

- Cold
Only cold water is used for the pre-wash.
- Hot
Hot water is also added for the pre-wash.
Hot water can only be added if the wash temperature is above 30°C.

Main wash water

You can select the type of water for the main wash.

- Cold
Only cold water is used for the main wash.
- Hot
Hot water is also added for the main wash.
Hot water can only be added if the wash temperature is above 30°C.

If the washing machine is not connected to hot water, programme durations will be longer and may deviate from the remaining runtimes displayed.

First rinse water

You can select the water type for the first rinse in some programmes.

- Cold (factory setting)
Only cold water is used for the first rinse.
- Hot
Hot water is also added for the first rinse.

Final rinse water

You can select the water type for the final rinse in some programmes.

- Cold (factory setting)
Only cold water is used for the final rinse.
- Hot
Hot water is also added for the final rinse (only possible for programmes with a temperature of at least 60°C).

Low water pressure

If the water pressure is below 100 kPa (1 bar), the programme will be cancelled and the fault message **Check water inlet** will appear.

If the on-site water pressure cannot be increased, activating the **Low water pressure** setting will prevent the programme from being cancelled.

Factory setting: Off

Empty sensor

A suction lance contact can be used to detect whether external liquid detergent containers are empty. A message will appear if a container is empty.

- Off (factory setting)
The empty container sensing function is switched off.
- Normally open contact
The siphons are equipped with a normally open contact.
- Normally closed contact
The siphons are equipped with a normally closed contact.

Supervisor level

Early warning counter

An internal counter reports when an external dispenser container is almost empty. The counter in question then has to be reset.

Water level Cottons

In the *Cottons* programme, you can increase the water level for the main wash.

- + 0 mmWS (factory setting)
- + 10 mmWS
- + 20 mmWS
- + 30 mmWS

Water level Minimum iron

In the *Minimum iron* programme, you can increase the water level for the main wash.

- + 0 mmWS (factory setting)
- + 10 mmWS
- + 20 mmWS
- + 30 mmWS

Pre-wash temp. Cottons

In the *Cottons* programme, you can select the temperature for the pre-wash.

- 30°C (factory setting)
- 35°C
- 40°C
- 45°C

Wash time pre-wash

In the *Cottons* programme, you can extend the duration of the pre-wash.

- + 0 min (factory setting)
- + 6 min
- + 9 min
- + 12 min

Wash time Cottons

In the *Cottons* programme, you can extend the duration of the main wash.

- + 0 min (factory setting)
- + 10 min
- + 20 min
- + 30 min
- + 40 min

Wash time Minimum iron

In the *Minimum iron* programme, you can extend the duration of the main wash.

- + 0 min (factory setting)
- + 5 min
- + 10 min
- + 15 min
- + 20 min

Pre-rinse Cottons

In the *Cottons* programme, a pre-rinse can be activated.

Factory setting: Off

Pre-rinse Minimum iron

In the *Minimum iron* programme, a pre-rinse can be activated.

Factory setting: Off

Pre-wash Cottons/Min. iron

In the *Cottons* and *Minimum iron* programmes, you can choose whether a pre-wash is permanently activated or whether it can be selected during programme selection.

Factory setting: Menu selection

Cottons rinses

In the *Cottons* programme, you can change the number of rinse cycles that are carried out.

- 1 rinse cycle
- 2 rinse cycles (factory setting)
- 3 rinse cycles
- 4 rinse cycles
- 5 rinse cycles

Minimum iron rinses

In the *Minimum iron* programme, you can change the number of rinse cycles that are carried out.

- 2 rinse cycles (factory setting)
- 3 rinse cycles
- 4 rinse cycles

Disinfection rinse

Additional rinse cycles can be activated in disinfection programmes with a temperature of at least 60°C.

Rinsing is carried out with hot water. The programme duration is extended.

The laundry may feel hot at the end of the programme.
Take care when removing items.

Factory setting: Off

Programme packages

The selection of programmes can be extended by activating single programmes from the target group programme packages.

The programmes selected from the programme packages are displayed under *Special programmes* ☆.

- Sport
- Outdoor
- Wellness/Hair salons
- Hotel
- Home textiles
- Workwear
- Disinfection

Supervisor level

After selecting the programme packages, the individual programmes from the list are activated. Activated programmes are marked with a frame. The selection must then be confirmed.

Disinfection prog. code

A code needs to be entered to cancel a disinfection programme. The code can be changed.

The code is: 0 0 0

Useful tip: Make a note of your new code if you ever change it.

Temperature reduction

The suds temperature can be reduced to prevent the suds from boiling too early in high-altitude locations.

Factory setting: Off

Auto load control

The washing machine is equipped with an automatic load control. In some programmes, the water levels and the programme cycle times are adapted to the load. If the automatic load control is deactivated, the machine will always carry out the programme sequence based on a full load.

Factory setting: On

CapDosing

You can choose whether CapDosing is displayed in the *Further selections* list.

Factory setting: On

Pre-ironing

You can choose whether Pre-ironing is displayed in the *Extras* list.

Factory setting: On

Hygiene

The Maintenance wash hygiene programme is shown in the list of *special programmes*.

If a programme at a temperature below 60°C has been used, the prompt to start the Maintenance wash hygiene programme will appear in the display.

Factory setting: Off

Automatic dispensing

Automatic dispensing via an external dispensing system can be activated.

Factory setting: Off

Adjustment value dosage 1–6

To address the tolerances that occur in the pump system over time, the dosage amount (ml/min) for the pumps can be corrected.

The calibration value can be reduced in 3 increments or increased in 3 increments.

The calibration value is increased or reduced by 1, 2 or 3 times the adjustment value based on the selected incremental setting.

The calibration value and the adjustment value must be added to the data for the dispenser pumps by Miele Customer Service.

COM module selection

Your washing machine is equipped with an integrated Wi-Fi module. However, the machine can also be fitted with an external module.

- Off (factory setting)
- Internal module
 - The internal Wi-Fi module is used.
- External module
 - An XKM module or RS232 module is inserted into the module slot.

Field of application

After selecting the communication module, the field of application must be selected.

- Commercial environment
 - A connection to Miele MOVE is established.
- Private environment
 - A connection to the Miele App is established.

Availability of Miele digital products

The ability of Miele digital products depends on the availability of the services in your country.

The different services are not available in all countries.

For information about availability, please visit www.miele.com.

Wi-Fi/LAN

Control the networking of your washing machine.

- Setup
 - This message only appears if the washing machine has not yet been connected to a Wi-Fi network.
- Deactivate (visible when the network is activated)
 - The network remains set up, the Wi-Fi function is switched off.
- Activate (visible if the network is deactivated)
 - The Wi-Fi function is reactivated.
- Connection status (visible when the network is activated)
 - the quality of the Wi-Fi reception
 - the network name
 - the IP address
- New setup (visible if set up)

Supervisor level

Resets the Wi-Fi login (network) to immediately re-establish a new connection.

- Reset (visible if set up)

The network is no longer set up. To use the network again, a new connection must be established.

- The Wi-Fi is switched off.
- The Wi-Fi connection will be reset to the factory default setting.

Wi-Fi setup

There are 2 possible connection methods.

WPS

- Activate the WPS function on your router within 2 minutes.

Useful tip: If the connection has not been set up when the timeout has finished counting down, repeat the process.

Soft AP

- Activate the function with the Miele App on your smart device within 10 minutes.

Useful tip: The App will guide you through the remaining steps.

Network time

The date and time can be synchronised via the network.

- Off

The date and time are not synchronised via the network.

- as a master

The machines are in a network but are not connected to the internet. One machine is declared as the master and sends data to the *slave* devices.

- as a slave

The machines are in a network with internet connection. All machines are configured as *slaves*. Data is synchronised over the Internet.

Peak load signal

The peak-load cut-off function enables the washing machine to be connected to an energy management system. When a signal is registered, the washing machine's heater is switched off for a short period. The washing machine may only be operated with a peak-load system if this system is connected to the washing machine via the Miele XCI box.

- No function (factory setting)
- Peak load with 230V
- Peak load with 0V

Peak load prevention

The peak-load cut-off function can be deactivated for disinfection programmes. When a signal is registered, the washing machine's heater is not switched off.

Factory setting: Off

Remote

Operating data relating to the washing machine (e.g. fault messages or notifications) is communicated externally.

Factory setting: On

RemoteUpdate

The RemoteUpdate function is used for updating the software in your washing machine.

RemoteUpdate is activated at the factory.

If you do not install a RemoteUpdate, you can continue to use your washing machine in the usual way. However, Miele recommends installing RemoteUpdates.

Running a RemoteUpdate

If a RemoteUpdate is available for your washing machine, it will be displayed automatically in the open Supervisor level.

You can choose to start the RemoteUpdate immediately or wait until later. If you select "Start later", the prompt to run the RemoteUpdate will be displayed again the next time you switch on your washing machine.

The RemoteUpdate can take several minutes.

Please note the following information about the RemoteUpdate function:

- You will only receive a message when a RemoteUpdate is available.
- Once a RemoteUpdate has been installed, it cannot be undone.
- Do not switch off the washing machine during a RemoteUpdate. Otherwise, the RemoteUpdate will be aborted and will not be installed.

Supervisor level

SmartGrid (only functional in selected countries)

You can use the SmartGrid setting to integrate your washing machine into building energy management systems.

Factory setting: Off

Clean drain pump

The user sees a message when the drain pump filter has to be cleaned.

The message is displayed every 500 operating hours.

The message appears at the end of the programme.

Factory setting: Off

Legal information

[Open source licences](#)

You can view information at this point.

Copyright and licences for operating and control software

For the purpose of operating and controlling the machine, Miele uses proprietary or third-party software that is not covered by open source licensing terms. These items of software/software components are protected by copyright. The copyright powers of Miele and third parties must be respected.

In addition, the machine contains software components which are distributed under open source licensing terms. You can access these open source components along with the associated copyright notices, copies of the valid licensing terms and any further information in the machine under the menu option [Settings | Machine parameters | Legal information | Open source licences](#). The liability and warranty arrangements for the open source licences displayed at this location only apply in relation to the respective rights holders.

Payment system

If you wish to change the settings later, please contact Miele.

The XCI-AD or XCI box accessory unit is required to connect a payment system.

Settings for payment systems

You would like to connect a payment system.

- No payment system
The next settings are skipped and initial commissioning can be completed.
- Programme operation
The machine is operated using a coin box. The user purchases a wash programme.
- Time operation
The machine is operated using a payment system. The user purchases a time-controlled programme.
- COM module
The machine is operated by a central control unit.

Feedback signal to pay system

Setting the feedback signal for the payment system.

- Factory setting: Off
- Programme end
The feedback signal is sent at the end of the programme.
- Release of the start button
The feedback signal is sent when the start button is released.
- Start and end of programme
The feedback signal is sent at the start and end of the programme.
- Running programme
The feedback signal is sent continuously from the start until the end of the programme.

Supervisor level

Payment system lock

To avoid tampering, a programme lock can be set up in programme operation. If the lock is applied, the programme is interrupted and payment credit is lost as soon as the door is opened.

To offer the possibility to add laundry, the time when the lock activates can be adjusted.

- Off
- As soon as the programme starts
- 1 minute after the start of the programme
- 2 minutes after the start of the programme
- 3 minutes after the start of the programme (factory setting)
- 4 minutes after the start of the programme
- 5 minutes after the start of the programme

FOC programmes

In payment system mode, you can decide whether the Drain/Spin programme can be used for free.

Factory setting: Off

Clear paid signal

The "Paid" signal in payment system mode can be applied until the end of the programme or discarded if the programme has not been started after 5 minutes.

Factory setting: Off

Debounce time

In coin mode, the debounce time for the minimum payment signal that must be applied can be adjusted.

- Factory default: Short
For payment systems where the falling coin generates the paid pulse.
- Long
For central control units on a 230 V basis.

Miele Australia Pty. Ltd.

ACN 005 635 398

ABN 96 005 635 398

Melbourne:

Level 4, 141 Camberwell Road

Hawthorn East, VIC 3123

Telephone: 1300 731 411

professional.service@miele.com.au

www.miele.com.au/professional

professional.sales@miele.com.au

Miele New Zealand Limited

IRD 98 463 631

8 College Hill

Freemans Bay

Auckland 1011

New Zealand

Telephone: 0800 4 MIELE

(0800 464 353)

www.miele.com.au/professional

professional.sales@miele.com.au



Miele Global Headquarters: Miele & Cie. KG

Carl-Miele-Straße 29, 33332 Gütersloh, Germany

PWM 507

en-AU, NZ

M.-Nr. 12 936 580 / 01 / 002