

Operating and installation instructions Speed oven





It is **essential** to read these operating and installation instructions before installing and using the appliance. This prevents both personal injury and damage to the appliance.

Contents

Warning and safety instructions	6
Caring for the environment	15
Overview	16
Controls	17
On/Off sensor.....	18
Display.....	18
Sensor controls.....	18
Symbols.....	20
Operating principles	21
Selecting a menu option.....	21
Changing a setting in a list.....	21
Changing the setting with a segment bar.....	21
Selecting a function.....	21
Entering numbers.....	22
Entering letters.....	22
Activating MobileStart.....	22
Features	23
Data plate.....	23
Items supplied.....	23
Accessories supplied and available to order.....	23
Safety features.....	26
PerfectClean treated surfaces.....	26
Before using for the first time	27
Miele@home.....	27
Standard settings.....	28
Heating up the oven for the first time.....	29
Settings	30
Settings overview.....	30
Opening the “Settings” menu.....	32
Language 	32
Time.....	32
Date.....	32
Lighting.....	32
Display.....	33
Volume.....	33
Units.....	33
Quick MW.....	34
Popcorn.....	34
Booster.....	34
Recommended temperatures.....	34
Recommended power levels.....	35
Cooling fan run-on.....	35
Safety.....	35

Miele@home	36
Performing Scan & Connect	36
RemoteUpdate	37
Remote control	38
Activating MobileStart	38
Software version	38
Showroom programme	38
Factory default	38
Operating hours	38
Minute minder	39
Main and sub-menus	40
Microwave operation	42
How it works	42
Suitable crockery	42
Suitable containers	43
Unsuitable containers	44
Testing dishes for their suitability	45
Cover	46
Operation	47
Changing values and settings for a cooking programme	47
Changing the temperature	48
Changing the microwave power level	48
Setting cooking durations	48
Changing the set cooking durations	49
Deleting the set cooking durations	49
Interrupting a cooking programme in the Microwave function	49
Cancelling cooking	49
Pre-heating the oven	50
Booster	50
Pre-heat	51
Quick MW and Popcorn	52
Automatic programmes	53
Categories	53
Using Automatic programmes	53
Usage notes	53
Other applications	54
Defrost	54
Reheat	57
Drying	60
Heat crockery	61
Keeping warm	61
Cooking	62
Bottling	64

Contents

Frozen food/Ready meals.....	66
User programmes	67
Baking	70
Tips on baking.....	70
Notes on the cooking charts	70
Notes on the oven functions	70
Roasting	72
Tips for roasting.....	72
Notes on the cooking charts	72
Notes on the oven functions	73
Grilling	74
Tips for grilling.....	74
Notes on the cooking charts	74
Notes on the oven functions	75
Fan Grill 	76
Grill 	77
Cleaning and care	78
Unsuitable cleaning agents.....	78
Removing normal soiling.....	79
Removing stubborn soiling.....	80
Lowering the grill element.....	81
Problem solving guide	82
Service	86
Contact in case of fault.....	86
Warranty	86
Installation	87
Building-in dimensions	87
Installation in a tall or base unit.....	87
Side view.....	88
Connections and ventilation	89
Installing the oven	90
Electrical connection	90
Cooking charts	92
Creamed mixture.....	92
Rubbed in mixture	93
Yeast dough.....	93
Quark dough.....	94
Sponge mixture.....	94
Choux pastry, puff pastry, meringue	94
Savoury snacks	95
Beef	96
Veal.....	96
Pork.....	97

Contents

Lamb, game	98
Poultry, fish.....	99
Technical data	100
Copyright and licences for the communication module.....	100

Warning and safety instructions

► For the sake of simplicity, the speed oven will subsequently be referred to as the “oven”.

This oven complies with all current local and national safety requirements. However, inappropriate use can lead to personal injury and damage to property.

Read the operating and installation instructions carefully before using the oven for the first time. They contain important information on safety, installation, use and maintenance of the appliance. This prevents both personal injury and damage to the oven.

In accordance with standard IEC 60335-1, Miele expressly and strongly advises that you read and follow the instructions in “Installation”, as well as in the “Warning and Safety instructions”.

Miele cannot be held liable for injury or damage caused by non-compliance with these instructions.

Keep these instructions in a safe place and pass them on to any future owner.

Correct application

► This oven is designed for domestic use and for use in similar environments by guests in hotel or motel rooms, bed & breakfasts and other typical living quarters. This does not include common/shared facilities or commercial facilities within hotels, motels or bed & breakfasts.

► The oven is not suitable for outdoor use.

► It is intended only to cook, bake, roast, grill, defrost, bottle and reheat food. Any other use is not permitted.

► Fire hazard due to flammable materials.

If flammable items were dried in the microwave oven, the moisture in the items would evaporate. This could cause the materials to dry out and possibly self-ignite.

Never use the oven to store or dry items which could ignite easily.

► This oven is not intended for use by persons (including children) with reduced physical, sensory or mental capabilities, or lack of experience and knowledge, unless they are supervised whilst using it. They may only use the oven unsupervised if they have been shown how to use it in a safe manner. They must be able to recognise and understand the dangers of misuse.

Warning and safety instructions

▶ The oven compartment is equipped with special lamps to cope with particular conditions (e.g. temperature, moisture, chemical resistance, abrasion resistance and vibration). These special lamps must only be used for the purpose for which they are intended. They are not suitable for room lighting. Replacement lamps may only be fitted by a Miele authorised technician or by Miele.

Safety with children

- ▶ Activate the system lock to ensure that children cannot switch on the oven inadvertently.
- ▶ Young children must not be allowed to use this appliance.
- ▶ Older children may only use the oven if its operation has been clearly explained to them and they are able to use it safely. They must be able to understand and recognise the possible dangers caused by incorrect operation.
- ▶ Cleaning work may only be carried out by older children under the supervision of an adult.
- ▶ Children should be supervised in the vicinity of the oven. Never allow children to play with the oven.
- ▶ Risk of suffocation from packaging material. Whilst playing, children may become entangled in packaging material (such as plastic wrapping) or pull it over their head with the risk of suffocation. Keep packaging material away from children.
- ▶ Risk of injury caused by hot surfaces. Children's skin is far more sensitive to high temperatures than that of adults. External parts of the oven such as the door glass, control panel and the vent become quite hot.
Do not let children touch the oven when it is in operation.
- ▶ Risk of injury from the open door. The oven door can support a maximum weight of 8 kg. Children could injure themselves on an open door.
Do not let children sit on the open door, lean against it or swing on it.

Technical safety

▶ Unauthorised installation, maintenance and repairs (including removal of any cover) can cause considerable danger for the user. Installation, maintenance and repairs must only be carried out by a Miele authorised technician.

Warning and safety instructions

▶ Damage to the oven can compromise your safety. Check the oven for visible signs of damage. Do not use a damaged oven.

▶ Temporary or permanent operation with a self-sufficient or non-mains synchronous energy supply system (e.g. isolated networks, back-up systems) is possible. A requirement for the operation is that the energy supply system complies with all current local and national requirements that apply to stand-alone, solar and/or battery systems.

The protective measures provided in the installation and in this Miele product must also be assured in their function and operation in isolated operation or in non-mains synchronous operation, or replaced with equivalent measures in the installation.

▶ Operating a damaged oven can result in microwave leakage and present a hazard to the user. Do not use the oven if:

- the door is warped.
- the door hinges are loose.
- holes or cracks are visible in the casing, the door or the oven compartment walls.

▶ The electrical safety of this appliance can only be guaranteed when continuity is complete between it and an effective earthing system. It is essential that this basic safety requirement is present and tested regularly. If in doubt, the electrical installation should be checked by a qualified electrician.

▶ The connection data (voltage and frequency) on the data plate of the oven must match the mains electricity supply in order to avoid the risk of damage to the oven. Compare this before connecting the appliance to the mains electricity. If in any doubt, consult a qualified electrician.

▶ Multi-socket adapters and extension leads do not guarantee the required safety of the appliance. Do not use these to connect the oven to the mains electricity supply.

▶ For safety reasons, the oven may only be used when it has been fully installed.

▶ This oven must not be installed and operated in mobile installations (e.g. on a ship).

▶ Risk of injury due to electric shock. Any contact with live connections or tampering with the electrical or mechanical components of the oven will endanger your safety and may lead to appliance malfunctions.

Do not open the oven housing under any circumstances.

Warning and safety instructions

- ▶ The manufacturer's warranty will be invalidated if the appliance is not repaired by a Miele approved service technician.
- ▶ Miele can only guarantee the safety of the appliance when original Miele spare parts are used. Faulty components must only be replaced by original spare parts.
- ▶ If the oven is delivered without a mains connection cable, a special cable must be installed by a suitably qualified and competent person (see “Installation - Electrical connection”).
- ▶ If the mains connection cable is damaged, it must be replaced with a special connection cable by a suitably qualified and competent person in order to avoid a hazard (see “Installation - Electrical connection”).
- ▶ During installation, maintenance and repair work, the oven must be completely disconnected from the mains electricity supply. To ensure this:
 - Switch off the mains circuit breaker, or
 - switch off at the wall socket and withdraw the plug. To do this, pull the plug and not the mains connection cable.
- ▶ The oven requires a sufficient supply of cool air for efficient operation. Make sure that the supply of cool air is not hindered in any way (e.g. by heat insulation strips fitted in the housing unit). Furthermore, the required supply of cool air must not be excessively heated by other heat sources (e.g. solid fuel stoves).
- ▶ If the oven is built in behind a furniture front (e.g. a door), do not close the furniture door while the oven is in use. Heat and moisture can build up behind the closed furniture door. This can result in damage to the oven, housing unit and floor. Leave the furniture door open until the oven has cooled down completely.



Correct use

- ▶ Risk of injury caused by hot surfaces. The oven gets hot during operation. You could burn yourself on the heating elements, oven compartment, accessories or food. Wear oven gloves when placing food in the oven or removing it, and when adjusting oven shelves etc. in a hot oven.
- ▶ To avoid fuelling any flames, do not open the oven door if smoke occurs inside the appliance. Interrupt the process by switching the appliance off and disconnect it from the mains electricity supply. Do not open the door until the smoke has dispersed.

Warning and safety instructions

- ▶ Due to the high temperatures radiated, objects left near the oven could catch fire. Do not use the oven to heat up the room.
- ▶ Oils and fats can ignite if allowed to overheat. Never leave the oven unattended when cooking with oil or fats. Never attempt to put out oil or fat fires with water. Switch the oven off and extinguish the flames by leaving the door closed.
- ▶ Grilling food for excessively long cooking durations can cause it to dry out with the risk of catching fire. Do not exceed the recommended cooking durations.

▶ Please be aware that durations when using microwave power are often considerably shorter when cooking, reheating and defrosting than when using functions without microwave power. Excessively long cooking durations can lead to food drying out and burning, or could even cause it to catch fire.

Do not exceed recommended grilling times when using Grill functions. Do not use the Microwave  function to dry flowers or herbs or to crisp up bread or rolls. Never use a Grill function to dry flowers, herbs or the like. Use the Fan Plus  function and always ensure this type of procedure is supervised.



▶ If using alcohol in your recipes, please be aware that high temperatures can cause the alcohol to evaporate. The vapour can catch fire on hot heating elements.

▶ When using residual heat to keep food warm, corrosion from high air humidity and condensation can occur in the oven. This can also cause damage to the control panel, worktop and surrounding kitchen furniture. Keep the oven on and select the lowest temperature available for the selected function. The cooling fan will then continue to run and dissipate the moisture.

▶ Food which is stored in the oven compartment or left in it to be kept warm can dry out and the moisture released can lead to corrosion damage in the oven. Always cover food that is left in the oven to keep warm.

▶ A build-up of heat can cause damage to the oven.

Never line the floor of the oven compartment with aluminium foil or oven liners.

If you wish to place crockery on the floor of the oven compartment during cooking, or place crockery on the floor of the oven compartment to heat it up, you can do so, but only with the Fan Plus  or Eco Fan Heat  function without the Booster function.

Warning and safety instructions

▶ The oven compartment floor can become damaged by items being pushed around on it. When placing pots, pans or crockery on the oven compartment floor, ensure that you avoid pushing them around.

▶ Danger of injury caused by steam. Pouring a cold liquid onto a hot surface creates steam, which can cause severe scalding. The sudden temperature change can also cause damage to hot surfaces. Never pour cold liquids directly onto hot surfaces.

▶ The oven is not suitable for cleaning or disinfecting items. Items can get extremely hot. There is a risk of burning when items are removed from the oven.

▶ It is important that the temperature in the food being cooked is evenly distributed and sufficiently high.

This can be achieved by stirring or turning the food, and observing a sufficiently long standing time (see charts), which should be added to the time needed for reheating, defrosting or cooking.

During the standing time, the temperature is distributed evenly in the food.

▶ When heating food, and in particular liquids, using the Microwave  function, the boiling point may be reached without the production of typical bubbles. Liquids do not boil evenly throughout. This boiling delay can result in the liquid boiling over explosively. Take care when taking the container out of the oven, as the hot liquid can cause severe scalding. Under certain circumstances, the pressure can be so high that the door opens automatically.

Stir liquids well before reheating or cooking. After heating, wait at least 20 seconds before removing the container from the oven. In addition, a glass rod or similar item, if available, can be placed in the container during heating.

▶ Risk of injury caused by hot food. When heating food up, the heat is created directly in the food itself. For this reason, the crockery will remain cooler than the food (except when using ovenproof stoneware). The crockery is only warmed by the heat of the food. Before serving, always check the temperature of the actual food itself after taking it out of the oven. The temperature of the container is not an indication of the temperature of the food or liquid in it. **This is particularly important when heating food for babies, children, and the elderly or infirm.** After reheating food, especially food for babies and small children, stir the food or shake the container and check that the temperature does not pose any danger of burning. Double check after it has been left to stand.

Warning and safety instructions

▶ Risk of injury from increased pressure in sealed containers or bottles. Pressure can build up when reheating food or drinks in sealed containers, jars or bottles, which can cause them to explode. Never cook or reheat food or liquids in sealed containers or bottles. Open containers beforehand. In the case of baby bottles, the screw top and teat must be removed.

▶ If you cook eggs without their shells, the yolks could explode due to the resulting pressure.

Prick the yolk several times before cooking to avoid this.

▶ Eggs heated in their shells can burst, even after they have been taken out of the oven compartment.

Eggs can only be cooked in their shells in a specially designed egg-boiling device. Do not reheat hard boiled eggs using the Microwave  function.

▶ Food with a thick skin or peel, such as tomatoes, sausage, potatoes and eggplants can burst when heated or cooked.

Pierce or score the skin of these types of food several times to allow steam to escape.

▶ Do not use a thermometer containing mercury or liquid as these are not suitable for use with very high temperatures and break very easily.

To check food temperature, first interrupt the cooking process. Only use a thermometer specifically approved for food use to measure the temperature of the food.

▶ Cushions or pads filled with cherry kernels, gel, etc., such as those used in aromatherapy, can ignite when heated even after they have been removed from the oven.

Do not heat these up in the oven.

▶ Crockery and lids with hollow handles or knobs can collect moisture in the hollow spaces. When the moisture evaporates, pressure can build up and the item can explode. If the hollow recess is sufficiently ventilated, the item can be used.

Do not use crockery with hollow knobs or handles when using the Microwave  function.

Warning and safety instructions

▶ Non-microwave safe plastic dishes can suffer damage or damage the oven if used with the Microwave  function and or functions that use microwaves.

Do not use any containers or cutlery made from or containing metal, aluminium foil, lead crystal glassware, temperature-sensitive plastics, wooden utensils or cutlery, metal clips or plastic or paper covered wire ties. Do not use bowls with milled rims, or plastic pots with the foil lid only partially removed (see "Microwave operation - Suitable containers for microwave use").

▶ Plastic dishes that are not suitable for use in an oven will melt and may ignite at high temperatures and damage the oven.

Use only plastic dishes that are suitable for use in an oven when using functions that do not use microwave power. Follow the manufacturer's instructions.

▶ Fire hazard due to containers made of flammable materials. Plastic disposable containers must meet the requirements specified for crockery in "Microwave operation - Suitable containers for microwave use".

Do not leave the oven unattended when heating or cooking food in disposable containers made of plastic, paper or other inflammable materials.

▶ Heat-retaining bags usually contain a thin layer of aluminium foil that reflects microwave radiation. Because of this, the paper surrounding the aluminium foil can become so hot that it combusts. Do not use heat-retaining packaging, such as bags for grilled chicken, for warming food with functions that use microwave power.

▶ If the oven is used without food or the food is loaded incorrectly when using the Microwave  function or functions that use microwave power, the oven can become damaged.

Always use the glass tray with the Microwave  function, even if you use it as a container for smaller dishes.

Do not use any functions that use microwave power to pre-heat crockery or to dry herbs.

Instead, use the Fan Plus  function.

▶ Preserving and heating food in sealed tins will result in an increase in pressure, which can cause them to explode. Do not use tins for preserving or heating food.

▶ Risk of injury from the open door. You could bang into the open door or trip over it. Avoid leaving the door open unnecessarily.

Warning and safety instructions

▶ The door can support a maximum load of 8 kg. Do not lean or sit on an open door, or place heavy items on it. Make sure that nothing gets trapped between the door and the oven compartment. This could damage the oven.

The following applies for stainless steel surfaces:

▶ The coated stainless steel surface can be damaged by adhesives and will lose its dirt-repelling properties. Do not use sticky notes, adhesive tape or other types of adhesive on the stainless steel surface.

▶ Magnets can cause scratches. Do not use the stainless steel surface as a magnetic notice board.

Cleaning and care

▶ Risk of injury due to electric shock. The steam from a steam cleaning appliance could reach electrical components and cause a short circuit. Never use a steam cleaner for cleaning.

▶ Scratches on the door glass can cause the glass to break. Do not use abrasive cleaners, hard sponges, brushes or sharp metal tools to clean the door glass.

▶ Try to avoid the interior walls being splashed with food containing salt. If this does happen, wipe it away thoroughly to avoid corrosion to stainless steel surfaces inside the oven compartment.

▶ In warm, moist environments, there is a higher probability of vermin infestations (e.g. cockroaches). Ensure the oven and the area surrounding it are always kept clean.

Damage caused by vermin is not covered by the warranty.

Accessories

▶ Only use original Miele accessories. If other parts are used, warranty, performance and product liability claims will be invalidated.

▶ Miele will guarantee to supply functional spare parts for a minimum of 10 years and up to 15 years following the discontinuation of your oven.

Disposal of the packing material

The transport and protective packaging has been selected from materials which are environmentally friendly for disposal, and can normally be recycled.

Recycling the packaging reduces the use of raw materials in the manufacturing process and also reduces the amount of waste in landfill sites.

Ensure that any plastic wrappings, bags etc. are disposed of safely and kept out of the reach of babies and young children. Danger of suffocation.

Disposing of your old appliance

Electrical and electronic appliances often contain valuable materials. They also contain specific materials, compounds and components, which were essential for their correct function and safety. These could be hazardous to human health and to the environment if disposed of with your domestic waste or if handled incorrectly. Please do not, therefore, dispose of your old appliance with your household waste.



Please dispose of it at your local community waste collection / recycling centre for electrical and electronic appliances. You are also responsible for deleting any personal data that may be stored on the appliance prior to disposal. Please ensure that your old appliance poses no risk to children while being stored prior to disposal.





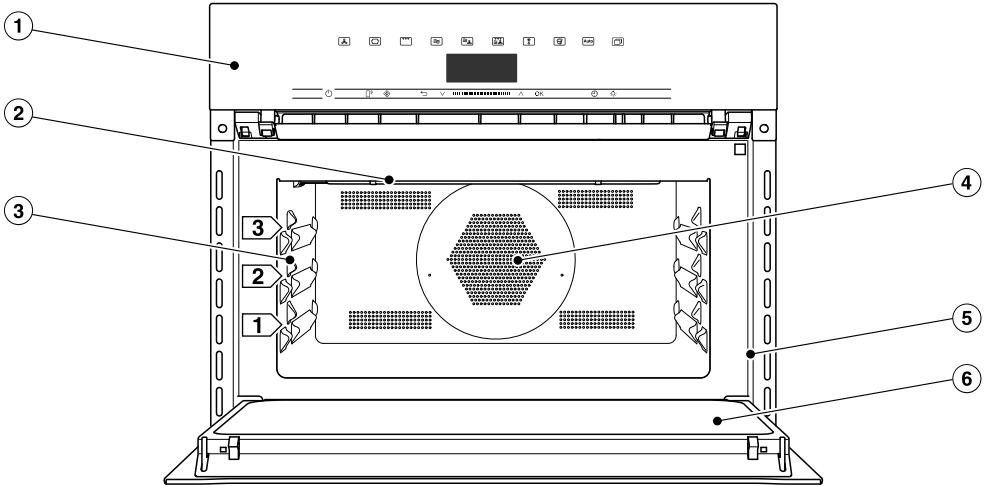

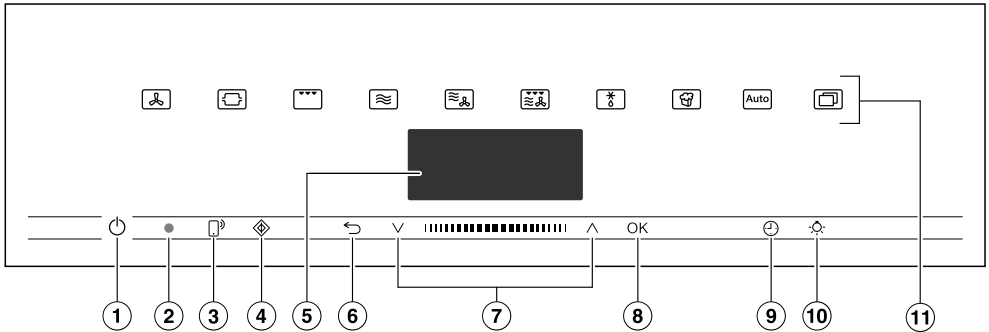

Overview

Oven



- ① Control panel
- ② Grill element
- ③ 3 Shelf levels for the glass tray and rack
- ④ Air inlet for the fan with ring heating element behind it
- ⑤ Front frame with data plate
- ⑥ Door



- ① Recessed On/Off  sensor
For switching the oven on and off
- ② Optical interface
(for Miele service technicians only)
- ③  sensor
For controlling the oven via your mobile device
- ④  sensor
For starting the Quick MW function
- ⑤ Display
For displaying the time of day and information on operation
- ⑥  sensor
For going back a step and for changing menu options during a cooking programme
- ⑦ Navigation area with  and  arrow sensors
For scrolling through lists and for changing values
- ⑧ *OK* sensor
For calling up functions and saving settings
- ⑨  sensor
For setting a minute minder, the cooking duration or the start or finish time for the cooking programme
- ⑩  sensor
For switching the oven interior lighting on and off
- ⑪ Sensor controls
For selecting functions, Automatic programmes and settings

Controls

On/Off sensor

The On/Off  sensor is recessed and reacts to touch.

Use this sensor to switch the oven on and off.

Display

The display is used for showing the time of day or information about functions, temperatures, cooking durations, Automatic programmes and settings.

After switching the oven on with the On/Off  sensor, *Select function* will appear in the main menu.

Sensor controls





The sensors react to touch. Every touch of the sensors is confirmed by a keypad tone. You can switch off this keypad tone using Other  | Settings | Volume | Keypad tone.

If you want the sensors to respond even when the oven is switched off, select the Display | QuickTouch | On setting.



Sensor controls above the display

For information on the oven functions and further functions, see “Main and sub-menus”, “Settings”, “Automatic programmes” and “Other applications”.

Sensor controls under the display





Sensor	Function
	<p>If you want to control the oven from your mobile device, you must have the Miele@home system, switch on the Remote control setting and touch this sensor. The sensor then lights up and the MobileStart function is available.</p> <p>As long as this sensor is illuminated, you can control the oven via your mobile device (see “Settings – Miele@home”).</p>
	<p>Use this sensor to start the Quick MW function. The cooking programme runs with the maximum power level (1000 W) and a cooking duration of 1 minute (see “Quick MW”). Touching the sensor control repeatedly increases the cooking duration in increments.</p> <p>This function can only be used when no other cooking programmes are in use.</p>
	<p>Depending on which menu you are in, this sensor control will take you back a level or back to the main menu.</p> <p>If a cooking programme is in progress at the same time, use this sensor control to change values and settings such as the temperature or Booster function for the programme, or to cancel the programme.</p>
 	<p>In the navigation area, use the arrow sensors or the area between them to scroll up and down in the selection lists. The menu options will be highlighted one after the other as you scroll through them. The desired menu option must be highlighted before you can select it.</p> <p>You can change the values or settings that are highlighted by using the arrow sensors or the area between them.</p>

Controls

Sensor	Function
<i>OK</i>	Functions highlighted in the display can be selected by touching the <i>OK</i> sensor. The selected function can then be changed. Confirm with <i>OK</i> to save changes. If information appears in the display, select <i>OK</i> to confirm the message.
	If no cooking programme is in progress, you can use this sensor to set a minute minder (e.g. when boiling eggs on the cooktop) at any point. While a cooking programme is in progress, you can set a minute minder, the cooking duration and a start or finish time for the programme.
	Select this sensor to switch the oven interior lighting on and off. Depending on the setting selected, the oven interior lighting switches off after 15 seconds or remains constantly switched on or off.

Symbols

The following symbols may appear in the display:

Symbol	Meaning
	This symbol indicates that there is additional information and advice about using the appliance. Select <i>OK</i> to confirm the information.
	Minute minder
	A tick indicates the option which is currently selected.
	Some settings, e.g. display brightness and signal tone volume, are selected using a segment bar.
	The system lock prevents the oven being switched on by mistake (see “Settings – Safety”).

Use the \wedge and \vee arrow sensors or the **|||||** area between them in the navigation area to use the oven.

The *OK* sensor lights up orange as soon as a value, setting or prompt can be confirmed.

Selecting a menu option

- Touch the \wedge or \vee arrow sensor or swipe to the right or left in the **|||||** area until the desired menu option is highlighted.

Useful tip: If you press and hold the arrow sensor, the list continues scrolling automatically until you release the arrow sensor.

- Confirm your selection with *OK*.

Changing a setting in a list

- Touch the \wedge or \vee arrow sensor or swipe to the right or left in the **|||||** area until you reach the desired value or the desired setting is highlighted.

Useful tip: A \checkmark tick will appear beside the current setting.

- Confirm with *OK*.

The setting is now saved. This will take you back to the previous menu.

Changing the setting with a segment bar

Some settings are represented by a **■■■■■□□□** bar with seven segments. If all of the segments are illuminated, the maximum value is selected.

If none or only one of the segments is illuminated, the minimum value is selected or the setting is switched off altogether (e.g. volume).

- Touch the \wedge or \vee arrow sensor or swipe to the right or left in the **|||||** area until you reach the desired setting.
- Confirm your selection with *OK*.

The setting is now saved. This will take you back to the previous menu.

Selecting a function

The sensor controls for the functions are located above the display (see “Operation” and “Settings”).

- Touch the sensor for the desired function.

The sensor on the control panel will light up orange.

- Under *Other* , scroll through the lists until the desired menu option is highlighted.
- Set the values for the cooking programme.
- Confirm with *OK*.

Operating principles

Changing the function

You can change to another function during a cooking programme.

The sensor for the previously selected function lights up orange.

- Touch the sensor for the new function.

The new function appears in the display with its corresponding recommended values.

The sensor for the new function lights up orange.

Under **Other** , scroll through the lists until you reach the desired menu option.

Entering numbers

Numbers that can be changed are highlighted.

- Touch the \wedge or \vee arrow sensor or swipe to the right or left in the **||||** area until the desired number is highlighted.

Useful tip: If you press and hold an arrow sensor, the numbers continue scrolling automatically until you release the arrow sensor.

- Confirm with *OK*.

The changed number is now saved. This will take you back to the previous menu.

Entering letters

Letters are entered via the navigation area. It is best to select short, memorable names.

- Touch the \wedge or \vee arrow sensor or swipe to the right or left in the **||||** area until the desired character is highlighted.

The character you have selected will appear in the top line of the display.

Useful tip: A maximum of 10 characters can be used.

You can delete the characters one at a time with \leftarrow .

- Select further characters.
- Once you have entered the name, select \checkmark .
- Confirm with *OK*.

The name is now saved.

Activating MobileStart

- Select the  sensor to activate MobileStart.

The  sensor lights up. You can operate your oven remotely with the Miele App.

Directly operating the oven takes priority over operating it via the remote control function on the App.

You can use MobileStart as long as the  sensor is lit up.

A list of the models described in these operating and installation instructions can be found on the back page.

Data plate

The data plate located on the front frame of the oven is visible when the door is open.

The data plate states the model number, the serial number as well as connection data (voltage, frequency and maximum rated load).

Have this information available if you need to contact Miele so that any issues can be rectified as quickly as possible.

Items supplied

- The operating and installation instructions for using the oven and microwave functions
- A cookbook with recipes for the Automatic programmes and other functions
- Screws for fixing the oven to the housing unit
- Various accessories

Accessories supplied and available to order

This oven is supplied with a glass tray and a rack.

All accessories and cleaning and care products listed in these instructions are designed for Miele ovens.

These are available to order via the Miele online shop or directly from Miele (see the end of this booklet for contact details).

When ordering, please quote the model number of your oven and the reference number of the accessories required.

Glass tray



The glass tray is suitable for use with all cooking functions.

The glass tray can be damaged by large temperature fluctuations. Do not place the hot glass tray on a cold surface, such as a tiled or granite worktop. Use a suitable mat or pot rest.

- **Always** use the glass tray with the Microwave  function, even if you use it as a container for smaller dishes.
- The maximum load for the glass tray is 8 kg.

The glass tray has an anti-tip safety notch which prevents it being pulled right out when it only needs to be pulled out partially.

When pushing the glass tray back in, always ensure that the safety notch is at the **back** of the oven (see illustration).

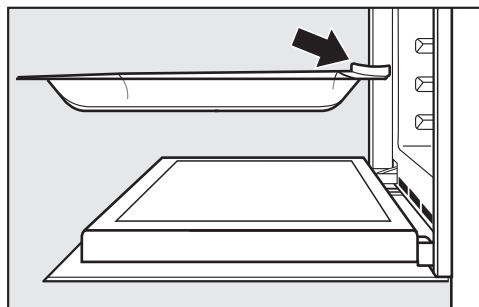



Features

- To remove the glass tray, lift it upwards slightly at the front when the safety notch connects with the sides of the oven.

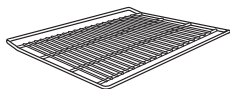
Rack with anti-tip safety notches



The rack is **not** suitable for use with the Microwave  function. You can use the rack for all other functions which use or do not use microwave power.

 Risk of injury caused by hot surfaces.

The rack gets hot during cooking programmes.

Wear oven gloves when placing food in the oven or removing it, and when adjusting oven shelves etc. in a hot oven.

The oven and rack can be damaged by the possible creation of sparks.

Do not use the rack for cooking programmes with the Microwave  function.

Do not place the rack on the oven floor. Place it on one of the shelf levels.

Using the rack

The rack has anti-tip safety notches which prevent it being pulled right out when it only needs to be pulled out partially.

If you insert the rack the wrong way round, the anti-tip safety mechanism is not guaranteed.

When pushing the rack back in, always ensure that the safety notches are at the **back** of the oven.

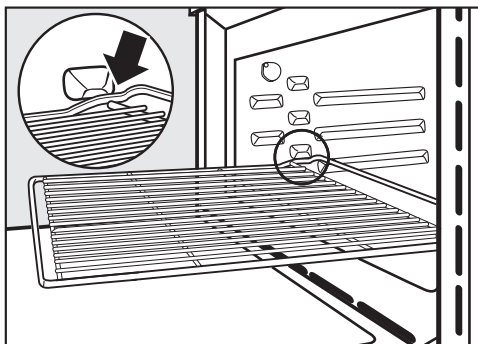



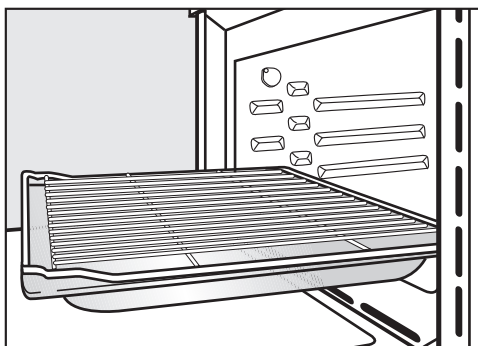

- To remove the rack, lift it upwards slightly at the front when the safety notches connect with the sides of the oven.



- We recommend using the rack together with the glass tray when cooking items on the rack which might drip. Only in this case should the safety notches be at the front.
- The maximum load for the rack is 8 kg.

Round baking trays

The round baking trays can suffer damage when subjected to microwaves.

Do not use the round baking trays with the Microwave , MW + Auto Roast , MW + Fan Plus , MW + Grill  or MW + Fan Grill  functions.



The **solid round baking tray HBF 27-1** is suitable for cooking pizzas, flat cakes made with yeast or whisked mixtures, sweet and savoury tarts, baked desserts, flat bread, and can also be used for frozen cakes and pizzas.

The **perforated round baking and AirFry tray HBFP 27-1** can be used for the same purposes as the **perforated Gourmet baking and AirFry tray HBBL 71**.

The surface of both baking trays has been treated with PerfectClean enamel.

- Insert the rack and place the round baking tray on the rack.

HUB Gourmet oven dishes HBD Gourmet oven dish lids

Gourmet oven dishes and their lids can suffer damage when subjected to microwaves. Metal reflects the microwaves which can create sparks and the microwaves are not absorbed by the metal.

Only use the oven dishes and their lids for cooking programmes with functions which **do not use** microwave power.

Insert the rack in shelf level 1 and place the Gourmet oven dish on the rack.

The surface of the Gourmet oven dishes has a non-stick coating and is suitable for induction cooktops.

Gourmet oven dishes are available in different depths. The width and the height are the same.

Suitable lids are available separately. Please quote the model number when ordering.

Depth: 22 cm

HUB 62-22

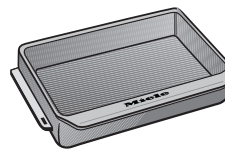

HBD 60-22

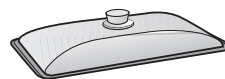

Depth: 35 cm*

HUB 62-35

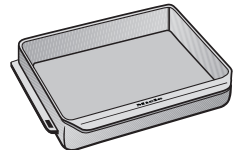

HBD 60-35

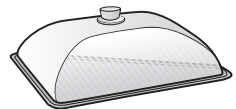

- * The oven dish cannot be used in conjunction with its lid in ovens with three shelf levels because the total height of these two items exceeds the height of the cavity.

Features

Accessories for cleaning and care

- Miele all purpose microfibre cloth
- Miele oven cleaner

Safety features

- **System lock** 
(see “Settings – Safety”)
- **Sensor lock**
(see “Settings – Safety”)
- **Cooling fan**
(see “Settings – Cooling fan run-on”)
- **Safety switch-off**

A function which does not use microwave power can be started without selecting a cooking duration. To prevent continuous use and avoid the risk of fire, the oven will switch itself off automatically after a certain time after the last operation depending on the function and temperature selected.

PerfectClean treated surfaces

Surfaces treated with PerfectClean enamel are characterised by their exceptional non-stick properties and ease of cleaning.

Food can be easily removed from these surfaces. Soiling from baking and roasting can be easily removed from these surfaces.

Food can be sliced or cut up on PerfectClean surfaces.

However, do not use ceramic knives as these will scratch the PerfectClean surface.

Surfaces treated with PerfectClean enamel can be cleaned as you would clean glass.

Read the instructions in “Cleaning and care” so that the benefits of the non-stick properties and easy cleaning are retained.

PerfectClean treated surfaces:

- Oven compartment
- Rack
- Round baking and AirFry tray, perforated
- Round baking tray

Before using for the first time

Miele@home

Your oven is equipped with an integrated Wi-Fi module.

In order to use it, you need:

- a Wi-Fi network
- the Miele App
- a Miele user account. The user account can be created via the Miele App.

The Miele App will guide you as you connect your oven to your home Wi-Fi network.

Once your oven is connected to your Wi-Fi network, you can use the App for a number of actions, including the following:

- Call up information on the operating status of your oven
- Retrieve information on cooking processes that are in progress
- End cooking programmes that are in progress

Connecting your oven to your Wi-Fi network will increase energy consumption, even when the oven is switched off.

Make sure that the signal of your Wi-Fi network is sufficiently strong in the place where your oven is installed.

Availability of the Wi-Fi connection

The Wi-Fi connection shares a frequency range with other appliances (including microwave ovens and remote control toys). This may result in sporadic or even complete connection failures. Therefore, a constant availability of featured functions cannot be guaranteed.

Miele@home availability

The ability to use the Miele App depends on the availability of the Miele@home service in your country.

The Miele@home service is not available in every country.

For information about availability, please visit www.miele.com.

Miele App

You can download the Miele App from the Apple App Store® or the Google Play Store™ free of charge (only functional in selected countries).



Before using for the first time

Standard settings

The following settings must be made before starting up for the first time. You can change these settings again at a later time (see “Settings”).

 Risk of injury caused by hot surfaces.

The oven gets hot during operation. For safety reasons, the oven may only be used when it has been fully installed.

The oven will switch on automatically when it is connected to the electricity supply.

Setting the language

- Select the language you want.

If you have accidentally selected a language that you don't understand, proceed as described in “Settings – Language ”.

Setting the location

- Select the required location.

Setting up Miele@home

Set up “Miele@home” appears in the display.

- To set up Miele@home immediately, select *Continue* and confirm with *OK*.
- To set it up at a later date, select *Skip* and confirm with *OK*. See “Settings – Miele@home” for information on setting up at a later date.
- To set up Miele@home immediately, select the desired connection method.

You will then be guided by the display and the Miele App.

Setting the date

- Set the year, then the month, and finally the day.
- Confirm with *OK*.

Setting the time of day

- Set the time of day in hours and minutes.
- Confirm with *OK*.

Completing the commissioning process

- Follow any further instructions in the display.

The appliance is now ready for use.

Before using for the first time

Heating up the oven for the first time

When the oven is heated up for the first time, it may give off a slight smell. This can be eliminated by heating the empty oven for at least an hour.

Ensure that the kitchen is well ventilated while the appliance is being heated up for the first time. Prevent odours from escaping into other rooms.

- Remove any protective foil and stickers, except the data plate, from the oven and accessories.
- Take all accessories out of the oven compartment and clean them (see “Cleaning and care”).
- Before heating the oven up, wipe the interior with a damp cloth to remove any dust or bits of packaging that may have accumulated during storage and unpacking.
- Switch the oven on with the On/Off  sensor.

Select function appears in the display.

- Select Fan Plus .

The recommended temperature will appear (160 °C).

The oven heating, lighting and cooling fan will switch on.

- Set the maximum possible temperature (250 °C).
- Confirm with *OK*.

Heat up the empty oven for at least one hour.

- Switch the oven off with the On/Off  sensor after at least one hour.

Cleaning the oven compartment after heating it up for the first time

 Risk of injury caused by hot surfaces.

The oven gets hot during operation. You could burn yourself on the heating elements and the oven interior.





Allow the heating elements and oven compartment to cool down before manual cleaning.

- Clean the oven compartment with a clean sponge and a solution of hot water and washing-up liquid or a clean, damp microfibre cloth.
- Dry all surfaces with a soft cloth.

Leave the oven door open until the oven interior is completely dry.

Settings

Settings overview

Menu option	Available settings
Language 	... deutsch english ... Location
Time	Show On* Off Night dimming Clock format 12 h 24 h* Set
Date	
Lighting	On "On" for 15 seconds* Off
Display	Brightness  * QuickTouch On Off*
Volume	Buzzer tones Melodies  * Solo tone  * Keypad tone  * Welcome melody On* Off
Units	Weight g* lb/oz lb Temperature °C* °F
Quick MW	Power level Duration
Popcorn	Duration
Booster	On* Off
Recommended temperatures	
Recommended power levels	

* Factory settings



Menu option	Available settings
Cooling fan run-on	Temperature-controlled* Time-controlled
Safety	Sensor lock On Off* System lock  On Off*
Miele@home	Activate Deactivate Connection status Set up again Reset Set up
Remote control	On* Off
RemoteUpdate	On* Off
Software version	
Showroom programme	Demo mode On Off*
Factory default	Appliance settings User programmes Recommended power levels Recommended temperatures

* Factory settings

Settings

Opening the “Settings” menu

In the Other  | Settings menu, you can personalise your oven by adapting the factory default settings to suit your requirements.



- Select Other .
- Select Settings .
- Select the desired setting.

You can check settings or change them.

Settings cannot be altered while a cooking programme is in progress.

Language

You can set your language and location. After selecting and confirming your choice, the language you have selected will appear in the display.

Useful tip: If you have selected the wrong language by mistake, select the  sensor. Follow the  symbol to get back to the Language  sub-menu.

Time

Show

Select how you want the time of day to appear in the display when the oven is switched off:

- On
The time is always visible in the display.
If you also select the Display | QuickTouch | On setting, all sensors react to touch as normal.
If you also select the Display | QuickTouch | Off setting, the oven has to be switched on before it can be used.

- Off
The display is dark to save energy. The oven has to be switched on before you can use it.
- Night dimming
To save energy, the time is only visible in the display between 5:00 am and 11:00 pm. The display remains dark at all other times.

Clock format

The time of day can be displayed in the 24 or 12-hour format (24 h or 12 h).

Set

Set the hours and then the minutes.

If there is a power cut, the current time of day will reappear once power has been restored. The time of day is saved for approx. 150 hours.

If the oven has been connected to a Wi-Fi network and signed into the Miele App, the time will be synchronised based on the location setting in the Miele App.

Date

Set the date.

Lighting



- On
The oven interior lighting is switched on during the entire cooking period.
- “On” for 15 seconds
The oven interior lighting switches off 15 seconds after a cooking programme has begun. Press the  sensor to switch the oven interior lighting on again for 15 seconds.

- Off
The oven interior lighting is switched off. Press the  sensor to switch on the oven interior lighting for 15 seconds.

Display

Brightness

The display brightness is represented by a segment bar.

- 
Maximum brightness
- 
Minimum brightness

QuickTouch

Select how the sensors should respond when the oven is switched off:

- On
If you have also selected the Time | Show | On or Night dimming setting, the sensors will also respond when the oven is switched off.
- Off
Independently of the Time | Show setting, the sensors only respond when the oven is switched on, as well as for a certain amount of time after switching it off.

Volume



Buzzer tones

If buzzers are switched on, a buzzer will sound when the set temperature is reached and at the end of a set time.

Melodies

At the end of a process, a melody will sound several times at intervals.



The volume of the melody is represented by a segment bar.

- 
Maximum volume
- 
Melody is switched off

Solo tone



At the end of a process, a continuous tone will sound for a period of time.

The pitch of this continuous tone is represented by a segment bar.

- 
Highest pitch
- 
Lowest pitch

Keypad tone

The volume of the tone that sounds each time you touch a sensor is represented by a segment bar.

- 
Maximum volume
- 
Keypad tone is switched off

Welcome melody

The melody that sounds when you touch the On/Off  sensor can be switched on or off.

Units

Weight

For Automatic programmes, you can set the weight of food in grams (g), pounds/ounces (lb/oz) or pounds (lb).

Temperature

You can set the temperature in degrees Celsius (°C) or degrees Fahrenheit (°F).

Settings

Quick MW

The maximum microwave power level of 1000 W and the maximum cooking duration of 1 minute are preset for starting the microwave function immediately.

- Power level

The following microwave power levels can be selected: 80 W, 150 W, 300 W, 450 W, 600 W, 850 W or 1000 W.

- Duration

The maximum cooking duration that can be set depends on the microwave power level selected:

80–300 W: maximum 10 minutes

450–1000 W: maximum 5 minutes

Popcorn

A microwave power level of 850 W and a cooking duration of 2:50 minutes is preset so that you can start cooking a bag of microwave popcorn immediately. These settings match the manufacturer's instructions on most bags of microwave popcorn.

The maximum cooking duration that can be set is 4 minutes.

The microwave power level is set and cannot be modified.

Booster

The **Booster** function is used to quickly pre-heat the oven compartment in some functions.

- On

The **Booster** function is automatically switched on during the heating-up phase of a cooking programme. The grill element, ring heating element and hot air fan pre-heat the oven compartment to the set temperature at the same time.

- Off

The **Booster** function is switched off during the heating-up phase of a cooking programme. Only the heating elements for the selected oven function are used to pre-heat the oven compartment.

Recommended temperatures

If you frequently cook with different temperatures, it makes sense to change the recommended temperatures.

After selecting this option, a list of oven functions will appear in the display.

■ Select the function you want.

The recommended temperature will appear together with the range within which it can be changed.

■ Change the recommended temperature.

■ Confirm with *OK*.





Changing the recommended temperatures also affects the corresponding function which uses microwave power.

Recommended power levels

If you frequently cook with different power levels, it makes sense to change the recommended microwave power levels.

You can change the recommended power levels for the Microwave  function and for the functions which use microwave power.

After selecting this option, a list of functions will appear in the display together with their recommended power levels.

- Microwave :
80 W, 150 W, 300 W, 450 W, 600 W, 850 W, 1000 W
- MW + Auto Roast , MW + Fan Plus , MW + Grill  and MW + Fan Grill :
80 W, 150 W, 300 W

- Select the function you want.
- Change the recommended power level.
- Confirm with *OK*.

Cooling fan run-on

The cooling fan will continue to run for a while after the oven has been switched off to prevent any humidity building up in the oven compartment, on the control panel or on the oven housing unit.

- Temperature-controlled
The cooling fan switches off when the temperature in the oven drops below 70 °C.
- Time-controlled
The cooling fan switches off after a period of about 25 minutes.

Condensate can damage the oven housing unit, damage the worktop and lead to corrosion in the oven.

If you have set the cooling fan to Time-controlled and leave food in the oven compartment to keep warm, moisture levels in the oven will increase, leading to condensation forming on the fascia panel and surrounding kitchen furniture, and drops of moisture collecting under the worktop.

Do not leave food in the oven to keep it warm if you have set the cooling fan to Time-controlled.

Safety

Sensor lock

The sensor lock prevents the cooking programme being switched off by mistake or settings being changed. Apart from the On/Off  sensor, the activated sensor lock prevents the sensors and fields in the display from working a few seconds after a programme has been started.

- On
The sensor lock is switched on. Touch the *OK* sensor for at least 6 seconds to deactivate the sensor lock for a short period of time.
- Off
The sensor lock is deactivated. All sensor controls react to touch as normal.

If you want to switch off the appliance with the sensor lock activated, touch the On/Off  sensor until the appliance switches off.

Settings

System lock

The system lock prevents the oven being switched on by mistake.

The minute minder and the MobileStart function can still be used when the system lock is active.

The system lock will remain activated even after a power failure.

- On
The system lock is switched on. Before you can use the oven, touch the *OK* sensor for at least 6 seconds.
- Off
The system lock is deactivated. You can use the oven as normal.

Miele@home

The oven is a Miele@home compatible appliance. Your oven is fitted ex-works with a Wi-Fi communication module and is suitable for wireless communication.

There are a number of ways of connecting your oven to your Wi-Fi network. We recommend connecting your oven to your Wi-Fi network with the help of the Miele App or via WPS.

- Activate
This setting is only visible if Miele@home is deactivated. The Wi-Fi function is reactivated.
- Deactivate
This setting is only visible if Miele@home is activated. Miele@home remains set up, the Wi-Fi function is switched off.
- Connection status
This setting is only visible if Miele@home is activated. The display

shows information such as the Wi-Fi reception quality, network name and IP address.

- Set up again
This setting is only visible if a Wi-Fi network has already been set up. Reset the network settings and immediately set up a new network connection.
- Reset
This setting is only visible if a Wi-Fi network has already been set up. The Wi-Fi function is deactivated and the Wi-Fi network will be reset to the factory default. You must set up a new connection to the Wi-Fi network to be able to use Miele@home. The network settings should be reset whenever the oven is being disposed of or sold, or if a used oven is being put into operation. This is the only way to ensure that all personal data has been removed and, in the case of the latter, the previous owner will no longer be able to access the oven.
- Set up
This setting is only visible if no connection to the Wi-Fi network has been set up yet. You must set up a new connection to the Wi-Fi network to be able to use Miele@home.

Performing Scan & Connect

Initial commissioning has been carried out without Miele@home having been set up.

- Scan the QR code.

If you have installed the Miele App and have a user account, you will be taken directly to the networking steps.

If you have not yet installed the Miele App, you will be taken to the Apple App Store® or the Google Play Store™.

- Install the Miele App and set up a user account.
- Scan the QR code again.

The Miele App will guide you through the set-up process.



RemoteUpdate

The RemoteUpdate menu option is only displayed and can only be selected if the requirements for using Miele@home have been met (see “Before using for the first time – Miele@home” or “Settings”).

The RemoteUpdate function is used for updating the software in your oven. If an update is available for your oven, it will automatically download it. Updates will not be installed automatically. They must be initiated manually.

If you do not install an update, you can continue to use your oven as usual. However, Miele recommends installing updates.

Switching on/Switching off

RemoteUpdate is switched on as standard. Available updates will be downloaded automatically and will only be installed if you initiate it.

Switch off RemoteUpdate if you do not wish any updates to be downloaded.

Running a RemoteUpdate

Information about the content and scope of an update is provided in the Miele App.

A message will appear in your oven display if a software update is available.

You can install the update immediately or postpone this until later. When the oven is switched on again, you will be reminded about the update.

Switch RemoteUpdate off if you do not wish to install updates.

The update can take several minutes.

Please note the following information about the RemoteUpdate function:

- You will only receive a message when an update is available.
- Once an update has been installed, it cannot be undone.
- Do not switch the oven off during the update. Otherwise, the update will be aborted and will not be installed.
- Some software updates can only be carried out by a Miele service technician.

Settings

Remote control

If you have installed the Miele App on your mobile device, have access to the Miele@home system and have activated the remote control function (On), you can use the MobileStart function to retrieve information on oven cooking programmes currently in progress or to end a programme in progress.

Activating MobileStart

- Select the  sensor to activate MobileStart.

The  sensor lights up. You can operate your oven remotely with the Miele App.

Directly operating the oven takes priority over operating it via the remote control function on the App.

You can use MobileStart as long as the  sensor is lit up.

Software version

The software version menu option is for use by Miele service technicians. You do not need this information for domestic use.

Showroom programme

This function enables the oven to be demonstrated in showrooms without heating up. Do not activate this setting for domestic use.

Demo mode

If you switch the oven on whilst it is in Demo mode, the following message will appear in the display: Demo mode is activated. The appliance will not heat up.

- On
Touch the *OK* sensor for at least 4 seconds to activate Demo mode.
- Off
Touch the *OK* sensor for at least 4 seconds to deactivate Demo mode. You can use the oven as normal.

Factory default

- Appliance settings
Any settings that have been altered will be reset to the factory default settings.
- User programmes
All User programmes will be deleted.
- Recommended power levels
Microwave power levels which have been changed will be reset to the factory default settings.
- Recommended temperatures
Any recommended temperatures that have been changed will be reset to the factory default settings.

Operating hours

Select Other  | Operating hours to query the total number of operating hours of your oven.

Using the Minute minder function

The  minute minder can be used to time other activities in the kitchen, e.g. boiling eggs on the cooktop.

The minute minder can also be used at the same time as a cooking programme for which the cooking duration start and finish times have been set (e.g. as a reminder to stir the food or add seasoning, etc.).

- The maximum minute minder time that can be set is 59 minutes and 59 seconds.

Setting the minute minder

If you have selected the Display | QuickTouch | Off setting, you will need to switch the oven on before setting the minute minder. The minute minder can then be seen counting down in the display when the oven is switched off.

- Select the  sensor.
- Select Minute minder if a cooking programme is in progress at the same time.

The prompt Set 00:00 min will appear.

- Using the navigation area, set 06:20.
- Confirm with *OK*.

The minute minder duration is now saved.

When the oven is switched off, the minute minder time counts down in the display and  appears instead of the time of day.

If you are cooking at the same time,  and the minute minder time will appear at the bottom of the display.

If you are in a menu, the minute minder will count down in the background.

At the end of the minute minder time  will flash, the time will start counting up and a buzzer will sound.

- Select the  sensor.
- If required, confirm with *OK*.

The buzzer will stop and the symbols in the display will go out.

Changing the time set for the minute minder

- Select the  sensor.
- Select Minute minder if a cooking programme is in progress at the same time.
- Select Change.
- Confirm with *OK*.

The minute minder time selected appears.

- Change the time set for the minute minder.
- Confirm with *OK*.









The altered minute minder time is now saved.

Cancelling the minute minder



- Select the  sensor.
- Select Minute minder if a cooking programme is in progress at the same time.
- Select Delete.
- Confirm with *OK*.

The minute minder is now cancelled.

Main and sub-menus

Menu	Recommended value	Range
Oven functions		
Fan Plus 	160 °C	30–250 °C
Auto Roast 	160 °C	100–230 °C
Grill 	3	1–3
Microwave 	1000 W	80–1000 W
MW + Fan Plus 	300 W 160 °C	80–300 W 30–220 °C
MW + Fan Grill 	300 W 200 °C	80–300 W 100–200 °C
Defrost 	25 °C	25–50 °C
Popcorn 	850 W	–
Automatic programmes 		

Main and sub-menus

Menu	Recommended value	Range
Other 		
MW + Grill	300 W 3	80–300 W 1–3
MW + Auto Roast	300 W 160 °C	80–300 W 100–200 °C
Eco Fan Heat	190 °C	100–230 °C
Fan Grill	200 °C	100–220 °C
Defrost	–	–
Reheat	–	–
Drying	60 °C	30–70 °C
Heat crockery	80 °C	50–100 °C
Prove yeast dough	35 °C	30–50 °C
Keeping warm	75 °C	60–90 °C
User programmes		
Settings 		
Operating hours		

Microwave operation

How it works

The oven contains a magnetron that converts electrical energy into electromagnetic waves (microwaves). These microwaves are distributed evenly throughout the oven compartment and are reflected off the metal appliance walls.

The microwaves penetrate the food from all sides. Food consists of many molecules. When subjected to microwave energy, these molecules (particularly the water molecules) start to oscillate. This heats the food from the outside to the inside. The more water a food contains, the faster it is heated or cooked.

Advantages of the microwave oven

- Food can generally be cooked with little or no liquid or cooking oil.
- The times for defrosting, reheating or cooking are shorter than with a cooktop or oven.
- Vitamins, minerals, natural colour, and taste of the food are generally retained.

If the oven is used without food or the food is loaded incorrectly when using the Microwave  function or functions that use microwave power, the oven can become damaged.

Always use the glass tray with the Microwave  function, even if you use it as a container for smaller dishes.

Suitable crockery

In order for microwaves to reach the food, they must be able to penetrate the crockery being used. Microwaves can pass through porcelain, glass, cardboard and plastics, but not metal. Therefore, do not use metal containers or crockery that contains metal. Metal reflects the microwaves which can create sparks and the microwaves are not absorbed by the metal.

 Risk of injury from increased pressure in sealed containers or bottles.

Pressure can build up when reheating food or drinks in sealed containers, jars or bottles, which can cause them to explode.

Never cook or reheat solid or liquid food in sealed containers or bottles. Open containers beforehand. In the case of baby bottles, the screw top and teat must be removed.

 Fire hazard due to using unsuitable crockery for functions which use microwave power.

Non-microwave safe dishes used in microwave mode can suffer damage or cause damage to the oven.

Only use microwave safe crockery for functions which use microwave power.

The material and shape of containers used affect cooking results and times. Heat distribution is more even in round and oval shaped flat containers than in rectangular containers, providing better results.

Suitable containers

 Fire hazard due to inflammable materials.

Disposable containers made out of plastic, paper or other inflammable materials can ignite, causing damage to the oven.

Do not leave the oven unattended when reheating or cooking food in disposable containers made of plastic, paper or other inflammable materials.

You can use the following crockery and material:

- Heat-resistant glass and ceramic glass
Exception: crystal glass as it contains lead and may crack.
- Porcelain
 - Without metallic decoration
Metallic decoration (e.g. gold rims or cobalt blue) can cause sparking.
 - Without hollow knobs and handles
Moisture can gather in the hollow knobs and handles. When the moisture evaporates, pressure can build up and the item can explode.
- Unpainted stoneware and stoneware with underglaze paints

 Risk of injury caused by hot crockery.

Earthenware can get very hot and may crack.





Wear oven gloves when using stoneware.

- Plastic containers and plastic disposable containers with the Microwave  function

Useful tip: To protect the environment, avoid the use of disposable containers.

Plastics must be heat-resistant to a minimum of 110 °C. Otherwise the plastic may melt and fuse with the food.

Only use plastic containers with the Microwave  function.

Do not use plastic containers with the MW + Auto Roast , MW + Fan Plus , MW + Grill  or MW + Fan Grill  functions.

- Microwave safe plastic containers
Special plastic containers designed for use in microwave ovens are available from retail outlets.
- Styrofoam containers
For briefly heating food.
- Plastic boiling bags
For cooking and reheating. They should be pierced beforehand. The holes allow the steam to escape. This prevents a build-up of pressure from forming and the bag from bursting. There are also special bags available for steam cooking which do not need to be pierced. Please follow the instructions given on the packet.
- Roasting bags and tubes
Please follow the manufacturer's instructions.









 Fire hazard due to metal parts.

Metal parts such as metal clips or plastic and paper ties that have wire running through them can heat inflammable materials until they burn.

Do not use metal clips, or plastic and paper ties containing wire.

Microwave operation

Useful tip: Metal tins are less suitable for functions which use microwave power because the metal reflects the microwaves. The microwaves only reach the cake from above, which extends the baking time. If you use metal tins, place the tin on the glass tray so that it cannot touch the oven walls. If sparks form, do not reuse the tin for functions which use microwave power.

- The **supplied** rack is only suitable for cooking programmes with the MW + Auto Roast , MW + Fan Plus , MW + Grill  and MW + Fan Grill  functions, as well as for functions which do not use microwave power (placed on one level)
- Metal baking tins for baking with the MW + Auto Roast , MW + Fan Plus , MW + Grill  and MW + Fan Grill  functions as well as for functions which do not use microwave power
- Aluminium foil trays without lids for defrosting and reheating ready meals. The food is only heated from the top. If you remove the food from the aluminium foil container and transfer it to crockery suitable for use in a microwave oven, the heat distribution will generally be more even.

Using aluminium foil trays and aluminium foil can cause crackling and sparks.

Therefore, place aluminium foil trays on the glass tray and not on the rack. Aluminium foil and aluminium foil trays must not touch the oven compartment walls and must remain at least 2 cm from the walls at all times.

- Metal meat skewers or clamps. The size of the cut of meat must be much larger than the metal skewers and clamps.

Unsuitable containers

Crockery and lids with hollow handles or knobs can collect moisture in the hollow spaces. When the moisture evaporates, pressure can build up and the item can explode. If the hollow recess is sufficiently ventilated, the item can be used.

Do not use crockery with hollow knobs or handles for cooking.

Do **not** use the following crockery and material:

- Metal racks (including the supplied rack) are **not** suitable for use with the Microwave  function
- Metal containers
- Aluminium foil. Exception: for even defrosting, reheating or cooking unevenly shaped cuts of meat, e.g. poultry, small pieces of aluminium foil may be used to cover thin parts for the last few minutes of the programme
- Metal clips, plastic or paper ties containing wire
- Plastic containers where the aluminium lid has not been completely removed
- Crystal glass
- Cutlery and crockery with metallic decoration (e.g. gold rims, cobalt blue)
- Crockery with hollow handles
- Plasticware made of melamine. Melamine absorbs microwave energy and gets hot. When purchasing plasticware, make sure that it is suitable for use in a microwave oven.
- Wooden dishes. Water contained in wood evaporates during the cooking programme. This causes the wood to dry and crack.

Testing dishes for their suitability

Unsuitable crockery can cause sparks or crackling noises in microwave operation. If you are not sure whether glass, porcelain or stoneware crockery is suitable, test the dishes.

This test cannot be used to check whether items with hollow knobs or handles are suitable for use.

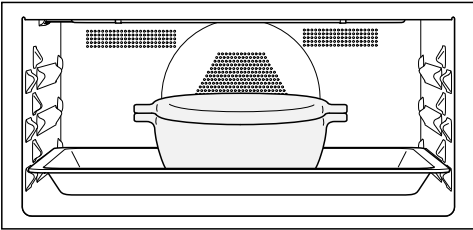

- Place the empty crockery in the middle of the glass tray and insert the tray in shelf level 1.

- Close the door.
- Select the Microwave  function.
- Set the highest microwave power level (1000 W) and a cooking duration of 30 seconds.
- Start the programme.
- Observe the crockery during the entire duration.
- Immediately open the door if there are sparks or crackling noises.

If there are sparks or if you can hear crackling noises, the tested crockery is not suitable for microwave use.

Microwave operation

Cover

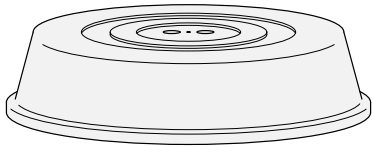



Useful tip: Covers are available from retail outlets.

- A cover prevents too much steam escaping, especially when cooking foods which need longer to cook.
- It speeds up the heating process of the food.
- It prevents food from drying out.
- It helps keep the oven interior clean.

- Use a glass or plastic cover suitable for microwave use for cooking programmes with the Microwave  function.

Alternatively, use a cling film suitable for use in a microwave oven. Heat can cause normal cling film to distort and fuse with the food.





The cover must be able to withstand temperatures of up to 110 °C. At higher temperatures (e.g. in the Grill  or Fan Plus  functions), the plastic may distort and fuse with the food.

Only use a cover for the Microwave  function.

The cover should not form a seal with the container. If the container has a narrow diameter, the steam may not be able to escape. The cover could get too hot and start to melt.

Use containers with a sufficiently large diameter.

- Do **not** use a cover for reheating the following types of food:

- Food coated in breadcrumbs
- Food which requires a crisp finish, e.g. toast
- Food which must be heated with the MW + Auto Roast , MW + Fan Plus , MW + Grill  or MW + Fan Grill  functions

If you place food directly on the floor of the oven when using the Microwave  function, the oven can become damaged.

When using the Microwave  function, place the glass tray on shelf level 1 and **always** place cooking containers on the glass tray.

- Switch the oven on.

The main menu will appear.

- Place the food in the oven.
- Select the function you want.

The function will appear in the display. Depending on the function, the recommended power level, recommended temperatures and the cooking duration will appear one after the other in the display.

- Change the recommended values for the cooking programme and set the cooking duration if required.

Using the  sensor, you can change the recommended values later if needed.

- Confirm each entry with *OK*.
Confirming the temperature starts the cooking process for functions which **do not use** microwave power.

For functions **which use** microwave power, a summary of the settings appears and *Start* is highlighted in the display.

- Use the *OK* sensor to start the cooking process for functions **which use** microwave power.

The set values appear and the cooking duration counts down in the display for all functions.

If you have set a temperature, you will see the temperature increasing. A buzzer will

sound when the selected temperature is reached for the first time.

The oven stops generating microwave power when you interrupt the cooking programme or open the door. You can continue the programme with the *OK* sensor.

- After cooking, select the sensor for the selected function to end the cooking programme.
- Take the food out of the oven.
- Switch the oven off.

Changing values and settings for a cooking programme

Depending on the function, as soon as a cooking programme is in progress, you can use the  sensor to change the values or settings for this programme.

- Select the  sensor.

Depending on the function, the following settings appear:

- Temperature
- Power level
- Duration
- Finish at
- Start at
- Booster
- Pre-heat



Changing values and settings

- Select the desired value or setting and confirm with *OK*.
- Change the value or setting and confirm with *OK*.

The cooking programme will continue with the new values and settings.

Operation

Changing the temperature

You can permanently reset the recommended temperature to suit your cooking preferences by selecting Other  | Settings  | Recommended temperatures.

- Select the \wedge or \vee arrow sensor or swipe to the right or left in the  area.

The target temperature appears in the display.

- Change the target temperature via the navigation area.



The temperature changes in 5 °C steps.

- Confirm with *OK*.

The cooking programme will restart with the new target temperature.

Changing the microwave power level

You can change the microwave power level for the Microwave  function and for functions which use microwave power.

Select Other  | Settings  | Recommended power levels to permanently set the recommended power level to suit your personal cooking preferences.

- Select the \leftarrow sensor.

The set microwave power level appears in the display.

- Change the microwave power level via the navigation area.

You can set the following microwave power levels: 80 W, 150 W, 300 W, 450 W, 600 W, 850 W, 1000 W.

- Confirm with *OK*.

Start will be highlighted.

- Select the *OK* sensor.

The process will restart with the new microwave power level.



Setting cooking durations

Cooking results can be adversely affected if there is a long delay between the food being placed in the oven and the start of cooking. Fresh food can change colour and even spoil. When baking, the cake mixture or dough can dry out, and the raising agents can lose their effectiveness. Select as short a time as possible until the start of the cooking process.

Example: You have placed the food in the oven compartment, selected a function and the required settings such as the temperature.

By entering Duration, Finish at or Start at via the  sensor, you can automatically switch the cooking programme off, or on and off.

- Duration
Enter the required cooking duration for the food. The heating will switch off automatically once this duration has elapsed. The maximum cooking duration that can be set depends on the function that you have selected.
- Finish at
Specify when you want the cooking programme to finish. The oven heating will switch off automatically at the time you have set.
- Start at
This function will only appear in the menu if you have set a Duration or Finish at time. With Start at, you have to specify when you want the cooking programme to start. The oven heating will switch on automatically at the time you have set.

- Select the  sensor.
- Set the required times.
- Confirm with *OK*.
- Touch the  sensor to return to the menu of the selected function.

Changing the set cooking durations

- Select the  sensor.
- Select the time you want.
- Confirm with *OK*.
- Select *Change*.

This menu option does not appear if you want to change the cooking duration for functions **which use** microwave power, as these functions always require a set cooking duration.

The time will be highlighted.

- Change the set time.
- Confirm with *OK*.
- Touch the  sensor to return to the menu of the selected function.
- Use the *OK* sensor to continue the cooking programme for functions **which use** microwave power.

These settings will be deleted in the event of a power failure.

Useful tip: You can also change the cooking duration for the Microwave  function via the navigation area.

Deleting the set cooking durations

For a function **which uses** microwave power, you can only delete the set times for Finish at and Start at. The cooking duration must always be set.

- Select the  sensor.
- Select the time you want.

- Confirm with *OK*.
- Select *Delete*.
- Confirm with *OK*.
- Touch the  sensor to return to the menu of the selected function.

If you delete Duration for a function which **does not use** microwave power, the set times for Finish at and Start at are also deleted.

If you delete Finish at or Start at, the cooking programme will start using the cooking duration set.

Interrupting a cooking programme in the Microwave function

You can interrupt cooking when using the Microwave  function and pause the cooking duration.

During the cooking duration, Stop will be highlighted.

- Select the *OK* sensor.

Cooking is interrupted and the cooking duration is paused.

Start will be highlighted.

- Select the *OK* sensor.

The cooking programme resumes and the cooking duration continues to count down.

Cancelling cooking

You can cancel a cooking programme using the function sensor that lights up orange or using the  sensor.

The oven compartment heating and lighting will then switch off. Any cooking durations set will be deleted.

Touch the function sensor to return to the main menu.

Operation

Cancelling a cooking programme without a set cooking duration

- Touch the sensor for the selected function.

The main menu will appear.

- **Or:** select the ↩ sensor.
- Select Cancel process.
- Confirm with *OK*.

Cancelling a cooking programme with a set cooking duration

- Touch the sensor for the selected function.

Cancel process? appears in the display.

- Select Yes.
- Confirm with *OK*.
- **Or:** select the ↩ sensor.
- Select Cancel process.
- Confirm with *OK*.
- Select Yes.
- Confirm with *OK*.

Pre-heating the oven

The **Booster** function is used to quickly heat up the oven compartment in some functions.

The **Pre-heat** function can be used with any function (except Microwave ) and has to be switched on separately for each cooking programme.



If you have set a cooking duration, it will only start to count down after the heating-up phase.





It is only necessary to pre-heat the oven in a few instances.

- Most dishes can be placed in a cold oven. They will then make use of the heat produced during the heating-up phase.
- For dark bread dough as well as beef sirloin joints and fillets, pre-heat the oven compartment when using the **Fan Plus**  function.

Booster

The **Booster** function is used to quickly pre-heat the oven compartment in some functions.

This function is switched on as the factory default setting for the following functions (Other  | Settings  | **Booster** | On):

- Fan Plus 
- Auto Roast 
- MW + Fan Plus 
- MW + Auto Roast 

If you set a temperature above 100 °C and the **Booster** function is switched on, a rapid heating-up phase heats the oven compartment to the set temperature. The grill element and ring heating element come on together with the hot air fan.

Delicate items (e.g. sponge or biscuits) will brown too quickly on the top if the **Booster** function is used. Switch off the **Booster** function for these items.

Switching Booster on or off for a cooking programme

If you have selected the **Booster | On** setting, you can switch off the function separately for a cooking programme.

On the other hand, you can also switch on the function separately for a cooking programme if you have selected the **Booster | Off** setting.

Example: You have selected a function and the required settings such as the temperature.

You want to switch off the **Booster** function for this cooking programme.

- Select the  sensor.
- Select **Booster | Off**.
- Confirm with **OK**.

The **Booster** function is switched off during the heating-up phase. Only the heating elements for the selected oven function are used to pre-heat the oven compartment.

Pre-heat

It is only necessary to pre-heat the oven in a few instances.

You can place most dishes in the cold oven compartment to make use of the heat produced during the heating-up phase.

If you have set a cooking duration, it will only start to count down when the target temperature is reached and you have placed the food in the oven.

Start the cooking programme immediately without delaying the start time.

The **Pre-heat** function is not available with the **Microwave**  operating mode.

Switching on the Pre-heat function

The **Pre-heat** function can be used with any oven function and has to be switched on separately for each cooking programme.

Example: You have selected a function and the required settings such as the temperature.

You want to switch on the **Pre-heat** function for this cooking programme.

- Select the  sensor.
- Select **Pre-heat | On**.
- Confirm with **OK**.

The following message is displayed with a time: **Place food in oven at ...** The oven compartment is heated to the set temperature.

- As soon as you are prompted to do so, place the food in the oven compartment.
- Confirm with **OK**.

Quick MW and Popcorn

These functions can only be used when no other cooking programmes are in use.

Always use the glass tray.

Quick MW

If you select the  sensor, the oven starts with a set microwave power level and cooking duration, e.g. to reheat a drink.

The maximum power level of 1000 W and a maximum duration of 1 minute are preset.

You can change the microwave power level and the cooking duration. The maximum cooking duration that can be set depends on the microwave power level selected (see “Settings – Quick MW”).

- Select the  sensor.

Touching it repeatedly increases the cooking duration in increments.

The time left will appear in the display.

You can interrupt and resume the cooking programme at any time by touching the *OK* sensor or cancel it with the  sensor.

At the end of the cooking programme, *Finished* appears in the display and a buzzer sounds.

- Select the  sensor.

The main menu will appear.

Popcorn

If you select the  sensor, the oven starts with a set microwave power level and cooking duration.

A microwave power level of 850 W and a maximum cooking duration of 2:50 minutes are preset. These settings match the manufacturer’s instructions on most bags of microwave popcorn.

The maximum cooking duration that can be set is 4 minutes. The microwave power level is set and cannot be modified (see “Settings – Popcorn”).

- Select the  sensor.

The time left will appear in the display.

You can interrupt and resume the cooking programme at any time by touching the *OK* sensor or cancel it with the  sensor.

Disposable containers made out of paper or other inflammable materials can ignite, causing damage to the oven.

Do not leave the oven unattended during this programme and make sure you follow the instructions on the packaging.

At the end of the cooking programme, *Finished* appears in the display and a buzzer sounds.

- Select the  sensor.

The main menu will appear.

The wide range of Automatic programmes enable you to achieve excellent results with ease.

Categories

The **Auto** Automatic programmes are sorted into categories to provide a better overview. Simply select the appropriate Automatic programme for the type of food you are cooking and follow the instructions in the display.

Using Automatic programmes

- Select Automatic programmes **Auto**.

A list will appear.

- Select the desired food category.

The Automatic programmes available for the food type selected will then appear.

- Select the Automatic programme that you want to use.
- Follow the instructions in the display.

Useful tip: Use **i** Info to display information such as how to place or turn the food depending on the cooking programme.

Usage notes

- When using Automatic programmes, the recipes provided are designed as a guide only. Other similar recipes, including those using different quantities, can be used for the Automatic programme in question.
- After cooking, allow the oven compartment to cool down to room temperature again before starting an Automatic programme.
- Some Automatic programmes require a pre-heating phase before food can be placed in the oven. A prompt will appear in the display indicating when this needs to be done.
- Some Automatic programmes require the addition of liquid after a certain cooking duration. You will be prompted by a message in the display when this needs to be done (e.g for adding liquid).
- The duration quoted for Automatic programmes is an estimate. It may increase or decrease depending on the programme. The duration, in particular with meat, will vary depending on the initial temperature of the food.
- If by the end of an Automatic programme the food is not cooked enough, select **Continue cooking** or **Continue baking**. Conventional heating will then be used for 3 minutes to continue cooking or baking the food.



Other applications

This section provides information on the following applications:

- Defrost
- Reheat
- Drying
- Heat crockery
- Prove yeast dough
- Keeping warm
- Cooking
- Bottling
- Frozen food/Ready meals

Defrost

Gentle defrosting of frozen goods means that the vitamins and minerals are generally retained.

- Use one of the following functions and special applications:
 - Defrost  function
Set the defrosting temperature.
 - Other  | Defrost Special application
Select a category and the weight for the food.
 - Microwave  function
Set the microwave power level and the defrosting duration.



Risk of infection from bacteria.

Bacteria such as salmonella can cause life-threatening food poisoning. It is particularly important to observe food hygiene rules when defrosting fish and meat, and in particular when defrosting poultry.

Do not use the liquid produced during defrosting.

Process the food as required as soon as it has been defrosted.

Useful tips

- Place the food to be defrosted on the glass tray without its packaging.
- For defrosting poultry, use the glass tray with the rack placed on top of it. This way the frozen food will not be lying in the defrosted liquid.
- Meat and poultry need to be fully defrosted before cooking. Fish, on the other hand, can be partially defrosted before cooking. Defrost so that the surface is sufficiently soft to take herbs and seasoning.

Using the Defrost function

This function was developed to gently defrost frozen food.

- Select Defrost .
- Alter the recommended temperature if necessary.

Air is circulated throughout the oven compartment to gently defrost the frozen food.

Using the Defrost Special application

This programme has been developed for gently defrosting frozen food.

Only use heat-resistant containers which are microwave safe.

- Select Other .
- Select Defrost.

A list will appear.

- Select the type of food.
- Enter the weight of the food.

You can start the defrosting process immediately or delay the start and display the individual actions and cooking stages.

- Follow the instructions in the display.

Useful tips

- Use **i** Info to display information such as when to turn the frozen goods depending on the cooking programme.
- If the frozen food is not defrosted properly by the end of the defrosting process, select Cont. keep warm. The frozen food will continue to be heated for 3 minutes.
- After the defrosting process has ended, select  and then **i** / Save to save the settings for the selected category and weight as a User programme (see “User programmes”).

Using the Microwave function

Alternatively, you can use the Microwave  function for defrosting. Set the microwave power level and the defrosting duration.



The time required depends on the nature of the food, its initial temperature and the amount to be cooked. Take note of the standing times.

Only use heat-resistant containers which are microwave safe.

- Select Microwave .
- Depending on the type of food, set the microwave power level and the defrosting duration specified in the chart.
- You are generally advised to select the middle duration.
- Place the food on the glass tray on shelf level 1 in the oven.

Other applications

Defrosting with the Microwave function

Food to be defrosted	Quantity	 [W]	 [min.]	 [min.] ¹
Butter	250 g	80	8–10	5–10
Milk	1000 ml	450	12–16	10–15
Sand cake (3 slice)	Approx. 300 g	150	4–6	5–10
Fruit cake (3 slices)	Approx. 300 g	150	6–8	10–15
Butter cake (3 slices)	Approx. 300 g	150	6–8	5–10
Cream cake (3 slices)	Approx. 300 g	80	4–4:30	5–10
Yeast buns, puff pastries (3 pieces)	Approx. 300 g	150	6–8	5–10

 Microwave power level,  Defrosting duration,  Standing time

¹ Allow food to stand at room temperature. This allows the heat to spread evenly throughout the food.

Reheat

It is essential that “Warning and Safety instructions - Correct use” is observed.

 Risk of injury caused by hot food.

If food for babies and children is heated at too high a temperature, they can burn themselves.

Only heat food for babies and children for 30–60 seconds at 450 W.

After heating food, especially food for babies and small children, stir the food or shake the container and taste the food so that children do not get burned.

 Risk of injury from increased pressure in sealed containers or bottles.

Pressure can build up when reheating food or drinks in sealed containers, jars or bottles, which can cause them to explode.

Never cook or reheat food or liquids in sealed containers or bottles. Open containers beforehand. In the case of baby bottles, the screw top and teat must be removed.

Risk of injury caused by hot liquids.

When heating food, and in particular liquids, using the

Microwave  function, the boiling point may be reached without the production of typical bubbles. Liquids do not boil evenly throughout.

This boiling delay can result in the liquid boiling over explosively. Take care when taking the container out of the oven, as the hot liquid can cause severe scalding. Under certain circumstances, the pressure can be so high that the door opens automatically.

Stir liquids well before reheating or cooking.

After heating, wait at least 20 seconds before removing the container from the oven.

In addition, a glass rod or similar item, if available, can be placed in the container during heating.

Other applications

Using the Reheat Special application

This programme is designed for reheating food.

The time required depends on the nature of the food, its initial temperature and the amount to be cooked. For example, food taken straight from the refrigerator takes longer to reheat than food which has been kept at room temperature. Take note of the standing times.

Only use heat-resistant containers which are microwave safe.

Always cover food when reheating it, except when reheating meat/fish coated in breadcrumbs.

■ Place the food that is to be reheated on the glass tray with a cover.

■ Select Other .

■ Select Reheat.

A list will appear.

■ Select the type of food.

■ Enter the weight of the food.

■ Follow the instructions in the display.

 Risk of burning due to hot surfaces!



The oven gets hot during operation. You could burn yourself on the heating elements, the oven compartment, or accessories. Droplets of water may have accumulated underneath the crockery.

Use oven gloves when working in the hot oven compartment and when removing the crockery.



During the standing time, the temperature is distributed evenly in the food.

■ After heating, allow the food to stand at room temperature for a few minutes to enable the heat to spread evenly throughout the food.

Useful tips

- Always cover food when reheating it, except when reheating meat/fish coated in breadcrumbs.
- Use  Info to display information such as when to turn or stir the food. Stir the food from the outside towards the middle, as food heats more quickly from the outside.
- If the food is not hot enough at the end of the programme, select **Cont. keep warm**. The food will continue to be heated for 3 minutes.
- After the programme has finished, select  and then  / **Save** to save the settings for the selected category and weight as a User programme (see “User programmes”).

Reheating with the Microwave function

Drink/ Food	Quantity	 [W]	 [min.]	 ¹ [min.]
Drinks (drinking temperature 60–65 °C)	1 cup/1 glass (200 ml)	1000	00:50–1:10	–
Baby bottle (milk) ²	Approx. 200 ml	450	00:50–1:00 ³	1
Food for babies and children ³	1 jar (200 g)	450	00:30–1:00	1
Sliced meat with sauce ³	200 g	600	3:00–5:00	1
Side dishes ³	250 g	600	3:00–5:00	1

 Microwave power level,  Cooking duration,  Standing time

- ¹ Allow food to stand at room temperature. This allows the heat to spread evenly throughout the food.
- ² Flash boiling can be avoided by stirring liquids before heating them. After heating, wait at least 20 seconds before removing the container from the oven. In addition, a glass rod or similar item, if available, can be placed in the container during heating.
- ³ The durations apply to food with an initial temperature of approx. 5 °C. For food not normally refrigerated, durations apply to food at room temperature of approx. 20 °C. With the exception of baby food and delicate whisked sauces, food should be heated to a temperature of 70–75 °C.

Other applications

Drying

Drying is a traditional method of preserving fruit, certain vegetables and herbs.





It is important that fruit and vegetables are ripe and not bruised before they are dried.



- Prepare the food for drying by cutting it up, and peeling and coring it if necessary.
- Distribute the food for drying evenly in a single layer according to size over the rack or the glass tray.
- Dry on a maximum of 2 levels at the same time.
Place the food for drying on shelf levels 1+2.
If you are using both the rack and glass tray, insert the glass tray below the rack.
- Select Other .
- Select Drying.

Useful tip: If you want to dry at higher temperatures, select Fan Plus .

- Alter the recommended temperature if necessary and then set the drying time.
- Follow the instructions in the display.
- Turn the food for drying on the glass tray at regular intervals.

The drying times are longer for whole or halved food.

Food		🌡️ [°C]	🕒 [h]
Fruit		60–70	2–8
Vegetables		55–65	4–12
Mushrooms		45–50	5–10
Herbs		30–35	4–8

 Special application, 🌡️ Temperature, 🕒 Drying time,  Drying Special application

- Reduce the temperature if condensation begins to form in the oven.

Removing the dried food

 Risk of injury caused by hot surfaces.

The oven gets hot during operation. You could burn yourself on the heating elements, the oven compartment, or accessories. Use oven gloves when removing dried food from the oven.

- Allow the dried fruit or vegetables to cool down after drying.

Dried fruit needs to be completely dry, but also soft and elastic. Juice should not escape when cut.

- Store dried food in sealed glass jars or tins.

Heat crockery

By pre-heating the crockery, the food does not cool down as quickly.

Use heat-resistant crockery.

- Place the rack on shelf level 1 and place the crockery to be pre-heated on it. Depending on the size of the crockery, you can also place it on the oven floor.
- Select Other .
- Select Heat crockery.
- Alter the recommended temperature if necessary and then set the duration.
- Follow the instructions in the display.

 Risk of injury caused by hot surfaces.

The oven gets hot during operation. You could burn yourself on the heating elements, the oven compartment, or accessories. Droplets of water may have accumulated underneath the crockery.

Wear oven gloves when removing dishes from the oven.

Prove yeast dough

This programme is designed specifically for proving yeast dough.

- Select Other .
- Select Prove yeast dough.
- Alter the recommended temperature if necessary and then set the duration.
- Follow the instructions in the display.

Keeping warm

You can keep food warm in the oven compartment for several hours.

In order to maintain the quality of food, select the shortest possible time.

- Select Other .
- Select Keeping warm.
- Place the food to be kept warm in the oven and confirm with *OK*.
- Alter the recommended temperature if necessary and then set the duration.
- Follow the instructions in the display.

Other applications

Cooking

It is essential that “Warning and Safety instructions - Correct use” is observed.



Food with a thick skin or peel, such as tomatoes, sausage, potatoes and eggplants can burst when heated or cooked.

Pierce or score the skin of these types of food several times to allow steam to escape.





Eggs heated in their shells can burst, even after they have been taken out of the oven compartment.

Eggs can only be cooked in their shells in a specially designed egg-boiling device. Do not reheat hard boiled eggs using the Microwave  function.

Useful tips

- Turn, separate or stir the food several times. Stir the food from the outside towards the middle, as food heats more quickly from the outside.
- Use only crockery that is suitable for use in a microwave and oven when using functions which use microwave power.
- If possible, use the Automatic programmes for cooking.
- Never use a lid with the MW + Fan Grill  and MW + Grill  functions, as the food will not brown.
- With the Microwave  function, select a microwave power level of 850 W to start cooking, and then continue cooking at 450 W. Observe the information in the cooking charts at the end of this book.

Cooking with the Microwave function

Soups/Casseroles Vegetables	 [g]	 850 W [min.]	+	 450 W [min.]	 ¹ [min.]
Casserole	1500	10	+	20	1
Soup	1500	11	+	24	1
Peas	500	5	+	10	2
Peas (frozen)	450	5	+	12	2
Carrots	500	5	+	10	2
Broccoli florets	500	6	+	8	2
Broccoli (frozen)	450	5	+	11	2
Cauliflower florets	500	6	+	10	2
Kohlrabi batons	500	3	+	8	2
Asparagus	500	5	+	8	2
Leeks	500	5	+	8	2
Leeks (frozen)	450	5	+	8	2
Capsicums, cut into strips	500	5	+	10	2
Beans, green	500	4	+	12	2
Brussels sprouts	500	5	+	12	2
Brussels sprouts (frozen)	450	5	+	10	2
Mixed vegetables (frozen)	450	5	+	12	2

 Weight,  Cooking duration,  Standing time

¹ Allow food to stand at room temperature. This allows the heat to spread evenly throughout the food.

Other applications

Bottling

 Risk of infection from bacteria.

The spores of the botulinum bacterium are not sufficiently killed by bottling pulses and meat only once. Toxins may form which can lead to serious poisoning. These spores are only destroyed by reheating the food within 2 days after preserving.

After they have cooled down, **always** reheat pulses and meat a second time within 2 days.

 Risk of injury from increased pressure in sealed tins.



Preserving and heating food in sealed tins will result in an increase in pressure, which can cause them to explode.

Do not use tins for preserving or heating food.

Preparing fruit and vegetables

The instructions are for a maximum of 5 jars with a capacity of 0.5 l each.

Only use special jars for bottling:

- Fan Plus : Bottling jars with a screw cap
- Microwave : Microwave safe bottling jars with glass lids, sealed with clear adhesive tape

- Only use undamaged jars and rubber rings.
- Rinse the jars with hot water before bottling and fill them up to a maximum of 2 cm below the rim.
- After you have filled the jars with the produce, clean the glass rims with a clean cloth and hot water.

- Seal the jars with clear adhesive tape. Do not use any metal clips as they cause sparks when used with the Microwave  function.
- Insert the glass tray on shelf level 1 and place the jars on it.

Using the Fan Plus function

- Select the Fan Plus  function and a temperature of 160–170 °C.
- Wait until bubbles evenly rise in the jars.

Reduce the temperature in time to prevent the contents from boiling over.



Bottling fruit and gherkins

- Set the specified continued warming temperature as soon as bubbles are visible in the jars, then leave the jars in the warm oven for the time specified.

Bottling vegetables

- As soon as bubbles are visible in the jars, set the specified bottling temperature and cook the vegetables for the time specified.
- After bottling, set the specified continued warming temperature, then leave the jars in the warm oven for the time specified.

Other applications

		
Fruit	-/-	30 °C 25–35 min.
Gherkins	-/-	30 °C 25–30 min.
Beetroot	120 °C 30–40 min.	30 °C 25–30 min.
Beans (green or yellow)	120 °C 90–120 min.	30 °C 25–30 min.

 Bottling temperature and time once bubbles are visible in the jars

 Continued warming temperature and time

Using the Microwave function

- Select the Microwave  and a microwave power level of 850 W.
- Wait until bubbles evenly rise in the jars. This takes about 3 minutes per jar. With 5 jars, therefore, it takes 15 minutes.



Reduce the microwave power level in time to prevent the contents from boiling over.

Bottling fruit and gherkins

- Switch the oven off as soon as bubbles are visible in the jars. Then leave the jars in the warm oven compartment for the time specified.

Bottling vegetables

- As soon as bubbles are visible in the jars, set the specified microwave power level and cook the vegetables for the time specified.
- Switch the oven off after bottling and then leave the jars in the warm oven compartment for the time specified.

		
Fruit	-/-	25– 35 min.
Gherkins	-/-	25–30 min.
Beetroot	450 W 20–30 min.	25–30 min.
Beans (green or yellow)	450 W 20–30 min.	25–30 min.

 Microwave power level and bottling time, as soon as bubbles are visible

 Continued warming time

Removing the jars after bottling

 Risk of injury caused by hot surfaces.

The jars are very hot after bottling. Wear oven gloves when removing the jars from the oven.

- Take the jars out of the oven.
- Cover the jars with a towel and leave for approx. 24 hours in a draught-free area.
- After they have cooled down, **always** reheat pulses and meat a second time within 2 days.
- Remove the fasteners from the jars and make sure all jars are closed properly when storing them.

Either boil open jars again or store them in a cool place and consume the preserved fruit or vegetables immediately.

- Check the jars during storage. If jars have opened during storage or if the screw cap is bulging and does not make a popping noise when opened, destroy the contents.

Other applications

Frozen food/Ready meals

Tips for cakes, pizza and baguettes

- Bake cakes, pizza and baguettes on baking paper on the rack.
- Use the lowest temperature recommended on the packaging.

Tips for oven chips, croquettes and similar items

- Bake these frozen products on baking paper in the glass tray.
- Use the lowest temperature recommended on the packaging.
- Turn food several times during cooking.

Preparing frozen food/ready meals

Handling food carefully will help protect your health.

Cakes, pizzas and chips should be cooked until golden, not dark brown.

- Select the function and temperature recommended on the manufacturer's packaging.
- Pre-heat the oven.
- Place the food in the pre-heated oven on the shelf level recommended on the packaging.
- Check the food at the end of the shortest cooking duration recommended on the packaging.

You can create and save up to 20 of your own programmes.

- You can combine up to 10 cooking stages to accurately programme your favourite or most frequently used recipes. In each cooking stage you can select settings such as function, temperature and duration or core temperature.
- You can specify the shelf level(s) for the food.
- You can enter the name of the programme for your recipe.

When you call up and start your programme the next time, it will run automatically.

There are different ways of creating a User programme:

- At the end of an Automatic programme, save it as a User programme.
- After running a programme with a set duration, save it.

Then name the programme.

Creating a User programme

- Select Other .
- Select User programmes.
- Select Create programme.

You can now specify the settings for the first cooking stage.

Follow the instructions in the display:

- Select and confirm the desired settings.

If you select the Pre-heat function, first complete the first cooking stage. Use Add cooking stage to then add another cooking stage where you set a cooking duration. Only then can you save or start the programme.

- Select Complete cooking stage.

All settings for the first cooking stage have now been set.

You can add more cooking stages, for example, if you want to add another cooking function to follow on from the first.

- If additional cooking stages are required, select Add cooking stage and proceed as you did for the first cooking stage.
- When you have finished setting all the cooking stages, select Set the shelf level.
- Select the desired level(s).
- Confirm with *OK*.

If you want to check the settings or to change them at a later date, select the cooking stage in question.

- Select Save.
- Enter the programme name.
- Select .

A message will appear in the display confirming that the new name has been saved.

- Confirm with *OK*.

You can start the saved programme immediately, delay the start or change the cooking stages.

Starting a User programme

- Place the food in the oven.

User programmes

- Select Other .
- Select User programmes.
- Select the required programme.
- Select Allow.

Depending on the programme settings, the following menu options will appear in the display:

- Start now
The programme will start immediately. The oven heating will switch on immediately.
 - Finish at
Specify the time at which the programme should finish. The oven heating will switch off automatically at the time you have set.
 - Start at
Specify the time at which you want the programme to start. The oven heating will switch on automatically at the time you have set.
 - Show cooking stages
A summary of your settings will appear in the display.
 - Display actions
The required actions, e.g. placing the food in the oven, will appear in the display.
- Select the required menu option.

- Confirm the message regarding which shelf level to use with *OK*.

The programme selected will begin straight away or at the time set.

Use **i** Info to display information such as how to place or turn the food depending on the cooking programme.

- At the end of the programme, select the  sensor.

Changing cooking stages

Cooking stages in an Automatic programme that you have renamed as a User programme cannot be changed.

- Select Other .
- Select User programmes.
- Select the programme you want to change.
- Select Change programme.
- Select the cooking stage that you want to change or Add cooking stage to add another cooking stage.
- Select and confirm the desired settings.
- If you want to start the modified programme without changing it, select Start programme.
- Select Save when you have changed all the settings.

A message will appear in the display confirming that the new name has been saved.

- Confirm with *OK*.

The saved programme has been changed and you can start it immediately or delay the start.

Changing a name

- Select Other .
- Select User programmes.
- Select the programme you want to change.
- Select Change name.
- Change the programme name.
- Select ✓.
- Once you have changed the programme name, select Save.

A message will appear in the display confirming that the new name has been saved.

- Confirm with *OK*.

The programme has now been renamed.

Deleting User programmes

- Select Other .
- Select User programmes.
- Select the programme you want to delete.
- Select Delete programme.

The programme will be deleted.

Go to Other  | Settings  | Factory default | User programmes to delete all User programmes at the same time.

Baking

Handling food carefully will help protect your health.
Cakes, pizzas and chips should be cooked until golden, not dark brown.

Tips on baking

- Set a cooking duration. When baking, the oven should not be set to start a long time off. Otherwise the cake mixture or dough will dry out, and the raising agents will lose their effectiveness.
- Avoid using bright, thin-walled tins as they give an uneven or poor browning result. In certain unfavourable conditions, the food will not cook properly.
- Place cakes in rectangular tins on the rack with the longer side across the width of the oven for optimum heat distribution and even results.
- Line the glass tray with baking paper before placing chips, potatoes croquette and similar types of food on it.

Notes on the cooking charts

You can find the cooking charts at the end of this book.

Selecting the temperature

- As a general rule, select the lower temperature given in the chart. Baking at temperatures higher than those recommended may reduce the cooking duration, but will lead to uneven browning of the food, and unsatisfactory cooking results.

Selecting the cooking duration

Unless otherwise stated, the cooking durations given in the cooking charts are for an oven compartment which has not been pre-heated. With a pre-heated oven compartment, shorten durations by around 10 minutes.

- As a general rule, check whether the food is cooked after the shortest duration. Stick a wooden skewer into the food.

If it comes out clean without any batter/dough on it, the food is done.

Notes on the oven functions

You can find an overview of all the functions with their recommended values in “Main and sub-menus”.

Using Automatic programmes

- Follow the instructions in the display.

Using Fan Plus

You can use any type of baking tray made of heat-resistant material.

Use this function if you are baking on multiple shelves at the same time.

- 1 shelf level: place cakes in baking tins on shelf level 1.
- 1 shelf level: place flat items (e.g. biscuits, tray cakes) on shelf level 2.
- 2 shelf levels: depending on the height, place the food on shelf levels 1+3 or 2+3.

Using Eco Fan Heat

You can use any type of baking tray made of heat-resistant material.

Use this function for cooking bakes and gratins that need to be crispy on top.

- Place cakes or bakes in baking tins on shelf level 1.
- Place flat items (e.g. biscuits, tray cakes) on shelf level 2.

Using MW + Fan Plus

Use heat-resistant baking tins suitable for microwave use (see “Microwave operation - Suitable containers for microwave use”), such as heat-resistant glass or ceramic dishes, as these allow microwaves through them.

The MW + Fan Plus  function is particularly suitable for baking dough which requires a longer cooking duration, such as rubbed in, beaten mixtures and yeast recipes.

If you use this function, the cooking duration is shortened.

When selecting the microwave power level, observe the information in the cooking charts and in the recipes.

- Place the glass tray on shelf level 1.
- Place the baking tin on the glass tray.

Useful tip: Metal tins are less suitable for functions which use microwave power because the metal reflects the microwaves. The microwaves only reach the cake from above, which extends the cooking duration. If you use metal tins, place the tin on the glass tray so that it cannot touch the oven walls. If sparks form, do not reuse the tin for functions which use microwave power.

Roasting

Tips for roasting

- **Pre-heating** the oven compartment is only required when roasting beef sirloin joints and fillet. Pre-heating is generally not necessary.
- Use a **closed roasting dish** for roasting meat, such as an oven dish. The meat stays succulent. The oven compartment will also stay cleaner than when roasting on the rack. This ensures that sufficient stock remains for making gravy.
- If you are using a **roasting bag**, follow the instructions on the packaging.
- If you are using the **rack** or an **open roasting dish** for roasting, you can add a little fat or oil to very lean meat or place a few strips of streaky bacon on the top.
- **Season** the meat and place in the roasting dish. Dot with butter or margarine or brush with oil or cooking fat if necessary. For large lean cuts of meat (2–3 kg) and fatty poultry, add about 1/8 l of water to the dish.
- Do not add too much liquid during cooking as this will hinder the **browning** process. Browning only occurs towards the end of the cooking duration. Remove the lid about halfway through the cooking duration if a more intensive browning result is desired.
- At the end of the programme, take the food out of the oven compartment, cover it and leave to **stand** for about 10 minutes. This helps retain juices when the meat is carved.
- For a crisp finish, baste **poultry** 10 minutes before the end of the cooking duration with slightly salted water.

Notes on the cooking charts

You can find the cooking charts at the end of this book.

- Take note of the temperature range, microwave power levels, shelf levels and durations. These also take the type of cooking container, the size of the meat and cooking practices into account.

Selecting the °C temperature

- As a general rule, select the lower temperature given in the chart. If higher temperatures are used than those specified, the meat will brown on the outside, but will not be properly cooked through.
- For cuts which weigh more than 3 kg, select a temperature approx. 10 °C lower than that given in the chart. The roasting process will take longer, but the meat will cook evenly through and the skin or crackling will not be too thick.
- When roasting on the rack, set a temperature approx. 20 °C lower than for roasting in a covered oven dish.

Selecting the cooking duration ☺

Unless otherwise stated, the durations given in the cooking chart are for an oven compartment which has not been pre-heated.

- Determine the cooking duration by multiplying the thickness of the roast [cm] with the time per cm [min./cm] stated below, depending on the type of meat:
 - Beef/Venison: 15–18 min./cm
 - Pork/Veal/Lamb: 12–15 min./cm
 - Sirloin joints/Filletts: 8–10 min./cm
- As a general rule, check whether the food is cooked after the shortest duration.

Notes on the oven functions

You can find an overview of all the functions with their recommended values in “Main and sub-menus”.

Using Automatic programmes

- Follow the instructions in the display.

Using Fan Plus or Auto Roast

These functions are suitable for roasting meat, fish and poultry that needs to be well browned as well as sirloin joints and fillet.

In the Auto Roast  function, the oven compartment heats initially to a high searing temperature (approx. 230 °C). As soon as this temperature has been reached, the oven automatically drops the temperature back down to the pre-selected roasting temperature (continued roasting).

- For roasting, use crockery with heat-resistant handles such as an oven dish, roasting pan, Römertopf or a heat-resistant glass dish.
- Place the rack with the food on shelf level 1.

Using MW + Fan Plus or MW + Auto Roast

These functions are **not** suitable for roasting delicate cuts of meat such as sirloin joints or fillet. The centre would be too well cooked before the exterior is browned.

Use the MW + Fan Plus  function for rapid reheating and cooking of food while browning it at the same time. This function saves the most time and energy.

Use the MW + Auto Roast  function for searing using a high temperature to start with, then continue cooking with a lower temperature.

If you use functions which use microwave power, the cooking duration is shortened.

When selecting the microwave power level, observe the information in the cooking charts and in the recipes.

- Dishes must be suitable for use in a microwave oven, must be heat-resistant and must not have metal lids (see “Suitable containers for microwave use”).
- Place the rack together with the glass tray or the glass tray on shelf level 1.

Grilling



Risk of injury caused by hot surfaces.

If you grill with the door open, hot air will escape from the oven instead of being cooled by the cooling fan. The control elements will get hot.

Grill with the oven door closed.

Tips for grilling

- Pre-heating is necessary when grilling. For pre-heating, select a function which **does not use** microwave power.
Pre-heat the grill element for approx. 5 minutes with the door closed.
- Trim the meat if necessary. Season meat 10-15 minutes before cooking.
- Add a little oil to lean meat if necessary. Do not use other types of fat as they can easily burn and cause smoke.
- Clean fish in the normal way. To enhance the flavour, season with a little salt. Fish can also be drizzled with lemon juice.
- Grill on the rack.
- To grill, brush the rack with oil and then place the food on the rack.

Notes on the cooking charts

You can find the cooking charts at the end of this book.



- Take note of the temperature range, the shelf levels and the timings. These take the size of the meat and cooking practices into account.
- Check the food after the shortest duration quoted.

Selecting the temperature

Select the temperature for the Fan Grill  and MW + Fan Grill  functions.

- As a general rule, select the lower temperature given in the chart. If higher temperatures are used than those specified, the meat will brown on the outside, but will not be properly cooked through.

Selecting the grill setting

Select between setting 1–3 for the Grill  and MW + Grill  functions.

- If you are grilling thicker foods further away from the grill element, select **Setting 1**.
- If you desire a lighter, golden finish, on gratins for example, select **Setting 2**.
- If you are quickly grilling thinner foods closer to the grill element, select **Setting 3**.

Selecting the cooking duration

- Grill thinner cuts of meat/slices of fish for approx. 6–8 minutes per side. It is best to grill food of a similar thickness at the same time so that the cooking durations do not vary too much.
- Grill thicker pieces for about 7–9 minutes per side.
- When grilling rolled meat, allow approx. 10 minutes per cm diameter.
- As a general rule, check whether the food is cooked after the shortest duration.
- To **test the food**, press down on the meat with a spoon. This lets you determine how well the meat has been cooked.
 - **Rare**
If the meat gives easily to the pressure of the spoon, it will still be red on the inside.
 - **Medium**
If there is some resistance, the inside will be pink.
 - **Well-done**
If there is great resistance, it is cooked through.

Useful tip: If the surface of a thicker cut of meat is browned but the centre is still raw, move the food to a lower level or reduce the temperature and continue grilling. This will stop the surface from becoming excessively charred.

Notes on the oven functions

You can find an overview of all the functions with their recommended values in “Main and sub-menus”.

If you use functions which use microwave power, the cooking duration is shortened.

When selecting the microwave power level, observe the information in the grilling chart and in the recipes.

Using Fan Grill or MW + Fan Grill

These functions are suitable for grilling thicker food, such as chicken.

A temperature setting of 220 °C is generally recommended for thinner types of food, while 180–200 °C is recommended for thicker cuts.

- Place the rack on shelf level 1 or 2 depending on the height of the food.



Using Grill or MW + Grill

These functions are suitable for grilling thin cuts of meat and browning food.



- Place the rack on shelf level 2 or 3 depending on the height of the food.



Grilling

Fan Grill

- Use the Fan Grill  function for meat, fish, poultry and vegetables.
- Always pre-heat for at least 5 minutes before Fan Grilling.
- It is not necessary to turn food when Fan Grilling. Only one side of the food, however, will become brown.
- The door must be closed when using Fan Grill .
- When using red meat, pat the meat dry before Fan Grilling as this encourages a richer colour.

All temperatures are approximations and must be varied according to the thickness and preparation of the meat. The chart below is a suggested guide only. Personal taste and size of serves will vary times and temperatures. We recommend you monitor cooking results for best outcomes.

Food to be grilled	 [°C]	 ³ ₁	 [min.]
Lean thin sausages	180	3	8–10
Thick sausages	180	3	15–20
Lean beef fillet steak	220	3	6–12
Chicken breast fillet	200	3	14–18
Whole butterflied chicken	200	1	30–35
Thin white fish fillets	220	3	6–10
Thick fish fillets, cutlets or steaks	200	3	10–15
Oily fish	200	3	8–12
Lamb loin chops	190	3	12–16
Lamb back straps	220	3	8–10
Vegetables, capsicum, zucchini, sweet potato, eggplant	200	3	12–15
Potato wedges or small roast potatoes	220	2	20–25
Kebabs and satays (red meat)	200	3	12–15
Chicken satays	200	3	12–15

 Temperature / ³₁ Shelf level /  Duration

Fan Grill  can be used for small roasts but is only recommended for lean, tender cuts of meat, e.g. lamb racks, rump roasts, and beef fillet. Fan Grill the roast at 200 °C on shelf level 3 for approximately 25 minutes, depending on thickness.

Grill

- Use for thick toasts, muffins, cheese on toast, focaccia, bruschetta and bacon.
- Pre-heat grill for at least 5 minutes at 200–220 °C.
- Select the appropriate shelf level for the thickness of the food.
- The door must be closed when using the Grill  function.

This is a suggested guide only. Personal taste and size of serves will vary times and temperatures.

Cleaning and care

 Risk of injury caused by hot surfaces.

The oven gets hot during operation. You could burn yourself on the heating elements, the oven compartment, or accessories. Allow the heating elements, oven compartment and the accessories to cool before manual cleaning.

 Risk of injury due to electric shock.

The steam from a steam cleaning appliance could reach electrical components and cause a short circuit. Do not use a steam cleaner to clean the oven.

The use of unsuitable cleaning agents can cause the surfaces to discolour or alter. The oven front is particularly susceptible to damage from oven cleaners.

All surfaces of this appliance are susceptible to scratching. Scratches on glass surfaces could cause a breakage in certain circumstances. Remove all cleaning agent residues immediately.

Stubborn soiling could damage the oven in certain circumstances. Once the oven has cooled, clean the oven compartment, the inside of the door and the door seal. Waiting too long can make cleaning unnecessarily difficult and in some cases impossible.

Operating a damaged oven can result in microwave leakage and present a hazard to the user.

Check the door and door seal for any sign of damage. If any damage is noticed, the oven should not be used again with microwave functions until the fault has been rectified by a service technician.

Unsuitable cleaning agents

To avoid damaging the surfaces of your appliance, do not use:

- cleaning agents containing soda, alkalines, ammonia, acids or chlorides
- cleaning agents containing descaling agents on the front
- abrasive cleaning agents, e.g. powder cleaners and cream cleaners
- solvent-based cleaning agents
- stainless steel cleaning agents
- dishwasher cleaners
- glass cleaning agents
- cleaning agents for ceramic cooktops
- hard, abrasive brushes or sponges, e.g. pot scourers, brushes or sponges which have been previously used with abrasive cleaning agents
- dirt eraser sponges
- sharp metal scrapers
- steel wool or metal scourers
- spot cleaning with mechanical cleaning agents
- Oven cleaners *
- stainless-steel spiral pads

* These can, however, be used to remove very heavy soiling from PerfectClean treated surfaces

If soiling is left on for any length of time, it may become impossible to remove. Continued use without regular cleaning will make the oven much harder to clean. Failure to maintain the oven in a clean condition could lead to deterioration of the surfaces that could adversely affect the life of the appliance and result in a hazardous situation. Remove any soiling immediately.

Only the glass tray is dishwasher proof.

Useful tip: Soiling caused by spilled fruit juices and cake mixtures is best removed while the oven is still warm. Exercise caution and make sure the oven is not too hot.

To make it easier to clean the oven:

- Lower the grill element.
- To neutralise odours in the oven compartment, put a container of water with some lemon juice in the oven and heat for a few minutes.

Removing normal soiling

Moisture inside the oven can cause damage.

Do not use too much water on the cloth or sponge and do not let water or any other substance find its way into any openings.

Removing normal soiling

- It is best to remove normal soiling immediately using a clean sponge and a solution of hot water and washing-up liquid, or a clean, damp microfibre cloth.
- Remove any residual cleaning agent thoroughly with clean water. This is particularly important for any parts with a PerfectClean finish, as cleaning agent residues will impair the non-stick properties.
- After cleaning, wipe the surfaces dry using a soft cloth.

Cleaning and care

Removing stubborn soiling

Spilt fruit and roasting juices may cause lasting discolouration or matte patches on surfaces. This discolouration will not affect the functional characteristics of the surface finish.

Do not attempt to remove these marks. Clean them following the instructions given here.

- Moisten stubborn soiling with a solution of hot water and washing-up liquid and leave to soak for a few minutes.
- If necessary, the scouring pad on the back of a non-scratching washing-up sponge can be used to remove the soiling after the soaking time.

Using oven cleaners

- Very stubborn soiling on PerfectClean surfaces can be cleaned using Miele Oven Cleaner. This cleaner must only be applied to cold surfaces.

If the oven spray gets into gaps and openings, a strong odour is generated during subsequent cooking programmes.

Do not spray the oven cleaner onto the roof of the oven compartment.

Do not spray the oven cleaner into the gaps and openings of the oven compartment walls and rear wall.

- Follow the instructions on the packaging.

Oven cleaners from other manufacturers must only be used in a cold oven and must not be left on for longer than 10 minutes.

- If necessary, the scouring pad on the back of a non-scratching washing-up sponge can be used to remove the soiling after the soaking time.
- Remove any residual cleaning agent thoroughly with clean water.
- Dry all surfaces with a soft cloth.

Lowering the grill element

If the oven compartment roof is badly soiled, the grill element can be lowered to make cleaning easier. Clean the oven compartment roof regularly with a damp cloth or a dishwashing sponge.

 Risk of injury caused by hot surfaces.

The oven gets hot during operation. You could burn yourself on the heating elements, the oven compartment, or accessories. Allow the heating elements, oven compartment and the accessories to cool before manual cleaning.

The oven compartment floor can be scratched by the falling nut. Place a cloth or similar item over the oven compartment floor to protect it.

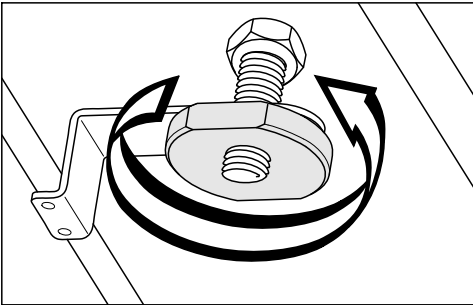

■ Undo the nut.

The grill element can get damaged. Do not use force to lower the grill element.

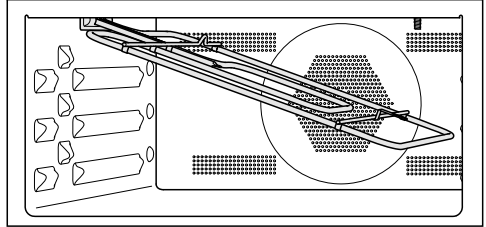

■ Carefully lower the grill element.

The mica sheet can be damaged on the top of the oven cavity.

Do not use the abrasive side of the dishwashing sponge to clean the roof liner.

The LED on the oven compartment roof can be damaged.

Do not clean the LED if possible.

■ Clean the roof of the oven with a damp cloth or a soft dishwashing sponge.

■ After cleaning the grill element, raise it gently back up again.

■ Replace the nut and tighten it securely.





Problem solving guide

Many malfunctions and minor faults that can occur in daily operation can be corrected without contacting Miele. This will save you time and money because you will not need a service call.

You can find information on how to remedy faults yourself at www.miele.com.au/service or www.miele.co.nz/service and on the Miele website. Please note, however, that a call-out charge will be applied to unnecessary service visits where the problem could have been rectified as described in these operating instructions.

Problem	Possible cause and remedy
The display is dark.	<p>You have selected the Time Show Off setting. When the oven is switched off, the display is dark.</p> <ul style="list-style-type: none"> ■ As soon as the oven is switched on, the main menu will appear. If you want the time of day to be displayed constantly, select the Time Show On setting.
	<p>There is no power to the oven.</p> <ul style="list-style-type: none"> ■ Check that the oven plug is correctly inserted into the socket and switched on. ■ Check if the circuit breaker has tripped. Contact a qualified electrician or Miele.
The signal tone does not sound.	<p>The buzzers are deactivated or set at too low a volume.</p> <ul style="list-style-type: none"> ■ Switch on the buzzers or increase the volume with the Volume Buzzer tones setting.
The oven does not heat up.	<p>Demo mode is active.</p> <p>You can select menu options in the display and the sensors, but the oven heating does not work.</p> <ul style="list-style-type: none"> ■ Deactivate Demo mode with the Showroom programme Demo mode Off setting.
The sensors do not respond.	<p>You have selected the Display QuickTouch Off setting. When the oven is switched off, the sensors do not respond.</p> <ul style="list-style-type: none"> ■ As soon as the oven is switched on, the sensors will respond. If you want the sensors to respond even when the oven is switched off, select the Display QuickTouch On setting.
	<p>The oven is not connected to the electricity supply.</p> <ul style="list-style-type: none"> ■ Make sure that the plug is correctly inserted in the socket and that the socket is switched on. ■ Check if the circuit breaker has tripped. Contact a qualified electrician or Miele.
	<p>There is a fault with the control unit.</p> <ul style="list-style-type: none"> ■ Touch and hold the On/Off  sensor until the display switches off and the oven restarts.



Problem solving guide

Problem	Possible cause and remedy
You cannot start a cooking programme.	If you are cooking with microwave power, the door may be open. ■ Check whether the door is closed properly.
	If you are cooking with microwave power, the power level or duration is not selected. ■ Check whether a microwave power level and a duration have been selected.
	If you are cooking with a function which uses microwave power, not all of the required settings have been entered. ■ Check whether you have entered a microwave power level, a duration and a temperature.
Press OK for 6 seconds to unlock appears in the display when the oven is switched on.	The system lock  has been switched on. ■ You can deactivate the system lock for a programme by touching the OK sensor for at least 6 seconds. ■ If you want to permanently deactivate the system lock, select the Safety System lock  Off setting.
Power cut -process cancelled appears in the display.	There has been a brief power cut. This has caused the current cooking programme to stop. ■ Switch the oven off and then back on again. ■ Restart the cooking programme.
12:00 appears in the display.	The power supply was interrupted for longer than 150 hours. ■ Reset the time and date.
Maximum operating hours reached appears in the display.	The oven has been operating for an unusually long time. This has triggered the safety switch-off function. ■ Confirm with OK. The oven is now ready to use.
Fault and a fault code not listed here appears in the display.	A fault has occurred that you cannot resolve. ■ Call Miele.
If the door is opened while cooking with the Microwave  function, the oven stops making noise.	This is not a fault. If the door is opened while cooking with the Microwave  function, the door contact switch will switch off microwave power and switch the cooling fan to a lower speed.

Problem solving guide

Problem	Possible cause and remedy
A noise can be heard after a cooking process.	The cooling fan remains switched on after a cooking programme (see “Settings – Cooling fan run-on”).
An abnormal sound can be heard when the oven is operating in microwave mode.	A metal dish has been used during a cooking programme using microwave power. <ul style="list-style-type: none"> ■ Check if there are sparks caused by using metal dishes (see “Microwave operation - Suitable containers for microwave use”).
	The food was covered with aluminium foil during a programme with microwave power. <ul style="list-style-type: none"> ■ If it is, remove the foil.
	The rack was used during a programme with microwave power. <ul style="list-style-type: none"> ■ Always use the glass tray when using the oven with microwave power.
The oven has switched itself off.	The oven will switch itself off automatically to save energy if no other action is taken within a certain time frame after switching it on or after the end of a cooking programme. <ul style="list-style-type: none"> ■ Switch the oven back on.
Cakes and biscuits are not cooked properly after the duration given in the cooking chart.	A different temperature from the one given in the recipe has been used. <ul style="list-style-type: none"> ■ Select the temperature required for the recipe.
	The ingredient quantities used are different from those given in the recipe. <ul style="list-style-type: none"> ■ Check whether you have amended the recipe. The addition of more liquid or more eggs makes a moister mix which would take longer to cook.
The browning of baked goods is uneven.	The wrong temperature or shelf level was selected. <ul style="list-style-type: none"> ■ There will always be a slight unevenness in browning. If browning is very uneven, check whether the correct temperature and shelf level were selected.
	The material or colour of the baking tin is not suitable for the oven function. Light-coloured, shiny or thin-walled tins are less suitable. These reflect the oven's heat, which means that the heat does not penetrate to the food effectively, resulting in uneven or poor browning. <ul style="list-style-type: none"> ■ Dark, matte tins are best for baking.

Problem solving guide

Problem	Possible cause and remedy
<p>The food is not sufficiently heated or is not cooked at the end of a set duration when using the Microwave function.</p> 	<p>Check whether the programme using microwave power has been interrupted and has not been restarted.</p> <ul style="list-style-type: none"> ■ Restart the cooking programme to ensure the food is heated or cooked properly. <p>When cooking or reheating with microwave power, the time set was too short.</p> <ul style="list-style-type: none"> ■ Check that the correct duration is selected for the microwave power level. The lower the microwave power level, the longer the cooking duration.
<p>Food has cooled down too quickly after being reheated or cooked using microwave power.</p>	<p>In the microwave oven, food begins to cook from the outside first, the inside of the food relying on the slower conduction of heat. If food is cooked at a high microwave power level, it is possible that the heat may not have reached the centre of the food, so it is hot on the outside but cold in the centre. During the standing time, the heat is transferred to the centre of the food.</p> <ul style="list-style-type: none"> ■ When reheating food with different densities, such as with menu cooking, it is sensible to start with a low microwave power level and select a longer reheating duration.
<p>The oven lighting switches off after a short time.</p>	<p>You have selected the Lighting "On" for 15 seconds setting.</p> <ul style="list-style-type: none"> ■ If you want the oven lighting to remain switched on during the entire cooking programme, select the Lighting On setting.
<p>The oven lighting is off or does not switch on.</p>	<p>You have selected the Lighting Off setting.</p> <ul style="list-style-type: none"> ■ Select the  sensor control to switch on the oven interior lighting for 15 seconds. ■ If required, select the Lighting On or "On" for 15 seconds setting. <p>The oven interior lighting is faulty.</p> <ul style="list-style-type: none"> ■ Call Miele.

Service

You can find information on how to remedy faults yourself and about Miele spare parts at www.miele.com.au/service or www.miele.co.nz/service.

Contact in case of fault

In the event of any faults which you cannot remedy yourself, please contact Miele.

You can book a Miele customer service call-out online at www.miele.com.au/service or www.miele.co.nz/service.

Contact information for Miele can be found at the end of this booklet.

Please quote the model and serial number of your appliance when contacting Miele. This information can be found on the data plate.

This information is given on the data plate, visible on the front frame of the oven, with the door fully open.

Warranty

The manufacturer's warranty for this appliance is 2 years.

For further information, please refer to your warranty booklet.

Building-in dimensions

Dimensions are given in mm.

Installation in a tall or base unit

When building the oven into a base unit underneath a cooktop, please also observe the installation instructions for the cooktop as well as the building-in height required for the cooktop.

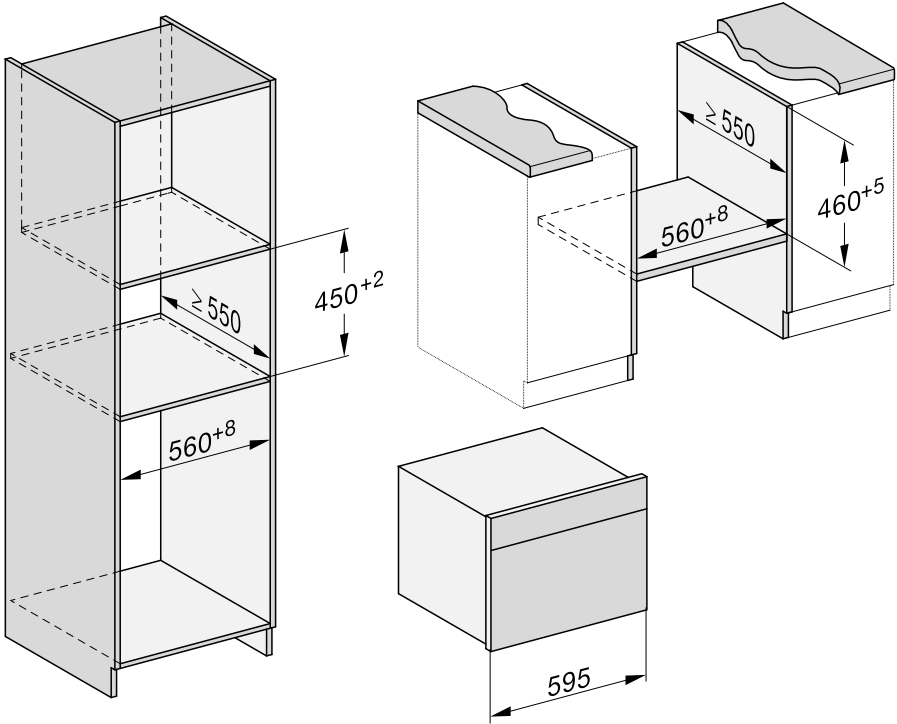

Installation

Side view

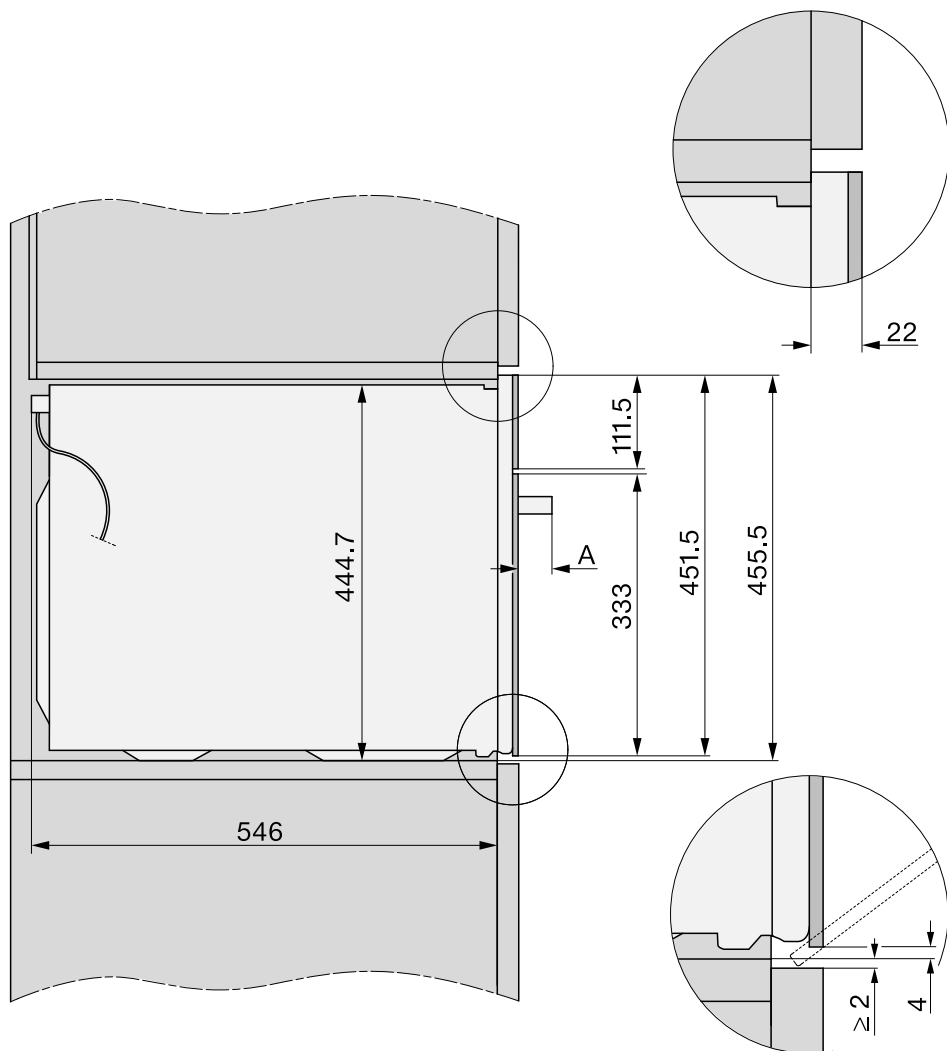

A H 73xx: 43 mm

H 74xx: 47 mm

Connections and ventilation

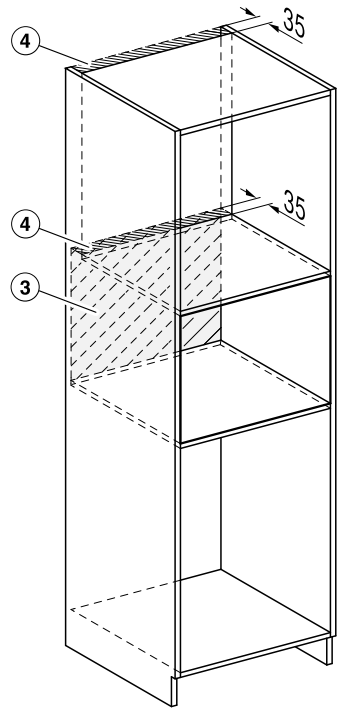
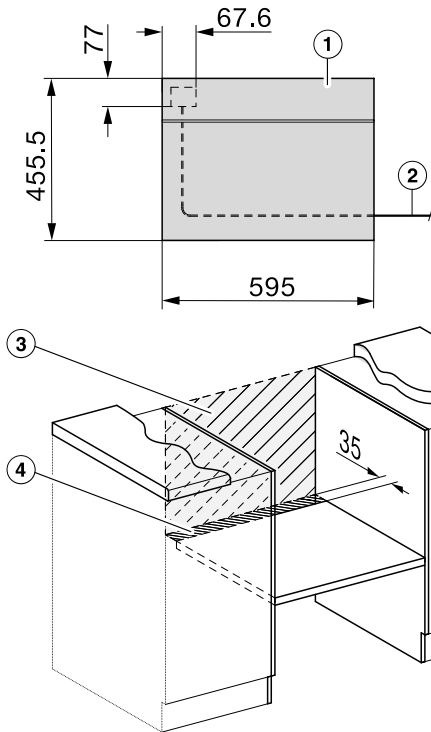

- ① Front view
- ② Mains connection cable, length = 2000 mm
- ③ No connections permitted in this area
- ④ Ventilation cut-out, min. 150 cm²

Installation

Installing the oven

- Connect the mains cable from the oven to the electricity supply.
- Push the oven into the housing unit and align it.

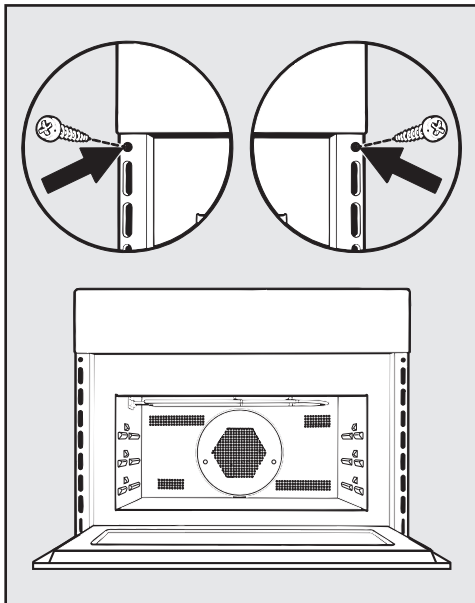

- Open the door and use the screws supplied to secure the oven to the side walls of the housing unit through the holes in the oven trim.

Electrical connection

The oven is equipped with a mains connection cable and plug for connection to a 50 Hz, 230 V supply. The fuse rating must be at least 16 A.

The appliance must only be connected to a correctly installed earthed socket. All electrical work must be carried out by a suitably qualified and competent person in strict accordance with national and local safety regulations. Ensure that the plug and switch are accessible at all times.

If the appliance is hardwired or if the switch is not accessible after installation, an additional means of disconnection must be provided.

Suitable means of disconnection include accessible switches with an all-pole contact gap of at least 3 mm. These include circuit breakers, fuses and contactors.

Voltage, rated load and fuse rating are given on the data plate situated at the front of the oven compartment. Please ensure the connection data matches the household supply.

When contacting Miele, please quote the following:

- Model number
- Serial number
- Connection data (voltage/frequency/maximum rated load)

If the mains connection cable is damaged, a new one must be fitted by a service technician authorised by Miele.

This speed oven complies with European Standard EN 55011. This appliance is classified as a Group 2, class B product.

Group 2 appliances use high frequency energy in the form of electromagnetic waves to create heat in food.

















Class B is assigned to appliances that are suitable for domestic use.









Temporary or permanent operation with a self-sufficient or non-mains synchronous energy supply system (e.g. isolated networks, back-up systems) is possible. A requirement for the operation is that the energy supply system complies with all current local and national requirements that apply to stand-alone, solar and/or battery systems.

The protective measures provided in the domestic installation and in this Miele product must also be assured in their function and operation in isolated operation or in non-mains synchronous operation, or replaced with equivalent measures in the installation.

Cooking charts

Creamed mixture

Cakes/Biscuits (accessories)		 +  [°C] + [W]		 ³ ₁	 [min.]
Muffins		150–160	✓	2	35–45
Small cakes (1 glass tray)		150	–	2	25–35
Small cakes (2 glass trays)		140	–	2+3	35–45
Sand cake (loaf tin, 30 cm)	 ¹	160–170 + 80	✓	1	35–45
Ring cake (ring tin/Gugelhupf cake tin, Ø 26 cm)	 ¹	160–170 + 150	✓	1	40–50
Marble, nut cake (loaf tin, 30 cm)		150–160	✓	1	65–75
Marble, nut cake (ring tin/Bundt cake tin, Ø 26 cm)		150–160	✓	1	55–65
Fresh fruit cake (1 glass tray)		150–160	✓	2	50–60
Fresh fruit cake (springform cake tin, Ø 26 cm)		150–160	✓	1	55–65
Flan base (flan base tin, Ø 28 cm)		150–160	✓	1	25–35

 Function,  Temperature,  Microwave power level,  Booster, ³₁ Shelf level,
 Cooking duration,  Fan Plus,  MW + Fan Plus, ✓ On, – Off

¹ Place the baking tin in the centre of the glass tray.

² Pre-heat the oven before placing the food inside.

Rubbed in mixture

Cakes/Biscuits (accessories)		[°C]		3 1	[min.]
Biscuits (1 glass tray)		140–150	✓	2	20–30
Drop cookies (1 glass tray)		140	–	2	40–50
Drop cookies (2 glass trays)		140	–	2+3	45–55 ²
Flan base (flan base tin, Ø 28 cm)		150–160	✓	2	30–40
Cheesecake (springform cake tin, Ø 26 cm)		150–160	✓	1	75–85
Apple cake (springform cake tin, Ø 20 cm)		160	–	1	110–120
Apple pie (springform cake tin, Ø 26 cm)		150–160	✓	1	65–75
Fresh fruit cake (springform cake tin, Ø 26 cm)		150–160	✓	1	60–70
Fresh fruit cake, glazed (1 glass tray)		150–160	✓	2	55–65
Swiss flan (1 glass tray)		190–200 ¹	✓	2	30–40

Function, Temperature, Booster, 3 1 Shelf level, Cooking duration, Fan Plus, ✓ On, – Off

¹ Pre-heat the oven before placing the food inside.

² Take the baking trays out of the oven early if the food has already browned sufficiently before the specified cooking time has elapsed.

Yeast dough

Cakes/Biscuits (accessories)		+ [°C] + [W]		3 1	[min.]
Bundt cake (Bundt cake tin, Ø 24 cm)		140–150	✓	1	55–65
Stollen (1 glass tray)		150–160	✓	1	60–70
Streusel cake with/without fruit (1 glass tray)		160–170	✓	2	40–50
		170–180 + 150	–	2	30–40
Fresh fruit cake (1 glass tray)		160–170	✓	2	40–50
		170–180 + 150	–	2	25–35
Apple turnovers/Raisin scrolls (1 glass tray)		150–160	✓	2	25–35
White bread (free form) (1 glass tray)		180–190	–	2	35–45
White bread (loaf tin, 30 cm)		190–200	✓	1	50–60
Wholegrain bread (loaf tin, 30 cm)		180–190	✓	1	55–65
Prove yeast dough (bowl)		35	–	1	30

Function, Temperature, Booster, 3 1 Shelf level, Cooking duration, Fan Plus, MW + Fan Plus, ✓ On, – Off

Cooking charts

Quark dough

Cakes/Biscuits (accessories)		+ [°C] + [W]		³ ₁	 [min.]
Fresh fruit cake (1 glass tray)		160–170	✓	2	40–50
		170–180 + 150	–	2	25–35
Apple turnovers/Raisin scrolls (1 glass tray)		150–160	✓	2	25–35

Function, Temperature, Booster, ³₁ Shelf level, Cooking duration, Fan Plus, MW + Fan Plus, ✓ On, – Off

Sponge mixture

Cakes/Biscuits (accessories)		 [°C]		³ ₁	 [min.]
Sponge cake base (2 eggs, springform cake tin, Ø 26 cm)		170–180 ¹	–	1	15–25
Sponge cake base (4 eggs, springform cake tin, Ø 26 cm)		170–180 ¹	–	1	30–40
Whisked sponge (springform cake tin, Ø 26 cm)		190	–	2	20–30
Swiss roll sponge (1 glass tray)		170–180 ¹	–	2	12–22

Function, Temperature, Booster, ³₁ Shelf level, Cooking duration, Fan Plus, ✓ On, – Off















¹ Pre-heat the oven before placing the food inside.









Choux pastry, puff pastry, meringue

Cakes/Biscuits (accessories)		 [°C]		³ ₁	 [min.]
Choux buns (1 glass tray)		160–170	✓	2	30–40
Pastry puffs (1 glass tray)		170–180	✓	2	25–35
Macaroons (1 glass tray)		120–130	✓	2	35–45
Meringues/Pavlovas (1 glass tray, 1 tray of 6 Ø 6 cm)		80–100	–	2	120–150

Function, Temperature, Booster, ³₁ Shelf level, Cooking duration, Fan Plus, ✓ On, – Off

Savoury snacks











Food (accessories)		 +  [°C] + [W]		 ³ ₁	 [min.]
Savoury flan (1 glass tray)		190–200 ²	✓	2	30–40
Onion tart (1 glass tray)		180–190 + 150	–	2	30–40
Pizza, yeast dough (1 glass tray)		160–170 + 80	–	2	25–35
Pizza, quark dough (1 glass tray)		150–160	–	2	25–35
Toast (rack)	 ¹	3 ³	–	2	2–4
Baked dishes/gratins (e.g. toast) (rack on the glass tray)	 ¹	3	–	2	5–9
Grilled vegetables (rack on the glass tray)	 ¹	3 ³	–	2	10–12 ⁴
		210–220 ³	–	2	8–10 ⁴









 Function,  Temperature,  Booster, ³₁ Shelf level,  Cooking duration,  Fan Plus,  MW + Fan Plus,  Full Grill,  Fan Grill, ✓ On, – Off

- ¹ Select the specified grill setting.
- ² Pre-heat the oven before placing the food inside.
- ³ Pre-heat the oven for 5 minutes before placing the food inside.
- ⁴ Turn the food halfway through cooking.

Cooking charts











Beef









Food (accessories)		 [°C]		 ³ ₁	 [min.]	 ⁸ [°C]
Braised beef, approx. 1 kg (oven dish with lid)	 ²	150–160	✓	1	120–130 ⁶	–
Fillet of beef, approx. 1 kg ¹	 ²	150–160 ⁴	–	1	30–70	53–75
Sirloin joint, approx. 1 kg ¹	 ²	150–160 ⁴	✓	1	25–70	53–75
Burgers ¹	 ³	3 ⁵	–	2	1: 17–22 2: 5–10 ⁷	–
Rissoles ¹	 ³	3 ⁵	–	2	1: 10–15 2: 5–10 ⁷	–

 Function,  Temperature,  Booster,  ³₁ Shelf level,  Cooking duration,  Core temperature,  Fan Plus,  Full Grill, ✓ On, – Off

- ¹ Use the rack and glass tray.
- ² Sear the meat on the cooktop first.
- ³ Select the specified grill setting.
- ⁴ Pre-heat the oven before placing the food inside.
- ⁵ Pre-heat the oven for 5 minutes before placing the food inside.
- ⁶ Roast with the lid on first. Remove the lid after roasting for 60 minutes and add approx. 0.5 litre of liquid.
- ⁷ Turn the food once it has browned sufficiently (1: Grill duration side 1, 2: Grill duration side 2).
- ⁸ If you have a separate food probe you can use the core temperature shown.













Veal



Food (accessories)		 [°C] +  [W]		 ³ ₁	 [min.]	 ³ [°C]
Braised veal, approx. 1.5 kg (roasting dish with lid)	 ¹	160–170	✓	1	120–130 ²	–
	 ¹	160–170 + 150	✓	1	80–90 ²	–
Fillet of veal, approx. 1 kg (glass tray)	 ¹	150–160	✓	1	20–50	53–75

 Function,  Temperature,  Booster,  ³₁ Shelf level,  Cooking duration,  Core temperature,  Fan Plus,  MW + Fan Plus, ✓ On, – Off

- ¹ Sear the meat on the cooktop first.
- ² Roast with the lid on first. Remove the lid after roasting for 60 minutes and add approx. 0.5 litre of liquid.
- ³ If you have a separate food probe you can use the core temperature shown.

Pork













Food (accessories)		 +  [°C] + [W]		 ³	 [min.]	 ⁷ [°C]
Pork joint/pork neck roast, approx. 1 kg (oven dish with lid)	 ¹	160–170 + 150	✓	1	80–90 ⁴	80–90
Pork joint with crackling, approx. 2 kg (oven dish)	 ¹	170–180 + 150	✓	1	70–80 ⁵	80–90
Gammon joint, approx. 1 kg (glass tray)	 ¹	170–180 + 150	–	1	40–50	75–80
Meat loaf, approx. 1 kg (glass tray)	 ¹	170–180 + 150	–	1	35–45 ⁵	80–85
Bacon (rack on the glass tray)	 ²	3 ³	–	2	5–10	–
Sausages (rack on the glass tray)	 ²	3 ³	–	2	15–20 ⁶	–









 Function,  Temperature,  Booster, ³ Shelf level,  Cooking duration, ⁷ Core temperature,  MW + Auto Roast,  MW + Fan Plus,  Full Grill, ✓ On, – Off

- ¹ Only use heat-resistant containers which are microwave safe.
- ² Select the specified grill setting.
- ³ Pre-heat the oven for 5 minutes before placing the food inside.
- ⁴ Roast with the lid on first. Remove the lid after roasting for 60 minutes and add approx. 0.5 litre of liquid.
- ⁵ Add approx. 0.5 l of liquid halfway through roasting.
- ⁶ Turn the food halfway through cooking.
- ⁷ If you have a separate food probe you can use the core temperature shown.

Cooking charts

















Lamb, game











Food (accessories)		 +  [°C] + [W]		 ³	 [min.]	 ⁴ [°C]
Leg of lamb on the bone, approx. 1.5 kg (oven dish with lid)		170–180 + 80	✓	1	100–120 ³	53–75
Saddle of lamb, off the bone (rack on the glass tray)	 ¹	170–180 ²	✓	1	15–40	53–75
Saddle of venison, off the bone (oven dish)	 ¹	170–180 ²	✓	1	45–75	54–57
Saddle of roebuck, off the bone (glass tray)	 ¹	140–150 ²	–	1	20–40	60–81
Leg of wild boar, off the bone, approx. 1 kg (oven dish with lid)		180–190	✓	1	90–120 ³	80–90

 Function,  Temperature,  Booster, ³ Shelf level,  Cooking duration, ⁴ Core temperature,  MW + Auto Roast,  Fan Plus,  Auto Roast, ✓ On, – Off

- ¹ Sear the meat on the cooktop first.
- ² Pre-heat the oven before placing the food inside.
- ³ Roast with the lid on first. Remove the lid after roasting for 60 minutes and add approx. 0.5 litre of liquid.
- ⁴ If you have a separate food probe you can use the core temperature shown.

Poultry, fish

Food (accessories)		 +  [°C] + [W]		 ³	 [min.]	 ⁴ [°C]
Poultry, 0.8–1.5 kg (rack on the glass tray)		160–170	✓	1	55–65	85–90
		170–180 + 150	–	1	40–50	85–90
Chicken, approx. 1.2 kg (rack on the glass tray)		180–190 ¹	–	1	60–70 ²	85–90
		200 + 150	–	1	45–55 ²	85–90
Poultry, approx. 2 kg (shallow ovenproof dish on the glass tray)		160–170	✓	1	110–140	85–90
		170–180 + 80	–	1	100–120	85–90
Poultry, approx. 4 kg (oven dish on the glass tray)		160–170 + 80	–	1	150–160 ³	90–95
Fish, 200–300 g (e.g. trout) (glass tray)		160–170 + 150	–	1	15–25	75–80
Fish, 1–1.5 kg (e.g. Australian salmon) (glass tray)		160–170 + 150	–	1	20–30	75–80

 Function,  Temperature,  Booster, ³ Shelf level,  Cooking duration, ⁴ Core temperature,  Auto Roast,  MW + Auto Roast,  Fan Grill,  MW + Fan Grill,  MW + Fan Plus, ✓ On, – Off

¹ Pre-heat the oven for 5 minutes before placing the food inside.

² Turn the food halfway through grilling.

³ Add approx. 0.5 litre of liquid after 30 minutes.

⁴ If you have a separate food probe you can use the core temperature shown.

Copyright and licences for the communication module

For the purpose of operating and controlling the communication module, Miele uses proprietary or third-party software that is not covered by open source licensing terms. These items of software/software components are protected by copyright. The copyright powers of Miele and third parties must be respected.

In addition, the communication module contains software components which are distributed under open source licensing terms. The open source components contained in the appliance along with the corresponding copyright notices, copies of the licensing terms valid at the time, and any further information can be accessed locally via IP using a web browser (*http://<IP address>/Licenses*), where <IP address> is the IP address of the appliance. The liability and warranty arrangements for the open source licences displayed in this location only apply in relation to the respective rights holders.

Miele Australia Pty. Ltd.

ACN 005 635 398

ABN 96 005 635 398

Level 4, 141 Camberwell Road
Hawthorn East, VIC 3123

1300 464 353 (1300 4 MIELE)

info@miele.com.au

www.miele.com.au

Miele New Zealand Limited

IRD 98 463 631

8 College Hill
Freemans Bay, Auckland 1011

0800 464 353 (0800 4 MIELE)

customercare@miele.co.nz

www.miele.co.nz

Miele Global Headquarters

Germany

Miele & Cie. KG

Carl-Miele-Straße 29

33332 Gütersloh

Federal Republic of Germany

H 7440 BM

en-AU, NZ

M.-Nr. 11 195 640 / 16