

Miele

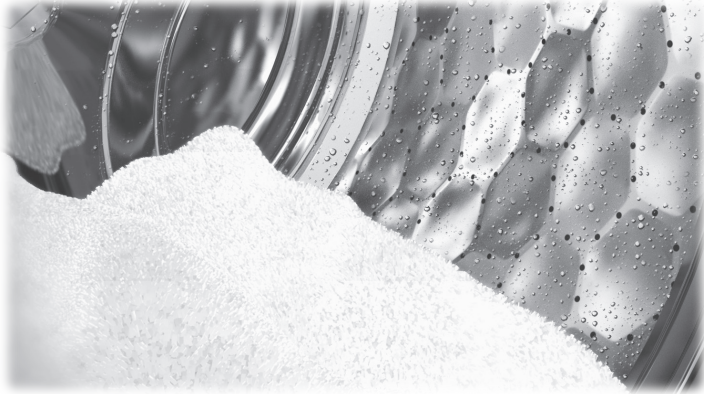

Operating and Installation Instructions

Commercial Washing Machine

PWM 514

PWM 520









Always read the operating instructions before setting up, installing, and commissioning the machine. This prevents both personal injury and damage to the appliance.

en - US, CA

M.-Nr. 11 872 030

Contents

| | |
|--|----|
| Caring for the environment | 5 |
| IMPORTANT SAFETY INSTRUCTIONS | 6 |
| Appropriate use | 7 |
| Preventing misuse | 8 |
| Technical safety | 9 |
| Correct use | 11 |
| Chlorine and component damage | 13 |
| Accessories | 14 |
| Disposing of your old machine | 14 |
| Description of the machine (with detergent compartment) | 15 |
| Models with detergent dispenser drawer (WEK) | 15 |
| Models without detergent dispenser drawer (WEK) | 16 |
| Operation | 17 |
| Control panel | 17 |
| Sensor controls and touch display | 17 |
| Main menu | 18 |
| Examples of how to operate the machine | 18 |
| Operating a laundromat machine | 21 |
| Preparing for use | 22 |
| Emptying pockets | 22 |
| Max. load | 22 |
| Loading the washing machine | 23 |
| Selecting a program | 24 |
| Selecting program settings | 25 |
| Washing with detergent drawer | 26 |
| Adding detergent using the detergent dispenser drawer | 26 |
| Bleaching agent | 27 |
| Dyes, dye removers, and descaling agents | 27 |
| Detergent dispensing | 27 |
| Amount of detergent | 27 |
| Water hardness levels | 27 |
| Program start – program end | 29 |
| Timer | 31 |
| Frequently asked questions | 32 |
| Customer Service | 33 |
| Frequently asked questions | 35 |
| Frequently asked questions | 35 |
| The wash program will not start | 35 |
| Insufficient wash results | 36 |
| General problems with the washing machine | 37 |
| Possible reasons for increased levels of foaming | 38 |
| Stretching of large items | 38 |
| Continuing a program after a power failure | 38 |

| | |
|--|----|
| Cleaning and care | 39 |
| Build-up of rust..... | 39 |
| Cleaning the detergent drawer, detergent compartments, and siphons..... | 40 |
| Installation | 42 |
| Installing the washing machine | 42 |
| Securing the machine..... | 42 |
| General operating conditions | 42 |
| Facilitating maintenance..... | 43 |
| Installation on a base | 43 |
| Shipping struts | 44 |
| Removing the shipping struts | 44 |
| Water connection | 45 |
| Dispensing-agent connection to the liquid-dispensing mixer compartment | 46 |
| Drainage | 47 |
| Electrical connection..... | 47 |
| Extra options | 48 |
| Selecting Extras..... | 48 |
| Pre-wash  | 48 |
| Pre-rinse  | 48 |
| Rinse plus  | 48 |
| Soak  | 48 |
| Intensive  | 48 |
| Water plus  | 48 |
| Rinse hold  | 48 |
| Fill stop  | 48 |
| Special features in the program sequence | 49 |
| Spinning | 49 |
| Omitting the final spin (Rinse hold) | 49 |
| Anti-crease | 49 |
| Changing the program sequence | 50 |
| Changing a program..... | 50 |
| Altering the wash program | 50 |
| Canceling a program | 50 |
| Switching on the washing machine after a power failure..... | 50 |
| Adding or removing laundry | 51 |
| Supervisor level | 52 |
| Opening the Supervisor level | 52 |
| Code-based access | 52 |
| Changing the code..... | 52 |
| Closing the Settings menu | 52 |

Contents

| | |
|---|----|
| Operation/display | 53 |
| Language | 53 |
| Language menu | 53 |
| Set languages | 53 |
| Display brightness..... | 53 |
| Clock display..... | 54 |
| Date..... | 54 |
| Volume | 54 |
| Visibility parameters | 54 |
| Sort Options..... | 54 |
| Machine off status..... | 54 |
| Delay start | 55 |
| Memory | 55 |
| Temperature unit | 55 |
| Weight unit | 55 |
| Program selection | 56 |
| Controls..... | 56 |
| Program packages | 57 |
| Sort programs | 57 |
| Program color allocation | 57 |
| Hygiene | 57 |
| Expert code..... | 57 |
| Process technology | 58 |
| Anti-crease | 58 |
| Service interval..... | 58 |
| Water intake | 59 |
| Legal Information | 59 |
| Technical details | 60 |
| PWM 514 machine data | 60 |
| Electrical connection..... | 60 |
| Installation dimensions..... | 60 |
| Weight and floor load | 60 |
| Emission values | 60 |
| Product safety | 60 |
| WiFi | 60 |
| PWM 520 machine data | 61 |
| Electrical connection..... | 61 |
| Installation dimensions..... | 61 |
| Weight and floor load | 61 |
| Emission values | 61 |
| Product safety | 61 |
| WiFi | 61 |
| WiFi data protection | 63 |
| Data protection and data security | 63 |
| Factory default settings for network configuration..... | 63 |
| Copyrights and licenses | 63 |

Disposal of the packaging material

The packaging is designed to protect the washing machine against damage during transportation. The packaging materials used are selected from materials which are environmentally friendly for disposal and can therefore be recycled.

Recycling the packaging material reduces the use of raw materials in the manufacturing process and also reduces the amount of waste in landfill sites. Your dealer will take the packaging material away.

Disposing of your old machine

Old electrical and electronic machines often contain valuable materials. However, they also contain harmful substances which were essential for their correct functioning and safety. These could be hazardous to human health and to the environment if disposed of with household waste or if handled incorrectly. Therefore, please do not dispose of your old machine with household waste.

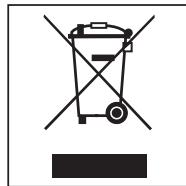

Please dispose of it at your local community waste collection/recycling center for electrical and electronic machines. Consult your dealer if necessary.

Please ensure that your old machine poses no risk to children while being stored for disposal.

Energy saving tips

Energy and water consumption

- Make use of the **maximum** load size that the wash program can accommodate.
The most efficient use of energy and water is achieved when a full load is washed.

Detergent

- Do not exceed the amounts of detergent recommended on the packaging.
- Reduce the amount of detergent for smaller load sizes.

When drying with a tumble dryer

Select the highest possible spin speed for the wash program to save energy in the subsequent drying cycle.

IMPORTANT SAFETY INSTRUCTIONS

This washing machine complies with all current local and national safety requirements. Inappropriate use can, however, lead to personal injury and material damage.

Read the operating instructions carefully before using the washing machine. They contain important information on safety, installation, use, and maintenance. This prevents both personal injury and damage to the washing machine.

Miele expressly and strongly advises that you read and follow the instructions in the section on installing the washing machine as well as the IMPORTANT SAFETY INSTRUCTIONS.

Miele cannot be held liable for injury or damage caused by non-compliance with these instructions.

Keep these operating instructions in a safe place and pass them on to any future user.

When instructing other people how to use the washing machine, they must be made aware of these IMPORTANT SAFETY INSTRUCTIONS.

IMPORTANT SAFETY INSTRUCTIONS

Appropriate use

- ▶ The washing machine is only suitable for washing fabrics with a care label stating that they are suitable for machine washing. Any other applications may be dangerous. The manufacturer cannot be held liable for damage resulting from incorrect or improper use or operation of the machine.
- ▶ This washing machine must be used as described in the operating instructions and must be checked on a regular basis to make sure it is functioning correctly. Maintenance must be carried out when necessary.
- ▶ The washing machine is not suitable for outdoor use.
- ▶ Do not install the washing machine in a room where there is a risk of frost. Frozen hoses are at risk of tearing or bursting. The reliability of the electronic may be impaired at temperatures below freezing point.
- ▶ This washing machine is intended only for use in a commercial environment.
- ▶ If the machine is operated in the commercial sector, it may only be operated by trained or qualified personnel. If the machine is operated in a place open to the public, the supervisor must ensure that its use does not pose a risk.
- ▶ The washing machine must not be used in a non-stationary installation site (e.g., on a ship).
- ▶ This washing machine should not be used by persons with reduced physical, sensory, or mental capabilities, or a lack of experience and knowledge, unless they are supervised or instructed on its use by a responsible person.
- ▶ Children must not be allowed near the washing machine unless they are constantly supervised.
- ▶ Children may only use the washing machine without supervision if its operation has been clearly explained to them and they are able to use it safely. Children must be able to understand and recognize the possible dangers caused by incorrect operation.
- ▶ Children may not carry out cleaning or maintenance on the washing machine unsupervised.
- ▶ Always supervise any children in the vicinity of the washing machine. Never allow children to play with the washing machine.
- ▶ Disinfection programs must not be interrupted, as this can have a limiting effect on the disinfection result. It is the operator's responsibility to ensure that the standard of disinfection in thermal as well as chemo-thermal procedures is maintained by carrying out suitable validation tests.

IMPORTANT SAFETY INSTRUCTIONS

Preventing misuse

▶ Never use solvent-based cleaning agents, e.g., those containing benzene, in this washing machine. This may result in damage to component parts and create toxic fumes. **Risk of fire and explosion!**

▶ When washing with high temperatures, remember that the porthole glass becomes hot. Do not let children touch it during the wash process.

Danger of injury by burning!

▶ Close the drum door after each wash cycle. This is to avoid the risk of children trying to climb into the washing machine or hide things in it, and animals getting into the machine.

▶ Do not damage, remove, or bypass the safety features or control elements of this washing machine.

▶ Machines with a damaged control panel, wires, or cords must not be used until they have been repaired.

▶ Water used for washing in this machine consists of suds and is not drinking water! Drain the suds into a proper drainage system.

▶ Always make sure that the drum is stationary before reaching in to remove laundry. Reaching into a rotating drum is extremely dangerous and may result in injury.

▶ Be careful not to put your hands in the gap between the door and frame when closing the drum door.

Please note: The drum door is locked automatically as soon as the washing machine starts.

▶ It is particularly important to observe the manufacturer's instructions when using a combination of cleaning agents and special application products. Products must only be used for applications approved by the manufacturer to avoid any material damage or the occurrence of strong chemical reactions.

IMPORTANT SAFETY INSTRUCTIONS

Technical safety

- ▶ Before installing the washing machine, check it for visible signs of damage. Do not install or use a damaged washing machine.
- ▶ The electrical safety of this washing machine can only be guaranteed when correctly grounded. It is essential that this standard safety requirement is observed and regularly tested. If in any doubt, please have the electrical installation inspected by a specialist. Miele cannot be held liable for the consequences of an inadequate grounding system.
- ▶ Unauthorized repairs could result in unforeseen dangers for the user, for which the manufacturer cannot accept liability. Repairs must only be carried out by a Miele authorized technician, otherwise any subsequent damage will not be covered by the warranty.
- ▶ Do not make any alterations to the machine, unless authorized to do so by Miele.
- ▶ Disconnect the washing machine from the power supply in the event of a fault and for cleaning and maintenance. The washing machine is only electrically disconnected from the power supply when
 - the electrical plug of the washing machine is unplugged, or
 - the fuse is disconnected, or
 - the screw-in fuse has been completely removed.

For more information, see “Installation – Electrical connection”.

- ▶ The washing machine may only be connected to the water supply using the set of hoses supplied with the machine. Old sets of hoses must not be re-used. Check the sets of hoses regularly for signs of wear. Change the sets of hoses ahead of time to avoid the risk of leaks and subsequent water damage.
- ▶ The cause of any leaks must be dealt with before the washing machine is restarted. Disconnect the washing machine immediately if any water leaks out.
- ▶ In the case of a fault with the steam heating there can be increased temperatures in the vicinity of the door, the detergent compartment panel and in the drum interior (especially at the edges). Danger of burning.
This only applies for machines with steam heating.
- ▶ Faulty components must only be replaced by genuine Miele replacement parts. Miele can only guarantee the safety standards of the machine when Miele replacement parts are used.

IMPORTANT SAFETY INSTRUCTIONS

- ▶ All relevant national provisions and regulations (DGUV in Germany) relating to accident insurance are applicable to this machine. It is recommended to carry out testing in accordance with the regulatory framework described in DGUV 100-500/Chapter 2.6/Section 4. The test book required for the documentation is available from Miele Customer Service.
- ▶ Please observe the instructions in “Installation and connection” and “Technical data”.
- ▶ The electrical plug for the washing machine must always be kept accessible so that the washing machine can be easily disconnected from the power supply.
- ▶ For hard-wired machines, an all-pole means of deactivation must be provided on site.
- ▶ If the washing machine is to be hard-wired, there must be a means of disconnecting all poles from the power supply. The disconnection switch must be close to the washing machine and be clearly identifiable, unhindered, and easily accessible at all times.
- ▶ A central Emergency shut off device must be available for models without an Emergency shut off.

IMPORTANT SAFETY INSTRUCTIONS

Correct use

- ▶ The maximum dry-laundry weight for the PW 514 is 30 lb (14 kg), and for the PW 520 it is 45 lb (20 kg). See the “Program chart” for the maximum recommended loads for individual programs.
- ▶ Before using the washing machine for the first time, check that the shipping struts have been removed (see “Installation – Removing the shipping struts”). During spinning, a shipping strut which is still in place may result in damage to both the washing machine and adjacent furniture or machines.
- ▶ Never try to open the drum door of the washing machine using force. The door can only be opened when a corresponding message appears in the display.
- ▶ Do not push back the soft mount drum of the machine while the machine is running.
- ▶ When closing the door there is a danger of crushing and shearing between the door frame and the drum opening and also at the hinges.
Caution: The drum door locks automatically when the machine is started.
- ▶ Turn off the faucet if the machine is to be left for any length of time (e.g., during vacation), especially if there is no floor drain (gully) in the immediate vicinity.
- ▶ Take care to ensure that foreign objects (e.g., nails, pins, coins, paper clips) do not find their way into the machine with the laundry. These may damage components of the machine (e.g., suds container, drum). Damaged components can damage the laundry.
- ▶ If the correct amount of detergent is dispensed, the washing machine should not need to be descaled. If, however, you do wish to descale your washing machine, only use proprietary non-corrosive descaling agents. Special descaling agent is available from your Miele dealer or from Miele Customer Service. Strictly observe the instructions for the descaler.
- ▶ Fabrics that have been pre-treated in solvent-based cleaning agents must be thoroughly rinsed in clean water before being washed in the machine. Note that solvent residues may only be discharged into waste water in compliance with local legislation.
- ▶ Never use solvent-based cleaning agents, e.g., those containing benzene, in this washing machine. This may result in damage to component parts and create toxic fumes. **Risk of fire and explosion!**
- ▶ Do not store or use gasoline, paraffin, or any easily flammable substances near the washing machine. Do not use the machine lid as storage space.

Risk of fire and explosion!

IMPORTANT SAFETY INSTRUCTIONS

- ▶ Do not store chemicals (liquid detergents, additives) on the machine lid. They may cause discoloration or lacquer damage. Accidentally spilled chemicals should be removed from the surface immediately with a wet cloth.
- ▶ A fan outlet is located on the rear of the washer. This area must not be blocked. Please ensure that the minimum gap required, as shown on the installation drawing, is maintained.
- ▶ Only use dyes, dye removers, and descaling agents suitable for use in a washing machine. The manufacturer's instructions on the packaging must be observed.
- ▶ Dye removers contain sulfur compounds which can cause damage such as corrosion. Do not use these products in this washing machine.
- ▶ Avoid contact of stainless steel surfaces with liquid cleaning and disinfecting agents which contain chlorine or sodium hypochlorite. These agents can cause corrosion on stainless steel. Aggressive chlorine bleach vapors can also be corrosive. Do not store open containers of these agents near the machine.
- ▶ Do not use a power washer or hose to clean the washing machine.

IMPORTANT SAFETY INSTRUCTIONS

Chlorine and component damage

▶ Frequent use of chlorine products increases the risk of damage to components.

▶ The use of substances containing chlorine, such as sodium hypochlorite and chlorine bleach in powder form, can result in damage to the protective layer of stainless steel and corrosion on components. Therefore, refrain from using substances containing chlorine. Use oxygen-based bleaching agents instead.

If, however, chlorine bleaching agents are used, an anti-chlorine treatment must always be carried out. Otherwise, both the washing machine components and the laundry may suffer persistent and irreparable damage.

▶ Anti-chlorine treatment must be carried out immediately after chlorine bleaching agents have been used. Hydrogen peroxide as well as oxygen-based detergents and bleaching agents are suitable for anti-chlorine treatment. The suds must not be drained in between.

Treatments with thiosulfates can result in gypsum-like deposits particularly when used in combination with hard water. This gypsum can build up in the washing machine or cause incrustations on the laundry. Treatment with hydrogen peroxide is recommended over treatment with thiosulfates because hydrogen peroxide neutralizes chlorine.

The exact dispensing quantities and the treatment temperatures required must be set and tested on site in accordance with the dispensing recommendations of the detergent and cleaning agent manufacturers. The laundry must also be tested to check whether it contains any active chlorine residues.

IMPORTANT SAFETY INSTRUCTIONS

Accessories

▶ Only use genuine Miele spare parts and accessories with this machine. Using parts or accessories from other manufacturers will invalidate the warranty, and Miele cannot accept liability.

Disposing of your old machine

▶ Ensure that the door locks are unusable when disposing of or scrapping old washing machines. This will prevent the risk of children accidentally locking themselves in while playing and endangering their lives.

Miele cannot be held liable for damage caused by failure to comply with these IMPORTANT SAFETY INSTRUCTIONS.

Description of the machine (with detergent compartment)

Models with detergent dispenser drawer (WEK)

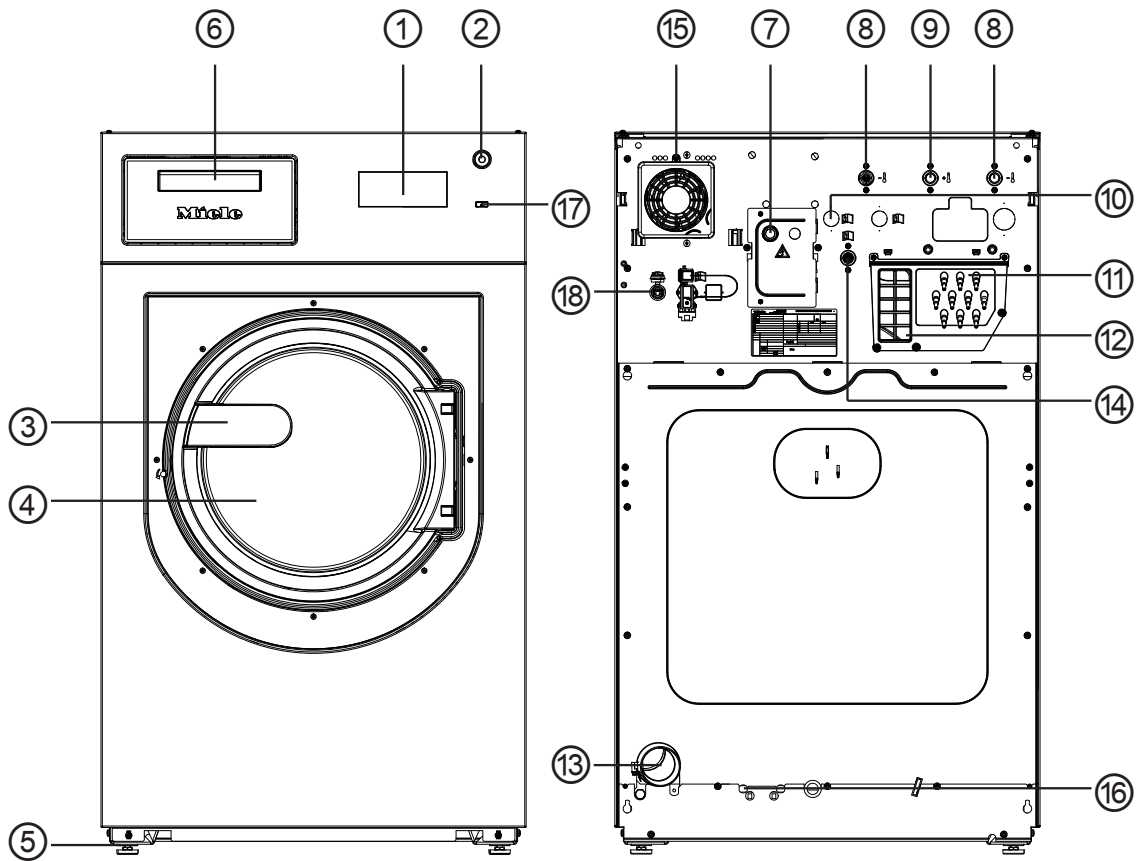

- ① **Display**
see "Control panel"
- ② **Emergency shut-off switch**
see "Control panel"
- ③ **Door handle**
- ④ **Drum door**
- ⑤ **Four adjustable feet**
- ⑥ **Detergent dispenser drawer**
- ⑦ **Electrical connection**
- ⑧ **Cold-water connection**
- ⑨ **Hot-water connection**
- ⑩ **2 x hard-water connection**
(optional)
- ⑪ **Connections for external dispenser pumps**
- ⑫ **Vapor extraction/free outlet Type AB**
- ⑬ **Drainage**
- ⑭ **Cold-water connection for liquid dispensing**
(optional)
- ⑮ **Fan casing**
- ⑯ **Connection option for direct/indirect steam**
(depending on model)
- ⑰ **On/Off button**
- ⑱ **Interface for communicating with external appliances**

Description of the machine (with detergent compartment)

Models without detergent dispenser drawer (WEK)

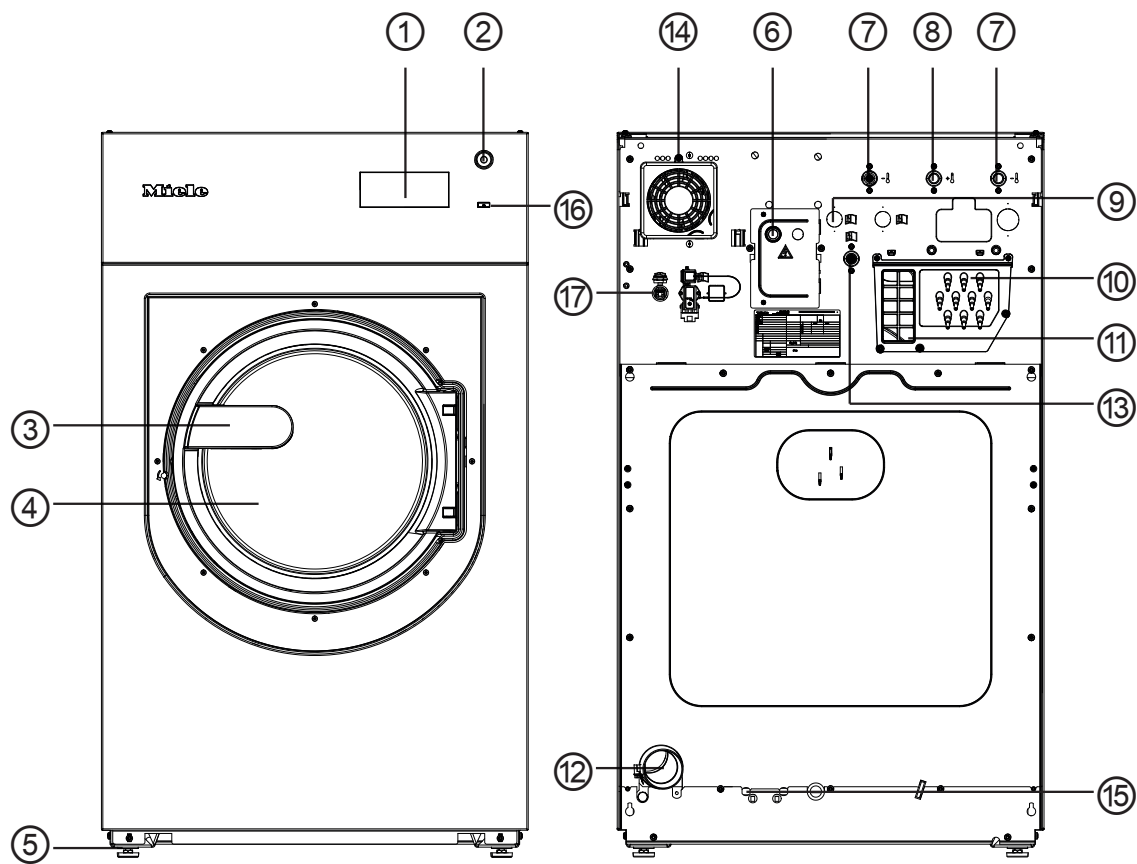

- ① **Display**
see "Control panel"
- ② **Emergency shut-off switch**
see "Control panel"
- ③ **Door handle**
- ④ **Drum door**
- ⑤ **Four adjustable feet**
- ⑥ **Electrical connection**
- ⑦ **Cold-water connection**
- ⑧ **Hot-water connection**
- ⑨ **2 x hard-water connection**
(optional)
- ⑩ **Connections for dispenser pumps**
- ⑪ **Vapor extraction/free outlet Type AB**
- ⑫ **Drainage**
- ⑬ **Cold-water connection for liquid dispensing**
- ⑭ **Fan casing**
- ⑮ **Connection option for direct/indirect steam**
(depending on model)
- ⑯ **On/Off button**
- ⑰ **Interface for communicating with external appliances**

Control panel

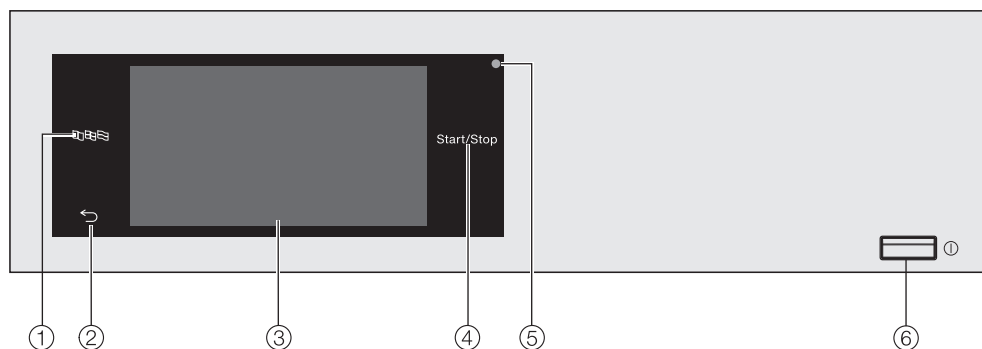

- ① **Language sensor button** 



For selecting the current user language.
The supervisor language is displayed again at the end of the program.
- ② **Back sensor button** 

Takes you back one level in a menu.
- ③ **Touch display**
- ④ **Start/Stop sensor button**

For starting the wash program selected and canceling a program once it has started. The program selected can be started as soon as the sensor button starts flashing.
- ⑤ **Optical interface**
For Customer Service.
- ⑥ **⏻ button**

For switching the washing machine on and off. To save energy, the washing machine will switch off automatically. It is switched off 15 minutes after the end of the program/Anti-crease phase, or after being switched on if no further selection is made.

Sensor controls and touch display

The sensor controls , , and *Start/Stop* and the elements in the display respond to finger tip contact. Every tap of a sensor control is confirmed with an audible keypad tone. You can adjust the volume of the keypad tone or switch it off (see “Supervisor level”).

The control field with sensor controls and the touch display can be scratched by pointed or sharp objects, e.g., pens.
Only touch the control field with your fingers.

Main menu

After switching on the washing machine, the main menu will appear in the display.

You can access all the important submenus from the main menu.

Touch the  sensor button at any time to return to the main menu. Values set previously are not saved.

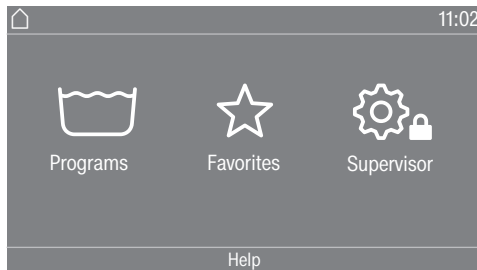

Programs menu

In this menu, you can select the wash programs.

Favorites

For selecting one of 12 favorite wash programs which can be set up and saved by the supervisor (see “Favorite programs” under “Supervisor level”).

Supervisor

You can alter the washing machine's electronic to suit changing requirements in the supervisor level (see “Supervisor level”).

Examples of how to operate the machine

Option lists

Program menu (single selection)



You can scroll to the right or the left by swiping your finger across the screen. To do this, place your finger on the touch display and swipe it in the direction you want.

The orange scroll bar under the pictures shows that there are additional options to choose from.

Touch a program name to select the wash program.

The display will change to the standard menu for that program.

Options menu (multiple selection)

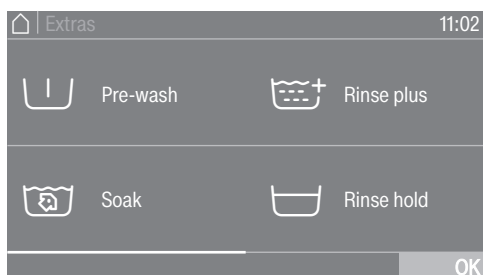

Touch one or several *Options* to select it/them.

Currently selected *Options* are highlighted orange.

To deselect an *Option*, simply touch the *Option* again.

Use the *OK* sensor button to activate all selected *Options*.

Setting numerical values

You can set numerical values in some menus.

The following example shows how to set the time of day. The “Supervisor level” section describes how to get to this level.

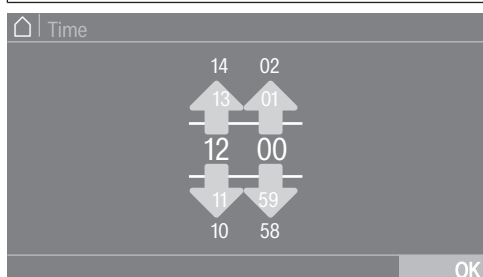

Enter the numbers by swiping upward or downward.

Place your finger on the number that you want to change and move your finger in the direction you want. Use the *OK* symbol to accept the set numerical value.

Tip: A numerical keypad may also appear to adjust the value for some settings.

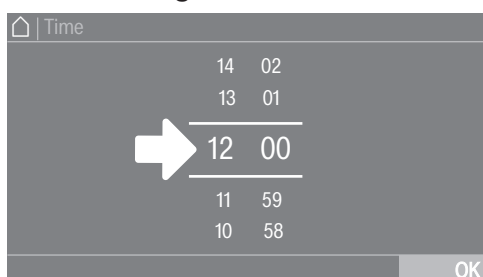

Briefly touching a number between the two lines will bring up the numerical keypad.

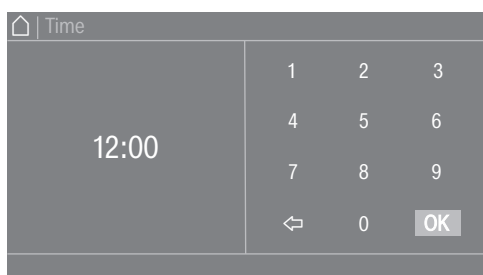

Operation

Once a valid number has been entered, the *OK* symbol will be highlighted green.

Pull-down menu

The following example describes the display for an ongoing wash program. The “Program start – program end” section describes how to get to this level.

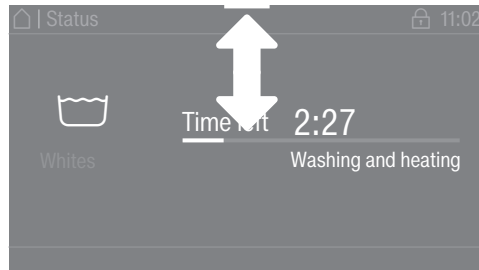

If an orange bar appears at the top of the screen in the middle of the display, you can open the pull-down menu. Touch the bar and drag down with your finger.

Exiting a menu level

- Touch the ↶ symbol to return to the previous screen.

Entries you have made before this which have not yet been confirmed with *OK* will not be saved.

Help display

With some menus, Help appears along the bottom line of the display.

- Touch the Help sensor button to display the text.
- Touch the Close sensor button to return to the previous screen.

Operating a laundromat machine

The entry menu will vary depending on the programming status (see “Supervisor level – Controls”).

Shortcuts are the easiest way to operate the machine. Operating staff are unable to change pre-set programs.

Laundromat, basic

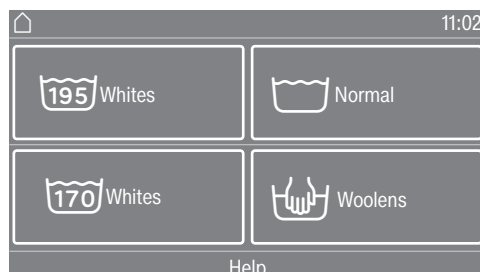

Between 4 and 12 pre-set programs are available. These programs cannot be changed by the user.

Laundromat Logo

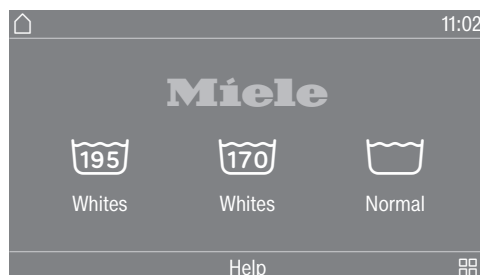

Up to 12 pre-set programs are available. The first 3 programs can be selected directly. The remaining programs are selected from a list . These programs cannot be changed by the user.

Preparing for use

Emptying pockets

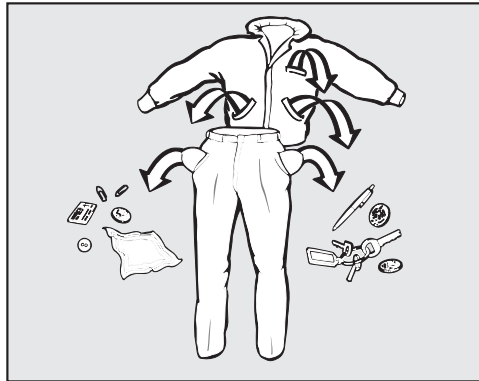

- Empty all pockets.

⚠ Damage due to foreign objects.
Nails, coins, paper clips, and so on can cause damage to garments and components in the machine.
Check the laundry before washing and remove any such foreign objects.

Max. load

(dry laundry)

| PWM 514 | PWM 520 |
|--------------------|--------------------|
| max. 30 lb (14 kg) | max. 45 lb (20 kg) |

Maximum load weights are given in the program chart.

Loading the washing machine

- Switch on the washing machine with the I button.
- Pull the door handle to open the drum door.
- Unfold the laundry and load loosely in the drum. Mixing both large and small items gives better wash results and also helps distribute the load evenly during spinning.

The most efficient use of energy and water is achieved when a full load is washed. However, do not overload as this reduces cleaning efficiency and causes creases.

Closing the drum door

- Close the drum door by pressing it until the pre-latch engages.

 Make sure that no items are caught between the drum door and the seal.

The drum door engages, but is not locked yet. The drum door locks automatically as soon as the machine starts.

Selecting a program

Switching on the washing machine

- Press the  button.

Selecting a program

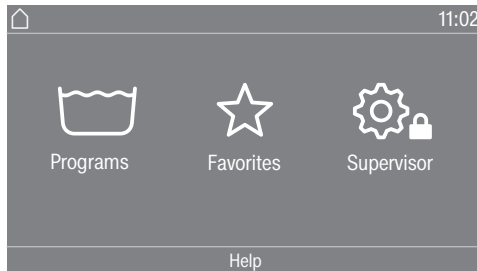

There are different ways to select a program.

You can select a program from the Programs menu.

- Touch the Programs sensor button.



- Scroll to the right in the display until the program you want appears.
- Touch the sensor button for that program.

The display will change to the standard menu for that wash program.

Alternatively, you can select a program from the Favorites menu.

The programs under Favorites can be changed by the supervisor (see “Supervisor level – Favorite programs”).

- Touch the Favorites sensor button.



- Scroll to the right in the display until the program you want appears.
- Touch the sensor button for that program.

The display will change to the standard menu for that wash program.

In the case of Favorite programs, the majority of the program settings are already fixed and cannot be changed.

Selecting a load

To enable load-specific dispensing, you can specify the load for some programs.

- Touch the **Weight sensor** button.
- Enter a valid value for the load quantity.

The display will change to the **Overview** menu.

Selecting a temperature

You can alter the pre-set temperature of a wash program.

- Touch the **Temperature sensor** button.
- Select the temperature you want.

The display will change to the **Overview** menu.

Selecting a spin speed

You can alter the pre-set spin speed of a wash program.

- Touch the **Spin speed sensor** button.
- Select the spin speed you want.

The display will change to the **Overview** menu.

Selecting Options

You can select extra options for some wash programs.

- Touch the **Extras sensor** button.
- Select one or more extra options.
- Confirm with the **OK sensor** button.



The display will change to the **Overview** menu.

See “Options” for further information.

Washing with detergent drawer

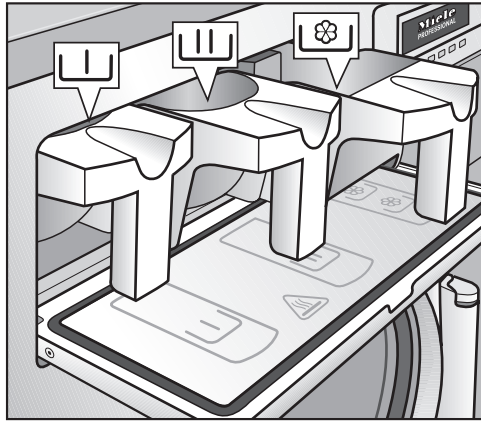
Adding detergent using the detergent dispenser drawer



- For standard wash programs, add powder detergent for the main wash to the  compartment and if desired, add detergent for a pre-wash to the  compartment. Add fabric softener to the front of the  compartment.

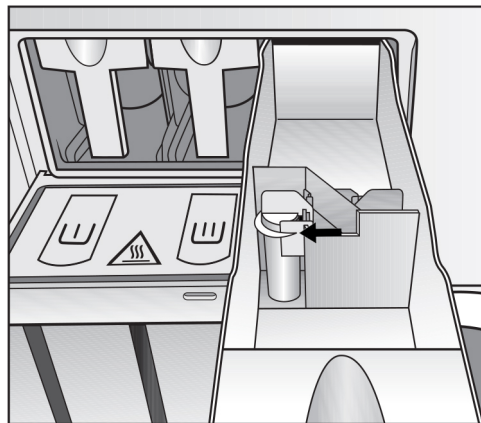

- Add any other liquid agents to the back of compartment  (if this has been programmed).

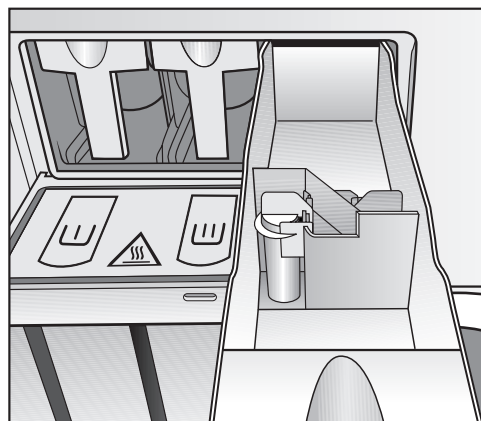

Do not fill the  compartments above the level marker with liquid agents.

They will otherwise run through the siphon and into the suds container before they are needed.

Bleaching agent

Only use bleach on fabrics with the Δ symbol on the care label.

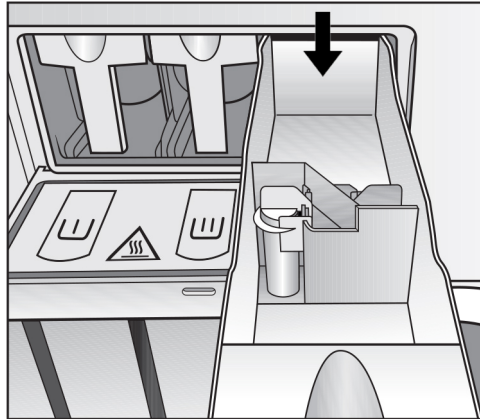

Liquid bleaching agents must only be dispensed through the designated dispenser drawer compartment. Only then it is ensured that the agent is added in to the second rinse cycle automatically. Liquid bleaching agents should only be used on colored textiles which have a wash care label stating that they are suitable for bleaching.

⚠ Frequent use of chlorine products increases the risk of damage to components.

Dyes, dye removers, and descaling agents

Proprietary dyes, dye removers, and descaling agents may only be used in this machine if the manufacturer expressly states that they are suitable for use in a washing machine. The manufacturer's instructions on the packaging must be observed.

Detergent dispensing

Detergent dispensing

Avoid dispensing more than the required amount as this can cause excessive foaming.

- Only use low-foaming detergents.
- Follow the detergent manufacturer's recommendations.

The amount to dispense will depend on:

- the amount of laundry
- the water hardness
- how dirty the laundry is

Amount of detergent

Please dispense according to water hardness levels and follow the detergent manufacturer's instructions.

Washing with detergent drawer

Water hardness levels

| Water hardness level | Total hardness in gpg | German scale °dH |
|----------------------|-----------------------|------------------|
| Soft (I) | 0-8.7 | 0-8.4 |
| Medium (II) | 8.7-14.6 | 8.4-14 |
| Hard (III) | Above 14.6 | Above 14 |

Check with your local water supplier if you do not know the water hardness level in your area.

Starting a program

The program can be started as soon as the *Start/Stop* sensor control is flashing on and off.

- Touch the *Start/Stop* sensor control.

The door will lock (🔒 symbol) and the wash program will start.

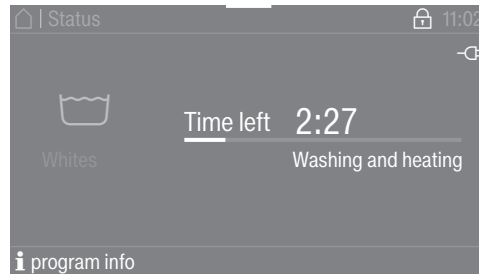

Tip: You can use the pull-down menu to display the selected temperature, spin speed, and any selected Extras.

If a delay start period (⌚ Timer) has been selected, this will appear in the display at the bottom left.

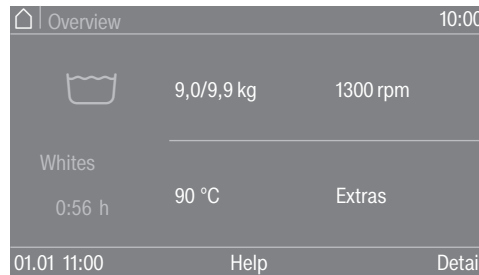

If you select the **i** program info selection area, all program-related information will be displayed.

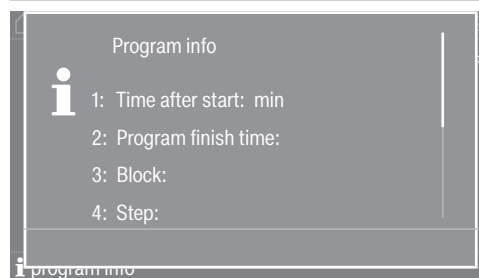

The program duration will appear in the display either straight away or once the delay start period has elapsed. The program sequence is also shown in the display.

Depending on the setting selected in the supervisor level or in the program, the machine will switch to the anti-crease action cycle at the end of the program. The door remains locked. The door can be unlocked at any time by touching the *Start/Stop* sensor control.

Removing the laundry

- Pull open the door.
- Remove the laundry.

Program start – program end

Items left in the drum could discolor other items in the next wash or become discolored themselves.
Remove all items from the drum.

- Check the folds in the door seal for any foreign objects.

Tip: Leave the door slightly open to allow the drum to dry.

- Switch the washing machine off with the Ⓛ button.
- If applicable, remove the used cap from the detergent dispenser drawer.

Tip: Leave the detergent dispenser drawer slightly open to allow it to dry.



The timer can be used to select a program start date, program start time, or program end time. This mode is also referred to as delay start.

Setting the timer

- Touch the  Timer sensor button.
- Select the Finish at, Start in, or Start at option.
- Set the hours and the minutes and confirm your entry with the OK sensor button.



Changing the timer

The selected delay-start period can be changed before the program starts.

- Touch the , , or  sensor control.
- If required, change the specified time and confirm with the OK sensor control.

Deleting the timer

The selected delay-start period can be canceled before the program starts.

- Touch the , , or  sensor button.

The selected delay-start period will appear in the display.

- Touch the Delete sensor button.
- Confirm with the OK sensor button.

The selected delay-start period is deleted.

Starting the timer

- Touch the *Start/Stop* sensor button.

The door will lock and the time until the program starts will appear in the display.

After the program has started, the selected delay-start period can only be changed or canceled by interrupting the program.

The program can be started immediately at any time.

- Touch the Start immediately sensor button.

Frequently asked questions

Power failure during the wash cycle

- Switch off the machine.
- Switch the machine off with the on-site power switch.
- Close the on-site shut-off valves for water or steam.

To remove the laundry, first open the drain valve manually and then manually unlock the door.

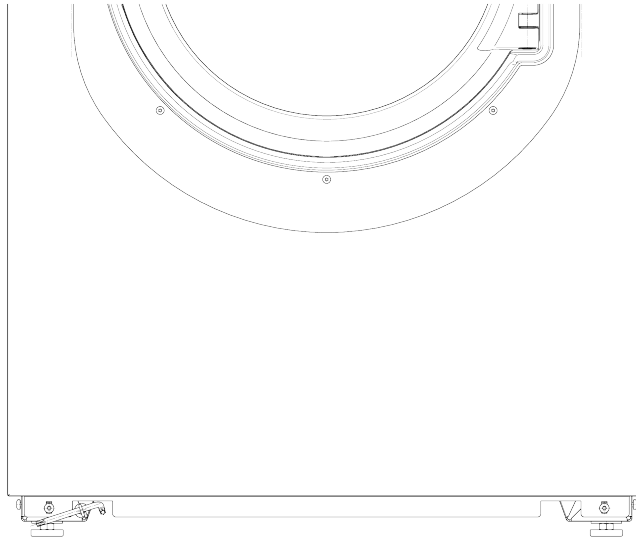

- Guide the T 40 Torx wrench for the emergency-door release through the eye on the front of the machine.
- Open the drain valve by pulling the eye using the Torx wrench.
- Keep pulling the eye until the suds have drained away completely.

The suds will drain away.

The emergency drain closes automatically when the Torx wrench is removed from the eye.

- Push the eye back in as far as it will go.

Opening the door in an emergency in case of a power failure

The drum door cannot be opened.

⚠ Warning! Danger from rotating drum and danger of scalding.
Before inserting the Torx wrench, make sure that the machine is disconnected, the drum has stopped, and there is no water in the machine.

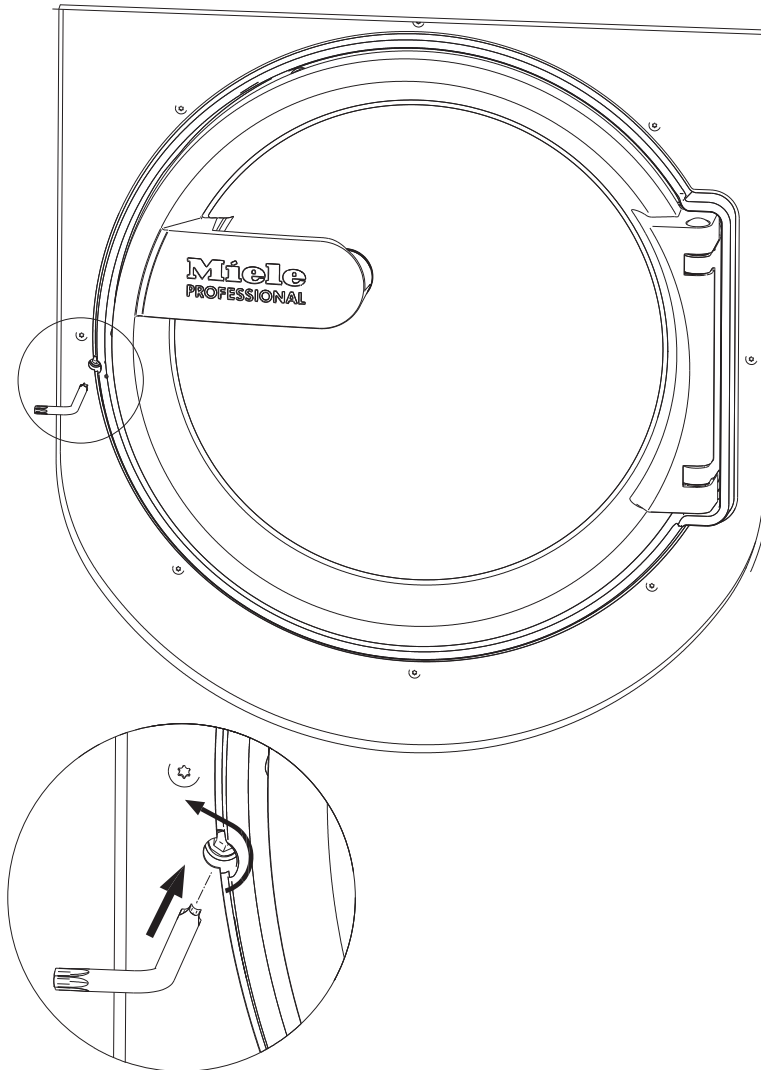

- Turn the release element with a T 40 Torx wrench two whole revolutions **counter-clockwise (left)**.

Tip: Pushing on the door at the same time makes it easier to turn the emergency-release element.

The release element is opposite the door hinge at the same height as the door handle (see diagram).

The release element must not be turned to the right.
This damages the door lock.

The resistance will noticeably decrease. When the release element moves freely, the door is unlocked.

Tip: The release element does not need to be screwed back in.
The door can now be opened.

Customer Service

In the event of a malfunction, contact Customer Service.

Frequently asked questions

When contacting Customer Service, please quote the model, serial number (SN), and material number (mat. no.) of your machine. This information can be found on the data plate. The data plate is visible in the door ring when the drum door is open, or on the back of the machine at the top:

| | | | |
|-----------------|-------------------|-----------------|--|
| Model | | | |
| SN: | / 0 0 0 0 0 0 0 0 | | |
| Art.-Nr. | | Mat -Nr. | |
| IBN | | | |

Symbol icon

Please also tell Customer Service the fault message that appears on the machine display.

Use only original Miele spare parts. Customer Service will also require the model, serial number (SN), and material number (mat. no.) when ordering.

Frequently asked questions

The majority of faults and problems that arise during day-to-day use can be remedied without external assistance. You can save time and money in many cases, as you do not need to contact Miele Customer Service.

The following tables are designed to help you to find the cause of a malfunction or an error and to resolve it. However, please note:

 Repair work to electrical appliances must only be carried out by an authorized technician. Incorrect repairs can cause considerable danger to users.

The wash program will not start



| Problem | Possible cause and solution |
|---|---|
| The display remains dark, and the <i>Start/Stop</i> sensor control does not light up or flash. | There is no power to the washing machine. <ul style="list-style-type: none"> ■ Check whether the washing machine is switched on. ■ Check whether the washing machine is connected to the power supply. ■ Check whether the fuse has tripped. |
| | The washing machine has switched off automatically to save energy. <ul style="list-style-type: none"> ■ Switch the washing machine back on with the  button. |
| There is a fault message on the display | A program cannot be started while there is a fault message on the display. <ul style="list-style-type: none"> ■ Note the information on the display. |
| The display is blank and the <i>Start</i> button indicator is flashing slowly. | The display has switched off automatically to save energy (Standby mode). <ul style="list-style-type: none"> ■ Press any button. Standby will end. |

Frequently asked questions

Insufficient wash results

| Problem | Possible cause and solution |
|---|--|
| Liquid detergent is not achieving the required results. | <p>Liquid detergents usually contain no bleaching agents. They do not remove fruit, coffee, or tea stains.</p> <ul style="list-style-type: none"> ■ Use powder detergent containing a bleaching agent. ■ Pour powder stain remover into drawer (U) in the dispenser compartment and liquid detergent into a dispenser ball. ■ Never put powder stain remover and liquid detergent together in the detergent drawer. |
| There are gray, oily particles clinging to washed laundry. | <p>Insufficient amounts of detergent were used. The laundry was heavily soiled with grease (oils, ointments).</p> <ul style="list-style-type: none"> ■ Use more detergent or use liquid detergent with this type of soiled laundry. ■ Before washing the next load, run a 140°F (60°C) program with liquid detergent and no load. |
| White residues which look like powder detergent are seen on dark textiles after washing. | <p>The detergent contained compounds (zeolites) to aid water softening which are not soluble in water. These have ended up on the laundry.</p> <ul style="list-style-type: none"> ■ Try and brush off the residues with a soft brush once the laundry is dry. ■ In the future, wash dark textiles using a detergent which contains no zeolites. Liquid detergents do not usually contain zeolites. |
| Textiles that were very greasy are not properly clean. | <ul style="list-style-type: none"> ■ Select a program with pre-wash. Use liquid detergent for the pre-wash. ■ Continue to use universal powder detergent for the main wash. |
| | <p>The use of heavy-duty detergent is recommended in the main wash for very heavily soiled workwear. Please seek advice from the detergent and cleaning agent manufacturer.</p> |

General problems with the washing machine

| Problem | Possible cause and solution |
|--|--|
| The washing machine shakes during the spin cycle. | <p>The machine feet are not level and not secured.</p> <ul style="list-style-type: none"> ■ Adjust the machine and secure the feet. |
| Large amounts of detergent residue remain in the detergent drawer. | <p>The water flow pressure is too low.</p> <ul style="list-style-type: none"> ■ Clean the filters in the water intake. |
| | <p>Powder detergent used in conjunction with water softeners tends to become sticky.</p> <ul style="list-style-type: none"> ■ Clean the detergent drawer and in future, add detergent first and then the water softener into the compartment. |
| Fabric softener is not completely dispensed or too much water remains in the  compartment. | <p>The siphon is not correctly positioned or is clogged up.</p> <ul style="list-style-type: none"> ■ Clean the siphon (see “Cleaning and care – Cleaning the detergent drawer”). |
| The display is in a different language. | <p>A different language has been selected in “Settings”  “Language” .</p> <ul style="list-style-type: none"> ■ Set the language you want. The flag symbol will guide you. |
| The door will not open. | <p>There is no power to the machine.</p> <ul style="list-style-type: none"> ■ Check that the machine is switched on. ■ Check that the power supply to the machine is switched on. ■ Check whether the fuse or circuit breaker has tripped. |
| | <p>Power failure</p> <ul style="list-style-type: none"> ■ Open the drum door as described in the next section. |
| | <p>There is still water in the drum and the machine is unable to drain.</p> <ul style="list-style-type: none"> ■ Check if the drain system is blocked. Clean the drainage system as described in the next section. |
| | <p>For safety reasons the drum door cannot be opened if the suds temperature is higher than 130 °F / 55 °C.</p> |

Frequently asked questions

Possible reasons for increased levels of foaming

| Problem | Possible cause and solution |
|---|--|
| Excessive foaming during the wash cycle. | You are using an unsuitable detergent. <ul style="list-style-type: none"> ■ Only use detergent suitable for use in commercial washing machines. Domestic laundry detergent is not suitable. |
| | You are using too much detergent. <ul style="list-style-type: none"> ■ Dispense detergent following the instructions on the packaging and in accordance with local water hardness. |
| | You are using very soft water. <ul style="list-style-type: none"> ■ In areas with water hardness level 1, add less detergent in accordance with the detergent manufacturer's instructions. |
| | The items of laundry are only slightly soiled. <ul style="list-style-type: none"> ■ For lightly soiled laundry, add less detergent in accordance with the detergent manufacturer's instructions. |
| | There are residues in the laundry (e.g., from detergent). <ul style="list-style-type: none"> ■ Additionally, pre-rinse the laundry without setting a temperature and using detergent. |
| | The load is too small. <ul style="list-style-type: none"> ■ Reduce the amount of detergent. |
| | The drum speed is too high during the wash cycle. <ul style="list-style-type: none"> ■ Reduce the drum speed and wash rhythm. |

Stretching of large items

| Problem | Possible cause and solution |
|--|--|
| Large items stretched during spinning | Large items can get stretched during spinning. <ul style="list-style-type: none"> ■ This can mostly be prevented by reprogramming. Contact Customer Service. |

Continuing a program after a power failure

If a running program is interrupted, e.g., by a power outage, the program can be continued when power is restored.

- Switch on the washing machine with the **I** button.
- Then press "START".

The program will then continue with the next program stage.

- Carry out cleaning and maintenance of the washing machine after use if possible.

Do not use a pressure washer or water jet to clean the washing machine.

- Clean the **machine casing, control panel, and plastic parts** with a mild, non-abrasive cleaning agent or with a soft, damp cloth only. Wipe dry with a soft cloth.

Scouring agents will scratch the surface.

- Clean stainless-steel parts of the casing with a standard commercial stainless-steel cleaner.
- Remove any deposits from the door seal with a damp cloth.

Cleaning agent can seep into electrical components.

- When disinfecting the surfaces, use a damp cloth only to clean the front and around the door lock. Do not spray any liquids.

Tip: Heavy deposits of dust around the vents housing should be removed with a vacuum cleaner. The fan housing is located on the back of the machine.

Build-up of rust

The drum is made of stainless steel. Water or foreign objects containing ferrous substances (e.g., paper clips, metal buttons, or metal swarf) which are placed in the machine with the laundry can cause a build-up of rust in the drum. Clean the drum regularly in this case and if rust occurs, remove it immediately with a proprietary stainless steel care product. Check the door seals for ferrous residues and clean thoroughly as described above. This must be carried out regularly.

Cleaning and care

Cleaning the detergent drawer, detergent compartments, and siphons

- Clean the detergent drawer and the detergent compartments thoroughly with hot water as required to remove detergent residues and incrustations.
- If the machine is not going to be used for a long time, leave the flap of the detergent drawer open.
- Also clean the siphons in the compartments for cleaning agents.

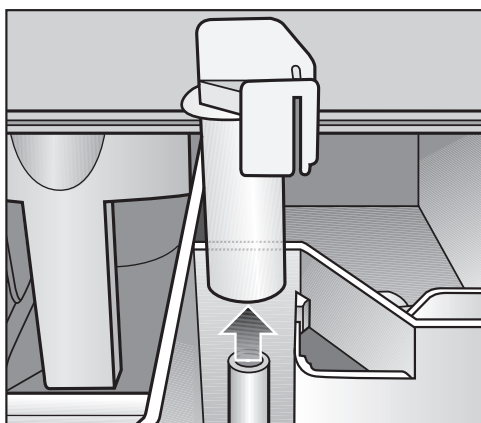

- Remove the siphon. Clean the siphon with hot water and reinsert it.

Cleaning the drip channel and siphon

- Open the flap on the detergent drawer to an angle of 45° and lift out the flap of the detergent drawer on the right side.



If the drip channel and associated drain connection are blocked, clean them.

- Check the vapor extraction grille on the rear of the machine for soiling from time to time and clean when necessary.

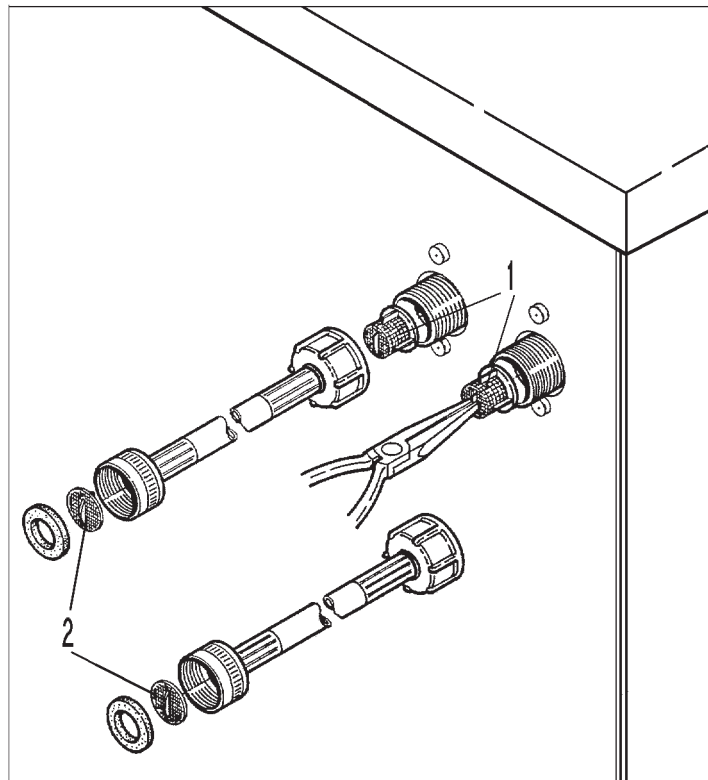

- The filters in the water intake valves (1) and the inlet hoses (2) must be checked for soiling from time to time and cleaned as necessary.

Installing the washing machine

The washing machine must be installed by Miele Customer Service or by an authorized dealer. Please observe the instructions in the installation plan.

This washing machine is only intended for items of laundry that have not been proofed with dangerous or inflammable substances.

- To avoid the risk of frost damage, the washing machine must not be located in rooms which may be subject to very low temperatures.
- Transport the machine on a pallet truck inside the room.

Machines with feet must not be pushed to move them. This could damage the machine feet.

- Remove the packaging carefully with a suitable tool.
- Lift the machine off the pallet using a lifting device.

Securing the machine

- The feet of the washing machine must be secured to the floor using the fixtures and fastenings supplied.

The material provided is intended for use in bolting the machine to a concrete floor. If other floor types are present at the installation site, the fastening material must be ordered separately.

General operating conditions

This washing machine is intended only for use in a commercial environment and must only be operated indoors.

Ambient temperature in installation room: 32°F (0°C) to 140°F (40°C)

Relative humidity: non-condensing

Depending on the nature of the installation site, sound emissions and vibration may occur.

Tip: Have the machine's installation site inspected and seek the advice of a specialist in instances where increased noise may cause a nuisance.

Facilitating maintenance

To facilitate future maintenance and servicing by Customer Service, the minimum clearances and distance to the wall must be provided to enable access.

- Observe the recommended distances from the wall for easier service access.

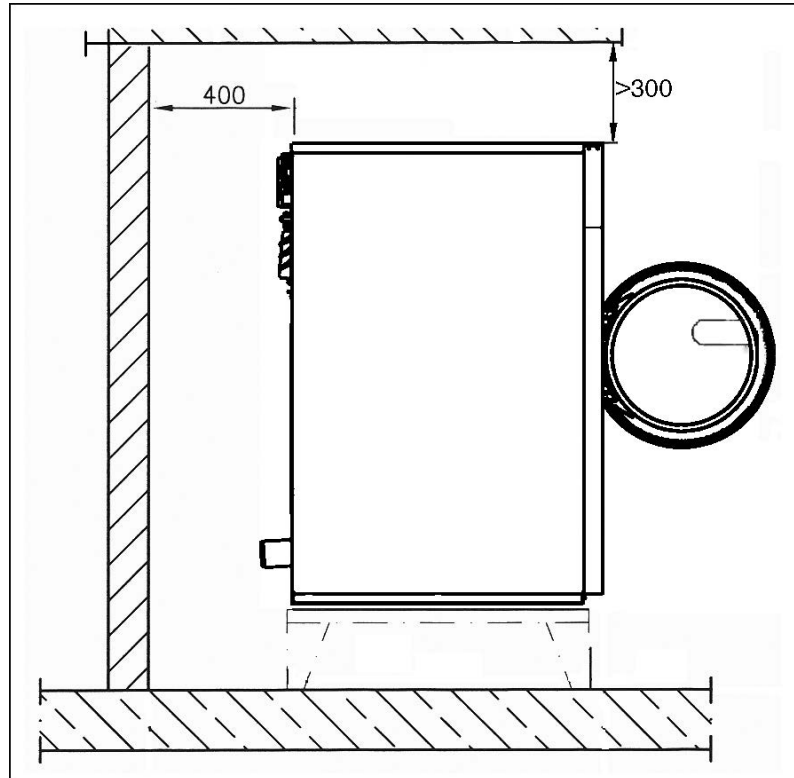

Minimum safety distance to the wall approx. 15 3/4" (400 mm) to allow for maintenance.

- Adjust the washing machine's adjustable feet until the machine is level.

The washing machine must be completely level to ensure smooth operation.

Installation on a base

When installed on a raised base, the machine must be secured to the base and the base must be secured to the floor. When installed on a concrete base, the machine must be secured to the base.

Shipping struts

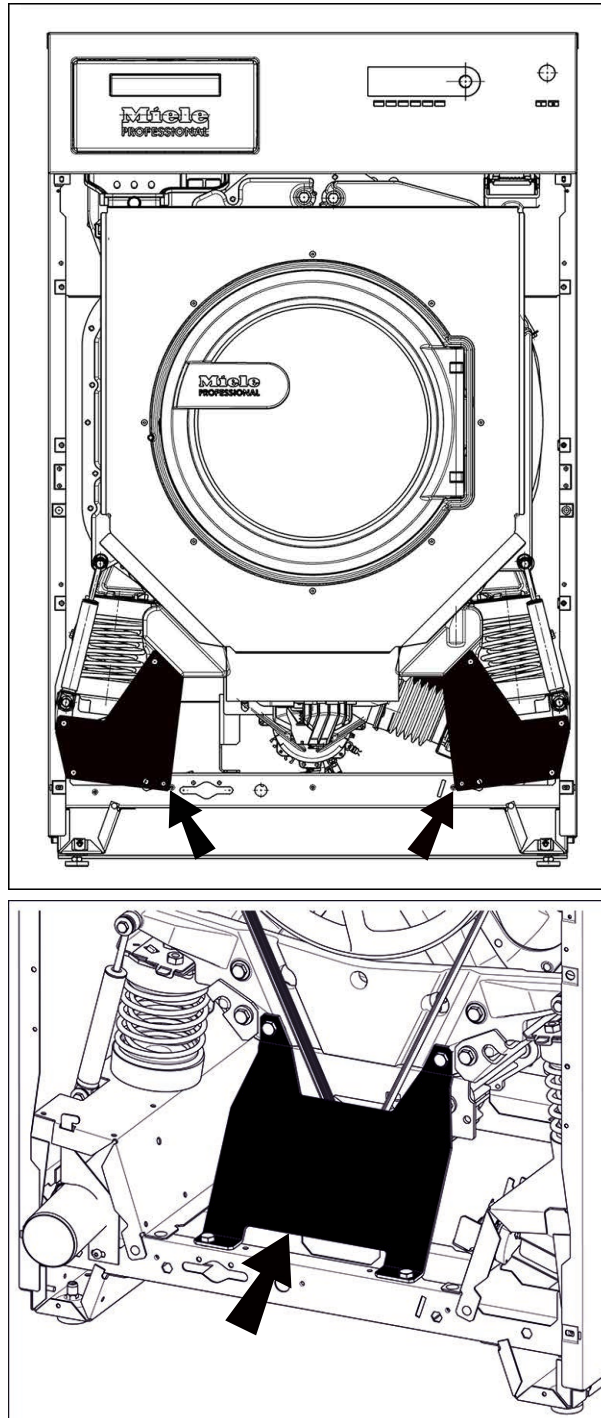

Removing the shipping struts

The 2 shipping struts in the front are secured with 3 hexagonal screws each. The shipping strut in the back is secured with 4 hexagonal screws. The shipping struts must only be removed at the installation site before the washing machine is commissioned.

- Remove the front and back panel:
- Unscrew the screws at the bottom of the front panel and remove the panel.

- Unscrew the screws at the bottom of the back panel and remove the panel.
- Loosen the hexagonal screws to remove the shipping struts.

Keep the shipping struts. They must be re-assembled before transporting the machine.

Water connection

Water pressure (flow pressure) of a minimum 14.5 psi (100 kPa)/max. 145 psi (1000 kPa) is required to guarantee problem free program operation.

The machine must be connected to the water supply using the inlet hoses provided.

Hoses must be replaced with hoses tested for a burst pressure of at least 1015 psi (7000 kPa) overpressure and for water temperatures of a minimum of 194 °F / 90 °C.

This also applies for associated connection fittings. Miele original replacement parts fulfil these requirements.

The temperature of the hot water inlet must not exceed 158°F (70°C) on machines with electric heating (EL).

The temperature of the hot water intake must not exceed 194°F (90°C) on machines without heating (EH).

The machine must be connected to the water supply using the inlet hoses provided.

Dispensing-agent connection to the liquid-dispensing mixer compartment

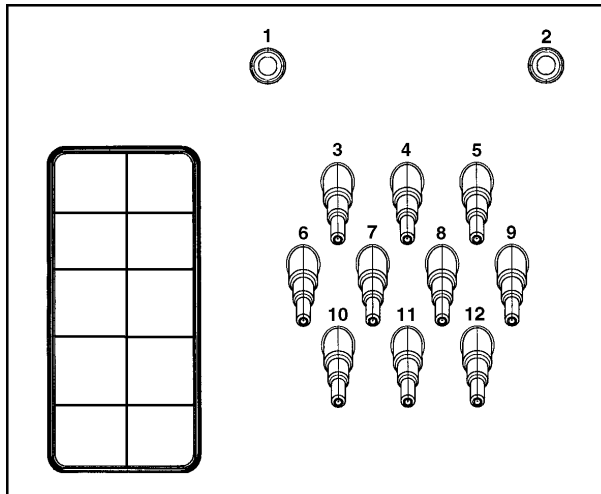

Connections **1** and **2** are provided for viscous agents. These connectors are closed and must be drilled open using an 8 mm bit.

Connections **1** and **2** can also be used for high-pressure dispensing systems with water injection.

The dispensing systems must be equipped with a separate drinking-water safety feature in accordance with EN 61770 and EN 1717.

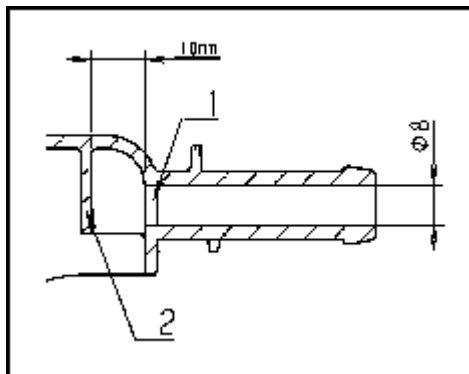

Care must be taken to drill through the first wall (1) only, as there is a deflecting wall (2) 3/8" (10 mm) behind it.

If the drilled-out connections are no longer required, they must be re-sealed.

Connections **3** to **12** are provided for liquid dispensing. These connectors are sealed and must be cut to suit the diameter of the hose with a suitable hacksaw. If opened connectors are no longer required, they must be capped off.

Drainage

Drain valve **DV** on machine side DN 70, on-site socket DN 70. Flow rate temporary 200 l/min.

If the slope for drainage is extremely steep, the piping must be vented to prevent a vacuum from forming in the washing machine's drainage system.

Foam and vapor venting kit **BWS**

If excessive suds form, foam may escape from the vapor extraction. To remove the foam, an optional vapor venting kit (BWS) can be used.

Electrical connection

The electrical connection must only be carried out by a suitably qualified electrician in accordance with local and national regulations.

Tip: Open the machine lid. The connection points are located on the machine frame.

When installing a residual current device (RCD), it must be **Type B**.

The voltage is stated on the data plate.

For hard-wired machines, an all-pole means of deactivation must be provided on site. Switches with a minimum contact gap greater than 1/8" (3 mm) are suitable disconnectors.

The plug connector or isolator switch should be easily accessible at all times.

If the machine is disconnected from the electricity supply, the isolator must be lockable or the point of disconnection must be monitored at all times.

Please check the enclosed wiring diagram.

Extra options

You can add extra options to the wash programs.

Not all extra options can be selected with every program. If an extra option is not listed, it is not permitted for use with the wash program in question.

Selecting Extras

- Touch the **Extras** sensor control.
- Select one or more of the available Extras.
- Confirm with the **OK** sensor button if several Extras are available.

Pre-wash

A pre-wash can be added for heavily soiled laundry. Coarse soiling is loosened and removed before the main wash.

Pre-rinse

The laundry is rinsed before the main wash to remove larger quantities of soiling, e.g., dust, sand.

Rinse plus

An extra rinse can be activated to achieve a more thorough wash result.

Soak

For heavily soiled and stained items with protein stains. The soak duration is 10 minutes.

Intensive

For hard-wearing laundry that is very heavily soiled. Cleaning efficiency is increased through more intense mechanical action and the application of more heat energy.

Water plus

The water level in the main wash and the rinses will be increased.

Rinse hold

The laundry is not spun after the final rinse and remains in the rinse water. This helps prevent creasing if the laundry is not going to be removed from the washing machine drum immediately after the end of the program.

Fill stop

Water is drained out of the machine before the last rinse and the program stops. Laundry after-treatment agents, such as starch, can be added via the detergent dispenser drawer.

The program is continued with the *Start/Stop* sensor button.

Special features in the program sequence

Spinning

Final spin speed

When a program is selected, the maximum spin speed for this wash program is shown in the display.

You can reduce the final spin speed.

However, you cannot select a final spin speed higher than that shown in the chart.

Rinse-spin

There is a spin cycle after the main wash and between the rinse cycles. A reduction in the final spin speed will also reduce the rinse-spin speed as appropriate.

Omitting the final spin (Rinse hold)

- Select the *Rinse hold* extra option and then the *Drain* program. After the last rinse cycle, the water will be pumped away and the Anti-crease phase will switch on.

Anti-crease

At the end of the program, the drum continues to turn at intervals for up to 30 minutes to help prevent creasing. The washing machine can be opened at any time.

| |
|--|
| There is no anti-crease phase at the end of some programs. |
|--|

Changing the program sequence

Changing a program

Altering the wash program

You will need to cancel the current program before you can select a new one.

Canceling a program

You can cancel a wash program at any time after it has started.

- Touch the *Start/Stop* sensor control.

The following will appear in the display:

i Cancel the program?

- Select yes.

The following will appear in the display:

Program cancelled.

The suds are pumped away.

- Wait until the door unlocks.
- Pull open the door.
- Remove the laundry.

Switching on the washing machine after a power failure

If the washing machine is switched off with the  button during a wash program, the program will be interrupted.

- Switch the washing machine back on with the  button.
- Note the message in the display.
- Touch the *Start/Stop* sensor control.

The program continues.

Adding or removing laundry

You can add or remove items during the first few minutes after the program has started.

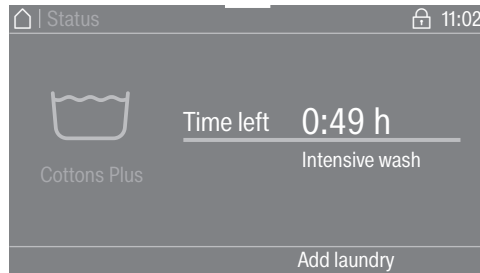

- Touch the **Add laundry** sensor button.

If the message **Add laundry** is not visible in the display then it is no longer possible to add items of laundry.

The wash program will stop and the door will unlock.

 **Risk of chemical burns from detergent.**
When adding or removing laundry, your skin may come into contact with detergent, particularly if the detergent is dispensed externally.
Take care when placing your hands inside the drum.
If suds have come into contact with the skin, rinse off immediately with plenty of lukewarm water.

- Pull open the door.
- Add laundry or remove individual items.
- Close the door.
- Touch the *Start/Stop* sensor button.

The wash program will continue.

The door lock will remain activated if the temperature in the drum is above 130°F (55°C). The door lock will not deactivate until the temperature has dropped to below 130°F (55°C).

Supervisor level

Opening the Supervisor level

- Switch on the washing machine.

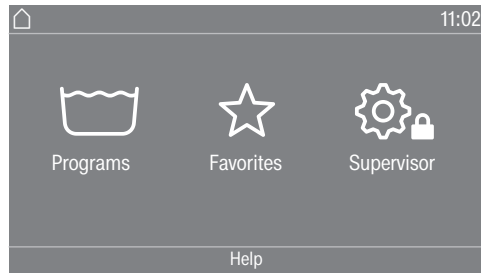

- Touch the Supervisor  sensor control.

The display will change to the Supervisor level menu.

Code-based access

The supervisor level is accessed using a code.

The code is **000** (factory default).

After entering the code, you will be in the supervisor level. The individual setting options are described in the following sections.

Changing the code

You can alter the supervisor level access code to protect the washing machine from unauthorized access.

Please inform Miele Customer Service if you have forgotten your new code. Customer Service will have to reset the code.
Make a note of your new code and store it in a safe place.

Closing the Settings menu

- Touch the  symbol.

The display will then go back to the previous menu level.

- Touch the  symbol.

The display will change to the main menu.

Operation/display

Language

The display can be set to appear in one of several different languages. To select the permanent supervisor language you want, go to the Languages submenu.

When a program is running, you can change the user language using the  sensor button.

Language menu

The display can be set to one of several different user languages. This setting allows you to determine how languages can be selected.

International

6 languages are available. The  sensor button is not active. Note the setting *Set languages*.

Language setting

The  sensor button can be used to select a language. All languages are available (factory default).

You can change the order of the first 4 languages. These slots are allocated to the most commonly used languages.

Standard language

The user language cannot be changed. The user language is the same as the supervisor language. The  sensor button is not active.

Set languages

The languages for the *Language* entry *International* setting can be changed.

6 languages can be selected. All languages are available.

If you wish to add a new language to the language menu:

- First select the language you want to replace.

All available languages are displayed.

- Select and confirm the language to replace the previous language.

The new language appears instead of the old one.

Display brightness

The brightness of the display can be altered. The setting depends on the various lighting conditions in the place of installation.

It can be set to one of 10 different levels.

Supervisor level

Clock display

After selecting the clock format, you can set the time of day.

Clock format

- 24 h clock
- 12 h clock
- No clock

Set

- The time can be set.

Date

The date can be set after selecting the date format.

Date format

- DD.MM.YYYY
- YYYY.MM.DD
- MM.DD.YYYY

Date

- The date can be set.

Volume

The volume for various sounds can be changed.

- Finish tone
- Keypad tone
- Welcome tone

It can be set to one of 7 different levels or switched off altogether.

- Fault alarm

The fault alarm can be activated or deactivated.

Visibility parameters

Various parameters, such as the temperature, spin speed, extra options, etc., are displayed when a program is selected. You can decide which parameters should not be displayed. These parameters can then not be edited during program selection.

Factory default: All parameters are visible (marked in orange)

Sort Options

Under the setting *Visibility parameters*, *Sort Extras* appears in the bottom line. Touch the sensor button to change the sequence of extra options (see “Supervisor level – Arranging programs”).

Machine off status

In order to save energy, the washing machine will switch off automatically after the end of the program or if no further selection is made. You can change this setting.

Changing this setting leads to increased energy consumption.

- No switch off
- Switch off after 15 minutes (factory default)

- Switch off after 20 minutes
- Switch off after 30 minutes

Delay start

The delay start (timer) display can be switched on or off.

Factory default: On

Memory

The washing machine will save the settings (temperature, spin speed, and some of the options) which have been selected for a wash program after the program has started.

When the wash program is chosen again, the saved settings will appear in the display.

Factory default: Off

Temperature unit

You can select the unit for the temperature display.

Factory default: °C/Celsius

Weight unit

You can decide whether load quantities are displayed in “kg” or “lbs”. You can also switch this information off altogether.

Factory default: kg

You can alter the access code to the Supervisor level.

- Enter the current code.
- Enter a new code.

Supervisor level

Program selection

Controls

You can select whether the washing machine is operated as a laundromat machine. Shortcuts are the easiest way to operate the machine. Operating staff are unable to change pre-set programs.

Tip: Start by configuring all necessary settings and changes to the washing machine before adjusting any of the options below.

If “Laundromat, basic” or “Laundromat, Logo” are selected, the Supervisor level can no longer be opened from the display after the *Supervisor level* is closed. Please follow the instructions below if you wish to change any other settings.

Standard (factory default).

All functions and programs can be displayed.

Laundromat, basic

Up to 12 programs are available. Go to Favorite programs to select which programs are to be listed.

Laundromat Logo

Up to 12 programs are available. Go to Favorite programs to select which programs are to be listed.

External program selection

Programs are selected using a communication module, e.g., an external terminal.

| | |
|---------------------------------|---|
| Program packages | <p>The selection of programs can be expanded by activating single programs from the target group program packages.</p> <p>The programs selected from the program packages (marked in orange) are displayed under program selection.</p> |
| Sort programs | <p>Programs can be moved within the program list and in the Favorites list.</p> <p>Factory default: Off</p> |
| Moving programs | <ul style="list-style-type: none">■ Touch the selection area for the program you want to move.■ Press and hold the selection area until the frame changes.■ Drag the program to the required place. |
| Program color allocation | <p>You can assign a color to a Favorite program. In the list of Favorites, each Favorite program is given a colored frame, which can be adjusted.</p> <p>Factory default: On</p> |
| Hygiene | <p>If a program at a temperature below 140°F (60°C) has been used, a request to start the Maintenance Wash Hygiene program appears in the display.</p> <p>Factory default: Off</p> |
| Expert code | <p>A code has to be entered to cancel a disinfection program. The code can be modified.</p> <p>The code is: 0 0 0</p> <p>Make a note of your new code if you ever change it.</p> |

Supervisor level

Process technology

Anti-crease

The Anti-crease function helps prevent creasing after the end of the program. At the end of the program, the drum continues to turn for up to 30 minutes.

The washing machine door can be opened at any time during the Anti-crease phase.

Factory default: On

Service interval

Service information can appear in the display. You can configure whether a date or the number of operating hours is displayed.

You can select up to 3 messages with their own text.

Your message is displayed at the end of the program and can be acknowledged with *OK*. The same message appears at the end of the next program.

Settings

This setting allows you to determine the interval (by hours or date) at which the message appears.

- Factory default: Off
- By time
You can then select a time interval from 1–9,999 hours.
- By date
You can then enter a date.

Message text

Enter your message for your planned maintenance work.

Resetting the display

The message appears until the display is permanently reset. The message then appears again once the next interval is reached.

Water intake

Pre-wash

You can select the water type for the pre-wash.

- Cold

Only cold water is used for the pre-wash.

- Hot

Hot water is also added for the pre-wash.

Hot water can only be added if the wash temperature is above 86°F (30°C).

Main wash

You can select the water type for the main wash.

- Cold

Only cold water is used for the main wash.

- Hot

Hot water is also added for the main wash.

Hot water can only be added if the wash temperature is above 86°F (30°C).

Program cycle times will be longer if the washing machine is not connected for hot water; this may mean that the “Time left” display is incorrect.

First rinse

You can select the water type for the first rinse in some programs.

- Cold (factory default)

Only cold water is used for the first rinse.

- Hot

Hot water is also added for the first rinse.

Final rinse

You can select the water type for the last rinse in some programs.

- Cold (factory default)

Only cold water is used for the final rinse.

- Hot

Hot water is also added for the final rinse (only possible for programs with a temperature of at least 140°F /60°C).

Legal Information

Open Source Licenses

You can view information here (see WiFi data protection).

Technical details

PWM 514 machine data

Electrical connection

| | |
|--------------------|----------------|
| Connection voltage | See data plate |
| Frequency | See data plate |
| Power rating | See data plate |
| Current | See data plate |
| Fuse rating | See data plate |
| Heater rating | See data plate |

Installation dimensions

| | |
|--|--------------------|
| Casing width (without add-on components) | 31 5/16" (795 mm) |
| Casing height (without add-on components) | 53" (1347 mm) |
| Casing depth (without add-on components) | 35 1/4" (895 mm) |
| Overall machine width | 31 7/16" (799 mm) |
| Overall machine height | 53 1/8" (1350 mm) |
| Overall machine depth | 43 1/16" (1093 mm) |
| Minimum width of transport opening | 35 7/16" (900 mm) |
| Minimum distance between wall and front of machine | 54 3/8" (1380 mm) |
| Door opening diameter | 16 5/16" (415 mm) |
| Door opening angle | 180° |

Weight and floor load

| | |
|-------------------------------------|-----------------------|
| Net weight | see installation plan |
| Maximum floor load during operation | see installation plan |

Emission values

| | |
|---|----------------------|
| Emission sound pressure level in accordance with EN ISO 11204/11203 | < 70 dB(A) re 20 µPa |
| Sound power level, EN ISO 9614-2 | < 80 dB(A) |

Product safety

| | |
|--------------------------|----------------|
| Product safety standards | See data plate |
|--------------------------|----------------|

WiFi

| | |
|---|------------------|
| Frequency range of the WiFi module | 2.400–2.4835 GHz |
| Maximum transmission power of the WiFi module | < 100 mW |

PWM 520 machine data

Electrical connection

| | |
|--------------------|----------------|
| Connection voltage | See data plate |
| Frequency | See data plate |
| Power rating | See data plate |
| Current | See data plate |
| Fuse rating | See data plate |
| Heater rating | See data plate |

Installation dimensions

| | |
|--|---------------------|
| Casing width (without add-on components) | 36 1/4" (920 mm) |
| Casing height (without add-on components) | 57 1/16" (1,450 mm) |
| Casing depth (without add-on components) | 33 3/4" (857 mm) |
| Overall machine width | 36 3/8" (924 mm) |
| Overall machine height | 57 3/16" (1,452 mm) |
| Overall machine depth | 37 3/8" (950 mm) |
| Minimum width of transport opening | 36 5/8" (930 mm) |
| Minimum distance between wall and front of machine | 49 3/16" (1,250 mm) |

Weight and floor load

| | |
|-------------------------------------|-----------------------|
| Net weight | see installation plan |
| Maximum floor load during operation | see installation plan |

Emission values

| | |
|---|----------------------|
| Emission sound pressure level in accordance with EN ISO 11204/11203 | < 70 dB(A) re 20 µPa |
| Sound power level, EN ISO 9614-2 | < 80 dB(A) |

Product safety

| | |
|--------------------------|----------------|
| Product safety standards | See data plate |
|--------------------------|----------------|

WiFi

| | |
|---|------------------|
| Frequency range of the WiFi module | 2.400–2.4835 GHz |
| Maximum transmission power of the WiFi module | < 100 mW |

Technical details

ANY CHANGES OR MODIFICATIONS NOT EXPRESSLY APPROVED BY THE PARTY RESPONSIBLE FOR COMPLIANCE COULD VOID THE USER'S AUTHORITY TO OPERATE THE EQUIPMENT.

THIS DEVICE COMPLIES WITH PART 15 OF THE FCC RULES AND CONTAINS LICENSE-EXEMPT TRANSMITTER(S)/RECEIVER(S) THAT COMPLY WITH INNOVATION, SCIENCE AND ECONOMIC DEVELOPMENT CANADA'S LICENCE-EXEMPT RSS STANDARD(S). OPERATION IS SUBJECT TO THE FOLLOWING TWO CONDITIONS: (1) THIS DEVICE MAY NOT CAUSE HARMFUL INTERFERENCE, AND (2) THIS DEVICE MUST ACCEPT ANY INTERFERENCE RECEIVED, INCLUDING INTERFERENCE THAT MAY CAUSE UNDESIRE OPERATION.

Contains FCC ID: 2ACUWEK047

Contains IC: 5669C-EK047

RADIATION EXPOSURE STATEMENT: THIS EQUIPMENT COMPLIES WITH FCC AND WITH ISED RADIATION EXPOSURE LIMITS SET FORTH FOR AN UNCONTROLLED ENVIRONMENT. THIS EQUIPMENT SHOULD BE INSTALLED AND OPERATED WITH A MINIMUM DISTANCE OF 20CM BETWEEN THE RADIATOR AND YOUR BODY. THIS DEVICE AND ITS ANTENNA(S) MUST NOT BE CO-LOCATED OR OPERATION IN CONJUNCTION WITH ANY OTHER ANTENNA OR TRANSMITTER.

Data protection and data security

When you activate the networking function and connect your machine to the Internet, your machine sends the following data to the Miele Cloud:

- machine serial number
- machine model and technical features
- machine status
- information about the software status of your machine

Initially, this data cannot be assigned to a specific user and is not saved permanently. Data cannot be saved permanently or assigned to a specific user until after you have linked your machine to a user. Data transmission and processing are governed by Miele's strict security standards.

Factory default settings for network configuration

You can reset all of the settings on the communication module or your integrated WiFi module to the factory default settings. The network configuration should be reset whenever a machine is being disposed of or sold, or if a used machine is being put into operation. This is the only way to ensure that all personal data has been removed and the previous owner will no longer be able to access the machine.

Copyrights and licenses

For the purpose of operating and controlling the communication module, Miele uses proprietary or third-party software that is not covered by open source licensing terms. This software/these software components are protected by copyright. The copyrights held by Miele and third parties must be respected.

This communication module contains software components which are distributed under open source licensing terms. The open source components contained in the machine along with the corresponding copyright notices, copies of the licensing terms valid at the time, and any additional information can be accessed locally by IP via a web browser (*<https://<IP address>/Licenses>*). The liability and warranty arrangements for the open source licenses displayed in this location only apply in relation to the respective rights holders.

**Please have the model and serial number
of your machine available when
contacting Technical Service.**

U.S.A.

Miele, Inc.

National Headquarters

9 Independence Way
Princeton, NJ 08540
Phone: 800-991-9380
www.mieleusa.com/professional
prosales@mieleusa.com

Technical Service & Support

Phone: 800-991-9380
proservice@mieleusa.com

Canada

**Importer
Miele Limited**

Professional Division

161 Four Valley Drive
Vaughan, ON L4K 4V8
Phone: 1-888-325-3957
www.mieleprofessional.ca
professional@miele.ca

Miele Professional Technical Service

Phone: 1-888-325-3957
serviceprofessional@miele.ca



Manufacturer: Miele & Cie. KG
Carl-Miele-Straße 29, 33332 Gütersloh, Germany