



No Heater



Steam Indirect



Electric Heating



PW 6241 | 55 lbs.

Features

- Profitronic M: Freely programmable controls
- Short program cycles
- Patented Honeycomb Drum
- Electronic imbalance monitoring
- G-force of 541
- High durability: tested for 30,000 operating hours
- Safe disinfection
- Low consumption values

Exclusive to Miele



Patented Honeycomb Drum

The sculptured structure of the Miele Honeycomb Drum allows garments to glide gently on a thin film of water.

Exclusive to Miele



Patented Pre-Spin

The patented pre-spin removes excess water from cleaning cloths as soon as the program starts and reduces soiling.



Short Program Cycles

Premium commercial technology allows you to benefit from quick and efficient program cycles.



Safe Disinfection

Ensure reliable levels of hygiene, with special programs for thermal and chemo-thermal disinfection.*

**May not apply for No Heater version.*

Model	Heat Type	Electrical Specification Voltage/Hz/Phase (Amp)	Color	Material No.	Article No.
PW 6241	No Heater	240/60/1 (2 x 30 A)	Iron Grey	12092200	51624179NAM
PW 6241	No Heater	240/60/1 (2 x 30 A)	Stainless Steel	12092190	51624159NAM
PW 6241	Steam	240/60/1 (2 x 30 A)	Iron Grey	12092220	51624189NAM
PW 6241	Steam	240/60/1 (2 x 30 A)	Stainless Steel	12092210	51624149NAM
PW 6241	Steam	208, 240/60/3 (3 x 20 A)	Stainless Steel	12088640	51624187NAM
PW 6241	Electric	208, 240/60/3 (3 x 70 A)	Iron Grey	12092180	51624167NAM
PW 6241	Electric	208, 240/60/3 (3 x 70 A)	Stainless Steel	12088670	51624107NAM
PW 6241	Electric	440, 480/60/3 (3 x 35 A)	Stainless Steel	12092170	51624106NAM

Specifications

Capacity	55 lbs. (24.5 kg)
Cylinder Diameter	16 ¹⁵ / ₁₆ in. (800 mm)
Cylinder Depth	18 ⁷ / ₈ in. (479 mm)
Cylinder Volume	8.5 cu.ft. (240 l)
Machine Dimensions (WxDxH)	42 ⁷ / ₈ x 51 ⁹ / ₁₆ x 64 ¹³ / ₁₆ in. (1,089 x 1,309 x 1,646 mm)
Door Opening	16 ¹⁵ / ₁₆ in. (430 mm)
Floor to Door	25 ¹⁵ / ₁₆ in. (658 mm)
Reversible Door	No
Shipping Dimensions (WxDxH)	49 ¹¹ / ₁₆ x 51 ¹⁵ / ₁₆ x 67 ⁵ / ₁₆ in. (1,262 x 1,472 x 1,710 mm)
Net Weight	1,517 lbs. (688 kg)
Crated Weight	1,630 lbs. (739 kg)
Wash Speed	38 rpm
Extract Speed	1,100 rpm
G-force	541
Water Inlets	7-8 x 3/4 in. (178-203 x 19 mm)
Hot Water (No Heater version)	1 x 1 in. (26 x 26 mm)
Steam Inlets (Steam version)	2 x 1/2 in. (51 x 13 mm)
Drain Diameter	2 3/4 in. (70 mm)
Recommended Water Pressure	14.5 -145 psi
Water Flow	52.8 gal/min. (200 l /min.)
Min. Recommended Distance Between Machines	2 in. (50 mm)
Agency Approvals	Intertek

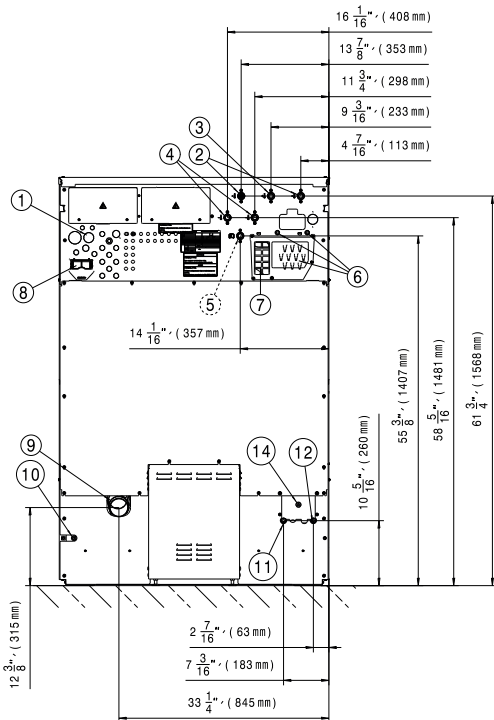
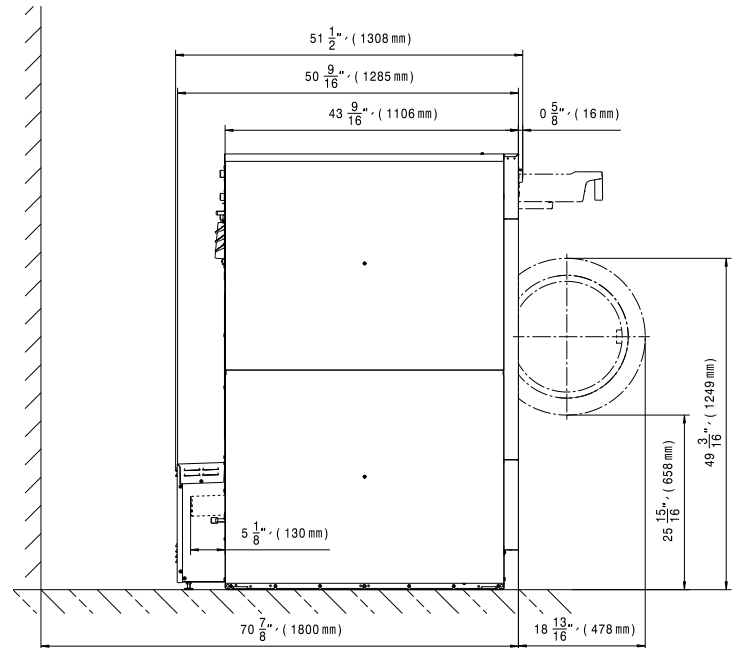
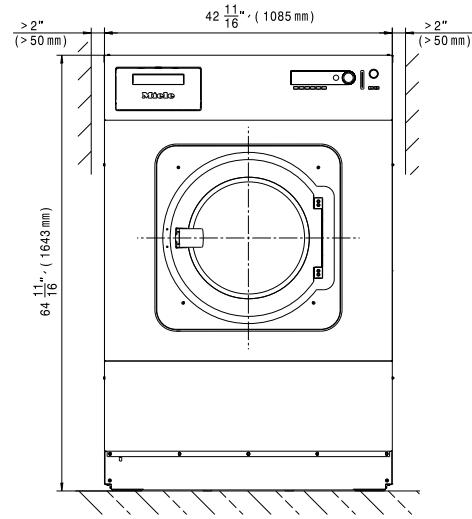

Heating	Voltage (Voltage/Hz/Phase)	Wire	Circuit Breaker Amps	Running Amps	Total Power (kW)
No Heater	240/60/1	2 Wire + Ground	30	27	4.4
Steam	240/60/1	2 Wire + Ground	30	27	4.4
Steam	208, 240/60/3	3 Wire + Ground	20	11	4.4
Electric	208, 240/60/3	3 Wire + Ground	70	63	26.2
Electric	440, 480/60/3	3 Wire + Ground	35	30.4	25.3

Specifications subject to change without notice or obligation.
Contact Miele USA at (800) 991-9380 or Miele Canada at (888) 325-3957 for dimensions not shown or for clarification.