





















Operating instructions Wine conditioning unit



It is **essential** to read these operating and installation instructions before installing and using the appliance. This prevents both personal injury and damage to the appliance.

Contents

Warning and Safety instructions ..	4	Commissioning	27
Sustainability and environmental protection	13	Before using for the first time.....	27
How to save energy	14	Connecting the wine conditioning unit.....	27
Familiarising yourself with the appliance.....	15	Activating the charcoal filter (Active AirClean filter) 	27
Guide to the appliance	15	Switching on the wine conditioning unit	27
Appliance overview	15	Switching off the wine conditioning unit	27
Display.....	17	Switching off for longer periods of time	27
Settings mode 	18	Requirements for networking	28
Feature lighting 	18	Setting up networking for the first time.....	28
Lock function  / 	18	Performing Scan & Connect.....	28
Switching off the wine conditioning unit (both wine conditioning zones) 	18	Operation.....	29
Sabbath mode 	18	Setting the temperatures in the wine conditioning zones.....	29
Information on Sabbath mode 	18	Temperature range	29
Time before door alarm  is triggered	18	Temperature display for the wine conditioning zones.....	29
Networking 	18	Setting the humidity (ActiveHumidity) in the lower wine conditioning zone 	29
Keypad tone  / 	18	Humidity range	30
Alarms and buzzers  / 	19	Adjusting settings.....	31
Display brightness 	19	Cleaning and care	36
Temperature unit °C/°F	19	Cleaning agents.....	36
Demo mode 	19	Preparing the wine conditioning unit for cleaning.....	36
Factory default settings 	19	Cleaning the interior of the appliance	37
Information on the wine conditioning unit 	19	Replacing an Active AirClean filter (charcoal filter).....	37
Active AirClean filter display 	19	Confirming that the Active AirClean filter has been changed	38
Networking.....	20	Cleaning the front of the appliance and the side panels.....	38
Safety	21	Cleaning the door seal.....	39
Temperature alarm.....	21	Cleaning the ventilation openings ...	39
Door alarm	22	After cleaning.....	39
Adjusting the interior fittings	22		
Removing and reinserting the wooden shelves	22		
Maximum capacity	23		
Loading the wooden shelves.....	23		
Labelling the labelling strips (NoteBoards).....	24		
Using the PresenterFrame.....	24		
Accessories supplied	25		
Optional accessories	26		

Automatic defrosting	39
Problem solving guide	40
Interior lighting.....	47
Noises	48
Service	50
Contact in case of fault.....	50
Warranty	50
Installation	51
Installation site	51
Ventilation requirements	52
Installing several wine conditioning units/refrigeration appliances.....	53
Changing the door hinging	53
Installing the wine unit	54
Aligning the wine conditioning unit.	54
Integrating the wine unit in a run of kitchen units	55
Appliance dimensions.....	57
Electrical connection	59

Warning and Safety instructions

This wine conditioning unit complies with all current local and national safety requirements. However, inappropriate use can lead to personal injury and damage to property.

Read the operating and installation instructions carefully before using the wine conditioning unit. They contain important information on installation, safety, use and maintenance. This is to protect yourself from injury, and from damaging your wine conditioning unit.

In accordance with standard IEC 60335-1, Miele expressly and strongly advises that you read and follow the instructions in “Installation”, as well as in the “Warning and safety instructions”.

Miele cannot be held liable for injury or damage caused by non-compliance with these instructions.

Keep these instructions in a safe place and pass them on to any future owner.

 Risk of injury from broken glass.

If installed at altitudes above 1500 m, there is a risk of the glass in the appliance door breaking because of changes in air pressure. Shards of glass can cause severe injury.

 Danger of injury and damage to the appliance due to the wine conditioning unit tipping over.

The wine conditioning unit is very heavy and can tip forwards when the appliance door is open.

Keep the appliance door shut until the wine conditioning unit has been built in and secured in its building-in niche in accordance with these operating and installation instructions.

Correct application

▶ This appliance is designed for domestic use and for use in similar environments by guests in hotel or motel rooms, bed & breakfasts and other typical living quarters. This does not include common/shared facilities or commercial facilities within hotels, motels or bed & breakfasts. This wine conditioning unit is not suitable for outdoor use.

▶ The wine conditioning unit is intended exclusively for domestic use for storing wine.

The wine conditioning unit is not suitable for freezing food.

Any other usage is not permitted.

▶ This wine conditioning unit is not suitable for storing and keeping cool medicines, blood plasma, laboratory preparations or similar substances or products. Incorrect use of the wine conditioning unit for such purposes may cause deterioration of the items stored. The wine conditioning unit is also not suitable for use in areas where there is a risk of explosion.

Miele cannot be held liable for damage resulting from incorrect or improper use or operation of the appliance.

▶ This appliance is not intended for use by persons (including children) with reduced physical, sensory or mental capabilities or lack of experience and knowledge, unless they have been given supervision and instruction concerning its use by a person responsible for their safety.

They may only use the appliance unsupervised if its operation has been clearly explained to them and they are able to use it safely and are able to understand and recognise the possible dangers caused by incorrect operation.

Safety with children

▶ Young children must not be allowed to use this appliance.

▶ Older children may only use the wine conditioning unit if its operation has been clearly explained to them and they are able to use it safely. They must be able to understand and recognise the possible dangers of misuse.

▶ Cleaning work may only be carried out by older children under the supervision of an adult.

Warning and Safety instructions

- ▶ Children should be supervised in the vicinity of the wine conditioning unit. Never allow children to play with the wine conditioning unit.
- ▶ The wine conditioning unit door hinges can cause injury. Keep children away at all times.
- ▶ Danger of suffocation. Whilst playing, children may become entangled in packaging material (such as plastic wrapping) or pull the packaging material over their head, presenting the risk of suffocation. Keep packaging material away from children.

Technical safety

- ▶ The refrigerant circuit has been checked for leaks. The wine conditioning unit complies with all current local and national safety requirements.



- ▶ Warning: fire hazard/flammable materials. This symbol is on the compressor and indicates flammable materials. Do not remove this sticker.

The refrigerant inside the appliance (details on the data plate) is environmentally friendly but flammable.

The use of this refrigerant does, however, sometimes lead to a slight increase in the noise level of the appliance. In addition to the noise of the compressor, you might be able to hear the refrigerant flowing around the system. Unfortunately, this cannot be avoided, but it does not affect the performance of the wine conditioning unit.

When transporting and installing the wine conditioning unit, ensure that no parts of the cooling circuit are damaged. Splashes of refrigerant can damage the eyes and leaking refrigerant can ignite.

In the event of any damage:

- Avoid naked flames or anything which creates a spark.
- Disconnect the wine conditioning unit from the mains electricity supply.
- Ventilate the room in which the wine conditioning unit is located for several minutes.
- Call Miele.

Warning and Safety instructions

▶ The more coolant there is in a wine conditioning unit, the larger the room should be in which it is installed. In the event of a leakage, if the appliance is in a small room, there is the danger of a combustible gas/air mixture building up. For every 8 g of coolant, at least 1 m³ of room space is required. The amount of coolant in the wine conditioning unit is stated on the data plate inside the appliance.

▶ Ensure that the connection data on the wine conditioning unit's data plate (fuse rating, frequency and voltage) match the electricity supply to prevent damage to the wine conditioning unit. Compare this before connecting the appliance to the mains electricity.

If in any doubt, consult a qualified electrician.

▶ The electrical safety of this wine conditioning unit can only be guaranteed when continuity is complete between it and an effective earthing system. It is most important that this basic safety requirement is present.

If in doubt, the electrical installation should be checked by a qualified electrician.

▶ Temporary or permanent operation with a self-sufficient or non-mains synchronous energy supply system (e.g. isolated networks, back-up systems) is possible. A requirement for the operation is that the energy supply system complies with all current local and national requirements that apply to stand-alone, solar and/or battery systems. The protective measures provided in the installation and in this Miele product must also be assured in their function and operation in isolated operation or in non-mains synchronous operation, or replaced with equivalent measures in the installation.

▶ The socket must be easily accessible so that the wine conditioning unit can be quickly disconnected from the electrical supply in case of an emergency.

▶ If the power supply cord is damaged, disconnect the wine conditioning unit from the mains power supply immediately. Call Customer Service.

▶ If the power supply cord is damaged, it must only be replaced with a specific power supply cord of the same type (available in the Miele online shop or from Miele Customer Service). For safety reasons, replacement may only be carried out by a suitably qualified specialist or Miele Customer Service.

Warning and Safety instructions

- ▶ Multi-socket adapters and extension leads do not guarantee the required safety of the appliance (e.g. danger of overheating). Do not use these to connect the wine conditioning unit to the mains electricity supply.
- ▶ If moisture gets into electrical components or into the mains connection cable, it could cause a short circuit. Therefore, do not operate this wine conditioning unit in areas which are exposed to moisture (e.g. in a garage or utility room).
- ▶ This wine conditioning unit must not be installed and operated in mobile installations (e.g. on a ship).
- ▶ Damage to the wine conditioning unit can compromise your safety. Before using the wine conditioning unit, check it for any visible damage. Never use a damaged wine conditioning unit.
- ▶ This wine conditioning unit is not intended for use as a built-in appliance.
- ▶ During installation, maintenance and repair work, the wine conditioning unit must be completely disconnected from the mains electricity supply. It is only completely isolated from the electricity supply when:
 - the mains circuit breaker is switched off, or
 - the screw-out fuse is removed (in countries where this is applicable), or
 - it is switched off at the wall socket and the plug is withdrawn from the socket, or it is switched off at the isolator. Pull on the plug and not the cable when disconnecting it from the power supply.
- ▶ Installation, repairs, and other work by unqualified persons could be extremely dangerous. The manufacturer cannot accept liability for unauthorised work.
Installation, maintenance and repairs must only be carried out by a qualified specialist or Miele Customer Service.
- ▶ The manufacturer's warranty will be invalidated if the wine unit is not repaired by a qualified specialist or Miele Customer Service.
- ▶ We recommend replacing faulty components with original Miele parts. If original Miele parts are installed correctly, Miele ensures full compliance with safety requirements and the warranty remains valid.

Warning and Safety instructions

▶ This wine unit is supplied with a special lamp to cope with particular conditions (e.g. temperature, moisture, chemical resistance, abrasion resistance and vibration). This lamp must only be used for the purpose for which it is intended. The lamp is not suitable for room lighting. Replacement lamps may only be installed by a qualified specialist or Miele Customer Service. This wine unit contains several light sources with at least energy efficiency class G.

Correct installation

▶ Change the door hinging (if necessary) as described in the installation instructions.

▶ Always wear protective gloves when transporting, changing the door hinging and setting up the wine unit.

▶ The wine unit is heavy and can tip forwards when the appliance door(s) is (are) open:

- At least 2 people are required to transport or move the wine unit.
- At least 2 people are required to change the door hinging of the wine unit.
- At least 2 people are required to install the wine unit.
- Never leave the wine unit unattended while it is being installed.

Correct use

▶ This wine conditioning unit is designed for use within specific ambient temperatures (climate range). Do not use it in ambient temperatures for which it is not designed. The climate range is stated on the data plate inside the wine conditioning unit. A lower ambient temperature will cause the compressor to switch off for longer periods, meaning that the wine conditioning unit is unable to maintain the required temperature in some circumstances.

▶ The ventilation cross-sections must not be covered or blocked in any way. This can impair the proper ventilation of the appliance, increase the energy consumption and cause damage to the components.

▶ Risk of damage due to greasy or oily foods. If the wine unit is used for storing food which contains fat or oil, make sure that it does not come into contact with plastic components. Any spillages of oil or fat could cause stress cracks to the plastic and cause it to break or split.

Warning and Safety instructions

- ▶ Risk of fire and explosion due to flammable mixtures of gases. Do not store explosive materials in the wine unit or any products containing propellants (e.g. spray cans). Electrical components can cause flammable mixtures of gases to ignite. The spray cans in question can be identified by the contents printed on the can or by a flame symbol. Electrical components can cause escaping gases to ignite.
- ▶ Danger of explosion! Do not operate any electrical appliances inside the wine conditioning unit. Danger of sparking and explosion.
- ▶ In areas which may be subject to infestation by cockroaches or other vermin, pay particular attention to keeping the appliance and its surroundings clean at all times. Any damage caused by cockroaches or other vermin will not be covered by the warranty.

Accessories and spare parts

- ▶ We recommend using original Miele accessories. Using spare parts or accessories from other manufacturers will invalidate the warranty and Miele cannot accept liability.
- ▶ Miele original spare parts are kept in stock for at least 10 years and up to 15 years after discontinuation of your wine unit.

Cleaning and care

- ▶ Do not use any oils or grease on the door seals, as these will cause the seals to deteriorate and become porous with time.
- ▶ The steam from a steam cleaning appliance could reach electrical components and cause a short circuit. Do not use a steam cleaning appliance to clean this appliance.
- ▶ Warning: Do not use any mechanical tools or other types of aid which are not recommended by the manufacturer to accelerate the defrosting process.
- ▶ Sharp edged objects will damage the evaporator, causing irreversible damage to the wine conditioning unit. Therefore, do not use sharp objects to:
 - remove layers of ice.
 - remove label residues, for example.

Transport

- ▶ Always transport the wine conditioning unit upright and in its packaging to avoid it being damaged.

Warning and Safety instructions

▶ Risk of injury and damage! The wine conditioning unit is very heavy and must be transported by two people.

Disposal of your old appliance

▶ Children playing could become trapped in the wine conditioning unit and could suffocate.

- Remove the appliance door.
- Leave the wooden/metal shelves in the wine conditioning unit so children cannot climb inside.
- If the wine conditioning unit has a door lock, make sure that children cannot lock themselves inside while playing as this could endanger their lives.

▶ Risk of electric shock!

- Cut the electrical plug off the power supply cord.
- Cut the power supply cord off the old appliance.

Dispose of the electrical plug and power supply cord separately from the old appliance.

▶ During and after disposal, make sure that the wine conditioning unit is not placed near petrol or other flammable gases and liquids.

▶ Risk of fire due to escaping oil or refrigerant.

The refrigerant and oil inside the appliance are flammable. In high enough concentrations, escaping refrigerant or oil can ignite if they come into contact with an external heat source.

During disposal, make sure that the cooling circuit is not damaged. This prevents refrigerant and oil escaping in an uncontrolled manner (see the data plate for details of the refrigerant).

▶ Splashes of coolant can damage the eyes. Be careful not to damage any part of the pipework whilst awaiting disposal, e.g. by

- puncturing the refrigerant channels in the condenser,
- bending any pipework, or
- scratching the surface coating.

Symbol on the compressor (depending on model)

This information is only relevant for recycling. There is no risk during normal operation.

Warning and Safety instructions



- ▶ The oil in the compressor can be fatal if swallowed or if it penetrates the airways.

Disposal of the packing material

The transport and protective packaging has been selected from materials which are environmentally friendly for disposal, and can normally be recycled.

Recycling the packaging reduces the use of raw materials in the manufacturing process and also reduces the amount of waste in landfill sites.

Ensure that any plastic wrappings, bags etc. are disposed of safely and kept out of the reach of babies and young children. Danger of suffocation.

Only for Australia: Note for installer: Expanded polystyrene (EPS) packaging included. Please retain and dispose of EPS packaging responsibly. For further information, please contact Miele.

Disposing of your old appliance

Electrical and electronic appliances contain many valuable materials. They also contain certain materials, compounds, and components which were essential for their correct functioning and safety. These could be hazardous to human health and to the environment if disposed of with general waste or if handled incorrectly. Please do not, therefore, dispose of your old appliance with your household waste.



Take care not to damage your refrigeration appliance before or during disposal in an authorised, environmentally friendly manner.

This is to ensure that refrigerant in the cooling circuit and oil in the compressor is contained, and will not leak into the environment.

Please dispose of it at your local community waste collection/recycling centre for electrical and electronic appliances, or contact Miele. You are also responsible for deleting any personal data that may be stored on the appliance prior to disposal. You should remove any old batteries which are not securely enclosed by the appliance and remove any lamps without destroying them, where this is possible. These must be taken to a suitable collection point where they can be handed in free of charge. Please ensure that your old appliance presents no danger to children while being stored awaiting disposal.

Sustainability and environmental protection

How to save energy ...

- Installation site** The wine conditioning unit has to cool more often at higher ambient temperatures and consumes more energy in the process. Therefore, you should:
- Install the wine conditioning unit in a well-ventilated room.
 - Do not install the wine conditioning unit near to a heat source (heater element, cooker).
 - Protect the wine conditioning unit from direct sunlight.
 - Ensure an ideal ambient temperature of 20 °C.
 - Clean the ventilation openings on a regular basis to remove any dust.
- Temperature setting** The colder the temperature, the higher the energy consumption. The following settings are recommended:
- +12 to +14 °C.
- Use** Energy consumption is increased by heat input and impeded air circulation. Therefore, you should:
- only open the appliance door when necessary and for as short a time as possible arrange the wine bottles in a way that makes them easy to find in the appliance
 - always close the appliance door properly after opening it
 - keep wooden shelves arranged as they were when the appliance was delivered
 - avoid overfilling the wooden shelves to allow air to circulate
 - keep the fan air ducts in the wine conditioning unit clear
 - Maintain a distance of 25 mm between the back of the appliance and the wall.

Familiarising yourself with the appliance

Guide to the appliance

Appliance overview

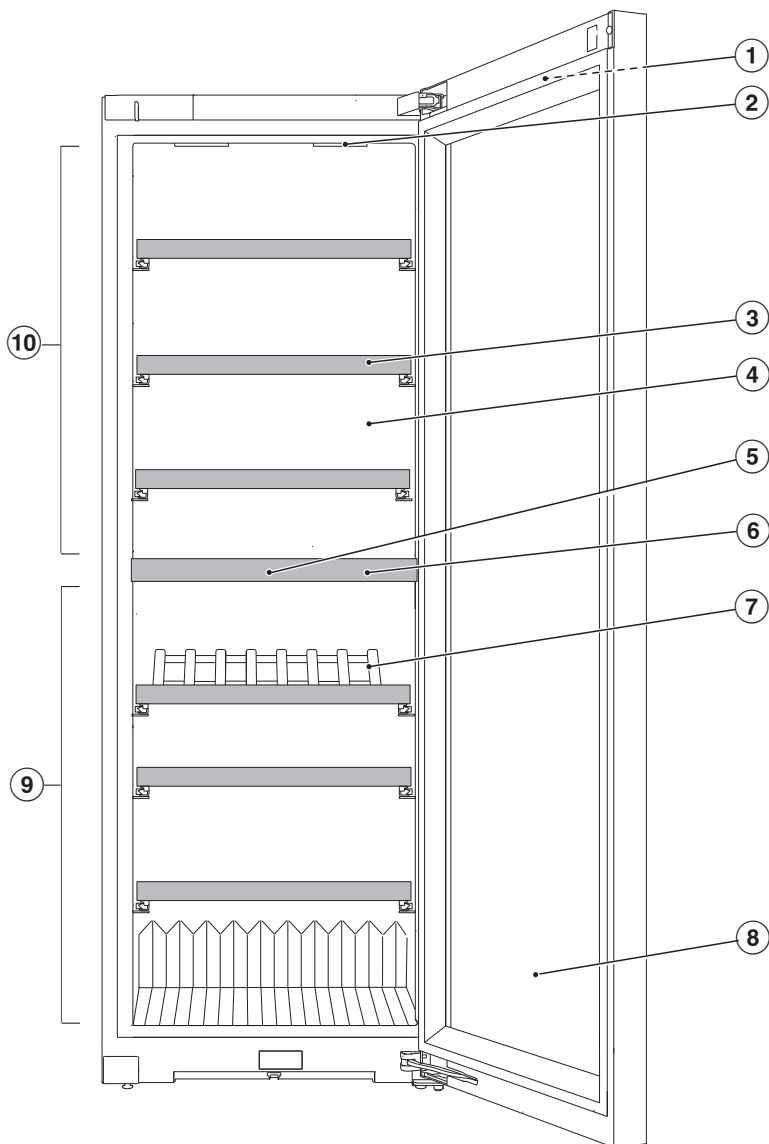

Familiarising yourself with the appliance



- ① Outer display on appliance door
- ② Interior lighting and feature lighting 
(in both wine conditioning zones): thanks to the use of LEDs, the wine will not be adversely affected by heat or UV light.
- ③ Wooden shelves with labelling strips (NoteBoards)
- ④ Dry rear wall for preventing the formation of condensation
- ⑤ Charcoal filter: the Active AirClean filter is located behind the NoteBoard.
- ⑥ Insulating plate between the wine conditioning zones: different types of wine can be stored at different temperatures at the same time.
- ⑦ PresenterFrame
- ⑧ Glass door: the safety glass door with UV filter protects your wine from harmful UV rays.
- ⑨ Lower wine conditioning zone with humidity setting (ActiveHumidity) for long-term storage
- ⑩ Upper wine conditioning zone

Familiarising yourself with the appliance

Display

The display can be scratched by pointed or sharp objects, e.g. pens.
Only touch the display with your fingertips.
It is possible that the display will not react to finger contact if your fingers are cold.





- ① Demo mode display
(only visible when the Demo mode function has been switched on)
- ② Temperature display for upper wine conditioning zone and sensor control for setting the temperature
- ③ Feature lighting sensor control 
For switching the interior lighting on and off when the appliance door is closed
- ④ Temperature display for lower wine conditioning zone and sensor control for setting the temperature and humidity (ActiveHumidity)
- ⑤ Settings mode sensor 
For adjusting various functions in Settings mode
- ⑥ Display for connection status
(only visible if networking has been set up)

Familiarising yourself with the appliance

Settings mode

Feature lighting

The interior lighting can be set to remain on when the appliance door is closed so your wines can be on display at all times.

The feature lighting is switched on and off using the  sensor control in the display. When the feature lighting is switched on, the  sensor control lights up orange.

The feature lighting can be switched on or off separately for each individual wine conditioning zone (see “Adjusting settings”).

Lock function /

When the lock function is switched on, it protects the wine conditioning unit from being switched off unintentionally and being adjusted unintentionally by unauthorised persons, e.g. children.

If you just want to adjust the temperature quickly, for example, you can deactivate the lock function temporarily (see “Adjusting settings”).

Switching off the wine conditioning unit (both wine conditioning zones)

See “Commissioning – Switching off the wine conditioning unit”.

Sabbath mode

The wine conditioning unit offers a Sabbath mode for the purposes of religious observance (see “Adjusting settings”).

When Sabbath mode is switched on, the following are deactivated temporarily:

- the interior lighting when the appliance door is opened
- feature lighting when the appliance door is closed
- the display
- all audible and visual signals
- an active Wi-Fi connection
- reminders (e.g. Active AirClean filter display): the set time interval is paused

All other functions switched on previously remain activated.

When Sabbath mode is switched on, you cannot adjust any settings on your wine conditioning unit.

Information on Sabbath mode

You can call up the Sabbath mode version here.

Time before door alarm is triggered

You can set the time before the appliance door alarm is triggered here.

Networking

Here you can set up networking for the first time, deactivate and activate the Wi-Fi or reset the network configuration (see “Adjusting settings”).

Keypad tone /

You can switch the keypad tone on or off here (see “Adjusting settings”).

Familiarising yourself with the appliance

Alarms and buzzers /

You can change the volume of the alarms and buzzers (e.g. in the event of a door alarm or a fault message) here. Alternatively, you can switch the alarms and buzzers off completely if you find them annoying (see “Adjusting settings”).

Display brightness

You can adjust the display brightness to the lighting conditions in the room here (see “Adjusting settings”).

Temperature unit °C/°F

You can set the required temperature unit (°Celsius or °Fahrenheit) here (see “Adjusting settings”).

Demo mode

You can switch off demo mode here if it has been switched on as a default setting ( will appear in the display) (see “Adjusting settings”).

Demo mode allows the wine conditioning unit to be presented in the showroom without the cooling system being switched on. Do not activate this setting for domestic use.

Factory default settings

You can reset the wine conditioning unit's settings to their factory default settings here (see “Adjusting settings”).

Useful tip: Reset the settings to the factory default settings when disposing of your wine conditioning unit, selling it or putting a used wine conditioning unit into operation. This will reset the network configuration so that your personal data is deleted from the wine conditioning unit. This will also ensure that a previous owner is no longer able to access the wine conditioning unit.

Information on the wine conditioning unit

You can call up the model identifier and serial number of your wine conditioning unit here.

Keep this appliance data to hand:

- for integrating the wine conditioning unit into your Wi-Fi network (see “Adjusting settings – Setting up Miele@home for the first time”)
- when reporting an appliance fault to Miele Customer Service (see “Service”)

Active AirClean filter display

Filtering the air through the Active AirClean filter ensures that the air remains free from dust and odours.

The Active AirClean filter display  will remind you approx. every 12 months that the Active AirClean filter has to be replaced (see “Cleaning and care – Replacing the Active AirClean filter (active charcoal filter)”).

You can activate the Active AirClean filter display  here (see “Adjusting settings”).

Familiarising yourself with the appliance

Networking

Your wine unit is equipped with an integrated Wi-Fi module. The Wi-Fi module makes it possible to connect to your home network and to use the Miele App on a mobile device.

Once your wine unit has been connected via Wi-Fi, the connection is automatically re-established every time it is switched on.

Make sure that your Wi-Fi network signal is strong enough in the place where you intend to install your wine unit.

Connecting your wine unit to your Wi-Fi network will increase energy consumption, even when the wine unit is switched off.

*This is a separate digital offer from Miele & Cie. KG. The range of functions can vary depending on the model and the country. Acceptance of the General Terms and Conditions and Privacy Policy for Miele digital products and services in the Miele App is required. Miele reserves the right to change or discontinue the digital offers at any time.

Smart Extras via the Miele App*

Networking via the Miele App gives you access to numerous Smart Extras, including:

- Accessing status information.
- Using additional helpful functions.
- Keep your wine unit up to date with the latest Miele developments via software updates.



You can find more detailed information about Smart Extras on the Miele website, in the Apple App Store® or in the Google Play Store™.

Familiarising yourself with the appliance

Safety

Temperature alarm

The wine conditioning unit is equipped with a temperature alarm so that the temperature cannot rise or fall unnoticed and therefore damage the wine.

If the temperature becomes too warm or too cold,   will light up red in the corresponding temperature display. An alarm will also sound until the cause of the alarm is rectified or the alarm is switched off.

The set temperature determines when the appliance recognises a temperature as being too warm or too cold.

The audible and visual signals may be activated in the following situations:



- Too much warm ambient air enters the wine conditioning unit when you are rearranging or taking out wine bottles.
- You are storing a large number of wine bottles.
- There was a power outage.
- There is a fault with the wine conditioning unit.

Switching the temperature alarm off early

Before you switch the temperature alarm off, you must determine the cause and rectify it.

You can switch the alarm off early if you wish.

■ Tap  .

  goes out and the alarm will stop.



The warmest temperature recorded in the wine conditioning zone concerned will flash for about 1 minute in the temperature display for the wine conditioning zone. Then the temperature display will change to the current temperature in the wine conditioning zone.

Familiarising yourself with the appliance

Door alarm

The wine conditioning unit is fitted with a door alarm to avoid increased energy consumption if the door is left open and prevent the stored wine bottles being affected by temperature fluctuations.

If the appliance door is left open for a longer period of time,  will light up yellow in the display. An alarm will also sound and the interior lighting will flash.

The amount of time until the door alarm is triggered can be changed (see “Adjusting settings – Changing the time before the door alarm  is triggered”). The door alarm’s audible signal can also be switched off (see “Adjusting settings – Changing the volume of the alarms and buzzers ”).

The alarm will stop and  will go out in the display as soon as the appliance door is closed.

Switching the door alarm off early

- Tap the  symbol.

The alarm will stop, the  symbol will go out and the interior lighting will light up again constantly.

If the appliance door is not closed, the door alarm will sound again after around 1 minute.

Adjusting the interior fittings

Removing and reinserting the wooden shelves

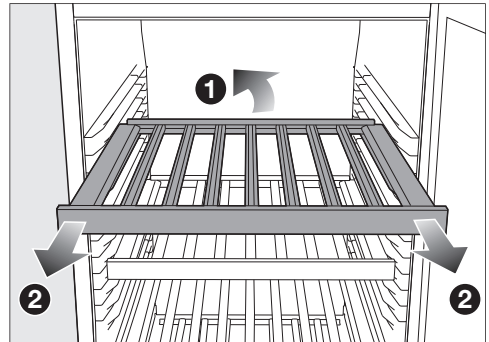

- Lift the wooden shelf slightly at the back **1** and pull it out towards the front **2**.

Stoppers prevent the wooden shelves from being dislodged by mistake.

- Reinsert the wooden shelf at the required position.

 Risk of injury from falling wine bottles.

Wine bottles may become wedged in the wooden shelves above and fall out of the wine conditioning unit/refrigeration appliance when the shelves are pulled out.

Always pull out the wooden shelves slowly and carefully.

 Risk of damage and injury from broken glass.

If wooden shelves and bottles protrude too far forwards, they may damage the glass door when it is closed.

Please ensure that the wooden shelves and wine bottles do not protrude.

Familiarising yourself with the appliance

Maximum capacity

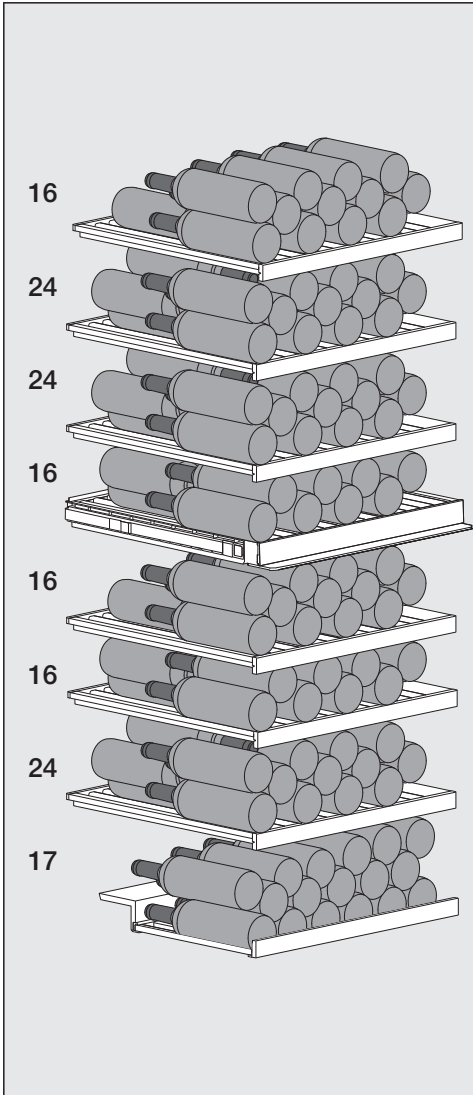

Up to 153 Bordeaux bottles (0.75 l) can be stored in the wine conditioning unit:

- 80 bottles in the upper wine conditioning zone and
- 73 bottles in the lower wine conditioning zone.

Loading the wooden shelves

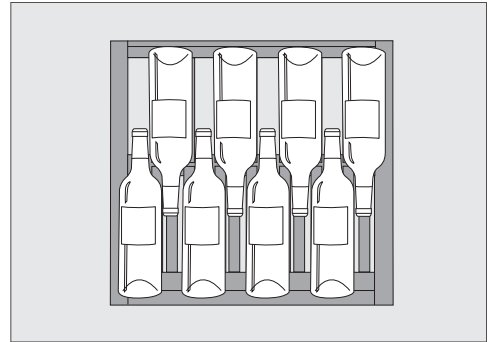

Arrangement of the lower row of bottles on the wooden shelves or PresenterFrame

 Risk of damage due to overloading.

Exceeding the maximum recommended capacity can lead to damage to the wooden shelves.

Do not exceed the maximum load-bearing capacity of 40 kg for each wooden shelf.

The PresenterFrame can also bear a load of 40 kg.

Familiarising yourself with the appliance

Labelling the labelling strips (NoteBoards)

For quick and easy identification of the wines stored, you can write on the NoteBoards on the wooden shelves.

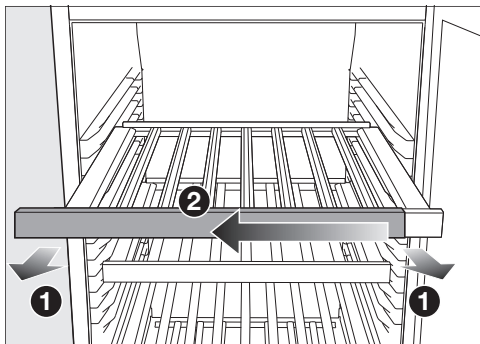

- Pull the wooden shelf out a little towards the front ①.
- Pull the NoteBoard to one side away from the wooden shelf ②.
- The labelling strip can be wiped clean with a damp cloth.

⚠ Risk of damage from unsuitable cleaning agents.

Cleaning the labelling strips (NoteBoards) with a cleaning agent may damage the coating on them. Use clean water only to wipe the NoteBoards.

- Label the NoteBoard with the chalk pen supplied. Alternatively, we recommend the following products for labelling:
 - liquid chalk pens, such as an edding 4095 chalk marker
 - traditional blackboard chalk

⚠ Risk of damage due to writing with the wrong products.

Never write on the NoteBoard with a ballpoint pen, crayon or pencil, correction pencil, wax crayon, oil chalk or felt-tip pen (e.g. permanent marker, highlighter, foil pen, etc.). These products are difficult or impossible to remove from the NoteBoard.

Only use the products recommended to write on the NoteBoard as these can be removed easily.

- Slide the NoteBoard back onto the wooden shelf from the side.

Using the PresenterFrame

The PresenterFrame can be used to present selected wines so that the labels on the bottles are visible even with the appliance door closed.

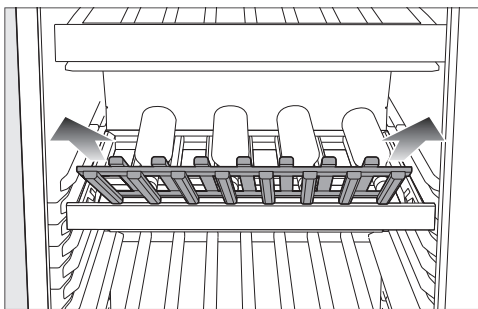

- Pull the PresenterFrame upwards and out.

Familiarising yourself with the appliance

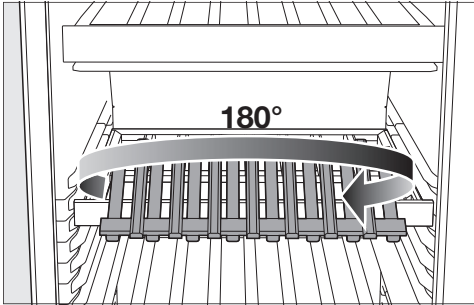

- Rotate the PresenterFrame 180° about its own axis.

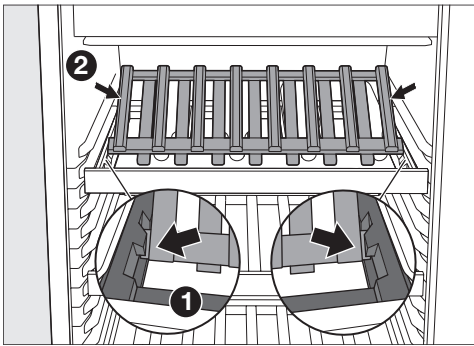

- Insert the PresenterFrame so that it engages into the holders on the left and right of the wooden shelf ①.

Useful tip: The PresenterFrame has been inserted correctly if there are wooden slats at each end ②.

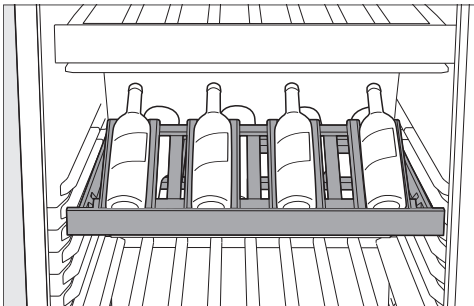

- Place the wine bottles on the PresenterFrame.

In particular, wine bottles that have already been opened can be perfectly stored on the PresenterFrame.

- If required, switch on the feature lighting (see “Familiarising yourself with the appliance – Settings mode ⚙”) to highlight the selected wine bottles.

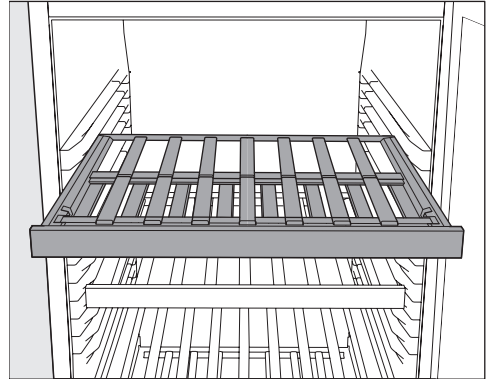

- If you do not need the PresenterFrame, rotate the PresenterFrame 180° about its own axis and replace it onto the frame of the wooden shelf.

Accessories supplied

Active AirClean filters

The Active AirClean filter between the wine conditioning zones ensures optimum air quality by filtering the incoming air.

Chalk pen

Use the chalk pen supplied to label the NoteBoards on the wooden shelves. By labelling the NoteBoards you will have a good overview of the types of wine being stored.

Familiarising yourself with the appliance

Optional accessories

Products specially tailored to your wine conditioning unit – such as appliance care products and accessories – are available from the Miele online shop and Miele Customer Service.

You can access the Miele online shop via the following QR code:



Before using for the first time



- Remove all packaging material and protective film.
- Clean the inside of the appliance and the accessories (see “Cleaning and care”).

Connecting the wine conditioning unit

- Connect the wine conditioning unit to the electricity supply as described in “Installation – Electrical connection”.

Miele will then appear in the appliance display, followed by .

Activating the charcoal filter (Active AirClean filter)

- Activate the Active AirClean filter display  (see “Adjusting settings – Activating the Active AirClean filter display ”).

Switching on the wine conditioning unit



- Tap  on the display.

If you do not interact with the display for a certain period of time, it switches to energy-saving mode and goes dark.

The wine conditioning unit will start to cool and the interior lighting will come on when the appliance door is opened.

Depending on the ambient temperature and the temperature setting, it can take the appliance a few hours to reach the temperature required in the corresponding wine conditioning zones and for this temperature to then be shown as a constant temperature in the display.

Switching off the wine conditioning unit

- Tap .
- Swipe left or right until  is shown in the middle.
- Tap .

The cooling and interior lighting are switched off.

 will appear in the display.

Please note: the wine conditioning unit is not disconnected from the power supply when it is switched off.

Switching off for longer periods of time

If, during a long absence, the wine conditioning unit is switched off but not cleaned and the door is left shut, there is a danger of mould building up inside the appliance.
The wine conditioning unit must be cleaned.

If the wine conditioning unit is not going to be used for a longer period of time, observe the following:

- Switch the wine conditioning unit off.
- Switch off at the wall and withdraw the plug from the socket, or switch off the mains circuit breaker.
- Clean the wine conditioning unit and leave the door ajar to air the wine conditioning unit and avoid odours building up inside it.

Commissioning

Requirements for networking

Note the following requirements for networking:

1. A home network is available at the installation site.
Have the Wi-Fi password ready.
2. The Miele App is available on a mobile device.
3. You have a user account in the Miele App.

Miele App

You can download the Miele App from the Apple App Store® or the Google Play Store™ free of charge (only functional in selected countries).



Setting up networking for the first time

- Tap the ⚙️ symbol.
- Swipe left or right until the @ symbol is shown in the middle.
- Tap the @ symbol.
- Tap on the connection method you wish to use (App or WPS).

After you have successfully logged in, the 🏠 symbol will appear in the display.

If a connection could not be established, the ⊗ symbol will appear.

- In this case, start the process again.
- To leave the Settings level, tap the ↩️ symbol.

Performing Scan & Connect

- Scan the QR code.

If you have installed the Miele App and have a user account, you will be taken directly to the networking steps.

If you have not yet installed the Miele App, you will be taken to the Apple App Store® or the Google Play Store™.

- Install the Miele App and set up a user account.
- Scan the QR code again.



The Miele App will guide you through the set-up process.



Setting the temperatures in the wine conditioning zones

The temperatures in the 2 wine conditioning zones can be set independently of one another.

A temperature of between 12 and 14 °C is recommended to store wine over the long term.

- Tap the temperature display for the wine conditioning zone you want to change.
- **Lower wine conditioning zone:** tap .
- Swipe left or right until the temperature you want is shown in the middle.
- Tap the temperature you want to confirm.
- To leave this Settings level, tap .

The temperature display will then change back to the current temperature in the wine conditioning zone.

The temperature in the wine conditioning unit will rise:

- the more often the appliance door is opened and the longer it is kept open.
- the more wine bottles there are being stored.
- the warmer the newly stored wine bottles are.
- the higher the ambient temperature surrounding the wine conditioning unit. This wine conditioning unit is designed for use within specific ambient temperatures (climate range). Do not use it in ambient temperatures for which it is not designed.

Temperature range

In all wine conditioning zones, it is possible to set temperatures between 5 and 20 °C.





Temperature display for the wine conditioning zones

In normal operating mode, the temperature display shows the **current average temperature** inside the corresponding wine conditioning zone.

Depending on the ambient temperature and the temperature setting, it can take the appliance a few hours to reach the temperature required and for this temperature to then be shown as a constant temperature in the display.

Setting the humidity (ActiveHumidity) in the lower wine conditioning zone

An ambient temperature of between 19 and 28 °C is required to ensure that the humidity level is set correctly.

- Tap the temperature display for the lower wine conditioning zone.
- Swipe left until  is shown in the middle.
- Tap .
- Swipe left or right until the humidity ( or ) you want is shown in the middle.
- Tap the setting you want to confirm.
- To leave this Settings level, tap .

Depending on the ambient temperature and the set humidity level, it can take the appliance a few days to reach the set humidity level.

Operation

















Humidity range

You can set the humidity to 2 levels and therefore adapt it to your individual needs.

- Δ: Low humidity
- ΔΔΔ: High humidity

If you would like to use the lower wine conditioning zone for the long-term storage of wine bottles with natural corks, we recommend setting a high humidity level ΔΔΔ.

Please bear in mind that energy consumption will increase slightly as the set humidity level is increased.





 Settings mode	
	Set the brightness of the feature lighting.
	Switch the locking function on, deactivate it temporarily or switch it off completely.
	Switch Sabbath mode on or off.
	Call up the Sabbath mode version.
	Change the time before the door alarm is triggered.
	Networking
APP / WPS	Set up networking for the first time.
	Activate or deactivate the Wi-Fi connection.
	Reset the network configuration.
	Switch the keypad tone on or off.
	Change the volume of the alarms and buzzers or switch off the alarms and buzzers completely.
	Adjust the display brightness.
	Change the temperature unit.
	Switch the demo mode off (only visible when switched on).
	Reset the settings to their factory default settings.
	Access information about your refrigeration appliance.
	Activate the Active AirClean filter display.

Adjusting settings



The door alarm and other warnings are automatically disabled when the appliance is in Settings mode .

Setting the brightness of the feature lighting



The feature lighting can be set separately at different brightness levels for each individual wine conditioning zone or switched off completely.

- Tap .
- Swipe left or right until  is shown in the middle.
- Tap .
- Swipe left or right until the wine conditioning zone you want is shown in the middle.
- Tap the wine conditioning zone you want.
- Select the brightness you want by swiping the segment bar to the left or right (level 1–7).
- If you want to switch the feature lighting off completely, swipe to the left until the segment bar goes out completely.
- Confirm the setting you want by tapping the segment bar.
- Alternatively: confirm the setting you want by tapping .
- To leave this Settings level, tap .

Switching the lock function / on

- Tap .
- Swipe left or right until  is shown in the middle.
- Tap .

When the lock function is switched on,  will light up orange.

- To leave this Settings level, tap .
- Open and close the appliance door. Only then will the lock function  be active.

Deactivating the lock function / temporarily





- Touch the temperature display for the wine conditioning zone you want to change.
- Touch  for approx. 6 seconds.

The display switches to the temperature controls.

- Now select the required settings.

Opening and closing the appliance door will reactivate the lock function .

Switching the lock function / off completely



- Tap the  symbol.
- Touch the  symbol for approx. 6 seconds.
- Swipe left or right until the  symbol is shown in the middle.
- Tap the .



When the lock function is switched off, the  symbol will light up white.

- To leave the Settings level, tap the  symbol.

Switching Sabbath mode on

When Sabbath mode  is switched on, you cannot adjust any settings.

- Tap the .
- Swipe left or right until the  symbol is shown in the middle.

- Tap the  symbol.
- The  symbol will light up orange.
- To leave the Settings level, tap the  symbol.

If Sabbath mode  is switched on, this is indicated in the display for approx. 3 seconds.







The display then switches off.

Ensure that the appliance door is properly closed, as visual and audible alarms are switched off.



Switching Sabbath mode off

The Sabbath mode function  will switch off automatically after approx. 80 hours.

However, you can switch the Sabbath mode function  off early.



- Tap the blank display.
- The  symbol will appear.
- Tap the  symbol.
- The  symbol will light up orange.
- Tap the  symbol again.
- When Sabbath mode is switched off, the  symbol will light up white.
- To leave the Settings level, tap .

Changing the time before the door alarm is triggered

- Tap the  symbol.
- Swipe left or right until the  symbol is shown in the middle.
- Tap the  symbol.
- Swipe left or right until the time you want between 30 seconds and 3 minutes 30 seconds is shown in the middle.

- Tap the setting you want to confirm.
- To leave the Settings level, tap the  symbol.

Setting up networking for the first time





- Tap the  symbol.
- Swipe left or right until the  symbol is shown in the middle.
- Tap the  symbol.
- Tap on the connection method you wish to use (App or WPS).

After you have successfully logged in, the  symbol will appear in the display.

If a connection could not be established, the  symbol will appear.

- In this case, start the process again.
- To leave the Settings level, tap the  symbol.



Deactivating the Wi-Fi connection

- Tap the  symbol.
- Swipe left or right until the  symbol is shown in the middle.
- Tap the  symbol.
- Tap the  symbol to deactivate the Wi-Fi connection.

The  symbol appears.

- To leave the Settings level, tap the  symbol.

Activating the Wi-Fi connection

- Tap the  symbol.
- Swipe left or right until the  symbol is shown in the middle.
- Tap the  symbol.

Adjusting settings







- Tap the  symbol to activate the Wi-Fi connection.

The  symbol appears.

- To leave the Settings level, tap the  symbol.

When the Wi-Fi connection is active, the  symbol will light up in the display.

Resetting the network configuration



- Tap .
- Swipe left or right until  is shown in the middle.
- Tap .
- Swipe right until  is shown in the middle.
- Tap .
- Tap .
- To leave this Settings level, tap .

All entered settings and values for Miele@home are reset to the default settings.

The Wi-Fi connection has been deactivated.  will go out in the display.

The network configuration should be reset whenever a wine conditioning unit is being disposed of or sold, or if a used wine conditioning unit is being put into operation. All personal data is removed from the wine conditioning unit. This will also ensure that a previous owner is no longer able to access the wine conditioning unit.

Switching on the keypad tone



- Tap the  symbol.
- Swipe left or right until the  symbol is shown in the middle.

- Tap the  symbol.

If the keypad tone is switched on, the  symbol will light up orange.

- To leave the Settings level, tap the  symbol.



Switching off the keypad tone

- Tap the .
- Swipe left or right until the  symbol is shown in the middle.
- Tap the .

If the keypad tone is switched off, the  symbol will light up white.

- To leave the Settings level, tap the .

Changing the volume of the alarms and buzzers





- Tap the .
- Swipe left or right until the  symbol is shown in the middle.
- Tap the .
- Select the volume you want by swiping the segment bar to the left or right (level 1–7).
- If you want to switch the alarms and buzzers off completely, swipe to the left until the segment bar goes out completely.
- Confirm the setting you want by tapping the segment bar.

When the alarms and buzzers are switched off, the  symbol will light up white.



When the alarms and buzzers are switched on, the  symbol will light up orange.

- To leave the Settings level, tap the .





Changing the display brightness

- Tap the  symbol.
- Swipe left or right until the  symbol is shown in the middle.
- Tap the  symbol.
- Select the brightness you want by swiping the segment bar to the left or right (level 1–7).
- Confirm the setting you want by tapping the segment bar.
- To leave the Settings level, tap the  symbol.

Changing the temperature unit °C/°F



- Tap the  symbol.
 - Swipe left or right until °C or °F is shown in the middle.
 - Tap °C or °F to change the temperature unit.
- °C or °F will appear in the display.
- To leave the Settings level, tap the  symbol.

Switching off Demo mode

- Tap .
- Tap .
- Swipe left or right until  is shown in the middle.
- Tap .

After demo mode  has been switched off, the wine conditioning unit shuts down and must be switched on again.

Resetting the settings to their factory default settings

- Tap .
- Swipe left or right until  is shown in the middle.



- Tap .

 will appear in the display.

- Tap .

The wine conditioning unit shuts down and must be switched on again.

Activating the Active AirClean filter display

- Tap .
- Swipe left or right until  is shown in the middle.
- Tap .

If the Active AirClean filter display is activated,  will light up orange.

- To leave this Settings level, tap .

Cleaning and care

The data plate located inside the wine conditioning unit must not be removed. It contains information which is required in the event of a fault.

Do not let water get into the electronic unit or the lighting.

 Risk of damage due to moisture ingress.

The steam from a steam cleaning appliance can damage plastic parts and electrical components. Do not use a steam cleaner to clean the wine conditioning unit.

 Health risk due to soiling entering the appliance.

Soiling that enters the appliance from outside (such as food or drink residues) can cause fungus to form in the wine conditioning unit at increased temperature and humidity levels.

Only place clean wine bottles and clean accessories in the wine conditioning unit.

Cleaning agents

Cleaning and care products used inside the wine conditioning unit must be food safe.

To avoid damaging the surfaces of your appliance, **do not use:**

- cleaning agents containing soda, ammonia, acid or chloride
- cleaning agents containing descaling agents
- abrasive cleaning agents, e.g. powder cleaners and cream cleaners

- solvent-based cleaning agents
- stainless steel cleaners
- dishwasher cleaners
- oven sprays
- cleaning agents for ceramic glass cooktops (except to clean the glass front)
- glass-cleaning agents (except to clean the glass front: for this a glass-cleaning agent containing a little alcohol, but no citric or similar additives, may be used)
- hard, abrasive sponges and brushes, e.g. pot scourers
- dirt eraser sponges
- sharp metal scrapers

We recommend using lukewarm water with a little washing-up liquid to clean the appliance.

Preparing the wine conditioning unit for cleaning

- Switch the wine conditioning unit off.  appears in the display and the cooling system is switched off.
- Take any wine bottles out of the wine conditioning unit and store them in a cool place.
- If necessary, take out all removable parts for cleaning (see “Familiarising yourself with the appliance – Adjusting the interior fittings”).
- Remove the labelling strips (NoteBoards) from the wooden shelves before cleaning them.

Cleaning the interior of the appliance

Clean the wine conditioning unit regularly, or at least once a month.

If soiling is left on for any length of time, it may become impossible to remove under certain circumstances. Surfaces may suffer discolouration or damage. Remove any soiling immediately.

- Clean the interior with a clean sponge, lukewarm water and a little washing-up liquid.
- Rinse all parts by hand. Do not wash in a dishwasher.
- The **wooden** shelves should only be wiped with a well wrung-out moist cloth. They must **not** be allowed to get wet.

 Risk of damage from unsuitable cleaning agents. Cleaning the labelling strips (NoteBoards) with a cleaning agent may damage the coating on them. Use clean water only to wipe the NoteBoards.

- After cleaning, wipe with a damp cloth and dry with a soft cloth.
- Leave the door open to air the wine conditioning unit sufficiently for a short while and to prevent odour build-up.

Replacing an Active AirClean filter (charcoal filter)

New Active AirClean filters are available from Miele Customer Service, from a specialist dealer or on the Miele website.

The Active AirClean filter is located behind the NoteBoard (labelling strips) between the wine conditioning zones.

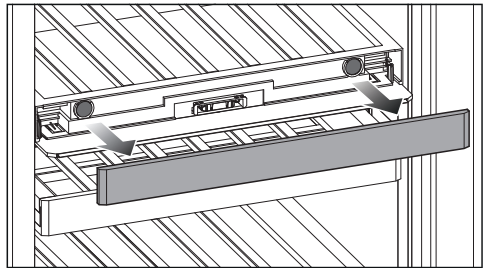

- Pull the NoteBoard off.

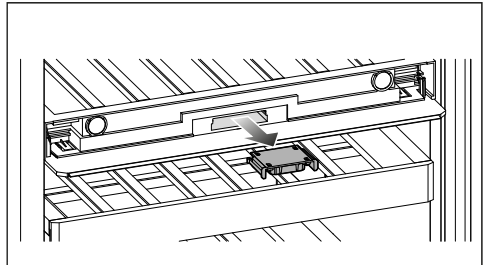

- Pull the filter holder out.

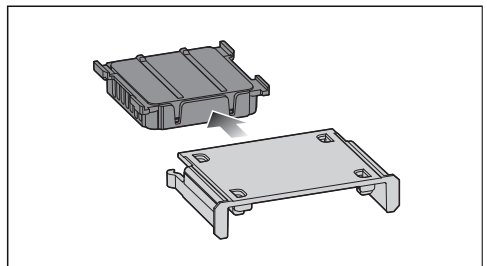

- Remove the used Active AirClean filter.

Cleaning and care

- Used Active AirClean filters can be disposed of with normal household waste.

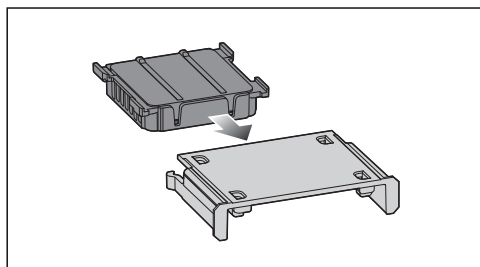

- Insert the new Active AirClean filter into the filter holder.

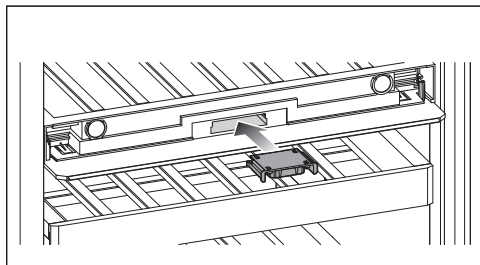

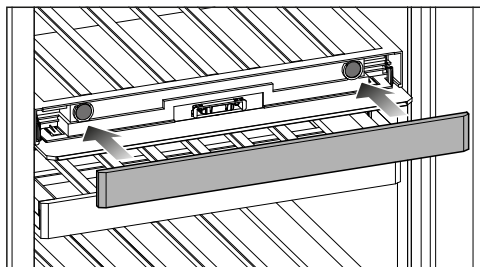

- Reinsert the filter holder with the new Active AirClean filter.



- Fit the NoteBoard in position.

Confirming that the Active AirClean filter has been changed

- Touch the  symbol in the display.
-  will go out in the display and the counter will be reset.

Cleaning the front of the appliance and the side panels

If soiling is left on for any length of time, it may become impossible to remove. Surfaces may suffer discolouration or damage.

Therefore it is best to remove soiling from the appliance doors and side panels immediately.

All surfaces are susceptible to scratching. Contact with unsuitable cleaning agents can alter or discolour the surfaces.

See the information on “Cleaning agents” at the beginning of this section.

- Clean the surfaces with a clean sponge and a solution of warm water and washing-up liquid. A clean, damp microfibre cloth without cleaning agent can also be used.
- After cleaning, wipe with clean water and dry with a soft cloth.
- Clean the appliance door with a proprietary glass cleaner.

Cleaning the door seal

 Risk of damage due to incorrect cleaning.

If you treat the door seal with oils or grease, it can become porous.

Do not use any oils or grease on the door seals.

- The door seal should be cleaned regularly with clean water, and then wiped dry with a soft cloth.

Cleaning the ventilation openings

- The ventilation openings should be cleaned on a regular basis with a feather duster or vacuum cleaner (you could use a Miele vacuum cleaner dusting brush, for example).

After cleaning

- Refit all shelves and accessories in the wine conditioning unit.
- Switch the wine conditioning unit on.
- Place the wine bottles in the wine conditioning unit and close the appliance door.

Automatic defrosting

The wine conditioning unit defrosts automatically.

Problem solving guide

Many malfunctions and faults can be easily remedied. You can save time and money in many cases, as you do not need to contact Customer Service.

More information to help you remedy faults yourself can be found at www.miele.com.au/support/customer-assistance or www.miele.co.nz/support/customer-assistance.



To prevent cold from escaping, open the appliance as little as possible until the fault has been corrected.

General problems with the wine conditioning unit

Problem	Possible cause and remedy
The wine conditioning unit is not cooling.	The wine conditioning unit is not switched on. ■ Switch the wine conditioning unit on.
	The mains plug is not inserted in the socket correctly or not switched on, or the plug connector is not inserted into the socket at the back of the appliance correctly. ■ Insert the mains plug into the mains socket and the plug connector into the appliance socket and switch on.
	The mains circuit breaker has tripped. There could be a fault with the wine conditioning unit, the household electrical wiring or another electrical appliance. ■ Contact a qualified electrician or Customer Service.
The compressor is switching on more frequently and for longer periods of time. The temperature in the wine unit is too low.	The temperature in the wine unit is set too low. ■ Correct the temperature setting.
	The appliance door has been opened too frequently. Or large amounts of wine have been placed in the appliance. ■ Only open the appliance door when necessary and for as short a time as possible.
	The appliance door does not close fully. The temperature in the wine unit drops. ■ Check that the appliance doors are seated correctly and use the screws in the hinges to adjust them if necessary.
	The appliance door is not properly closed.





Problem solving guide

Problem	Possible cause and remedy
	<ul style="list-style-type: none"> ■ Always close the appliance door fully. <p>The ambient temperature is too high. The higher the ambient temperature, the longer the compressor runs.</p> <ul style="list-style-type: none"> ■ See the information in “Installation – Installation site”. <p>The ventilation openings are covered or have become too dusty.</p> <ul style="list-style-type: none"> ■ Do not block the ventilation openings. ■ Clean the dust from the ventilation openings on a regular basis. <p>For built-in appliances: the wine unit has not been installed properly in the building-in niche.</p> <ul style="list-style-type: none"> ■ Install the wine unit in the niche as described in the installation instructions.
<p>The temperature in the wine unit is too low.</p>	<p>The temperature in the wine unit is set too low.</p> <ul style="list-style-type: none"> ■ Correct the temperature setting.
<p>The temperature in the wine unit is too high.</p>	<p>This is not a fault. The temperature setting is too high.</p> <ul style="list-style-type: none"> ■ Correct the temperature setting. ■ Check the temperature again after 24 hours. <p>The ambient temperature is too low for this wine unit. If the ambient temperature is too low, the compressor will run less frequently. The temperature in the wine unit rises.</p> <ul style="list-style-type: none"> ■ See the information in “Installation – Installation site”. ■ Increase the ambient temperature.







Problem solving guide

Problem	Possible cause and remedy
<p>The humidity inside the lower wine conditioning zone cannot be set to the required level.</p>	<p>The ambient temperature is too high or too low.</p> <ul style="list-style-type: none"> ■ Ensure an ambient temperature of 19 to 28 °C.
	<p>The temperature in the lower wine conditioning zone was set too high.</p> <ul style="list-style-type: none"> ■ A temperature of between 12 and 14 °C is recommended to store wine over the long term.
	<p>The ambient humidity is too low.</p> <ul style="list-style-type: none"> ■ If the ambient humidity is very low, it is sometimes not possible to achieve a high humidity level in the wine conditioning zones.
	<p>The humidity inside the wine conditioning unit depends on how often and for how long the door is opened, on the ambient temperature and ambient humidity, on how full the appliance is, and on the appliance settings.</p>
<p>The wooden slats in the wooden shelves are warping.</p>	<p>A change in volume due to moisture absorption or drying out is a typical characteristic of wood. An increase in humidity in the wine conditioning unit causes wooden components to warp. Therefore, under certain circumstances, wooden parts can warp and cracks can develop. Knots and grain patina are part of the natural character of the wood.</p>
<p>Mould forms on the labels of the wine bottles.</p>	<p>Mould can form on the labels, depending on the type of adhesive used on them.</p> <ul style="list-style-type: none"> ■ Remove all mould residues. Clean the wine bottles and remove any adhesive residues.
<p>A white film has formed on the corks of the wine bottles.</p>	<p>The corks have oxidised due to contact with the air.</p> <ul style="list-style-type: none"> ■ Wipe off the film with a dry cloth. The film does not affect the quality of the wine.















Problem solving guide

Problem	Possible cause and remedy
There is no audible alarm even though the appliance door has been open for a long time.	<p>This is not a fault. The alarm has been switched off in Settings mode. If you want to switch the audible alarm back on again:</p> <ul style="list-style-type: none"> ■ Tap the  symbol. ■ Swipe left or right until the  symbol is shown in the middle. ■ Tap the  symbol. ■ Select the volume you want by swiping the segment bar to the right. ■ Confirm the setting you want by tapping the segment bar. <p>When the alarms and buzzers are switched on, the  orange symbol will light up.</p>
Condensation has built up inside the wine conditioning unit. The appliance door may not close correctly.	<p>The door seal has come out of its groove.</p> <ul style="list-style-type: none"> ■ Check that the door seal is correctly seated in the groove.
	<p>The door seal is damaged.</p> <ul style="list-style-type: none"> ■ Check if the door seal is damaged.
The door seal is damaged and needs to be replaced.	<p>No tools are required to change the door seal.</p> <ul style="list-style-type: none"> ■ Change the door seal. A replacement is available from Miele.



Messages in the display

Message	Possible cause and remedy
 lights up in the display and the wine conditioning unit is not getting cold. However, the appliance and the interior lighting are working fine.	<p>Demo mode has been activated.</p> <ul style="list-style-type: none"> ■ Tap . ■ Tap . ■ Swipe left or right until  is shown in the middle. ■ Tap . <p>After demo mode  has been switched off, the wine conditioning unit shuts down and must be switched on again.</p>







Problem solving guide

Message	Possible cause and remedy
<p>Nothing is visible in the display. The display is dark.</p>	<p>Sabbath mode  is switched on: the interior lighting is switched off and the wine conditioning unit is cooling.</p> <ul style="list-style-type: none"> ■ Tap on the black display. <p> will appear in the display.</p> <ul style="list-style-type: none"> ■ Tap . <p> lights up orange.</p> <ul style="list-style-type: none"> ■ Tap the  icon again. <p>When Sabbath mode is switched off, the  symbol will light up white.</p> <hr/> <p>The display is not connected to the wine conditioning unit correctly.</p> <ul style="list-style-type: none"> ■ Was the door hinging changed correctly? Check the plug connection between the wine conditioning unit and the display again (see accompanying installation instructions). <hr/> <p>Energy-saving mode is switched on: if you do not interact with the display for a certain period of time, it switches to energy-saving mode and goes dark.</p>
<p> lights up in the display and the wine conditioning unit cannot be used.</p>	<p>The lock function has been activated.</p> <ul style="list-style-type: none"> ■ Unlock the wine conditioning unit temporarily or switch the lock function off completely (see “Adjusting settings”).
<p> lights up in the display and a buzzer sounds.</p>	<p>The Active AirClean filter display  is reminding you that the Active AirClean filter needs to be changed.</p> <ul style="list-style-type: none"> ■ Replace the Active AirClean filter (see “Cleaning and care – Replacing an Active AirClean filter (charcoal filter)”). Confirm that you have changed the Active AirClean filter by touching  in the display. <p> will go out in the display.</p>
<p> will light up yellow in the display; an alarm will also sound and the interior lighting will flash.</p>	<p>The door alarm has been activated.</p> <ul style="list-style-type: none"> ■ Tap . <p>The alarm will stop,  will go out and the interior lighting will light up again constantly.</p>

Problem solving guide

Message	Possible cause and remedy
<p> will light up red in 1 of the wine conditioning zones and an alarm will also sound.</p>	<p>The temperature alarm has been activated. The temperature in the wine conditioning zone concerned has risen higher or fallen lower than the temperature set.</p> <p>Possible reasons for this include:</p> <ul style="list-style-type: none">– The appliance door has been opened too frequently.– The ventilation openings have been blocked.– A prolonged power cut has occurred. <p>■ Tap .</p> <p> goes out and the alarm will stop.</p> <p>The warmest temperature recorded in the wine conditioning zone concerned will flash for about 1 minute in the temperature display for the wine conditioning zone. Then the temperature display will change to the current temperature in the wine conditioning zone.</p> <p>You can exit the flashing temperature display early:</p> <p>■ Touch the temperature display for the wine conditioning zone.</p> <p>The warmest temperature displayed will disappear. The temperature display will then revert to showing the current temperature in the wine conditioning zone.</p> <p>■ Rectify the cause of the alarm.</p>

Problem solving guide

Message	Possible cause and remedy
<p> lights up red in the display and an alarm also sounds.</p>	<p>Indication of a power failure: the temperature in the wine conditioning unit over the last few days or hours has risen too high because of a power failure or interruption to the power supply.</p> <ul style="list-style-type: none"> ■ Tap . <p> goes out and the alarm will stop.</p> <p>The warmest temperature recorded in the wine conditioning unit will flash for about 1 minute in the temperature display. Then the temperature display will change to the current temperature.</p> <p>You can exit the flashing temperature display early:</p> <ul style="list-style-type: none"> ■ Tap the temperature display. <p>The warmest temperature displayed will disappear. The temperature display will revert to showing the current temperature. The wine conditioning unit will go back to the last temperature setting when the power is back on.</p> <ul style="list-style-type: none"> ■ Rectify the cause of the alarm.
<p> lights up red in the display and a fault code F with numbers may appear. An alarm tone also sounds.</p>	<p>There is a fault.</p> <ul style="list-style-type: none"> ■ Tap  on the display to switch the alarm off. ■ Call Customer Service. <p>To report the fault, you need the fault code and also the model identifier and serial number of your wine conditioning unit. You can access this information in the display.</p> <ul style="list-style-type: none"> ■ To do this, touch  in the display. <p>The appliance data required will be shown in the display.</p> <p>Confirm with  to exit the information display and the fault code will be shown again in the display.</p> <p>The wine conditioning unit can be switched off directly from the fault message display.</p> <hr/> <p>There is an appliance fault: this display always has priority over any settings which have just been selected.</p> <p>An appliance fault has priority over any current door and/or temperature alarms in the display.</p>

Interior lighting



Risk of electric shock due to exposed, live electrical components!

When removing the lighting cover, there is a risk of coming into contact with live electrical components.









Do not remove the lighting cover. The LED lighting must only be repaired or replaced by a qualified technician.



Danger of injury from LED lighting.

This lighting corresponds to risk group RG 2. If the cover is defective, there is a risk of eye injury.

Do not look from a close range directly into the lighting with optical instruments (e.g. magnifying glass or similar).

Problem	Possible cause and remedy
<p>The interior lighting is not working.</p>	<p>The wine conditioning unit is not switched on.</p> <ul style="list-style-type: none"> ■ Switch the wine conditioning unit on.
	<p>Sabbath mode  is switched on: the display is dark and the wine conditioning unit is cooling.</p> <ul style="list-style-type: none"> ■ Tap on the black display. <p> will appear in the display.</p> <ul style="list-style-type: none"> ■ Tap . <p> lights up orange.</p> <ul style="list-style-type: none"> ■ Tap the  icon again. <p>When Sabbath mode is switched off,  will light up white.</p>
	<p>To avoid overheating, the interior lighting switches itself off automatically after approx. 15 minutes if the appliance door is left open. If this is not the case, there is a fault.</p> <ul style="list-style-type: none"> ■ Call Customer Service.
<p>The interior lighting is on even when the appliance door is closed.</p>	<p>This is not a fault. The feature lighting is switched on.</p> <ul style="list-style-type: none"> ■ To switch off the feature lighting, touch the sensor control for the feature lighting  in the display. <p>The  sensor control no longer lights up orange.</p>
<p>The interior lighting is pulsating.</p>	<p>This is not a fault. The door alarm has been activated.</p>

Problem solving guide

Noises

The wine conditioning unit is producing various noises during operation.
If the cooling performance is low, the wine conditioning unit will conserve energy but operate for longer. The volume will be lower.
Food will be chilled faster if the cooling performance is high.
The volume will be higher.

Normal noises	What causes them
Hissing	Refrigerant is being injected into the cooling circuit.
Bubbling, gurgling, splashing	Refrigerant is circulating through the pipes.
Humming	The wine conditioning unit is cooling.
Clicking	The thermostat is switching the compressor on or off.
Humming, whirring	The fan is running.
Cracking	Materials are expanding inside the wine conditioning unit.
Rattling	Valves or flaps are active.
Slurping (wine conditioning unit with soft-close mechanism)	The appliance door with soft-close mechanism is being opened or closed.

Please bear in mind that the noise of the compressor and the coolant circulating in the system is unavoidable.

Problem solving guide

Noises	Possible cause and remedy
Vibrating, rattling, clinking	The wine unit is uneven. Realign the wine unit using a spirit level. Do so by raising or lowering the adjustable feet underneath the wine unit (depending on the model). For built-in appliances: For niches of 140 cm or more: place the stabilising rods supplied underneath the appliance base.
	The wine unit is touching other appliances or pieces of furniture. Move the wine unit away.
	Drawers, baskets or shelves are jiggling or are stuck. Check all removable items and refit them correctly.
	Bottles or containers are touching. Separate bottles or containers slightly.
	The transport cable clips (depending on the model) are hanging loose at the back of the appliance. Remove the transport cable clips.

Service

You can find information on how to remedy faults yourself at www.miele.com.au/support/customer-assistance or www.miele.co.nz/support/customer-assistance and about Miele spare parts at www.miele.com.au/service or www.miele.co.nz/service.

Contact in case of fault

In the event of a fault which you cannot remedy yourself, please contact Miele.

You can book a Miele customer service call-out online at www.miele.com.au/service or www.miele.co.nz/service.

Contact information for Miele can be found at the end of this booklet.

Please quote the model and serial number of your appliance when contacting Miele. Both of these can be found on the data plate inside the refrigeration appliance or, depending on the model, in the settings mode under information **i**.

Warranty

The manufacturer's warranty for this appliance is 2 years.

For further information, please refer to your warranty booklet.

Installation site

 Fire hazard and risk of damage from appliances that give off heat. Appliances which give off heat can catch fire and set fire to the wine unit.

The power supply cord must not come into contact with heat sources. Do not place appliances which give off heat, such as mini-ovens, double burner cooktops or toasters, on the wine unit.

 Fire risk and danger of damage from open flames!

Open flames can set fire to the wine conditioning unit. Keep open flames (e.g. a candle) away from the wine conditioning unit.

 Risk of fire and damage due to improper installation.

If the mains plug and power supply cords touch the back of the wine unit, they may be damaged by vibrations and cause a short circuit. Mains plugs or power supply cords must not touch the wine unit.

Power supply cords must not be trapped or damaged.

Do not connect any other appliances to sockets located directly behind this wine unit.

Do not place or operate multi-socket adapters, distributor strips or other electronic devices (such as halogen transformers) behind the appliance.

This appliance should be installed in a dry, well-ventilated room.

The floor at the installation site must be horizontal and level and must be as high as the surrounding floor.

 Risk of damage due to high humidity.

In environments with high humidity, condensation can build up on the external wine unit panels.

This condensate can cause corrosion on external appliance panels.

Install the wine unit with sufficient ventilation in a dry and/or air-conditioned room.

After installation, please make sure that the appliance door(s) closes (close) properly and the wine unit is installed in accordance with these installation instructions. It is essential to comply with the specified ventilation opening requirements.

When deciding on the installation site, please bear in mind that the energy consumption increases if the wine unit is installed near a heater, a cooker or another appliance that gives off heat. Avoid direct sunlight. Higher ambient temperatures increase energy consumption as the compressor runs for longer.

Climate range

This wine conditioning unit is designed for use within specific ambient temperatures (climate range). Do not use it in ambient temperatures for which it is not designed. The climate range is stated on the data plate inside the wine conditioning unit.

Installation

Climate range	Ambient temperature
SN	10 to 32 °C
N	16 to 32 °C
ST	16 to 38 °C
T	16 to 43 °C
SN-ST	10 to 38 °C
SN-T	10 to 43 °C

A lower ambient temperature will cause the compressor to switch off for longer periods, meaning that the wine conditioning unit is unable to maintain the required temperature in some circumstances.

Ventilation requirements

⚠ Risk of fire and damage due to insufficient ventilation!
If the wine conditioning unit is not ventilated sufficiently, the compressor will run more frequently and for longer periods. This will result in increased energy consumption and a higher operating temperature of the compressor. This, in turn, can result in damage to the compressor. Please ensure that there is adequate ventilation around the wine conditioning unit. It is essential to observe the required ventilation openings. The ventilation openings must not be covered or blocked in any way. They must also be cleaned on a regular basis to remove dust.

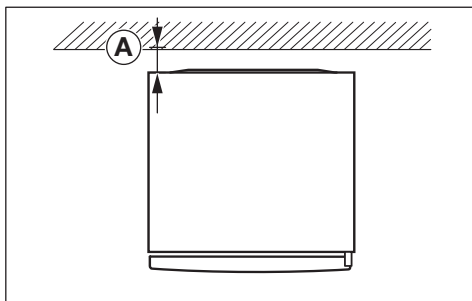

The energy consumption was calculated with a distance of **Ⓐ** = 25 mm between the back of the appliance and the wall. If the distance to the wall is less than 25 mm, the functionality of the wine unit is maintained, but energy consumption increases slightly. Condensation can also form at high ambient temperatures.

Air at the back of the wine conditioning unit gets warm. Sufficient space for proper ventilation must therefore be ensured (see “Installation - Appliance dimensions”).

Installing several wine conditioning units/refrigeration appliances

 Risk of damage due to condensation on the external appliance panels.

In environments with high humidity, condensation can build up between the external wine conditioning unit panels, which can cause corrosion.

Do **not** place different wine conditioning units/refrigeration appliances **directly** next to one another.

A distance of at least 70 mm must be maintained between the wine conditioning units/refrigeration appliances.

Changing the door hinging

The wine unit is supplied with right-hand hinging. If left-hand hinging is required, the door hinging must be changed.

Useful tip: Place a suitable cover on the floor in front of the wine unit to protect the appliance door and your floor from damage.

 Risk of injury and damage due to live electrical components.

You will come into contact with live electrical components while you are changing the hinging.

Switch off the appliance at the wall socket and withdraw the plug before changing the hinging.

 Danger of injury and damage to the appliance due to heavy door.

There is an increased danger of injury and damage if the door hinging is installed by a single person.

Always change the door hinging with the help of a second person.

 Carry out the door hinging change in accordance with the installation instructions (see QR code).



Material number 12350120

Installation

Installing the wine unit

⚠ Risk of injury and damage due to the wine conditioning unit tipping over.

There is an increased risk of injury and damage if the wine conditioning unit is installed by a single person. Two people are always required to install the wine conditioning unit.

⚠ Risk of damage and injury caused by appliance door impact.

The appliance door could hit the wall of the room resulting in damage to the door. If the door is made of glass, the damaged glass can lead to injuries.

Protect the appliance door by fitting a felt stopper, for example, to the wall of the room.

⚠ Risk of damaging the floor.

Moving the wine conditioning unit can cause damage to the floor. Move the wine conditioning unit carefully on floors that are sensitive to scratching.

For easier installation, there are transport handles on the back at the top and transport wheels underneath the wine conditioning unit.

The wine unit must be empty when it is installed.

- Prepare the wine unit for installation as close as possible to its intended installation site.
- Connect the wine unit to the mains power supply as described in “Installation – Electrical connection”.

- Move the wine unit carefully to its intended installation site.
- Position the wine unit with its back facing the wall, taking the necessary distance into account.

Aligning the wine conditioning unit

⚠ Risk of damage and injury caused by the appliance door falling out or the wine conditioning unit tipping over.

If the additional adjustable foot on the hinge plate at the bottom is not resting firmly on the floor, the appliance door can fall out or the wine conditioning unit can tip over.

Use the spanner supplied with the appliance to unscrew the adjustable foot until it is resting on the floor. Then unscrew it by a further quarter turn.

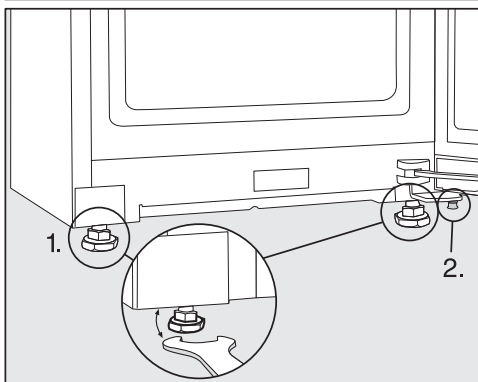

- Use a spirit level and the spanner supplied to align the wine conditioning unit and support the appliance door.

1. Adjust the front adjustable feet.

- Unscrew the additional adjustable foot until it is touching the floor. Then unscrew it by a further quarter turn.

Integrating the wine unit in a run of kitchen units

The wine unit can be surrounded by kitchen units.

The energy consumption was calculated with a distance of 25 mm between the back of the appliance and the wall. If the distance to the wall is less than 25 mm, the functionality of the wine unit is maintained, but energy consumption increases slightly. Condensation can also form at high ambient temperatures.

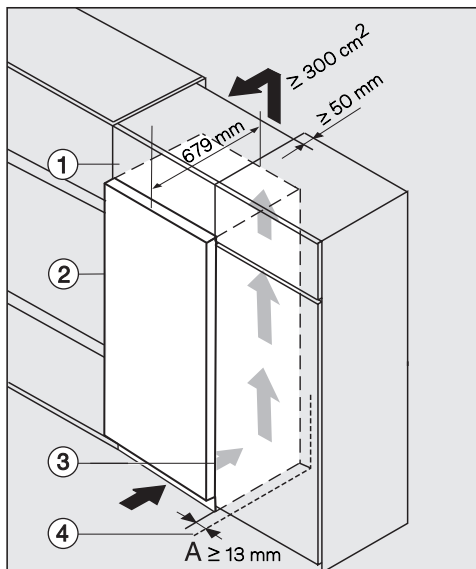

- Top box
- Wine unit, door depth = 75 mm
- Kitchen unit
- Wall

⚠ Risk of fire and damage due to insufficient ventilation!

If the wine conditioning unit is not ventilated sufficiently, the compressor will run more frequently and for longer periods. This will result in increased energy consumption and a higher operating temperature of the compressor. This, in turn, can result in damage to the compressor.

Please ensure that there is adequate ventilation around the wine conditioning unit.

It is essential to observe the required ventilation openings.

The ventilation openings must not be covered or blocked in any way.

They must also be cleaned on a regular basis to remove dust.

The larger the ventilation openings, the less energy the compressor will use.

Installation

- Install the wine unit next to the kitchen unit ③.
- The appliance front must protrude in front of furniture fronts by at least the door depth. This enables the appliance door to be opened and shut without being obstructed.
- When installing the wine unit next to a wall ④, a distance (**A**) must be maintained on the hinge side between the wall ④ and the wine unit ②.
- To match the height of the rest of the kitchen units, the wine unit can be fitted with a suitable top box ①.

An air outlet of 50 mm depth must be provided across the whole width of the top box.

The ventilation cross-section under the ceiling must be at least 300 cm² to ensure that warm air can escape without obstruction.

Appliance dimensions

Installation dimensions/View from above

All dimensions are given in mm.

The wine conditioning unit will function correctly if the specified ventilation openings are kept clear.

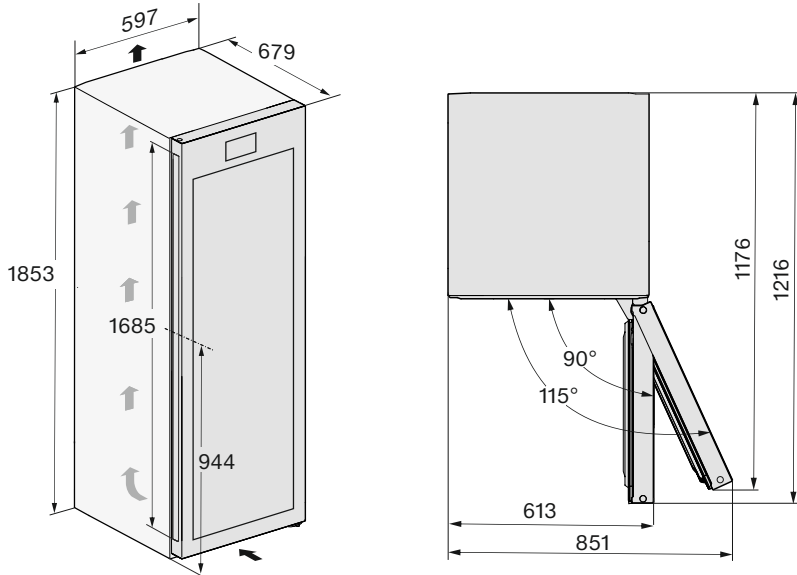

* Dimensions without wall spacers fitted. Appliance depth is increased by 15 mm with the wall spacers supplied fitted.

Installation

Connections

All dimensions are given in mm.

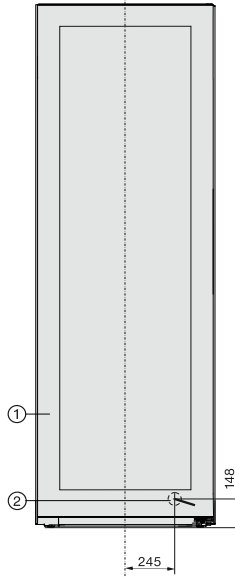

- ① Front view
- ② Mains connection cable, length = 2000 mm
A longer mains connection cable is available from Miele

Electrical connection

The wine conditioning unit must only be connected to an earthed socket using the mains connection cable supplied.

The socket should be easily accessible after the wine conditioning unit has been installed. If the socket is not easily accessible, ensure that a suitable means of disconnection is provided on the installation side for each pole.

⚠ Risk of fire from overheating.
Connecting the wine conditioning unit to a multi-socket adapter or to an extension lead can overload the mains connection cable.
For safety reasons, do not use an extension cable or multi-socket adapter.

All electrical work must be carried out by a suitably qualified and competent person in strict accordance with national and local safety regulations.

For extra safety, it is advisable to install a suitable residual current device (RCD) with a trip current of 30 mA. Ensure power is not supplied to the appliance until after the installation has been completed.

If the mains connection cable is damaged, it must only be replaced with a specific mains connection cable of the same type (available from Miele Customer Service). For safety reasons, replacement may only be carried out by a suitably qualified specialist or Miele.

These operating instructions and the data plate indicate the nominal power consumption and the appropriate fuse rating. Compare this information with the data of the on-site electrical connection. If in any doubt, consult a qualified electrician.

Temporary or permanent operation with a self-sufficient or non-mains synchronous energy supply system (e.g. isolated networks, back-up systems) is possible. A requirement for the operation is that the energy supply system complies with all current local and national requirements that apply to stand-alone, solar and/or battery systems.

The protective measures provided in the domestic installation and in this Miele product must also be assured in their function and operation in isolated operation or in non-mains synchronous operation, or replaced with equivalent measures in the installation.

Connection dimensions

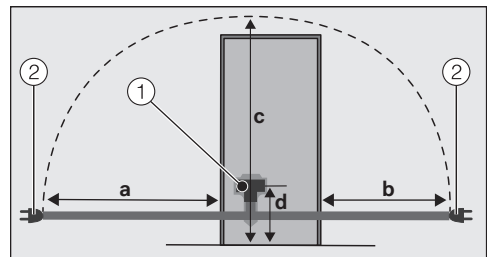

Back of the refrigeration appliance/wine conditioning unit

- ① Appliance plug connector
- ② Power plug

a	b	c	d
1800 m	1400 m	2100 m	200 m
m	m	m	m

Installation

Connecting the wine conditioning unit

- Plug the appliance plug connector into the appliance socket.

Make sure that the plug connector has locked into position correctly.

- Insert the plug of the wine conditioning unit into the socket and switch on at the socket.

The wine conditioning unit is now connected to the electricity supply.

Miele Australia Pty. Ltd.

ACN 005 635 398

ABN 96 005 635 398

Level 4, 141 Camberwell Road
Hawthorn East, VIC 3123

1300 464 353 (1300 4 MIELE)

info@miele.com.au

www.miele.com.au

Miele New Zealand Limited

IRD 98 463 631

8 College Hill
Freemans Bay, Auckland 1011

0800 464 353 (0800 4 MIELE)

customercare@miele.co.nz

www.miele.co.nz

Miele Global Headquarters

Germany

Miele & Cie. KG

Carl-Miele-Straße 29

33332 Gütersloh

Federal Republic of Germany

KWTS 4785 ...

en- AU, NZ

M.-Nr. 12 596 120 / 05 / 002