

Operating instructions Coffee machine



To avoid the risk of accidents or damage to the appliance it is **essential** to read these instructions before it is installed and used for the first time.

Caring for the environment

Disposing of the packaging material

The packaging material is used for handling and protects the appliance from transport damage. The packaging material used is selected from materials which are environmentally friendly for disposal and can generally be recycled.

Recycling the packaging material reduces the use of raw materials. Use material-specific collection points for valuable materials and take advantage of return options. Your Miele dealer will take the packaging material away.

Disposal of your old appliance

Electrical and electronic appliances often contain valuable materials. They also contain materials which, if handled or disposed of incorrectly, could be potentially hazardous to human health and to the environment. They are, however, essential for the correct functioning of your appliance. Please do not therefore dispose of it with your household waste.

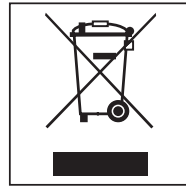

Please dispose of it at your local community waste collection / recycling centre or contact your Miele dealer for advice.

Ensure that it presents no danger to children while being stored for disposal.

Caring for the environment	2
Warning and Safety instructions	6
Product description	16
Controls and indicators	18
Operation	20
Symbols in the display	21
Miele@home	22
Before using for the first time	23
Filling the water container	25
Filling the coffee bean container	26
Switching on and off	27
Cup heating	28
Adjusting the central spout to the correct cup height	29
Making drinks	30
Making coffee with and without milk.....	30
Milk preparation.....	31
Using a milk carton with the milk siphon	31
Making a coffee.....	33
Cancelling a drink.....	33
DoubleShot.....	33
Making 2 portions (☑ sensor control).....	33
Coffee pot.....	34
Making coffee drinks with ground coffee	35
Adding ground coffee.....	35
Tea.....	36
TeaTimer.....	37
Making tea.....	37
Dispensing warm or hot water	38
Expert mode	39
Grinder setting	40
Adjusting the fineness of grind.....	40

Contents

Parameters	41
Displaying and changing parameters.....	41
Portion size.....	41
Quantity of coffee.....	42
Brewing temperature.....	42
Pre-brewing the ground coffee.....	42
Profiles	43
Creating profiles.....	43
Making drinks stored in a profile.....	43
Changing drinks within a profile.....	43
Editing profiles.....	43
Setting when the profile should change.....	43
Changing the name.....	44
Deleting a profile.....	44
MobileStart	45
Settings	46
Displaying and changing Settings.....	46
Language.....	46
Timer: switch off after.....	46
TeaTimer.....	46
Volume.....	46
Display brightness.....	46
Lighting.....	46
Info (display information).....	46
Altitude.....	46
Performance mode.....	46
Eco mode.....	47
Barista mode.....	47
Latte mode.....	47
Party mode.....	47
Water hardness.....	47
System lock 	48
Miele@home.....	49
Remote control.....	49
RemoteUpdate.....	49
Software version.....	50
Showroom programme (Demo mode).....	50
Factory defaults.....	50
Cleaning and care	51
Overview of cleaning intervals.....	51

Cleaning by hand or in the dishwasher	52
Unsuitable cleaning agents	53
Drip tray and waste container	54
Cleaning the drip tray cover	55
Water container	55
Removing and cleaning the water container filter	56
Dismantling and cleaning the central spout	56
Cleaning the steam jet	58
Cleaning the milk pipework and rinse valve	58
Cleaning the milk siphon	60
Cleaning the milk flask	60
Bean container and ground coffee chute	60
Cleaning the casing	61
Opening the “Maintenance” menu	61
Rinse the appliance	61
Rinsing the milk pipework	61
Degreasing the brew unit	63
Descaling the machine	65
Problem solving guide	67
Messages in the display	67
Unusual performance of the coffee machine	70
Unsatisfactory results	77
Transporting the machine	79
Evaporating the coffee machine	79
Packing the machine	79
After sales service and warranty	80
Contact in case of malfunction	80
Guarantee	80
Accessories	81
Saving energy	82
Electrical connection	83
Non-rewireable plugs BS 1363	84
Installation	85
Dimensions	86
Technical data	87

Warning and Safety instructions

This coffee machine complies with all the stipulated safety requirements. Inappropriate use can, however, lead to personal injury and material damage.

Read the operating instructions carefully before using the coffee machine. They contain important information on the installation, safety, use and maintenance of the appliance. This prevents both personal injury and damage to the coffee machine.

Miele expressly and strongly advises that you read and follow the instructions in the chapter on installing and connecting the coffee machine as well as the safety instructions and warnings.

Miele cannot be held liable for injury or damage caused by non-compliance with these instructions.

Keep these operating instructions in a safe place and pass them on to any future owner.

Correct application

- ▶ This coffee machine is intended for home use.
- ▶ This coffee machine is not intended for outdoor use.
- ▶ This coffee machine must not be used at altitudes above 2000 m.
- ▶ It must only be used as a domestic appliance to make espresso, cappuccino, latte macchiato, tea etc. Any other use is not permitted.
- ▶ This coffee machine can only be used by people with reduced physical, sensory or mental capabilities, or lack of experience and knowledge, if they are supervised whilst using it, or have been shown how to use it in a safe way and recognise and understand the consequences of incorrect operation.

Warning and Safety instructions

Safety with children

- ▶ Install the coffee machine where it is out of the reach of children.
- ▶ Children under 8 years of age must be kept away from the coffee machine and the mains connection cable and plug/socket.
- ▶ Children aged 8 and older may only use the coffee machine without supervision if they have been shown how to use it in a safe manner.
Children aged 8 and older must be aware of the potential dangers caused by incorrect operation.
- ▶ Please supervise children in the vicinity of the coffee machine and do not allow them to play with it.
- ▶ Young children must not be allowed to clean the coffee machine at all. Cleaning may only be carried out by children 8 years of age or older under the supervision of an adult.
- ▶ Remember that coffee and espresso are not suitable drinks for children.
- ▶ Danger of suffocation! Whilst playing, children may become entangled in packaging material (such as plastic wrapping) or pull the packaging material over their head, presenting the risk of suffocation. Keep packaging material away from children.

Technical safety

- ▶ A damaged coffee machine is dangerous. Check it for any visible damage before setting it up. Never attempt to use a damaged coffee machine.
- ▶ To avoid the risk of damage to the machine, make sure the connection data (voltage and frequency) on the data plate corresponds to the household supply, before connecting the machine to the mains supply. Consult a qualified electrician if in any doubt.
- ▶ The electrical safety of this coffee machine can only be guaranteed when correctly earthed. It is essential that this standard safety requirement is met. If in any doubt please have the electrical installation tested by a qualified electrician.
- ▶ Temporary or permanent operation on an autonomous power supply system or a power supply system that is not synchronised with the mains power supply (e.g. island networks, back-up systems) is possible. A prerequisite for operation is that the power supply system complies with the specifications of EN 50160 or an equivalent standard.

The function and operation of the protective measures provided in the domestic electrical installation and in this Miele product must also be maintained in isolated operation or in operation that is not synchronised with the mains power supply, or these measures must be replaced by equivalent measures in the installation. As described, for example, in the current version of BS OHSAS 18001–2 ISO 45001.
- ▶ Do not connect the machine to the mains electricity supply by a multi-socket adapter or an extension lead. These are a fire hazard and do not guarantee the required safety of the appliance.
- ▶ The coffee machine must not be used in a non-stationary location (e.g. on a ship).

Warning and Safety instructions

- ▶ Unplug the machine from the power supply immediately if you notice any damage or smell scorching, for example.
- ▶ Ensure that the mains connection cable cannot be pinched or damaged by any sharp edges.
- ▶ The mains connection cable should not hang down. Someone could trip over it with the risk of injury and damage the machine.
- ▶ Only use the coffee machine in rooms where the ambient temperature is between +10 °C and +38 °C.
- ▶ Position the coffee machine at a height of at least 850 mm from the floor.
- ▶ Danger of overheating. Please ensure that there is adequate ventilation around the coffee machine. Do not cover the coffee machine with tea towels etc. while it is in use.
- ▶ If the coffee machine is installed behind a closed furniture front, it may only be used with the furniture door open (see “Installation” for the minimum niche size). Heat and moisture can build up behind the furniture front when closed. This can result in damage to the appliance and/or furniture unit. Do not close the furniture front while the coffee machine is in use. Leave the furniture door open until the coffee machine has cooled down completely.
- ▶ Protect the coffee machine from water and water spray. Do not immerse the machine in water.
- ▶ Repairs and other work by unqualified persons to the machine and the connection cable could be dangerous. The manufacturer cannot be held liable for unauthorised work. Repairs may only be carried out by a Miele authorised technician.
- ▶ While the machine is under warranty, repairs should only be undertaken by a Miele authorised technician. Otherwise the warranty is invalidated.

Warning and Safety instructions

- ▶ The coffee machine must be disconnected from the electricity supply during repair work.
- ▶ Never open the outer casing of the machine. Tampering with electrical connections or components and mechanical parts is highly dangerous to the user and can cause operational faults or electric shock.

Warning and Safety instructions

Correct use

 Danger of burning and scalding on the dispensing spouts. The liquids and steam dispensed are very hot.

Keep well away from the area underneath the spouts when hot liquids and steam are being dispensed.

Do not touch hot components.

Hot liquid or steam could spatter from the spouts. Ensure that the central spout is clean and fitted correctly.

Water in the drip tray can also be very hot. Take care when emptying it.

 Danger of injury to the eyes.

Never look directly at the lighting or use optical instruments to look at it.

► Please note the following regarding water:

- The water quality must conform to the requirements for drinking water in the country in which the coffee machine is being used.
- Only use cold, fresh tap water to fill the water container. Hot or warm water or other liquids can damage the coffee machine.
- Change the water every day to prevent a build-up of bacteria.
- Do not use carbonated water.

► Only fill the bean container with roasted espresso/coffee beans. Do not fill the bean container with coffee beans which have been treated with additives or with ground coffee.

► Do not fill the bean container with any type of liquid.

► Do not use green (unroasted) coffee beans or mixtures of coffee beans which contain green coffee beans. Green coffee beans are very hard and still contain residual moisture. These can damage the coffee machine grinder as soon as grinding begins.

Warning and Safety instructions

- ▶ Do not use coffee beans which have been treated with caramel, sugar or other substances including sugary liquids. Sugar will damage the coffee machine.
- ▶ Only fill the coffee chute with ground coffee beans.
- ▶ Do not use any caramelised ready ground coffee. The sugar in the coffee will stick to and block the brew unit of the coffee machine. The cleaning tablets for degreasing the brew unit will not remove this type of deposit.
- ▶ Only use milk without additives. Additives in milk usually contain sugar and this will stick to the milk pipework.
- ▶ If using dairy milk make sure that it has been pasteurised.
- ▶ When making tea, please follow the instructions on the packaging.
- ▶ Do not use naked flames, e.g. a candle, on or near the coffee machine. The coffee machine could catch fire with the risk of the fire spreading.
- ▶ The machine must not be used for cleaning objects.

Warning and Safety instructions

Accessories and spare parts

- ▶ Miele can only guarantee the safety of the machine when original Miele spare parts are used. Faulty components must only be replaced by genuine Miele original spare parts.
- ▶ Only use original Miele accessories. If other parts are used, warranty, performance and/or product liability claims will be invalidated.
- ▶ Miele will guarantee to supply functional spare parts for a minimum of 10 years and up to 15 years following the discontinuation of your coffee machine.

Cleaning and care

- ▶ Refer to the relevant instructions in “Cleaning and care”.
- ▶ Do not use a steam cleaner to clean this machine. Steam could reach electrical components and cause a short circuit.
- ▶ Descale the coffee machine regularly depending on the water hardness level in your area. Descale the machine more frequently in areas with very hard water. Miele cannot be held liable for damage arising from insufficient descaling, the use of incorrect descaling agent or the use of descaling agent which is not of the appropriate concentration.
- ▶ Degrease the brew unit regularly with Miele cleaning tablets. Depending on the natural oil content of the coffee used, the brew unit can become blocked quite quickly.
- ▶ Used coffee grounds should be disposed of with the organic rubbish or on the compost heap. Do not empty them down the sink, as they could block it.

Warning and Safety instructions

For machines with stainless steel surfaces:

- ▶ Do not use sticky notes, adhesive tape, masking tape or other types of adhesive on the stainless steel surfaces.
- ▶ Stainless steel surfaces are susceptible to scratching. Even magnets can cause scratches.

Product description

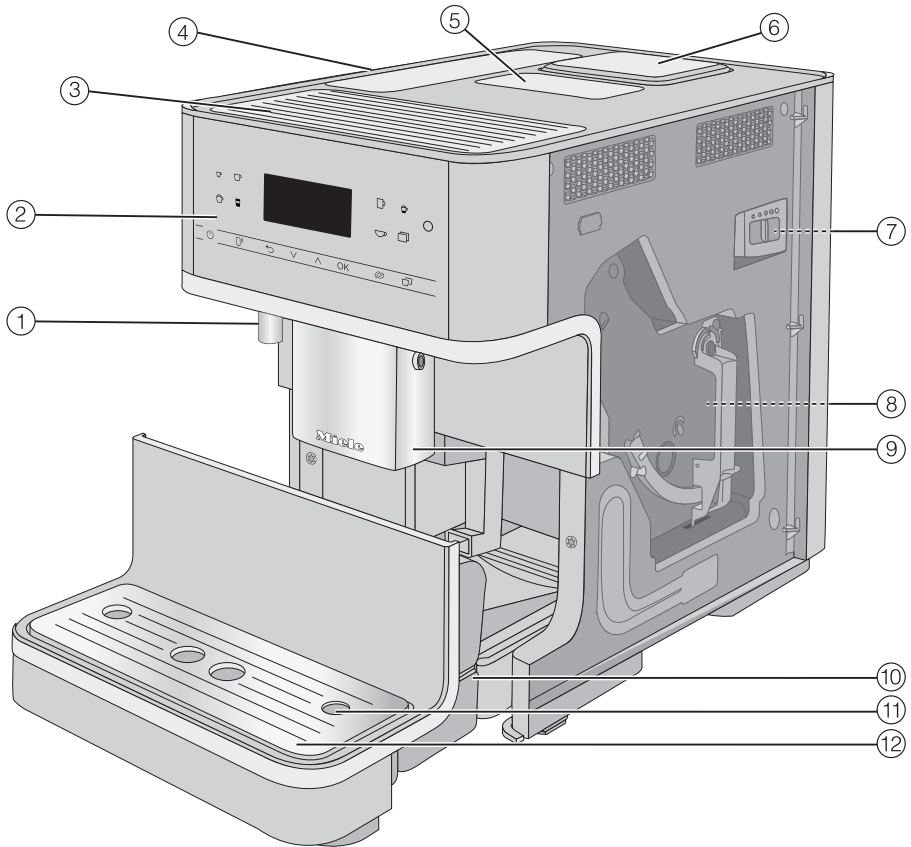

① Hot-water spout

② Control panel

③ Cup heater*

④ Water container

⑤ Ground coffee chute

⑥ Bean container

⑦ Grinder setting (behind the appliance door)

⑧ Brew unit (behind the appliance door)

⑨ Height-adjustable central spout

⑩ Drip tray with lid and waste container

⑪ Milk pipework aperture

⑫ Lower panel with drip tray cover

* depending on model: CM 6360, CM 6560

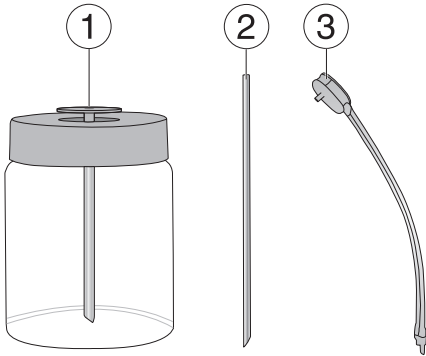





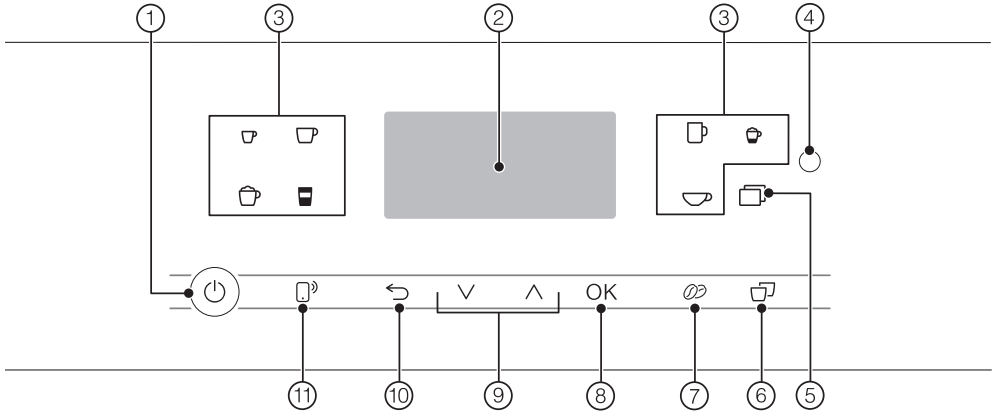

- ① Milk flask*
- ② Milk siphon
- ③ Milk pipework with rinse valve







* depending on model: CM 6360,
CM 6560

Controls and indicators



- ① **On/Off button** 
For switching coffee machine on and off
- ② **Display**
For showing information about the current action or status
- ③ **Drink buttons**
For making drinks
- ④ **Optical interface**
(For your Miele dealer only)
- ⑤ **Sensor control** 
 - For making other drinks: ristretto, cappuccino italiano, flat white, café au lait, hot milk and milk froth, hot water, warm water, coffee pot function
 - Maintenance programmes
 - Profiles
 - Settings
- ⑥ **“2 portions”**  sensor
For dispensing 2 portions of a drink at once
- ⑦ **“DoubleShot”**  sensor
For making a particularly strong and aromatic coffee by using twice as much ground coffee but the same amount of water
- ⑧ **OK sensor**
For confirming display messages and saving settings
- ⑨ **Arrow buttons** 
For scrolling through lists, selecting entries or changing values
- ⑩ **“Back”**  sensor
For returning to the previous menu and cancelling unwanted actions
- ⑪ **MobileStart sensor control** 
For activating the Remote start option for making drinks via the Miele app

Drink button symbols

-  Espresso
-  Coffee
-  Long coffee
-  Cappuccino
-  Latte macchiato
-  Espresso macchiato
-  Tea water

Operation

Sensors

To operate the coffee machine, touch the sensors with your finger.

An audible signal is generated each time a sensor is touched. You can adjust the volume of the signal tones or switch the tones off (see “Settings – Volume”).

Drinks menu

When the following appears in the display, you are in the drinks menu: Select drink.

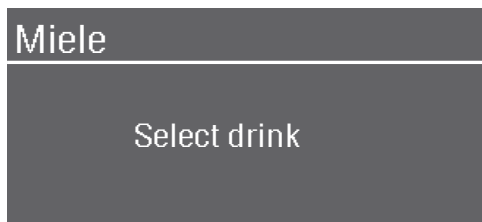

You can find more drinks in the Further menu (☐ sensor control).

Selecting a menu and navigating within a menu

To select a menu, touch the relevant sensor control, e.g. the ☐ sensor control.



You will then be able to start an action or change settings in the menu. A bar on the right-hand side of the display indicates that further options or text are available.

To select a menu option, keep pressing the ^∨ arrow buttons until the option you want is highlighted.

As soon as you reach a confirmable value, message or setting, the *OK* sensor control will light up orange.

Touch the *OK* sensor control to confirm your selection.

The setting which is currently selected in a list will have a tick ✓ beside it.







Exiting a menu or cancelling an action

To exit the current menu, touch the ↵ sensor.

Alternatively, touch the lit orange sensor again to return to the drinks menu.

Symbols in the display

The following symbols may also appear in the display in addition to the text:

Symbol	Explanation	
	This symbol indicates the “Settings” menu and the “Language” menu option.	
	This symbol indicates that there is additional information and advice about using the coffee machine. Select OK to confirm the information.	
	The system lock is activated (see „Settings – Locking the coffee machine (System lock 	The TeaTimer minute minder has been started (see “Tea – TeaTimer”). The remaining brewing time is shown next to the symbol.
	This symbol appears while the appliance is being descaled. (This symbol can also be found on the water container: fill up to this mark).	
	If Miele@home has been activated for the coffee machine, these symbols represent the quality/status of the WiFi connection, indicating the strength in increments from strong to not connected.	

Miele@home

Your coffee machine is equipped with an integrated WiFi module.

To use this feature, you will need:

- A WiFi network
- The Miele app
- A Miele user account. You can create a user account via the Miele app.

The Miele app will guide you through the process of connecting your coffee machine to your home WiFi network.

Once your coffee machine is connected to your WiFi network, you can use the app to carry out activities such as the following:

- Calling up information on the operating status of your coffee machine
- Changing settings on your coffee machine
- Controlling your coffee machine remotely

Connecting your coffee machine to your WiFi network will increase energy consumption, even when the machine is switched off.

Before installing the coffee machine in its final location, ensure that the signal from your WiFi network is strong enough.

Availability of the WiFi connection

The WiFi connection shares a frequency range with other appliances (including microwave ovens and remote control toys). This can give rise to sporadic or

even complete connection failures. Therefore, the availability of featured functions cannot be guaranteed.

Miele@home availability

The ability to use the Miele app depends on the availability of the Miele@home service in your country.

The Miele@home service is not available in every country.

For information about availability, please visit www.miele.com.

Miele App

The Miele App is available to download free of charge from the Apple App Store® or from the Google Play Store™.



Before using for the first time

Before using for the first time

- Remove any notices from the machine.

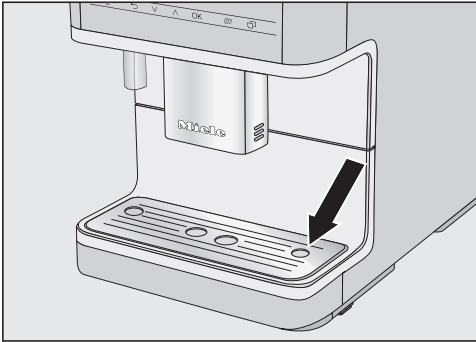

- Remove the protective foil from the drip tray cover and place the drip tray cover into the lower panel.
- Place the coffee machine on a flat surface that is not sensitive to water (see “Installation”).

Clean the appliance before filling it with water and coffee beans. Refer to the relevant instructions in “Cleaning and care”; for example, clean the bean container with a soft, dry cloth.

- Clean the water container, the bean container and the central spout.
- Remove the water container and fill it with fresh, cold tap water. Only fill the water container up to the “max.” marker and then refit it in the machine.
- Take the lid off the bean container, fill it with roasted coffee beans and replace the lid.
- Insert the plug of the coffee machine into the socket.

Switching on for the first time

- Press the On/Off button  if nothing is visible on the display.

Selecting the display language

- Select the desired display language.

You might also be asked for your location.

Setting up the network (Miele@home)

You can connect your coffee machine to your home WiFi network.

The following appears in the display during set-up: Set up “Miele@home”

Tip: You can also choose to set up Miele@home for your coffee machine at a later point. In this case, select Skip.

- Make sure that your WiFi network signal is sufficiently strong in the place where you want to set up your coffee machine.
 - Touch Continue.
 - Select the connection method you wish to use.
 - Follow the instructions provided in the coffee machine display and in the Miele app.
- Connection successfully established. will appear in the display.
- Touch Continue to proceed with the set-up.

Before using for the first time

Setting the water hardness level

Contact your local water supplier to find out your local water hardness range if necessary.

More information can be found under “Settings – Water hardness”.

- Enter your local water hardness (in °dH) and confirm with *OK*.

Selecting the Performance mode

You can select the appropriate mode to suit your personal preferences (see “Settings – Performance mode”).

- **Eco mode:** This is an energy-saving mode.
 - **Barista mode:** This mode has been optimised for unadulterated coffee enjoyment.
 - **Latte mode:** In this mode, milk-based drinks can be prepared within a much shorter space of time.
- Select the desired mode and confirm with *OK*.

Your machine has been successfully set up and is ready for use.

- Confirm with *OK*.

The coffee machine heats up and rinses the pipework. The water used for rinsing will run out of the central spout.

- Before preparing milk for the first time, rinse the milk pipework (see “Cleaning and care – Rinsing the milk pipework”).

Please note that the full aroma of the coffee and typical crema will not develop fully until several coffees have been made.

To ensure that any coffee residues from the factory testing process are removed from the brewing system, please throw away the first 2 cups of coffee when using the coffee machine for the first time.

Switch the coffee machine off with the On/Off button . Do not unplug the power plug to switch off the coffee machine. If you unplug the coffee machine from the mains supply while using it for the first time, you will have to set it up for use again.

For the first coffee drinks, a larger quantity of coffee beans is ground and powder from the coffee grounds may adhere to the lid of the drip tray.

Filling the water container

 Risk to health due to contaminated water.

Bacteria can develop in water which has been sitting in the water container for too long and is a risk to your health.

Change the water in the water container **every day**.

 Risk of damage due to incorrect operation.

Unsuitable liquids such as hot or warm water or other liquids can damage the coffee machine. Bottled mineral water leaves too much limescale in the coffee machine.

Only use cold, fresh tap water to fill the water container.

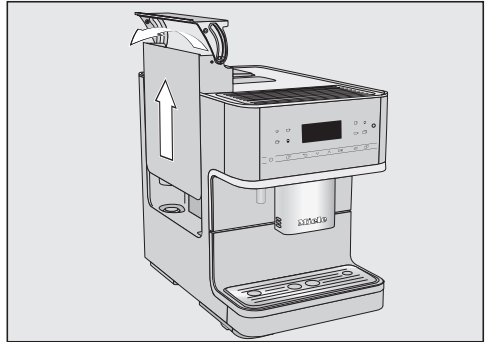

- Press the lid on the right side.
- Pull the water container up by the lid to remove it.
- Fill the water container with fresh, cold drinking water up to the *max.* mark.
- Reinsert the water container.

If the water container sits a little too high or at an angle, check whether the surface under the water container is soiled. This will prevent the dispenser valve from attaching correctly and water can leak out. Clean the surface underneath the water container if necessary.

Filling the coffee bean container

Fill the coffee bean container with roasted coffee or espresso beans if you want to use freshly ground coffee beans for each cup of espresso or coffee.

Alternatively, you can make coffee or espresso with ready ground coffee (see „Making coffee or espresso using ready ground coffee“).

Warning! Risk of damage to the grinder.

Only put roasted coffee or espresso beans in the container. Anything else, including ground coffee, will damage the grinder.

Do not fill the bean container with any type of liquid.

Warning! Sugar will damage the coffee machine.

Do not use coffee beans that have been treated with sugar, caramel or other substances and do not put liquids containing sugar in the coffee bean container.

Do not use green (unroasted) coffee beans or mixtures of coffee beans which contain green coffee beans. Green coffee beans are very hard and still contain residual moisture. These can damage the coffee machine grinder as soon as grinding begins.

Tip: You can use a nut or seed grinder to grind green coffee beans. These types of grinder generally have a rotating stainless steel blade. You can then add the ground green coffee **one portion at a time** to the ground coffee chute and make the desired coffee drink (see „Making espresso and coffee using ready ground coffee“).

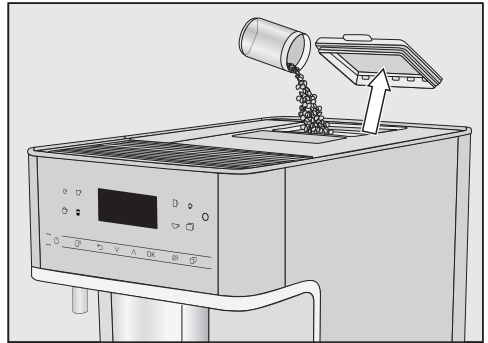

- Take the lid off the coffee bean container.
- Fill the container with roasted coffee beans.
- Replace the lid.

Tip: Only add enough beans to last for a few days. Contact with air causes coffee beans to lose their aroma.

Switching the coffee machine on

- Touch the On/Off button .

The coffee machine heats up and rinses the pipework. Hot water will run out of the central spout.

When *Select drink* appears in the display, you can make drinks.

If the coffee machine is already at operating temperature, rinsing will not take place.

If you do not touch any sensor control or run any maintenance programmes, the display will switch itself off after approx. 7 minutes to save energy. The *OK* sensor control will flash on and off as long as the coffee machine is switched on.

- Touch one of the sensor controls to wake the coffee machine up again to make a drink.

Switching the coffee machine off

- Touch the On/Off button .

If coffee has been dispensed, the coffee machine will rinse the pipework automatically before switching off.

Switching off for longer periods of time

If the coffee machine is not going to be used for a while, e.g. if you are going on holiday, remember to do the following:

- Empty the drip tray, the waste container and the water container.
- Clean all parts thoroughly, including the brew unit.
- If necessary, switch off the coffee machine and unplug it to disconnect it from the power supply.

Cup heating



(depending on model: CM 6360,
CM 6560)

Cups should always be pre-heated to allow the flavour of the coffee to develop and its temperature to be retained.

You can pre-heat cups or glasses on the cup heating surface on the top of the coffee machine.

When the cup heating surface is activated, the cup rest will be heated continually until the coffee machine is switched off.

Switching the cup heater on or off

- Touch the  sensor control.
- Select Settings  | Cup heating.
- Select the option you want and confirm with **OK**.

The setting is now saved.

Pre-heating cups

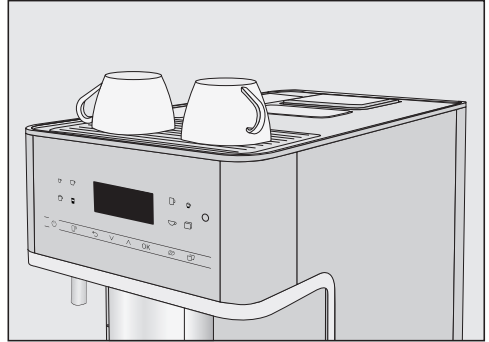

- Arrange the cups or glasses on the cup heating surface on the top of the coffee machine.

Adjusting the central spout to the correct cup height

You can adjust the central spout to suit the height of the cup you are using so that the coffee or espresso will not cool down as quickly and the crema will have a better consistency.

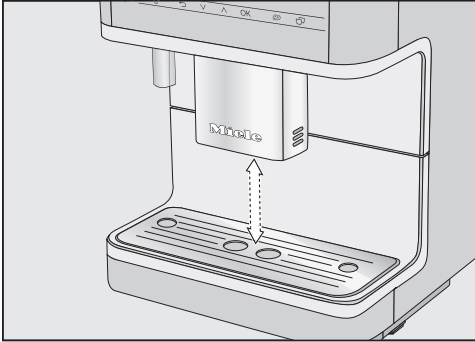

- Pull the central spout down until it is at the same level as the rim of the cup.
Alternatively, push the central spout up until there is enough room to fit a larger cup or mug underneath.

Making drinks

 Danger of burning and scalding on the dispensing spouts.

The liquids and steam dispensed are very hot and can cause scalding.

Keep well away from the area underneath the spouts when hot liquids and steam are being dispensed.

Do not touch hot components.

Making coffee with and without milk

The following drinks can be made:

- **Ristretto** is a strong, concentrated espresso. It is prepared with the same amount of coffee as for an espresso but with a lot less water.
- **Espresso** is a strong aromatic coffee with a thick hazelnut brown coloured froth – known as the crema – on top. We recommend using espresso-roasted coffee beans to make an espresso.
- **Coffee** differs from espresso by the increased amount of water and the roast of the beans. We recommend using coffee beans of the correct roast to make the coffee.
- **Long coffee** is a coffee with considerably more water.
- **Cappuccino** consists of approx. 2 thirds milk froth and 1 third espresso.
- **Latte macchiato** consists of 1 third each of hot milk, milk froth and espresso.

- **Caffè latte** consists of espresso and hot milk.
- **Cappuccino italiano** has the same proportions of milk froth and espresso as a cappuccino. The difference is that the espresso is added first and then the milk froth.
- **Espresso macchiato** is an espresso with a small amount of milk froth on top.
- **Flat white** is a special variety of cappuccino that contains significantly more espresso than milk froth for an intensive coffee aroma.
- **Café au lait** is a French style of coffee consisting of coffee and milk froth. Café au lait is usually served in a bowl.

Hot milk or **milk froth** can also be made.

Milk preparation

Milk or milk alternatives (e.g. soya milk) containing added sugar can clog up the milk pipe and the rest of the milk pipework. Residues from unsuitable liquids can interfere with milk preparation.

The milk used must not contain any additives.

Only use pasteurised cow's milk.

If you have not made any milk drinks for a while, rinse the milk pipework thoroughly before making the first drink.

Tip: Using cold cow's milk ($< 10\text{ }^{\circ}\text{C}$) with a protein content of at least 3 % will produce the perfect milk froth. You can select milk with a fat content according to preference. With whole milk (at least 3.5 % fat), the milk froth will be slightly creamier than with low-fat milk.

You can prepare milk with the milk siphon or milk flask (included in the scope of delivery depending on the model).

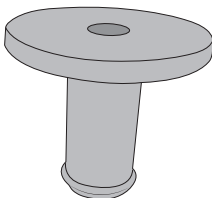

There is one connecting piece included in the scope of delivery which can be inserted either into the milk siphon or into the milk flask lid.

The appliance is supplied with the connecting piece either enclosed

separately or inserted into the milk flask lid (depending on the model). The connecting piece is easy to push out from the inside of the milk flask lid.

The “seam” on the milk pipework and on the central spout makes it easier to assemble it correctly.

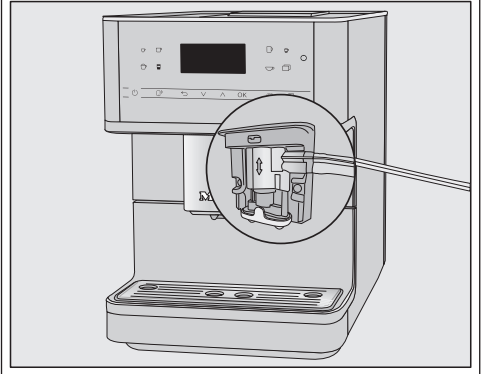

Using a milk carton with the milk siphon

The milk siphon enables you to prepare milk directly from milk cartons or other suitable containers.

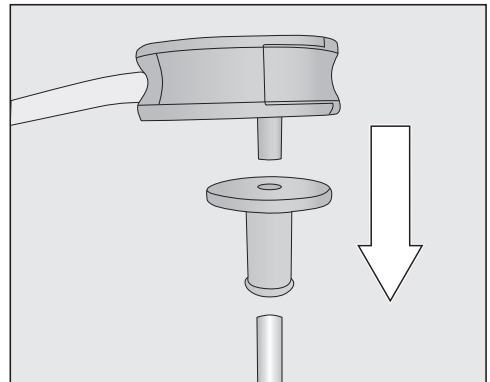

Making drinks

- First insert the connecting piece onto the long stainless steel tube. Make sure that the slanted end of the stainless steel tube is pointing downwards.
- Attach the rinse valve to the connecting piece.

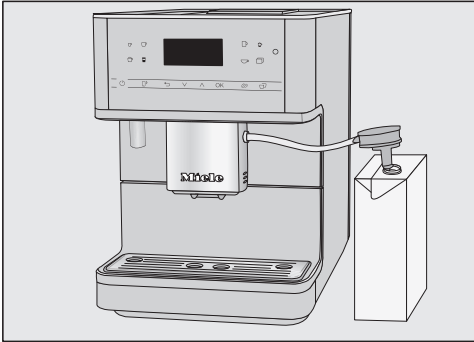

- Open the milk carton and dip the milk siphon into the milk. Place the milk carton to the right next to the coffee machine.
- Connect the milk pipework to the aperture in the central spout.

Tip: Rinse the milk siphon under running water after use.

The milk flask

depending on model: CM 6360,
CM 6560

Milk is **not** cooled in the milk flask.
For high-quality milk froth, always
use cold milk (< 10 °C).

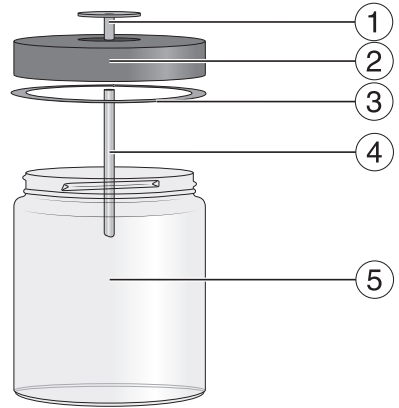

- ① Connecting piece
- ② Lid
- ③ Sealing ring
- ④ Stainless steel tube
- ⑤ Glass

Using the milk flask

- Insert the connecting piece into the lid from above until everything sits flush.
- Connect the stainless steel tube to the inside of the lid. Make sure that the slanted end of the stainless steel tube is pointing downwards.
- Fill the milk flask with milk up to a maximum of 2 cm below the rim. Seal the milk flask with the lid.

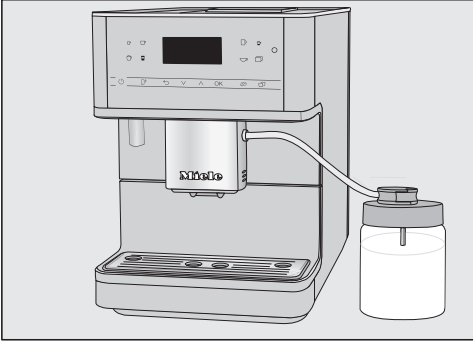

- Place the milk flask to the right next to the coffee machine.
- Attach the milk pipework rinse valve to the milk flask lid.
- Connect the milk flask to the coffee machine by attaching the milk pipework to the aperture in the central spout.

If you have not made any milk drinks for a while, rinse the milk pipework thoroughly before making the first drink.

Making a coffee



- Place a cup under the central spout.

- Select a drink: touch the sensor control for the drink you want. Or select a drink from the Further | Other drinks menu (☐ sensor control).

Dispensing will start.

Cancelling a drink

- Touch the lit orange symbol on the control panel again.

When preparing drinks with several ingredients (e.g. latte macchiato) you can cancel each of the individual components prematurely.

- Touch **OK** when **Stop** appears in the display.

DoubleShot

Select the DoubleShot  function if you would like a particularly strong and aromatic coffee. In this case, more coffee beans will be ground and brewed halfway through the brewing process. The shorter extraction time means that fewer unwanted aromas and bitter compounds will be released.

Making a DoubleShot of coffee

- Press the  sensor control immediately before or after you start making a drink.

Dispensing starts and the  sensor control lights up. 2 portions of coffee beans will be ground and brewed.

Making 2 portions (☐ sensor control)

You can dispense 2 portions of a drink into 1 large cup or into 2 cups at the same time.

Making drinks



Each portion of coffee will be brewed and dispensed individually. You can follow the process in the display.

Cancelling a drink

- Touch the  sensor control.

- Place a cup under each of the coffee dispensers in the central spout.
- Press the  sensor control immediately before or after you start making a drink.

The  sensor control lights up.

The dispensing starts and 2 portions of the desired drink will be dispensed.

Coffee pot

You can make several cups of coffee one after the other automatically with the Coffee pot function (maximum of 1 litre).

The drinks menu is displayed.

Tip: Make sure that the bean and water containers have enough beans and water inside them before starting the Coffee pot function.

- Place a sufficiently large container under the central spout.
- Touch the  sensor control.
- Select Further | Other drinks | Coffee pot and confirm with OK.
- Select the number of cups you want (3 to 8).

Making coffee drinks with ground coffee

To make drinks using ready ground coffee, add a portion of ground coffee to the ground coffee chute.

This allows you to make a decaffeinated coffee if the bean container is already filled with regular coffee beans, for example.

Only **1** portion of coffee or espresso can be made at a time when using ready ground coffee.

Place a **maximum of 12 g** in the ground coffee chute.
If too much ground coffee is added, the brew unit will not be able to process the coffee.

Adding ground coffee

The coffee machine will use all the ground coffee which has been added to the chute to make the next coffee.

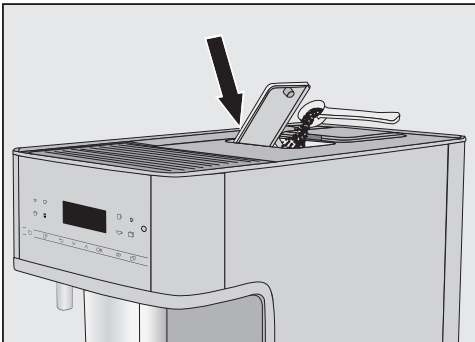

- Open the ground coffee chute.

Place a maximum of **12 g** in the ground coffee chute.

- Add ready ground coffee to the chute.

- Close the coffee chute.

Making coffee with ground coffee

The following appears in the display: Use ground coffee?

- Select **Yes** and confirm with **OK**.

You can now select which type of drink you would like to make with ground coffee.

- Place a cup under the central spout.
- Select a drink.

The coffee will now be made.

If you select **No** and confirm this with **OK**, the ground coffee will be disposed of in the waste container without being brewed. The appliance rinses.

Making drinks

Tea

The coffee machine is not intended for commercial or scientific purposes. Temperatures given are approximate and can vary according to ambient conditions.

To make tea, you can select from the following options:

- **Japanese tea** is a high-quality green tea which boasts a fine, fresh, “green” taste.
Dispensed temperature: approx. 60 °C, brewing time: approx. 1,5 minutes
- **White tea** is a green tea where only the young buds of the tea plant are used and processed very gently. White tea has a particularly mild taste.
Dispensed temperature: approx. 63 °C, brewing time: approx. 2 minutes
- **Green tea** gets its green colour from the leaves of the tea plant. The tea leaves are either roasted or steamed depending on the region. Green tea can be infused multiple times.
Dispensed temperature: approx. 74 °C, brewing time: approx. 2,5 minutes
- **Black tea** gets its dark colour and characteristic taste from the fermentation of tea leaves. Black tea can be enjoyed with a little lemon or milk.
Dispensed temperature: approx. 78 °C, brewing time: approx. 3 minutes

- **Herbal tea** is an aromatic infusion drink made up of dried leaves or fresh parts of plants.
Dispensed temperature: approx. 78 °C, brewing time: approx. 8 minutes
- **Fruit tea** is made from dried pieces of fruit and/or parts of plants, e.g. rose hip. The taste of the drink varies according to which plants are used and how they are blended. Lots of fruit teas are also flavoured.
Dispensed temperature: approx. 78 °C, brewing time: approx. 8 minutes

The type of tea determines the preset temperature.

The respective dispensing temperatures are the ones that Miele recommends for making the types of tea concerned.

You can adjust the dispensing temperatures used for the individual teas by customising the brewing temperature (see “Parameters – Brewing temperature”). A temperature increment of approximately 2 °C makes a noticeable difference.

Whether you use loose tea leaves, blended tea or tea bags depends on your own personal preference.

Follow the instructions for making tea on the tea packaging.

The amount of tea required varies from one type of tea to another. Always follow the recommendations of the manufacturer on the packaging or of the retailer. You can adjust the amount

of water according to the type of tea and the size of the cup (see “Portion size”).

TeaTimer

You can use the TeaTimer function to start a minute minder when making tea. There is a preset brewing time for the type of tea selected. You can adjust the preset brewing time (up to a maximum of 14:59 minutes). The changed brewing time is saved.



While the brewing time is counting down, you can continue to use the coffee machine as normal. After the brewing time has elapsed, a buzzer will sound and the  symbol will flash.

Setting the TeaTimer

You can choose between the following options:

- **Automatic:** The TeaTimer starts automatically once the water has been dispensed.
- **Manual:** Once the water has been dispensed, you have the option of starting the TeaTimer.

The drinks menu is displayed.

- Touch the  sensor.
- Select Settings  | TeaTimer.
- Select the setting you want and confirm with OK.

Making tea

Touch the  sensor control to access the menu containing the various types of tea.

The drinks menu is displayed.

- Pour loose tea into a tea filter or similar, or take a tea bag from the packet.
- Place the tea filter or the tea bag in the tea cup.

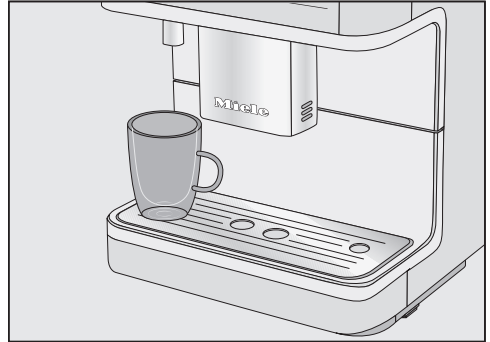

- Place the cup under the hot water spout.
- Touch the  sensor control.
- Select the type of tea you want and confirm your choice with OK.

Hot water will be dispensed into the cup.

If the TeaTimer | Automatic setting has been selected, the minute minder for the brewing time will start running once the water has been dispensed.

Starting the TeaTimer manually

TeaTimer appears in the display as soon as the water has been dispensed.

- Touch OK.

The editor will open with a suggested time.

- Change the brewing time if required and confirm with OK.

Making drinks

After the brewing time has elapsed, a buzzer will sound and the  symbol will flash.

- Remove the tea filter or tea bag when the desired brewing time has elapsed.

Dispensing warm or hot water

 Danger of burning and scalding on the hot water spout. The liquids and steam dispensed are very hot and can cause scalding.

Keep well away from the area underneath the spouts when hot liquids and steam are being dispensed.

Do not touch hot components.

You can choose between the following options:

- Hot water at approx. 80 °C
- Warm water at approx. 60 °C

The drinks menu is displayed.



- Place a suitable container underneath the hot water spout.
- Touch the  sensor control.
- Select **Other drinks** and choose between warm or hot water.
- Confirm with **OK**.

Dispensing will start.

The Expert mode function allows you to change the portion size while the drink is being made. The setting will **not** be saved and will only apply for the current drink.

Switching Expert mode on and off

The drinks menu is displayed.



- Touch the  sensor.
- Select Settings  | Expert mode.
- Select the option you want.
- Confirm with *OK*.

The setting is now saved.

Expert mode: changing the portion size

The drinks menu is displayed.

The portion size can only be changed when the respective ingredient is being processed while the drink is being made.

If you select DoubleShot  or 2 portions , Expert mode cannot be used to change the portion size.

- Select a drink.

Dispensing will start. You can adjust the portion size while it is being dispensed, e.g. individually change the amount of hot milk, milk froth and espresso for a latte macchiato.

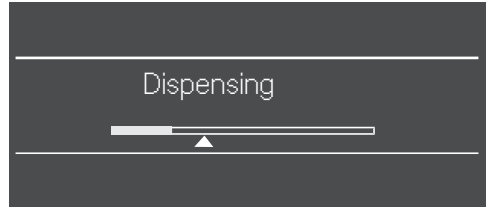

- Use the \wedge arrow buttons and the \vee indicator (small triangle) to adjust as required.

Grinder setting

The grinder setting determines the contact time between the ground coffee and the water, known as the extraction time. When the ideal grinder setting is selected, the machine dispenses a perfect cup of coffee with a fine, hazelnut-brown crema.

The grinder setting you select will be used for all coffee drinks.

There are various ways to tell whether the coffee grinder is set correctly.

The grinder setting is **too coarse** if the coffee or espresso is watery and tastes acidic. The crema is very pale.

Set a finer grinder setting.

The grinder setting is **too fine** if the coffee or espresso tastes too bitter and the crema is dark brown.

Set a coarser grinder setting.

Only adjust the grinder one setting at a time.

Start making a new drink to grind beans again. Adjust the grinder setting one setting at a time again.

Adjusting the fineness of grind

- Open the appliance door.

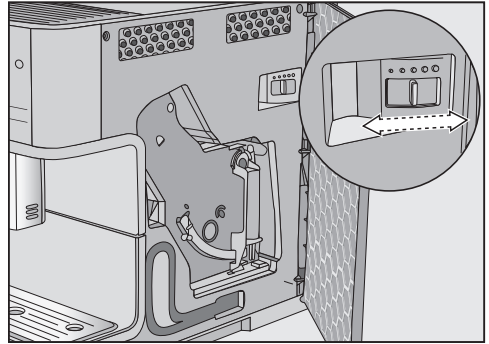

- Push the slide control a maximum of one setting to the left (for finer grinding) or to the right (for coarser grinding).
- Close the appliance door.
- Empty the drip tray **and** the waste container.
- Make one cup of coffee.

Adjust the grinder setting again, if required.

The altered grinder setting will not be used until after the second coffee has been dispensed.

Displaying and changing parameters

You can change the portion size for all drinks.

In addition, you set the quantity of coffee, the brewing temperature and pre-brewing for each coffee drink individually.

- Touch  and then select Parameters.
- Select a drink and confirm with *OK*.

The parameters that can be changed for this drink are displayed.

Once you have selected a drink, the current settings for the following appear: Amount of coffee, Brew temperature and Pre-brewing.

The Portion size menu option is displayed in the first line. If you select Portion size and confirm with *OK*, the drink will be dispensed immediately.

- Select the parameter you want.
- Change the setting as required and confirm with *OK*.

The setting is now saved.

Portion size

The flavour of the coffee produced depends not only on the type of coffee, but also on the amount of water used.

You can programme the amount of water for all drinks (apart from the Coffee pot function) to suit the size of your cups and/or the type of coffee you are using.

For coffee drinks that use milk, you can not only set the amount of espresso or coffee but also the amount of milk or milk froth to be dispensed with these drinks.

A maximum portion size can be programmed for each type of drink. Dispensing stops once this has been reached. The maximum possible portion size is then saved by the machine for this type of drink.

If the water container becomes empty whilst making a drink, the coffee machine will stop programming the portion size. The portion size will **not** be saved.

Changing the portion size

- Place a cup under the central spout.
- Select Portion size and confirm with *OK*.

The desired drink will be made and *Save* will appear in the display.

- When the cup is filled up to the level you want, touch *OK*.

If you want to change the portion size for coffee made with milk, the ingredients which make up the drink will be saved one after the other while the drink is being made.

- When the quantity for each ingredient reaches the level you want, touch *OK*.

The programmed portion size will now be dispensed every time that particular drink is selected.

Parameters

Tip: For the drinks pictured on the control panel, you can change the portion size by pressing and holding the button down while the drink is being dispensed. To do this, keep the drinks sensor pressed until the machine starts dispensing. During dispensing, *Save* appears in the display.

Quantity of coffee

The coffee machine can grind and brew 6-14 g of coffee beans per cup. The greater the quantity, the stronger the coffee.

The quantity of coffee is **too low** if the espresso or coffee lacks body.

Increase the quantity of coffee so that more ground coffee is brewed.

The quantity of coffee is **too high** if the espresso or coffee tastes bitter.

Decrease the quantity of coffee so that less ground coffee is brewed.

Brewing temperature

The brewing temperature must be adapted to the beans you are using and how they are roasted. It also varies depending on whether you are making espresso or coffee.

Some bean types are sensitive to high brewing temperatures, resulting in an impaired taste. If your coffee tastes bitter, the brewing temperature you have selected might be too high.

Espresso is usually brewed at higher temperatures.

Pre-brewing the ground coffee

When the pre-brewing function is turned on, the ground coffee is first moistened with a little hot water. The ground coffee swells a little. The remaining amount of water is then pressed through the moistened coffee grounds shortly after. If your coffee tastes too bland and you want to add some spice and richness, try the “Pre-brewing” function. Depending on the type of coffee used, pre-brewing can intensify the taste.

You can set a short or long duration for pre-brewing or turn the “Pre-brewing” function off completely.

Tip: We particularly recommend using the “Pre-brewing” function to make coffee.

In addition to the Miele drinks menu (Miele profile), you can create individual profiles to cater for different tastes and preferences.

Within the profile, you can adjust the portion sizes and parameters individually for all drinks.

The name of the current profile is shown in the top left of the display.

Creating profiles

- Touch the  sensor control and select Profiles. Confirm with *OK*.

The Profiles menu opens.

- Select Create profile.

The editor will open in the display.

Entering a name

Letters and numbers are entered using the \wedge and \vee arrow buttons. You can choose between upper and lower case letters.

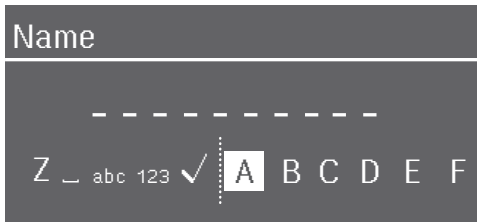

- To enter a character, highlight the one you want and confirm your choice with *OK*.
- To delete a character, touch the \leftarrow sensor control.
- To save the name, select the tick \checkmark and confirm with *OK*.
- Enter the profile name.

Tip: It is best to select short names.

The profile has been created.

Making drinks stored in a profile

- Touch the  sensor control and select Profiles. Confirm with *OK*.
- Select the profile you want.
- Select the drink you want.

The machine starts dispensing the drink.

Changing drinks within a profile

When you change the parameters of a drink within a profile, these settings only apply to the active profile. The settings for drinks contained within other profiles remain unaffected.

- Select the profile you want.

The name of the selected profile is shown in the top left of the display.

You can now change the drinks individually.

Editing profiles

Once you have created at least one profile, you can rename, delete or set when the profile should change in the Profiles menu.

- Select Edit and confirm with *OK*.

You can now edit the selected profile.

Setting when the profile should change

You can choose between the following options:

Profiles

- **Manual:** The selected profile will remain active until you select another one.
 - **After each use:** The machine will revert to the Miele profile whenever a drink is dispensed.
 - **When switched on:** The Miele profile will be displayed whenever the coffee machine is switched on, regardless of which profile was selected before the machine was last switched off.
- Select **Change profile** and confirm with **OK**.
 - Select the option you want and confirm with **OK**.

Changing the name

This option can only be selected if a profile has been allocated in addition to the Miele standard profile.

- Select **Change name** and confirm with **OK**.
- Change the name as required (see also “Creating profiles”).

Deleting a profile

This option can only be selected if a profile has been allocated in addition to the Miele standard profile.

- Select **Delete profile** and confirm with **OK**.
- Select the profile you wish to delete.
- Select **Yes** and confirm with **OK**.

The profile will be deleted.

With MobileStart you can, for example, start making a drink via the Miele app.

You will only be able to use MobileStart if Miele@home has been set up for your coffee machine.

 **Danger of burning and scalding on the dispensing spouts.**

If liquids or steam are dispensed while the machine is unsupervised, persons may burn themselves if they place body parts under the central spout or touch hot components.

Ensure that no one, especially children, can be harmed if the machine is operated without supervision.

Milk is not cooled in the milk container. If you want to start making a drink with milk using the app, make sure that the milk is sufficiently cold (< 10 °C).

If the coffee machine is being operated manually, it cannot be operated via the app. Operation on the appliance takes precedence.

To start making drinks remotely, MobileStart must be activated. Make sure that the coffee machine is ready to use, for example check that the water container is sufficiently filled. Place a sufficiently large, empty cup under the central spout.

If you are making a drink with MobileStart, you will be notified of drink dispensing with acoustic and optical signals. These signals cannot be changed or switched off.

Switching MobileStart on and off

If you want to use MobileStart , the Remote control option must be switched on.

The drinks menu is displayed.



■ Touch the  sensor.

The  sensor lights up. You can now start making a drink via the app. Follow the prompts for doing this.

Settings

Displaying and changing Settings

The drinks menu is displayed.

- Touch the  sensor control.
- Select Settings  and touch *OK*.
- Select the menu option that you want to display or change.
- Confirm with *OK*.
- Change the setting as required and confirm with *OK*.

Some settings which can be found in the Settings menu are described in their separate sections in the operating instructions.

Language

You can select the language (and location variant of that language) for all display text.

Tip: If you select the wrong language by mistake, you can find the “Language” option again via the  symbol.

Timer: switch off after

If none of the sensors have been touched or no drink has been made, the coffee machine will switch itself off after 20 minutes to save energy.

You can change this to another time (can be set between 20 minutes and 9 hours).

TeaTimer

You can use the TeaTimer to start a minute minder when making tea (see “Making drinks – TeaTimer”).

Volume

You can set the volume of the buzzer and keypad tones (segment bar).

Display brightness

You can set the display brightness (segment bar).

Lighting

You can change the brightness of the lighting while the coffee machine is switched on or off.

You can also specify how long the lighting should stay on for when the machine is switched off (adjustable between 15 minutes and 9 hours).

Info (display information)

You can display the number of drinks dispensed so far and how many more can be dispensed until the maintenance programmes have to be run.

Altitude

If the coffee machine is installed at high altitudes, the lower air pressure will cause the water to boil at a lower temperature. You can set the local altitude of the machine to ensure that the correct temperatures are achieved.

Performance mode

You can select the appropriate performance mode for how you use your machine. Eco mode is set by default.

Eco mode

Eco mode is an energy-saving mode. The system does not heat up until someone starts making a drink.

Barista mode

This performance mode has been optimised for unadulterated coffee enjoyment. Users can enjoy coffee-based drinks without any delay as the coffee machine remains heated to the brewing temperature. This mode consumes more energy than Eco mode.

Latte mode

This performance mode has been optimised for preparing milk. Milk-based drinks can be prepared within a much shorter space of time. This mode consumes more energy than Eco mode and Barista mode.

Party mode

This Performance mode has been configured for the **occasional** intensive use of the coffee machine, e.g. for family get-togethers.

Clean the coffee machine thoroughly after intensive use, particularly the milk pipework. It may be necessary to descale the coffee machine and degrease the brew unit.

Please note the following information about Party mode:

- Cleaning status messages or cleaning prompts are suppressed and delayed until the machine is next switched on.

- The timer Switch off after is deactivated. The coffee machine switches off 6 hours after the last sensor was pressed.
- The cup light remains permanently switched on at the maximum brightness level for as long as the coffee machine stays switched on.

Water hardness

Programme the coffee machine to the water hardness level of your area so that it functions correctly and does not get damaged.

Contact your local water supplier to find out your local water hardness range if necessary.

If you are using bottled drinking water, e.g. mineral water, select settings according to the calcium content. The calcium content is specified on the label of the bottle in mg/l Ca^{2+} or ppm (mg Ca^{2+} /l).

Do not use carbonated water.

The hardness level is set to 21 °dH by default.

Settings

Water hardness		Calcium content mg/l Ca ²⁺ or ppm (mg Ca ²⁺ /l)	Setting s
°dH	mmol/l		
1	0.2	7	1
2	0.4	14	2
3	0.5	21	3
4	0.7	29	4
5	0.9	36	5
6	1.1	43	6
7	1.3	50	7
8	1.4	57	8
9	1.6	64	9
10	1.8	71	10
11	2.0	79	11
12	2.1	86	12
13	2.3	93	13
14	2.5	100	14
15	2.7	107	15
16	2.9	114	16
17	3.0	121	17
18	3.2	129	18
19	3.4	136	19
20	3.6	143	20
21	3.8	150	21
22	3.9	157	22
23	4.1	164	23
24	4.3	171	24
25	4.5	179	25
26	4.6	186	26
27	4.8	193	27
28	5.0	200	28
29	5.2	207	29

Water hardness		Calcium content mg/l Ca ²⁺ or ppm (mg Ca ²⁺ /l)	Setting s
°dH	mmol/l		
30	5.4	214	30
31	5.5	221	31
32	5.7	229	32
33	5.9	236	33
34	6.1	243	34
35	6.3	250	35
36	6.4	257	36
37–45	6.6–8.0	258–321	37–45
46–60	8.2–10.7	322–429	46–60
61–70	10.9–12.5	430–500	61–70

Tip: If your water hardness is >21 °dH (3.8 mmol/l), we recommend using bottled drinking water instead (< 150 mg/l Ca²⁺). This will mean your coffee machine will need to be descaled less often and there will be less impact on the environment because less descaler will be used.

System lock

You can lock the coffee machine to prevent it being used without your knowledge, by children, for example.

Temporarily deactivating the system lock

- Press and hold *OK* for 6 seconds.

The system lock is reactivated when the coffee machine is next switched off.

Miele@home

The following options may appear under Miele@home:

- **Set up**: This option only appears if the coffee machine has never been connected to a WiFi network or if the network configuration has been reset.
- **Deactivate*/Activate***: The settings for the WiFi network are retained, but the network is switched on or off.
- **Connection status***: Information about the WiFi connection is displayed. The symbols indicate the strength of the connection.
- **Set up again***: The settings for the current WiFi network will be reset. The WiFi connection will be set up from scratch.
- **Reset***: The WiFi is switched off and the settings for the current WiFi network will be reset.

The network configuration should be reset whenever the coffee machine is being disposed of or sold, or if a used coffee machine is being put into operation. This is the only way to ensure that all personal data has been removed and the previous owner will no longer be able to access the coffee machine.

* This menu option appears if Miele@home has been set up and the coffee machine has – where applicable – been connected to a WiFi network.

Remote control

The remote control option appears when the coffee machine is connected to a WiFi network.

You can change the coffee machine settings, for example, in the Miele app when remote control is switched on. To start making a drink via the app, MobileStart must be activated as well.

The remote control function is switched on by default.

RemoteUpdate

The RemoteUpdate menu option is only displayed and can only be selected if the requirements for using Miele@home have been met.

The RemoteUpdate function allows the software on your coffee machine to be updated. If an update is available for your coffee machine, it will automatically download it. Updates will not be installed automatically. They must be initiated manually.

If you do not install an update, you can continue to use your coffee machine in the usual way. However, Miele recommends installing updates.

Activating/deactivating

The RemoteUpdate function is activated by default. Available updates will be downloaded automatically but will only be installed if you initiate installation manually.

Deactivate RemoteUpdate if you do not want any updates to be downloaded automatically.

Settings

Running a RemoteUpdate

Information about the content and scope of an update will be provided in the Miele@mobile app.

A message will appear in your coffee machine display if a software update is available.

You can install the update immediately or postpone this until later. When the coffee machine is switched on again, you will be reminded about the update.

Deactivate RemoteUpdate if you do not want to install the update.

The update may take several minutes.

Please note the following information about the RemoteUpdate function:

- You will only receive a message when an update is available.
- Once an update has been installed, it cannot be undone.
- Do not switch the coffee machine off during the update. Otherwise, the update will be aborted and will not be installed.
- Some software updates can only be carried out by your Miele dealer.

Software version

The “Software version” menu option is intended for the your Miele dealer. You do not need this information for domestic use.

Showroom programme (Demo mode)

Do not activate this function for domestic use.

The Showroom programme | Demo mode function enables the coffee machine to be demonstrated in shops or showrooms. In this mode, the appliance lights up but no drinks can be prepared and no maintenance programmes can be run.

Factory defaults

You can reset the coffee machine to its factory default settings.

The following will **not** be reset:

- The number of drinks dispensed and the appliance status (No. of portions until appliance needs descaling, ... brew unit needs degreasing)
- Language
- Profiles and the associated drinks
- Miele@home



Risk to health due to inadequate cleaning

Heat and moisture inside the coffee machine can cause coffee residues to become mouldy and/or milk residues to go off and pose a risk to health.

Carefully clean the coffee machine regularly.

Overview of cleaning intervals

Recommended frequency	What do I have to clean / maintain?
Daily (at the end of the day)	Water container
	Waste container
	Drip tray and drip tray cover
	Milk flask
	Milk siphon
Once a week (more often if heavily soiled)	Central spout
	Milk pipework rinse valve and connecting pieces (with cleaning brush)
	Brew unit
	Interior area underneath the brew unit
	Casing (especially important immediately after descaling)
Once a month	Bean container and ground coffee chute
	Water container filter
	Steam jet (with cleaning brush)
When prompted	Degrease the brew unit (1 cleaning tablet)
	Descale the appliance (1 descaling tablet)

Cleaning and care

Cleaning by hand or in the dishwasher

The brew unit is **not** dishwasher safe.

Clean the brew unit by hand only under warm running water. **Do not use washing-up liquid or any other cleaning agent.**

The following components must be cleaned **by hand only**:

- Central spout stainless steel cover
- Brew unit
- Water container lid
- Bean container lid
- Lower panel

 Risk of damage as a result of excessively high dishwasher temperatures.

Components may be ruined (e.g. may become warped) if washed in a dishwasher at temperatures higher than 55 °C.

For dishwasher-safe components, always select dishwasher programmes with a maximum temperature of 55 °C.

Contact with natural dyes such as those found in carrots, tomatoes and ketchup may discolour the plastic parts in the dishwasher. This discolouration does not affect the stability of the parts.

The following components are **dishwasher safe**:

- Drip tray and lid
- Drip tray cover
- Waste container
- Water container
- Central spout (without stainless steel cover)
- Milk pipework with rinse valve
- Milk siphon
- Milk flask with lid (included depending on model)

 Danger of burning and scalding on hot components or by hot liquids. Components can become very hot during operation. Touching hot components can cause burning. The liquids and steam dispensed are very hot and can cause scalding. Keep well away from the area underneath the spouts when hot liquids and steam are being dispensed. Always allow the coffee machine to cool down before cleaning it. Please be aware that water in the drip tray can also be very hot.

 Risk of damage due to moisture ingress. The steam from a steam cleaning appliance could reach live electrical components and cause a short circuit. Do not use a steam cleaner to clean the coffee machine.

It is important to clean the machine regularly, as the used coffee grounds will soon go mouldy. Milk residues can go off and can block the milk pipework.

Unsuitable cleaning agents

Contact with unsuitable cleaning agents can alter or discolour the external surfaces. All surfaces are susceptible to scratching. Remove all cleaning agent residues immediately. To protect the machine and surrounding surfaces from damage, make sure you remove any spillages or splashes of descaler immediately.

To avoid damaging the surfaces, do not use:

- Cleaning agents containing soda, ammonia, acids or chlorides
- Solvent-based cleaning agents
- Cleaning agents containing descaling agents (unsuitable for cleaning the casing)
- Stainless steel cleaners
- Dishwasher cleaning agents (unsuitable for cleaning the casing)
- Glass cleaning agents
- Cleaning agents for ceramic glass hobs
- Oven cleaner
- Abrasive cleaning agents, e.g. powder cleaners and cream cleaners
- Hard, abrasive sponges, e.g. pot scourers, brushes or sponges which have been previously used with abrasive cleaning agents
- Eraser stain remover blocks
- Sharp metal scrapers
- Steel wool or stainless steel wire scourers

Cleaning and care

Drip tray and waste container

Clean the drip tray and waste container **every day** to avoid unpleasant smells and mildew.

The waste container is located in the drip tray. Water from rinsing also collects in the waste container.

A prompt will appear in the coffee machine display when the drip tray and/or the waste container is full and needs to be emptied. Empty the drip tray **and** the waste container.



Danger of burning!

If the rinsing process has just finished, wait a while before removing the drip tray from the coffee machine. The water used for rinsing will continue to run out of the coffee spouts for a while.

Remove the drip tray and the waste container while the coffee machine is switched on. Otherwise the message Empty and refit the drip tray and the waste container will appear in the display even though the drip tray and/or the waste container are not filled to the maximum level.

- Push the central spout up as far as it will go.

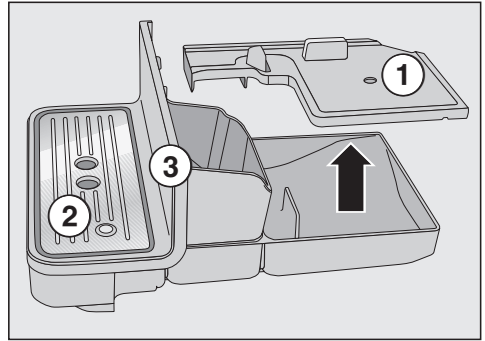

- Pull the drip tray carefully out of the coffee machine. Take the lid ① off.
- Empty the drip tray **and** the waste container.
- Remove the drip tray cover ② and lower panel ③.
- Clean all parts thoroughly.

Clean the lower panel by hand only using hot water, a little washing-up liquid and a soft cloth. All other parts are dishwasher-safe.

- Clean the inside of the appliance underneath the drip tray.
- Reassemble all parts and place the drip tray back in the coffee machine.

Make sure the drip tray has been pushed right into the appliance as far as it will go.

Cleaning the drip tray cover

- Remove the drip tray cover.
- The drip tray cover can be cleaned in the dishwasher, or by hand using warm water and a little washing-up liquid.
- Dry the drip tray.

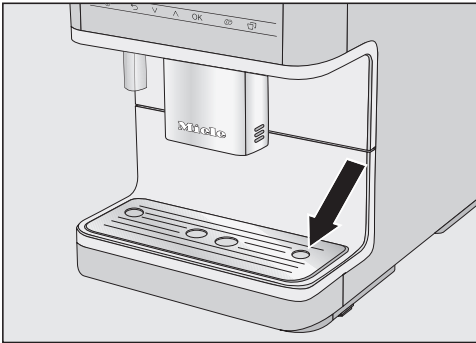

- Refit the drip tray. Make sure that the drip tray cover is correctly fitted (see picture).

Water container

Clean the water container lid **by hand only** using warm water and a little washing-up liquid.

Clean the water container every day. You can clean the water container in the dishwasher once a week.

- Press on the mark on the water container lid.
- Pull the water container up by the lid to remove it.

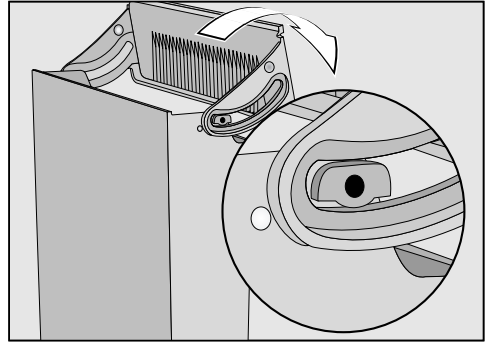

- Remove the lid from the container and wash it by hand.
- The water container can be cleaned in the dishwasher, or by hand using hot water and a little washing-up liquid. After cleaning, dry the water container.
- Carefully clean and dry the surface the water container sits on, taking special care to clean the recesses properly.
- Reassemble the water container.

Make sure that the valve, the underside of the water container and the surface the water container sits on are clean. Otherwise the water container will not sit correctly.

Cleaning and care

Removing and cleaning the water container filter

Clean the water container filter once a month.

The water container filter is located under the water container.

- Remove the water container.

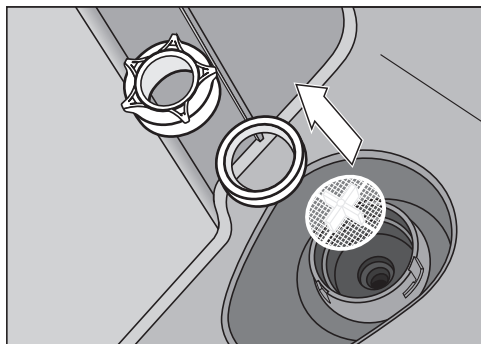

- Unscrew the cap. Remove the sealing ring and the filter.
- Rinse all parts carefully under running water.
- Then replace the water container filter (with the cross facing upwards) and then the sealing ring. Finally screw the cap back on tightly.
- Replace the water container.

Dismantling and cleaning the central spout

Clean the central spout's stainless steel cover **by hand only**, using warm water and a little washing-up liquid.

All other parts are dishwasher-safe.

- Use the supplied cleaning brush for parts that are difficult to reach, e.g. in the dispensing unit.
- Stubborn soiling is easier to clean if you soak the individual components overnight in water and washing-up liquid. Rinse the components under running water afterwards.

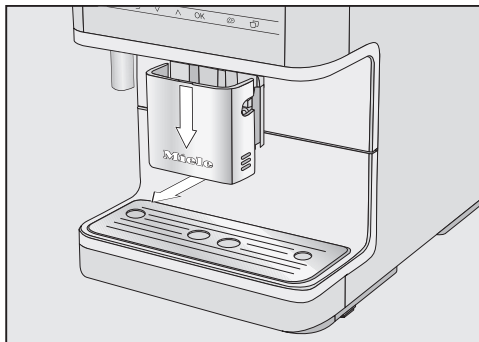

- Push the central spout right down and remove the stainless steel cover by pulling it off towards you.

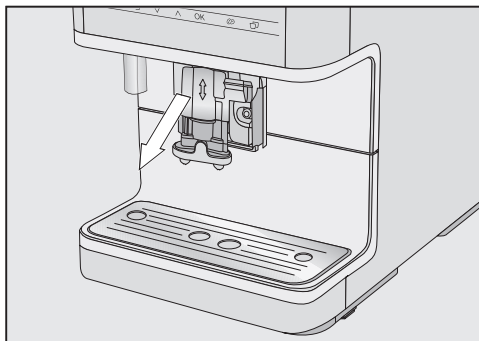

- Remove the dispensing unit to the front.

Cleaning and care

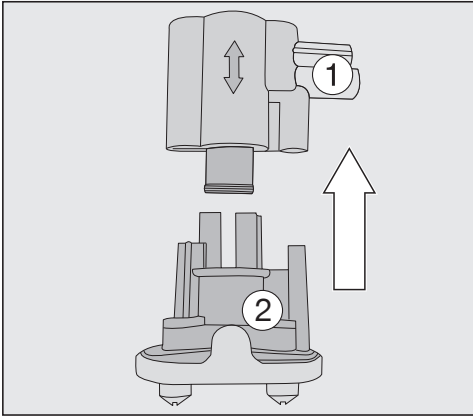

- Pull off the upper silicone section with the aperture for the milk pipework ①.

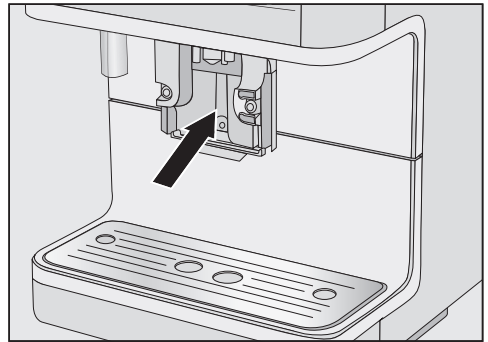

- Clean the surfaces of the central spout with a damp cloth.

To effectively remove coffee deposits, clean the coffee pipework with the cleaning brush once a month.

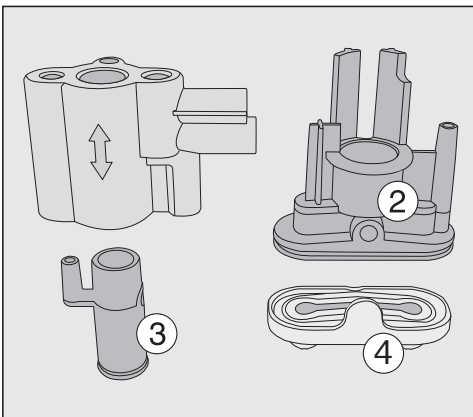

- The grey silicone section contains a black, cylindrical component ②. Pull out the black component.
- Remove the dispensing spouts ③.
- Clean all parts thoroughly.

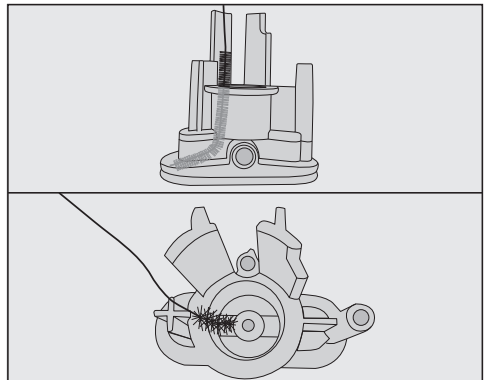

- Angle the cleaning brush slightly and clean both spouts from above and below.

Reassembling the central spout

The dispensing unit is easier to reassemble if the individual parts are dampened with water.

- Fit the dispensing unit back together. Push the spouts ③ firmly all the way round so that the dispensing unit is firmly seated in the groove.

Cleaning and care

- Refit the dispensing unit onto the central spout.
- Replace the stainless steel cover and connect the milk pipework if required.

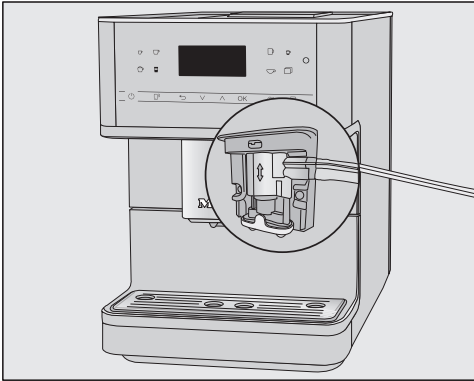

Tip: The “seam” on the milk pipework and on the central spout makes it easier to assemble.

Cleaning the steam jet

Clean the steam jet once a month.

- Push the central spout right down and remove the stainless steel cover by pulling it off towards you.
- Remove the dispensing unit to the front.

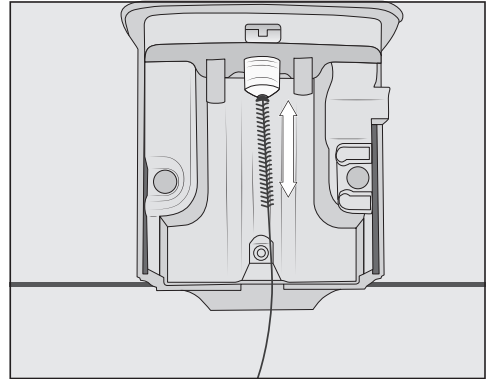

Push the cleaning brush a max. of 1 cm into the steam jet.

- Clean the steam jet with the cleaning brush.
- Push the dispensing unit back into the central spout and replace the stainless steel cover.

Cleaning the milk pipework and rinse valve

Risk of damage due to incorrect cleaning.

The silicone plug can be damaged by pointed objects, e.g. also the cleaning brush, and stop working.

Do not use pointed objects, e.g. a needle, for cleaning.

Only clean the silicone plug under running water and/or in the dishwasher. **Do not use** the cleaning brush supplied with the appliance.

Clean the rinse valve and milk pipework once a week.

Cleaning and care

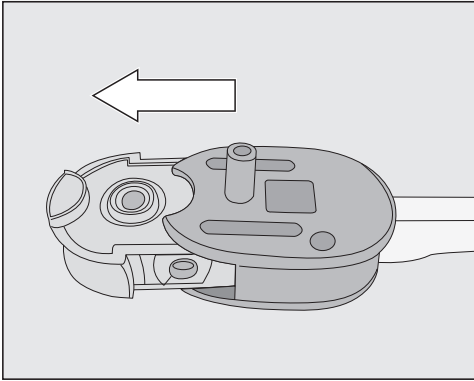

- Pull the silicone plug out of the rinse valve body.
- Rinse the silicone plug under running water before placing the component in the dishwasher.

Risk of damage to the silicone plug
Be sure to remove the silicone plug before cleaning the rinse valve body with a cleaning brush or similar utensil.

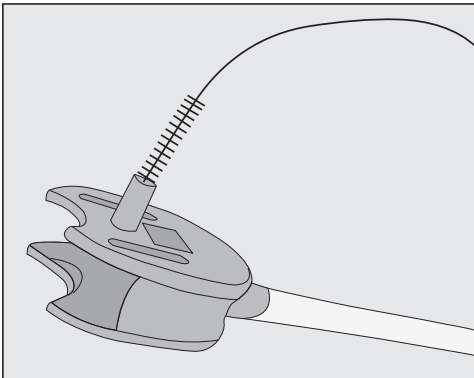

- Use the brush to clean the rinse valve body under running water to remove any milk residues.

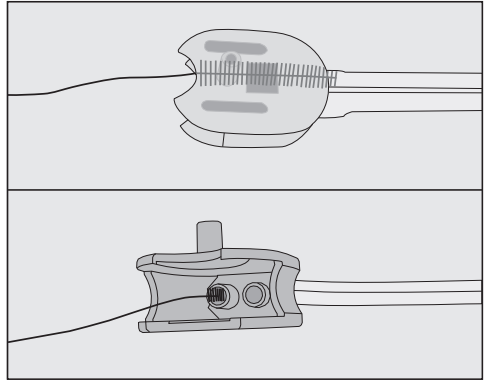

- Clean also the hose connections in the rinse valve body. To do this, insert the cleaning brush into both openings and move the brush back and forth.

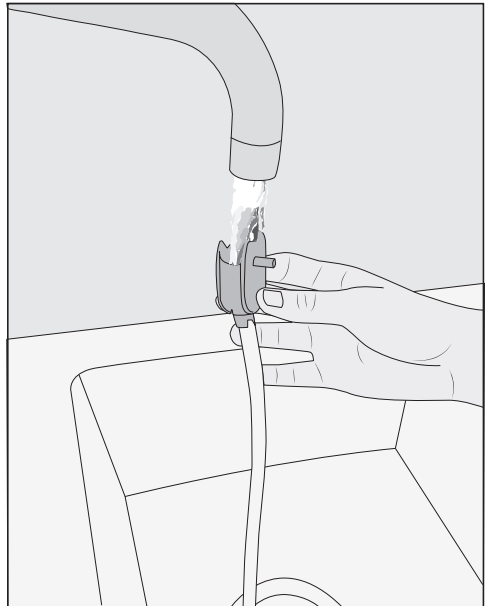

- Rinse the milk pipework and the rinse valve body under running water.
- Clean all components in a dishwasher.

Cleaning and care

Tip: Alternatively, you can soak the individual components overnight in water and washing-up liquid. Rinse the components under running water afterwards.

- Reassemble the rinse valve.

Cleaning the milk siphon

Clean the milk siphon every day.

- Rinse the milk siphon under running water.
- Remove the connecting piece from the stainless steel tube.
- Clean the individual components in a dishwasher.

Tip: Alternatively, you can soak the individual components overnight in water and washing-up liquid. Rinse the components under running water afterwards.

Cleaning the milk flask

Clean the milk flask every day in a dishwasher or by hand using warm water and a little washing-up liquid.

- Unscrew the lid from the milk flask and remove the stainless steel tube.
- Place all milk flask components in a dishwasher.

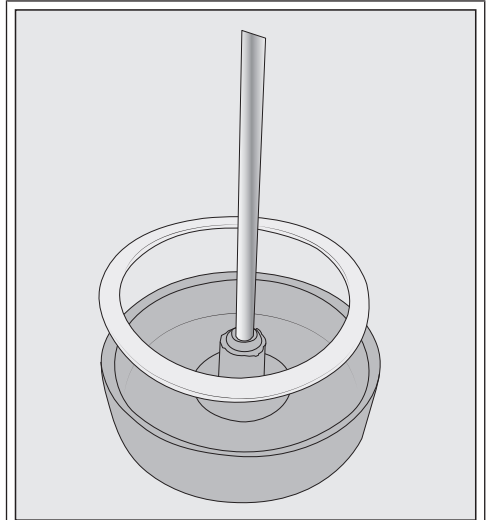

If necessary, you can remove the connecting piece and sealing ring from the milk flask lid. Once you have removed the stainless steel tube, the connecting piece is easy to push out from the inside of the lid. Clean the individual components in a dishwasher.

Bean container and ground coffee chute

 **Danger of injury from the grinder!**
Switch off the coffee machine and disconnect it from the power supply before cleaning the bean container.

Coffee beans contain oils which can deposit on the walls of the bean container and hinder the flow of the beans. Therefore, clean the bean container regularly with a soft, dry cloth.

- Open the bean container.
- Remove any coffee beans.

- Clean the bean container with a soft, dry cloth.

The bean container can now be refilled.

If necessary, clean the ground coffee chute:

- Open the coffee chute and remove any ground coffee residue.

Tip: Use a vacuum cleaner to remove any coffee residues from the bean container and the ground coffee chute.

Cleaning the casing

If soiling is allowed to stay on for a long time or there is contact with unsuitable cleaning agents, surfaces can alter or discolour.

Remove any soiling immediately.

Ensure that any splashes of descaler are wiped up immediately.

- Switch the coffee machine off.
- Clean the appliance front with a clean soft sponge and a solution of warm water and washing-up liquid. Then wipe it all dry using a soft cloth.

Tip: You can also clean the appliance casing with the Miele all purpose microfibre cloth.

Opening the “Maintenance” menu

You can find the maintenance programmes in the Maintenance menu. Run the relevant maintenance programme when the prompt to do so appears in the display.

Tip: To save you having to empty the drip tray too often and to catch any splashes, you can place the a container under the central spout.

- Touch .

- Select Maintenance and confirm with OK.

You can now select a maintenance programme.

Rinse the appliance

If you have made a coffee drink, the coffee machine will rinse the coffee pipework automatically before switching off.

You can also start the Rinse the appliance function manually.

Rinsing the milk pipework

If you have not made any milk drinks for a while, rinse the milk pipework thoroughly before making the first drink.

- Touch .

- Select Maintenance | Rinse the milk pipework and confirm with OK.

Place rinsing valve in drip tray will appear on the display.

Cleaning and care

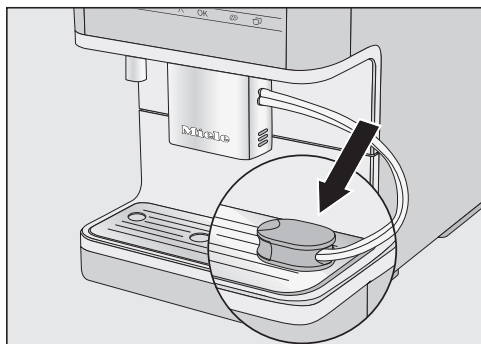

- Insert the rinse valve into the right aperture in the drip tray cover and confirm with **OK**.

The milk pipework will now be rinsed.

Cleaning the milk pipework using the maintenance programme

For optimal cleaning results, we recommend Miele Cleaning Agent for milk pipework. The Cleaning Agent for milk pipework has been specially developed for use with Miele coffee machines and prevents subsequent damage.

It is available to order from your Miele dealer.

The Clean milk pipework maintenance programme lasts for approx. 15 minutes.

- Touch **≡**.
- Select **Maintenance** and touch **OK**.

The cleaning process cannot be cancelled. It must be completed through to the end.

- Select **Clean milk pipework** and touch **OK**.

The process will start.

- Follow the instructions in the display.

Place milk pipe in cleaning agent will appear in the display.

Preparing the cleaning solution:

- Dissolve the cleaning agent in a container with 200 ml of lukewarm water. Stir the solution with a spoon until the powder has fully dissolved.

Carrying out the cleaning process:



- Place the container next to the machine and hang the milk tube in the solution. Make sure it is placed sufficiently far into the cleaning solution.
- Touch **OK**.
- Follow the further instructions given in the display.

The cleaning process is finished at the end of the rinsing cycle.

Tip: Flush any residual cleaning agent out of the milk pipework with running water.

Degreasing the brew unit

Depending on the natural oil content of the coffee used, the brew unit can become blocked quite quickly. It must be degreased regularly in order to ensure aromatic coffee and trouble-free operation of the coffee machine.

We recommend using Miele cleaning tablets to clean the brew unit. These have been specially developed for use with Miele coffee machines and prevent subsequent damage.

Miele cleaning tablets can be ordered from your Miele dealer.

The maintenance programme for degreasing the brew unit lasts for approx. 15 minutes.

After 200 portions have been dispensed, a message prompting you to degrease the brew unit will appear in the display.

- Confirm the message with *OK*.

This message will keep being displayed until the brew unit has been degreased.

Degreasing the brew unit

- Touch the  sensor control.
- Select Maintenance | Degrease the brew unit.
- Confirm with *OK*.

The maintenance programme will then start.

- Follow the instructions in the display.

Cleaning the brew unit and interior

Clean the brew unit **by hand only** with warm water. **Do not use any cleaning agents.** The moving parts of the brew unit are lubricated. Cleaning agents will damage the brew unit.

To ensure good tasting coffee and to prevent the formation of microbes in the machine, remove and clean the brew unit under running water once a week.

Rinse the brew unit by hand and clean inside the machine **will appear in the display.**

- Open the appliance door.

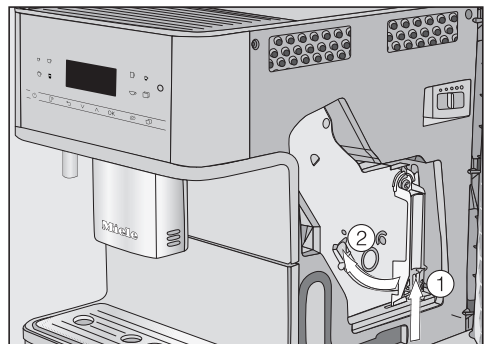

- Press and hold the button under the brew unit handle ① and, whilst doing so, turn the handle to the left ②.
- Carefully pull the brew unit out of the coffee machine.

When you have removed the brew unit, do **not** change the position of the handle on the brew unit.

- Clean the brew unit **by hand under warm running water** without using cleaning agent.

Cleaning and care

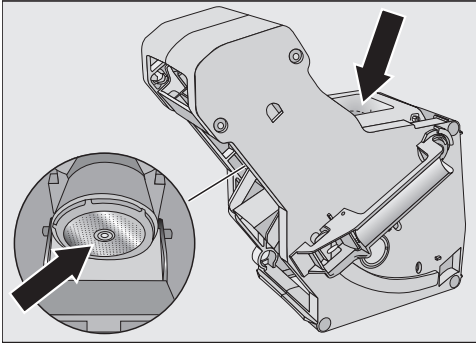

- Clean any coffee residue off the brew unit filter.
- Dry the funnel to prevent ground coffee sticking to it the next time a coffee is made.

Make sure you regularly remove any damp ground coffee residues to prevent the build-up of mould.

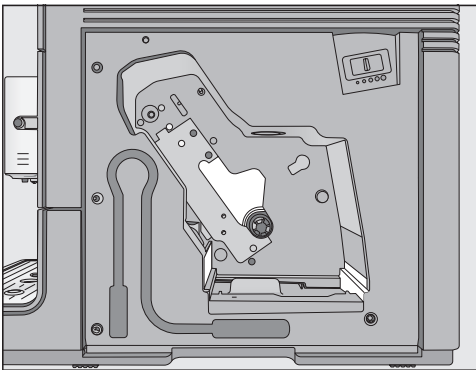

- Clean the inside of the coffee machine. Make sure that the areas highlighted in the illustration are cleaned especially well.

Tip: Use your vacuum cleaner to remove dry ground coffee residues.

Dropping a cleaning tablet into the brew unit

Insert brew unit containing tablet. Close the door. will appear in the display.

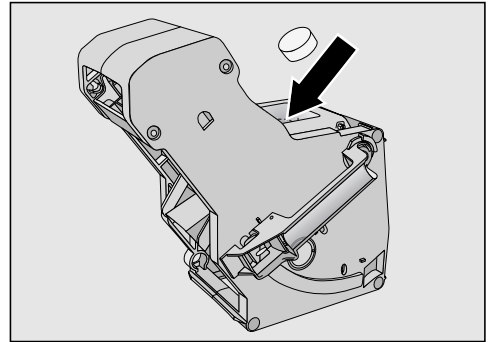

- Drop a cleaning tablet into the top of the brew unit (arrow).
- Push the brew unit containing the cleaning tablet back into the coffee machine.

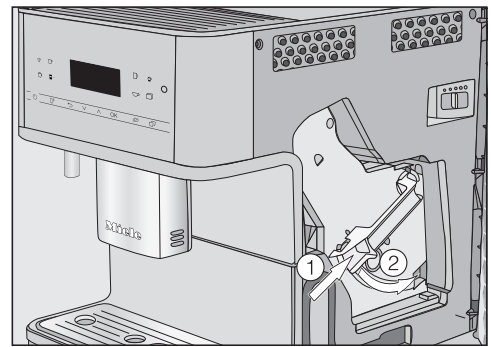

- Press the button under the handle of the brew unit ① and, whilst doing so, turn the handle to the right ②.
- Close the appliance door.
- Follow the further instructions given in the display.

The cleaning process is complete when the drinks menu appears.

Descaling the machine

Risk of damage from spilt descaling solution.

Sensitive surfaces and/or natural floors can suffer damage.

Wipe up any spillages of descaling agent immediately.

Limescale builds up in the coffee machine through use. How often the appliance needs to be descaled will depend on the water hardness level in your area. Limescale must be removed regularly.

The appliance will guide you through the descaling process. Various messages will appear in the display, e.g. you will be prompted to empty the drip tray or fill the water container.

Descaling **must be carried out**. The process takes approx. 15 minutes.

The coffee machine will give you plenty of warning when it needs to be descaled. As of this point, the display will indicate how many more drinks can be made before descaling becomes absolutely essential. This number is indicated whenever a drink is made.

■ Confirm the message with *OK*.

When the number of remaining portions reaches 0, the coffee machine will lock out.

You can switch the coffee machine off if you do not want to run the descaling programme at this point in time. You can not make any drinks until the machine has been descaled.

Descaling the appliance will appear on the display.

■ Confirm with *OK*.

The process will start.

■ Follow the instructions in the display.

If the operating temperature is too high for the descaling process, the coffee machine cools down. No separate message is shown on the display during the cooling phase.

When Fill the water container with lukewarm water and descaling agent up to the  symbol and replace it **appears** in the display, proceed as follows.

Make up the descaling solution

We recommend using Miele descaling tablets for optimum results.

These have been specially developed for use with Miele coffee machines and prevent subsequent damage.

Other descaling agents, which contain other acids besides citric acid and/or other undesirable substances, such as chlorides for example, could damage the coffee machine. Moreover, the descaling effect required could not be guaranteed if the descaling solution was not of the appropriate concentration.

Miele descaling tablets are available to order from your Miele dealer.

You will need **1** descaling tablet to descale the machine.

Cleaning and care

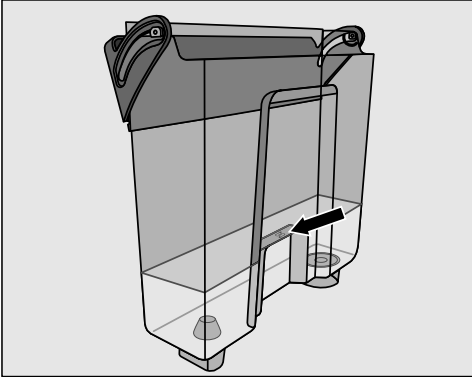

- Add 1 descaling tablet to the water container.
- Fill the water container to the S mark with lukewarm water.

Follow the instructions for the descaler mixing ratio carefully. Do not fill the water container with too much or too little water. Otherwise, the descaling process will be cancelled prematurely.

Carrying out descaling

- Reinsert the water container.
- Follow the additional instructions given in the display.

When Fill the water container up to the descaling symbol S and replace it. Close the door. **appears in the display:**

- Remove the water container and rinse it thoroughly with clean water. Ensure that **no** descaling solution residue remains in the water container. Fill the water container at least up to the S mark with fresh drinking water.

The descaling process is complete when the drinks menu appears.

Many malfunctions and faults that can occur in daily operation can be easily remedied. Time and money will be saved because a service call will not be needed.



The following guide may help you to find the reason for a malfunction or a fault, and to correct it.

Messages in the display



Error messages must be confirmed with „OK“, otherwise the message can reappear in the display even though the problem has been remedied.

Follow the instructions which appear in the display to troubleshoot an issue.

If after this, the error message appears in the display again, contact your Miele dealer.

Issue	Cause and remedy
F1, F2, F80, F82	There is an internal fault. <ul style="list-style-type: none">■ Switch the coffee machine off with the On/Off button . Wait for approximately 1 hour before switching the appliance back on again.
F41, F42, F74, F77, F235, F236	There is an internal fault. <ul style="list-style-type: none">■ Switch the coffee machine off with the On/Off button . Wait for approximately 2 minutes before switching the appliance back on again.
F10, F17	No water or very little water is being drawn in. <ul style="list-style-type: none">■ Remove the water container. Fill the water container with fresh tap water and reinsert the water container.■ Remove and clean the water container filter (see “Cleaning and care – Removing and cleaning the water container filter”).

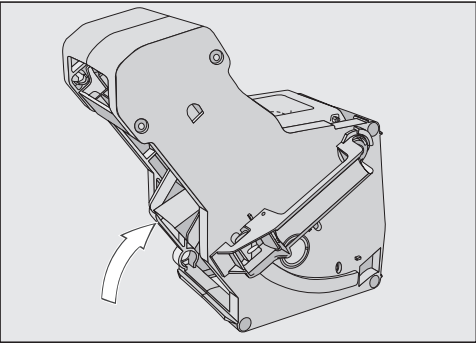
Problem solving guide



Issue	Cause and remedy
<p>F73 or Check the brew unit</p>	<p>The brew unit cannot be positioned correctly.</p> <ul style="list-style-type: none">■ Switch the coffee machine off with the On/Off button .■ Switch off at the wall socket and unplug the coffee machine. Wait for two minutes before inserting the plug back in the socket and switching on.■ Remove the brew unit and rinse under warm running water.  <ul style="list-style-type: none">■ Push the coffee ejector of the brew unit into the correct position.■ Do not fit the brew unit. Close the appliance door and switch the coffee machine on with the On/Off button . <p>This will initialise the brew unit drive and put it back into the start position.</p> <ul style="list-style-type: none">■ When Insert the brew unit appears in the display, put the brew unit back in the appliance. Close the appliance door.

Problem solving guide



Issue	Cause and remedy
Too much ground coffee	<p>There is too much ground coffee in the ground coffee chute.</p> <p>The brew unit cannot compact ground coffee if more than 12 g (2 level spoonfuls) of ground coffee are added to the coffee chute. The ground coffee will be emptied into the waste container and the fault message will appear in the display.</p> <ul style="list-style-type: none">■ Switch the coffee machine off with the On/Off button .■ Remove and clean the brew unit (see “Removing the brew unit and cleaning it by hand”).■ Remove the ground coffee inside the coffee machine, e.g. with a vacuum cleaner.■ Place a maximum of 12 g of coffee in the ground coffee chute.
	<p>There is too much ground coffee in the ground coffee chute.</p> <p>Certain types of coffee produce a lot of coffee when they are ground. Usually this is because the grinder is set too coarse and the maximum quantity of coffee is set.</p> <ul style="list-style-type: none">■ Set the grinder to a finer setting.■ Select a smaller quantity of coffee. <p>If the coffee is still not to your taste, e.g. too weak, try another type of bean.</p>

Problem solving guide

Unusual performance of the coffee machine

Issue	Cause and remedy
The display remains dark after the coffee machine has been switched on using the On/Off sensor .	The On/Off sensor  was not touched for long enough. <ul style="list-style-type: none">■ Touch the depression in the middle of the On/Off sensor  for at least three seconds.
	The plug is not inserted in the socket correctly. <ul style="list-style-type: none">■ Insert the plug into the socket correctly and switch on.
	The mains fuse has tripped due to a problem with the coffee machine, the electricity supply or another appliance. <ul style="list-style-type: none">■ Switch the coffee machine off at the wall socket and unplug it.■ Contact your Miele dealer.
The coffee machine turns off suddenly.	The factory set switch-off time (20 minutes) or the switch-off time you have programmed has been reached. <ul style="list-style-type: none">■ If required, you can select a new switch-off time (see “Settings – Timer”).
	The plug is not inserted in the socket correctly. <ul style="list-style-type: none">■ Insert the plug into the socket.
The sensors do not react to touch. The coffee machine cannot be operated.	There is an internal fault. <ul style="list-style-type: none">■ Disconnect the machine from the power supply by removing the plug from the socket.
The display is hard to see or not able to be read.	The display brightness has been set too low. <ul style="list-style-type: none">■ Change this setting (see “Settings”).

Problem solving guide

Issue	Cause and remedy
<p>Fill and replace the water container appears in the display even though the water container is full and in the machine.</p>	<p>The water container is not in the correct position.</p> <ul style="list-style-type: none"> ■ Remove the water container and push it back in again. ■ Remove and clean the water container filter (see “Cleaning and care – Removing and cleaning the water container filter”). <p>The water container was not correctly filled and refitted for descaling.</p> <ul style="list-style-type: none"> ■ Fill the water container to the descaling symbol  and restart the descaling programme.
<p>Fill and replace the water container appears after switching on even though the container is filled and fitted in the machine. The appliance does not rinse.</p>	<p>The coffee machine needs descaling.</p> <ul style="list-style-type: none"> ■ Switch the coffee machine off with the On/Off button . Wait approx. 1 hour. ■ Switch the appliance back on again. As soon as Heating-up phase appears, touch the  sensor control and then select <i>Descale the appliance</i>. ■ Descale the coffee machine.
<p>After switching on the machine the message Empty the drip tray and the waste container appears even though they are both empty.</p>	<p>This is not a fault. When the drip tray and waste container are emptied, the internal counter is not reset after the coffee machine has been switched off. Empty the drip tray and the waste container appears in the display even though the drip tray and the waste container are not filled to the maximum.</p>

Problem solving guide

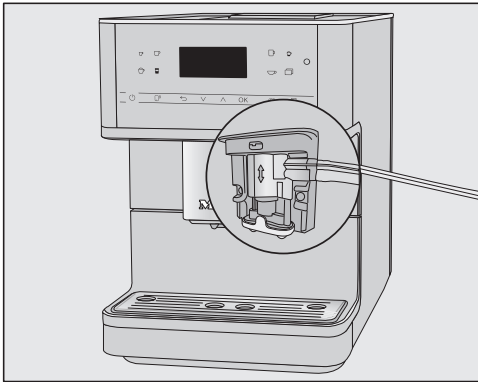
Issue	Cause and remedy
<p>Neither milk nor milk froth comes out of the central spout.</p>	<p>The milk pipework was connected incorrectly to the central spout.</p>  <p>The seam on the milk pipework, central spout and on the rinse valve makes it easier to assemble.</p> <ul style="list-style-type: none"> ■ Check whether the milk pipework is correctly connected to the central spout. <p>The milk pipework is blocked.</p> <ul style="list-style-type: none"> ■ Clean the central spout and milk pipework carefully with the brush.
<p>Empty the drip tray and the waste container appears in the display, even though the drip tray has been emptied.</p>	<p>This is not a fault. The drip tray was not properly removed and/or replaced too quickly.</p>
<p>Insert the drip tray and the waste container appears in the display even though both are fitted.</p>	<p>The drip tray is not in the correct position and is therefore not detected.</p> <ul style="list-style-type: none"> ■ Empty the drip tray and the waste container. Reassemble all parts and push the drip tray back as far as it will go in the coffee machine.
<p>The waste container is full, although the drip tray and waste container have been emptied following each reminder.</p>	<p>This is not an error.</p> <p>The drip tray has probably been removed without the waste container being emptied. Removing the drip tray resets the internal counter for emptying the waste container.</p> <ul style="list-style-type: none"> ■ Always empty the waste container if you remove the drip tray.

Problem solving guide

Issue	Cause and remedy
<p>Fill the bean container appears in the display even though the bean container has just been filled.</p>	<p>This is not a fault.</p> <ul style="list-style-type: none"> ■ Confirm the message with <i>OK</i>. <p>Insufficient coffee beans are getting into the grinder. Have you used a dark roast? This type of coffee bean is often more oily. These oils can cling to the inside of the coffee bean container and hinder the flow of beans.</p> <ul style="list-style-type: none"> ■ Make a coffee and observe whether the coffee beans drop into the coffee bean container. ■ Clean the coffee bean container more often if you are using a darker, more oily bean. <p>Try other types of coffee bean which are less oily.</p>
<p>The coffee machine does not rinse itself when turned on.</p>	<p>This is not a fault.</p> <p>If the coffee machine is already at operating temperature, rinsing will not take place.</p>
<p>Coffee dispensing is repeatedly interrupted and the message Fill the bean container appears in the display.</p>	<p>This is not a fault.</p> <p>The brew unit has not detected the ground coffee. Certain types of coffee produce a small amount of coffee when they are ground. Usually this is because the grinder is set too fine and the minimum quantity of coffee is set.</p> <ul style="list-style-type: none"> ■ Confirm the message with <i>OK</i>. <p>If the coffee is too strong for you or tastes bitter, try a different type of coffee beans.</p> <p>If the display appears with all types of coffee:</p> <ul style="list-style-type: none"> ■ Set the grinder to a coarser setting (see “Grinder setting”). ■ Select a larger quantity of coffee. <p>Don't forget to check any drinks changed in “Profiles”.</p> <p>If the message only appears when dispensing certain drinks:</p> <ul style="list-style-type: none"> ■ Check the quantity of coffee set for this drink (see “Quantity of coffee”). Select a larger quantity of coffee. ■ You may also need to set a coarser grinder setting.

Problem solving guide

Issue	Cause and remedy
The descaling process was started inadvertently.	<p>The descaling programme cannot be stopped once OK has been touched. It must now be completed through to the end. This is a security setting to fully descale the coffee machine. It ensures a long service life and that your coffee machine is functioning correctly.</p> <ul style="list-style-type: none">■ Descal the coffee machine (see “Descaling the appliance”).
Coffee is not flowing out of the central spout. Or coffee is only being dispensed via one spout.	<p>The central spout has a blockage.</p> <ul style="list-style-type: none">■ Rinse the coffee pipework (see “Cleaning and care – Rinsing the appliance”). <p>Is there still no coffee flowing out of the central spout or is it only dispensed via one side?</p> <ul style="list-style-type: none">■ Dismantle the central spout and clean all parts carefully. Use the supplied cleaning brush for parts that are difficult to reach.■ Make sure all parts are reassembled correctly. <p>The brew unit is blocked.</p> <ul style="list-style-type: none">■ Degrease the brew unit (see “Cleaning and care – Degreasing the brew unit and cleaning the interior”).

Problem solving guide

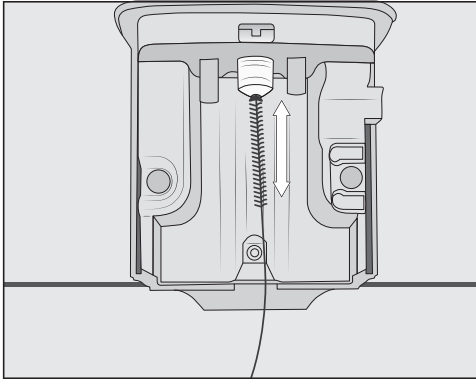
Issue	Cause and remedy
<p>The milk sputters when it is dispensed. Hissing noises can be heard when milk is being heated up or frothed. Although the milk should be frothed, only hot milk comes out of the central spout.</p>	<p>The milk pipework was not correctly fitted.</p> <ul style="list-style-type: none">■ Pay attention to the seam on the double hose when you connect the milk pipework into the central spout.■ If you have disconnected the milk pipework from the rinse valve: the double hose has different diameters. Make sure all parts are assembled correctly.
	<p>The milk temperature is too high. Good milk froth can only be achieved with cold milk (below 10 °C).</p> <ul style="list-style-type: none">■ Check the temperature of the milk.
	<p>The central spout is not fitted correctly and is taking in air. Or the spouts are blocked.</p> <ul style="list-style-type: none">■ Check whether the central spout has been assembled correctly. Make sure that all parts are tightly connected to one another.■ Clean the central spout. Knead the spouts under running water to loosen any soiling.
	<p>The milk pipework, connecting pieces, the stainless steel tube of the milk flask or the milk siphon are blocked.</p> <ul style="list-style-type: none">■ Clean all parts carefully with the cleaning brush.
	<p>The steam jet on the central spout has a blockage.</p>  <ul style="list-style-type: none">■ Clean the steam jet with the cleaning brush (see illustration).

Problem solving guide

Issue	Cause and remedy
Coffee grounds have settled on the lid of the drip tray and in the interior around the brew unit.	This is not a fault. The movement of the brew unit during the brewing process can cause some ground coffee to fall around it. The type of beans used, the fineness of the ground coffee and the quantity of coffee ground also affect the quantity. Important! Clean the inside of the coffee machine regularly to prevent mould etc. Check whether the quantity of coffee is set too high.
The display lights up but the coffee machine does not heat up and no drinks are made. The coffee machine cannot be turned off.	The Demo mode for demonstrating the coffee machine in the showroom has been activated. ■ Deactivate Demo mode.

Unsatisfactory results

Issue	Cause and remedy
<p>The coffee is not hot enough.</p>	<p>The cup has not been pre-heated. The smaller the cup and the thicker its sides, the more important it is to pre-heat it.</p> <ul style="list-style-type: none"> ■ Pre-heat the cups, e.g. using the cup heating (depending on model).
	<p>The brewing temperature has been set too low.</p> <ul style="list-style-type: none"> ■ Set a higher brewing temperature.
	<p>The filters in the brew unit are blocked.</p> <ul style="list-style-type: none"> ■ Remove the brew unit and clean it by hand. ■ Degrease the brew unit.
<p>The heating-up time is getting longer, the amount of water being dispensed is incorrect and the coffee machine is not performing properly. Coffee flows very slowly out of the central spout.</p>	<p>The coffee machine needs descaling.</p> <ul style="list-style-type: none"> ■ Descale the coffee machine.
<p>The quantity of dispensed coffee has changed.</p>	<p>The brew unit is blocked.</p> <ul style="list-style-type: none"> ■ Degrease the brew unit (see “Cleaning and care – Degreasing the brew unit and cleaning the interior”).
<p>The consistency of the milk froth is unsatisfactory.</p>	<p>The milk temperature is too high. Good milk froth can only be achieved with cold milk (below 10 °C).</p> <ul style="list-style-type: none"> ■ Check the temperature of the milk in the milk flask.
	<p>The milk pipework is blocked.</p> <ul style="list-style-type: none"> ■ Clean the central spout and milk pipework with the brush.
<p>The coffee grinder makes a louder noise than usual.</p>	<p>The coffee bean container has become empty during the grinding process.</p> <ul style="list-style-type: none"> ■ Fill the container with fresh beans.
	<p>There may be stones in amongst the coffee beans.</p> <ul style="list-style-type: none"> ■ Switch the coffee machine off immediately. Call your Miele dealer.

Problem solving guide

Issue	Cause and remedy
The coffee flows too quickly into the cup.	The coffee is too coarsely ground. ■ Set the grinder to a finer setting (see “Grinder setting”).
The coffee is dispensed too slowly into the cup.	The brew unit is blocked. ■ Degrease the brew unit (see “Cleaning and care – Degreasing the brew unit and cleaning the interior”).
There is no crema on the coffee or espresso.	The coffee beans are no longer fresh. If roasted coffee beans are stored open for too long, the carbon dioxide gradually escapes from the coffee beans. The crema is no longer formed during dispensing. Of course, you can still use the coffee beans.

Transporting the machine



If you are not going to use the coffee machine for an extended period of time, e.g. whilst on holiday, or if it needs to be moved, a number of procedures will need be carried out to ensure its safety.

- Empty and clean the coffee bean container
- Empty and clean the water container
- Evaporate the coffee machine
- Clean the inside of the machine
- Pack the machine securely

Evaporating the coffee machine

The coffee machine should be evaporated before it is stored for a long period of time or transported any distance – particularly at temperatures below freezing.

Evaporating the appliance involves removing all traces of water from the system to prevent the risk of water and frost damage.

- Touch the  sensor control.
- Select Further | Settings  | Showroom programme | Evaporate.

The cleaning process cannot be cancelled. It must be completed through to the end.

- Select Yes and confirm with OK.
- Follow the instructions in the display.

 Caution! Danger of burning and scalding on the dispensing spouts! Hot steam is discharged.

When the display goes out, the machine has finished evaporating.

- Switch off the coffee machine and unplug it to disconnect it from the power supply.
- Clean the drip tray and waste container.

Packing the machine

The coffee machine should only be packed when it is clean and dry. Residues of coffee grounds can cause scratches on surfaces. Coffee and milk residues or water can cause a build-up of bacteria.

Use the original packaging including polystyrene blocks to pack the coffee machine.

Also pack the operating instructions so that they are available when the coffee machine is next used.

After sales service and warranty

Contact in case of malfunction

In the event of any faults which you cannot remedy yourself, please contact your Miele dealer.

Contact details for your Miele dealer are given at the end of this document.

Please note that telephone calls may be monitored and recorded for training purposes and that a call-out charge will be applied to service visits where the problem could have been resolved as described in this booklet.

Please quote the model and serial number of your appliance when contacting your Miele dealer. This information can be found on the data plate.

Guarantee

For information on the appliance guarantee specific to your country please contact your Miele dealer. See end of this booklet for contact details.

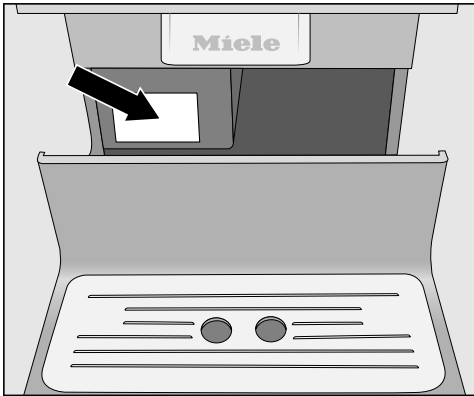

These products and other useful accessories can be ordered from your Miele dealer.

Accessories supplied

- **Starter set “Miele appliance care”**
Various cleaning products are supplied depending on model.
- **Cleaning brush**
for cleaning the milk pipework
- **Milk siphon**
For preparing milk directly from the sales packaging
- **Milk flask with lid**
For storing and preparing milk (included depending on model)

Optional accessories

Miele accessories and cleaning and conditioning products are available for your coffee machine.

- **Microfibre cloth**
for removing finger marks and light soiling
- **Descaling tablets**
for descaling the water pipework
- **Milk flask with lid**
For storing and preparing milk
- **CJ Jug 1.0 l**
Insulated flask for coffee or tea (pot function)
- **Miele Black Edition One for all**
Whole coffee beans – perfect for making espresso, café crema and speciality coffees with milk
- **Miele Black Edition Espresso**
Whole coffee beans – perfect for making espresso
- **Miele Black Edition Café Crema**
Whole coffee beans – perfect for making coffee
- **Miele Black Edition Decaf**
Whole coffee beans – perfect for making decaffeinated speciality coffees

Saving energy

The following tips can help you save energy and money as well as care for the environment:

- Operate the coffee machine in Eco mode.
- Switch the coffee machine off with the On/Off button  if it is not going to be used for a while.
- Change the setting for the Switch off after timer to 20 minutes. The coffee machine will then switch itself off 20 minutes after the last drink was made or a sensor control was touched.
- If you only want to pre-heat your cups occasionally, you can switch the cup heating surface off. You can use hot water to pre-heat the cups.

The appliance is supplied with a mains cable with moulded plug for connection. Please ensure the connection data (voltage and frequency) quoted on the data plate match the household mains supply. Please consult a qualified electrician if you are in any doubt.

Connection should be made via a suitable switched socket which is easily accessible after installation.

For extra safety it is advisable to operate the machine via a suitable residual current device (RCD). Contact your Miele dealer.

Do not connect the appliance to the mains electricity supply by a multisocket adapter or an extension lead. These are a fire hazard and do not guarantee the required safety of the appliance.

If the connection cable is faulty, it may only be replaced by a qualified electrician in order to avoid a hazard.

The required connection data is quoted on the data plate. This can be seen on the left-hand side when the drip tray is pulled out.

Temporary or permanent operation on an autonomous power supply system or a power supply system that is not synchronised with the mains power supply (e.g. island networks, back-up systems) is possible. A prerequisite for operation is that the power supply system complies with the specifications of EN 50160 or an equivalent standard. The function and operation of the protective measures provided in the domestic electrical installation and in

this Miele product must also be maintained in isolated operation or in operation that is not synchronised with the mains power supply, or these measures must be replaced by equivalent measures in the installation. As described, for example, in the current version of BS OHSAS 18001-2 ISO 45001.

The appliance must not be used with so-called **energy saving devices** either. These reduce the amount of energy supplied to the machine causing it to overheat.

Electrical connection

Non-rewireable plugs BS 1363

The fuse cover must be refitted when changing the fuse, and if the fuse cover is lost, the plug must not be used until a suitable replacement is obtained. The colour of the correct replacement cover is that of the coloured insert in the base of the plug, or the colour that is embossed in words on the base of the plug (as applicable to the design of plug fitted).

Replacement fuses must be ASTA approved to BS 1362 and have the correct rating. Replacement fuses and fuse covers may be purchased from your local electrical supplier.

WARNING: THIS APPLIANCE MUST BE EARTHED

 Danger of overheating due to insufficient ventilation.

If the coffee machine is not sufficiently ventilated, the appliance can overheat.

Please ensure that there is adequate ventilation around the coffee machine.

Do not cover the coffee machine with tea towels etc. while it is in use.

If the coffee machine is installed behind a closed furniture front, heat and moisture can build up behind the furniture front when closed. This can result in damage to the coffee machine and/or furniture unit.

Do not close the furniture front while the coffee machine is in use.

Please observe the following installation instructions:

- The location of the machine must be dry and well ventilated.
- The ambient temperature of the room in which the machine is used must be between 10 °C and 38 °C.
- The machine must be set up on a level surface. The surface must be water resistant.

If the machine is installed in a niche, the niche must provide the following minimum dimensions:

Height	508 mm
Width	450 mm
Depth	555 mm

When setting up the machine: make sure that the service panel can be fully opened so that the brew unit can be removed with ease when required.

- The machine must be set up in the niche such that it sits flush with the front edge of the niche.

Dimensions

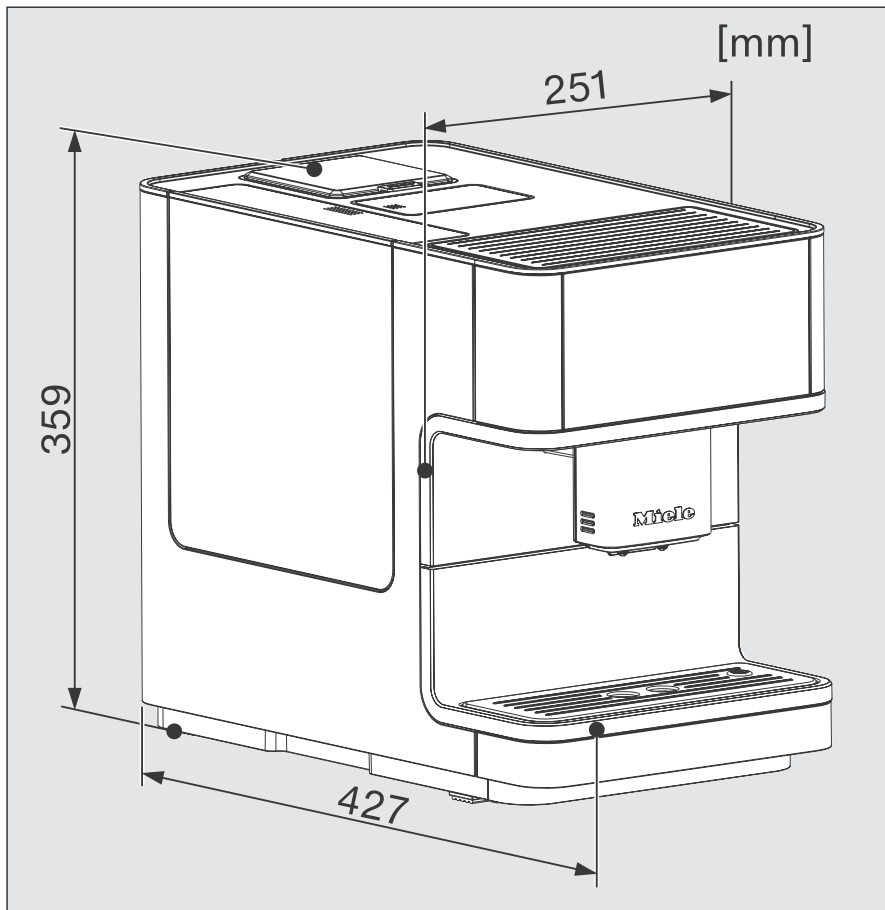

Technical data

Electricity consumption in standby:	< 0,1 W
Electricity consumption in networked standby:	< 0,5 W
Pump pressure:	Max. 15 bar
Through-flow heater:	1 stainless steel thermo block
Dimensions (W x H x D):	251 x 359 x 427 mm
Net weight:	9,9 kg
Mains connection cable length:	140 cm
Water container capacity:	1,8 l
Bean container capacity:	Approx. 300 g
Milk container capacity:	0,7 l
Drip tray capacity:	0,8 l
Waste container capacity:	Max. 10 portions of coffee grounds
Central spout:	Height adjustable from 80-140 mm
Grinder:	Steel conical grinder
Grinder setting:	5 settings
Ground coffee amount:	Max. 12 g
Frequency band:	2.400–2.4835 GHz
Max. transmission power	< 100 mW

(The milk flask is supplied with the CM 6360, CM 6560.)

Miele Saudi Arabia

AWAD BADI NAHAS TRADING CO. LTD

Head Office:

Jeddah

P.O. Box 11529 Jeddah 21463

Tel. +966 12 2560888, Fax. +966 12 2560555

Hotline for customer care: 920003240

Website: www.awadnahas.com

Branches:

Jeddah

Madina Road

Tel. +966 12 6970060, Fax. +966 12 6970012

Jeddah

Sitteen Street

Tel. +966 12 6611675, Fax. +966 12 6606852

Jeddah

Miele Gallery

Al Thanyyan Group Building, Al-Madina Road,

Near, Al Rowdah District, Jeddah

Tel. +966 12 6989339 Ext. 100

Fax. +966 12 6989339 Ext. 200

Riyadh

Olaya Street

Tel. +966 11 2013501, Fax. +966 11 2013502

Taif

Hadiya Street

Tel. +966 12 7327001, Fax. +966 12 7369596

Khobar

Al Zahran Road

Tel. +966 13 8646150, Fax. +966 13 8646190

Miele United Arab Emirates

Miele Appliances Ltd.

Showroom 1

Eiffel 1 Building

Sheikh Zayed Road, Umm Al Sheif

P.O. Box 114782 - Dubai

United Arab Emirates

Tel. +971 4 3044 999

Fax. +971 4 3418 852

800-MIELE (64353)

Email: info@miele.ae

Website: www.miele.ae

Webshop: shop.miele.ae

Miele Kuwait

Al Wazzan United Trading Co.

P. O. Box : 3379

Hawally, 32034 Kuwait

Tel.: 00965-22001010

Fax: 00965-24838292

Email: mail@alwazzanunited.com

Website: www.alwazzanunited.com

Showroom

Al Wazzan Electronics

Odah Al-Mahanna Complex

Tunis Street, Hawally, Kuwait

Tel.: 00965- 22001010

Ext: 202 / 205 / 206

Manufacturer: Miele & Cie. KG, Carl-Miele-Straße 29, 33332 Gütersloh, Germany

CM 6160, CM 6360, CM 6560

en – AE, SA

M.-Nr. 11 725 852 / 00