

Operating and Installation Instructions Induction Cooktops



It is **essential** to read the operating and installation instructions before setup, installation, and commissioning. This prevents both personal injury and damage to the appliance.

Contents

IMPORTANT SAFETY INSTRUCTIONS	5
Sustainability and environmental protection	15
Overview	16
Cooktop.....	16
KM 7720 FR	16
KM 7730 FR	17
KM 7740 FR	18
Controls and display	19
Cooking zone data	20
Power management system.....	26
Operation.....	27
Networking	28
Miele@home	28
Direct connection with the ventilation hood.....	28
Functions.....	29
Con@ctivity 3.0	29
Permanent pan recognition	29
Pan and pan size recognition	29
Booster.....	29
Stop & Go.....	29
Additional power levels	29
Auto heat-up	29
Timer	29
System lock.....	29
Safety lock.....	30
Keeping warm	30
Wipe protection.....	30
Programming.....	30
Demo mode.....	30
Residual heat indicator.....	30
Safety shut-off.....	31
Overheating protection.....	32
Commissioning	33
Unpacking the cooktop.....	33
Cleaning the cooktop for the first time.....	33
Switching on the cooktop for the first time	33
Miele@home	34
Installing the Miele app	34
Setting up Miele@home	34
Establishing a direct connection with the ventilation hood.....	38

Operation	40
Safety notes for operation.....	40
Switching the cooktop on.....	41
Switching off a cooking zone/the cooktop.....	41
Power level.....	41
Setting the power level.....	41
Setting the power level – extended power level range.....	41
Changing the power level.....	41
Booster.....	42
Activating the Booster function.....	42
Deactivating the Booster function.....	42
Activating/deactivating Stop & Go.....	42
Auto heat-up.....	43
Activating Auto heat-up.....	43
Deactivating Auto heat-up.....	43
Timer.....	44
Setting timer durations.....	44
Setting the kitchen timer.....	44
Changing the kitchen timer.....	44
Deleting the kitchen timer.....	44
Setting the switch-off time.....	45
Changing the switch-off time.....	45
Deleting the switch-off time.....	45
Setting multiple switch-off times.....	45
Displaying switch-off times.....	45
Using both timer functions at the same time.....	46
System lock.....	47
Activating the system lock.....	47
Deactivating the system lock.....	47
Safety lock.....	47
Activating the safety lock.....	47
Deactivating the safety lock.....	47
Keeping warm.....	48
Activating/deactivating the Keeping warm function.....	48
Keeping warm temperatures for various applications.....	48
Tips for keeping food warm.....	48
Wipe protection.....	48
Activating wipe protection.....	48
Deactivating wipe protection.....	48
Cooktop data.....	49
Displaying the model identifier/serial number.....	49
Displaying the software version.....	49
Activating/deactivating demo mode.....	49

Contents

Setting ranges	50
Good to know	51
How induction cooktops work	51
Noises.....	51
Cookware	52
Customizing settings	54
Cleaning and care	58
Frequently asked questions	60
Messages in the display	60
Unexpected behavior	62
Unsatisfactory results.....	64
General problems or technical faults.....	64
Customer Service	65
Contact in the event of a fault	65
Data plate	65
Appliance warranty and product registration	65
Optional accessories	66
Installation	67
Safety notes for installation.....	67
Safety distances.....	70
Installation dimensions.....	74
KM 7720 FR	74
KM 7730 FR	75
KM 7740 FR	76
Reinstalling the cooktop.....	77
Electrical connection	78
Declaration of conformity	80

IMPORTANT SAFETY INSTRUCTIONS

This cooktop complies with all relevant local and national safety requirements. Inappropriate use can, however, lead to personal injury and material damage.

Read the operating and installation instructions carefully before using the cooktop. They contain important information on safety, installation, use and maintenance. This prevents both personal injury and damage to the cooktop.

When installing the cooktop, Miele expressly and strongly advises that you read and follow the instructions under “Installation”, as well as in the “IMPORTANT SAFETY INSTRUCTIONS”.

Miele cannot be held liable for injury or damage caused by non-compliance with these instructions.

Keep these instructions in a safe place and pass them on to any future owner.

Appropriate use

- ▶ This cooktop is intended for domestic use and use in other similar environments.
- ▶ This cooktop is not intended for outdoor use.
- ▶ The cooktop is intended for domestic use only to prepare food and keep it warm. Any other use may be dangerous.
- ▶ Persons (including children) who lack physical, sensory or mental abilities, or experience with the appliance should not use it without supervision or instruction by a responsible person.

IMPORTANT SAFETY INSTRUCTIONS

Safety with children

- ▶ Do not leave children unattended: Children should not be alone or unsupervised in the area where the appliance is installed. Do not allow them to sit or stand on the appliance.
- ▶ Be sure to supervise any children in the vicinity of the cooktop, and do not let them play with it.
- ▶ The cooktop gets hot when in use and remains hot for some time after being turned off. Keep children away from the appliance until it has cooled down and is no longer a burn hazard.
- ▶ Danger of burning. Do not store anything which might arouse a child's interest in storage areas above or behind the cooktop. Otherwise they could be tempted to climb onto the cooktop.
- ▶ Risk of burning or scalding. Turn pot and pan handles inward, so children cannot pull them down and be burned.
- ▶ Danger of suffocation. While playing, children may become entangled in packaging material (such as plastic wrapping) or pull it over their head, presenting the risk of suffocation. Keep packaging material away from children.
- ▶ Activate the system lock to ensure that children cannot turn on the appliance inadvertently. Use the safety lock when the cooktop is in use to prevent children from altering the settings selected.

IMPORTANT SAFETY INSTRUCTIONS

Technical safety

- ▶ Proper installation: Make sure that your appliance has been installed correctly and that it has been grounded by a qualified technician.
- ▶ Maintenance by the user: Never repair or replace any part of the appliance unless the instructions specifically recommend doing so. Service work should only be performed by a qualified technician.
- ▶ Unauthorized installation, maintenance, and repairs can cause considerable danger for the user. Installation, maintenance, and repairs must only be carried out by a Miele authorized technician.
- ▶ Damage to the cooktop can compromise your safety. Check the cooktop for visible signs of damage. Do not use the cooktop if it is damaged.
- ▶ Temporary or permanent operation on an autonomous power supply system or a power supply system that is not synchronized with the grid power supply (e.g., island networks, back-up systems) is possible. A prerequisite for operation is that the power supply system complies with national and local codes.
The function and operation of the protective measures provided in the domestic electrical installation and in this Miele product must also be maintained in isolated operation or in operation that is not synchronized with the grid power supply, or these measures must be replaced by equivalent measures in the installation.
- ▶ Be certain your appliance is properly installed and grounded by a qualified technician. To guarantee the electrical safety of this appliance, continuity must exist between the appliance and an effective grounding system. It is imperative that this basic safety requirement be met. If there is any doubt, have the electrical system of the house checked by a qualified electrician.

IMPORTANT SAFETY INSTRUCTIONS

- ▶ To avoid damaging the cooktop, make sure that the connection data (voltage and frequency) on the data plate correspond to the building's power supply before connecting the appliance. When in doubt, consult a qualified electrician.
- ▶ Do not connect the appliance to the electrical supply with a power bar or extension cord. These are a fire hazard and do not guarantee the required safety of the appliance.
- ▶ For safety reasons, the cooktop may only be used when it has been fully installed.
- ▶ This appliance must not be used in a non-stationary location (e.g. on a ship).
- ▶ Any contact with live connections or tampering with the electrical or mechanical components of the cooktop will endanger your safety and may lead to appliance malfunctions. Do not open the casing of the cooktop under any circumstances.
- ▶ Any repairs not performed by a Miele authorized service technician will void the warranty.
- ▶ Defective components should be replaced by Miele original parts only. Only with these parts can safety of the appliance be assured as intended by the manufacturer.
- ▶ The appliance is not intended for use with an external timer switch or a remote control system.
- ▶ The cooktop must be connected to the electricity supply by a qualified electrician (see “Installation – Electrical connection”).
- ▶ If the power supply cord is damaged, it must be replaced with a special power supply cord by a qualified electrician (see “Installation – Electrical connection”).

IMPORTANT SAFETY INSTRUCTIONS

▶ The appliance must be completely disconnected from the electricity supply during installation, maintenance and repair work. Ensure that power is not supplied to the appliance until after it has been installed or until any maintenance or repair work has been carried out.

Disconnect by

- removing the fuse,
- “tripping” the circuit breaker, or
- unplugging the unit (if equipped with plug). Pull the plug not the cord.

▶ Danger of electric shock. Do not use the cooktop if it is faulty, or if the ceramic surface is cracked, chipped, or damaged in any way. Switch it off immediately. Disconnect the cooktop from the electrical power supply. Contact Miele Service.

▶ If the cooktop is installed behind a cabinet door, do not close the door while the cooktop is in operation. Heat and moisture can build up behind the closed door and cause damage to the cooktop, cabinetry, and flooring. Do not close the door until the residual heat indicators go out.

IMPORTANT SAFETY INSTRUCTIONS

Correct use

- ▶ The cooktop gets hot when in use and remains hot for a while after being turned off. There is a potential hazard until the residual heat indicator goes out.
- ▶ Never leave the appliance unattended at high heat settings – Boilover causes smoking and greasy spillovers that may ignite.
- ▶ Oil and fat can catch fire if overheated. Never leave the appliance unattended when cooking with oil and fat. If the oil or fat catches fire, do not attempt to put the flames out with water. Turn off the cooktop and smother the flames using a lid or a suitable fire blanket.
- ▶ Do Not Use Water on Grease Fires – Smother fire or flame or use dry chemical or foam-type extinguisher.
- ▶ Storage in or on the appliance: Flammable materials should not be stored in an oven or in the vicinity of the appliance.
- ▶ The flames could set the grease filters of a ventilation hood on fire. Do not flambé under a ventilation hood.
- ▶ Spray canisters, aerosols and other inflammable substances can ignite when heated. Therefore do not store such items or substances in a drawer under the appliance. Cutlery inserts must be heat-resistant.
- ▶ Never heat empty cookware.
- ▶ Do not heat or can food in closed containers, such as tins or sealed jars, on the cooktop, as pressure will build up in the container and cause it to explode.
- ▶ If the cooktop is covered, there is a risk that the material of the cover will ignite, explode or melt if the cooktop is still hot or if turned on inadvertently. Never cover the cooktop with a board, cloth or protective sheet.

IMPORTANT SAFETY INSTRUCTIONS

- ▶ If the cooktop is turned on or accidentally turned on or if it is still hot, metal objects on the cooktop can heat up. Other items may melt or catch fire. Damp lids can become attached to the cooktop by suction. Do not store items on the cooktop! Always turn the cooking zones off after use!
- ▶ You could burn yourself on the hot cooktop. Protect your hands with heat-resistant pot holders or gloves when handling hot pots and pans. Do not let them get wet or damp, as this causes heat to transfer through the material more quickly with the risk of scalding or burning yourself.
- ▶ When using an electrical appliance, e.g. a hand mixer, near the cooktop, make sure that the power cable does not come into contact with the hot cooktop. The cable's insulation could become damaged.
- ▶ Grains of salt, sugar and sand (e.g. from cleaning vegetables) can cause scratches if they get under pan bases. Make sure that the ceramic surface is clean before placing pans on it.
- ▶ Even a light object can cause damage to the ceramic cooktop in certain circumstances. Do not drop anything on the ceramic surface.
- ▶ Do not place hot pans on the sensor buttons and display as this could cause damage to the electronics underneath. Do not place hot pans on the area around the display.
- ▶ Do not allow solid or liquid sugar, or pieces of plastic or aluminum foil to get onto the cooktop when it is hot, as they can damage the ceramic surface when it cools down. If this should occur, turn off the appliance immediately and scrape off all the sugar, plastic or aluminum residues while still hot, using a shielded scraper blade. Use pot holders. Allow the ceramic surface to cool down before cleaning with a suitable ceramic cleaning agent.
- ▶ Pans that boil dry can cause damage to the ceramic glass. Do not leave the appliance unattended while it is being used.

IMPORTANT SAFETY INSTRUCTIONS

- ▶ Pots and pans with bases with pronounced edges or ridges can scratch the ceramic surface. Only use pots and pans with smooth bases.
- ▶ Lift pans into position on the cooktop. Sliding them into place can cause scuffs and scratches.
- ▶ Wear Proper Apparel – Loose-fitting or hanging garments should never be worn while using the appliance.
- ▶ Because induction heating works so quickly, the temperature can quickly reach the ignition point of oils and fats. Never leave the cooktop unattended when it is turned on.
- ▶ Do not heat oils and fats for longer than 1 minute, and never use the booster.
- ▶ For people who have a heart pacemaker: Please note that the area immediately surrounding the cooktop is electromagnetically charged. It is very unlikely to affect a pacemaker. However, if in any doubt, consult the manufacturer of the pacemaker or your doctor.
- ▶ Objects affected by electromagnetic fields, for instance credit cards, CDs and calculators, should be kept away from the cooktop when it is on.
- ▶ Metal utensils stored in a drawer under the cooktop can become hot if the appliance is used intensively for a long time.
- ▶ The cooktop is equipped with a cooling fan. If a drawer is located directly underneath the cooktop, ensure that there is sufficient space between the drawer and its contents and the underside of the cooktop in order to ensure sufficient ventilation for the cooktop.
- ▶ If a drawer is located directly underneath the cooktop, do not store any pointed or small items, paper, napkins, etc. in the drawer. They could get in through the ventilation slots or be sucked into the casing by the fan and damage the fan or impair cooling.

IMPORTANT SAFETY INSTRUCTIONS

- ▶ Do not use 2 items of cookware on a cooking zone or extended zone at the same time.
- ▶ If the cookware only partially covers a cooking zone, the handle could become very hot.
Always place cookware in the middle of the cooking zone.
- ▶ Wet sponges or cloths can cause burns due to hot steam if they are used to wipe spilled food off a hot cooktop. Some cleansers can emit hazardous vapors if they are applied to a hot surface. Be careful when cleaning the cooktop.
- ▶ If the cooktop is damaged, cleansers or spilled food can penetrate the glass surface and cause a short-circuit. Never cook on a damaged cooktop. Contact an electrician immediately.
- ▶ If an induction adapter plate is used for cookware, the induction generators may be damaged or even destroyed. Do not use induction adapter plates.

IMPORTANT SAFETY INSTRUCTIONS

Cleaning and maintenance

- ▶ Do not use a steam cleaner to clean the cooktop. The steam may reach electrical components and cause a short circuit.

Sustainability and environmental protection

Energy-saving tips

- Cook in covered pots and pans if possible. This prevents heat escaping unnecessarily.
- Cook with as little water as possible.
- Once food has come to a boil or the pan is hot for frying, reduce the heat to a lower power level.
- Use a pressure cooker to reduce cooking durations.

Disposal of the packing material

The cardboard box and packing materials protect the appliance during shipping. They have been designed to be biodegradable and recyclable.

Ensure that any plastic wrappings, bags, etc. are disposed of safely and kept out of the reach of children. Danger of suffocation!

Disposal of your old appliance

Electrical and electronic appliances contain valuable materials. They also contain certain substances, compounds and components which were essential for the proper functioning and safe use of the equipment. Handling these materials improperly by disposing of them in your household waste can be harmful to your health and the environment. Therefore, please do not dispose of your old appliance with regular household waste and follow local regulations on proper disposal.



Consult with local authorities, dealers or Miele in order to dispose of and recycle electrical and electronic appliances. Miele assumes no responsibility for deleting any personal data left on the appliance being disposed. Please ensure that your old appliance is kept away from children until removal. Observe safety requirements for appliances that may tip over or pose an entrapment hazard.

Overview

Cooktop

KM 7720 FR

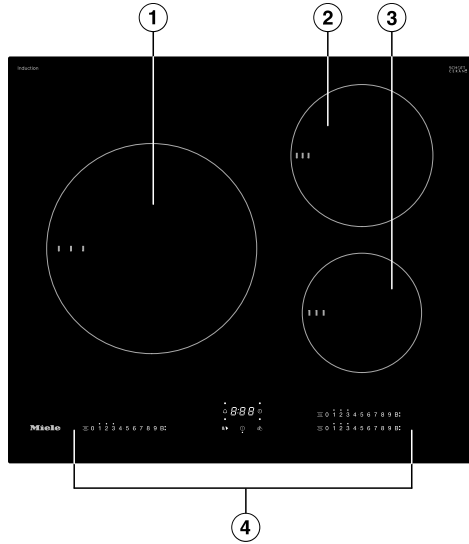

- ① Cooking zone with TwinBooster
- ② Cooking zone with TwinBooster
- ③ Cooking zone with TwinBooster
- ④ Controls and indicators

KM 7730 FR

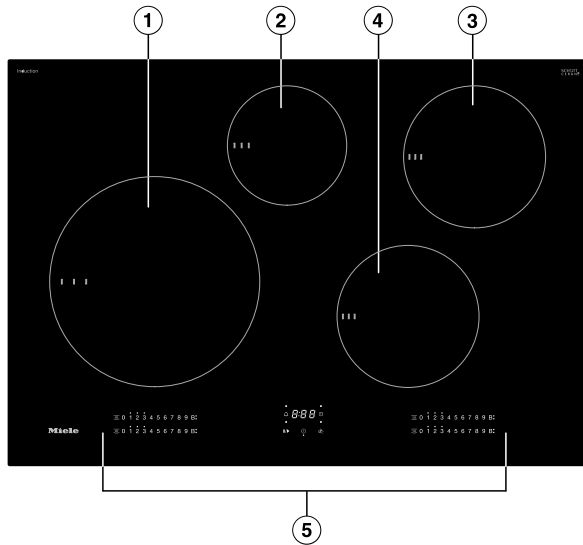

- ① Cooking zone with TwinBooster
- ② Cooking zone with TwinBooster
- ③ Cooking zone with TwinBooster
- ④ Cooking zone with TwinBooster
- ⑤ Controls and indicators

Overview

KM 7740 FR

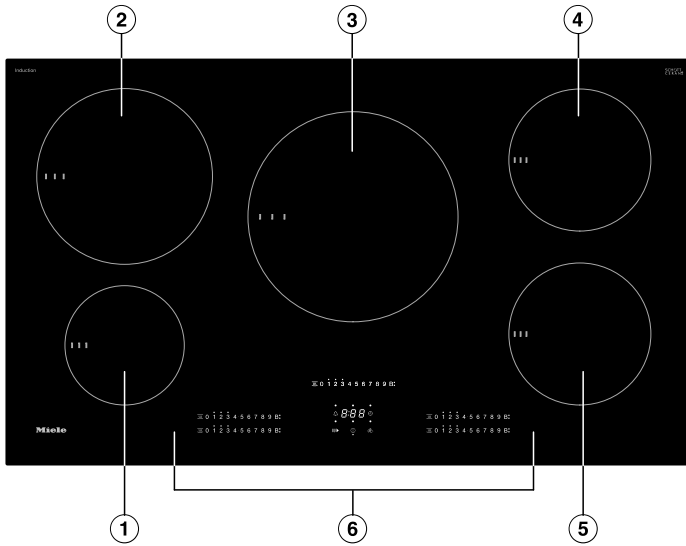

- ① Cooking zone with TwinBooster
- ② Cooking zone with TwinBooster
- ③ Cooking zone with TwinBooster
- ④ Cooking zone with TwinBooster
- ⑤ Cooking zone with TwinBooster
- ⑥ Controls and indicators

Controls and display

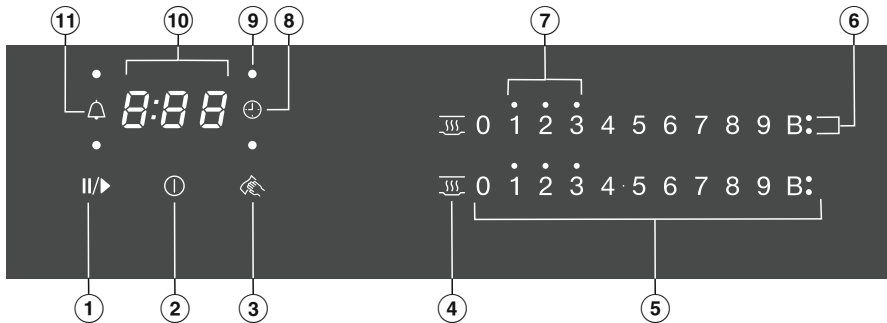

- ① Stop & Go sensor control
For stopping/starting a cooking process in progress
- ② Cooktop On/Off sensor control
- ③ Wipe protection sensor control
For locking the sensor controls
- ④ Keeping warm sensor control
For activating/deactivating the Keeping warm function
- ⑤ Numerical display sensor controls
 - For setting the power level
 - For setting the times
- ⑥ Booster display
Booster function is activated
- ⑦ Residual heat indicator lights
- ⑧ Safety shut-off sensor control
Switches the cooking zones off automatically
- ⑨ Cooking zone allocation safety shut-off indicator light
Safety shut-off for the cooking zone is activated
- ⑩ Timer display
 - 00* to *99* Time in minutes
 - LC* System lock/safety lock is activated
 - dE* Demo mode activated
- ⑪ Kitchen timer sensor control

Overview

Cooking zone data

KM 7720 FR				
Cooking zone	Ø in inches (cm) ¹	Max. rating in watts for 208 V ²		Linked cooking zone ³
①	7"-11" (18-28 cm)	Normal	2,400	-
		TwinBooster, level 1	2,750	
		TwinBooster, level 2	3,350	
②	5 1/2"-7 1/2" (14-19 cm)	Normal	1,700	③
		TwinBooster, level 1	2,300	
		TwinBooster, level 2	2,750	
③	4"-6 1/2" (10-16 cm)	Normal	1,300	②
		TwinBooster, level 1	1,550	
		TwinBooster, level 2	2,000	
		Total	6,600	

¹ Cookware with a base diameter within the given range may be used.

² The power indicated may vary depending on the size and material of the cookware used.

³ The cooking zone is linked to this cooking zone electrically so that the rating can be increased; see "Overview – Power management system".

KM 7720 FR				
Cooking zone	Ø in inches (cm) ¹	Max. rating in watts for 240 V ²		Linked cooking zone ³
①	7"–11" (18–28 cm)	Normal	2,600	-
		TwinBooster, level 1	3,000	
		TwinBooster, level 2	3,700	
②	5 1/2"–7 1/2" (14–19 cm)	Normal	1,850	③
		TwinBooster, level 1	2,500	
		TwinBooster, level 2	3,000	
③	4"–6 1/2" (10–16 cm)	Normal	1,400	②
		TwinBooster, level 1	1,700	
		TwinBooster, level 2	2,200	
		Total	7,600	

¹ Cookware with a base diameter within the given range may be used.

² The power indicated may vary depending on the size and material of the cookware used.

³ The cooking zone is linked to this cooking zone electrically so that the rating can be increased; see "Overview – Power management system".

Overview

KM 7730 FR				
Cooking zone	Ø in inches (cm) ¹	Max. rating in watts for 208 V ²		Linked cooking zone ³
①	7"–11" (18–28 cm)	Normal	2,400	②
		TwinBooster, level 1	2,750	
		TwinBooster, level 2	3,350	
②	4"–6 1/2" (10–16 cm)	Normal	1,300	①
		TwinBooster, level 1	1,550	
		TwinBooster, level 2	2,000	
③	5 1/2"–7 1/2" (14–19 cm)	Normal	1,700	④
		TwinBooster, level 1	2,300	
		TwinBooster, level 2	2,750	
④	5 1/2"–7 1/2" (14–19 cm)	Normal	1,700	③
		TwinBooster, level 1	2,300	
		TwinBooster, level 2	2,750	
		Total	6,600	

¹ Cookware with a base diameter within the given range may be used.

² The power indicated may vary depending on the size and material of the cookware used.

³ The cooking zone is linked to this cooking zone electrically so that the rating can be increased; see "Overview – Power management system".

KM 7730 FR				
Cooking zone	Ø in inches (cm) ¹	Max. rating in watts for 240 V ²		Linked cooking zone ³
①	7"–11" (18–28 cm)	Normal	2,600	②
		TwinBooster, level 1	3,000	
		TwinBooster, level 2	3,700	
②	4"–6 1/2" (10–16 cm)	Normal	1,400	①
		TwinBooster, level 1	1,700	
		TwinBooster, level 2	2,200	
③	5 1/2"–7 1/2" (14–19 cm)	Normal	1,850	④
		TwinBooster, level 1	2,500	
		TwinBooster, level 2	3,300	
④	5 1/2"–7 1/2" (14–19 cm)	Normal	1,850	③
		TwinBooster, level 1	2,500	
		TwinBooster, level 2	3,000	
		Total	7,600	

¹ Cookware with a base diameter within the given range may be used.

² The power indicated may vary depending on the size and material of the cookware used.

³ The cooking zone is linked to this cooking zone electrically so that the rating can be increased; see "Overview – Power management system".

Overview

KM 7740 FR				
Cooking zone	Ø in inches (cm) ¹	Rating in watts for 208 V ²		Linked cooking zone ³
①	4"-6 1/2" (10-16 cm)	Normal	1,300	②
		TwinBooster, level 1	1,550	
		TwinBooster, level 2	2,000	
②	6 1/2"-9" 16-23 cm (16-23 cm)	Normal	2,100	①
		TwinBooster, level 1	2,750	
		TwinBooster, level 2	3,350	
③	7"-11" (18-28 cm)	Normal	2,400	-
		TwinBooster, level 1	2,750	
		TwinBooster, level 2	3,350	
④	5 1/2"-7 1/2" (14-19 cm)	Normal	1,700	⑤
		TwinBooster, level 1	2,300	
		TwinBooster, level 2	2,750	
⑤	5 1/2"-7 1/2" (14-19 cm)	Normal	1,700	④
		TwinBooster, level 1	2,300	
		TwinBooster, level 2	2,750	
		Total	9,900	

¹ Cookware with a base diameter within the given range may be used.

² The power indicated may vary depending on the size and material of the cookware used.

³ The cooking zone is linked to this cooking zone electrically so that the rating can be increased; see "Overview – Power management system".

KM 7740 FR				
Cooking zone	Ø in inches (cm) ¹	Rating in watts for 240 V ²		Linked cooking zone ³
①	4"-6 1/2" (10-16 cm)	Normal	1,400	②
		TwinBooster, level 1	1,700	
		TwinBooster, level 2	2,200	
②	6 1/2"-9" 16-23 cm (16-23 cm)	Normal	2,300	①
		TwinBooster, level 1	3,000	
		TwinBooster, level 2	3,700	
③	7"-11" (18-28 cm)	Normal	2,600	-
		TwinBooster, level 1	3,000	
		TwinBooster, level 2	3,700	
④	5 1/2"-7 1/2" (14-19 cm)	Normal	1,850	⑤
		TwinBooster, level 1	2,500	
		TwinBooster, level 2	3,000	
⑤	5 1/2"-7 1/2" (14-19 cm)	Normal	1,850	④
		TwinBooster, level 1	2,500	
		TwinBooster, level 2	3,000	
		Total	11,500	

¹ Cookware with a base diameter within the given range may be used.

² The power indicated may vary depending on the size and material of the cookware used.

³ The cooking zone is linked to this cooking zone electrically so that the rating can be increased; see "Overview – Power management system".

Overview

Power management system

Total power

The cooktop has a maximum total permitted power consumption which cannot be exceeded for safety reasons.

The higher the total permitted power consumption of the cooktop, the more power levels/functions can be used on all cooking zones at the same time.

If the set power levels/functions require more power than can be provided in accordance with the total permitted power consumption, the cooktop will distribute the maximum permitted power between the cooking zones.

Distribution of power

Cooking zones can be linked together in pairs on the cooktop. This allows power to be transferred from one cooking zone (A) to another (B). As a result, the power of cooking zone (A) is reduced.

Example: The Booster function for cooking zone (B) is activated.

Cooking zone (B), which requires additional power, is determined by the most recent setting on the cooktop.

The values for the maximum total permitted power consumption and which cooking zones are linked together can be found in "Overview – Cooking zone data".

You can reduce the maximum total permitted power consumption; see "Customizing settings".

Effects of power distribution

If a cooking zone gives power to another zone, this can have the following effects on the zone giving the power:

- The power level is reduced.
- Auto heat-up will be deactivated. Cooking continues at the set level. If the power is not sufficient, the power level will be reduced again.
- The Booster function is deactivated.
- The cooking zone is switched off.

When the cooking zone stops transferring power to the other zone, the power level can be increased again.

Tip: If you wish to cook a large quantity of food on one cooking zone, switch the other cooking zones to lower power levels.

Operation

Cooktop when switched off

When the cooktop is switched off, you can only see the printed symbols for the sensor controls and the numerical display. More sensor controls light up when the cooktop is switched on.

Operation

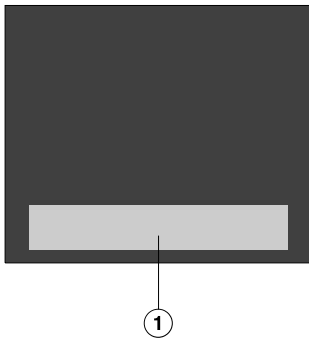

① Sensor controls and indicators

This glass-ceramic cooktop is equipped with sensor controls which react to finger contact.

Each time a sensor control is activated, an audible signal sounds.

For safety reasons, in order to switch the appliance on, the On/Off ① sensor control needs to be touched for a little longer than the other sensors.

Overview

Networking

Your cooktop is equipped with an integrated WiFi module. The cooktop can be connected to your home WiFi network or simply to your Miele ventilation hood.

Miele@home

After installing the Miele app on a mobile device, you can do the following:

- call up information on the operating status of your cooktop
- call up information on the program sequence of your cooktop
- set up a Miele@home network with other WiFi-enabled Miele domestic appliances
- control a connected Miele ventilation hood automatically via the cooktop settings (Con@ctivity 3.0)

Direct connection with the ventilation hood

Once you have established a direct connection with a Miele ventilation hood, you can do the following:

- control a connected Miele ventilation hood automatically via the cooktop settings (Con@ctivity 3.0)

Functions

Con@ctivity 3.0

Con@ctivity 3.0 is the direct communication system between your cooktop and a Miele ventilation hood. Communication is achieved by means of networking. Con@ctivity 3.0 enables the ventilation hood to operate automatically depending on the operating status of your cooktop.

Additional information can be found in the operating and installation instructions for your ventilation hood.

Permanent pan recognition

When you place cookware on a cooking zone, the numerical display for the cooking zone is activated automatically.

Pan and pan size recognition

The cookware and its size are detected within a cooking zone. The release of energy is adapted to the size of the pan.

Booster

When the Booster function is activated, the power is boosted so that large quantities can be heated up quickly, e.g., when boiling water for cooking pasta.

Stop & Go

When Stop & Go is activated, the power level of all cooking zones in use is reduced to power level 1. When Stop & Go is deactivated, the cooking zones will operate at the power level previously selected.

Tip: Use this function if there is a danger of food boiling over.

Additional power levels

You can activate additional levels between the existing power levels. These intermediate levels allow you to adjust the power more precisely for the cookware.

Auto heat-up

When Auto heat-up has been activated, the cooking zone switches on automatically at the highest setting and then switches to the power level (continued cooking level) which you have previously selected.

Timer

The timer can be used for the following 2 functions:

- setting the kitchen timer
- automatically switching a cooking zone off

You can use the functions simultaneously.

Kitchen timer

You can set a timer for activities that are independent of the cooktop.

Safety shut-off

You can set a time after which the cooking zone will reduce automatically to power level 1. This function can be used on all cooking zones at the same time.

System lock

If the system lock is activated, then the cooktop cannot be switched on.

Overview

Safety lock

The safety lock is activated while the cooktop is switched on. When the safety lock is activated, the cooktop can only be operated under certain conditions.

Keeping warm

This function enables food to be kept warm after it has finished cooking.

The maximum duration for keeping food warm is 2 hours.

Wipe protection

The cooktop sensor controls can be locked for 20 seconds, e.g., to remove soiling. The ⓘ sensor control is not locked.

Programming

You can adapt the programming of the cooktop to your personal needs.

Demo mode

This function enables the cooktop to be demonstrated in dealer showrooms without heating up.

Residual heat indicator

If a cooking zone is still hot, the residual heat indicator will light up after it has been switched off. Depending on the temperature, a dot will appear above power levels 1, 2, and 3.

The dots in the residual heat indicator go out one by one as the cooking zones cool down. The last dot only goes out when the cooking zone is safe to touch.

Safety shut-off

Sensor controls are covered

Your cooktop will turn off automatically if one or several of the sensor controls remain covered for longer than 10 seconds; for example, by finger contact, food boiling over, or an object.

① flashes briefly above the \square sensor control and a tone will sound.

\square will go out once you have removed the object and/or cleaned the soiling and the cooktop will be ready to use again.

Excessive operating time

The safety shut-off mechanism is triggered automatically if a cooking zone is heated for an unusually long period of time. This time depends on the power level selected. If the time has been exceeded, the cooking zone switches to power level 1. If you turn the cooking zone off and on again, it will be ready for operation again.

You can adjust the safety shut-off by changing the safety setting (see “Customizing settings”).

Power level*	Maximum operating time [h:min]		
	Safety setting		
	0**	1	2
1	10:00	8:00	5:00
1.	10:00	7:00	4:00
2/2.	5:00	4:00	3:00
3/3.	5:00	3:30	2:00
4/4.	4:00	2:00	1:30
5/5.	4:00	1:30	1:00
6/6.	4:00	1:00	00:30
7/7.	4:00	00:42	00:24
8	4:00	00:30	00:20
8.	4:00	00:30	00:18
9	1:00	00:24	00:10

* The power levels with a dot after the number are only available if the power level range has been extended (see “Setting ranges”).

** Factory default setting

Overview

Overheating protection

In order to prevent the cooktop from being damaged by excessive temperatures, the overheating protection mechanism intervenes in one of the following ways:

Overheating protection measures

- If the Booster function is switched on, it will stop.
- The set power level will be reduced.
- A cooking zone will switch off. *Err* will flash alternately with *044* in the timer display.
- All cooking zones will switch off.

Triggering the overheating protection mechanism

The overheating protection may be activated under the following circumstances:

- The cookware being heated is empty.
- Fat or oil is being heated on a high power level.
- There is insufficient ventilation to the underside of the cooktop.
- A hot cooking zone is turned back on after a power failure.

Unpacking the cooktop

- Please stick the extra data plate for the appliance supplied with this documentation in the space provided in the “Customer Service” section of this manual.
- Remove any protective foil and stickers.

Cleaning the cooktop for the first time

- Before using it for the first time, clean the cooktop with a damp cloth.
- Wipe the cooktop dry.

Switching on the cooktop for the first time

The metal components have a protective coating. When the cooktop is used for the first time, this causes a smell and possibly also vapor. The heating of the induction coils also causes odors in the first few hours of operation. With each subsequent use, the odors are reduced until they disappear completely.

The smell and any vapors do not indicate a faulty connection or a defective appliance and are not harmful to your health.

Commissioning

Miele@home

Installing the Miele app

The ability to use the Miele app depends on the availability of the Miele@home service in your country. For information about availability, please visit www.miele.com.

The Miele app is available free of charge from the Apple App Store® or from the Google Play Store™.



- Install the Miele app on your device.

Setting up Miele@home

The WiFi connection shares a frequency range with other appliances (including microwave ovens and remote control toys). This can give rise to sporadic or even complete connection failures. Therefore, the availability of featured functions cannot be guaranteed.

The cooktop requires max. 2 W in networked standby.

There are a number of ways of connecting your cooktop to your WiFi network.

Connecting via the Miele app

- A home WiFi network is available.
- The signal of your WiFi network is sufficiently strong in the place where your cooktop is installed.
- There is no direct WiFi connection between the cooktop and a Miele ventilation hood (Con@ctivity 3.0).
- The Miele app is installed on your device.

- Start the Miele app.
- Switch the cooktop on.
- Touch the 0 sensor control on any of the numerical displays.
- Touch the 0 and 5 sensor controls at the same time for 6 seconds.

The seconds can be seen counting down in the timer display. After this time has elapsed, the code `[:07]` is displayed in the timer display for 10 seconds.

You now have 10 minutes to configure the WiFi.

- Follow the user navigation in the app.

You can use all Miele@home functions.

Commissioning

Connecting via WPS

- A home WiFi network is available.
- The signal of your WiFi network is sufficiently strong in the place where your cooktop is installed.
- There is no direct WiFi connection between the cooktop and a Miele ventilation hood (Con@ctivity 3.0).
- You must have a WPS (WiFi protected setup) compatible router.

- Touch the 0 sensor control on any of the numerical displays.
- Touch the 0 and 6 sensor controls at the same time for 6 seconds.

The seconds can be seen counting down in the timer display. After the time has elapsed, a progress light appears in the timer display during the connection attempt (for max. 120 seconds).

The WPS login is active during these 120 seconds.

- Activate the WPS function on your WiFi router.

If the connection was successful, the code `∞:02` appears in the timer display. If the connection could not be established, the timer display will show the code `∞:01`. You have probably not activated WPS on your router quickly enough. Repeat the steps above.

- Install the Miele app.
- Follow the user navigation in the app.

You can use all Miele@home functions.

Tip: If your WiFi router does not support WPS, please connect via the Miele app.

Canceling the process

- Touch any sensor control.

Resetting settings

Reset the settings if you are disposing of your cooktop, selling it, or putting a used cooktop into operation. This is the only way to ensure that all personal data has been removed and the previous owner will no longer be able to access the cooktop.

Resetting is not required when replacing the router.

- Switch the cooktop on.
- Press the 0 sensor control on any numerical display.
- Touch the 0 and 9 sensor controls at the same time for 6 seconds.

The seconds can be seen counting down in the timer display.

After this time has elapsed, the code `ℓ:00` is displayed in the timer display for 10 seconds.

Commissioning

Establishing a direct connection with the ventilation hood

The cooktop requires max. 2 W in networked standby.

Availability of the Wi-Fi connection

The Wi-Fi connection shares a frequency range with other appliances (including microwave ovens and remote control toys). This can cause sporadic or even complete connection failures. Therefore, the availability of featured functions cannot be guaranteed.

Establishing a direct connection with the ventilation hood

You can find the necessary information on connecting the ventilation hood in the associated operating and installation instructions.

- Miele ventilation hood with Con@ctivity 3.0
- The cooktop is not connected to your home network (Miele@home)

- Switch the cooktop on.
- Press the 0 sensor control on any numerical display.
- Touch the 0 and 7 sensor controls at the same time for 6 seconds.

The seconds can be seen counting down in the timer display. After the time has elapsed, a progress light appears in the timer display during the connection attempt. If the connection was successful, the code `C:D2` appears in the timer display. If the connection could not be established, the timer display will show the code `C:D1`. Repeat the steps above.

When successfully connected, 2 and 3 will light up constantly on the ventilation hood.

- Quit connection mode on the ventilation hood by pressing the run-on  button.

Con@ctivity 3.0 is now activated.

Canceling the process

- Touch any sensor control.

Resetting settings

Reset the settings if you are disposing of your cooktop, selling it, or putting a used cooktop into operation. This is the only way to ensure that all personal data has been removed and the previous owner will no longer be able to access the cooktop.

Resetting is not required when replacing the router.

- Switch the cooktop on.
- Press the 0 sensor control on any numerical display.
- Touch the 0 and 9 sensor controls at the same time for 6 seconds.

The seconds can be seen counting down in the timer display.



After this time has elapsed, the code `ℓ:00` is displayed in the timer display for 10 seconds.

Operation

Safety notes for operation

 Fire hazard due to overheated food.
Unattended food can overheat and ignite.
Do not leave the cooktop unattended while it is being used.

 Risk of burning or scalding due to hot cooking zones.
The cooking zones will be hot after use.
Do not touch the cooking zones while the residual heat indicators are on.

 Risk of burning due to hot items.
When the cooktop is switched on either deliberately or by mistake, or when there is residual heat present, there is the risk of metal items placed on the cooktop heating up.
Do not store items on the cooktop.
After use, switch the cooktop off with the  sensor control.

The cooking result can be negatively affected if food is kept warm at excessively high temperatures. Food can change color and even spoil.

 Placing hot cookware on the sensor controls and indicators can damage the electronic underneath.
The sensor controls do not respond.
They may be switched on or off unintentionally.
The cooktop will switch itself off (see “Overview – Safety shut-off”).
Do not place hot cookware over the sensor controls or indicators.

Switching the cooktop on

- Touch the ① sensor control.

Additional sensor controls will light up.

If no further entry is made, the cooktop will turn itself off after a few seconds for safety reasons.

Switching off a cooking zone/ the cooktop

Switching off the cooktop

- To switch off the cooktop and all the cooking zones, touch the ① sensor control.

Switching off a cooking zone

- To switch off a cooking zone, touch the 0 sensor control on the numerical display for that cooking zone.

Power level

Setting the power level

Permanent pan recognition is activated as standard (see “Customizing settings”). When the cooktop is switched on and you place an item of cookware on one of the cooking zones, all the sensor controls for the numerical display will light up.

- Place the cookware on the cooking zone you want to use.
- Touch the 0 sensor button on the relevant numerical display.
- Touch the appropriate sensor control for the power level you want on the relevant numerical display.

Setting the power level – extended power level range

The extended setting range for the power levels is activated (see “Customizing settings”).

- Press the numerical display between the sensor controls.

The numbers to the left and right of the interim level light up brighter than the other sensor controls.

Example:

If you have set power level 7., the numbers 7 and 8 will be brighter than the other numbers.

Changing the power level

- Touch the appropriate sensor control for the power level you want on the numerical display.

Operation

Booster

Activating the Booster function

When the Booster function is activated, the settings for the linked cooking zone may be changed (see “Overview – Power management system”).

The Booster function can be used on a maximum of 2 cooking zones at the same time.

The Booster function is active for a maximum of 15 minutes.

TwinBooster level 1

- Place the cookware on the cooking zone you want to use.
- Select a power level, if necessary.
- Touch the **B** sensor control.

The indicator light ● for TwinBooster level 1 lights up.

TwinBooster level 2

- Place the cookware on the cooking zone you want to use.
- Select a power level, if necessary.
- Touch the **B** sensor control twice.

The indicator light ●● for TwinBooster level 2 lights up.

Deactivating the Booster function

- Touch the **B** sensor control repeatedly until the indicator lights go out.

or

- Select a different power level.

If you deactivate the Booster function or the Booster time comes to an end and

- no power level was selected before activating the Booster function, the cooking zone will revert automatically to level 9.
- a power level was selected before activating the Booster function, the cooking zone will revert automatically to the previously selected level.

Activating/deactivating Stop & Go

The cooking zone power levels and the timer settings cannot be altered; the cooktop can only be switched off. The kitchen timer, switch-off, Booster, and heat-up times continue to run.

If the function is not deactivated within 1 hour, the cooktop will switch off.

- Touch the **II/▶** sensor control.

Auto heat-up

The heat-up time depends on which continued cooking level has been chosen:

Continued cooking level*	Heat-up time [min:sec]
1	approx. 00:15
1.	approx. 00:15
2	approx. 00:15
2.	approx. 00:15
3	approx. 00:25
3.	approx. 00:25
4	approx. 00:50
4.	approx. 00:50
5	approx. 2:00
5.	approx. 5:50
6	approx. 5:50
6.	approx. 2:50
7	approx. 2:50
7.	approx. 2:50
8	approx. 2:50
8.	approx. 2:50
9	–

* The continued cooking levels with a dot after the number are only available if the power level range has been extended (see “Customizing settings”).

Activating Auto heat-up

- Touch the sensor control for the continued cooking level you want until a tone sounds and the sensor control starts to pulsate.

During the heat-up time (see table) for a selected:

- continued cooking level, the set continued cooking level will pulsate
- interim power level, the sensor controls in front of and after the interim power level will pulsate

Deactivating Auto heat-up

- Tap the sensor control of the set continued cooking level.

or

- Select a different power level.

Operation

Timer

Setting timer durations

A duration of between 1 minute (0:01) and 9 hours 59 minutes (9:59) can be set.

Durations of up to 59 minutes are shown in minutes (00:59) and durations of more than 60 minutes are shown in hours and minutes.

Durations are entered:

- using the left or front left numerical display (depending on the model) in the case of a kitchen timer
 - using the numerical display of the cooking zone to be switched off automatically in the case of a switch-off time
- Enter durations in the order of hours, followed by minutes in tens and then units.

Example:

59 minutes = 0:59 hours,

Enter: 5-9

80 minutes = 1:20 hours,

Enter: 1-2-0

After the first number has been entered, the timer display will light up constantly. After the second number has been entered, the first number will move to the left. After the third number has been entered, the first and second numbers will move to the left.

Setting the kitchen timer

- Touch the  sensor control.

The timer display flashes.

- Set the required duration (see “Timer – Setting timer durations”).

Touch the  sensor control or wait 10 seconds to start the kitchen timer.

Changing the kitchen timer



- Touch the  sensor control.

The timer display flashes.

- Set the required duration (see “Timer – Setting timer durations”).

Touch the  sensor control or wait 10 seconds to start the kitchen timer.

Deleting the kitchen timer

- Touch the  sensor control.
- Touch  on the numerical display.

Setting the switch-off time

A cooking zone will switch off when the maximum operating time has elapsed, independently of a set switch-off time (see “Overview – Safety shut-off”).

A power level is set for the desired cooking zone.

- Touch the ⏸ sensor control.

The timer display flashes.

- Set the required duration (see “Timer – Setting timer durations”).

Touch the ⏸ sensor control or wait 10 seconds to start the switch-off time.

The switch-off time for the cooking zone elapses and the cooking zone allocation safety shut-off indicator light pulsates.

Changing the switch-off time

- Touch the ⏸ sensor control repeatedly until the indicator light for the cooking zone you require pulsates.

The timer display flashes.

- Set the required duration (see “Timer – Setting timer durations”).

Touch the ⏸ sensor control or wait 10 seconds to start the switch-off time.

The switch-off time for the cooking zone elapses and the cooking zone allocation safety shut-off indicator light pulsates.

Deleting the switch-off time

- Touch the ⏸ sensor control repeatedly until the indicator light for the cooking zone you require pulsates.

The timer display flashes.

- Touch the ⏸ sensor control on the numerical display.

Setting multiple switch-off times

- To set a switch-off time for another cooking zone, follow the steps described in “Operation – Setting the switch-off time”.

If more than one switch-off time is programmed, the shortest time remaining will be displayed and the corresponding indicator light will pulsate. The other indicator lights will light up constantly.

Displaying switch-off times



- If you want to show the time left for another cooking zone which is counting down in the background, touch the ⏸ sensor control repeatedly until the indicator light for the desired cooking zone pulsates.

The **rounded** time left is displayed for the required cooking zone.

Operation

Using both timer functions at the same time

If you use both functions simultaneously, the shortest time is always displayed. The  sensor control (kitchen timer) or the indicator light of the cooking zone with the shortest switch-off time pulsates.

- If you want to show the times left counting down in the background, touch the  or  sensor control.
- If a switch-off time has been programmed for several cooking zones, touch the  sensor control repeatedly until the indicator light for the required cooking zone pulsates.

System lock

Activating the system lock

All sensor controls are locked. A set kitchen timer will continue to count down.

- Touch the ① sensor control for 6 seconds.

The seconds can be seen counting down in the timer display. When this time has elapsed, *LDC* will appear in the timer display. The system lock is activated.

If a disallowed sensor control is touched whilst the system lock is activated, *LDC* will appear in the timer display for a few seconds and a buzzer will sound.

The system lock can be programmed to be activated automatically 5 minutes after the cooktop has been switched off (see “Customizing settings”).

Deactivating the system lock

- Touch the ① sensor control for 6 seconds.

LDC will appear briefly in the timer display and then the seconds will count down. The system lock is deactivated once the time has elapsed.

Safety lock

Activating the safety lock

When the safety lock is activated:

- the cooking zones and the cooktop can only be switched off
- a set kitchen timer can be modified

- Touch and hold the ⏸ and II/▶ sensor controls at the same time for 6 seconds.

The seconds can be seen counting down in the timer display. When this time has elapsed, *LDC* will appear in the timer display. The safety lock is activated.

If a disallowed sensor control is touched while the safety lock is activated, *LDC* will appear in the timer display for few seconds and a buzzer will sound.

Deactivating the safety lock

- Touch and hold the ⏸ and II/▶ sensor controls at the same time for 6 seconds.

LDC will appear briefly in the timer display and then the seconds will count down. Once the time has elapsed, the safety lock function is deactivated.

Operation

Keeping warm

Activating/deactivating the Keeping warm function

- Touch the  sensor control for the cooking zone you wish to use.

Keeping warm temperatures for various applications

A keeping warm temperature of 185°F (85°C) is set as standard. You can change the keeping warm temperature (see “Customizing settings”).

Application	Temperature (°F (°C))
Melting chocolate	120-130 (50-55)
Keeping solid food and thick liquids warm	150-167 (65-75)
Keeping clear soups warm	175-195 (80-90)

Tips for keeping food warm

- Only use cookware (pots/pans) for keeping food warm. Cover the cookware with a lid.
- Stir firm or viscous food (mashed potatoes, stew) occasionally.
- Foods begin to lose their nutrients during the cooking process and continue to do so while being kept warm. The longer food is kept warm, the greater the loss of nutrients. Try to ensure that food is kept warm for as short a time as possible.

Wipe protection

Activating wipe protection

- Touch the  sensor control.

The time counts down in the timer display.

Deactivating wipe protection

- Touch the  sensor control until the timer display goes out.

Cooktop data

Displaying the model identifier/serial number

There must not be any cookware on the cooktop.

- Switch the cooktop on.
- Press the 0 sensor control on any numerical display.
- Press the 0 and 4 sensor controls on the numerical display at the same time for 6 seconds.

Numbers will appear in the timer display one after another, separated by a dash.

Example: *12 34* (model identifier KM 1234) – *1 23 45 67 89* (serial number)

Displaying the software version

There must not be any cookware on the cooktop.

- Switch the cooktop on.
- Press the 0 sensor control on any numerical display.
- Press the 0 and 3 sensor controls on the numerical display at the same time for 6 seconds.

3 numbers appear in the timer display:

Example: *123* = software version 1.23.

Activating/deactivating demo mode

- Switch the cooktop on.
- Press the 0 sensor control on any numerical display.
- Press the 0 and 2 sensor controls on the numerical display at the same time for 6 seconds.

The following will flash in the timer display for a few seconds:

- *dE* alternating with *On* (demo mode activated)
- or
- *dE* alternating with *OFF* (demo mode deactivated)

Setting ranges

The cooktop is programmed with 9 power levels at the factory. If you wish to fine-tune a setting, you can extend the power level range to 17 power levels (see “Customizing settings”).

	Setting range	Extended setting (17 power levels)
Melting butter, chocolate, etc. Dissolving gelatin Keeping soups and sauces warm	1–2	1–2.
Making vanilla puddings and other puddings	2	2–2.
Defrosting frozen vegetables (in a block) Keeping soups and sauces warm and preparing rice Preparing rolled oats, grits, polenta, risotto, rice pudding, couscous, dulce de leche	2–4	2.–4.
Cooking noodles, matzoh balls, ravioli, gnocchi, and tortellini Poaching eggs Heating liquid and semi-solid dishes Preparing omelettes or fried eggs Steaming fruit, making compote Defrosting and heating frozen food	4–5	3.–5.
Steaming vegetables, fish, shellfish, mussels Gently frying eggs (without overheating the fat) Frying pancakes Preparing paella	5–6	4.–6.
Cooking large quantities of food, such as casseroles Thickening puddings and sauces, such as hollandaise Simmering for a stew Toasting nori, tortillas, pita, flat bread, etc. Toasting nuts Frying bacon	6–7	5.–7.
Searing meat, chicken, fish, or sausage Cooking meat (such as hamburger, kebabs, and steak), fish, and chicken Frying crêpes, etc.	6–8	6.–8.
Making marmalade and jelly	8	8–8.
Cooking meat, chicken, fish, and vegetables Cooking at hot temperatures in a wok, stir-frying	7–9	7.–9
Frying, e.g., French fries	9	8.–9
Boiling water or other liquid	Booster	Booster

These settings should only be taken as a guide. The power of the induction coils will vary depending on the voltage, size, and material of the cookware base. For this reason, it is possible that the power levels will need to be adjusted slightly to suit your cookware. As you use the cooktop, you will get to know which settings suit your cookware best. When using new cookware that you are not familiar with, set the power to one level below the one specified.

How induction cooktops work

An induction coil is located under each cooking zone. The coil creates a magnetic field that reacts directly with the base of the pan and heats it up. The cooking zone itself is heated up indirectly by the heat given off by the pan.

An induction cooking zone only works when a piece of cookware with a magnetic base is placed on it (see “Good to know – Cookware”). The induction cooking zone automatically recognizes the size of the cookware.

Noises

When you use induction cooking zones, the following noises may occur, depending on the type and shape of the cookware base:

On the higher power levels, it might buzz. This will decrease or cease altogether when the power level is reduced.

Cookware with bases made of different materials (e.g., sandwich bases) may produce a crackling noise.

Whistling might occur if linked cooking zones (see “Operation – Booster”) are being used at the same time, and the cookware items also have bases made of layers of different materials (e.g., sandwich bases).

The electronics may produce a clicking sound, especially at lower power levels caused by switching operations.

You may hear a whirring sound when the cooling fan turns on. It turns on to protect the electronics when the cooktop is being used intensively. The fan may continue to run after the cooktop has been switched off.

Good to know

Cookware

Suitable cookware

- stainless steel with a magnetic base
- enameled steel
- cast iron

The composition of the pan base can affect the evenness of the cooking results (e.g., when making pancakes). The base of the pan must be able to distribute the heat evenly. Cookware with a base made from multilayer material (triply or encapsulated base) is ideal in this case.

Unsuitable cookware

- Stainless steel without a magnetic base
- Aluminum or copper
- Glass, ceramics, earthenware, stoneware

Testing cookware

To test whether a pot or pan is suitable for use on an induction cooktop, hold a magnet to the base of the pan. If the magnet sticks, the cookware is generally suitable.

Cookware tips

- Position the cookware as centrally as possible on the relevant cooking zone/cooking area.
 - To make optimum use of the cooking zones, choose cookware with a suitable base diameter (see “Overview – Cooking zone data”). If the cookware is too small it will not be recognized.
 - Use only pots and pans with smooth bases. Rough bases can scratch the ceramic glass.
 - Always lift the cookware to move it. This will help prevent scratching. If any scratches do appear as a result of cookware being pushed around, this will not affect the function of the cooktop. These scratches are normal signs of use and are not grounds for making a complaint.
- Please note that the pot or pan diameter quoted by manufacturers often refers to the maximum diameter or diameter of the top rim. The diameter of the base (generally smaller) is more important.

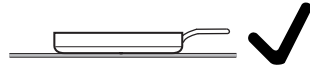

- Where possible, use cookware with vertically straight sides. If pans with sloped sides are used, the induction also takes effect around the edges of the pan. This can cause the edge of the pan to become discolored or the coating to peel off.

Customizing settings

Accessing programming mode

The **II/▶** sensor control is located approx. 1/2" (1 cm) (index finger width) to the left of the **⓪** sensor control.

The cooktop is switched off.

- Touch and hold the **⓪** and **II/▶** sensor controls until the **⊕** sensor control lights up and **PC** appears in the timer display.

After a few seconds **P:01** (Program 01) will flash alternately with **C:01** (Code) in the timer display.

Setting the program

For a two-digit program number you first need to set the tens position.

- While the program is visible in the display (e.g., **P:01**), touch the **⊕** sensor control repeatedly until the number for the program you want appears in the display or touch the appropriate number on the numerical display.

Setting the code

- While the code is visible in the display (e.g., **C:01**), touch the **⊕** sensor control repeatedly until the number for the code you want appears in the display or touch the appropriate number on the numerical display.

Saving the settings

- While the program is visible in the display (e.g., **P:01**), touch the **⓪** sensor control until the indicators go out.

To avoid saving the settings

- While the code is showing in the display (e.g., **C:01**), touch the **⓪** sensor control until the indicators go out.

Customizing settings

Program ¹		Code ²	Settings
P:01	Demo mode	C:00	Demo mode off
		C:01	Demo mode on ³
P:03	Factory default	C:00	Do not restore factory default settings
		C:01	Restore factory default settings
P:04	Power level setting range	C:00	9 power levels + Booster
		C:01	17 power levels + Booster ⁴
P:06	Audible tone when a sensor control is touched	C:00	Off ⁵
		C:01	Quiet
		C:02	Medium
		C:03	Loud
P:07	Audible signal for timer	C:00	Off
		C:01	Quiet
		C:02	Medium
		C:03	Loud
P:08	System lock	C:00	System lock can only be activated manually
		C:01	System lock activated automatically
P:09	Maximum operating time	C:00	Safety setting 0
		C:01	Safety setting 1
		C:02	Safety setting 2

Customizing settings

Program ¹		Code ²	Settings
P:10	WiFi registration	C:00	Not active/deactivated
		C:01	Active but not configured
		C:02	Active and configured (cannot be selected; displays whether connection was successful)
		C:03	Connection possible via WPS push button
		C:04	WiFi reset to default (C:00)
		C:05	Direct WiFi connection of cooktop and ventilation hood without Miele app (Con@ctivity 3.0)
P:12	Sensor controls reaction speed	C:00	Slow
		C:01	Normal
		C:02	Fast
P:15	Permanent pan recognition	C:00	Permanent pan recognition off
		C:01	Permanent pan recognition on

Customizing settings

Program ¹		Code ²	Settings
P:25	Keeping warm temperature	C:00	120°F (50°C)
		C:01	130°F (55°C)
		C:02	140°F (60°C)
		C:03	150°F (65°C)
		C:04	160°F (70°C)
		C:05	170°F (75°C)
		C:06	175°F (80°C)
		C:07	185°F (85°C)
		C:08	195°F (90°C)

¹ Programs not shown here have no allocation.

² The factory default setting is shown in bold.

³ After the cooktop has been switched on, *dE* appears in the timer display for a few seconds.

⁴ In the text and tables, the extended power levels are shown with a dot after the number for better understanding.

⁵ The confirmation tone of the On/Off sensor control cannot be switched off.

Cleaning and care

Safety notes on cleaning and care

 Danger of burning due to hot surfaces.

All parts of the cooktop may be hot after use.

Turn off the cooktop.

Allow the cooktop to cool down before cleaning it.

All surfaces could be discolored or damaged if unsuitable cleaning agents are used or if residues from suitable cleaning agents are heated on the cooktop. All surfaces are susceptible to scratching.

Allow the surfaces to cool down before cleaning the cooktop.

Remove any residual cleaning agent immediately.

Do not clean with any abrasive cleaning agents or sharp pointed objects.

- ▶ Do not use a steam cleaner to clean the cooktop.
- ▶ Do not use pointed objects for cleaning.

When to clean

- The entire cooktop should be cleaned after each use.

Removing light soiling

- Clean the entire ceramic surface of the cooktop with a damp, soft cloth and a solution of water and a little washing-up liquid. Please follow the cleaning-agent manufacturer's instructions.

Removing stubborn soiling

- First wipe down the surface with a damp cloth to loosen soiling, then remove stubborn crusting with a glass scraper.
- Clean the glass ceramic surface with the Miele ceramic and stainless steel cleaner (see "Optional accessories – Cleaning and care products") or with a proprietary ceramic glass cleaner. Please follow the cleaning-agent manufacturer's instructions.

Finishing the cleaning process

- Remove all cleaning agent residues with a damp cleaning cloth.
- Dry the ceramic surface of the cooktop after cleaning.

Unsuitable cleaning agents

To avoid damaging the surfaces of the appliance, do not use:

- cleaning agents containing soda, alkalis, ammonia, acids, or chlorides
- stain or rust removers
- abrasive cleaning agents, such as scouring powder, scouring liquid, or pumice stones
- cleaning agents containing solvents
- dishwasher cleaning agents
- grill and oven sprays
- hard, abrasive brushes
- eraser sponges
- sponges

Frequently asked questions

Many malfunctions and faults that can occur in daily operation can be easily remedied. You can save time and money in many cases, as you do not need to contact Miele Customer Service. Information to help you rectify faults yourself can be found at www.miele.com/service. The following tables are designed to help you to find the cause of a malfunction or a fault and to resolve it.

Messages in the display

Problem	Possible cause and solution
Err will flash alternately with 30 in the timer display and a tone will sound.	The cooktop is incorrectly connected. <ul style="list-style-type: none"> ■ Disconnect the cooktop from the electrical power supply. ■ Contact Customer Service. The cooktop must be connected to the power supply according to the wiring diagram.
After the cooktop has been switched on, or after touching a sensor control, LOC appears in the timer display for a few seconds.	The system lock is activated. <ul style="list-style-type: none"> ■ Deactivate the system lock (see “Operation – Deactivating the system lock”).
	The safety lock is activated. <ul style="list-style-type: none"> ■ Deactivate the safety lock (see “Operation – Deactivating the safety lock”).
After the cooktop has been switched on, dE appears briefly in the timer display. The cooking zones do not heat up.	The cooktop is in demo mode. <ul style="list-style-type: none"> ■ Press the 0 sensor control on any numerical display. ■ Then touch the 0 and 2 sensor controls at the same time until dE flashes alternately with OFF in the timer display.
The cooktop has switched off automatically. When the element is switched back on, 1 appears above the On/Off sensor control.	One or more of the sensor controls are covered, e.g., by finger contact, food boiling over, or an object. <ul style="list-style-type: none"> ■ Clean off any soiling and/or remove the object (see “Overview – Safety shut-off”).
Err will flash alternately with 044 in the timer display.	Overheating protection has been triggered. <ul style="list-style-type: none"> ■ Allow the cooktop to cool down. ■ Rectify the causes of the overheating (see “Overview – Overheating protection”). ■ Check that the cooktop works. ■ If this fault message continues to appear in the display, contact Miele Customer Service.

Frequently asked questions

Problem	Possible cause and solution
<p>Err will flash alternately with <i>047, 048, or 049</i> in the timer display.</p>	<p>The fan is blocked or defective.</p> <ul style="list-style-type: none"> ■ Make sure it has not been blocked by an object. ■ Remove the obstruction. ■ If this fault message continues to appear in the display, contact Miele Customer Service.
<p>In the timer display, an E-number such as E-0 flashes alternately with <i>120, 121, 122, 123, 124, 125, 126, or 127</i>.</p>	<p>The fan is blocked or defective.</p> <ul style="list-style-type: none"> ■ Make sure it has not been blocked by an object. ■ Remove the obstruction. ■ If this fault message continues to appear in the display, contact Miele Customer Service.
<p>A message not listed in this table is appearing in the timer display.</p>	<p>There is an electronic fault.</p> <ul style="list-style-type: none"> ■ Disconnect the power supply to the cooktop for approx. 1 minute. ■ If the problem persists after the power supply has been restored, please contact Customer Service.

Frequently asked questions

Unexpected behavior

Problem	Possible cause and solution
The \cup symbol lights up or flashes alternately with the set power level or β in one of the cooking zone indicators.	No cookware is present on the cooking zone. Unsuitable cookware is present on the cooking zone. The base diameter of the cookware used is too small. Suitable dishware has been removed from the cooking zone. If no cookware or unsuitable cookware is used, the cooking zone will automatically turn off after 15 seconds. ■ Place a suitable item of cookware on the cooking zone within 15 seconds. \cup goes out. The cooking process starts/continues with the previously selected settings. ■ If you are using a different item of cookware and/or food, modify the settings.
Power level 9 is automatically reduced if you also set power level 9 for the connected cooking zone.	Operating both zones at power level 9 exceeds the permitted maximum power for the two zones. ■ Use a different cooking zone.
A cooking zone turns itself off automatically.	It might have been operated for too long. ■ Switch the cooking zone back on (see “Overview – Safety shut-off”).
The cooking zone is not working in the usual way with the set power level.	Overheating protection has been triggered. ■ Allow the cooktop to cool down. ■ Rectify the causes of the overheating (see “Overview – Overheating protection”). ■ Check that the cooktop works. ■ If the problem occurs again, contact Customer Service.
A cooking zone or the whole cooktop switches off automatically.	Overheating protection has been triggered. ■ Allow the cooktop to cool down. ■ Rectify the causes of the overheating (see “Overview – Overheating protection”). ■ Check that the cooktop works. ■ If the problem occurs again, contact Customer Service.

Frequently asked questions

Problem	Possible cause and solution
The Booster level has automatically turned off early.	<p>Overheating protection has been triggered.</p> <ul style="list-style-type: none">■ Allow the cooktop to cool down.■ Rectify the causes of the overheating (see “Overview – Overheating protection”).■ Check that the cooktop works.■ If the problem occurs again, contact Customer Service.

Frequently asked questions

Unsatisfactory results

Problem	Possible cause and solution
Auto Heat-up is turned on, but the food does not start cooking.	Large amounts of food are being heated. <ul style="list-style-type: none">■ Start cooking at the highest power level, then reduce the power level manually.
	The pan is not conducting heat properly. <ul style="list-style-type: none">■ Use a different pan that is able to better conduct heat on an induction cooktop.

General problems or technical faults

Problem	Possible cause and solution
Cooktop or cooking zones cannot be switched on.	There is no power to the cooktop. <ul style="list-style-type: none">■ Check if the breaker has tripped. Contact a qualified electrician or Miele Customer Service (for the minimum fuse rating, see the data plate).
	There may be a technical fault. <ul style="list-style-type: none">■ Disconnect the cooktop from the electricity supply for approx. 1 minute by<ul style="list-style-type: none">– tripping the relevant breaker or unscrewing the fuse completely, or– switching off the residual current device.■ If the cooktop will still not switch on after the fuse or the residual current device has been reset/replaced, contact a qualified electrician or Customer Service.
There is a strange smell or vapors when the cooktop is being used for the first time.	The metal components have a protective coating. When the cooktop is used for the first time, this causes a smell and possibly also vapor. The material from which the induction coils are made also gives off a smell in the first few hours of operation. With each subsequent use, the odors are reduced until they disappear completely. The smell and any vapors do not indicate a faulty connection or a defective appliance and are not harmful to your health.
A noise can be heard after the appliance is turned off.	The fan will continue running until the cooktop has cooled down. It will then turn itself off automatically.

Information to help you rectify faults yourself and about Miele spare parts can be found at www.miele.com/service.

Contact in the event of a fault

In the event of a fault which you cannot remedy yourself, please contact your Miele dealer or Miele Customer Service.

You can book a Miele Service call online at www.miele.com/service.

Contact information for Miele Customer Service can be found at the end of this document.

Please quote the model identifier and serial number of your appliance (SN) when contacting Miele Customer Service. These can be found on the data plate or see “Operation – Cooktop data”.

Data plate

Adhere the extra data plate supplied with the appliance in the space below. Make sure that the model number matches the one specified on the back cover of this document.

Appliance warranty and product registration

You can register your product and/or view the manufacturer’s warranty terms and conditions for Miele appliances and vacuum cleaners at www.mieleusa.com.

Optional accessories

Miele offers a range of useful accessories, as well as cleaning and conditioning products for your appliance.

These products can be easily ordered from the Miele webshop.

Cookware

Miele offers a wide range of cookware. These have all been optimized for Miele appliances in terms of functionality and dimensions. Detailed information can be found on the Miele website.

Cleaning and care products

Ceramic and stainless steel cleaner 250 mL

Removes heavy soiling, lime scale, and aluminum residue.

Microfiber cloth

Removes finger marks and light soiling.

Safety notes for installation

 Risk of damage caused by incorrect installation.

Incorrect installation can damage the cooktop.

The cooktop must only be installed by a qualified specialist.

 Risk of electric shock from voltage.

Incorrect connection to the power supply may result in an electric shock.

The cooktop must be connected to the electrical supply by a qualified electrician only.

 Damage from falling objects.

Take care not to damage the cooktop when installing wall units or a ventilation hood above it.

Install the wall units and ventilation hood before installing the cooktop.

Installation

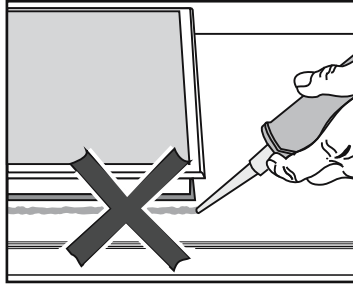

⚠ Damage caused by incorrect installation.

Using sealant under the cooktop could result in damage to the cooktop and the countertop if the cooktop ever needs to be removed for servicing.

Do not use sealant between the cooktop and the countertop. The sealing strip under the edge of the cooktop provides a sufficient seal for the countertop.

Dismantling the cooktop for service purposes may damage the sealing strip underneath the edge of the cooktop.

Always replace the sealing strip before reinstallation.

► Reaching over a hot appliance to access the cabinets can result in burns. You can reduce the risk of burns by installing a ventilation hood that extends at least 5" (12 cm) past the bottom of the cabinets.

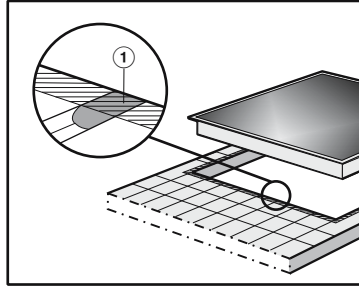

- ▶ Grout lines ① and the hatched area underneath the cooktop frame must be smooth and even. If they are not, the cooktop will not sit flush with the countertop and the sealing strip underneath the cooktop will not provide a good seal between the cooktop and the countertop.
- ▶ The cooktop must not be installed above refrigerators/freezers, dishwashers, or washer/dryers.
- ▶ This cooktop may only be installed above a range or oven if it has a built-in cooling fan.
- ▶ Ensure that the power cord cannot be touched after the cooktop has been installed.
- ▶ After the installation of the cooktop, the electrical cord may not come into contact with any moving kitchen parts (e.g. a drawer) or be subject to mechanical stress.
- ▶ The countertop must be heat-resistant (up to 212°F / 100°C), so that it does not become deformed or the veneer detached. The wall strips must be heat-resistant as well.
- ▶ Remember to maintain the minimum safety distances (see “Installation – Safety distances”).

Installation

Safety distances

Safety distance above the cooktop

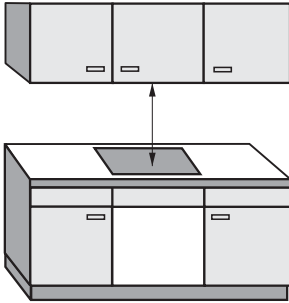

The safety distance specified by the manufacturer of the ventilation hood must be maintained between the cooktop and the ventilation hood above it.

When two or more appliances which have different safety distances are installed together below a ventilation hood, you should observe the greatest safety distance.

If combustible objects are installed above the cooktop (e.g., a suspended rack), a minimum safety distance of 19 3/4" (500 mm) must be maintained.

Safety distance behind and to the side of the cooktop

The minimum safety distances shown below must be maintained between the appliance and a tall cabinet or wall:

- between the **back** ① of the countertop cut-out and the rear edge of the countertop:
2" (50 mm)

and

- on the **right side** ② between the countertop cut-out and the closest adjacent piece of furniture (e.g., tall unit) or a room wall:
2" (50 mm) and on the opposite side a minimum safety distance of 7 7/8" (200 mm)

or

- on the **left side** ③ between the countertop cut-out and the closest adjacent piece of furniture (e.g., tall unit) or a room wall:
2" (50 mm) and on the opposite side a minimum safety distance of 7 7/8" (200 mm)

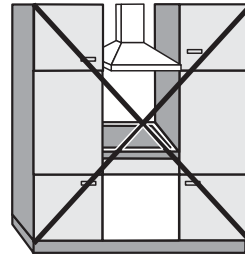

Not allowed

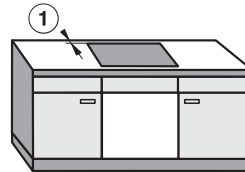
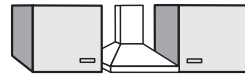

Highly recommended

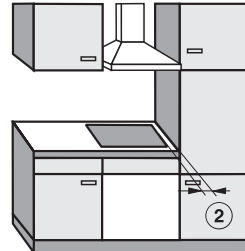

Not recommended

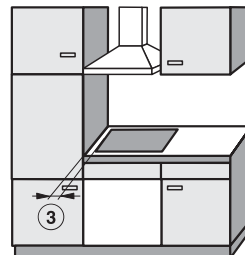

Not recommended

Installation

Minimum safety distance underneath the cooktop

To ensure sufficient ventilation to the cooktop, a minimum safety distance must be left between the underside of the cooktop and any oven, protective base, or drawer.

The minimum safety distance between the underside of the cooktop and	KM 7720 FR, KM 7740 FR	KM 7730 FR
Upper edge of drawer	≥ 3/16" (5 mm)	
Base of drawer	≥ 3" (75 mm)	
Upper edge of oven	≥ 9/16" (15 mm)	
Upper edge of protective base	≥ 9/16" (15 mm)	≥ 3 3/4" (95 mm)

Protective base

Installation of a protective base under the cooktop is allowed but not required.



Side view

- ① Front
- ② Rear air gap

Leave a air gap ② of 3" (75 mm) at the back between the cabinet and the protective base to **accommodate the power supply cord**.

Safety distance from the wall covering

If a wall covering is installed, a minimum safety distance must be maintained between the countertop cut-out and the covering. High temperatures can alter or damage these materials.

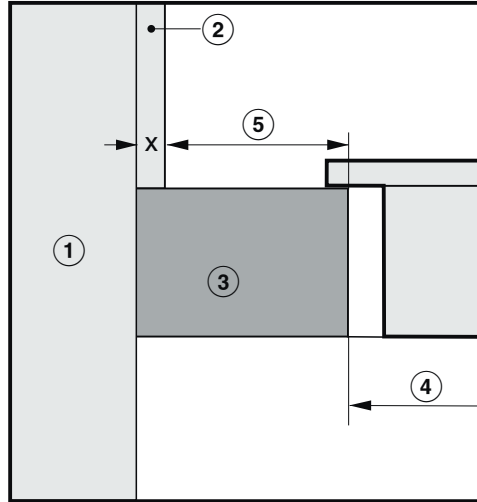

- ① Wall frame
- ② Dimension x = thickness of the wall covering material
- ③ Countertop
- ④ Countertop cut-out
- ⑤ Minimum safety distance to
 - combustible** materials (e.g., wood) 2" (50 mm)
 - non-combustible** materials (e.g., metal, natural stone, ceramic tiles)
2" (50 mm) – dimension x

Example: 1/2" (15 mm) thick non-combustible wall covering
2" (50 mm) – 1/2" (15 mm) = minimum safety distance of 1 3/8" (35 mm)

Installation

Installation dimensions

KM 7720 FR

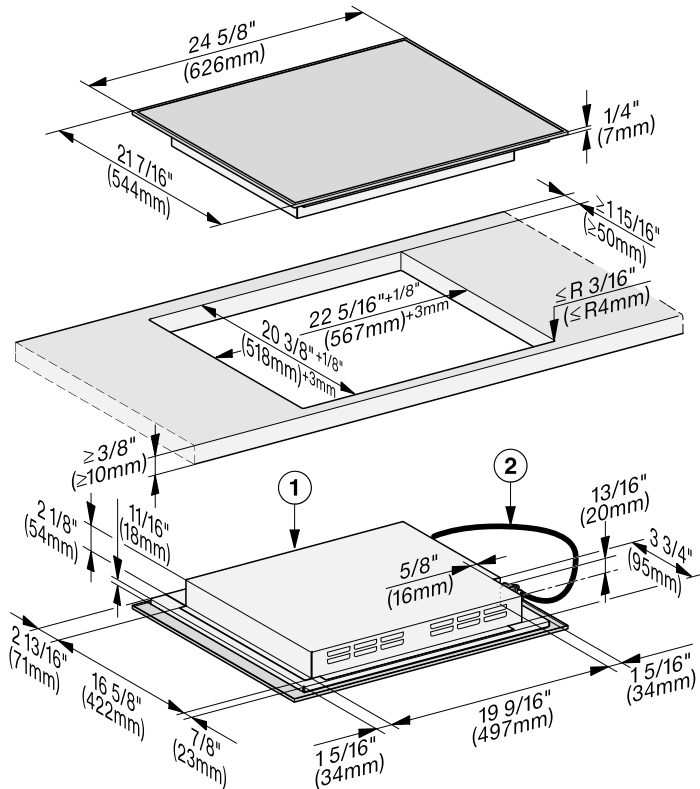

All dimensions are given in mm and inches. The superscript numbers after the cut-out dimensions are the tolerances for the cut-out.

- ① Front
- ② Flexible metal hose with power cords,
L = 4' (1,200 mm)

KM 7730 FR

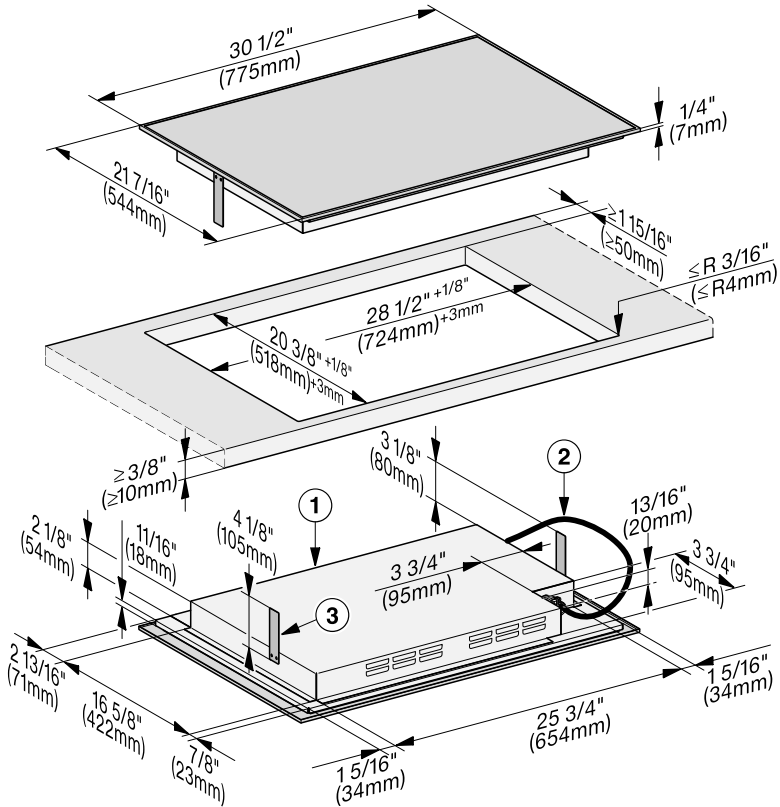

All dimensions are given in mm and inches. The superscript numbers after the cut-out dimensions are the tolerances for the cut-out.

- ① Front
- ② Flexible metal hose with power cords,
L = 4' (1,200 mm)
- ③ Spacer plate (only required if a protective base is installed)

Installation

KM 7740 FR

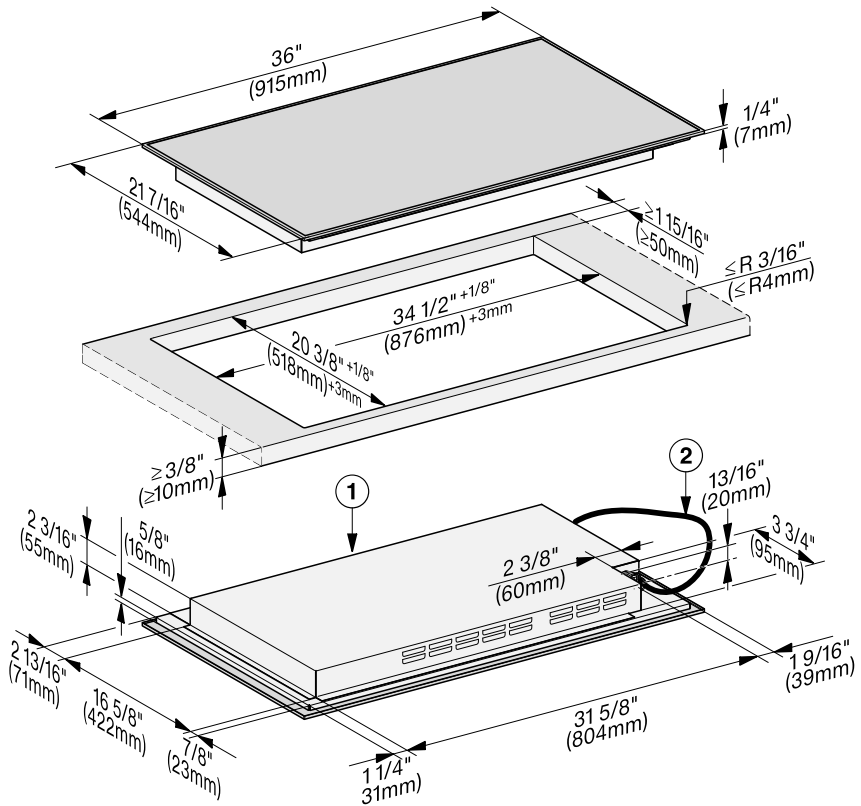

All dimensions are given in mm and inches. The superscript numbers after the cut-out dimensions are the tolerances for the cut-out.

- ① Front
- ② Flexible metal hose with power cords, L = 4' (1,200 mm)

Reinstalling the cooktop

- Create the countertop cut-out. Remember to maintain the minimum safety distances (see “Installation – Safety distances”).
- Seal any cut surfaces on **wooden countertops** with a special varnish, silicone rubber, or resin to prevent the wood from swelling as a result of moisture. The sealant must be temperature-resistant.

Ensure that the sealant does not get on the top surface of the countertop.

- Attach the sealing strip provided underneath the edge of the cooktop. Do not apply the sealing strip under tension.

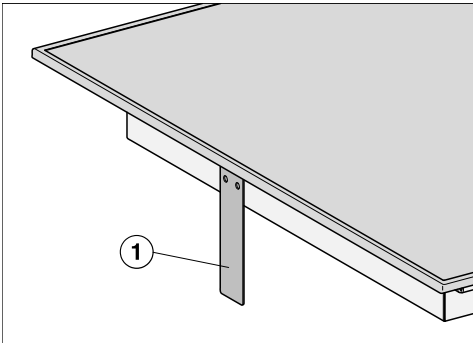

- KM 7730 FR If a protective base is to be installed, fasten one spacer plate on both the left and right side of the cooktop ①.
- Feed the cooktop power supply cord down through the countertop cut-out.

- Place the cooktop centrally in the cut-out. When doing this, make sure that the seal of the appliance sits flush with the countertop on all sides. This is important to ensure an effective seal all round.
- If the seal does not sit flush with the countertop in the corners, the corner radius ($\leq R4$) can be carefully cut to fit using a jigsaw.
- Connect the cooktop to the electrical power supply.
- Check that the cooktop works.

Installation

Electrical connection

 Damage through improper work. Installation, repair, and maintenance work performed by unqualified persons can cause considerable danger to users.

Miele cannot be held liable for any damage arising as a result of such work.

Installation, repair and maintenance work should only be performed by a Miele-authorized qualified electrician in compliance with local regulations and the ANSI National Electrical Code/NFPA 70 in the United States or the Canadian Electric Code, CSA C22.1-02. in Canada.

 Danger of electric shock.

There is a risk of electric shock when performing installation, repair, and service work .

Before performing installation, repair, and service work, disconnect the power supply by either removing the fuse, shutting off the main power or manually “tripping” the circuit breaker.

 Danger of electric shock by missing or interrupted grounding. The appliance may be energized.

To guarantee the electrical safety of this appliance, continuity must exist between the appliance and an effective grounding system. It is imperative that this basic safety requirement be met. If there is any doubt, have the electrical system of the house checked by a qualified electrician.

 Damage by incorrect connection. If the household electrical supply is not suitable for the appliance, it can be damaged.

The voltage and frequency listed on the data plate must correspond with the household electrical supply to prevent damage to the appliance. Ensure that the connection data on the data plate match those of your electrical supply. Consult an electrician if in doubt.

For safety reasons, the cooktop may only be used when it has been fully installed into the countertop.

- Important – Save these instructions for the local electrical inspector’s use.

Connection

- Ensure that the connection data on the data plate (voltage, frequency, and fuse rating) match those of your electrical supply.

The data plate is located underneath the appliance.

The appliance is approved and ready for connection to a grounded connector with three connecting wires, sheathed by a flexible metal hose.

It must be connected to an assigned line in an approved connecting socket.

The appliance must be able to be disconnected from the power supply on all poles by disconnecting devices. When turned off, a contact distance of at least $\frac{1}{8}$ " (3 mm) must be present. The disconnecting devices are overcurrent protection elements and protective circuit breakers.

Black: Connect to L1 (hot)

Red: Connect to L2 (hot)

Green: Connect to GND (ground)

KM 7720, KM 7730

208/240 V, 60 Hz, minimum 32 A
(select a higher protection level if necessary)

KM 7740

208/240 V, 60 Hz, minimum 48 A
(select a higher protection level if necessary)

Make sure that the power outlet is accessible after the installation of the appliance.

Further information can be found on the included data plate.

 **WARNING:**
THIS APPLIANCE MUST BE GROUNDED

Installation

Declaration of conformity

Supplier's Declaration of Conformity 47 CFR § 2.1077 Compliance Information

Induction Cooktop

Unique Identifier: Miele Model: KM7720; KM7730; KM7740

Responsible Party

Miele, Inc.
National Headquarters
9 Independence Way
Princeton, NJ 08540
Phone: 800-843-7232
Fax: 609-419-4298
www.mieleusa.com

FCC Compliance Statement: This device complies with Part 18 of the FCC Rules.

IC Compliance Statement: This device complies with
CAN ICES-001 (B) / NMB-001 (B)

Radio Modules

This device contains the following WiFi module:

FCC ID	2ACUWEK037
IC ID	5669C-EK37
Frequency band	2.412 GHz – 2.462 GHz
Maximum transmitting power	< 0.1 W

Compliance Statement

This device complies with Part 15 of the FCC Rules and contains licence-exempt transmitter(s)/receiver(s) that comply with Innovation, Science and Economic Development Canada's licence-exempt RSS Standard(s).

Operation is subject to the following two conditions:

- (1) this device may not cause harmful interference, and
- (2) this device must accept any interference received, including interference that may cause undesired operation.

The construction of the device assures that the FCC/IC exposure limits are verifiably met using the integrated radio module.

 Warning!

Any changes or modifications to this unit not expressly approved by the party responsible for compliance could void the user's authority to operate the equipment.

**Please have the model and serial number
of your appliance available when
contacting Customer Service.**

U.S.A.

Miele, Inc.

National Headquarters

9 Independence Way
Princeton, NJ 08540
www.mieleusa.com

Customer Support

Phone: 888-99-MIELE (64353)
info@mieleusa.com

International Headquarters

Miele & Cie. KG
Carl-Miele-Straße 29
33332 Gütersloh
Germany

Canada

**Importer
Miele Limited**

Headquarters and Miele Centre

161 Four Valley Drive
Vaughan, ON L4K 4V8
www.miele.ca

Customer Care Centre

Phone: 1-800-565-6435
905-532-2272
customercare@miele.ca

KM 7720 FR, KM 7730 FR, KM 7740 FR

en-US

M.-Nr. 12 155 090 / 04