

Operating and installation instructions Oven





It is **essential** to read these operating and installation instructions before installing and using the appliance. This prevents both personal injury and damage to the appliance.

Contents

Warning and safety instructions	6
Caring for the environment	13
Overview	14
Controls	15
On/Off sensor.....	16
Display.....	16
Sensor controls.....	16
Symbols.....	18
Operating principles	19
Selecting a menu option.....	19
Changing a setting in a list.....	19
Changing the setting with a segment bar.....	19
Selecting a function.....	19
Entering numbers.....	20
Entering letters.....	20
Activating MobileStart.....	20
Features	21
Data plate.....	21
Items supplied.....	21
Accessories supplied and available to order.....	21
Safety features.....	25
PerfectClean treated surfaces.....	26
Pyrolytic accessories.....	26
Before using for the first time	27
Miele@home.....	27
Standard settings.....	28
Heating up the oven for the first time and rinsing the steam injection system.....	29
Settings	31
Settings overview.....	31
Opening the “Settings” menu.....	33
Language 	33
Time.....	33
Date.....	33
Lighting.....	33
Display.....	34
Volume.....	34
Units.....	34
Booster.....	34
Rapid cooling.....	35
Keeping warm.....	35
Recommended temperatures.....	35
Pyrolytic recommendation.....	36
Cooling fan run-on.....	36

Safety	36
Miele@home	37
Performing Scan & Connect	37
Remote control	38
Activating MobileStart	38
RemoteUpdate	38
Software version	39
Showroom programme	39
Factory default	39
Operating hours	39
Minute minder	40
Main and sub-menus	41
Energy saving tips	43
Operation	45
Changing values and settings for a cooking programme	45
Changing the temperature and the core temperature	45
Setting cooking durations	46
Changing the set cooking durations	46
Deleting the set cooking durations	46
Cancelling cooking	47
Pre-heating the oven	47
Booster	48
Pre-heat	48
Rapid cooling	49
Keeping warm	49
Crisp function	50
Moisture Plus	51
Starting the cooking programme with Moisture Plus	51
Evaporate residual moisture	53
Automatic programmes	55
Categories	55
Using Automatic programmes	55
Usage notes	55
Other applications	56
Defrost	56
Drying	56
Heat crockery	57
Keeping warm	58
Low temperature cooking	58
Bottling	59
Frozen food/Ready meals	60
User programmes	61

Contents

Baking	64
Tips on baking	64
Notes on the cooking charts	64
Notes on the oven functions	65
Roasting	66
Tips for roasting	66
Notes on the cooking charts	66
Notes on the oven functions	67
Food probe	68
Grilling	70
Tips for grilling.....	70
Notes on the cooking charts	70
Notes on the oven functions	71
Fan Grill 	72
Grill 	73
Cleaning and care	74
Unsuitable cleaning agents.....	74
Removing normal soiling.....	75
Removing stubborn soiling (excluding the FlexiClip telescopic runners).....	75
Pyrolytic cleaning	76
Descale	79
Removing the door.....	82
Dismantling the door	83
Fitting the door	85
Removing the shelf runners with FlexiClip telescopic runners.....	86
Lowering the top heat/grill element.....	87
Problem solving guide	88
Service	93
Contact in case of fault.....	93
Warranty	93
Installation	94
Building-in dimensions	94
Installation in a tall or base unit.....	94
Side view.....	95
Connections and ventilation	96
Installing the oven	97
Electrical connection	98
Cooking charts	99
Creamed mixture.....	99
Rubbed in mixture	100
Yeast dough.....	101
Quark dough.....	102
Sponge mixture.....	102

Contents

Choux pastry, puff pastry, meringue	103
Savoury snacks	104
Beef	105
Veal	106
Pork.....	107
Lamb, game	108
Poultry, fish.....	109
Technical data	110
Copyright and licences for the communication module.....	110

Warning and safety instructions

This oven complies with all current local and national safety requirements. However, inappropriate use can lead to personal injury and damage to property.

Read the operating and installation instructions carefully before using the oven for the first time. They contain important information on safety, installation, use and maintenance of the appliance. This prevents both personal injury and damage to the oven.

In accordance with standard IEC 60335-1, Miele expressly and strongly advises that you read and follow the instructions in “Installation”, as well as in the “Warning and Safety instructions”.

Miele cannot be held liable for injury or damage caused by non-compliance with these instructions.

Keep these instructions in a safe place and pass them on to any future owner.

Correct application

- ▶ This oven is designed for domestic use and for use in similar environments by guests in hotel or motel rooms, bed & breakfasts and other typical living quarters. This does not include common/shared facilities or commercial facilities within hotels, motels or bed & breakfasts.
- ▶ The oven is not suitable for outdoor use.
- ▶ The oven is intended for domestic use only to bake, roast, grill, cook, defrost, preserve, and dry food. Any other use is not permitted.
- ▶ This oven is not intended for use by persons (including children) with reduced physical, sensory or mental capabilities, or lack of experience and knowledge, unless they are supervised whilst using it. They may only use the oven unsupervised if they have been shown how to use it in a safe manner. They must be able to recognise and understand the dangers of misuse.
- ▶ The oven compartment is equipped with special lamps to cope with particular conditions (e.g. temperature, moisture, chemical resistance, abrasion resistance and vibration). These special lamps must only be used for the purpose for which they are intended. They are not suitable for room lighting. Replacement lamps may only be fitted by a Miele authorised technician or by Miele.

Safety with children

- ▶ Activate the system lock to ensure that children cannot switch on the oven inadvertently.
- ▶ Young children must not be allowed to use this appliance.
- ▶ Older children may only use the oven if its operation has been clearly explained to them and they are able to use it safely. They must be able to understand and recognise the possible dangers caused by incorrect operation.
- ▶ Cleaning work may only be carried out by older children under the supervision of an adult.
- ▶ Children should be supervised in the vicinity of the oven. Never allow children to play with the oven.
- ▶ Risk of suffocation from packaging material. Whilst playing, children may become entangled in packaging material (such as plastic wrapping) or pull it over their head with the risk of suffocation. Keep packaging material away from children.
- ▶ Risk of injury caused by hot surfaces. Children's skin is far more sensitive to high temperatures than that of adults. External parts of the oven such as the door glass, control panel and the vent become quite hot.
Do not let children touch the oven when it is in operation.
- ▶ Risk of injury caused by hot surfaces. Children's skin is far more sensitive to high temperatures than that of adults. The oven gets much hotter during pyrolytic cleaning than during normal use.
Do not let children touch the oven during pyrolytic cleaning.
- ▶ Risk of injury from the open door. The oven door can support a maximum weight of 15 kg. Children could injure themselves on an open door.
Do not let children sit on the open door, lean against it or swing on it.
- ▶ If you touch the  sensor, the door will fully open automatically. In doing so, it can knock against small children or animals, for example. If the buzzers are switched on, a buzzer will sound on the oven when you open the door remotely using a voice-based service. Ensure that no person or object is located within the opening range of the door when it is opened. Make sure that you keep the buzzers switched on.

Warning and safety instructions

Technical safety

- ▶ Unauthorised installation, maintenance and repairs (including removal of any cover) can cause considerable danger for the user. Installation, maintenance and repairs must only be carried out by a Miele authorised technician.
- ▶ Damage to the oven can compromise your safety. Check the oven for visible signs of damage. Do not use a damaged oven.
- ▶ Temporary or permanent operation with a self-sufficient or non-mains synchronous energy supply system (e.g. isolated networks, back-up systems) is possible. A requirement for the operation is that the energy supply system complies with all current local and national requirements that apply to stand-alone, solar and/or battery systems. The protective measures provided in the installation and in this Miele product must also be assured in their function and operation in isolated operation or in non-mains synchronous operation, or replaced with equivalent measures in the installation.
- ▶ The electrical safety of this appliance can only be guaranteed when continuity is complete between it and an effective earthing system. It is essential that this basic safety requirement is present and tested regularly. If in doubt, the electrical installation should be checked by a qualified electrician.
- ▶ The connection data (voltage and frequency) on the data plate of the oven must match the mains electricity supply in order to avoid the risk of damage to the oven. Compare this before connecting the appliance to the mains electricity. If in any doubt, consult a qualified electrician.
- ▶ Multi-socket adapters and extension leads do not guarantee the required safety of the appliance. Do not use these to connect the oven to the mains electricity supply.
- ▶ For safety reasons, the oven may only be used when it has been fully installed.
- ▶ This oven must not be installed and operated in mobile installations (e.g. on a ship).
- ▶ Risk of injury due to electric shock. Any contact with live connections or tampering with the electrical or mechanical components of the oven will endanger your safety and may lead to appliance malfunctions. Do not open the oven housing under any circumstances.
- ▶ The manufacturer's warranty will be invalidated if the appliance is not repaired by a Miele approved service technician.

Warning and safety instructions

- ▶ Miele can only guarantee the safety of the appliance when original Miele spare parts are used. Faulty components must only be replaced by original spare parts.
- ▶ If the oven is delivered without a mains connection cable, a special cable must be installed by a suitably qualified and competent person (see “Installation - Electrical connection”).
- ▶ If the mains connection cable is damaged, it must be replaced with a special connection cable by a suitably qualified and competent person in order to avoid a hazard (see “Installation - Electrical connection”).
- ▶ During installation, maintenance and repair work, the oven must be completely disconnected from the mains electricity supply. To ensure this:
 - Switch off the mains circuit breaker, or
 - switch off at the wall socket and withdraw the plug. To do this, pull the plug and not the mains connection cable.
- ▶ The oven requires a sufficient supply of cool air for efficient operation. Make sure that the supply of cool air is not hindered in any way (e.g. by heat insulation strips fitted in the housing unit). Furthermore, the required supply of cool air must not be excessively heated by other heat sources (e.g. solid fuel stoves).
- ▶ If the oven is built in behind a furniture front (e.g. a door), do not close the furniture door while the oven is in use. Heat and moisture can build up behind the closed furniture door. This can result in damage to the oven, housing unit and floor. Leave the furniture door open until the oven has cooled down completely.

Correct use



- ▶ Risk of injury caused by hot surfaces. The oven gets hot during operation. You could burn yourself on the heating elements, oven compartment, accessories or food. Wear oven gloves when placing food in the oven or removing it, and when adjusting oven shelves etc. in a hot oven.
- ▶ To avoid fuelling any flames, do not open the oven door if smoke occurs inside the appliance. Interrupt the process by switching the appliance off and disconnect it from the mains electricity supply. Do not open the door until the smoke has dispersed.
- ▶ Due to the high temperatures radiated, objects left near the oven could catch fire. Do not use the oven to heat up the room.

Warning and safety instructions

▶ Oils and fats can ignite if allowed to overheat. Never leave the oven unattended when cooking with oil or fats. Never attempt to put out oil or fat fires with water. Switch the oven off and extinguish the flames by leaving the door closed.

▶ Grilling food for excessively long cooking durations can cause it to dry out with the risk of catching fire. Do not exceed the recommended cooking durations.

▶ Certain foods dry out quickly and may catch fire due to high grilling temperatures.

Never use a grill function to finish baking bake-off rolls or bread, or to dry flowers or herbs. Instead, use the Fan Plus  or Conventional Heat  function and always ensure this type of procedure is supervised.



▶ If using alcohol in your recipes, please be aware that high temperatures can cause the alcohol to evaporate. The vapour can catch fire on hot heating elements.

▶ When using residual heat to keep food warm, corrosion from high air humidity and condensation can occur in the oven. This can also cause damage to the control panel, worktop and surrounding kitchen furniture. Keep the oven on and select the lowest temperature available for the selected function. The cooling fan will then continue to run and dissipate the moisture.

▶ Food which is stored in the oven compartment or left in it to be kept warm can dry out and the moisture released can lead to corrosion damage in the oven. Always cover food that is left in the oven to keep warm.

▶ An accumulation of heat can cause the enamel on the floor of the oven to crack or flake off.

Never line the floor of the oven compartment with aluminium foil or oven liners.

If you wish to place crockery on the floor of the oven compartment during cooking, or place crockery on the floor of the oven compartment to heat it up, you can do so, but only with the Fan Plus  or Eco Fan Heat  function without the Booster function.

▶ The oven compartment floor can become damaged by items being pushed around on it. When placing pots, pans or crockery on the oven compartment floor, ensure that you avoid pushing them around.

▶ Danger of injury caused by steam. Pouring a cold liquid onto a hot surface creates steam, which can cause severe scalding. The sudden temperature change can also cause damage to hot surfaces. Never pour cold liquids directly onto hot surfaces.

Warning and safety instructions

- ▶ Danger of injury caused by steam. During cooking processes with moisture injection and during the residual moisture evaporation process, steam is produced which can lead to severe scalding. Never open the door when bursts of steam are being injected or during the evaporation of residual water.
- ▶ It is important that the temperature in the food being cooked is evenly distributed and sufficiently high. This can be achieved by stirring or turning the food.
- ▶ Plastic dishes that are not suitable for use in an oven will melt and may ignite at high temperatures and damage the oven. Use only plastic containers that are suitable for use in an oven. Follow the manufacturer's instructions.
- ▶ Preserving and heating food in sealed tins will result in an increase in pressure, which can cause them to explode. Do not use tins for preserving or heating food.
- ▶ Risk of injury from the open door. You could bang into the open door or trip over it. Avoid leaving the door open unnecessarily.
- ▶ The door can support a maximum load of 15 kg. Do not lean or sit on an open door, or place heavy items on it. Make sure that nothing gets trapped between the door and the oven compartment. This could damage the oven.

The following applies for stainless steel surfaces:

- ▶ The coated stainless steel surface can be damaged by adhesives and will lose its dirt-repelling properties. Do not use sticky notes, adhesive tape or other types of adhesive on the stainless steel surface.
- ▶ Magnets can cause scratches. Do not use the stainless steel surface as a magnetic notice board.

Cleaning and care

- ▶ Risk of injury due to electric shock. The steam from a steam cleaning appliance could reach electrical components and cause a short circuit. Never use a steam cleaner for cleaning.
- ▶ Excess spillage must be removed before cleaning. Coarse soiling in the oven compartment can cause thick smoke to develop. Coarse soiling should be removed from the oven compartment before running the pyrolytic cleaning programme.

Warning and safety instructions

▶ Risk of injury caused by hazardous steam. During pyrolytic cleaning, steam, which can irritate mucous membranes, may be released.

During pyrolytic cleaning, do not stay in the kitchen for longer periods of time and do not let children and pets enter the kitchen. It is important to ensure that the kitchen is well ventilated during pyrolytic cleaning. Prevent odours from escaping into other rooms.

▶ The shelf runners can be removed (see “Cleaning and care – Removing the shelf runners with FlexiClip telescopic runners”). Refit the shelf runners correctly.

▶ Scratches on the door glass can cause the glass to break. Do not use abrasive cleaners, hard sponges, brushes or sharp metal tools to clean the door glass.

▶ In warm, moist environments, there is a higher probability of vermin infestations (e.g. cockroaches). Ensure the oven and the area surrounding it are always kept clean.

Damage caused by vermin is not covered by the warranty.

Accessories

▶ Only use original Miele accessories. If other parts are used, warranty, performance and product liability claims will be invalidated.

▶ Miele will guarantee to supply functional spare parts for a minimum of 10 years and up to 15 years following the discontinuation of your oven.

▶ The Miele gourmet oven dish HUB 5000/HUB 5001 (if available) must not be inserted on shelf level 1. This will damage the oven floor. The lack of clearance will create an accumulation of heat which can cause the enamel to crack or flake off. Never place a Miele oven dish on the upper support of shelf level 1 either as it will not be secured by the non-tip safety notches. As a general rule, use shelf level 2.

▶ Only use the Miele food probe supplied with the appliance. If it is faulty, it must be replaced with a new original Miele food probe.

▶ The plastic on the food probe can melt at very high temperatures. Do not use the food probe when using the Grill functions. Do not store the food probe in the oven compartment when it is not being used.

▶ Accessories that are not suitable for pyrolytic cleaning will be damaged by the high temperatures. Remove all accessories that are not suitable for pyrolytic cleaning from the oven compartment before starting the pyrolytic cleaning programme. This also applies to optional accessories that are not suitable for pyrolytic cleaning (see “Cleaning and care”).

Disposal of the packing material

The transport and protective packaging has been selected from materials which are environmentally friendly for disposal, and can normally be recycled.

Recycling the packaging reduces the use of raw materials in the manufacturing process and also reduces the amount of waste in landfill sites.

Ensure that any plastic wrappings, bags etc. are disposed of safely and kept out of the reach of babies and young children. Danger of suffocation.

Disposing of your old appliance

Electrical and electronic appliances often contain valuable materials. They also contain specific materials, compounds and components, which were essential for their correct function and safety. These could be hazardous to human health and to the environment if disposed of with your domestic waste or if handled incorrectly. Please do not, therefore, dispose of your old appliance with your household waste.



Please dispose of it at your local community waste collection / recycling centre for electrical and electronic appliances. You are also responsible for deleting any personal data that may be stored on the appliance prior to disposal. Please ensure that your old appliance poses no risk to children while being stored prior to disposal.

Overview

Oven

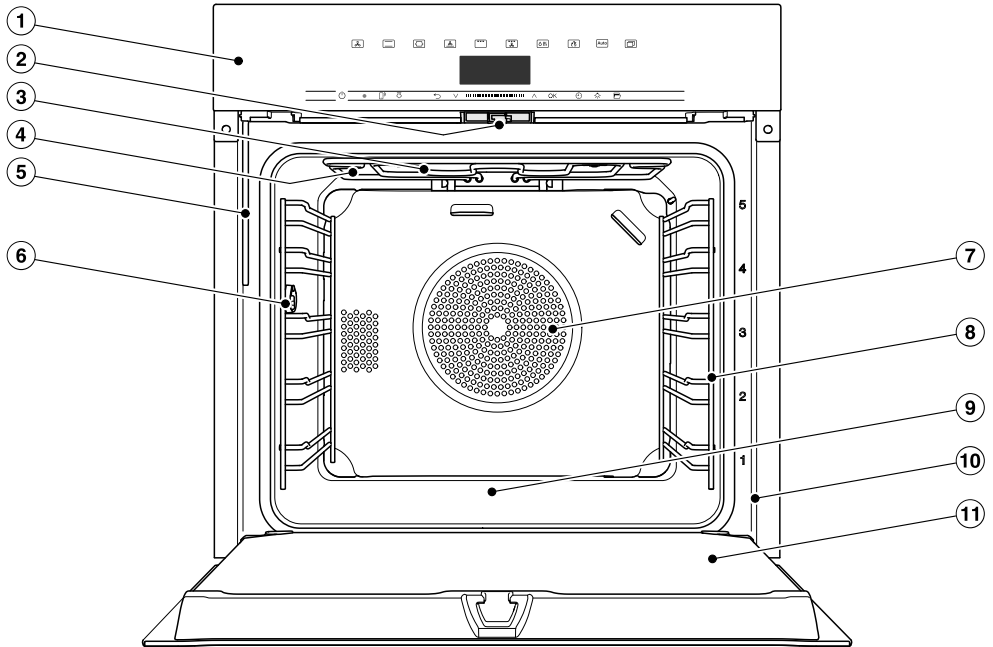

- ① Control panel
- ② Door lock
- ③ Top heat/grill element
- ④ Steam outlet openings
- ⑤ Water intake pipe for the steam injection system
- ⑥ Connection socket for the food probe
- ⑦ Air inlet for the fan with ring heating element behind it
- ⑧ Shelf runners with 5 shelf levels
- ⑨ Oven floor with bottom heat element underneath it
- ⑩ Front frame with data plate
- ⑪ Door

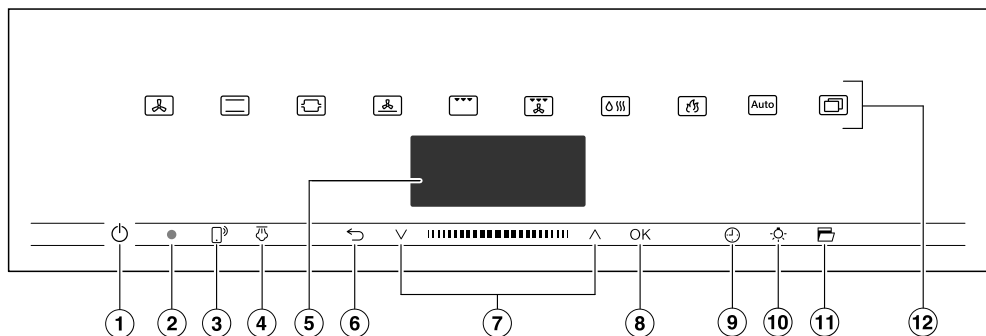

- ① Recessed On/Off sensor
For switching the oven on and off
- ② Optical interface
(for Miele service technicians only)
- ③ sensor
For controlling the oven via your mobile device
- ④ sensor
For injecting the bursts of steam
- ⑤ Display
For displaying the time of day and information on operation
- ⑥ sensor
For going back a step and for changing menu options during a cooking programme
- ⑦ Navigation area with and arrow sensors
For scrolling through lists and for changing values
- ⑧ *OK* sensor
For calling up functions and saving settings
- ⑨ sensor
For setting a minute minder, the cooking duration or the start or finish time for the cooking programme
- ⑩ sensor
For switching the oven interior lighting on and off
- ⑪ sensor
For opening the door
- ⑫ Sensor controls
For selecting functions, Automatic programmes and settings

Controls

On/Off sensor

The On/Off  sensor is recessed and reacts to touch.

Use this sensor to switch the oven on and off.

Display

The display is used for showing the time of day or information about functions, temperatures, cooking durations, Automatic programmes and settings.

After switching the oven on with the On/Off  sensor, *Select function* will appear in the main menu.

Sensor controls







The sensors react to touch. Every touch of the sensors is confirmed by a keypad tone. You can switch off this keypad tone using Other  | Settings | Volume | Keypad tone.

If you want the sensors to respond even when the oven is switched off, select the Display | QuickTouch | On setting.





Sensor controls above the display

For information on the oven functions and further functions, see “Main and sub-menus”, “Settings”, “Automatic programmes” and “Other applications”.

Sensor controls under the display





Sensor	Function
	<p>If you want to control the oven from your mobile device, you must have the Miele@home system, switch on the Remote control setting and touch this sensor. The sensor then lights up and the MobileStart function is available.</p> <p>As long as this sensor is illuminated, you can control the oven via your mobile device (see “Settings – Miele@home”).</p>
	<p>After selecting manual steam injection for the Moisture Plus  function, you can use this sensor to inject steam.</p> <p>This sensor lights up orange as soon as a steam injection can be released.</p> <p> appears in the display while steam injection is in progress.</p>
	<p>Depending on which menu you are in, this sensor control will take you back a level or back to the main menu.</p> <p>If a cooking programme is in progress at the same time, use this sensor control to change values and settings such as the temperature or Booster function for the programme, or to cancel the programme.</p>
	<p>In the navigation area, use the arrow sensors or the area between them to scroll up and down in the selection lists. The menu options will be highlighted one after the other as you scroll through them. The desired menu option must be highlighted before you can select it.</p> <p>You can change the values or settings that are highlighted by using the arrow sensors or the area between them.</p>

Controls

Sensor	Function
	Functions highlighted in the display can be selected by touching the <i>OK</i> sensor. The selected function can then be changed. Confirm with <i>OK</i> to save changes. If information appears in the display, select <i>OK</i> to confirm the message.
	If no cooking programme is in progress, you can use this sensor to set a minute minder (e.g. when boiling eggs on the cooktop) at any point. While a cooking programme is in progress, you can set a minute minder, the cooking duration and a start or finish time for the programme.
	Select this sensor to switch the oven interior lighting on and off. Depending on the setting selected, the oven interior lighting switches off after 15 seconds or remains constantly switched on or off.
	Use this sensor to open the door automatically. To close it, press against the door frame with your hand or with a suitable pot holder or oven glove until the door shuts.

Symbols

The following symbols may appear in the display:

Symbol	Meaning
	This symbol indicates that there is additional information and advice about using the appliance. Select <i>OK</i> to confirm the information.
	Minute minder
	A tick indicates the option which is currently selected.
	Some settings, e.g. display brightness and signal tone volume, are selected using a segment bar.
	The system lock prevents the oven being switched on by mistake (see “Settings – Safety”).

Use the \wedge and \vee arrow sensors or the **|||||** area between them in the navigation area to use the oven.

The *OK* sensor lights up orange as soon as a value, setting or prompt can be confirmed.

Selecting a menu option

- Touch the \wedge or \vee arrow sensor or swipe to the right or left in the **|||||** area until the desired menu option is highlighted.

Useful tip: If you press and hold the arrow sensor, the list continues scrolling automatically until you release the arrow sensor.

- Confirm your selection with *OK*.

Changing a setting in a list

- Touch the \wedge or \vee arrow sensor or swipe to the right or left in the **|||||** area until you reach the desired value or the desired setting is highlighted.

Useful tip: A \checkmark tick will appear beside the current setting.

- Confirm with *OK*.

The setting is now saved. This will take you back to the previous menu.

Changing the setting with a segment bar

Some settings are represented by a **■■■■■□□□** bar with seven segments. If all of the segments are illuminated, the maximum value is selected.

If none or only one of the segments is illuminated, the minimum value is selected or the setting is switched off altogether (e.g. volume).

- Touch the \wedge or \vee arrow sensor or swipe to the right or left in the **|||||** area until you reach the desired setting.
- Confirm your selection with *OK*.

The setting is now saved. This will take you back to the previous menu.

Selecting a function

The sensor controls for the functions are located above the display (see “Operation” and “Settings”).

- Touch the sensor for the desired function.

The sensor on the control panel will light up orange.

- Under *Other* , scroll through the lists until the desired menu option is highlighted.
- Set the values for the cooking programme.
- Confirm with *OK*.

Operating principles

Changing the function

You can change to another function during a cooking programme.

The sensor for the previously selected function lights up orange.

- Touch the sensor for the new function.

The new function appears in the display with its corresponding recommended values.

The sensor for the new function lights up orange.

Under **Other** , scroll through the lists until you reach the desired menu option.

Entering numbers

Numbers that can be changed are highlighted.

- Touch the \wedge or \vee arrow sensor or swipe to the right or left in the **||||** area until the desired number is highlighted.

Useful tip: If you press and hold an arrow sensor, the numbers continue scrolling automatically until you release the arrow sensor.

- Confirm with *OK*.

The changed number is now saved. This will take you back to the previous menu.

Entering letters

Letters are entered via the navigation area. It is best to select short, memorable names.

- Touch the \wedge or \vee arrow sensor or swipe to the right or left in the **||||** area until the desired character is highlighted.

The character you have selected will appear in the top line of the display.

Useful tip: A maximum of 10 characters can be used.

You can delete the characters one at a time with \leftarrow .

- Select further characters.
- Once you have entered the name, select \checkmark .
- Confirm with *OK*.

The name is now saved.

Activating MobileStart

- Select the  sensor to activate MobileStart.

The  sensor lights up. You can operate your oven remotely with the Miele App.

Directly operating the oven takes priority over operating it via the remote control function on the App.

You can use MobileStart as long as the  sensor is lit up.

A list of the models described in these operating and installation instructions can be found on the back page.

Data plate

The data plate located on the front frame of the oven is visible when the door is open.

The data plate states the model number, the serial number as well as connection data (voltage, frequency and maximum rated load).

Have this information available if you need to contact Miele so that any issues can be rectified as quickly as possible.

Items supplied

- Operating and installation instructions for using the oven
- A cookbook with recipes for the Automatic programmes and other functions
- Food probe
- Opener
- Screws for fixing the oven to the housing unit
- Descaling tablets and a plastic tube with suction cup for descaling the steam injection system
- Various accessories

Accessories supplied and available to order

Features will vary depending on model.

The shelf runners, universal tray and wire rack (or “rack” for short) are supplied as standard with the oven.

Depending on the model, your oven may also come supplied with some of the accessories listed here.

All accessories and cleaning and care products listed in these instructions are designed for Miele ovens.

These are available to order via the Miele online shop or directly from Miele (see the end of this booklet for contact details).

When ordering, please quote the model number of your oven and the reference number of the accessories required.

Shelf runners

Shelf runners for accessories are fitted on either side of the oven cavity for shelf levels .

The shelf level numbers are marked on the front of the oven frame.

Each level consists of 2 rails, one above the other.

Accessories (e.g. the rack) are pushed into the oven between the two rails.

The FlexiClip telescopic runners (if present) are fitted on the lower rail.

The shelf runners can be removed (see “Cleaning and care – Removing the shelf runners with FlexiClip telescopic runners”).

Features

Baking tray, universal tray and rack with non-tip safety notches

Baking tray HBB 71:

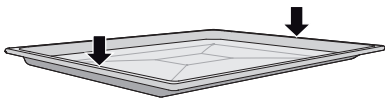

Universal tray HUBB 71:



Rack HBBR 72:



Insert these accessories into the shelf runners between the two rails of a shelf level.

The rack has a rail at the back to prevent dishes sliding off. Ensure the rack is inserted so that the rail is facing upwards.

Non-tip safety notches are located on accessories to prevent the trays being pulled out completely when you only wish to pull them out partially. They also prevent trays from tipping.

- The non-tip safety notches are located in the middle of the short sides of the baking tray and universal tray.
- The non-tip safety notches are located towards the back of the short sides of the rack.



If you are using the universal tray with the rack on top, insert the tray between the rails of a shelf runner and the rack will sit on top of it.

FlexiClip telescopic runners HFC 72

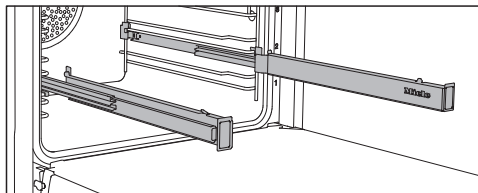

You can use the FlexiClip telescopic runners on shelf levels 1–4.

Push the FlexiClip telescopic runners right into the oven cavity before placing accessories on them.

The accessories will then automatically sit securely between the stoppers at either end of each runner and be prevented from sliding off.

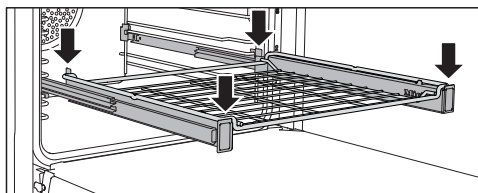
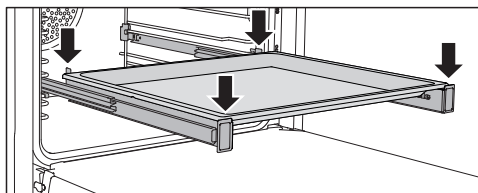

The FlexiClip telescopic runners can support a maximum load of 15 kg.

Fitting and removing the FlexiClip telescopic runners

 Risk of injury caused by hot surfaces.

The oven gets hot during operation. You could burn yourself on the heating elements, the oven compartment, or accessories. Allow the heating elements, oven compartment and the accessories to cool down before fitting or removing the FlexiClip telescopic runners.

The FlexiClip telescopic runners are fitted in between the two rails that make up a shelf level.

The FlexiClip telescopic runner with the Miele logo is fitted on the right.

When fitting or removing the FlexiClip telescopic runners, do **not** extend them.

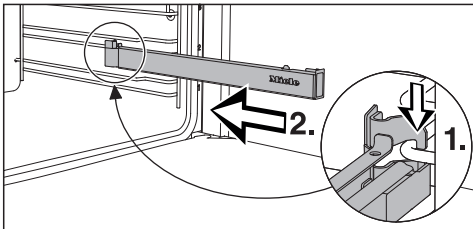

- Hook the FlexiClip telescopic runner onto the lower rail of a shelf level at the front (1.) and push it along the rail into the oven interior (2.).

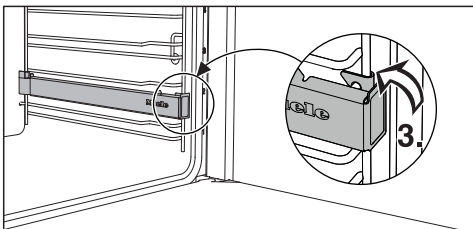

- Then secure the FlexiClip telescopic runner to the lower rail of the shelf level as illustrated (3).

If the FlexiClip telescopic runners are difficult to pull out after fitting, you may need to pull firmly on them once to release them.

To remove a FlexiClip telescopic runner, proceed as follows:

- Push the FlexiClip telescopic runner in all the way.

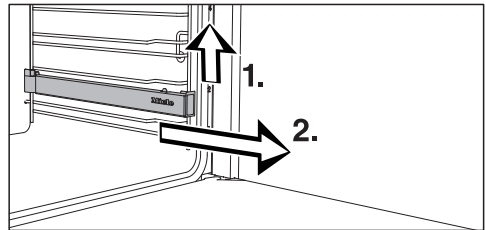

- Remove the FlexiClip telescopic runner by raising it at the front (1.) and then pulling it forwards along the rail of the shelf level and out (2.).

Round baking trays



The **solid round baking tray HBF 27-1** is suitable for cooking pizzas, flat cakes made with yeast or whisked mixtures, sweet and savoury tarts, baked desserts, flat bread, and can also be used for frozen cakes and pizzas.

The **perforated round baking and AirFry tray HBFP 27-1** can be used for the same purposes as the **perforated Gourmet baking and AirFry tray HBBL 71**.

The surface of both baking trays has been treated with PerfectClean enamel.

- Insert the rack and place the round baking tray on the rack.

Features

Gourmet baking and AirFry tray, perforated HBBL 71

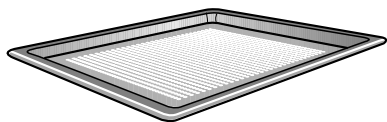

The fine perforations of the Gourmet baking and AirFry tray optimise cooking processes:

- Browning on the underside of baked goods made from fresh yeast and quark doughs, as well as bread and rolls is improved. Firstly, roll out the dough on an even work surface and then place it on the Gourmet baking and AirFry tray.
- Chips, croquettes, or similar items can be fried in a hot air flow (AirFrying) without using fat.
- During dehydrating/drying, the air circulation around the food for drying is optimised.

The surface has been treated with PerfectClean enamel.

The **perforated round baking and AirFry tray HBFP 27-1** can be used for these purposes.

Baking stone HBS 70



The baking stone is ideal for items which need a well baked base such as pizza, quiche, bread, bread rolls and savoury snacks.

The baking stone is made from heat-retaining fireclay and is glazed. A paddle made of untreated wood is supplied with the baking stone for placing food on it and taking it off.

- Slide the rack in and place the baking stone on it.

Grilling and roasting insert HGBB 71

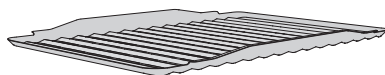

The grilling and roasting insert fits in the universal tray.

The tray will collect meat juices during grilling, roasting or AirFrying and stop them from burning so that they can be used for making gravy and sauces.

The enamelled surface has been treated with PerfectClean.

HUB Gourmet oven dishes HBD Gourmet oven dish lids

Unlike other oven dishes, the Miele Gourmet oven dishes can be placed in the oven directly on the shelf runners. They have non-tip safety notches like the rack to prevent them from being pulled out too far.

The surface of the oven dishes has a non-stick coating.

Gourmet oven dishes are available in different depths. The width and the height are the same.

Suitable lids are available separately. Please quote the model number when ordering.

Depth: 22 cm

HUB 5000-M
HUB 5001-M*

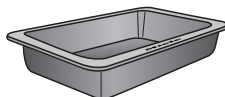

HBD 60-22

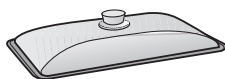

Depth: 35 cm

HUB 5001-XL*

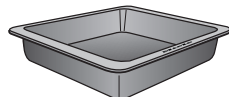

HBD 60-35



* Suitable for induction cooktops

Food probe

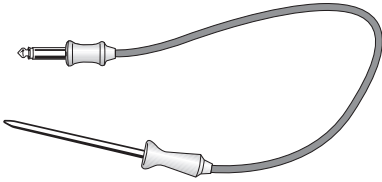

With the food probe you can monitor the temperature during cooking processes accurately (see “Roasting - Food probe”).

- When using the food probe, do not insert the FlexiClip telescopic runners on shelf level 4, otherwise this will block the socket.

Handle HEG

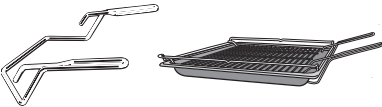

The handle makes it easier to take the universal tray, baking tray and rack out of the oven.

Accessories for cleaning and care

- Opener
The opener can be used to lever the door open during a power cut. To do so, push the opener at an angle into the gap on the outside edge of the door at the top between the control panel and the door.
- Descaling tablets, plastic tube with suction cup for descaling the oven
- Miele all purpose microfibre cloth
- Miele oven cleaner

Safety features

- **System lock** 
(see “Settings – Safety”)
- **Sensor lock**
(see “Settings – Safety”)
- **Cooling fan**
(see “Settings – Cooling fan run-on”)
- **Safety switch-off**
This safety switch-off is activated automatically if the oven has been operating for an unusually long period of time. The period of time will depend on the particular oven function being used.
- **Ventilated door**
The oven door is made of glass panes that have a heat-reflective coating on part of their surface. When the oven is operating, air is passed through the door to keep the outer pane cool. The door can be removed and disassembled for cleaning purposes (see “Cleaning and care”).
- **Door lock** for pyrolytic cleaning
At the beginning of a pyrolytic cleaning programme the door will lock for safety reasons. The door will only unlock when the temperature in the oven compartment has dropped to below 280 °C.

Features

PerfectClean treated surfaces

Surfaces treated with PerfectClean enamel are characterised by their exceptional non-stick properties and ease of cleaning.

Food can be easily removed from these surfaces. Soiling from baking and roasting can be easily removed from these surfaces.

Food can be sliced or cut up on PerfectClean surfaces.

However, do not use ceramic knives as these will scratch the PerfectClean surface.

Surfaces treated with PerfectClean enamel can be cleaned as you would clean glass.

Read the instructions in “Cleaning and care” so that the benefits of the non-stick properties and easy cleaning are retained.

PerfectClean treated surfaces:

- Universal tray
- Baking tray
- Grilling and roasting insert
- Gourmet baking and AirFry tray, perforated
- Round baking and AirFry tray, perforated
- Round baking tray

Pyrolytic accessories

See “Cleaning and care” for more information.

The following accessories can be left in the oven compartment during the pyrolytic cleaning programme:

- Shelf runners
- FlexiClip telescopic runners HFC 72
- Rack

Before using for the first time

Miele@home

Your oven is equipped with an integrated Wi-Fi module.

In order to use it, you need:

- a Wi-Fi network
- the Miele App
- a Miele user account. The user account can be created via the Miele App.

The Miele App will guide you as you connect your oven to your home Wi-Fi network.

Once your oven is connected to your Wi-Fi network, you can use the App for a number of actions, including the following:

- Call up information on the operating status of your oven
- Retrieve information on cooking processes that are in progress
- End cooking programmes that are in progress

Connecting your oven to your Wi-Fi network will increase energy consumption, even when the oven is switched off.

Make sure that the signal of your Wi-Fi network is sufficiently strong in the place where your oven is installed.

Availability of the Wi-Fi connection

The Wi-Fi connection shares a frequency range with other appliances (including microwave ovens and remote control toys). This may result in sporadic or even complete connection failures. Therefore, a constant availability of featured functions cannot be guaranteed.

Miele@home availability

The ability to use the Miele App depends on the availability of the Miele@home service in your country.

The Miele@home service is not available in every country.

For information about availability, please visit www.miele.com.

Miele App

You can download the Miele App from the Apple App Store® or the Google Play Store™ free of charge (only functional in selected countries).



Before using for the first time

Standard settings

The following settings must be made before starting up for the first time. You can change these settings again at a later time (see “Settings”).

 Risk of injury caused by hot surfaces.

The oven gets hot during operation. For safety reasons, the oven may only be used when it has been fully installed.

The oven will switch on automatically when it is connected to the electricity supply.

Setting the language

- Select the language you want.

If you have accidentally selected a language that you don't understand, proceed as described in “Settings – Language ”.

Setting the location

- Select the required location.

Setting up Miele@home

Set up “Miele@home” appears in the display.

- To set up Miele@home immediately, select *Continue* and confirm with *OK*.
- To set it up at a later date, select *Skip* and confirm with *OK*. See “Settings – Miele@home” for information on setting up at a later date.
- To set up Miele@home immediately, select the desired connection method.

You will then be guided by the display and the Miele App.

Setting the date

- Set the year, then the month, and finally the day.
- Confirm with *OK*.

Setting the time of day

- Set the time of day in hours and minutes.
- Confirm with *OK*.

Completing the commissioning process

- Follow any further instructions in the display.

The appliance is now ready for use.

Before using for the first time



Heating up the oven for the first time and rinsing the steam injection system

When the oven is heated up for the first time, it may give off a slight smell. This can be eliminated by heating the empty oven for at least one hour. It is a good idea to rinse out the steam injection system at the same time.

Ensure that the kitchen is well ventilated while the appliance is being heated up for the first time. Prevent odours from escaping into other rooms.

- Remove any protective foil and stickers, except the data plate, from the oven and accessories.
- Before heating the oven up, wipe the interior with a damp cloth to remove any dust or bits of packaging that may have accumulated during storage and unpacking.
- Fit the FlexiClip telescopic runners to the shelf runners and insert all trays and the rack.
- Switch the oven on with the On/Off  sensor.

Select function appears in the display.

- Select Moisture Plus .
- Select Moisture Plus + Fan Plus .

The recommended temperature will appear (160 °C).

The oven heating, lighting and cooling fan will switch on.

- Set the maximum possible temperature (250 °C).
- Confirm with *OK*.
- Select Automatic burst of steam.

The prompt to draw in water appears.

- Fill a suitable container with the required amount of fresh tap water.
- Open the door.
- Pull the water intake pipe forwards (located below the control panel on the left).

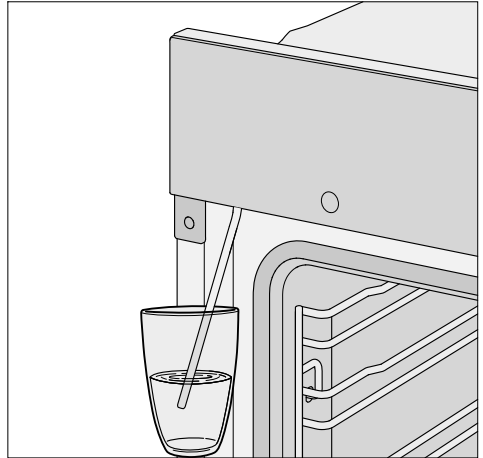

- Immerse the end of the water intake pipe in the container with tap water.
- Confirm with *OK*.

The water intake process will begin.

The amount of water actually drawn up into the oven may be less than the amount specified as required, leaving a small amount in the container.

- Remove the water container after the water intake process and close the door.

The sound of the pump running can be heard again briefly. Residual water in the water intake pipe is being drawn into the oven.

The oven heating, lighting and cooling fan will switch on.

After a short time a burst of steam will be released automatically.

Before using for the first time

 Danger of injury caused by steam.
The steam escaping is very hot.
Do not open the door during a burst of steam.

Heat up the empty oven for at least one hour.

- Switch the oven off with the On/Off  sensor after at least one hour.

Cleaning the oven compartment after heating it up for the first time

 Risk of injury caused by hot surfaces.





The oven gets hot during operation. You could burn yourself on the heating elements, the oven compartment, or accessories.

Allow the heating elements, oven compartment and the accessories to cool before manual cleaning.

- Take all accessories out of the oven and clean them by hand (see “Cleaning and care”).
- Clean the oven compartment with a clean sponge and a solution of hot water and washing-up liquid or a clean, damp microfibre cloth.
- Dry all surfaces with a soft cloth.

Leave the oven door open until the oven interior is completely dry.

Settings overview

Menu option	Available settings
Language 	... deutsch english ... Location
Time	Show On* Off Night dimming Clock format 12 h 24 h* Set
Date	
Lighting	On "On" for 15 seconds* Off
Display	Brightness  * QuickTouch On Off*
Volume	Buzzer tones Melodies  * Solo tone  * Keypad tone  * Welcome melody On* Off
Units	Temperature °C* °F
Booster	On* Off
Rapid cooling	On* Off
Keeping warm	On Off*
Recommended temperatures	
Pyrolytic recommendation	On Off*
Cooling fan run-on	Temperature-controlled* Time-controlled

* Factory settings



Settings

Menu option	Available settings
Safety	Sensor lock On Off* System lock  On Off*
Miele@home	Activate Deactivate Connection status Set up again Reset Set up
Remote control	On* Off
RemoteUpdate	On* Off
Software version	
Showroom programme	Demo mode On Off*
Factory default	Appliance settings User programmes Recommended temperatures

* Factory settings

Opening the “Settings” menu

In the Other  | Settings menu, you can personalise your oven by adapting the factory default settings to suit your requirements.



- Select Other .
- Select Settings .
- Select the desired setting.

You can check settings or change them.

Settings cannot be altered while a cooking programme is in progress.

Language

You can set your language and location. After selecting and confirming your choice, the language you have selected will appear in the display.

Useful tip: If you have selected the wrong language by mistake, select the  sensor. Follow the  symbol to get back to the Language  sub-menu.

Time

Show

Select how you want the time of day to appear in the display when the oven is switched off:

- On
The time is always visible in the display.
If you also select the Display | QuickTouch | On setting, all sensors react to touch as normal.
If you also select the Display | QuickTouch | Off setting, the oven has to be switched on before it can be used.
- Off
The display is dark to save energy. The oven has to be switched on before you can use it.

- Night dimming
To save energy, the time is only visible in the display between 5:00 am and 11:00 pm. The display remains dark at all other times.

Clock format

The time of day can be displayed in the 24 or 12-hour format (24 h or 12 h).

Set

Set the hours and then the minutes.



If there is a power cut, the current time of day will reappear once power has been restored. The time of day is saved for approx. 150 hours.

If the oven has been connected to a Wi-Fi network and signed into the Miele App, the time will be synchronised based on the location setting in the Miele App.

Date

Set the date.

Lighting

- On
The oven interior lighting is switched on during the entire cooking period.
- “On” for 15 seconds
The oven interior lighting switches off 15 seconds after a cooking programme has begun. Press the  sensor to switch the oven interior lighting on again for 15 seconds.
- Off
The oven interior lighting is switched off. Press the  sensor to switch on the oven interior lighting for 15 seconds.

Settings

Display

Brightness

The display brightness is represented by a segment bar.

- ■■■■■■■■
Maximum brightness
- ■■■■■■■■
Minimum brightness

QuickTouch

Select how the sensors should respond when the oven is switched off:

- On
If you have also selected the Time | Show | On or Night dimming setting, the sensors will also respond when the oven is switched off.
- Off
Independently of the Time | Show setting, the sensors only respond when the oven is switched on, as well as for a certain amount of time after switching it off.

Volume

Buzzer tones

If buzzers are switched on, a buzzer will sound when the set temperature is reached and at the end of a set time.

If you want to open the door remotely using a voice-based service, make sure that nobody is in the area around the door when opening it. Make sure that you keep the buzzers switched on.

Melodies

At the end of a process, a melody will sound several times at intervals.

The volume of the melody is represented by a segment bar.

- ■■■■■■■■
Maximum volume
- □■■■■■■□
Melody is switched off

Solo tone

At the end of a process, a continuous tone will sound for a period of time.

The pitch of this continuous tone is represented by a segment bar.

- ■■■■■■■■■■■■■■■■
Highest pitch
- □■■■■■■■■■■■■■■□
Lowest pitch

Keypad tone

The volume of the tone that sounds each time you touch a sensor is represented by a segment bar.

- ■■■■■■■■
Maximum volume
- □■■■■■■□
Keypad tone is switched off

Welcome melody

The melody that sounds when you touch the On/Off  sensor can be switched on or off.

Units

Temperature

You can set the temperature in degrees Celsius (°C) or degrees Fahrenheit (°F).

Booster

The Booster function is used to quickly pre-heat the oven.

- On
The Booster function is automatically switched on during the heating-up phase of a cooking programme. The top

heat/grill element, ring heating element and hot air fan pre-heat the oven compartment to the set temperature at the same time.

- Off
The Booster function is switched off during the heating-up phase of a cooking programme. Only the heating elements for the selected oven function are used to pre-heat the oven compartment.

Rapid cooling

Using the Rapid cooling function you can quickly cool down food and the oven compartment once the cooking programme is finished.

This function is useful if, for example, you immediately want to start an Automatic programme for which the oven compartment needs to be cold.

Using the Keeping warm function you can keep food warm after cooking without inadvertently cooking it further.

- On
The Rapid cooling function is switched on. Once the cooking programme has finished, the door opens a little automatically. The cooling fan cools the food and the oven compartment quickly.
- Off
The Rapid cooling function is switched off. The door remains closed at the end of the cooking programme. The cooling fan cools the food and the oven compartment.

Keeping warm

Using the Keeping warm function you can keep food warm after cooking without inadvertently cooking it further. The food is kept warm at a preset temperature (Settings | Recommended temperatures | Keeping warm).

It is only possible to use the Keeping warm function in combination with the Rapid cooling function.

- On
The Keeping warm function is switched on. Once the cooking programme has finished, the door opens a little automatically. The cooling fan cools the food and the oven compartment quickly to the preset temperature. Once this temperature is reached, the door closes again automatically in order to keep the food warm.
- Off
The Keeping warm function is switched off. The door remains closed at the end of the cooking programme. The cooling fan cools the food and the oven compartment.

Recommended temperatures

If you frequently cook with different temperatures, it makes sense to change the recommended temperatures.

After selecting this option, a list of oven functions will appear in the display.

- Select the function you want.

The recommended temperature will appear together with the range within which it can be changed.

- Change the recommended temperature.
- Confirm with *OK*.

Settings

You can also change the recommended temperature for the Keeping warm function.

Pyrolytic recommendation

You can set whether the recommendation for carrying out pyrolytic cleaning will appear (On) or will not appear (Off).

Cooling fan run-on

The cooling fan will continue to run for a while after the oven has been switched off to prevent any humidity building up in the oven compartment, on the control panel or on the oven housing unit.

- Temperature-controlled
The cooling fan switches off when the temperature in the oven drops below 70 °C.
- Time-controlled
The cooling fan switches off after a period of about 25 minutes.

Condensate can damage the oven housing unit, damage the worktop and lead to corrosion in the oven. If you have set the cooling fan to Time-controlled and leave food in the oven compartment to keep warm, moisture levels in the oven will increase, leading to condensation forming on the fascia panel and surrounding kitchen furniture, and drops of moisture collecting under the worktop. Do not leave food in the oven to keep it warm if you have set the cooling fan to Time-controlled.

Safety

Sensor lock

The sensor lock prevents the cooking programme being switched off by mistake or settings being changed. Apart from the On/Off  sensor, the activated sensor lock prevents the sensors and fields in the display from working a few seconds after a programme has been started.

- On
The sensor lock is switched on. Touch the OK sensor for at least 6 seconds to deactivate the sensor lock for a short period of time.
- Off
The sensor lock is deactivated. All sensor controls react to touch as normal.

If you want to switch off the appliance with the sensor lock activated, touch the On/Off  sensor until the appliance switches off.

System lock

The system lock prevents the oven being switched on by mistake.

The minute minder and the MobileStart function can still be used when the system lock is active.

The system lock will remain activated even after a power failure.

- On
The system lock is switched on. Before you can use the oven, touch the OK sensor for at least 6 seconds.
- Off
The system lock is deactivated. You can use the oven as normal.

Miele@home

The oven is a Miele@home compatible appliance. Your oven is fitted ex-works with a Wi-Fi communication module and is suitable for wireless communication.

There are a number of ways of connecting your oven to your Wi-Fi network. We recommend connecting your oven to your Wi-Fi network with the help of the Miele App or via WPS.

- Activate
This setting is only visible if Miele@home is deactivated. The Wi-Fi function is reactivated.
- Deactivate
This setting is only visible if Miele@home is activated. Miele@home remains set up, the Wi-Fi function is switched off.
- Connection status
This setting is only visible if Miele@home is activated. The display shows information such as the Wi-Fi reception quality, network name and IP address.
- Set up again
This setting is only visible if a Wi-Fi network has already been set up. Reset the network settings and immediately set up a new network connection.
- Reset
This setting is only visible if a Wi-Fi network has already been set up. The Wi-Fi function is deactivated and the Wi-Fi network will be reset to the factory default. You must set up a new connection to the Wi-Fi network to be able to use Miele@home. The network settings should be reset whenever the oven is being disposed of or sold, or if a used oven is being put into operation. This is the only way

to ensure that all personal data has been removed and, in the case of the latter, the previous owner will no longer be able to access the oven.

- Set up
This setting is only visible if no connection to the Wi-Fi network has been set up yet. You must set up a new connection to the Wi-Fi network to be able to use Miele@home.

Performing Scan & Connect

Initial commissioning has been carried out without Miele@home having been set up.

- Scan the QR code.

If you have installed the Miele App and have a user account, you will be taken directly to the networking steps.

If you have not yet installed the Miele App, you will be taken to the Apple App Store® or the Google Play Store™.

- Install the Miele App and set up a user account.
- Scan the QR code again.

The Miele App will guide you through the set-up process.





Settings

Remote control

If you have installed the Miele App on your mobile device, have access to the Miele@home system and have activated the remote control function (On), you can use the MobileStart function to retrieve information on oven cooking programmes currently in progress or to end a programme in progress.

Activating MobileStart

- Select the  sensor to activate MobileStart.

The  sensor lights up. You can operate your oven remotely with the Miele App.

Directly operating the oven takes priority over operating it via the remote control function on the App.

You can use MobileStart as long as the  sensor is lit up.

RemoteUpdate

The RemoteUpdate menu option is only displayed and can only be selected if the requirements for using Miele@home have been met (see “Before using for the first time – Miele@home” or “Settings”).

The RemoteUpdate function is used for updating the software in your oven. If an update is available for your oven, it will automatically download it. Updates will not be installed automatically. They must be initiated manually.

If you do not install an update, you can continue to use your oven as usual. However, Miele recommends installing updates.

Switching on/Switching off

RemoteUpdate is switched on as standard. Available updates will be downloaded automatically and will only be installed if you initiate it.

Switch off RemoteUpdate if you do not wish any updates to be downloaded.

Running a RemoteUpdate

Information about the content and scope of an update is provided in the Miele App.

A message will appear in your oven display if a software update is available. You can install the update immediately or postpone this until later. When the oven is switched on again, you will be reminded about the update.

Switch RemoteUpdate off if you do not wish to install updates.

The update can take several minutes.

Please note the following information about the RemoteUpdate function:

- You will only receive a message when an update is available.
- Once an update has been installed, it cannot be undone.
- Do not switch the oven off during the update. Otherwise, the update will be aborted and will not be installed.
- Some software updates can only be carried out by a Miele service technician.

Software version

The software version menu option is for use by Miele service technicians. You do not need this information for domestic use.

Showroom programme

This function enables the oven to be demonstrated in showrooms without heating up. Do not activate this setting for domestic use.

Demo mode

If you switch the oven on whilst it is in Demo mode, the following message will appear in the display: Demo mode is activated. The appliance will not heat up.

- On
Touch the *OK* sensor for at least 4 seconds to activate Demo mode.
- Off
Touch the *OK* sensor for at least 4 seconds to deactivate Demo mode.
You can use the oven as normal.

Factory default

- Appliance settings
Any settings that have been altered will be reset to the factory default settings.
- User programmes
All User programmes will be deleted.
- Recommended temperatures
Any recommended temperatures that have been changed will be reset to the factory default settings.

Operating hours

Select Other  | Operating hours to query the total number of operating hours of your oven.

Minute minder

Using the Minute minder function

The  minute minder can be used to time other activities in the kitchen, e.g. boiling eggs on the cooktop.

The minute minder can also be used at the same time as a cooking programme for which the cooking duration start and finish times have been set (e.g. as a reminder to stir the food or add seasoning, etc.).

- The maximum minute minder time that can be set is 59 minutes and 59 seconds.

Useful tip: When using a function that uses moisture, use the timer to remind you to inject steam manually at the desired time.

Setting the minute minder

If you have selected the Display | QuickTouch | Off setting, you will need to switch the oven on before setting the minute minder. The minute minder can then be seen counting down in the display when the oven is switched off.

- Select the  sensor.
- Select Minute minder if a cooking programme is in progress at the same time.

The prompt Set 00:00 min will appear.

- Using the navigation area, set 06:20.
- Confirm with *OK*.

The minute minder duration is now saved.

When the oven is switched off, the minute minder time counts down in the display and  appears instead of the time of day.

If you are cooking at the same time,  and the minute minder time will appear at the bottom of the display.

If you are in a menu, the minute minder will count down in the background.

At the end of the minute minder time  will flash, the time will start counting up and a buzzer will sound.

- Select the  sensor.
- If required, confirm with *OK*.

The buzzer will stop and the symbols in the display will go out.

Changing the time set for the minute minder

- Select the  sensor.
- Select Minute minder if a cooking programme is in progress at the same time.

- Select Change.

- Confirm with *OK*.

The minute minder time selected appears.

- Change the time set for the minute minder.
- Confirm with *OK*.

The altered minute minder time is now saved.

Cancelling the minute minder













- Select the  sensor.
- Select Minute minder if a cooking programme is in progress at the same time.

- Select Delete.



- Confirm with *OK*.

The minute minder is now cancelled.





Main and sub-menus

Menu	Recommended value	Range
Oven functions		
Fan Plus 	160 °C	30–250 °C
Conventional Heat 	180 °C	30–280 °C
Auto Roast 	160 °C	100–230 °C
Intensive Bake 	170 °C	50–250 °C
Full Grill 	240 °C	200–300 °C
Fan Grill 	200 °C	100–260 °C
Moisture Plus 		
Moisture Plus + Auto Roast 	160 °C	130–230 °C
Moisture Plus + Fan Plus 	160 °C	130–250 °C
Moisture Plus + Intensive Bake 	170 °C	130–250 °C
Moisture Plus + Conv. Heat 	180 °C	130–280 °C
Pyrolytic 		
Automatic programmes 		

Main and sub-menus

Menu	Recommended value	Range
Other 		
Bottom Heat	190 °C	100–280 °C
Eco Fan Heat	190 °C	100–250 °C
Defrost	25 °C	25–50 °C
Drying	60 °C	30–70 °C
Heat crockery	80 °C	50–100 °C
Prove yeast dough		
Prove for 15 minutes	–	–
Prove for 30 minutes	–	–
Prove for 45 minutes	–	–
Keeping warm	75 °C	60–90 °C
Descalc		
Settings 		
Operating hours		

Cooking programmes

- Remove any accessories from the oven that are not required for a cooking programme.
- In general, if a range of temperatures is given in a recipe or chart, it is best to select the lower temperature and to check the food after the shortest duration.
- Pre-heat the oven only if instructed to do so in the recipe or the cooking chart.
- Avoid opening the door during a cooking process.
- It is best to use dark bakeware and cooking containers with a matt finish made of non-reflective materials (enamelled steel, heat-resistant glass, non-stick coated cast aluminium). Shiny materials such as stainless steel or aluminium reflect the heat, preventing it from reaching the food efficiently. Do not cover the oven floor or the rack with heat-reflective aluminium foil.
- Monitor cooking durations to avoid wasting energy when cooking food. Set the cooking duration or use a food probe if you have one.
- The Fan Plus  function can be used for cooking many types of food. Because the fan distributes the heat in the oven compartment straight away, it allows you to use a lower temperature than you would with Conventional Heat . It also enables you to cook on several shelf levels at the same time.
- Eco Fan Heat  is an innovative function which is suitable for small amounts of food, e.g. frozen pizzas, bake-off rolls, biscuits and for meat dishes and roasts. The cooking process is energy-efficient thanks to optimal utilisation of heat. When cooking on a single level, up to 30% less energy is used with comparatively good cooking results. Do not open the door during the cooking programme.
- Fan Grill  is the best function for grilled dishes. With Fan Grill you can use lower temperatures than with other grill functions which use the maximum temperature setting.
- Whenever possible you should cook several dishes at the same time. Place them next to each other in the oven or on different shelf levels.
- Dishes which you are unable to prepare at the same time should, if possible, be cooked one after the other in order to make use of existing heat in the oven.

Energy saving tips

Using residual heat

- The temperature in cooking programmes using temperatures above 140 °C which take longer than 30 minutes to cook can be turned down to the lowest possible temperature about 5 minutes before the end of cooking. The residual heat in the oven is sufficient for cooking the food. However, do not switch the oven off (see “Warning and safety instructions”).
- If you have set a cooking duration for a cooking programme, the oven heating elements will switch off automatically shortly before the end of cooking. The residual heat in the oven is sufficient to complete the cooking process.
- It is best to start the pyrolytic cleaning programme immediately after a cooking programme. The residual heat in the oven will help reduce the amount of energy required.

Customising settings

- Select the setting **Display | QuickTouch | Off** for the control elements in order to reduce energy consumption.
- Select the **Lighting | Off** or “On” for 15 seconds setting for the oven interior lighting. The oven interior lighting can be switched on again at any time by touching the  sensor.

Energy saving mode

The oven will switch itself off automatically to save energy if a programme is not being run and no controls have been operated. The time of day will appear in the display or the display will remain dark (see “Settings”).

- Switch the oven on.

The main menu will appear.

- Place the food in the oven.
- Select the function you want.

The oven function and the recommended temperature will appear.

- Change the recommended temperature if necessary.

Otherwise the recommended temperature will be accepted within a few seconds. You can change the temperature later via the arrow sensors.

- Confirm with *OK*.

The required and the actual temperature are displayed and the heating-up phase will begin.

You will see the temperature rising in the display. A buzzer will sound when the selected temperature is reached for the first time.

- After cooking, select the sensor for the selected function to end the cooking programme.
- Take the food out of the oven.
- Switch the oven off.

Changing values and settings for a cooking programme

Depending on the function, as soon as a cooking programme is in progress, you can use the  sensor to change the values or settings for this programme.

- Select the  sensor.

Depending on the function, the following settings appear:



- Temperature
- Core temperature
- Duration
- Finish at
- Start at
- Booster
- Pre-heat
- Rapid cooling
- Keeping warm
- Crisp function

Changing values and settings

- Select the desired value or setting and confirm with *OK*.
- Change the value or setting and confirm with *OK*.

The cooking programme will continue with the new values and settings.

Changing the temperature and the core temperature

You can permanently reset the recommended temperature to suit your cooking preferences by selecting Other  | Settings  | Recommended temperatures.

The core temperature only appears if you are using the food probe (see “Roasting – Food probe”).

- Select the  sensor.
- Change the temperature and the core temperature as required.

Useful tip: You can change the temperature directly via the navigation area.

- Confirm with *OK*.

Operation

The cooking programme will resume with the new target temperatures.

Setting cooking durations

Cooking results can be adversely affected if there is a long delay between the food being placed in the oven and the start of cooking. Fresh food can change colour and even spoil.

When baking, the cake mixture or dough can dry out, and the raising agents can lose their effectiveness.

Select as short a time as possible until the start of the cooking process.

Example: You have placed the food in the oven compartment, selected a function and the required settings such as the temperature.

By entering Duration, Finish at or Start at via the ⌚ sensor, you can automatically switch the cooking programme off, or on and off.

- Duration

Enter the required cooking duration for the food. The heating will switch off automatically once this duration has elapsed. The maximum cooking duration that can be set depends on the function that you have selected.

- Finish at

Specify when you want the cooking programme to finish. The oven heating will switch off automatically at the time you have set.

- Start at

This function will only appear in the menu if you have set a Duration or Finish at time. With Start at, you have to specify when you want the cooking programme to start. The oven heating will switch on automatically at the time you have set.

- Select the ⌚ sensor.
- Set the required times.
- Confirm with *OK*.
- Touch the ↶ sensor to return to the menu of the selected function.

Changing the set cooking durations

- Select the ⌚ sensor.
- Select the time.
- Confirm with *OK*.
- Select *Change*.
- Change the set time.
- Confirm with *OK*.
- Touch the ↶ sensor to return to the menu of the selected function.

These settings will be deleted in the event of a power failure.

Deleting the set cooking durations

- Select the ⌚ sensor.
- Select the time.
- Confirm with *OK*.
- Select *Delete*.
- Confirm with *OK*.
- Touch the ↶ sensor to return to the menu of the selected function.

If you delete Duration, the set times for Finish at and Start at are also deleted.

If you delete Finish at or Start at, the cooking programme will start using the cooking duration set.

Cancelling cooking

You can cancel a cooking programme using the function sensor that lights up orange or using the ↶ sensor.

The oven compartment heating and lighting will then switch off. Any cooking durations set will be deleted.

Touch the function sensor to return to the main menu.

When the Rapid cooling function is switched on, the door automatically opens a little when the cooking programme is finished, and the cooling fan quickly cools the food and the oven compartment.
Touch the sensor for the selected function to return to the main menu.

Cancelling a cooking programme without a set cooking duration

- Touch the sensor for the selected function.

The main menu will appear.

- **Or:** select the ↶ sensor.
- Select Cancel process.
- Confirm with *OK*.

Cancelling a cooking programme with a set cooking duration

- Touch the sensor for the selected function.

Cancel process? appears in the display.

- Select *Yes*.
- Confirm with *OK*.
- **Or:** select the ↶ sensor.
- Select Cancel process.
- Confirm with *OK*.
- Select *Yes*.
- Confirm with *OK*.





Pre-heating the oven

The **Booster** function is used to quickly pre-heat the oven compartment in some functions.

The **Pre-heat** function can be used with any oven function and has to be switched on separately for each cooking programme.

If you have set a cooking duration, it will only start to count down after the heating-up phase.



It is only necessary to pre-heat the oven in a few instances.





- Most dishes can be placed in a cold oven. They will then make use of the heat produced during the heating-up phase.
- Pre-heat the oven for the following preparations and oven functions:
 - Dark bread dough and beef sirloin joints and fillet with the **Fan Plus** , **Moisture Plus**  and **Conventional Heat**  functions
 - Cakes and pastries with a short cooking duration (approx. 30 minutes or less) as well as delicate items (e.g. sponge) with the **Conventional Heat**  function (without the **Booster** function)

Operation

Booster

The Booster function is used to quickly pre-heat the oven compartment in some functions.

This function is switched on as the factory default setting for the following functions (Other  | Settings  | Booster | On):

- Fan Plus 
- Conventional Heat 
- Auto Roast 
- Moisture Plus 

If you set a temperature above 100 °C and the Booster function is switched on, a rapid heating-up phase heats the oven compartment to the set temperature. The top heat/grill element and the ring heating element come on together with the hot air fan.

Delicate items (e.g. sponge or biscuits) will brown too quickly on the top if the Booster function is used. Switch off the Booster function for these items.

Switching Booster on or off for a cooking programme

If you have selected the Booster | On setting, you can switch off the function separately for a cooking programme.

On the other hand, you can also switch on the function separately for a cooking programme if you have selected the Booster | Off setting.

Example: You have selected a function and the required settings such as the temperature.

You want to switch off the Booster function for this cooking programme.

- Select the ↶ sensor.
- Select Booster | Off.
- Confirm with *OK*.

The Booster function is switched off during the heating-up phase. Only the heating elements for the selected oven function are used to pre-heat the oven compartment.

Pre-heat

It is only necessary to pre-heat the oven in a few instances.

You can place most dishes in the cold oven compartment to make use of the heat produced during the heating-up phase.

If you have set a cooking duration, it will only start to count down when the target temperature is reached and you have placed the food in the oven. Start the cooking programme immediately without delaying the start time.

Switching on the Pre-heat function

The Pre-heat function can be used with any oven function and has to be switched on separately for each cooking programme.

Example: You have selected a function and the required settings such as the temperature.

You want to switch on the Pre-heat function for this cooking programme.

- Select the ↶ sensor.
- Select Pre-heat | On.
- Confirm with *OK*.

The following message is displayed with a time: Place food in oven at ... The oven compartment is heated to the set temperature.

- As soon as you are prompted to do so, place the food in the oven compartment.
- Confirm with *OK*.

Rapid cooling

Using the Rapid cooling function you can quickly cool down food and the oven compartment once the cooking programme is finished.

Switching Rapid cooling on or off for a cooking programme

If you have selected the Rapid cooling | On setting, you can switch off the function separately for a cooking programme.

On the other hand, you can also switch on the function separately for a cooking programme if you have selected the Rapid cooling | Off setting.

Example: You have selected a function and the required settings such as the temperature.

You want to switch off the Rapid cooling function for this cooking programme.

- Select the ↶ sensor.
- Select Rapid cooling | Off.
- Confirm with *OK*.

If the Keeping warm function is also switched on, When “Rapid cooling” is deactivated, “Keeping warm” is also switched off. **will appear.**

- If necessary, confirm this message with *OK*.

The Rapid cooling and Keeping warm functions are switched off. The door remains closed at the end of the cooking programme. The cooling fan cools the food and the oven compartment.

Keeping warm

Using the Keeping warm function you can keep food warm after cooking without inadvertently cooking it further.

The food is kept warm at a preset temperature (see “Settings – Recommended temperatures”).

It is only possible to use the Keeping warm function in combination with the Rapid cooling function.

If you have selected the Keeping warm | On setting, you can switch off the function separately for a cooking programme.

On the other hand, you can also switch on the function separately for a cooking programme if you have selected the Keeping warm | Off setting.

Switching on Keeping warm for a cooking programme

Example: You have selected a function and the required settings such as the temperature.

You want to switch on the Keeping warm function for this cooking programme.

- Select the ↶ sensor.
- Select Keeping warm | On.
- Confirm with *OK*.

When the Rapid cooling function is also switched off, Keeping warm requires the function Rapid cooling. Rapid cooling will also be activated. **will appear.**

- If necessary, confirm the message with *OK*.

The Keeping warm and Rapid cooling functions are switched on. Once the cooking programme has finished, the door opens a little automatically. The cooling fan cools the food and the oven

Operation

compartment quickly to the preset temperature.

Once this temperature is reached, the door closes again automatically in order to keep the food warm.

Switching off Keeping warm for a cooking programme

Example: You have selected a function and the required settings such as the temperature.

You want to switch off the Keeping warm function for this cooking programme.

- Select the ↵ sensor.
- Select Keeping warm | Off.
- Confirm with *OK*.

The Keeping warm function is switched off. The door remains closed at the end of the cooking programme. The cooling fan cools the food and the oven compartment.

The setting for the Rapid cooling function remains unchanged.

Crisp function

It is a good idea to use the Crisp function (moisture reduction) when cooking food which has a moist topping e.g. quiche, pizza, tray bakes with fresh fruit toppings or muffins.

Poultry in particular gets a good crisp skin with this function.

Switching on the Crisp function

The Crisp function can be used with any oven function and has to be switched on separately for each cooking programme.

Example: You have selected a function and the required settings such as the temperature.





You want to switch on the Crisp function for this cooking programme.

- Select the ↵ sensor.
- Select Crisp function | On.
- Confirm with *OK*.

The Crisp function is switched on.

Your oven is equipped with a steam injection system for cooking with moisture. When baking, roasting and cooking with the Moisture Plus  function, optimised steam supply and air flow guarantee even cooking and browning results.

You can also use moisture injection with various functions:

- Moisture Plus + Auto Roast 
- Moisture Plus + Fan Plus 
- Moisture Plus + Intensive Bake 
- Moisture Plus + Conv. Heat 

After selecting the function, set the temperature and the type and number of bursts of steam (Automatic burst of steam, Manual bursts of steam or Time-controlled bursts of steam).

Fresh tap water is taken into the steam system via the tube underneath the control panel on the left.

Liquids, other than water, can cause damage to the oven.
Only use tap water when cooking with moisture injection.

The water is injected as bursts of steam into the oven compartment during the cooking programme. The steam outlets are located in the rear left corner of the ceiling of the oven compartment.

Suitable food

One burst of steam takes about 5–8 minutes. The number of bursts of steam and when they are injected will depend on the type of food being cooked:

- **Yeast doughs** will rise better if steam is released at the beginning of the programme.

- **Bread and bread rolls** rise better if steam is released at the start. Injecting a burst of steam at the end of the programme will give the bread and rolls a glistening crust.
- When **roasting meat with a high fat content**, injecting steam at the beginning of roasting will help render the fat.

Additional moisture is not suitable for mixtures which already contain a lot of moisture, such as meringues. These need to dry out during baking.

Useful tip: Use the supplied recipes or the Miele App for reference.

Starting the cooking programme with Moisture Plus

It is normal for condensation to form on the inside of the door during a steam injection. This will evaporate during the course of the cooking programme.

- Prepare the food and place it in the oven.
- Select Moisture Plus .
- Select the desired function with moisture injection.
The cooking programmes proceed in the same way for all heating types.
- Confirm with *OK*.

The recommended temperature will appear.

Setting the temperature

- Change the recommended temperature if necessary.
- Confirm with *OK*.

The selection display for releasing the bursts of steam will appear.

Moisture Plus

Selecting bursts of steam

- If you would like a burst of steam to be automatically injected into the oven after the heating-up phase, select *Automatic burst of steam*.
- If you would like to inject one or more bursts of steam at specific times, select 1 burst of steam, 2 bursts of steam or 3 bursts of steam.
- Confirm with *OK*.

If you have selected multiple bursts of steam, the selection display for releasing the bursts of steam will appear.

- Select how you want the steam injections to be released.
 - Manual bursts of steam
You release the bursts of steam yourself.
 - Time-controlled bursts of steam
You set the times for the bursts of steam. The oven will inject 1, 2 or 3 bursts of steam at the specified times.
- Confirm with *OK*.

If you are cooking food – e.g. bread or rolls – in a pre-heated oven, it is best to inject the steam manually and select the *Pre-heat | On* function. The first burst of steam should be released as soon as you have placed the food in the oven.

If you select more than one burst of steam, the second burst of steam cannot be released until the temperature in the oven compartment has reached at least 130 °C.

If you want to use the *Pre-heat* function, take the heating-up phase into account for the manual and time-controlled bursts of steam (see “Operation – Pre-heat”).

- Set the times for the bursts of steam as required.
- Confirm with *OK*.
The prompt to draw in water appears.

Preparing and starting the water intake process

- Fill a suitable container with the required amount of fresh tap water.
- Open the door.
- Pull the water intake pipe forwards (located below the control panel on the left).

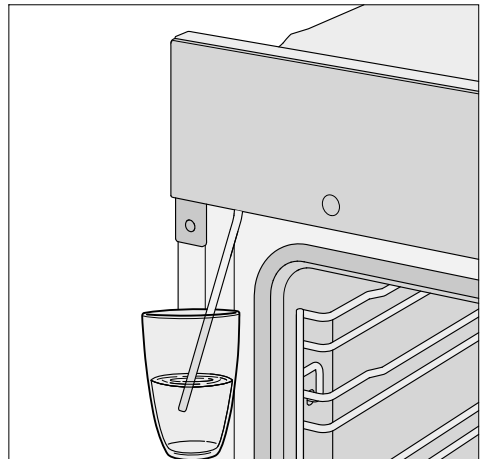

- Immerse the end of the water intake pipe in the container with tap water.
- Confirm with *OK*.

The intake process will begin.

The amount of water actually drawn up into the oven may be less than the amount specified as required, leaving a small amount in the container.

You can interrupt and resume the intake process at any time by selecting *OK*.

- Remove the water container after the water intake process and close the door.

The sound of the pump running can be heard again briefly. Residual water in the water intake pipe is being drawn into the oven.

The oven heating and cooling fan will switch on. The required and the actual temperature will appear.

You will see the temperature rising in the display. A buzzer will sound when the selected temperature is reached for the first time.

If you have selected Time-controlled bursts of steam, you can check the time before steam is released by touching **i** Info.

Injecting bursts of steam

 **Danger of injury caused by steam.** Steam can cause severe scalding. In addition, steam condensing on the control panel will cause the sensor controls and the touch display to react more slowly.

Do not open the door during a burst of steam.

Automatic burst of steam

The steam is released automatically after the heating-up phase.

The water will vaporise in the oven compartment.  and **Burst of steam active** appear in the display.

After the burst of steam,  and **Burst of steam active** will disappear.

- Continue cooking until the end of the programme.



Manual bursts of steam

The bursts of steam can be injected manually as soon as the  sensor lights up.



Please wait until the heating-up phase is completed to allow the steam to be distributed evenly by the warm air in the oven.

Useful tip: Refer to the supplied recipe book or the Miele App for tips on when to release the bursts of steam. Use the **Minute minder**  function to remind you to inject the steam.

- Select the  sensor.

The burst of steam will be released.  and **Burst of steam active** will appear in the display and the  sensor will go out.

- Proceed as described to inject further bursts of steam, as soon as the  sensor lights up.

After the last burst of steam is injected, the  sensor, the message and  all disappear from the display.

- Continue cooking until the end of the programme.

Time-controlled bursts of steam

The oven will release the bursts of steam automatically at the specified times.

 and **Burst of steam active** appear when the steam is being injected.

After the last burst of steam is injected,  and **Burst of steam active** disappear.

- Continue cooking until the end of the programme.

Evaporate residual moisture

When cooking using the addition of moisture, the water will be equally distributed between the number of bursts of steam and used up as long as the programme is not interrupted.

If a programme using the addition of moisture is manually interrupted before all the bursts of steam have been injected or if there is a power cut, the

Moisture Plus

water for these unused bursts of steam will remain in the steam injection system.

The next time Moisture Plus  or an Automatic programme with moisture injection is used, Evaporate residual moisture will appear in the display.

- It is best to start the evaporation of residual water straight away so that only fresh water is used during the next cooking programme.

 Danger of injury caused by steam.

Steam can cause severe scalding.
Do not open the door during a burst of steam.

Depending on the amount of water, the evaporation of residual water can take up to 30 minutes.

The oven compartment is heated up and the remaining water is evaporated, causing condensation to form in the oven compartment and on the door.

- This condensation needs to be wiped off the door and oven compartment once the oven has cooled down.

Starting residual moisture evaporation immediately

 Danger of injury caused by steam.

Steam can cause severe scalding.
Do not open the door during a burst of steam.

- Select an oven function or an Automatic programme that uses the addition of moisture.

The Evaporate res. moisture? query will appear.

- Select Yes.

Evaporate residual moisture and a time appear in the display.

The residual moisture evaporation process will start. You can follow the time counting down in the display.

The time shown in the display will depend on the amount of residual water left in the system. During the evaporation process, the duration may be adjusted by the system according to the actual amount of water present.

At the end of the residual water evaporation process, a buzzer will sound and Finished will appear.

A cooking programme with a function or an Automatic programme that uses moisture can now be run.

While the residual water is evaporating, the moisture will condense on the door and in the oven interior. This moisture needs to be wiped off after the oven has cooled down.

Skipping residual moisture evaporation

Skipping the residual moisture evaporation process can, in certain cases, cause water to overflow into the oven compartment.

It is best not to cancel the evaporation process.

- Select an oven function or an Automatic programme that uses the addition of moisture.

Evaporate res. moisture? appears in the display.

- Select Skip.

A cooking programme with a function or an Automatic programme that uses moisture can now be run.

You will be prompted to carry out the evaporation of residual water the next time you select the function or an Automatic programme that uses moisture, and when you switch the oven off.

The wide range of Automatic programmes enable you to achieve excellent results with ease.

Categories

The **Auto** Automatic programmes are sorted into categories to provide a better overview. Simply select the appropriate Automatic programme for the type of food you are cooking and follow the instructions in the display.

Using Automatic programmes

- Select Automatic programmes **Auto**.

A list will appear.

- Select the desired food category.

The Automatic programmes available for the food type selected will appear.

- Select the Automatic programme that you want to use.
- Follow the instructions in the display.

Some Automatic programmes will prompt you to use the food probe. Read the information under “Roasting – Food probe”.

The core temperature cannot be changed for the Automatic programmes.

Useful tip: Use **i** Info to display information such as how to place or turn the food depending on the cooking programme.

Usage notes

- When using Automatic programmes, the recipes provided are designed as a guide only. Other similar recipes, including those using different quantities, can be used for the Automatic programme in question.
- After cooking, allow the oven compartment to cool down to room temperature again before starting an Automatic programme.
- Some Automatic programmes require a pre-heating phase before food can be placed in the oven. A prompt will appear in the display indicating when this needs to be done.
- Some Automatic programmes require the addition of liquid after a certain cooking duration. You will be prompted by a message in the display when this needs to be done (e.g for adding liquid).
- The duration quoted for Automatic programmes is an estimate. It may increase or decrease depending on the programme. The duration, in particular with meat, will vary depending on the initial temperature of the food.
- When using the food probe, the cooking duration will depend on when the core temperature is reached.
- If by the end of an Automatic programme the food is not cooked enough, select **Continue cooking** or **Continue baking**. Conventional heating will then be used for 3 minutes to continue cooking or baking the food.

Other applications

This section provides information on the following applications:

- Defrost
- Drying
- Heat crockery
- Prove yeast dough
- Keeping warm
- Low temperature cooking
- Bottling
- Frozen food/Ready meals

Defrost

Gentle defrosting of frozen goods means that the vitamins and minerals are generally retained.

- Select Other .
- Select Defrost.
- Alter the recommended temperature if necessary and then set the duration.

Air is circulated throughout the oven compartment to gently defrost the frozen food.

 Risk of infection from bacteria. Bacteria such as salmonella can cause life-threatening food poisoning. It is particularly important to observe food hygiene rules when defrosting fish and meat, and in particular when defrosting poultry. Do not use the liquid produced during defrosting. Process the food as required as soon as it has been defrosted.

Useful tips

- Remove the packaging and place the frozen goods on the universal tray or in a suitable bowl or dish.

- Use the universal tray with the rack placed on top of it for defrosting poultry. This way the frozen food will not be lying in the defrosting liquid.
- Meat and poultry need to be fully defrosted before cooking. Fish, on the other hand, can be partially defrosted before cooking. Defrost so that the surface is sufficiently soft to take herbs and seasoning.

Drying

Drying is a traditional method of preserving fruit, certain vegetables and herbs.





It is important that fruit and vegetables are ripe and not bruised before they are dried.



- Prepare the food for drying by cutting it up, and peeling and coring it if necessary.
- Distribute the food for drying evenly in a single layer according to size over the rack or the universal tray.

Useful tip: You can also use the perforated Gourmet baking and AirFry tray, if you have one.

- Dry on a maximum of 2 levels at the same time. Place the food for drying on shelf levels 1+3. If using the rack and universal tray, place the universal tray below the rack.
- Select Other .
- Select Drying.
- Alter the recommended temperature if necessary and then set the drying time.
- Follow the instructions in the display.
- Turn the food for drying on the universal tray at regular intervals.

The drying times are longer for whole or halved dried food.

Food		🌡️ [°C]	🕒 [h]
Fruit		60–70	2–8
Vegetables		55–65	4–12
Mushrooms		45–50	5–10
Herbs*		30–35	4–8

-  Special application/Function,
- 🌡️ Temperature, 🕒 Drying time,
-  Special application Drying,
-  function Conventional Heat

* Dry herbs only on the universal tray on level 2 and use the Conventional Heat  function, as the fan is switched on in the Drying Special application.

- Reduce the temperature if condensation begins to form in the oven.

Removing the dried food

 Risk of injury caused by hot surfaces.

The oven gets hot during operation. You could burn yourself on the heating elements, the oven compartment, or accessories. Use oven gloves when removing dried food from the oven.

- Allow the dried fruit or vegetables to cool down after drying.

Dried fruit needs to be completely dry, but also soft and elastic. Juice should not escape when cut.

- Store dried food in sealed glass jars or tins.

Heat crockery

By pre-heating the crockery, the food does not cool down as quickly.

Use heat-resistant crockery.

- Place the rack on shelf level 2 and place the crockery to be pre-heated on it. Depending on the size of the dishes, you can also place them on the oven floor and take out the shelf runners to make more room.
- Select Other .
- Select Heat crockery.
- Alter the recommended temperature if necessary and then set the duration.
- Follow the instructions in the display.

 Risk of injury caused by hot surfaces.

The oven gets hot during operation. You could burn yourself on the heating elements, the oven compartment, or accessories. Droplets of water may have accumulated underneath the crockery.

Wear oven gloves when removing dishes from the oven.

Prove yeast dough

This programme is designed specifically for proving yeast dough.

- Select Other .
- Select Prove yeast dough.
- Select the proving time.
- Follow the instructions in the display.

Other applications

Keeping warm

You can keep food warm in the oven compartment for several hours.

In order to maintain the quality of food, select the shortest possible time.

- Select Other .
- Select Keeping warm.
- Place the food to be kept warm in the oven and confirm with *OK*.
- Alter the recommended temperature if necessary and then set the duration.
- Follow the instructions in the display.

Low temperature cooking

Low temperature cooking is ideal for cooking delicate cuts of beef, pork, veal or lamb when a tender result is desired.

First briefly sear the meat all over at a high temperature on the cooktop in order to seal it.

Then place the meat in the pre-heated oven where the low temperature and long cooking duration will cook it to perfection and ensure it is very tender.

The meat will relax. The juices inside will start to circulate evenly throughout the meat to reach the outer layers.

This gives very tender and succulent results.

- Use lean meat which has been correctly hung and trimmed. Bones should be removed before cooking.
- For searing, use a suitable cooking oil or fat that can withstand high temperatures (e.g. clarified butter, vegetable oil).
- Do not cover meat during the cooking process.

The cooking duration takes approx. 2–4 hours depending on the weight and size of the meat and how well you want it cooked.

- As soon as the cooking programme has finished, you can carve the meat straight from the oven. It does not need to rest.
- The meat can be left in the oven compartment to keep warm until you serve it. This will not affect results in any way.
- Serve on pre-heated plates with very hot sauce or gravy to prevent it cooling down too quickly. The meat is at the ideal temperature for eating straight away.

If using the food probe, please observe the information under “Roasting – Food probe”.

Using Conventional Heat

Refer to the information in the cooking charts at the end of this booklet.

Use the universal tray with the rack placed on top of it.

- Place the rack together with the universal tray on shelf level 2.
- Pre-heat the oven together with the universal tray and rack for approx. 15 minutes.
- While the oven is pre-heating, sear the meat on all sides on the cooktop.

 Risk of burning due to hot surfaces.

The oven gets hot during operation. You could burn yourself on the heating elements, the oven compartment, or accessories.

Wear oven gloves when placing food in the oven or removing it, and when adjusting oven shelves etc. in a hot oven.

- Place the seared meat on the oven rack.
- Reduce the temperature to 100 °C (see “Cooking charts”).
- Continue cooking until the end of the programme.

Bottling

 Risk of infection from bacteria.

The spores of the botulinum bacterium are not sufficiently killed by bottling pulses and meat only once. Toxins may form which can lead to serious poisoning. These spores are only destroyed by reheating the food within 2 days after preserving.

After they have cooled down, **always** reheat pulses and meat a second time within 2 days.

 Risk of injury from increased pressure in sealed tins.

Preserving and heating food in sealed tins will result in an increase in pressure, which can cause them to explode.

Do not use tins for preserving or heating food.

Preparing fruit and vegetables

The instructions are for 6 jars with a capacity of 1 litre each.

Only use special jars for preserving (preserving jars or jars with a screw cap). Only use undamaged jars and rubber rings.

- Rinse the jars with hot water before bottling and fill them up to a maximum of 2 cm below the rim.
- After you have filled the jars with the produce, clean the glass rims with a clean cloth and hot water and then seal the jars.
- Place the universal tray on shelf level 2 and place the closed jars on the tray.
- Select the Fan Plus  function and a temperature of 160–170 °C.
- Wait until bubbles evenly rise in the jars.

Reduce the temperature in time to prevent the contents from boiling over.



Bottling fruit and gherkins

- Set the specified continued warming temperature as soon as bubbles are visible in the jars, then leave the jars in the warm oven for the time specified.

Bottling vegetables

- As soon as bubbles are visible in the jars, set the specified bottling temperature and cook the vegetables for the time specified.
- After bottling, set the specified continued warming temperature, then leave the jars in the warm oven for the time specified.

Other applications

		
Fruit	-/-	30 °C 25–35 min.
Gherkins	-/-	30 °C 25–30 min.
Beetroot	120 °C 30–40 min.	30 °C 25–30 min.
Beans (green or yellow)	120 °C 90–120 min.	30 °C 25–30 min.

 Bottling temperature and time once bubbles are visible in the jars

 Continued warming temperature and time

Removing the jars after bottling

 Risk of injury caused by hot surfaces.

The jars are very hot after bottling. Wear oven gloves when removing the jars from the oven.

- Take the jars out of the oven.
- Cover the jars with a towel and leave for approx. 24 hours in a draught-free area.
- After they have cooled down, **always** reheat pulses and meat a second time within 2 days.
- Remove the fasteners from the jars and make sure all jars are closed properly when storing them.

Either boil open jars again or store them in a cool place and consume the preserved fruit or vegetables immediately.

- Check the jars during storage. If jars have opened during storage or if the screw cap is bulging and does not make a popping noise when opened, destroy the contents.

Frozen food/Ready meals

Tips for cakes, pizza and baguettes

- Bake cakes, pizza and baguettes on baking paper on the rack. Do not use the baking tray or the universal tray for frozen foods with a large surface area. The tray could become warped and difficult, or even impossible, to remove from the oven compartment when hot. Additional use will make the warping worse.
- Use the lowest temperature recommended on the packaging.

Tips for oven chips, croquettes and similar items

- These frozen items can be cooked on the baking tray or universal tray.
- Use the lowest temperature recommended on the packaging.
- Turn food several times during cooking.

Preparing frozen food/ready meals

Handling food carefully will help protect your health.

Cakes, pizzas and chips should be cooked until golden, not dark brown.

- Select the function and temperature recommended on the manufacturer's packaging.
- Pre-heat the oven.
- Place the food in the pre-heated oven on the shelf level recommended on the packaging.
- Check the food at the end of the shortest cooking duration recommended on the packaging.

You can create and save up to 20 of your own programmes.

- You can combine up to 10 cooking stages to accurately programme your favourite or most frequently used recipes. In each cooking stage you can select settings such as function, temperature and duration or core temperature.
- You can specify the shelf level(s) for the food.
- You can enter the name of the programme for your recipe.

When you call up and start your programme the next time, it will run automatically.

There are different ways of creating a User programme:

- At the end of an Automatic programme, save it as a User programme.
- After running a programme with a set duration, save it.

Then name the programme.

Creating a User programme

- Select Other .
- Select User programmes.
- Select Create programme.

You can now specify the settings for the first cooking stage.

Follow the instructions in the display:

- Select and confirm the desired settings.

If you select the Pre-heat function, first complete the first cooking stage. Use Add cooking stage to then add another cooking stage where you set a cooking duration. Only then can you save or start the programme.

- Select Complete cooking stage.

All settings for the first cooking stage have now been set.

You can add more cooking stages, for example, if you want to add another cooking function to follow on from the first.

- If additional cooking stages are required, select Add cooking stage and proceed as you did for the first cooking stage.
- When you have finished setting all the cooking stages, select Set the shelf level.
- Select the desired level(s).
- Confirm with *OK*.

If you want to check the settings or to change them at a later date, select the cooking stage in question.

- Select Save.
- Enter the programme name.
- Select .

A message will appear in the display confirming that the new name has been saved.

- Confirm with *OK*.

You can start the saved programme immediately, delay the start or change the cooking stages.

User programmes

Starting a User programme

- Place the food in the oven.
- Select Other .
- Select User programmes.
- Select the required programme.
- Select Allow.

Depending on the programme settings, the following menu options will appear in the display:

- Start now
The programme will start immediately. The oven heating will switch on immediately.
 - Finish at
Specify the time at which the programme should finish. The oven heating will switch off automatically at the time you have set.
 - Start at
Specify the time at which you want the programme to start. The oven heating will switch on automatically at the time you have set.
 - Show cooking stages
A summary of your settings will appear in the display.
 - Display actions
The required actions, e.g. placing the food in the oven, will appear in the display.
- Select the required menu option.
 - Confirm the message regarding which shelf level to use with *OK*.

The programme selected will begin straight away or at the time set.

Use **i** Info to display information such as how to place or turn the food depending on the cooking programme. During the cooking programme, use  to switch the Rapid cooling and Keeping warm functions on or off.

- At the end of the programme, select the  sensor.

Changing cooking stages

Cooking stages in an Automatic programme that you have renamed as a User programme cannot be changed.

- Select Other .
- Select User programmes.
- Select the programme you want to change.
- Select Change programme.
- Select the cooking stage that you want to change or Add cooking stage to add another cooking stage.
- Select and confirm the desired settings.
- If you want to start the modified programme without changing it, select Start programme.
- Select Save when you have changed all the settings.

A message will appear in the display confirming that the new name has been saved.

- Confirm with *OK*.

The saved programme has been changed and you can start it immediately or delay the start.

Changing a name

- Select Other .
- Select User programmes.
- Select the programme you want to change.
- Select Change name.
- Change the programme name.
- Select ✓.
- Once you have changed the programme name, select Save.

A message will appear in the display confirming that the new name has been saved.



- Confirm with *OK*.

The programme has now been renamed.

Deleting User programmes

- Select Other .
- Select User programmes.
- Select the programme you want to delete.
- Select Delete programme.

The programme will be deleted.

Go to Other  | Settings  | Factory default | User programmes to delete all User programmes at the same time.

Baking

Handling food carefully will help protect your health.
Cakes, pizzas and chips should be cooked until golden, not dark brown.

Tips on baking

- Set a cooking duration. When baking, the oven should not be set to start a long time off. Otherwise the cake mixture or dough will dry out, and the raising agents will lose their effectiveness.
- Generally, you can use the rack, baking tray, universal tray and any type of baking tray made of heat-resistant material.
- Avoid using bright, thin-walled tins as they give an uneven or poor browning result. In certain unfavourable conditions, the food will not cook properly.
- Place cakes in rectangular tins on the rack with the longer side across the width of the oven for optimum heat distribution and even results.
- Always place bakeware on the rack.
- Bake cakes with fruit toppings or deep cakes on the universal tray.

Using baking paper

Miele accessories, e.g. the universal tray, are treated with PerfectClean enamel (see “Features”). Surfaces treated with PerfectClean enamel generally do not need to be greased or covered with baking paper.

- Use baking paper when baking lye pastries (e.g. pretzels) because the sodium hydroxide can damage the PerfectClean treated surface.

- Use baking paper when baking sponge, meringue, macaroons or similar items. These are more likely to stick due to their high egg white content.
- Use baking paper when cooking frozen food on the rack.

Notes on the cooking charts

You can find the cooking charts at the end of this book.

Selecting the temperature

- As a general rule, select the lower temperature given in the chart. Baking at temperatures higher than those recommended may reduce the cooking duration, but will lead to uneven browning of the food, and unsatisfactory cooking results.

Selecting the cooking duration

Unless otherwise stated, the cooking durations given in the cooking charts are for an oven compartment which has not been pre-heated. With a pre-heated oven compartment, shorten durations by around 10 minutes.

- As a general rule, check whether the food is cooked after the shortest duration. Stick a wooden skewer into the food.

If it comes out clean without any batter/dough on it, the food is done.

Notes on the oven functions

You can find an overview of all the functions with their recommended values in “Main and sub-menus”.

Using Automatic programmes

- Follow the instructions in the display.

Using Fan Plus

Because the fan distributes the heat around the oven compartment straight away, you can use a lower temperature than you would with the Conventional Heat  function.

Use this function if you are baking on multiple shelf levels at the same time.

- 1 shelf: Place the food on shelf level 2.
- 2 shelves: Place the food on shelf levels 1+3 or 2+4.
- 3 shelves: Place the food on shelf levels 1+3+5.

Useful tips

- If you are cooking on multiple shelf levels at the same time, slide the universal tray in on the lowest level.
- For moist biscuits and cakes, bake on a maximum of 2 shelf levels at once.

Using Moisture Plus

Use this function with your preferred type of heating for cooking with moisture injection.

- Place the food on shelf level 2.

Using Intensive Bake

Use this function for baking cakes with moist toppings.

Do **not** use this function for baking thin biscuits.

- Place cakes on shelf level 1 or 2.

Using Conventional Heat

Dark metal, enamel, or aluminium bakeware with a matt finish, as well as heat-resistant glass, ceramic, and coated bakeware can be used.

Use this function for baking traditional recipes. If using an older recipe or cookbook, set the oven temperature 10 °C lower than that recommended. This will not change the cooking duration.

- Place the food on shelf level 1 or 2.

Using Eco Fan Heat

Use this function for cooking small amounts of food, e.g. frozen pizzas, bake-off rolls or biscuits, while saving energy.

- Place the food on shelf level 2.

Roasting

Tips for roasting

- You can use any crockery made from temperature-resistant materials, e.g. oven dishes, roasting pans with lid, ovenproof glass dishes, roasting bags, dishes made from earthenware or cast iron, the universal tray, rack and/or grilling and roasting insert (if present) on top of the universal tray.
- **Pre-heating** the oven compartment is only required when roasting beef sirloin joints and fillet. Pre-heating is generally not necessary.
- Use a **closed roasting dish** for roasting meat, such as an oven dish. The meat stays succulent. The oven compartment will also stay cleaner than when roasting on the rack. It ensures that sufficient stock remains for making gravy.
- If you are using a **roasting bag**, follow the instructions on the packaging.
- If you are using the **rack** or an **open roasting dish** for roasting, you can add a little fat or oil to very lean meat or place a few strips of streaky bacon on the top.
- **Season** the meat and place in the roasting dish. Dot with butter or margarine or brush with oil or cooking fat if necessary. For large lean cuts of meat (2–3 kg) and fatty poultry, add about 1/8 l of water to the dish.
- Do not add too much liquid during cooking as this will hinder the **browning** of the meat. Browning only occurs towards the end of the cooking duration. Remove the lid about halfway through the cooking duration if a more intensive browning result is desired.





- At the end of the programme, take the food out of the oven compartment, cover it and leave to **stand** for about 10 minutes. This helps retain juices when the meat is carved.
- For a crisp finish, baste **poultry** 10 minutes before the end of the cooking duration with slightly salted water.

Notes on the cooking charts

You can find the cooking charts at the end of this book.

- Take note of the temperature range, the shelf levels and the timings. These also take the type of cooking container, the size of the meat and cooking practices into account.

Selecting the temperature

- As a general rule, select the lower temperature given in the chart. If higher temperatures than those specified are used, the meat will brown on the outside, but will not be properly cooked through.
- When cooking with Fan Plus , Moisture Plus  or Auto Roast , select a temperature which is approx. 20 °C lower than with Conventional Heat .
- For cuts which weigh more than 3 kg, select a temperature approx. 10 °C lower than that given in the chart. The roasting process will take longer, but the meat will cook evenly through and the skin or crackling will not be too thick.
- When roasting on the rack, set a temperature approx. 10 °C lower than for roasting in a covered oven dish.



Selecting the cooking duration

Unless otherwise stated, the durations given in the cooking chart are for an oven compartment which has not been pre-heated.

- Determine the cooking duration by multiplying the thickness of the roast [cm] with the time per cm [min./cm] stated below, depending on the type of meat:
 - Beef/Venison: 15–18 min./cm
 - Pork/Veal/Lamb: 12–15 min./cm
 - Sirloin joints/Filletts: 8–10 min./cm
- As a general rule, check whether the food is cooked after the shortest duration.

Notes on the oven functions

You can find an overview of all the functions with their recommended values in “Main and sub-menus”.



Use the **Bottom Heat**  function towards the end of the cooking duration to brown the base of the food.
Do not use the **Intensive Bake**  function for roasting as the juices will become too dark.

Using Automatic programmes

- Follow the instructions in the display.

Using Fan Plus or Auto Roast

These functions are suitable for roasting meat, fish and poultry that needs to be well browned as well as sirloin joints and fillet.

The **Fan Plus**  function allows you to use a lower temperature than you would with the **Conventional Heat**  function, because the heat is immediately distributed throughout the oven compartment.

With the **Auto Roast**  function, the oven compartment heats initially to a high searing temperature (approx. 230 °C). As soon as this temperature has been reached, the oven automatically drops the temperature back down to the pre-selected roasting temperature (continued roasting).

- Place the food on shelf level 2.

Using Moisture Plus

Use this function with your preferred type of heating for cooking with moisture injection.

- Place the food on shelf level 2.

Using Conventional Heat

Use this function for baking traditional recipes. If using an older recipe or cookbook, set the oven temperature 10 °C lower than that recommended. This will not change the cooking duration.

- Place the food on shelf level 2.

Using Eco Fan Heat

Use this function for cooking smaller roasts or meat dishes in an energy-saving way.

- Place the food on shelf level 2.

Roasting

Food probe

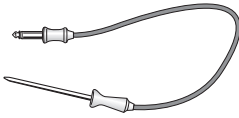

The food probe enables the temperature to be monitored precisely during a cooking programme.

How it works

The metal tip of the food probe must be inserted into the centre of the food all the way to the handle. There is a temperature sensor in the metal tip which measures the core temperature of the food during cooking. The rise in the core temperature of the food reflects the progress of cooking. Set a lower or higher core temperature, depending on whether you want your roast to be rare, medium or well-done.









The core temperature can be set up to 99 °C. Information on food and respective core temperatures can be found in the cooking charts at the end of this book.

The cooking duration will be similar when cooking with or without the food probe.

Options for use

Some Automatic programmes and Special applications will prompt you to use the food probe.

You can also use the food probe with User programmes and with the following functions:

- Auto Roast 
- Fan Plus 
- Intensive Bake 
- Conventional Heat 
- Moisture Plus + Auto Roast 
- Moisture Plus + Fan Plus 
- Moisture Plus + Intensive Bake 
- Moisture Plus + Conv. Heat 

Important notes on use

- You can place the meat in a pot or on the rack.
- The metal tip of the food probe must be fully inserted into the centre of the food so that the temperature sensor reaches more or less to the core.
- When cooking poultry, insert the metal tip into the thickest part of the breast. You can find the thickest part of the breast by pressing the area with your thumb and index finger.
- The metal tip must not touch any bone or be inserted in areas with a lot of fat. Heavily marbled areas and bones can cause cooking to end prematurely.
- If the meat is very heavily marbled with fat, select the highest core temperature given in the cooking charts.
- When using aluminium foil or roasting bags, insert the food probe through the foil/bag into the centre of the food. You can also place meat inside the bag or foil with the food probe already inserted. Follow the roasting bag manufacturer's instructions.

Using the food probe

- Fully insert the metal tip of the food probe into the centre of the meat.

If you are cooking several pieces of meat at the same time, insert the food probe into the largest piece of meat.

- Place the food in the oven.

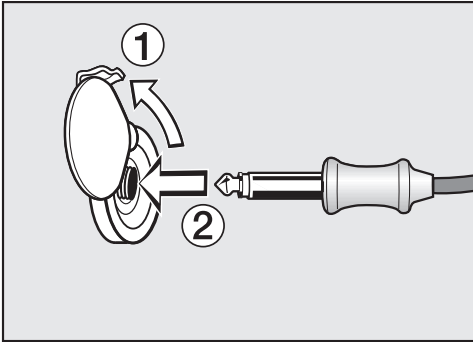

- Plug the food probe into the connection socket so that it clicks into place.
- Close the door.
- Select the oven function or Automatic programme.
- Set the temperature and the core temperature if necessary.

The core temperature cannot be changed for the Automatic programmes.
Follow the instructions in the display.

The cooking programme finishes as soon as the core temperature is reached.

⚠ Risk of injury caused by hot surfaces.

The food probe can get hot. You can burn yourself on the food probe.
Wear oven gloves when removing the food probe.

Delaying the start of a cooking programme with food probe

You can delay the start of the cooking programme to a later time.

- Once you have selected a function, touch the  sensor.
- Select Start at.

You can estimate approximately when the food will be ready as the duration of the cooking programme is about the same as if you were cooking food without using the food probe.

You cannot set Duration and Finish at because the total cooking duration is determined by when the set core temperature is reached.

Time left display

If the temperature set for a cooking process is above 140 °C, the estimated time left for the cooking process will appear in the display after a short while.

The time left is calculated from the cooking temperature selected, the set core temperature, and the progress of the core temperature as it rises.

The time left first shown is an estimate. As the cooking process continues, the time left is revised continuously, and a more accurate figure is shown.

The time left will be deleted if the cooking temperature or core temperature is changed or if a different function is selected. If the door is opened for a longer time, the time left will be recalculated.

Grilling

 Risk of injury caused by hot surfaces.

If you grill with the door open, hot air will escape from the oven instead of being cooled by the cooling fan. The control elements will get hot. Grill with the oven door closed.

Tips for grilling

- Pre-heating is necessary when grilling. Pre-heat the top heat/grill element for approx. 5 minutes with the door closed.
- Trim the meat if necessary. Season meat 10-15 minutes before cooking.
- Add a little oil to lean meat if necessary. Do not use other types of fat as they can easily burn and cause smoke.
- Clean fish in the normal way. To enhance the flavour, season with a little salt. Fish can also be drizzled with lemon juice.
- Use the universal tray with the rack or the grilling and roasting insert (if present) placed on top. The tray under the insert will collect the meat juices and stop them from burning so that they can be used for making gravy and sauces. To grill, brush the rack or the grilling and roasting insert with oil and then place the food on the rack.

Do not use the baking tray.

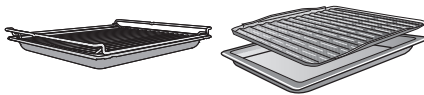

Notes on the cooking charts

You can find the cooking charts at the end of this book.

- Take note of the temperature range, the shelf levels and the timings. These take the size of the meat and cooking practices into account.
- Check the food after the shortest duration quoted.

Selecting the temperature

- As a general rule, select the lower temperature given in the chart. If higher temperatures than those specified are used, the meat will brown on the outside, but will not be properly cooked through.

Choosing a shelf level

- Select the shelf level depending on the thickness of the food to be cooked.
- Place flat food on shelf level 3 or 4.
- Place thicker food on shelf level 1 or 2.

Selecting the cooking duration

- Grill thinner cuts of meat/slices of fish for approx. 6–8 minutes per side. It is best to grill food of a similar thickness at the same time so that the cooking durations do not vary too much.
 - As a general rule, check whether the food is cooked after the shortest duration.
 - To **test the food**, press down on the meat with a spoon. This lets you determine how well the meat has been cooked.
- **Rare**
If the meat gives easily to the pressure of the spoon, it will still be red on the inside.
 - **Medium**
If there is some resistance, the inside will be pink.
 - **Well-done**
If there is great resistance, it is cooked through.

Useful tip: If the surface of a thicker cut of meat is browned but the centre is still raw, move the food to a lower level or reduce the temperature and continue grilling. This will stop the surface from becoming excessively charred.

Notes on the oven functions

You can find an overview of all the functions with their recommended values in “Main and sub-menus”.

The plastic on the food probe can melt at very high temperatures. Do not use the food probe when using the Grill functions. Do not store the food probe in the oven compartment when it is not being used.

Using Full Grill

Use this function to grill flat thin cuts in large quantities and for browning large baked dishes.

The entire top heat/grill element will get hot and glow red.





Using Fan Grill

This function is suitable for grilling thicker food, such as chicken.

A temperature setting of 220 °C is generally recommended for thinner types of food, while 180–200 °C is recommended for thicker cuts.

Grilling

Fan Grill

- Use the Fan Grill  function for meat, fish, poultry and vegetables.
- Always pre-heat for at least 5 minutes before Fan Grilling.
- It is not necessary to turn food when Fan Grilling . Only one side of the food, however, will become brown.
- The door must be closed when using Fan Grill .
- When using red meat, pat the meat dry before Fan Grilling as this encourages a richer colour.
- **Ovens with the Crisp function:** Activate the Crisp function (moisture reduction) at the beginning of the Fan Grill  function. This is great for items that are moist on the inside and should be crispy on the outside.

All temperatures are approximations and must be varied according to the thickness and preparation of the meat. The chart below is a suggested guide only. Personal taste and size of serves will vary times and temperatures. We recommend you monitor cooking results for best outcomes.

Food to be grilled	🌡️ [°C]	 5 1	🕒 [min.]
Lean thin sausages	180	4	8–10
Thick sausages	180	4	15–20
Lean beef fillet steak	220	5	6–12
Chicken breast fillet	200	4	14–18
Whole butterflied chicken	200	3	30–35
Thin white fish fillets	220	5	6–10
Thick fish fillets, cutlets or steaks	200	4	10–15
Oily fish	200	4	8–12
Lamb loin chops	190	4	12–16
Lamb back straps	220	5	8–10
Vegetables, capsicum, zucchini, sweet potato, eggplant	200	5	12–15
Potato wedges or small roast potatoes	220	3	20–25
Kebabs and satays (red meat)	200	5	12–15
Chicken satays	200	4	12–15

🌡️ Temperature /  Shelf level / 🕒 Duration

Fan Grill  can be used for small roasts but is only recommended for lean, tender cuts of meat, e.g. lamb racks, rump roasts, and beef fillet. Fan Grill the roast at 200 °C on shelf level 3 for approximately 25 minutes, depending on thickness.

Grill

- Use Grill  for thick toasts, muffins, cheese on toast, focaccia, bruschetta and bacon.
- Pre-heat the grill for at least 5 minutes at 200–220 °C.
- Select the appropriate shelf level for the thickness of the food.
- The door must be closed when using the Grill function.

This is a suggested guide only. Personal taste and size of serves will vary times and temperatures.

Cleaning and care



Risk of injury caused by hot surfaces.

The oven gets hot during operation. You could burn yourself on the heating elements, the oven compartment, or accessories.

Allow the heating elements, oven compartment and the accessories to cool before manual cleaning.



Risk of injury due to electric shock.

The steam from a steam cleaning appliance could reach electrical components and cause a short circuit.

Never use a steam cleaner for cleaning the oven.

The use of unsuitable cleaning agents can cause the surfaces to discolour or alter. The oven front is particularly susceptible to damage from oven cleaners or descaling agents.

All surfaces of this appliance are susceptible to scratching. Scratches on glass surfaces could cause a breakage in certain circumstances. Remove all cleaning agent residues immediately.

Cosmetic products, especially sunscreen, and hand disinfectants can leave stains on matt glass surfaces.

If cosmetic products come into contact with a matt glass surface, remove the residue immediately with hot water, washing-up liquid and a clean microfibre cloth.

Unsuitable cleaning agents

To avoid damaging the surfaces of your appliance, do not use:

- cleaning agents containing soda, alkalines, ammonia, acids or chlorides
- cleaning agents containing descaling agents on the front
- abrasive cleaning agents, e.g. powder cleaners and cream cleaners
- solvent-based cleaning agents
- stainless steel cleaning agents
- dishwasher cleaners
- glass cleaning agents
- cleaning agents for ceramic cooktops
- hard, abrasive brushes or sponges, e.g. pot scourers, brushes or sponges which have been previously used with abrasive cleaning agents
- dirt eraser sponges
- sharp metal scrapers
- steel wool or metal scourers
- spot cleaning with mechanical cleaning agents
- oven cleaner
- stainless-steel spiral pads

If soiling is left on for any length of time, it may become impossible to remove. Continued use without regular cleaning will make the oven much harder to clean. Failure to maintain the oven in a clean condition could lead to deterioration of the surfaces that could adversely affect the life of the appliance and result in a hazardous situation. Remove any soiling immediately.

The accessories are not dishwasher-safe.

Useful tip: Soiling caused by spilled fruit juices and cake mixtures is best removed while the oven is still warm. Exercise caution and make sure the oven is not too hot.

To make it easier to clean the oven:

- Remove the door.
- You can remove the shelf runners together with the FlexiClip telescopic runners (if present).
- Lower the top heat/grill element.

Removing normal soiling

The fibreglass seal around the front of the oven should be handled carefully. Do not rub and scour it. Ideally, you should avoid cleaning it.

Removing normal soiling

- It is best to remove normal soiling immediately using a clean sponge and a solution of hot water and washing-up liquid, or a clean, damp microfibre cloth.
- Remove any residual cleaning agent thoroughly with clean water. This is particularly important for any parts with a PerfectClean finish, as cleaning agent residues will impair the non-stick properties.
- After cleaning, wipe the surfaces dry using a soft cloth.

Cleaning the food probe

Do not put the food probe into water or clean it in the dishwasher as this will damage it.
Clean the food probe with a damp cloth only.

Removing stubborn soiling (excluding the FlexiClip telescopic runners)

Spilled fruit and roasting juices may cause lasting discolouration or matt patches on surfaces. This discolouration will not affect the functional characteristics of the surface finish.

Do not attempt to remove these marks. Clean them following the instructions given here.

- Baked-on deposits can be removed with a glass scraper or with a stainless steel spiral pad, hot water and washing-up liquid.

Using oven cleaners

- Very stubborn soiling on PerfectClean surfaces can be cleaned using Miele Oven Cleaner. This cleaner must only be applied to cold surfaces.

If the oven spray gets into gaps and openings, a strong odour is generated during subsequent cooking programmes.

Do not spray the oven cleaner onto the roof of the oven compartment.

Do not spray the oven cleaner into the gaps and openings of the oven compartment walls and rear wall.

- Follow the instructions on the packaging.

Oven cleaners from other manufacturers must only be used in a cold oven and must not be left on for longer than 10 minutes.

Cleaning and care

- If necessary, the scouring pad on the back of a non-scratching washing-up sponge can be used to remove the soiling after the soaking time.
- Remove any residual cleaning agent thoroughly with clean water.
- Dry all surfaces with a soft cloth.

Pyrolytic cleaning

Instead of cleaning the oven compartment manually you can run the Pyrolytic  function.

During Pyrolytic cleaning the oven compartment reaches temperatures in excess of 400 °C. Any residual soiling is burnt off and turned to ash by the high temperatures.

There are 3 Pyrolytic settings available, each with a different duration.

- Level 1 for light soiling
- Level 2 for heavier soiling
- Level 3 for very heavy soiling

The oven door is automatically locked when the Pyrolytic cleaning process is started. It cannot be opened until after the programme has finished.

The timer can be used to delay the start time of the Pyrolytic cleaning programme, for instance to make use of cheaper electricity tariffs.

At the end of the Pyrolytic cleaning programme any residues such as ash from the pyrolytic process, which are formed depending on the oven compartment's degree of soiling, can be easily wiped away.

Preparing for pyrolytic cleaning

Accessories that are not suitable for pyrolytic cleaning will be damaged by the high temperatures.

Remove all accessories that are not suitable for pyrolytic cleaning from the oven before starting the pyrolytic cleaning programme. This also applies to non-pyrolytic accessories purchased separately to the oven.

The following accessories are suitable for pyrolytic cleaning and can be left in the oven compartment during pyrolytic cleaning:

- Shelf runners
 - FlexiClip telescopic runners HFC 72
 - Rack HBBR 72
- Take all non-pyrolytic accessories out of the oven.
 - Place the rack on the top shelf level.

Coarse soiling in the oven compartment can cause thick smoke to develop.

Burnt-on residues can leave lasting discolouration or matt patches on enamelled surfaces.

Before starting the Pyrolytic cleaning programme, remove coarse soiling from the oven compartment and scrape any burnt-on residues off enamelled surfaces with a glass scraper.

Starting pyrolytic cleaning

 Risk of injury caused by hazardous steam.

During pyrolytic cleaning, steam, which can irritate mucous membranes, may be released.

During pyrolytic cleaning, do not stay in the kitchen for longer periods of time and do not let children and pets enter the kitchen.

It is important to ensure that the kitchen is well ventilated during pyrolytic cleaning. Prevent odours from escaping into other rooms.

 Risk of injury caused by hot surfaces.

The oven gets much hotter during pyrolytic cleaning than during normal use.

Do not let children touch the oven during pyrolytic cleaning.

- Select Pyrolytic .
- Select the level required according to the amount of soiling.
- Confirm with *OK*.

Follow the instructions in the display.

- Confirm with *OK*.

You can start pyrolytic cleaning straight away or schedule it to begin at a later time.

Starting pyrolytic cleaning straight away



- To start the pyrolytic cleaning programme straight away, select *Start now*.
- Confirm with *OK*.

The pyrolytic cleaning programme will start.

The door will lock automatically. The oven heating and the cooling fan will switch on automatically.

The oven interior lighting will not come on during pyrolytic cleaning.

The time left for the pyrolytic cleaning programme will start counting down in the display. It cannot be changed.

You can use the minute minder at the same time as running the cleaning programme. At the end of the minute minder time a buzzer will sound,  will start flashing and the time can be viewed counting up in the display. When you touch the  sensor, the acoustic and optical signals will switch off.

Starting pyrolytic cleaning at a later time

- To start the pyrolytic cleaning programme later, select *Start at*.
- Confirm with *OK*.
- Set the time at which you want the pyrolytic cleaning programme to start.
- Confirm with *OK*.

The door will lock automatically. *Start at* and the set start time will appear in the display.

The  sensor lights up orange.

You can reset the start time via the  sensor at any point up to the starting time.

As soon as the start time is reached, the oven heating and the cooling fan will switch on automatically. The remaining duration of the programme will appear in the display.

Cleaning and care

Finalising pyrolytic cleaning

When the time remaining has counted down to 0:00 h, a message will appear in the display to tell you that the door is unlocking.

Process finished will appear in the display and a buzzer will sound as soon as the door has been unlocked.

- Switch the oven off.

The visual and acoustic signals will switch off.

 Risk of injury caused by hot surfaces.

At the end of the Pyrolytic cleaning programme, the oven will still be very hot. You could burn yourself on the heating elements, the oven compartment, or accessories.

Allow the heating elements, oven compartment and accessories to cool down before removing any pyrolytic residues and before oiling the shelf runners.

- Clean the oven compartment and accessories suitable for Pyrolytic cleaning to remove any pyrolytic residues (e.g. ash) that can build up depending on the degree of soiling in the oven compartment.
- Add a few drops of heat-resistant cooking oil to some paper towels and use this to lubricate the shelf runners.

Most residues can be removed with warm water, a little washing-up liquid and a clean sponge or a clean, damp microfibre cloth.

Depending on the level of soiling, a visible deposit can build up on the glass on the inside of the oven door. This can be removed with a dishwashing sponge, a glass scraper or a stainless steel spiral pad and a little washing-up liquid.

The fibreglass seal around the front of the oven should be handled carefully. Do not rub and scour it. Ideally, you should avoid cleaning it.

Enamelled surfaces can be permanently discoloured by spilled fruit juice. Such discolouration does not affect the properties of the enamel.

Do not attempt to remove these marks.

Extending and retracting the FlexiClip runners

After cleaning, discolouration or light patches may remain on the FlexiClip telescopic runners. This will not affect the functionality in any way.

- Extend and retract the FlexiClip telescopic runners several times after running the pyrolytic cleaning programme.

Descale

The frequency of descaling will depend on how often you use the Moisture Plus function.

The descaling process can be run at any time.

However, to ensure that the oven functions correctly, you will be automatically prompted to run the descaling process for the steam injection system after a certain number of programmes.

The oven will count down in the display the last 10 programmes that can be run before it needs to be descaled. You will then not be able to run any function or Automatic programme using moisture.

These functions can only be used again after you have carried out the descaling process. All other functions and Automatic programmes without moisture can still be used.

Descaling process sequence

Once the descaling process has been started it must be completed through to the end. It cannot be cancelled.

The descaling process takes approx. 90 minutes and consists of several steps:

1. Preparing the descaling process
2. Drawing in the descaling solution
3. Activation phase
4. Rinse 1
5. Rinse 2
6. Rinse 3
7. Evaporating residual moisture

Preparing the descaling process

Risk of damage from spilt descaling solution.

Sensitive surfaces and/or natural floors can suffer damage.

Wipe up any spillages of descaling agent immediately.

You will need a container of approx. 1 litre capacity.

A plastic tube (with suction cup) is supplied with your oven so that you do not have to hold the container with the descaling agent underneath the water intake pipe.

We recommend using the descaling tablets supplied. They have been specially developed for Miele appliances for optimum cleaning results.

Useful tip: Miele descaling tablets are available to order from the Miele online shop or directly from Miele.

Other descaling agents, which contain other acids besides citric acid and/or other undesirable substances, such as chlorides, could cause damage.

Moreover, the descaling result required cannot be guaranteed if the descaling solution does not have the appropriate concentration.

- Fill the container with approx. 600 ml of cold tap water and thoroughly dissolve one descaling tablet in it.

Starting the descaling process

- Select Other .
- Select Descale.

Cleaning and care

If the functions and Automatic programmes that use moisture injection are already disabled, the descaling process can be started immediately by touching *OK*.

- Place the universal tray on the top shelf level to collect the descaling solution after it has been used. Confirm the message shown with *OK*.

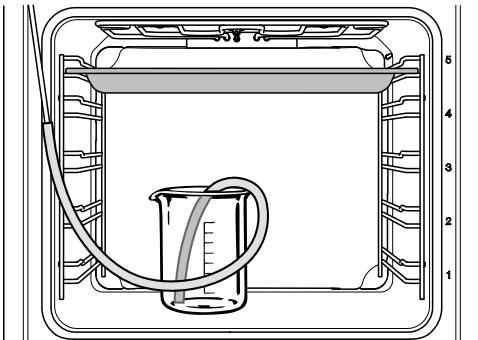

- Place the container with the descaling solution on the floor of the oven.
- Attach one end of the plastic tube to the water intake pipe. Place the other end of the plastic tube in the bottom of the descaling solution container and secure the plastic tube to the container with the suction cup.
- Confirm with *OK*.

The intake process will begin. You will hear the noise of the pump.

You can interrupt and resume the intake process at any time by selecting *OK*.

The amount of descaling solution specified can be more than the amount which is actually taken in. Some of the solution may therefore be left in the container at the end of descaling.

A message will appear in the display when the intake process is finished.

- Confirm with *OK*.

The **activation phase** will begin. You can follow the duration as it counts down in the display.

- Leave the container with the tube connected to the water intake pipe in the oven. Top the container up with approx. 300 ml of water, as the system will need to draw in more liquid during the activation phase.

The system will take in more liquid at approximately 5-minute intervals. You will hear the noise of the pump.

The oven lighting and the cooling fan will remain on during descaling.

A buzzer will sound at the end of the activation phase.

Rinsing the steam injection system after the activation phase

At the end of the activation phase the steam injection system will need to be rinsed out to remove all traces of descaling solution.

Cleaning is carried out by flushing approx. 1 litre of fresh tap water through the system three times. The water is collected in the universal tray.

- Take the universal tray with the collected descaling agent out of the oven and empty it. Place the tray back in the oven again on the top shelf level.
- Remove the plastic tube from the container.
- Remove the container, rinse it out thoroughly and fill it with approx. 1 litre of fresh tap water.
- Place the container back in the oven, insert the plastic tube, secure it to the container and close the door.
- Confirm with *OK*.

The intake process for the **first rinse** will start.

Water will be flushed through the steam injection system and will then collect in the universal tray.

Messages will appear in the display to prepare for the **second rinse**.

- Take the universal tray out of the oven and empty it. Place the tray back in the oven again on the top shelf level.
- Remove the plastic tube from the container. Fill it with approx. 1 litre of fresh tap water.
- Place the container back in the oven, insert the plastic tube and secure it to the container.
- Confirm with *OK*.
- Do the same for the **third rinse**.

Leave the universal tray (with the water which has collected in it from the third rinse) on the top oven shelf while the evaporation process takes place.

Evaporating residual moisture

After the third rinse residual moisture evaporation will begin.

- Remove the container and tube from the oven.
- Close the door.
- Confirm with *OK*.

 Danger of injury caused by steam.

Steam can cause severe scalding. Do not open the door while the residual moisture is being evaporated.

The oven heating will switch on and the duration of the evaporation process will count down in the display.

During the evaporation process, the duration may be adjusted by the system according to how much water is currently present.

Finalising the descaling process

At the end of the evaporation process a message will appear in the display with advice on cleaning after running the descaling programme.

- Confirm with *OK*.

A buzzer sounds and *Finished* appears.

- Switch the oven off with the On/Off  sensor.

 Risk of injury caused by hot surfaces.

The oven gets hot during operation. You could burn yourself on the heating elements, the oven compartment, or accessories.

Allow the heating elements, oven compartment and the accessories to cool before manual cleaning.

- Remove the universal tray with the collected liquid and empty it.
- When the oven compartment has cooled down, clean away any condensation and descaling agent residues.
- Leave the oven door open until the oven interior is completely dry.

Cleaning and care

Removing the door

The door weighs approx. 10 kg.

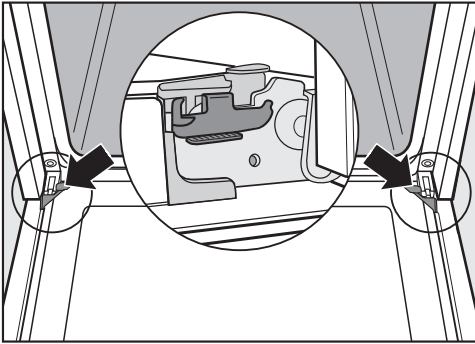

The oven door is connected to the hinges by retainers. Before removing the door from the retainers, the locking clamps on both hinges have to be released.

- Open the door fully.

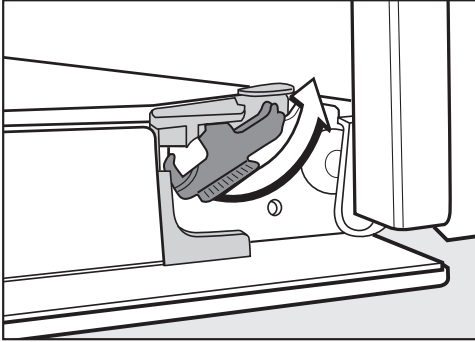

- Release the locking clamps by turning them as far as they will go.

The oven could be damaged if you remove the door incorrectly. Do not pull the door horizontally off its retainers, as they will spring back against the oven.

- Raise the door up till it rests partially open.



- Hold the door on either side and pull it diagonally upwards from the hinge guides. Make sure that the door is straight.

Dismantling the door

The oven door is an open system with 4 glass panes which have a heat-reflective coating on some of their surfaces.

When the oven is operating, air is directed through the door to keep the outer pane cool.

If soiling has worked its way in between the glass panes, the door can be dismantled in order to clean in between the panes.

Scratches on the door glass can cause the glass to break.

Do not use abrasive cleaners, hard sponges, brushes or sharp metal tools to clean the door glass.

When cleaning the door glass, you must also follow the instructions that apply to the oven front.

The different sides of the door glass have different coatings. The sides facing the oven compartment have heat-reflecting properties.

The oven will be damaged if you fit the door glass the wrong way round. Make sure that you place the door glass back in the right position after cleaning.

Oven cleaners will damage the surface of the aluminium profiles.

Only clean these parts with warm water and washing-up liquid applied with a clean sponge, or with a clean, damp microfibre cloth.

The door glass panes can break if dropped.

Keep the disassembled door glass in a safe place.

 Risk of injury caused by the door slamming shut.

The door may slam shut if you attempt to disassemble it when it is fitted to the oven.

Always remove the door before disassembling it.

- Place the door with the outer glass pane on a soft surface (e.g. a tea towel) to prevent it getting scratched.

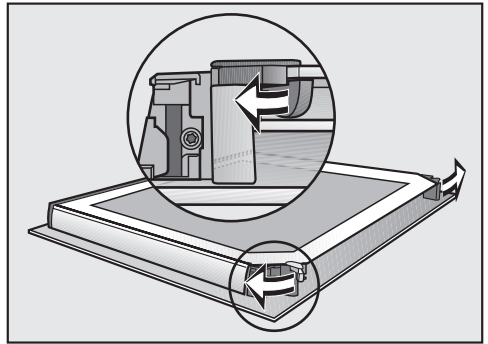

- Flip the two glass pane retainers outwards to open them.

You can now remove the inner pane and the two middle panes one after the other.

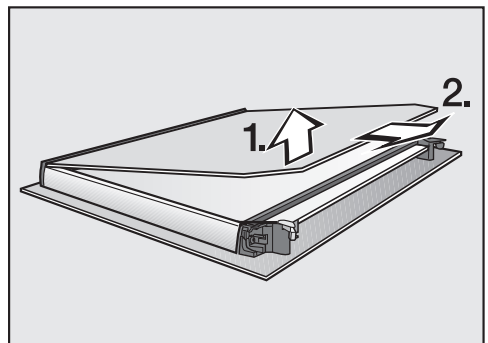

- Gently lift the inner pane up and out of the plastic strip.

Cleaning and care

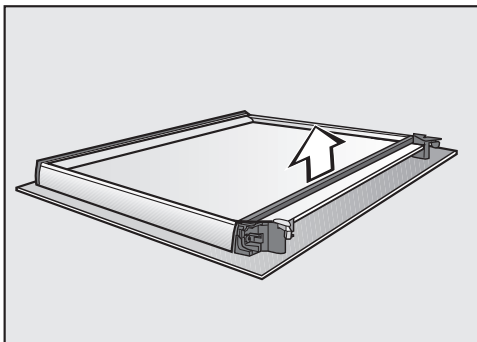

- Remove the seal.

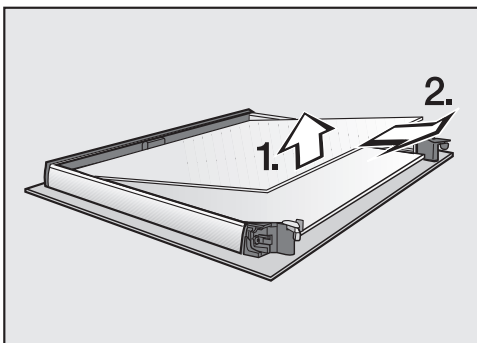

- Gently lift the top of the two middle panes up and take it out.

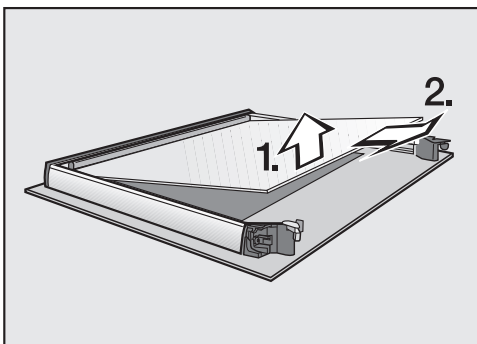

- Then lift the bottom of the two middle panes up carefully and take it out.

- Clean the door panes and other individual parts with a clean sponge and a solution of hot water and washing-up liquid or a clean, damp microfibre cloth.
- Dry all parts with a soft cloth.

Then reassemble the door carefully.

The two middle panes are identical. To help you put them back in correctly, the material number is printed on the panes.

- Refit the lower of the two middle panes in such a way that the material number is legible (i.e. not reversed).

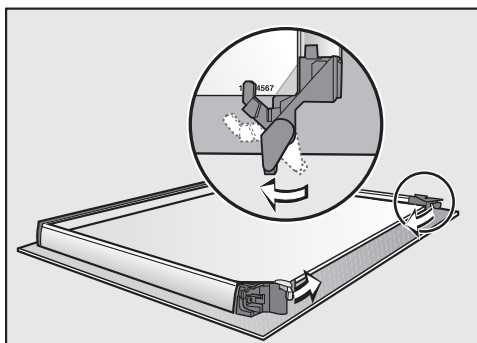

- Flip the glass pane retainers inwards in such a way that they fit over the lower of the two middle panes.
- Refit the upper of the two middle panes in such a way that the material number is legible (i.e. not reversed). The pane must rest on the retainers.

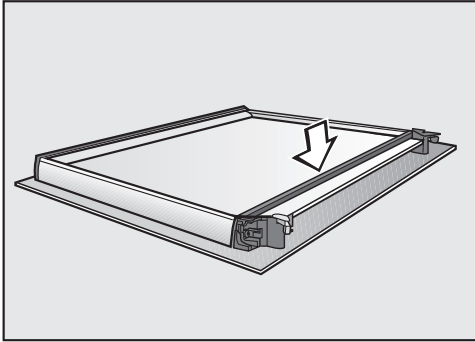

- Refit the seal.

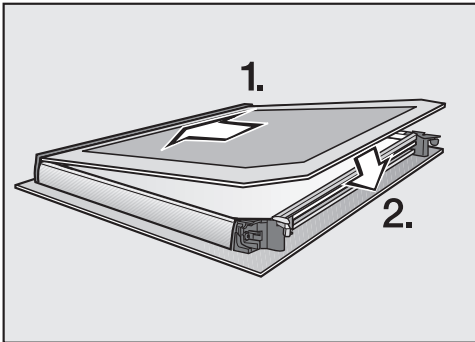

- Push the inner pane with the matt printed side facing downwards into the plastic strip and place it between the retainers.

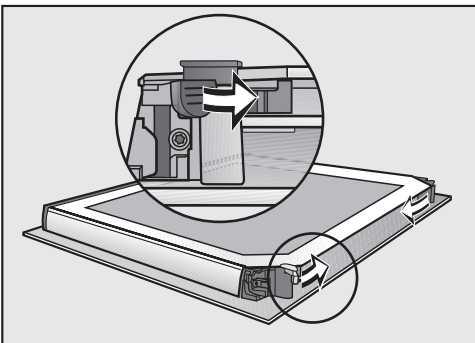

- Flip both the glass pane retainers inwards to close them.

The door is now reassembled.

Fitting the door

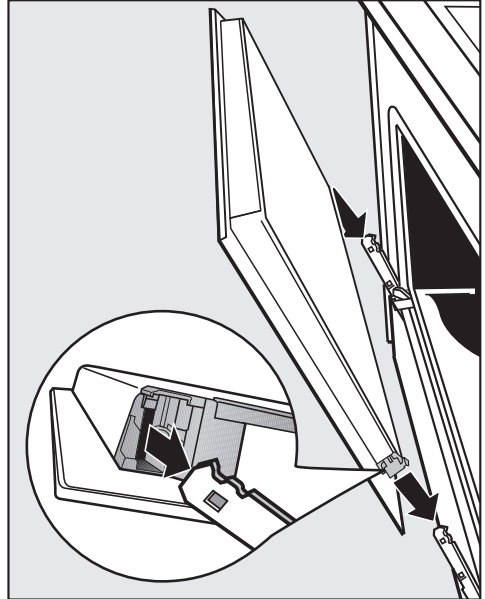

- Hold the door securely on both sides and carefully fit it back onto the hinge retainers. Make sure that the door goes back on straight.
- Open the door fully.

If the locking clamps are not locked, the door could work loose resulting in damage. Ensure that the locking clamps are locked after refitting the door.

Cleaning and care

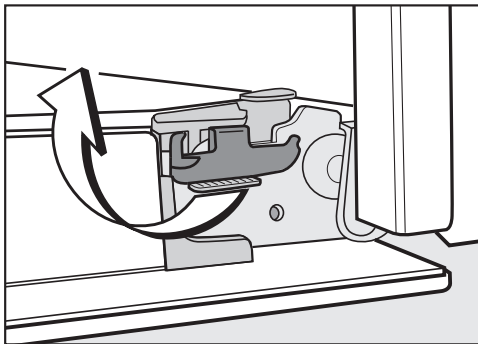

- To relock the locking clamps, flip them back up into a horizontal position as far as they will go.

Removing the shelf runners with FlexiClip telescopic runners

You can remove the shelf runners together with the FlexiClip telescopic runners (if present).

If you wish to remove the FlexiClip telescopic runners separately beforehand, please follow the instructions in “Features – Fitting and removing the FlexiClip telescopic runners”.

 Risk of injury caused by hot surfaces.

The oven gets hot during operation. You could burn yourself on the heating elements, the oven compartment, or accessories. Allow the heating elements, oven compartment and the accessories to cool before removing the shelf runners.

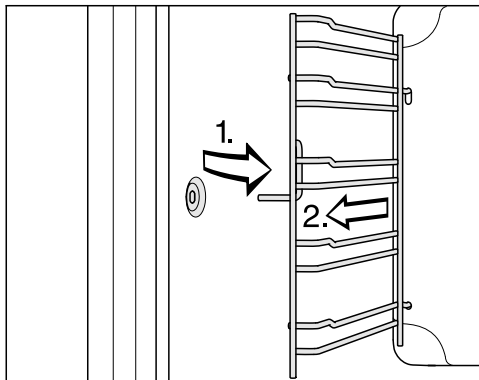

- Pull the shelf runners out of the holder (1) at the front of the oven and then pull them out of the oven (2).

Refit in the reverse order.

- Ensure that all parts are correctly fitted.

Lowering the top heat/grill element

If the oven compartment roof is badly soiled, the top heat/grill element can be lowered to make cleaning easier. Clean the oven compartment roof regularly with a damp cloth or a dishwashing sponge.

⚠ Risk of injury caused by hot surfaces.

The oven gets hot during operation. You could burn yourself on the heating elements, the oven compartment, or accessories.

Allow the heating elements, oven compartment and the accessories to cool before manual cleaning.

The enamel on the oven floor can be damaged by fastening nuts being dropped on it.

Place a cloth or similar item over the oven compartment floor to protect it.

- Remove the shelf runners.

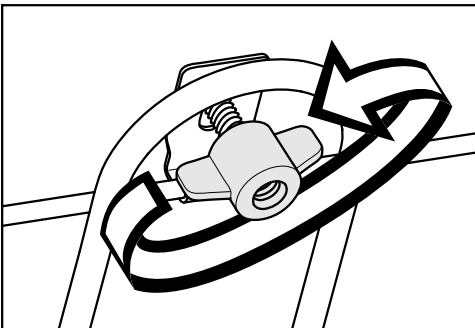

- Unscrew the wing nut.

Use caution not to damage the top heat/grill element.

Do not use force to lower the top heat/grill element as this can cause it to break.

- Carefully lower the top heat/grill element.

You can now access the ceiling of the oven compartment.

- Clean the ceiling of the oven compartment with a clean sponge and a solution of hot water and washing-up liquid or a clean, damp microfibre cloth.
- After cleaning, raise the top heat/grill element gently back up again.
- Replace the wing nut and tighten it securely.
- Refit the shelf runners.

Problem solving guide



Many malfunctions and minor faults that can occur in daily operation can be corrected without contacting Miele. This will save you time and money because you will not need a service call.

You can find information on how to remedy faults yourself at www.miele.com.au/service or www.miele.co.nz/service and on the Miele website.





Please note, however, that a call-out charge will be applied to unnecessary service visits where the problem could have been rectified as described in these operating instructions.

Problem	Possible cause and remedy
The display is dark.	You have selected the Time Show Off setting. When the oven is switched off, the display is dark. ■ As soon as the oven is switched on, the main menu will appear. If you want the time of day to be displayed constantly, select the Time Show On setting.
	There is no power to the oven. ■ Check that the oven plug is correctly inserted into the socket and switched on. ■ Check if the circuit breaker has tripped. Contact a qualified electrician or Miele.
The signal tone does not sound.	The buzzers are deactivated or set at too low a volume. ■ Switch on the buzzers or increase the volume with the Volume Buzzer tones setting.
The oven does not heat up.	Demo mode is active. You can select menu options in the display and the sensors, but the oven heating does not work. ■ Deactivate Demo mode with the Showroom programme Demo mode Off setting.

Problem solving guide

Problem	Possible cause and remedy
<p>You cannot open the door with the  sensor.</p>	<p>You have selected the Display QuickTouch Off setting. The  sensor does not respond when the oven is switched off.</p> <ul style="list-style-type: none"> ■ As soon as the oven is switched on, the sensors will respond. If you want the sensors to respond even when the oven is switched off, select the Display QuickTouch On setting.
	<p>The oven is not connected to the electricity supply.</p> <ul style="list-style-type: none"> ■ Make sure that the plug is correctly inserted in the socket and that the socket is switched on. ■ Check if the circuit breaker has tripped. Contact a qualified electrician or Miele. ■ If you need to open the door, for instance because there is still food in the oven compartment, use the opener supplied to prise the door open. To do so, push the opener at an angle into the gap on the outside edge of the door at the top between the control panel and the door. You can also pull the door open by grasping the sides of the door with both hands and pulling carefully until it opens.
	<p>The pyrolytic cleaning programme has started.</p> <div data-bbox="404 874 1042 1098" style="border: 1px solid gray; padding: 10px;"> <p> Risk of injury caused by hot surfaces. During pyrolytic cleaning, the door will remain locked until the temperature inside the oven compartment has dropped to below 280 °C. Do not attempt to prise open the door with the opener as described above!</p> </div> <ul style="list-style-type: none"> ■ Wait until the oven has cooled down. The door will unlock itself automatically as soon as the temperature inside the oven has dropped below 280 °C.



Problem solving guide

Problem	Possible cause and remedy
<p>The sensors do not respond.</p>	<p>You have selected the Display QuickTouch Off setting. When the oven is switched off, the sensors do not respond.</p> <ul style="list-style-type: none"> ■ As soon as the oven is switched on, the sensors will respond. If you want the sensors to respond even when the oven is switched off, select the Display QuickTouch On setting. <p>The oven is not connected to the electricity supply.</p> <ul style="list-style-type: none"> ■ Make sure that the plug is correctly inserted in the socket and that the socket is switched on. ■ Check if the circuit breaker has tripped. Contact a qualified electrician or Miele. <p>There is a fault with the control unit.</p> <ul style="list-style-type: none"> ■ Touch and hold the On/Off  sensor until the display switches off and the oven restarts.
<p>Press OK for 6 seconds to unlock appears in the display when the oven is switched on.</p>	<p>The system lock  has been switched on.</p> <ul style="list-style-type: none"> ■ You can deactivate the system lock for a programme by touching the OK sensor for at least 6 seconds. ■ If you want to permanently deactivate the system lock, select the Safety System lock  Off setting.
<p>Power cut -process cancelled appears in the display.</p>	<p>There has been a brief power cut. This has caused the current cooking programme to stop.</p> <ul style="list-style-type: none"> ■ Switch the oven off and then back on again. ■ Restart the cooking programme.
<p>12:00 appears in the display.</p>	<p>The power supply was interrupted for longer than 150 hours.</p> <ul style="list-style-type: none"> ■ Reset the time and date.
<p>Maximum operating hours reached appears in the display.</p>	<p>The oven has been operating for an unusually long time. This has triggered the safety switch-off function.</p> <ul style="list-style-type: none"> ■ Confirm with OK. <p>The oven is now ready to use.</p>
<p> Fault F32 appears in the display.</p>	<p>The door lock for pyrolytic cleaning has not locked.</p> <ul style="list-style-type: none"> ■ Switch the oven off and then back on again. Start the pyrolytic cleaning programme again. ■ If the message appears again, contact Miele.

Problem solving guide

Problem	Possible cause and remedy
⚠ Fault F33 appears in the display.	The door lock for pyrolytic cleaning does not open. <ul style="list-style-type: none"> ■ Switch the oven off and then back on again. ■ If the door lock still does not unlock itself, contact Miele.
Fault and a fault code not listed here appears in the display.	A fault has occurred that you cannot resolve. <ul style="list-style-type: none"> ■ Call Miele.
This function is not available at the moment appears in the display after selecting the Descale function.	The steam injection system is faulty. <ul style="list-style-type: none"> ■ Call Miele.
Programmes using moisture injection will not take in water.	Demo mode is active. You can select menu options in the display and the sensors, but the steam injection system pump will not work. <ul style="list-style-type: none"> ■ Deactivate demo mode by selecting Settings Showroom programme Demo mode Off.
	The pump for the steam injection system is faulty. <ul style="list-style-type: none"> ■ Call Miele.
A noise can be heard after a cooking process.	The cooling fan remains switched on after a cooking programme (see “Settings – Cooling fan run-on”).
The oven has switched itself off.	The oven will switch itself off automatically to save energy if no other action is taken within a certain time frame after switching it on or after the end of a cooking programme. <ul style="list-style-type: none"> ■ Switch the oven back on.
Cakes and biscuits are not cooked properly after the duration given in the cooking chart.	A different temperature from the one given in the recipe has been used. <ul style="list-style-type: none"> ■ Select the temperature required for the recipe.
	The ingredient quantities used are different from those given in the recipe. <ul style="list-style-type: none"> ■ Check whether you have amended the recipe. The addition of more liquid or more eggs makes a moister mix which would take longer to cook.

Problem solving guide

Problem	Possible cause and remedy
The browning of baked goods is uneven.	<p>The wrong temperature or shelf level was selected.</p> <ul style="list-style-type: none"> ■ There will always be a slight unevenness in browning. If browning is very uneven, check whether the correct temperature and shelf level were selected.
	<p>The material or colour of the baking tin is not suitable for the oven function.</p> <ul style="list-style-type: none"> ■ When using the Conventional Heat  function, light coloured, shiny tins are not as suitable. Dark, matt tins are best for baking.
There is still soiling in the oven compartment after a pyrolytic cleaning programme.	<p>The pyrolytic cleaning programme burns off soiling in the oven and leaves it as ash.</p> <ul style="list-style-type: none"> ■ Remove the ash using a damp microfibre cloth or a clean sponge and a solution of hot water and washing-up liquid. <p>If there is still coarse soiling left in the oven after the pyrolytic cleaning programme, you should start the programme again, selecting a higher level if necessary.</p>
The accessories make noises when being pushed into or pulled out of the oven.	<p>The pyrolytic resistant surface of the shelf runners creates friction when accessories are being pushed into or pulled out of the oven.</p> <ul style="list-style-type: none"> ■ To reduce the friction, add a few drops of heat-resistant cooking oil to some paper towels and use this to lubricate the shelf runners. Repeat this after every pyrolytic cleaning programme.
The oven lighting switches off after a short time.	<p>You have selected the Lighting "On" for 15 seconds setting.</p> <ul style="list-style-type: none"> ■ If you want the oven lighting to remain switched on during the entire cooking programme, select the Lighting On setting.
The oven lighting is off or does not switch on.	<p>You have selected the Lighting Off setting.</p> <ul style="list-style-type: none"> ■ Select the  sensor control to switch on the oven interior lighting for 15 seconds. ■ If required, select the Lighting On or "On" for 15 seconds setting.
	<p>The oven interior lighting is faulty.</p> <ul style="list-style-type: none"> ■ Call Miele.

You can find information on how to remedy faults yourself and about Miele spare parts at www.miele.com.au/service or www.miele.co.nz/service.

Contact in case of fault

In the event of any faults which you cannot remedy yourself, please contact Miele.

You can book a Miele customer service call-out online at www.miele.com.au/service or www.miele.co.nz/service.

Contact information for Miele can be found at the end of this booklet.

Please quote the model and serial number of your appliance when contacting Miele. This information can be found on the data plate.

This information is given on the data plate, visible on the front frame of the oven, with the door fully open.

Warranty

The manufacturer's warranty for this appliance is 2 years.

For further information, please refer to your warranty booklet.

Installation

Building-in dimensions

Dimensions are given in mm.

Installation in a tall or base unit

When building the oven into a base unit underneath a cooktop, please also observe the installation instructions for the cooktop as well as the building-in height required for the cooktop.

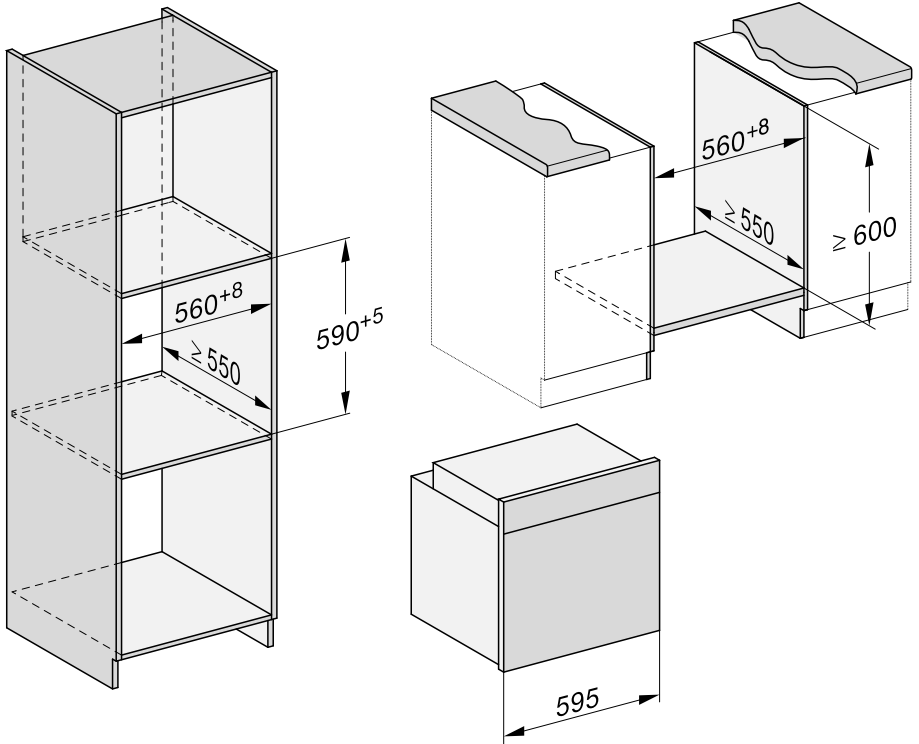

Side view

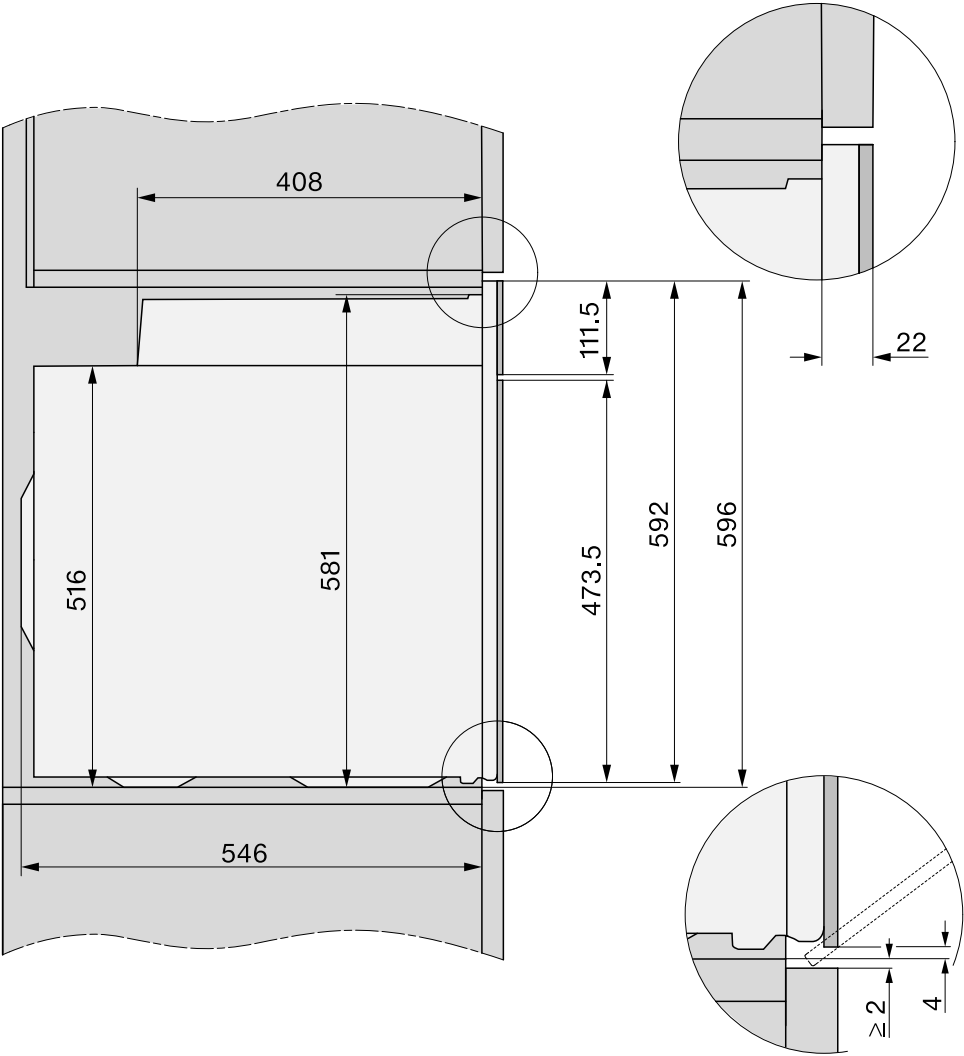

Installation

Connections and ventilation

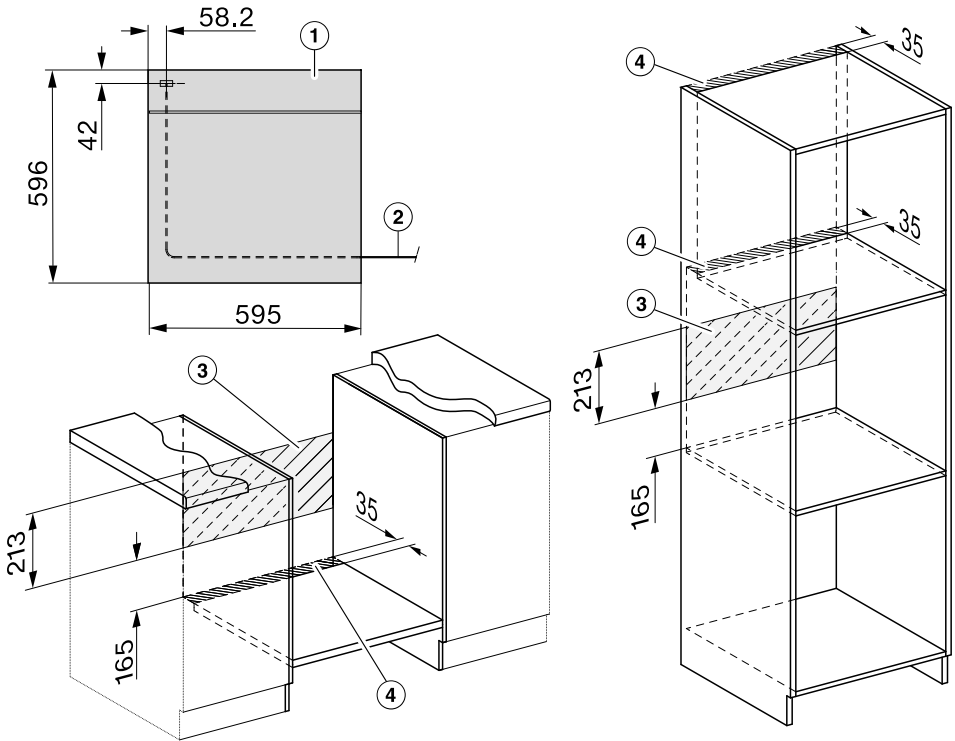

- ① Front view
- ② Mains connection cable, length = 1,500 mm
- ③ No connections permitted in this area
- ④ Ventilation cut-out, min. 150 cm²

Installing the oven

For safety reasons, the oven may only be used after it has been fully installed.

The oven requires a sufficient supply of cool air for efficient operation. The required supply of cool air must not be excessively heated by other heat sources (e.g. solid fuel stoves).

The following must be observed when installing the appliance:
Make sure that the shelf that the oven sits on does not touch the wall.
Do not fit heat insulation strips to the side walls of the housing unit.

- Connect the mains cable from the oven to the electricity supply.

Use the handle cut-outs on the side of the housing to lift the appliance. It is a good idea to remove the door and the accessories before installing the appliance. This makes the oven lighter when you push it into the housing unit.

- To remove the door, use the opener supplied to prise the door open at the top in the middle. You can also pull the door open by grasping the sides of the door with both hands and pulling carefully until it opens.
- Remove the door (see "Cleaning and care - Removing the door") and take the accessories out of the oven.
- Push the oven into the housing unit and align it.
- Reconnect the power supply to the mains socket.
- Touch the  sensor control to open the door if you have not removed it already.

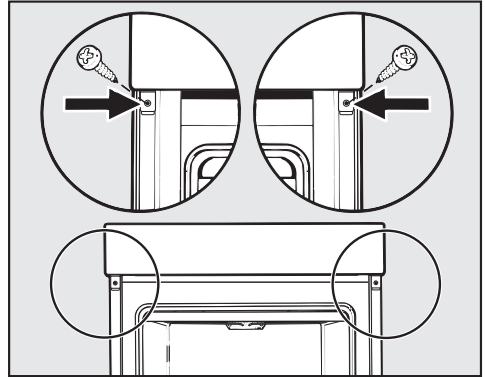

- Use the screws supplied to secure the oven to the side walls of the housing unit through the holes in the oven trim.
- Refit the door, if necessary (see "Cleaning and care - Fitting the door").

Installation

Electrical connection



Danger of injury!
Miele cannot be held liable for unauthorised installation, maintenance and repair work as this can be dangerous to users.

Connection to the electrical mains may only be carried out by a qualified electrician in accordance with national and local regulations and the additional regulations of the local electrical supply companies.

Connection of this appliance must comply with national and local safety regulations.

Connection to a switched socket is recommended as this provides easier access in the case of a service call.

If the appliance is **hardwired** or if the switch is not accessible after installation, an additional means of disconnection must be provided for all poles.

Suitable means of disconnection include switches with an all-pole contact gap of at least 3 mm. These include isolator switches, fuses and relays in accordance with the wiring rules AS/NZS 3000.

Voltage, rated load and fuse rating are given on the data plate situated at the front of the oven compartment. Please ensure the connection data matches the household supply.

When contacting Miele, please quote the following:

- Model number
- Serial number
- Connection data (voltage/frequency/maximum rated load)

If the mains connection cable is damaged, it must be replaced by a suitably qualified electrician with a specialist connection cable of type H 05 VV-F, available from Miele, in order to avoid a hazard.

Temporary or permanent operation with a self-sufficient or non-mains synchronous energy supply system (e.g. isolated networks, back-up systems) is possible. A requirement for the operation is that the energy supply system complies with all current local and national requirements that apply to stand-alone, solar and/or battery systems.

The protective measures provided in the domestic installation and in this Miele product must also be assured in their function and operation in isolated operation or in non-mains synchronous operation, or replaced with equivalent measures in the installation.























Oven







Ovens are supplied with a 3-core cable for connection to a 230 V, 50 Hz alternating current supply.

Fuse rating is 16 A.

Maximum rated load: see data plate.

Creamed mixture

Cakes/Biscuits (accessories)		 [°C]		 ⁵ / ₁	 [min.]	CF
Muffins (1 tray)		150–160	–	2	25–35	–
Muffins (2 trays)		150–160	–	1+3	30–40 ³	–
Small cakes (1 tray)		150	–	2	30–40	–
		160 ²	–	3	20–30	–
Small cakes (2 trays)		150 ²	–	1+3	25–35	–
Sand cake (rack, loaf tin, 30 cm) ¹		150–160	–	2	60–70	–
		155–165 ²	–	2	60–70	✓
Marble, nut cake (rack, loaf tin, 30 cm) ¹		150–160	–	2	60–70	–
		150–160	–	2	60–70	–
Marble, nut cake (rack, ring tin/Bundt cake tin, Ø 26 cm) ¹		150–160	✓	2	55–65	–
		150–160	✓	2	60–70	–
Fresh fruit cake (1 tray)		150–160	–	2	40–50	✓
		155–165	–	1	40–50	✓
Fresh fruit cake (rack, springform cake tin, Ø 26 cm) ¹		150–160	✓	2	55–65	✓
		165–175 ²	–	2	50–60	✓
Flan base (rack, flan base tin, Ø 28 cm) ¹		150–160	–	2	25–35	–
		170–180 ²	–	2	15–25	–

 Operating mode,  Temperature,  Booster,  ⁵/₁ Shelf level,  Cooking duration, CF Crisp function,  Fan Plus,  Conventional Heat, ✓ On, – Off



























¹ Use a dark coloured, matt baking tin and place it centrally on the rack.









² Pre-heat the oven before placing the food inside.

³ Take the baking trays out of the oven early if the food has already browned sufficiently before the specified cooking time has elapsed.

Cooking charts

Rubbed in mixture

Cakes/Biscuits (accessories)		 [°C]		 5 1	 [min.]	CF
Cookies (1 tray)		140–150	–	2	25–35	–
		150–160	–	2	25–35	–
Cookies (2 trays)		140–150	–	1+3	25–35 ³	–
Drop cookies (1 tray)		140	–	2	35–45	–
		160 ²	–	3	25–35	–
Drop cookies (2 trays)		140	–	1+3	40–50 ³	–
Flan base (rack, flan base tin, Ø 28 cm) ¹		150–160	✓	2	35–45	–
		170–180 ²	✓	2	20–30	–
Cheesecake (rack, springform cake tin, Ø 26 cm) ¹		170–180	–	2	80–90	–
		160–170	–	2	80–90	–
Apple pie (rack, springform cake tin, Ø 20 cm)		160	–	2	90–100	–
		180	–	1	85–95	–
Apple pie (rack, springform cake tin, Ø 26 cm) ¹		180–190 ²	–	2	60–70	✓
		160–170	–	2	60–70	✓
Fresh fruit cake, glazed (rack, springform cake tin, Ø 26 cm) ¹		170–180	–	2	60–70	–
		150–160	–	2	55–65	–
Fresh fruit cake, glazed (1 tray)		170–180	–	2	50–60	✓
		160–170	–	2	45–55	✓
Fruit flan (1 tray)		210–220 ²	✓	1	45–55	✓
		190–200	–	2	40–50	✓
Scones (2 x aluminium tray on rack, 4 x 4 pieces on each tray)		180–190 ²	–	1+3	17–20 ³	–























 Operating mode,  Temperature,  Booster,  Shelf level,  Cooking duration, CF Crisp function,  Fan Plus,  Eco Fan Heat,  Conventional Heat,  Intensive Bake, ✓ On, – Off









¹ Use a dark coloured, matt baking tin and place it centrally on the rack.

² Pre-heat the oven before placing the food inside.

³ Take the baking trays out of the oven early if the food has already browned sufficiently before the specified cooking time has elapsed.

Yeast dough









Cakes/Biscuits (accessories)		 [°C]		 ⁵ / ₁	 [min.]	CF
Bundt cake (rack, Bundt cake tin, Ø 24 cm) ¹		150–160	–	2	50–60	–
		160–170	–	2	50–60	–
Stollen (1 tray)		150–160	–	2	55–65	–
		160–170	✓	2	55–65	–
Streusel cake with/without fruit (1 tray)		160–170	–	2	35–45	✓
		170–180	–	3	45–55	✓
Fresh fruit cake (1 tray)		160–170	✓	2	45–55	✓
		170–180	✓	3	45–55	✓
Apple turnovers/raisin scrolls (1 tray)		160–170	✓	2	25–35	–
Apple turnovers/raisin scrolls (2 trays)		160–170	✓	1+3	30–40 ⁴	–
White bread, free form (1 tray)		190–200	✓	2	30–40 ⁵	–
		190–200	–	2	30–40	–
White bread (rack, loaf tin, 30 cm) ¹		180–190	✓	2	45–55	–
		190–200 ²	✓	2	55–65 ⁶	✓ ⁷
Wholegrain bread (rack, loaf tin, 30 cm) ¹		180–190	✓	2	55–65	–
		200–210 ²	✓	2	55–65 ⁶	✓ ⁷
Prove yeast dough (rack)		30–35	–	– ³	–	–







 Operating mode,  Temperature,  Booster,  ⁵/₁ Shelf level,  Cooking duration, CF Crisp function,  Fan Plus,  Conventional Heat,  Moisture Plus + Fan Plus,  Moisture Plus + Conv. Heat, ✓ On, – Off

- ¹ Use a dark coloured, matt baking tin and place it centrally on the rack.
- ² Pre-heat the oven before placing the food inside.
- ³ Place the rack on the floor of the oven, and stand the bowl with the dough on the rack. Depending on the size of the dish, you may need to remove the shelf runners.
- ⁴ Take the baking trays out of the oven early if the food has already browned sufficiently before the specified cooking time has elapsed.
- ⁵ Release 1 burst of steam at the beginning of the cooking programme.
- ⁶ Release 2 bursts of steam at the beginning of the cooking programme.
- ⁷ Switch on the Crisp function 15 minutes into the cooking process.

Cooking charts











Quark dough







Cakes/Biscuits (accessories)		 [°C]		 5 1	 [min.]	CF
Fresh fruit cake (1 tray)		160–170	✓	2	45–55	✓
		170–180	✓	3	45–55	✓
Apple turnovers/raisin scrolls (1 tray)		160–170	–	3	25–35	✓
Apple turnovers/raisin scrolls (2 trays)		150–160	✓	1+3	25–35 ¹	✓

 Operating mode,  Temperature,  Booster,  Shelf level,  Cooking duration, CF Crisp function,  Fan Plus,  Conventional Heat, ✓ On, – Off

¹ Take the baking trays out of the oven early if the food has already browned sufficiently before the specified cooking time has elapsed.

Sponge mixture













Cakes/Biscuits (accessories)		 [°C]		 5 1	 [min.]	CF
Sponge cake base (2 eggs) (rack, springform cake tin, Ø 26 cm) ¹		160–170 ²	–	2	15–25	–
Sponge cake base (4–6 eggs) (rack, springform cake tin, Ø 26 cm) ¹		150–160 ²	–	2	30–40	–
Whisked sponge (rack, springform cake tin, Ø 26 cm) ¹		180	–	2	25–35	–
		150–170 ²	–	2	25–45	–
Sponge cake base (1 tray)		180–190 ²	✓	1	15–25	–







 Operating mode,  Temperature,  Booster,  Shelf level,  Cooking duration, CF Crisp function,  Conventional Heat,  Fan Plus, ✓ On, – Off

¹ Use a dark coloured, matt baking tin and place it centrally on the rack.

² Pre-heat the oven before placing the food inside.

Choux pastry, puff pastry, meringue





















Cakes/Biscuits (accessories)		 [°C]		 5 1	 [min.]	CF
Choux buns (1 tray)		160–170	–	2	30–40	✓
		160–170	–	2	25–35 ¹	✓ ²
Pastry puffs (1 tray)		180–190	–	2	20–30	–
Pastry puffs (2 trays)		180–190	–	1+3	20–30 ³	–
Macaroons (1 tray)		120–130	–	2	25–50	✓
Macaroons (2 trays)		120–130	–	1+3	25–50 ³	✓
Meringues/pavlovas (1 tray of 6, each Ø 6 cm)		80–100	–	2	120–150	✓
Meringues/pavlovas (2 trays of 6, each Ø 6 cm)		80–100	–	1+3	150–180	✓











 Operating mode,  Temperature,  Booster,  Shelf level,  Cooking duration, CF Crisp function,  Fan Plus,  Moisture Plus + Fan Plus, ✓ On, – Off

- ¹ Release 1 burst of steam 8 minutes into the cooking programme.
- ² Switch on the Crisp function 15 minutes into the cooking process.
- ³ Take the baking trays out of the oven early if the food has already browned sufficiently before the specified cooking time has elapsed.

Cooking charts

Savoury snacks

Food (accessories)		 [°C]		 5 1	 [min.]	CF
Savoury flan (1 tray)		220–230 ¹	✓	1	30–40	✓
		180–190	–	1	45–55	✓
Onion tart (1 tray)		180–190 ¹	✓	2	25–35	✓
		170–180	–	2	30–40	✓
Pizza, yeast dough (1 tray)		170–180	✓	2	25–35	✓
		210–220 ¹	–	2	20–30	✓
Pizza, yeast dough (1 aluminium Pizza dish Ø 35 cm on rack)		200 ¹	–	1	13–16	–
Pizza, quark dough (1 tray)		170–180	✓	2	25–35	✓
		190–200 ¹	✓	3	25–35	✓
Frozen pizza, pre-cooked (rack)		200–210	–	2	20–25	–
Toast (rack)		300	–	3	5–8	–
Baked dishes/gratins (e.g. toast) (rack on universal tray)		275 ²	–	3	3–6	–
Grilled vegetables (rack on universal tray)		275 ²	–	4	5–10 ³	✓
		250 ²	–	3	5–10 ³	✓
Ratatouille (1 universal tray)		180–190	–	2	40–60	–



















 Operating mode,  Temperature,  Booster,  Shelf level,  Cooking duration, CF Crisp function,  Conventional Heat,  Intensive Bake,  Fan Plus,  Eco Fan Heat,  Full Grill,  Fan Grill, ✓ On, – Off











¹ Pre-heat the oven before placing the food inside.

² Pre-heat the oven for 5 minutes before placing the food inside.

³ Turn the food halfway through cooking.

Beef

Food (accessories)		 [°C]		 ⁵	 [min.]	 [°C]
Braised beef, approx. 1 kg (oven dish with lid)	 ²	150–160 ³	✓	2	120–130 ⁶	–
	 ²	170–180 ³	✓	2	120–130 ⁶	–
	 ²	180–190	–	2	160–180 ⁷	–
Fillet of beef, approx. 1 kg (universal tray)	 ²	180–190 ³	✓	2	25–60	53–75
Fillet of beef, "rare", approx. 1 kg ¹	 ²	80–85 ⁴	–	2	70–80	53–55
Fillet of beef, "medium", approx. 1 kg ¹	 ²	90–95 ⁴	–	2	80–90	60–65
Fillet of beef, "well-done", approx. 1 kg ¹	 ²	95–100 ⁴	–	2	110–130	70–75
Sirloin joint, approx. 1 kg (universal tray)	 ²	180–190 ³	✓	2	35–65	53–75
Sirloin joint, "rare", approx. 1 kg ¹	 ²	80–85 ⁴	–	2	80–90	53–55
Sirloin joint, "medium", approx. 1 kg ¹	 ²	90–95 ⁴	–	2	110–120	60–65
Sirloin joint, "well-done", approx. 1 kg ¹	 ²	95–100 ⁴	–	2	130–140	70–75
Burgers, rissoles ¹		300 ⁵	–	4	15–25 ⁸	–

 Function,
  Temperature,
  Booster,
  ⁵ Shelf level,
  Cooking duration,
  Core temperature,
  Auto Roast,
  Conventional Heat,
  Eco Fan Heat,
  Full Grill,
 ✓ On, – Off

* The settings also apply for testing in accordance with EN 60350-1.

¹ Use the rack and the universal tray.

² Sear the meat on the cooktop first.

³ Pre-heat the oven before placing the food inside.

⁴ Pre-heat the oven at 120 °C for 15 minutes. Reduce the temperature when you place the food in the oven.

⁵ Pre-heat the oven for 5 minutes before placing the food inside.















⁶ Roast with the lid on first. Remove the lid after roasting for 90 minutes and add approx. 0.5 litre of liquid.

⁷ Roast with the lid on first. Remove the lid after roasting for 100 minutes and add approx. 0.5 litre of liquid.

⁸ Turn the food halfway through cooking.

Cooking charts

Veal

Food (accessories)		 [°C]		 5 1	 [min.]	 [°C]
Braised veal, approx. 1.5 kg (roasting dish with lid)	 ²	160–170 ³	✓	2	120–130 ⁵	–
	 ²	170–180 ³	✓	2	120–130 ⁵	–
Fillet of veal, approx. 1 kg (universal tray)	 ²	160–170 ³	✓	2	30–60	45–75
Fillet of veal, “rare”, approx. 1 kg ¹	 ²	80–85 ⁴	–	2	50–60	45–48
Fillet of veal, “medium”, approx. 1 kg ¹	 ²	90–95 ⁴	–	2	80–90	54–57
Fillet of veal, “well-done”, approx. 1 kg ¹	 ²	95–100 ⁴	–	2	90–100	63–66
Saddle of veal, “rare”, approx. 1 kg ¹	 ²	80–85 ⁴	–	2	80–90	45–48
Saddle of veal, “medium”, approx. 1 kg ¹	 ²	90–95 ⁴	–	2	100–130	54–57
Saddle of veal, “well-done”, approx. 1 kg ¹	 ²	95–100 ⁴	–	2	130–140	63–66

 Function,  Temperature,  Booster,  Shelf level,  Cooking duration,  Core temperature,  Auto Roast,  Conventional Heat, ✓ On, – Off

- ¹ Use the rack and the universal tray.
- ² Sear the meat on the cooktop first.
- ³ Pre-heat the oven before placing the food inside.
- ⁴ Pre-heat the oven at 120 °C for 15 minutes. Reduce the temperature when you place the food in the oven.
- ⁵ Roast with the lid on first. Remove the lid after roasting for 90 minutes and add approx. 0.5 litre of liquid.

Pork













Food (accessories)		[°C]		⁵ ₁	[min.]	[°C]
Pork joint/pork neck roast, approx. 1 kg (oven dish with lid)		160–170	✓	2	130–140 ⁶	80–90
		170–180	✓	2	130–140 ⁶	80–90
Pork joint with crackling, approx. 2 kg (oven dish)		180–190	✓	2	130–150 ^{7,8,9}	80–90
		190–200	✓	2	130–150 ^{8,9}	80–90
Fillet of pork, approx. 350 g ¹	²	90–100 ⁴	–	2	70–90	63–69
Ham roast, approx. 1.5 kg (oven dish with lid)		160–170	–	2	130–160 ¹⁰	80–90
Gammon joint, approx. 1 kg (universal tray)		150–160	✓	2	50–60 ⁷	63–68
Gammon joint, approx. 1 kg ¹	²	95–105 ⁴	–	2	140–160	63–66
Meat loaf, approx. 1 kg (universal tray)		170–180	✓	2	60–70 ⁸	80–85
		190–200	✓	2	70–80 ⁸	80–85
Bacon ¹	³	300 ⁵	–	4	3–5	–
Sausage ¹	³	220 ⁵	–	3	8–15 ¹¹	–







Function, Temperature, Booster, ⁵₁ Shelf level, Cooking duration, Core temperature, Auto Roast, Conventional Heat, Moisture Plus + Fan Plus, Eco Fan Heat, Full Grill, ✓ On, – Off

- ¹ Use the rack and the universal tray.
- ² Sear the meat on the cooktop first.
- ³ Switch on the Crisp function.
- ⁴ Pre-heat the oven at 120 °C for 15 minutes. Reduce the temperature when you place the food in the oven.
- ⁵ Pre-heat the oven for 5 minutes before placing the food inside.
- ⁶ Roast with the lid on first. Remove the lid after roasting for 60 minutes and add approx. 0.5 litre of liquid.
- ⁷ After the heating-up phase, release a burst of steam 3 times manually throughout the cooking programme.
- ⁸ Add approx. 0.5 l of liquid halfway through roasting.
- ⁹ Switch on the Crisp function 60 minutes into the cooking process.
- ¹⁰ Roast with the lid on first. Remove the lid after roasting for 100 minutes and add approx. 0.5 litre of liquid.
- ¹¹ Turn the food halfway through cooking.

Cooking charts















Lamb, game











Food (accessories)		 [°C]		 5/1	 [min.]	 [°C]
Leg of lamb on the bone, approx. 1.5 kg (oven dish with lid)		170–180	–	2	100–120 ⁴	53–75
Saddle of lamb, off the bone (universal tray)	 ¹	180–190 ²	✓	2	10–20	53–75
Saddle of lamb, off the bone (rack and universal tray)	 ¹	95–105 ³	–	2	40–60	53–75
Saddle of venison, off the bone (universal tray)	 ¹	160–170 ²	–	2	70–90	54–57
Roebuck saddle, off the bone (universal tray)	 ¹	140–150 ²	–	2	25–35	60–81
Leg of wild boar, off the bone, approx. 1 kg (oven dish with lid)	 ¹	170–180	–	2	100–120 ⁴	80–90

 Function,  Temperature,  Booster,  Shelf level,  Cooking duration,  Core temperature,  Conventional Heat, ✓ On, – Off

- ¹ Sear the meat on the cooktop first.
- ² Pre-heat the oven before placing the food inside.
- ³ Pre-heat the oven at 120 °C for 15 minutes. Reduce the temperature when you place the food in the oven.
- ⁴ Roast with the lid on first. Remove the lid after roasting for 50 minutes and add approx. 0.5 litre of liquid.

Poultry, fish

Food (accessories)		 [°C]		 5 1	 [min.]	 [°C]
Poultry, 0.8–1.5 kg (universal tray)		170–180	✓	2	55–65	85–90
Chicken, approx. 1.2 kg (rack on universal tray)		180–190 ¹	–	2	60–70 ³	85–90
Poultry, approx. 2 kg (oven dish)		180–190	✓	2	100–120 ⁴	85–90
		190–200	✓	3	100–120 ⁴	85–90
Poultry, approx. 4 kg (oven dish)		160–170	✓	2	180–200 ⁵	90–95
		180–190	✓	2	180–200 ⁵	90–95
Fish, 200–300 g (e.g. trout) (universal tray)		210–220 ²	–	2	15–25 ⁶	75–80
Fish, 1–1.5 kg (e.g. Australian salmon) (universal tray)		210–220 ²	–	2	30–40 ⁶	75–80
Fish fillet in foil, 200–300 g (universal tray)		200–210	–	2	25–30	75–80

 Function,  Temperature,  Booster,  Shelf level,  Cooking duration,  Core temperature,  Auto Roast,  Fan Grill,  Conventional Heat,  Moisture Plus + Conv. Heat,  Eco Fan Heat, ✓ On, – Off

- ¹ Pre-heat the oven for 5 minutes before placing the food inside.
- ² Pre-heat the oven before placing the food inside.
- ³ Turn the food halfway through grilling.
- ⁴ Add approx. 0.25 litre of liquid at the start.
- ⁵ Add approx. 0.5 litre of liquid after 30 minutes.
- ⁶ Manually inject 1 burst of steam 5 minutes into the cooking programme.

Copyright and licences for the communication module

For the purpose of operating and controlling the communication module, Miele uses proprietary or third-party software that is not covered by open source licensing terms. These items of software/software components are protected by copyright. The copyright powers of Miele and third parties must be respected.

In addition, the communication module contains software components which are distributed under open source licensing terms. The open source components contained in the appliance along with the corresponding copyright notices, copies of the licensing terms valid at the time, and any further information can be accessed locally via IP using a web browser (*http://<IP address>/Licenses*), where <IP address> is the IP address of the appliance. The liability and warranty arrangements for the open source licences displayed in this location only apply in relation to the respective rights holders.

Miele Australia Pty. Ltd.

ACN 005 635 398

ABN 96 005 635 398

Level 4, 141 Camberwell Road
Hawthorn East, VIC 3123

1300 464 353 (1300 4 MIELE)

info@miele.com.au

www.miele.com.au

Miele New Zealand Limited

IRD 98 463 631

8 College Hill
Freemans Bay, Auckland 1011

0800 464 353 (0800 4 MIELE)

customercare@miele.co.nz

www.miele.co.nz

Miele Global Headquarters

Germany

Miele & Cie. KG

Carl-Miele-Straße 29

33332 Gütersloh

Federal Republic of Germany

H 7464 BPX

en-AU, NZ

M.-Nr. 11 192 330 / 15