

Operating and installation instructions Induction hobs



To avoid the risk of accidents or damage to the appliance it is **essential** to read these instructions before it is installed and used for the first time.

Warning and Safety instructions	7
Sustainability and environmental protection	15
Familiarisation	16
Your hob	16
Controls and display	17
Cooking zones	19
Power management	20
Operating principles	21
Networking	21
Miele@home	21
Direct connection with the cooker hood	21
Functions	22
Con@ctivity 3.0	22
Permanent pan recognition	22
Pan and pan size recognition	22
PowerFlex cooking area	22
Booster for hob power levels	22
TempControl	22
CookAssist	22
Stop&Go	22
Additional power levels	23
Auto heat-up	23
Timer	23
System lock	23
Safety lock	23
Recall	23
Keeping warm	23
Keeping warm Plus	23
Wipe protection	23
Programming	23
Demo mode	23
Residual heat indicator	24
Safety switch-off	24
Overheating protection	25
Hob data	25
Commissioning	26
Unpacking the hob	26
Cleaning the hob for the first time	26
Switching on the hob for the first time	26
Miele@home	26
Installing the Miele app	26
Setting up Miele@home	26

Contents

Establishing a direct connection with the cooker hood.....	29
Operation	30
Safety notes for operation.....	30
Switching the hob on.....	31
Switching off a cooking zone/the hob.....	31
Positioning cookware.....	32
Power level.....	33
Setting the power level.....	33
Setting the power level – extended setting range.....	33
Changing the power level.....	33
Linking/unlinking PowerFlex cooking zones manually.....	33
Booster.....	34
Activating the Booster.....	34
Deactivating the Booster.....	34
Activating/deactivating Stop&Go.....	34
TempControl.....	35
Notes on using the TempControl function.....	35
Activating TempControl.....	35
Activating the simmer setting.....	35
Enabling CookAssist actions.....	35
Auto heat-up.....	36
Activating auto heat-up.....	36
Deactivating auto heat-up.....	36
Timer.....	37
Setting timer durations.....	37
Setting the minute minder.....	37
Changing the minute minder duration.....	37
Deleting the minute minder duration.....	37
Setting the switch-off time.....	38
Changing the switch-off time.....	38
Deleting the switch-off time.....	38
Setting multiple switch-off times.....	38
Displaying switch-off times.....	38
Using both timer functions at the same time.....	38
System lock.....	39
Activating the system lock.....	39
Deactivating the system lock.....	39
Safety lock.....	39
Activating the safety lock.....	39
Deactivating the safety lock.....	39
Activating the Recall function.....	39

Keeping warm and reheating	40
Activating/deactivating the Keeping warm function	40
Activating/deactivating the Keeping warm Plus function.....	40
Keeping warm temperatures for various applications	40
Tips for keeping food warm	40
Wipe protection.....	40
Activating wipe protection	40
Deactivating wipe protection.....	40
Hob data	41
Displaying the model identifier/serial number	41
Displaying the software version	41
Activating/deactivating demo mode	41
Setting ranges for the power levels	42
Setting ranges for the frying levels.....	43
Good to know.....	44
How induction hobs work	44
Noises	44
Pans.....	44
Adjusting settings	46
Cleaning and care	51
Safety notes on cleaning and care	51
Unsuitable cleaning agents.....	52
Troubleshooting.....	53
Messages in the display.....	53
Unexpected behaviour.....	54
Unsatisfactory results.....	56
General problems or technical faults	56
After sales service.....	57
Contact in the event of a fault	57
Data plate	57
Guarantee.....	57
Optional accessories.....	59
Installation.....	60
Safety notes for installation	60
Additional safety notes for surface-mounted installation.....	61
Additional safety notes for flush-fit installation	62
Safety distances	63
Building-in dimensions for surface-mounted installation	70
Installation dimensions for flush-fit installation.....	71

Contents

Installing a surface-mounted hob	72
Preparing the worktop for surface-mounted installation	72
Installing a surface-mounted hob	72
Installing the hob flush with the worktop	73
Preparing the worktop for flush-fit installation	73
Installing a flush-fit hob	73
Electrical connection	74

Warning and Safety instructions

This hob complies with all relevant local and national safety requirements. Inappropriate use can, however, lead to personal injury and material damage.

Read the operating and installation instructions carefully before using the hob. They contain important information on safety, installation, use and maintenance. This prevents both personal injury and damage to the hob.

Miele expressly and strongly advises that you read and follow the instructions in the chapter on installing the hob as well as the safety instructions and warnings.

Miele cannot be held liable for injury or damage caused by noncompliance with these instructions.

Keep these instructions in a safe place and pass them on to any future owner.

Warning and Safety instructions

Correct application

- ▶ This hob is intended for domestic use and use in other similar environments.
- ▶ This hob is not intended for outdoor use.
- ▶ It is intended for domestic use only to cook food and keep it warm. Any other use is not supported by the manufacturer and could be dangerous.
- ▶ This hob is not intended for use by people with reduced physical, sensory or mental capabilities or lack of experience and knowledge, unless they have been given supervision and instruction concerning its use by a person responsible for their safety. They may only use the hob unsupervised if they have been shown how to use it in a safe way. They must be able to recognise and understand the dangers of misuse.

Safety with children

- ▶ Children must be kept away from the hob unless they are constantly supervised.
- ▶ Juveniles may use the hob if its operation has been clearly explained to them and they are able to use it safely. They must be able to understand and recognise the possible dangers caused by incorrect operation.
- ▶ Children must not be allowed to clean the hob unsupervised.
- ▶ Please supervise children in the vicinity of the hob and do not let them play with it.
- ▶ The hob gets hot when in use and remains hot for a while after being switched off. Keep children well away from the hob until it has cooled down and there is no danger of burning.
- ▶ Danger of burning. Do not store anything which might arouse a child's interest in storage areas above or behind the hob. Otherwise they could be tempted to climb onto the hob.
- ▶ Risk of burning and scalding. Place pots and pans on the cooking zone in such a way that children cannot pull them down and burn themselves.
- ▶ Danger of suffocation! Whilst playing, children may become entangled in packaging material (such as plastic wrapping) or pull it over their head with the risk of suffocation. Keep packaging material away from children.
- ▶ Activate the system lock to ensure that children cannot switch on the hob inadvertently. Use the safety lock when the hob is in use to prevent children from altering the settings selected.

Warning and Safety instructions

Technical safety

- ▶ Unauthorised installation, maintenance and repairs can cause considerable danger for the user. Installation, maintenance and repairs must only be carried out by a Miele authorised technician.
- ▶ Damage to the hob can compromise your safety. Check the hob for visible signs of damage. Do not use the hob if it is damaged.
- ▶ Temporary or permanent operation on an autonomous power supply system or a power supply system that is not synchronised with the mains power supply (e.g. island networks, back-up systems) is possible. A prerequisite for operation is that the power supply system complies with the specifications of EN 50160 or an equivalent standard.

The function and operation of the protective measures provided in the domestic electrical installation and in this Miele product must also be maintained in isolated operation or in operation that is not synchronised with the mains power supply, or these measures must be replaced by equivalent measures in the installation. As described, for example, in the current version of BS OHSAS 18001–2 ISO 45001.

- ▶ The electrical safety of this hob can only be guaranteed when correctly earthed. It is essential that this standard safety requirement is met. If in any doubt please have the electrical installation tested by a registered electrical worker.
- ▶ To avoid the risk of damage to the hob, make sure that the connection data on the data plate (voltage and frequency) match the mains electricity supply before connecting it to the mains. Consult a registered electrical worker if in doubt.
- ▶ Do not connect the hob to the mains electrical supply by a multi-socket adapter or extension lead. These are a fire hazard and do not guarantee the required safety of the appliance.
- ▶ For safety reasons, this hob may only be used after it has been built in.
- ▶ This hob must not be used in a non-stationary location (e.g. on a ship).
- ▶ Never open the casing of the hob.

Touching or tampering with electrical connections or components and mechanical parts is highly dangerous to the user and can cause operational faults.

Warning and Safety instructions

- ▶ While the hob is under warranty, repairs should only be undertaken by a Miele authorised service technician. Otherwise the warranty is invalidated.
- ▶ Miele can only guarantee the safety of the appliance when genuine original Miele replacement parts are used. Faulty components must only be replaced by Miele spare parts.
- ▶ The hob is not intended for use with an external timer switch or a remote control system.
- ▶ The hob must be connected to the electricity supply by a qualified electrician (see “Installation – Electrical connection”).
- ▶ If the mains connection cable is damaged, it must be replaced with a special mains connection cable by a registered electrical worker (see “Electrical connection” in the “Installation” chapter).
- ▶ The hob must be disconnected from the mains electricity supply during installation, maintenance and repair work. Ensure that power is not supplied to the appliance until after it has been installed or until any maintenance or repair work has been carried out.
- ▶ Danger of electric shock. Do not use the hob if it is faulty, or if the ceramic surface is cracked, chipped or damaged in any way. Switch it off immediately. Disconnect the hob from the mains electricity supply. Contact Miele Service.
- ▶ If the hob is installed behind a cabinet door, do not close the door while the hob is in use. Heat and moisture can build up behind the closed door. This can result in damage to the hob, the housing unit and the floor. Do not close the door until the residual heat indicators go out.
- ▶ In areas which may be subject to infestation by cockroaches or other vermin, pay particular attention to keeping the appliance and its surroundings clean at all times. Any damage caused by cockroaches or other vermin will not be covered by the warranty.

Warning and Safety instructions

Correct use

▶ The hob gets hot when in use and remains hot for a while after being switched off. There is a danger of burning until the residual heat indicators go out.

▶ Oil and fat can overheat and catch fire. Do not leave the hob unattended when cooking with oil and fat. If it does ignite do not attempt to put the flames out with water.

Disconnect the hob from the mains and use a suitable fire blanket, saucepan lid, damp towel or similar to smother the flames.

▶ Do not leave the hob unattended whilst it is being used. It should be continually monitored whilst boiling and flash frying.

▶ Flames could set the grease filters of a cooker hood on fire. Do not flambé under a cooker hood.

▶ Spray canisters, aerosols and other inflammable substances can ignite when heated. Therefore do not store such items or substances in a drawer under the hob. Cutlery inserts must be heat-resistant.

▶ Do not heat an empty pan.

▶ Do not heat up food in closed containers e.g. tins or sealed jars on the hob, as pressure can build up in the container, causing it to explode.

▶ Do not cover the hob, e.g. with a hob cover, a cloth or protective foil. The material could catch fire, shatter or melt if the hob is switched on by mistake or if residual heat is still present.

▶ When the appliance is switched on either deliberately or by mistake, or when there is residual heat present, there is the risk of any metal items left on the hob heating up, with the danger of burning. Depending on the material, other items left on the hob could also melt or catch fire. Damp pan lids might adhere to the ceramic surface and be difficult to dislodge. Do not use the appliance as a resting place. Switch the cooking zones off after use.

▶ You could burn yourself on the hot hob. Protect your hands with heat-resistant pot holders or gloves when handling hot pots and pans. Do not let them get wet or damp, as this causes heat to transfer through the material more quickly with the risk of scalding or burning yourself.

Warning and Safety instructions

- ▶ When using an electrical appliance, e.g. a hand-held food blender, near the hob, ensure that the cable of the electrical appliance cannot come into contact with the hot hob. The insulation on the cable could become damaged.
- ▶ Grains of salt, sugar and sand (e.g. from cleaning vegetables) can cause scratches if they get under pan bases. Make sure that the ceramic surface is clean before placing pans on it.
- ▶ Even a light object can cause damage in certain circumstances. Do not drop anything on the ceramic surface.
- ▶ Placing hot pans on the sensors and indicators could damage the electronics underneath. Do not place hot pans on the sensors or indicators.
- ▶ Do not allow solid or liquid sugar, or pieces of plastic or aluminium foil to get onto the hob when it is hot, as they can damage the ceramic surface when it cools down. If this should occur, switch off the appliance and scrape off all the sugar, plastic or aluminium residues whilst still hot, using a shielded scraper blade suitable for use on glass. Wear oven gloves when doing this. Allow the ceramic surface to cool down and then clean it with a suitable ceramic hob cleaning agent.
- ▶ Do not heat empty pans on the hob as this can damage the ceramic glass and/or the cookware. Never leave the hob unattended during use!
- ▶ Only use pots and pans with smooth bases. Rough bases will scratch the ceramic glass.
- ▶ Lift pans into position on the hob. Sliding them into place can cause scuffs and scratches.
- ▶ Because induction heating works so quickly, the base of the pan could, under certain circumstances, heat up to the temperature at which oil or fat self-ignites within a very short time. Never leave the hob unattended during use!
- ▶ Heat oil or fat for a maximum of one minute. Never use the Booster function to heat oil or fat.
- ▶ For people fitted with a heart pacemaker: Please note that the area immediately surrounding the hob is electromagnetically charged. It is very unlikely to affect a pacemaker. However, if in any doubt, consult the manufacturer of the pacemaker or your doctor.

Warning and Safety instructions

- ▶ To prevent damage to items which are susceptible to electromagnetic fields, e.g. credit cards, digital storage devices, pocket calculators, etc, do not leave them in the immediate vicinity of the hob.
- ▶ Metal utensils stored in a drawer under the hob can become hot if the appliance is used intensively for a long time.
- ▶ The hob is fitted with a cooling fan. If a drawer is fitted directly underneath the hob, ensure that there is sufficient space between the drawer and its contents and the underside of the hob in order to ensure sufficient ventilation for the hob.
- ▶ If a drawer is fitted directly underneath the hob, do not store any pointed or small items, paper, serviettes, etc. in the drawer. They could get in through the ventilation slots or be sucked into the casing by the fan and damage the fan or impair cooling.
- ▶ Never use two pans on a cooking zone, extended zone or PowerFlex zone at the same time.
- ▶ If the cookware only partially covers a cooking or extended zone, the handle could become very hot.
Always place cookware in the middle of a cooking or extended zone!
- ▶ The induction generators could be damaged or even destroyed if you use an induction adapter plate for cookware. Do not use induction adapter plates.

Cleaning and care

- ▶ Do not use a steam cleaning appliance to clean this hob. The steam could reach electrical components and cause a short circuit.
- ▶ If the hob is built in over a pyrolytic oven, the hob should not be used whilst the pyrolytic process is being carried out, as this could trigger the overheating protection mechanism on the hob (see relevant section).
- ▶ Miele will guarantee to supply functional spare parts for a minimum of 10 years and up to 15 years following the discontinuation of your hob.

Energy saving tips when cooking

- Cook in covered pots and pans if possible. This prevents heat escaping unnecessarily.
- Cook with as little water as possible.
- Once food has come to the boil or the pan is hot for frying, reduce the heat to a lower power level.
- Use a pressure cooker to reduce cooking durations.

Disposing of the packaging material

The packaging material is used for handling and protects the appliance from transport damage. The packaging material used is selected from materials which are environmentally friendly for disposal and can generally be recycled.

Recycling the packaging material reduces the use of raw materials. Use material-specific collection points for valuable materials and take advantage of return options. Your Miele dealer will take the packaging material away.

Disposing of your old appliance

Electrical and electronic appliances often contain valuable materials. They also contain specific materials, compounds and components, which were essential for their correct function and safety. These could be hazardous to human health and to the environment if disposed of with your domestic waste or if handled incorrectly. Please do not, therefore, dispose of your old appliance with your household waste.



Please dispose of it at your local community waste collection / recycling centre for electrical and electronic appliances, or contact your dealer or Miele for advice. You are also responsible (by law, depending on territory) for deleting any personal data that may be stored on the appliance being disposed of. Please ensure that your old appliance poses no risk to children while being stored prior to disposal.

Familiarisation

Your hob

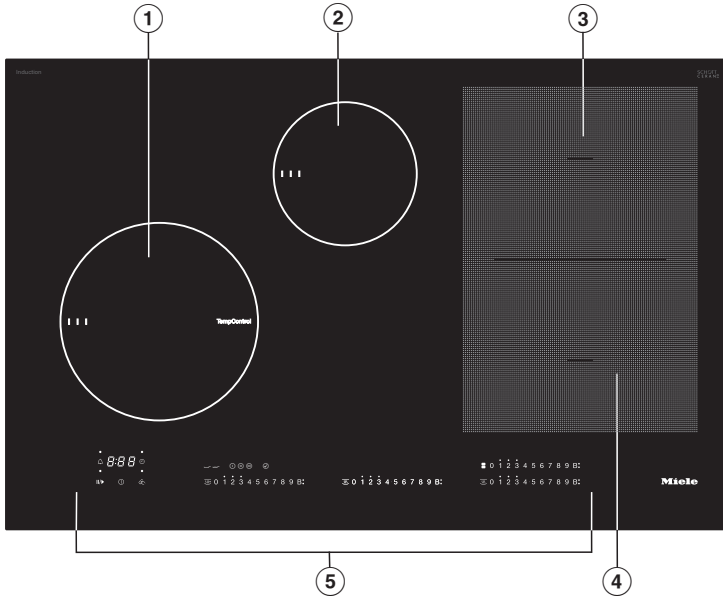

- ① Cooking zone with TwinBooster and TempControl*
- ② Cooking zone with TwinBooster
- ③ PowerFlex cooking zone with TwinBooster
can be combined with PowerFlex cooking zone ④ to form PowerFlex cooking area
- ④ PowerFlex cooking zone with TwinBooster
- ⑤ Controls and indicators

* On some hobs the ceramic surface in the middle of the cooking zone with TempControl is transparent and the temperature sensor is visible.

Controls and display

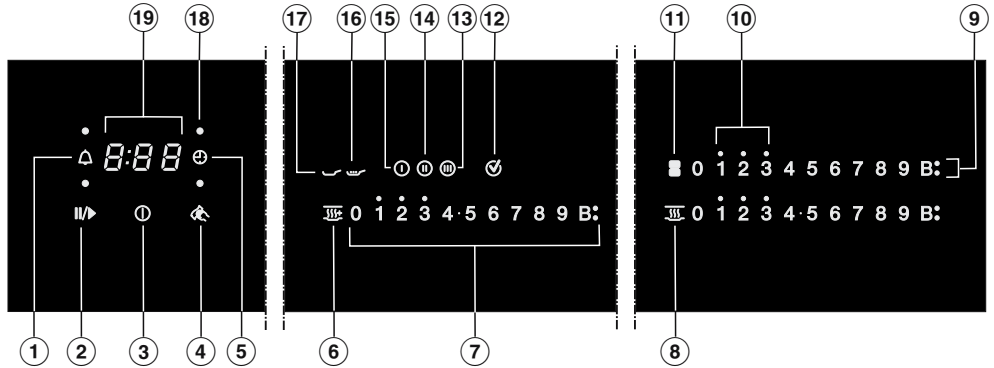

- ① Minute minder sensor control
- ② Stop&Go sensor control
To stop/start a cooking process in progress
- ③ Hob On/Off sensor control
- ④ Wipe protection sensor control
To lock the sensor controls
- ⑤ Auto switch off sensor control
Switches the cooking zones off automatically
- ⑥ Keeping warm Plus sensor control
(only for cooking zones with TempControl)
For activating/deactivating the Keeping warm Plus function
- ⑦ Numerical display sensor controls
– To set the power level
– To set the times
- ⑧ Keeping warm sensor control
To activate/deactivate the Keeping warm function
- ⑨ Booster sensor control
- ⑩ Residual heat displays
- ⑪ PowerFlex cooking zones sensor control
For manual connection/disconnection of PowerFlex cooking zones
- ⑫ CookAssist sensor control
(only for cooking zones with TempControl)
For enabling CookAssist actions
- ⑬ Frying level III sensor control
(only for cooking zones with TempControl)

Familiarisation

- ⑭ Frying level II sensor control
(only for cooking zones with TempControl)
- ⑮ Frying level I sensor control
(only for cooking zones with TempControl)
- ⑯ Simmer setting sensor control
(only for cooking zones with TempControl)
- ⑰ Cooking zone display with TempControl
- ⑱ Cooking zone allocation auto switch off indicator light
Auto switch off for the cooking zone is activated
- ⑲ Timer display

0:00 to Time
9:59

LOC System lock/safety lock is activated

dE Demo mode is activated

Cooking zones

Cooking zone	Size in cm ¹		Max. rating in watts for 220 V ²	Linked cooking zone ³	
	∅				
①	16–22	–	Normal TwinBooster, level 1 TwinBooster, level 2	2300 3000 3650	④
②	10–16	–	Normal TwinBooster, level 1 TwinBooster, level 2	1400 1700 2200	③
③	15–23	15 x 15 – 23 x 19	Normal TwinBooster, level 1 TwinBooster, level 2	2100 3000 3250	②
④	15–23	15 x 15 – 23 x 19	Normal TwinBooster, level 1 TwinBooster, level 2	2100 3000 3250	①
③ + ④	22–23	22 x 22 – 23 x 39	Normal TwinBooster, level 1 TwinBooster, level 2	3400 4800 7100	-
			Total	7100	

¹ Cookware with a base diameter/surface (width x depth) within the given range may be used.

² The power given may vary depending on the size and material of the cookware used.

³ The cooking zone is linked to this cooking zone electrically so that the rating can be increased (see “Familiarisation – Power management”).

Familiarisation

Power management

Total power

The hob has a maximum total permitted power consumption which cannot be exceeded for safety reasons.

The higher the total permitted power consumption of the hob, the more power levels/functions can be used on all cooking zones at the same time.

If the set power levels/functions require more power than can be provided in accordance with the total permitted power consumption, the hob will distribute the maximum permitted power between the cooking zones.

Distribution of power

Cooking zones can be linked together in pairs on the hob. This allows power to be transferred from one cooking zone (A) to another (B). As a result, the power of cooking zone (A) is reduced.

Example: the Booster function for cooking zone (B) is activated.

Cooking zone (B) which requires additional power is determined by the most recent setting on the hob.

The values for the maximum total permitted power consumption and which cooking zones are linked together can be found in "Familiarisation – Cooking zone data".

You can reduce the maximum total permitted power consumption (see "Adjusting settings").

Effects of power distribution

If a cooking zone gives power to another zone, this can have the following effects on the zone giving the power:

- The power level is reduced.
- Auto heat-up is deactivated. Cooking continues at the set level. If the power is not sufficient, the power level will be reduced again.
- The Booster function is deactivated.
- The cooking zone is switched off.

When the cooking zone stops transferring power to the other zone, the power level can be increased again.

Tip: If you wish to cook a large quantity of food on one cooking zone, switch the other cooking zones to lower power levels.

Operating principles

Hob when switched off

When the hob is switched off, you can only see the printed symbols for the sensor controls and the numerical display. More sensor controls light up when the hob is switched on.

Operation

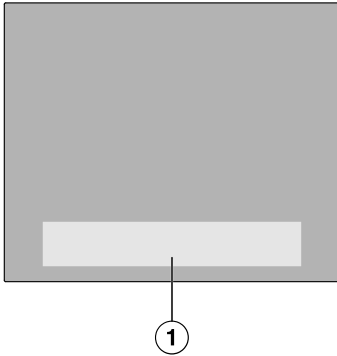

① Sensor controls and indicators

This ceramic glass hob is equipped with sensor controls which react to finger contact.

Each time a sensor control is activated, an audible signal sounds.

For safety reasons, in order to switch the appliance on, the On/Off ① sensor control needs to be touched for a little longer than the other sensors.

Networking

Your hob is equipped with an integrated WiFi module. The hob can be connected to your home WiFi network or simply to your Miele cooker hood.

Miele@home

After installing the Miele app on a mobile device, you can do the following:

- Call up information on the operating status of your hob
- Call up information on the programme sequence of your hob
- Set up a Miele@home network with other WiFi-enabled Miele appliances
- Control a connected Miele cooker hood automatically via the hob settings (Con@ctivity 3.0)

Direct connection with the cooker hood

Once you have established a direct connection with a Miele cooker hood, you can do the following:

- Control a connected Miele cooker hood automatically via the hob settings (Con@ctivity 3.0)

Familiarisation

Functions

Con@ctivity 3.0

Con@ctivity 3.0 is the direct communication system between your hob and a Miele cooker hood. Communication is achieved by means of networking. Con@ctivity 3.0 enables the cooker hood to operate automatically depending on the operating status of your hob.

The Con@ctivity versions of the hob and cooker hood must match.

Further information can be found in the operating and installation instructions for your cooker hood.

Permanent pan recognition

When you place cookware on a cooking zone, the numerical display for the cooking zone is activated automatically.

Pan and pan size recognition

The cookware and its size are detected within a cooking zone. The release of energy is adapted to the size of the pan.

PowerFlex cooking area

A PowerFlex cooking area links together 2 PowerFlex cooking zones, making it possible to use larger cookware.

The PowerFlex cooking zones combine automatically to form a PowerFlex cooking area when you place sufficiently large items of cookware on them (see “Familiarisation – Cooking zone data”). The PowerFlex cooking zones can also be linked manually.

Booster for hob power levels

When the Booster function is activated, the power is boosted so that large quantities can be heated up quickly, e.g. when boiling water for cooking pasta.

TempControl

TempControl is used to obtain and maintain the ideal temperature for the food being cooked so that the power levels do not need to be adjusted manually. A sensor under the cooking zone measures the temperature under the ceramic glass and the pan. The sensor regulates the cooking zone power level so that the temperature remains constant:

- The fat cannot overheat.
- The power levels do not need to be adjusted manually.
- It is not necessary to turn the food being fried frequently.

Depending on the hob model, the sensor will be visible in the centre of the cooking zone.

There are 3 frying levels and a simmer setting.

CookAssist

With the CookAssist function, you can transfer the settings (such as the power level) of specific Miele recipes to your hob.

Stop&Go

When Stop&Go is activated, all power levels are reduced to 1. When the function is deactivated, the appliance switches back to the power level that was set last.

Tip: Use this function if there is a danger of food boiling over.

Additional power levels

You can activate additional levels between the existing power levels. These intermediate levels allow you to adjust the power more precisely for the cookware.

Auto heat-up

When auto heat-up has been activated, the cooking zone switches on automatically at the highest setting and then switches to the power level (continued cooking setting) which you have previously selected.

Timer

The timer can be used for the following two functions:

- For setting the minute minder
- For automatically switching a cooking zone off

You can use the functions simultaneously.

Minute minder

You can set an alarm for activities that are independent of the hob.

Auto switch off

You can set a time after which a cooking zone will switch off automatically. This function can be used for all cooking zones at the same time.

System lock

If the system lock is activated, then the hob cannot be switched on.

Safety lock

The safety lock is activated when the hob is switched on. When the lock is activated, the hob can be operated only under certain conditions.

Recall

If the hob is switched off by mistake during use, this function can be used to reset all settings. For this to work, the hob must be switched on again within 10 seconds of being switched off.

Keeping warm

This function enables food to be kept warm after it has finished cooking. The maximum duration for keeping food warm is 2 hours.

Keeping warm Plus

Only TempControl cooking zones have the Keeping warm Plus function.

This function enables food to be kept warm after it has finished cooking and to be reheated.

The TempControl sensor detects whether food needs to be kept warm or reheated and adjusts the power level accordingly.

The maximum duration for keeping food warm is 2 hours.

Wipe protection

The hob sensor controls can be locked for 20 s to remove soiling, for example. The ⓘ sensor control is not locked.

Programming

You can adapt the programming of the hob to your personal needs.

Demo mode

This function enables dealers to demonstrate the hob without it heating up.

Familiarisation

Residual heat indicator

If the cooking zone is still hot, the residual heat indicator will light up after it has been switched off. Depending on the temperature, a dot will appear above power levels 1, 2 and 3.

The dots in the residual heat indicator go out one by one as the cooking zones cool down. The last dot only goes out when the cooking zone is safe to touch.

Safety switch-off

Sensor controls are covered

Your hob will turn off automatically if one or several of the sensor controls remain covered for longer than 10 seconds, for example, by finger contact, food boiling over or by an object such as an oven glove or tea towel. ① flashes briefly above the Ƨ sensor control and a tone will sound. Ƨ will go out once you have removed the object and/or cleaned the hob and the hob will be ready to use again.

Excessive operating time

The safety switch-off is triggered automatically if a cooking zone is heated for an unusually long period of time. This time depends on the power level selected. If it has been exceeded, the cooking zone switches off and the residual heat indicator appears. If you switch the cooking zone off and on again, it is ready for operation again.

You can adjust the safety switch-off by changing the safety setting (see “Adjusting settings”).

Power level*	Maximum operating time [h:min]		
	Safety setting		
	0**	1	2
1	10:00	8:00	5:00
1.	10:00	7:00	4:00
2/2.	5:00	4:00	3:00
3/3.	5:00	3:30	2:00
4/4.	4:00	2:00	1:30
5/5.	4:00	1:30	1:00
6/6.	4:00	1:00	00:30
7/7.	4:00	00:42	00:24
8	4:00	00:30	00:20
8.	4:00	00:30	00:18
9	1:00	00:24	00:10
①, ②, ③	4:00	00:42	00:24

* The power levels with a dot after the number are only available if the power level range has been extended (see “Setting ranges”).

** Factory default setting

Overheating protection

In order to prevent the hob from being damaged by excessive temperatures, the overheating protection mechanism intervenes in one of the following ways:

Overheating protection measures

- If the Booster function is switched on, it will stop.
- The set power level will be reduced.
- A cooking zone will switch off. *Err* will flash alternately with *044* in the timer display.
- All cooking zones will switch off.

Triggering the overheating protection mechanism

The overheating protection may be activated under the following circumstances:

- The cookware being heated is empty.
- Fat or oil is being heated on a high power level.
- Insufficient ventilation to the underside of the hob.
- A hot cooking zone is switched back on after an interruption to the power supply.

Hob data

The model identifier, serial number and software version of the hob can be displayed.

Commissioning

Unpacking the hob

- Please stick the data plate for the appliance, supplied with this documentation, in the space provided in the “Customer Service Department” section of this booklet.
- Remove any protective foil and stickers.

Cleaning the hob for the first time

- Before using for the first time, clean the hob with a damp cloth.
- Wipe the hob dry.

Switching on the hob for the first time

The metal components have a protective coating. When the hob is used for the first time, this causes a smell and possibly also vapour. The heating of the induction coils also causes odours in the first few hours of operation. With each subsequent use, the odour is reduced until it disappears completely.

The smell and any vapours given off do not indicate a faulty connection or appliance and they are not hazardous to health.

Miele@home

Installing the Miele app

The ability to use the Miele app depends on the availability of the Miele@home service in your country. For information about availability, please visit www.miele.com.

The Miele app is available free of charge from the Apple App Store® or from the Google Play Store™.



- Install the Miele app on your mobile device.

Setting up Miele@home

The WiFi connection shares a frequency range with other appliances (including microwave ovens and remote control toys). This can give rise to sporadic or even complete connection failures. Therefore, the availability of featured functions cannot be guaranteed.

The hob requires max. 2 W in networked standby.

There are a number of ways of connecting your hob to your WiFi network.

Connecting via the Miele app

- A home WiFi network is available.
- The signal of your WiFi network is sufficiently strong in the place where your hob is installed.
- There is no direct WiFi connection between the hob and a Miele cooker hood (Con@ctivity 3.0).
- The Miele app is installed on your mobile device.

- Start the Miele app.
- Switch the hob on.
- Touch the 0 sensor control on any of the numerical displays.
- Touch the 0 and 5 sensor controls at the same time for 6 seconds.

The seconds can be seen counting down in the timer display. After this time has elapsed, the code `Ⓒ:07` is displayed in the timer display for 10 seconds.

You now have 10 minutes to configure the WiFi.

- Follow the user navigation in the app.

You can use all Miele@home functions.

Connecting via WPS

- A home WiFi network is available.
- The signal of your WiFi network is sufficiently strong in the place where your hob is installed.
- There is no direct WiFi connection between the hob and a Miele cooker hood (Con@ctivity 3.0).
- You must have a WPS (WiFi protected setup) compatible router.

- Switch the hob on.
- Touch the 0 sensor control on any of the numerical displays.
- Touch the 0 and 6 sensor controls at the same time for 6 seconds.

The seconds can be seen counting down in the timer display. After the time has elapsed, a progress light appears in the timer display during the connection attempt (for max. 120 seconds).

The WPS login is active during these 120 seconds.

- Activate the WPS function on your WiFi router.

If the connection was successful, the code `Ⓒ:02` appears in the timer display. If the connection could not be established, the timer display will show the code `Ⓒ:07`. You have probably not activated WPS on your router quickly enough. Repeat the steps above.

- Install the Miele app.
- Follow the user navigation in the app.

You can use all Miele@home functions.

Tip: If your WiFi router does not support WPS, please connect via the Miele app.

Commissioning

Canceling the process

- Touch any sensor control.

Resetting settings

Reset the settings if you are disposing of your hob, selling it or putting a used hob into operation. This is the only way to ensure that all personal data has been removed and the previous owner will no longer be able to access the hob. Resetting is not required when replacing the router.

- Switch the hob on.
- Press the 0 sensor control on any numerical display.
- Touch the 0 and 9 sensor controls at the same time for 6 seconds.

The seconds can be seen counting down in the timer display.

After this time has elapsed, the code `ℳ:00` is displayed in the timer display for 10 seconds.

Establishing a direct connection with the cooker hood

The hob requires max. 2 W in networked standby.

Availability of the WiFi connection

The WiFi connection shares a frequency range with other appliances (including microwave ovens and remote control toys). This can give rise to sporadic or even complete connection failures. Therefore, the availability of featured functions cannot be guaranteed.

Establishing a direct connection with the cooker hood

You can find the necessary information on connecting the cooker hood in the associated operating and installation instructions.

- Miele cooker hood with Con@ctivity 3.0
- The hob is not connected to your home network (Miele@home)

- Switch the hob on.
- Press the 0 sensor control on any numerical display.
- Touch the 0 and 7 sensor controls at the same time for 6 seconds.

The seconds can be seen counting down in the timer display. After the time has elapsed, a progress light appears in the timer display during the connection attempt. If the connection was successful, the code `C:02` appears in the timer display. If the connection could not be established, the timer display will show the code `C:01`. Repeat the steps above.

When successfully connected, displays 2 and 3 will light up constantly on the cooker hood.

- To quit connection mode on the cooker hood, press the run-on button ⁵ .

Con@ctivity 3.0 is now activated.

Cancelling the process

- Touch any sensor control.

Resetting settings

Reset the settings if you are disposing of your hob, selling it or putting a used hob into operation. This is the only way to ensure that all personal data has been removed and the previous owner will no longer be able to access the hob. Resetting is not required when replacing the router.

- Switch the hob on.
- Press the 0 sensor control on any numerical display.
- Touch the 0 and 9 sensor controls at the same time for 6 seconds.

The seconds can be seen counting down in the timer display.

After this time has elapsed, the code `C:00` is displayed in the timer display for 10 seconds.

Operation

Safety notes for operation

 Risk of fire with overheated food.

Unattended food can overheat and catch alight.

Do not leave the hob unattended whilst it is being used.

 Risk of burning due to hot cooking zones.

The cooking zones will be hot after use.

Do not touch the cooking zones while the residual heat indicators are on.

 Risk of burning due to hot items.

When the hob is switched on either deliberately or by mistake, or when there is residual heat present, there is the risk of metal items placed on the hob heating up.

Do not use the hob as a resting place for anything.

After use, switch the hob off with the  sensor control.

 Placing hot cookware on the sensor controls and displays can damage the electronic module underneath.

The sensor controls do not respond.

They may be switched on or off unintentionally.

The hob will switch itself off (see “Familiarisation – Safety switch-off”).

Do not place hot cookware over the sensor controls or displays.

TempControl is not suitable for deep fat frying and boiling.

Use this function for normal frying only.

Switching the hob on

- Touch the ① sensor control.

Further sensor controls will light up.

If no further entry is made, the hob will switch itself off after a few seconds for safety reasons.

Switching off a cooking zone/ the hob

Switching the hob off

- To switch off the hob and all the cooking zones, touch the ① sensor control.

Switching off a cooking zone

- To switch off a cooking zone, touch the 0 sensor control on the numerical display for that cooking zone.

Operation

Positioning cookware

Refer to the cooking zone data for your hob model for information about cookware sizes and the corresponding positions (see “Familiarisation – Hob data”).

- Position the cookware as shown below:

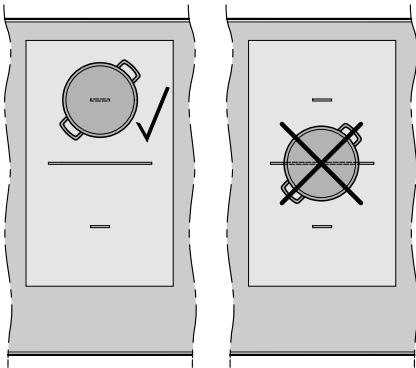

PowerFlex cooking zone

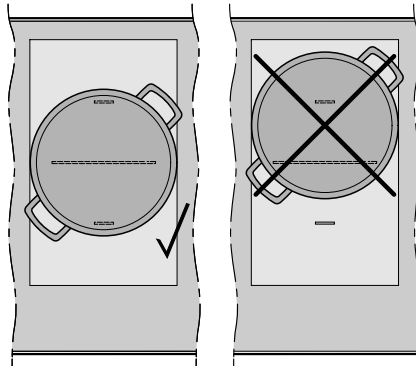

PowerFlex cooking area

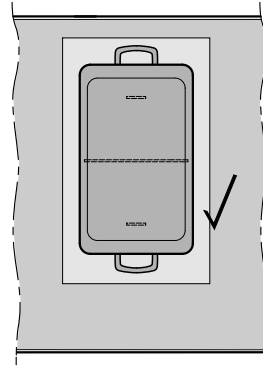

PowerFlex cooking area

Power level

Setting the power level

Permanent pan recognition is activated as standard (see “Adjusting settings”). When the hob is switched on and you place an item of cookware on one of the cooking zones, all the sensor controls for the numerical display will light up.

- Place the cookware on the cooking zone you want to use.
- Touch the appropriate sensor control for the power level you want on the relevant numerical display.

Setting the power level – extended setting range

The extended setting range for the power levels is activated (see “Adjusting settings”).

- Press the numerical display between the sensor controls.

The numbers to the left and right of the interim level light up brighter than the other sensor controls.

Example:

if you have set power level 7. the numbers 7 and 8 will be brighter than the other sensor controls.

Changing the power level

- Touch the appropriate sensor control for the power level you want on the numerical display.

Linking/unlinking PowerFlex cooking zones manually

- To manually link or unlink the PowerFlex cooking zones, touch the  sensor control.

Operation

Booster

Activating the Booster

When the Booster function is activated, the settings for the linked cooking zone may be changed (see “Familiarisation – Power management”).

The Booster function can be used on a maximum of 2 cooking zones at the same time.

The Booster function is active for a maximum of 15 minutes.

TwinBooster level 1

- Place the cookware on the cooking zone you want to use.
- Select a power level if necessary.
- Touch the **B** sensor control.

The indicator light ● for TwinBooster level 1 lights up.

TwinBooster level 2

- Place the cookware on the cooking zone you want to use.
- Select a power level if necessary.
- Touch the **B** sensor control twice.

The indicator light ●● for TwinBooster level 2 lights up.

Deactivating the Booster

- Touch the **B** sensor control repeatedly until the indicator lights go out.

or

- Set another power level.

If you deactivate the Booster function or the Booster time comes to an end and

- no power level was selected before activating the Booster, the cooking zone will revert automatically to level 9.
- a power level was selected before activating the Booster, the cooking zone will revert automatically to the previously selected level.

Activating/deactivating Stop&Go

The power levels and the timer settings cannot be altered; the hob can only be switched off. The minute minder, switch-off, Booster and heat-up times continue to run.

If the function is not deactivated within 1 hour, the hob will switch off.

- Touch the **II/▶** sensor control.

TempControl

Notes on using the TempControl function

- You can switch from one frying level to another.
- You can switch from the simmer setting back to a frying level.
- TempControl is deactivated if you switch from a frying level to a power level.
- You can perform several frying processes in succession. The cooking zone does not need to cool down.

Activating TempControl

When frying with butter, only use frying level ①.

- Place a pan on the cooking zone and add frying fat/oil if necessary.
- Touch the sensor control for the frying level you want to use (①, ②, ③).

The sensor control for the frying level selected will start to pulsate.

Once the pre-set temperature for the frying level selected has been reached:

- A signal sounds.
- The sensor control lights up constantly.
- The simmer setting sensor control  lights up.
- Place the food in the frying pan.

Activating the simmer setting

If you want to cook on low heat following the frying process, select the simmer setting.

To ensure the simmer process works reliably, at least 250 ml of liquid must be added (make sure the liquid is not too thick).

- Touch the simmer setting sensor control  and add at least 250 ml of liquid.

Enabling CookAssist actions

If there is no action in the app that is waiting to be confirmed on the hob, the sensor control will not light up.

If a recipe is started in the app, only the start needs to be confirmed in the app and on the hob. Additional preparation steps can be confirmed either in the app or on the hob.

- Mobile device with latest version of the Miele app (see “Commissioning – Miele@home”)
- Hob must be connected to Miele@home

- Follow the user navigation in the app.
- If you wish to start an action in the app via the hob, confirm the action in the app.

The  sensor control flashes.

- Touch the  sensor control on the hob.

The  sensor control no longer lights up. The hob starts the action.

Operation

Auto heat-up

The heat-up time depends on which continued cooking setting has been chosen:

Continued cooking setting*	Heat-up time [min:sec]
1	Approx. 0:15
1.	Approx. 0:15
2	Approx. 0:15
2.	Approx. 0:15
3	Approx. 0:25
3.	Approx. 0:25
4	Approx. 0:50
4.	Approx. 0:50
5	Approx. 2:00
5.	Approx. 5:50
6	Approx. 5:50
6.	Approx. 2:50
7	Approx. 2:50
7.	Approx. 2:50
8	Approx. 2:50
8.	Approx. 2:50
9	—

* The continued cooking settings with a dot after the number are only available if the power level range has been extended (see "Adjusting settings").

Activating auto heat-up

- Touch the sensor control for the continued cooking level you want until a tone sounds and the sensor control starts to pulsate.

During the heat-up time (see table) for a selected:

- Continued cooking level, the set continued cooking level will pulsate
- Interim power level, the sensor controls in front of and after the interim power level will pulsate

Deactivating auto heat-up

- Touch the sensor for the continued cooking setting.

or

- Set another power level.

Timer

Setting timer durations

A duration of between 1 minute (0:01) and 9 hours 59 minutes (9:59) can be set.

Durations of up to 59 minutes are shown in minutes (00:59) and durations of more than 60 minutes are shown in hours and minutes.

Durations are entered:

- Using the left or front left numerical display (depending on the model) in the case of a minute minder
 - Using the numerical display of the cooking zone to be switched off automatically in the case of a switch-off time
- Enter durations in the order of hours, followed by minutes in tens and then units.

Example:

59 minutes = 00:59 hours,

Enter: 5-9

80 minutes = 1:20 hours,

Enter: 1-2-0

After the first number has been entered, the timer display will light up constantly. After the second number has been entered, the first number will move to the left. After the third number has been entered, the first and second numbers will move to the left.

Setting the minute minder

- Touch the  sensor control.

The timer display flashes.

- Set the required duration (see “Timer – Setting timer durations”).

Touch the  sensor control or wait 10 seconds to start the minute minder.

Changing the minute minder duration

- Touch the  sensor control.

The timer display flashes.

- Set the required duration (see “Timer – Setting timer durations”).

Touch the  sensor control or wait 10 seconds to start the minute minder.

Deleting the minute minder duration

- Touch the  sensor control.

- Touch  on the numerical display.

Operation

Setting the switch-off time

A cooking zone will switch off when the maximum operating time has elapsed, independently of a set switch-off time (see “Familiarisation – Safety switch-off”).

A power level is set for the desired cooking zone.

- Touch the  sensor control.

The timer display flashes.

- Set the required duration (see “Timer – Setting timer durations”).

Touch the  sensor control or wait 10 seconds to start the switch-off time.

The switch-off time for the cooking zone elapses and the cooking zone allocation auto switch off indicator light pulsates.

Changing the switch-off time

- Touch the  sensor control repeatedly until the indicator light for the cooking zone you require pulsates.

The timer display flashes.

- Set the required duration (see “Timer – Setting timer durations”).

Touch the  sensor control or wait 10 seconds to start the switch-off time.

The switch-off time for the cooking zone elapses and the cooking zone allocation auto switch off indicator light pulsates.

Deleting the switch-off time

- Touch the  sensor control repeatedly until the auto switch off indicator light for the cooking zone you require pulsates.

The timer display flashes.

- Touch the  sensor control on the numerical display.

Setting multiple switch-off times

- To set a switch-off time for another cooking zone, follow the steps described in “Operation – Setting the switch-off time”.

If more than one switch-off time is programmed, the shortest time left will be displayed and the corresponding indicator light will pulsate. The other indicator lights light up constantly.



Displaying switch-off times

- If you want to show the time left for another cooking zone which is counting down in the background, touch the  sensor control repeatedly until the indicator light for the desired cooking zone pulsates.

The **rounded up** time left is displayed for the required cooking zone.

Using both timer functions at the same time

If you use both functions simultaneously, the shortest time is always displayed. The  sensor control (minute minder) or the indicator light of the cooking zone with the shortest switch-off time pulsates.

- If you want to show the times left counting down in the background, touch the  or  sensor control.
- If a switch-off time has been programmed for several cooking zones, touch the  sensor control repeatedly until the indicator light for the required cooking zone pulsates.

System lock

Activating the system lock

All sensor controls are locked. A set minute minder time will continue to count down.

- Touch the ① sensor control for 6 seconds.

The seconds can be seen counting down in the timer display. When this time has elapsed, *LDC* will appear in the timer display. The system lock is activated.

If a disallowed sensor control is touched whilst the system lock is activated, *LDC* will appear in the timer display for a few seconds and a buzzer will sound.

The system lock can be programmed to be activated automatically 5 minutes after the hob has been switched off (see “Adjusting settings”).

Deactivating the system lock

- Touch the ① sensor control for 6 seconds.

LDC will appear briefly in the timer display and then the seconds will count down. The system lock is deactivated once the time has elapsed.

Safety lock

Activating the safety lock

When the safety lock is activated:

- The cooking zones and the hob can only be switched off
- A set minute minder time can be modified

- Touch and hold the ☺ and II/▶ sensor controls at the same time for 6 seconds.

The seconds can be seen counting down in the timer display. When this time has elapsed, *LDC* will appear in the timer display. The safety lock is activated.

If a disallowed sensor control is touched while the safety lock is activated, *LDC* will appear in the timer display for few seconds and a buzzer will sound.

Deactivating the safety lock

- Touch and hold the ☺ and II/▶ sensor controls at the same time for 6 seconds.

LDC will appear briefly in the timer display and then the seconds will count down. Once the time has elapsed, the safety lock function is deactivated.

Activating the Recall function

- Switch the hob on again.

The previously set power levels flash.

- Press one of the flashing power level indicators immediately.

All settings are restored.

Operation

Keeping warm and reheating

Activating/deactivating the Keeping warm function

The Keeping warm function cannot be used to reheat food that has gone cold.

The cooking zone does not have the TempControl function.

- Touch the  sensor control for the cooking zone you wish to use.

Activating/deactivating the Keeping warm Plus function

The Keeping warm Plus function can be used to reheat food that has gone cold.

The cooking zone has the TempControl function.

- Touch the  sensor control for the cooking zone you wish to use.

Keeping warm temperatures for various applications

A keeping warm temperature of 85 °C is set as standard. You can change the keeping warm temperature (see “Changing settings”).

Application	Temperature °C
Melting chocolate	50–55
Keeping solid food and thick liquids warm	65–75
Keeping clear soups warm	80–90

Tips for keeping food warm

- Only use cookware (pots/pans) for keeping food warm. Cover the cookware with a lid.
- Stir firm or viscous food (mashed potatoes, stew) occasionally.
- Nutrients are lost when food is cooked, and continue to diminish when food is kept warm. The longer food is kept warm, the greater the loss of nutrients. Try to ensure that food is kept warm for as short a time as possible.

Wipe protection

Activating wipe protection

- Touch the  sensor control.

The time counts down in the timer display.

Deactivating wipe protection

- Touch and hold the  sensor control until the timer display goes out.

Hob data

Displaying the model identifier/serial number

There must not be any cookware on the hob.

- Switch the hob on.
- Press the 0 sensor control on any numerical display.
- Press the 0 and 4 sensor controls on the numerical display at the same time for 6 seconds.

Numbers will appear in the timer display one after another, separated by a dash.

Example: *12 34* (model identifier KM 1234) – *1 23 45 67 89* (serial number)

Displaying the software version

There must not be any cookware on the hob.

- Switch the hob on.
- Press the 0 sensor control on any numerical display.
- Press the 0 and 3 sensor controls on the numerical display at the same time for 6 seconds.

3 numbers appear in the timer display:

Example: *123* = Software version 1.23.

Activating/deactivating demo mode

- Switch the hob on.
- Press the 0 sensor control on any numerical display.
- Press the 0 and 2 sensor controls on the numerical display at the same time for 6 seconds.

The following will flash in the timer display for a few seconds:

- *dE* alternating with *On* (demo mode activated)
or
- *dE* alternating with *OFF* (demo mode deactivated)

Setting ranges for the power levels

The hob is programmed with 9 power levels at the factory. If you wish to fine-tune a setting, you can extend the power level range to 17 power levels (see “Adjusting settings”).

	Setting range	
	Factory setting (9 power levels)	Extended setting (17 power levels)
Melting butter Melting chocolate Dissolving gelatine	1–2	1–2.
Warming up small quantities of liquid Keeping warm food which sticks easily Cooking rice or porridge Defrosting vegetables frozen in a block	2–4	2–3.
Warming up liquid and semi-solid food Steaming fruit Simmering potatoes (cookware with lids)	4–6	3.–5.
Making omelettes or lightly fried eggs Gently frying meat patties Steaming fish and vegetables Cooking dumplings and dried pulses Defrosting and reheating frozen food Thickening sauces, e.g. Hollandaise Pancakes	5–7	4.–7.
Gently frying (without overheating the fat) fish, escalopes, sausages, fried eggs, etc.	6–8	6–7.
Cooking hash browns, pancakes, etc.	7–8	7–8.
Frying, e.g. chips	9	8.–9
Boiling large quantities of water Bringing to the boil Searing large quantities of meat	9–Booster	8.–Booster

These settings should only be taken as a guide. The power of the induction coils will vary depending on the size and material of the cookware. For this reason, the power levels may need to be adjusted slightly to suit your cookware. As you use the hob, you will get to know which settings suit your cookware best. When using new cookware that you are not familiar with, set the power level to one level below the one specified.

Setting ranges for the frying levels

	Setting range
Reducing sauces	Simmer setting 
Fried eggs, scrambled eggs Frozen meat, e.g. cordon bleu Chicken breasts Frozen spring rolls Frozen fish fingers Fish fillets/whole fish Kebabs Vegetables in butter (mushrooms, garlic) Gnocchi in butter Meat patties Bacon	Frying level ①
Potato pancakes Pancakes Fried potatoes made from raw potatoes Meat loaf Steaks Escalopes Tortilla Langos (Hungarian flatbread) Popcorn Frozen stir-fried dishes Dry-roasting seeds Prawns Sausages Caramel Sliced meat	Frying level ②
Cooking with a wok Fried potatoes made from cooked potatoes Searing meat for stews (e.g. goulash) Searing large amounts of meat	Frying level ③

Good to know

How induction hobs work

An induction coil is located under each induction cooking zone. The coil creates a magnetic field that reacts directly with the base of the pan and heats it up. The cooking zone itself is heated up indirectly by the heat given off by the pan.

An induction cooking zone only works when a piece of cookware with a magnetic base is placed on it (see “Good to know – Cookware”). The hob automatically recognises the size of the cookware.

Noises

When using induction cooking zones, the following noises can occur in the cookware, depending on what it is made of and how it has been constructed:

Buzzing on the higher power levels. This will decrease or cease altogether when the power level is reduced.

If the cookware base is made of layers of different materials (e.g. in a sandwiched base), it might emit a crackling sound.

Whistling might occur if linked cooking zones (see “Operation – Booster”) are being used at the same time, and the cookware items also have bases made of layers of different materials (e.g. sandwiched base).

You might hear a clicking sound from the electronic switches, especially at lower power levels.

A whirring sound, when the cooling fan comes on. This switches on to protect the electronic module when the hob is being used intensively. The cooling fan may continue to run after the hob has been switched off.

Pans

Suitable cookware

- Stainless steel cookware with a magnetic base
- Enamelled steel cookware
- Cast iron

Please be aware that the properties of the cookware base can affect the evenness with which the food heats up (e.g. when making pancakes). The base of the pan must be able to distribute the heat evenly. Cookware with a base made from multilayer material (sandwich or encapsulated base) is ideal in this case.

Unsuitable pans.

- stainless steel pans without a magnetic base
- aluminium or copper pans
- glass, ceramic or earthenware pots and pans

Testing pans

To test whether a pan is induction-compatible, hold a magnet to the base of the pan. If the magnet sticks, the pan is generally suitable.

Cookware tips

- Position the cookware as centrally as possible on the relevant cooking zone/cooking area.
- To make optimum use of the cooking zones, choose cookware with a suitable base diameter (see “Familiarisation – Cooking zone data”). If a pan is too small, it will not be recognised.
- Use only pots and pans with smooth bases. Rough bases can scratch the ceramic glass.
- Always lift cookware to move it. This will help prevent scratching. If any scratches do appear as a result of cookware being pushed around, this will not affect the function of the hob. These scratches are normal signs of use and are not grounds for making a complaint.
- Please note that the cookware diameter quoted by manufacturers often refers to the maximum diameter or diameter of the top rim. The diameter of the base (generally smaller) is more important.

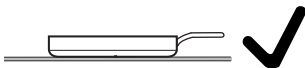

- Where possible, use cookware with vertically straight sides. If an item of cookware has angular sides, induction also acts on the sides of the item of cookware. The sides of the item of cookware may discolour or the coating may peel off.

Adjusting settings

Accessing programming mode

The **II/▶** sensor is located approx. 1 cm (index finger width) to the left of the **⓪** sensor.

The hob is switched off.

- Press and hold the **⓪** and **II/▶** sensor controls until the **⊕** sensor control lights up and **PC** appears in the timer display.

After a few seconds **P:01** (Programme 01) will flash alternately with **⓪:01** (Code) in the timer display.

Setting a programme

For a two-digit programme number you need to first set the tens position.

- While the programme is visible in the display (e.g. **P:01**), press the **⊕** sensor control repeatedly until the number for the programme you want appears in the display or touch the appropriate number on the numerical display.

Setting the code

- While the code is visible in the display (e.g. **⓪:01**), press the **⊕** sensor control repeatedly until the number for the code you want appears in the display or touch the appropriate number on the numerical display.

Saving the settings

- Whilst the programme is visible in the display (e.g. **P:01**), touch the **⓪** sensor control until the displays go out.

To avoid saving the settings

- While the code is showing in the display (e.g. **⓪:01**) touch the **⓪** sensor until the indicators go out.

Adjusting settings

Programme ¹		Code ²	Settings
P:01	Demo mode	C:00	Demo mode off
		C:01	Demo mode on ³
P:03	Factory default settings	C:00	Do not restore factory default settings
		C:01	Restore factory default settings
P:04	Power level setting range	C:00	9 power levels + Booster
		C:01	17 power levels + Booster ⁴
P:06	Audible tone when a sensor control is touched	C:00	Off ⁵
		C:01	Quiet
		C:02	Medium
		C:03	Loud
P:07	Timer buzzer	C:00	Off
		C:01	Quiet
		C:02	Medium
		C:03	Loud
P:08	System lock	C:00	System lock can only be activated manually
		C:01	System lock activated automatically
P:09	Maximum operating time	C:00	Safety setting 0
		C:01	Safety setting 1
		C:02	Safety setting 2

Adjusting settings

Programme ¹		Code ²	Settings
P:10	WiFi registration	C:00	Not active/deactivated
		C:01	Active but not configured
		C:02	Active and configured (cannot be selected; displays whether connection was successful)
		C:03	Connection possible via WPS push button
		C:04	WiFi reset to default (C:00)
		C:05	Direct WiFi connection of hob and cooker hood without Miele app (Con@ctivity 3.0)
P:12	Sensor controls reaction speed	C:00	Slow
		C:01	Normal
		C:02	Fast
P:15	Permanent pan recognition	C:00	Permanent pan recognition off
		C:01	Permanent pan recognition on
P:16	Maximum cookware temperature for manual frying and cooking	C:00	160 °C
		C:01	170 °C
		C:02	180 °C
		C:03	190 °C
		C:04	200 °C
		C:05	210 °C
		C:06	220 °C
		C:07	230 °C
		C:08	240 °C
		C:09	250 °C
P:18	Empty cookware protection with manual cooking and frying	C:00	Off
		C:01	On

Adjusting settings

Programme ¹		Code ²	Settings
P:19	Frying level temperature ①	C:00	140 °C
		C:01	145 °C
		C:02	150 °C
		C:03	155 °C
		C:04	160 °C
		C:05	165 °C
		C:06	170 °C
		C:07	175 °C
		C:08	180 °C
P:20	Frying level temperature ②	C:00	180 °C
		C:01	185 °C
		C:02	190 °C
		C:03	195 °C
		C:04	200 °C
		C:05	205 °C
		C:06	210 °C
		C:07	215 °C
		C:08	220 °C
P:21	Frying level temperature ③	C:00	200 °C
		C:01	205 °C
		C:02	210 °C
		C:03	215 °C
		C:04	220 °C
		C:05	225 °C
		C:06	230 °C
		C:07	235 °C
		C:08	240 °C

Adjusting settings

Programme ¹		Code ²	Settings
P:25	Keeping warm Plus temperature	C:00	50 °C
		C:01	55 °C
		C:02	60 °C
		C:03	65 °C
		C:04	70 °C
		C:05	75 °C
		C:06	80 °C
		C:07	85 °C
		C:08	90 °C

¹ Unlisted programmes are not assigned.

² The factory-set code is shown in bold.

³ After the hob has been switched on *dE* appears in the timer display for a few seconds.

⁴ In the text and charts, the extended power levels are shown with a dot after the number for better understanding.

⁵ The audible tone for the On/Off sensor control cannot be switched off.

Safety notes on cleaning and care

 Risk of burns due to hot surfaces.

All parts of the hob may be hot after use.

Switch the hob off.

Allow the hob to cool down before cleaning it.

All surfaces could be discoloured or damaged if unsuitable cleaning agents are used or if residues from suitable cleaning agents are heated on the hob. All surfaces are susceptible to scratching.

Allow the surfaces to cool down before cleaning the hob.

Remove all cleaning agent residues immediately.

Never use abrasive sponges or cleaning agents.

- ▶ Do not use a steam cleaner to clean the hob.
- ▶ Do not use pointed objects for cleaning.

Cleaning and care

When to clean

- Clean the hob after every use.

Removing light soiling

- Clean the entire ceramic surface of the hob with a damp, soft cloth and a solution of water and a little washing-up liquid. Please follow the cleaning agent manufacturer's instructions.

Removing stubborn soiling

- Remove any coarse soiling with a damp cloth and more stubborn soiling with a scraper suitable for use on glass.
- Clean the glass ceramic surface with the Miele ceramic and stainless steel cleaner (see "Optional accessories – Cleaning and care products") or with a proprietary ceramic glass cleaner. Please follow the cleaning agent manufacturer's instructions.

Finishing the cleaning process

- Remove all cleaning agent residues with a damp cleaning cloth.
- Dry the ceramic surface of the hob after cleaning.

Unsuitable cleaning agents

To avoid damaging the surfaces of the appliance, do not use:

- Cleaning agents containing soda, alkalines, ammonia, acids or chlorides
- Stain and rust removers
- Abrasive cleaning agents, e.g. powder cleaners and cream cleaners
- Cleaning agents containing solvents
- Dishwasher cleaning agents
- Grill and oven sprays
- Hard, abrasive brushes
- Eraser stain remover blocks
- Sponges

Messages in the display

Problem	Cause and remedy
<i>Err</i> will flash alternately with 30 in the timer display and a tone will sound.	<p>The hob is incorrectly connected.</p> <ul style="list-style-type: none"> ■ Disconnect the hob from the mains electricity supply. ■ Contact the Customer Service Department. The hob must be connected to the mains according to the wiring diagram.
After the hob has been switched on, or after touching a sensor, <i>LDC</i> appears in the timer display for a few seconds.	<p>The system lock is activated.</p> <ul style="list-style-type: none"> ■ Deactivate the system lock (see “Operation – Deactivating the system lock”).
	<p>The safety lock is activated.</p> <ul style="list-style-type: none"> ■ Deactivate the safety lock (see “Operation – Deactivating the safety lock”).
After the hob has been switched on, <i>dE</i> appears briefly in the timer display. The cooking zones do not heat up.	<p>The hob is in demo mode.</p> <ul style="list-style-type: none"> ■ Press the 0 sensor control on any numerical display. ■ Then touch the 0 and 2 sensor controls at the same time until <i>dE</i> flashes alternately with <i>OFF</i> in the timer display.
The hob has switched off automatically. When the appliance is switched back on, <i>L</i> appears above the On/Off ① sensor control.	<p>One or more of the sensor controls are covered, e.g. by finger contact, food boiling over or an object.</p> <ul style="list-style-type: none"> ■ Clean off any soiling and/or remove the object (see “Familiarisation – Safety switch-off”).
<i>Err</i> will flash alternately with 044 in the timer display.	<p>The overheating protection mechanism has been activated.</p> <ul style="list-style-type: none"> ■ Allow the hob to cool down. ■ Rectify the causes of the overheating (see “Familiarisation – Overheating protection”). ■ Check that the hob is working. ■ If this fault message continues to appear in the display, contact the Customer Service Department.
<i>Err</i> will flash alternately with 047, 048 or 049 in the timer display.	<p>The fan is blocked or defective.</p> <ul style="list-style-type: none"> ■ Make sure it has not been blocked by an object. ■ Remove the obstruction. ■ If this fault message continues to appear in the display, contact the Customer Service Department.

Troubleshooting

Problem	Cause and remedy
In the timer display E-number, e.g. E-O, will flash alternately with 120, 121, 122, 123, 124, 125, 126 or 127.	The fan is blocked or defective. <ul style="list-style-type: none">■ Make sure it has not been blocked by an object.■ Remove the obstruction.■ If this fault message continues to appear in the display, contact the Customer Service Department.
A message not listed in this table is appearing in the timer display.	There is an electronic module fault. <ul style="list-style-type: none">■ Disconnect the power supply to the hob for approx. 1 minute.■ If the problem persists after the power supply has been restored, please contact the Customer Service Department.

Unexpected behaviour

Problem	Cause and remedy
The power level selected is flashing.	No cookware is present on the cooking zone. Unsuitable cookware is present on the cooking zone. The diameter of the base of the cookware is too small. Suitable cookware has been removed from the cooking zone. If no cookware or unsuitable cookware is placed on the cooking zone, the cooking zone will switch off automatically after 3 minutes. <ul style="list-style-type: none">■ Place a suitable item of cookware on the cooking zone within 3 minutes. The power level will stop flashing. The cooking process starts/continues with the previously selected settings. <ul style="list-style-type: none">■ If you are using a different item of cookware and/or food, modify the settings.
Power level 9 is automatically reduced if you also set power level 9 for the connected cooking zone.	Operating both zones at power level 9 exceeds the permitted maximum power for the two zones. <ul style="list-style-type: none">■ Use a different cooking zone.

Problem	Cause and remedy
<p>A cooking zone or the whole hob switches off automatically.</p>	<p>It has been operated for too long.</p> <ul style="list-style-type: none"> ■ Switch the hob or the cooking zone back on (see “Familiarisation – Safety switch-off”). <hr/> <p>The overheating protection mechanism has been activated.</p> <ul style="list-style-type: none"> ■ Allow the hob to cool down. ■ Rectify the causes of the overheating (see “Familiarisation – Overheating protection”). ■ Check that the hob is working. ■ If the problem occurs again, contact the Customer Service Department.
<p>The cooking zone is not working in the usual way with the set power level.</p>	<p>The overheating protection mechanism has been activated.</p> <ul style="list-style-type: none"> ■ Allow the hob to cool down. ■ Rectify the causes of the overheating (see “Familiarisation – Overheating protection”). ■ Check that the hob is working. ■ If the problem occurs again, contact the Customer Service Department.
<p>A cooking zone or the whole hob switches off automatically.</p>	<p>The overheating protection mechanism has been activated.</p> <ul style="list-style-type: none"> ■ Allow the hob to cool down. ■ Rectify the causes of the overheating (see “Familiarisation – Overheating protection”). ■ Check that the hob is working. ■ If the problem occurs again, contact the Customer Service Department.
<p>The Booster level has deactivated early automatically.</p>	<p>The overheating protection mechanism has been activated.</p> <ul style="list-style-type: none"> ■ Allow the hob to cool down. ■ Rectify the causes of the overheating (see “Familiarisation – Overheating protection”). ■ Check that the hob is working. ■ If the problem occurs again, contact the Customer Service Department.

Troubleshooting

Unsatisfactory results

Problem	Cause and remedy
The food in the pan does not heat up when the Auto heat-up function is switched on.	A large amount of food is being heated up. <ul style="list-style-type: none"> ■ Start cooking at the highest power level and then turn down to a lower one manually later on.
	The pan is not conducting heat properly. <ul style="list-style-type: none"> ■ Use a different pot or pan which conducts heat properly.

General problems or technical faults

Problem	Cause and remedy
The hob or cooking zones will not switch on.	There is no power to the hob. <ul style="list-style-type: none"> ■ Check whether the circuit breaker has tripped. Contact a qualified electrician or the Miele Customer Service Department (for the minimum fuse rating, see data plate).
	There may be a technical fault. <ul style="list-style-type: none"> ■ Disconnect the hob from the electricity supply for approx. 1 minute. To do this: <ul style="list-style-type: none"> – tripping the relevant mains fuse or screwing the fine-wire fuse out completely, or – switching off at the residual current device. ■ If the hob will still not turn on after resetting the trip switch in the fuse box or the residual current device, contact a qualified electrician or the Miele Customer Service Department.
A smell and vapours are given off when the new appliance is being used.	The metal components have a protective coating. When the appliance is used for the first time, this causes a smell and possibly also vapour. The material from which the induction coils are made also gives off a smell in the first few hours of operation. With each subsequent use, the odour is reduced until it disappears completely. The smell and any vapours given off do not indicate a faulty connection or appliance and they are not hazardous to health.
An operating noise can be heard after the appliance has been switched off.	The cooling fan runs until the hob has cooled down and then switches off automatically.

Information to help you rectify faults yourself and about Miele spare parts can be found at www.miele.com/service.

Contact in the event of a fault

In the event of a fault which you cannot remedy yourself, please contact your Miele dealer or Miele Customer Service.

You can book a Miele Customer Service call-out online at www.miele.com/service.

Contact information for Miele Customer Service can be found at the end of this document.

Please quote the model identifier and serial number of your appliance (SN) when contacting Miele Customer Service. These can be found on the data plate or see "Operation – Hob data".

Data plate

Stick the extra data plate supplied with the appliance here. Make sure that the model number matches the one specified on the back cover of this document.

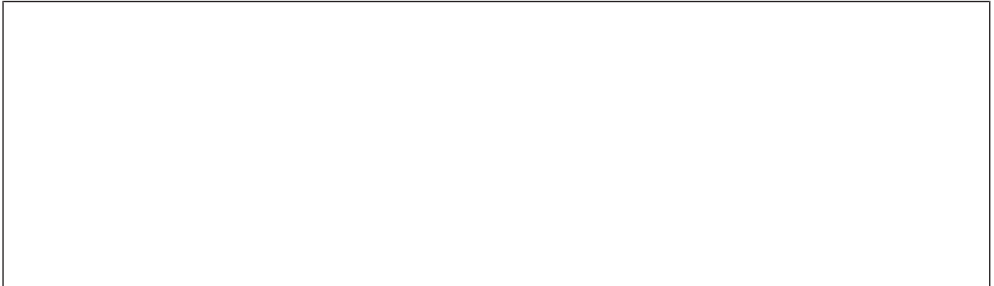

Guarantee

For information on the appliance guarantee specific to your country please contact Miele. See end of this booklet for contact details.

After sales service

Test food acc. to EN 60350-2

9 power levels are programmed at the factory.

For testing in accordance with the above standard, programme the hob to the extended power level setting (see “Adjusting settings”).

Test food	Ø Pan base (mm)	Lid	Power level	
			Pre-heat	Cook
Heating oil up	150	No	–	1–2
Pancakes	180 (Sandwich base)	No	9	5.–7.
Frying deep frozen chips	According to the standard	No	9	9

Miele offer a comprehensive range of useful accessories as well as cleaning and conditioning products for your Miele appliances.

These products can be ordered through the Miele Webshop.

They can also be ordered from Miele (see end of this booklet for contact details) or from your Miele dealer.

Cookware

Miele offers a wide range of cookware. These have all been optimised for Miele appliances in terms of functionality and dimensions. Detailed information is provided on the Miele website.

Cleaning and care products

Ceramic and stainless steel hob cleaner 250 ml

Removes heavy soiling, limescale deposits and aluminium residues.

Microfibre cloth

For removing finger marks and light soiling.

Installation

Safety notes for installation

 Risk of damage from incorrect installation.
Incorrect installation can cause damage to the hob.
The hob must only be installed by a qualified specialist.

 Risk of electric shock from mains voltage.
Incorrect connection to the mains supply may result in an electric shock.
The hob must be connected to the electrical supply by a qualified electrician only.

 Damage from falling objects.
Take care not to damage the hob when fitting wall units or a cooker hood above it.
Fit the wall units and the cooker hood before the hob.

Dismantling the hob for service purposes may damage the sealing strip underneath the edge of the hob.
Always replace the sealing strip before reinstalling.

- ▶ The hob must not be installed over a fridge, fridge-freezer, freezer, dishwasher, washing machine, washer-dryer or tumble dryer.
- ▶ This hob may only be installed above a cooker or oven if they have a built-in cooling fan.
- ▶ After installation, ensure that nothing can come into contact with the connection cable and that it is without hindrance.
- ▶ The electrical cable may not come into contact with any moving kitchen component (e.g. a drawer) or be subject to mechanical obstruction which could damage it.
- ▶ The veneer or laminate coatings of worktops (or adjacent kitchen units) must be treated with 100 °C heat-resistant adhesive which will not dissolve or distort. Any backmoulds must be of heat-resistant material.
- ▶ Remember to maintain the minimum safety distances (see “Installation – Safety distances”).

Additional safety notes for surface-mounted installation

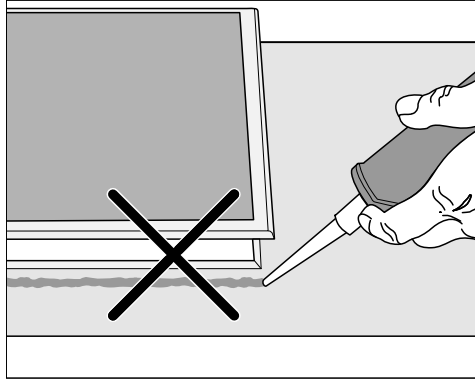

⚠ Damage caused by incorrect installation.

Using sealant under the hob could result in damage to the hob and the worktop if the hob ever needs to be removed.

Do not use sealant between the hob and the worktop.

The sealing strip under the edge of the hob provides a sufficient seal for the worktop.

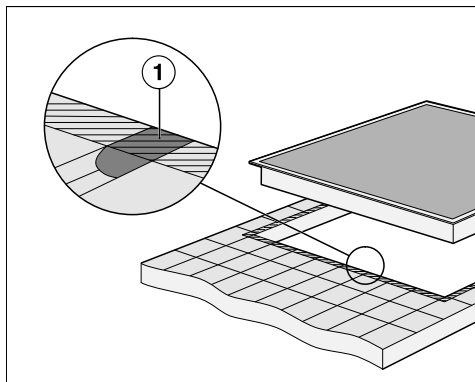

► Grout lines ① and the hatched area underneath the hob frame must be smooth and even. If they are not, the hob will not sit flush with the worktop and the sealing strip underneath the hob will not provide a good seal between the hob and the worktop.

Installation

Additional safety notes for flush-fit installation

 Damage from unsuitable sealant.

Unsuitable sealant can damage natural stone.

For natural stone worktops and natural stone tiles, only use silicone sealant that is specially formulated for natural stone. Follow the manufacturer's instructions.

► The internal width of the base unit underneath the appliance must be at least as wide as the inner worktop cut-out (see “Installation – Building-in dimensions for flush-fit installation”), so that the hob is easily accessible from underneath after installation and the casing can be removed for maintenance. If the underside of the hob is not freely accessible after installation, any sealant used must be removed to enable the hob to be lifted out of the cut-out should this be necessary.

► A flush-fit hob is suitable only for installation in natural stone (granite, marble), solid wood and tiled worktops. When using a worktop made from any other material, please check first with the worktop manufacturer that the material is suitable for installing a flush-fit hob.

- Natural stone worktops: the hob is set directly in the cut-out.
- Solid wood worktops, tiled worktops: the hob is secured inside the cut-out with wooden battens. The battens must be provided on site and are not included in the scope of delivery.

Safety distances

Safety distance above the hob

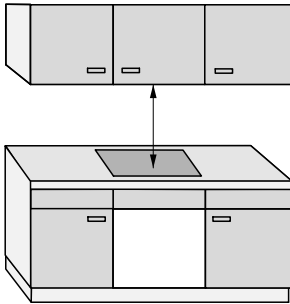

The following must be ensured between the hob and the cooker hood above it:

- The safety distance specified by the manufacturer of the cooker hood must be maintained.
- When two or more appliances which have different safety distances are installed together below a cooker hood, the greatest specified safety distance must be maintained.

If combustible objects are installed above the hob (e.g. cabinets, utensil rail, etc.), a minimum safety distance of 500 mm must be maintained.

Installation

Safety distance behind and to the side of the hob

The minimum safety distances shown below must be maintained between the appliance and a tall unit or wall:

- Between the **back** ① of the worktop cut-out and the rear edge of the worktop:
50 mm
and
- On the **right side** ② between the worktop cut-out and the closest adjacent piece of furniture (e.g. tall unit) or a room wall:
50 mm and on the opposite side a minimum safety distance of 200 mm
or
- On the **left side** ③ between the worktop cut-out and the closest adjacent piece of furniture (e.g. tall unit) or a room wall:
50 mm and on the opposite side a minimum safety distance of 200 mm

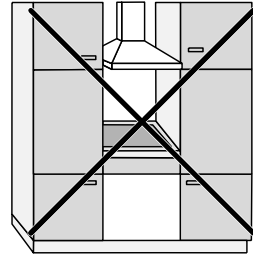

Not permitted

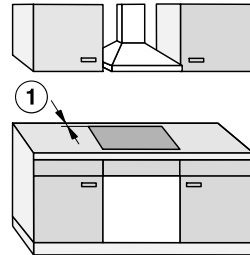

Highly recommended

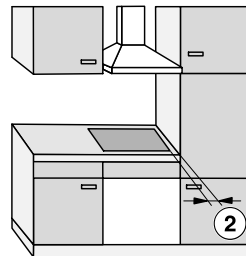

Not recommended

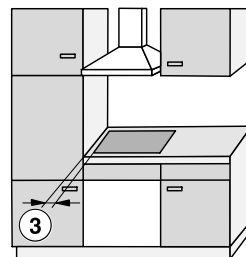

Not recommended

Safety distance underneath the hob

To install the hob while maintaining the safety distances, you can choose from 3 variants:

1. Without intermediate shelf or base panel
2. With intermediate shelf
3. With an air intake-optimised base panel

Further instructions are described in the relevant section.

An air intake-optimised base panel and an intermediate shelf cannot be combined.

If they are combined, more warm air is drawn in. The hob is not adequately cooled.

The hob is ventilated from below. A drawer underneath the hob is heated.

If you wish to install a drawer underneath the hob, we recommend installing the hob with an air intake-optimised base panel to reduce the waste heat from the hob.

Rear wall cut-out

For ventilation and **accommodating the mains connection cable**, you will need to create a cut-out in the rear wall.

Create a cut-out in the rear wall using the following instructions:

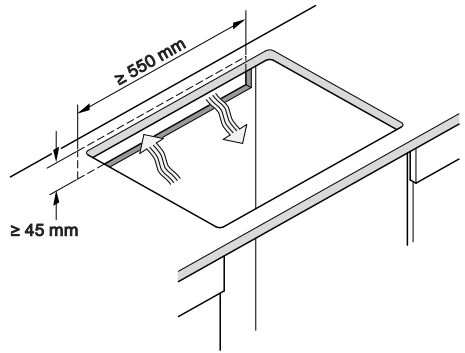

Installation

1. Without intermediate shelf or base panel

To ensure sufficient ventilation to the hob, a minimum safety distance must be left between the underside of the hob and any drawer or oven.

The minimum safety distance between the underside¹ of the hob and:

- Upper edge of drawer: ≥ 5 mm
- Base of drawer: ≥ 75 mm
- Upper edge of oven: ≥ 15 mm

¹ The underside is the outside of the hob casing. Other items that are attached lower down, such as connection boxes and shims, do not count as the lowest point and are not relevant when calculating the minimum safety distance.

2. Intermediate shelf

The dimensions in brackets are recommendations.

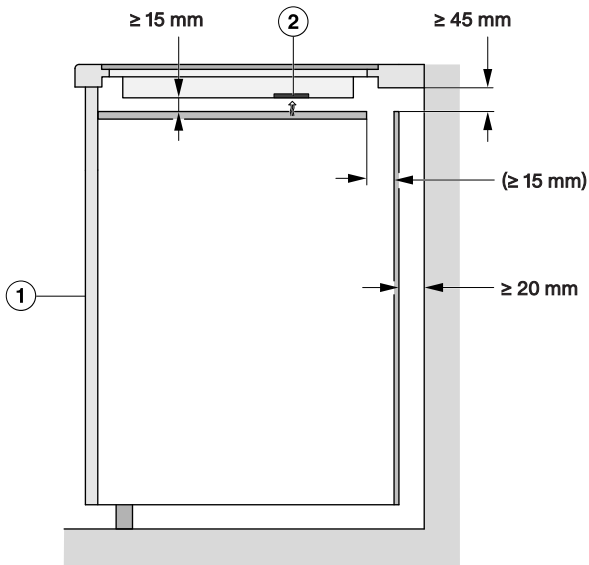

Side view

① Front

② Fan

3. Air intake-optimised base panel

The performance of the hob depends on the ventilation.

The air intake-optimised base panel has openings where the fans are positioned. This section contains instructions for creating an air intake-optimised base panel.

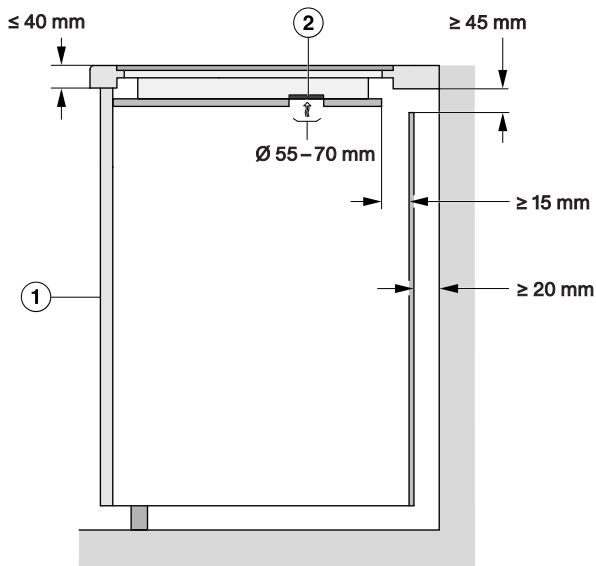

Side view

① Front

② Fan

To ensure sufficient ventilation to the hob, a minimum safety distance must be left between the underside of the air intake-optimised base panel and any drawer.

Minimum safety distance between the **underside of the air intake-optimised base panel** to the:

- Upper edge of drawer: $\geq 5\text{ mm}$
- Base of drawer: $\geq 75\text{ mm}$
- Upper edge of intermediate shelf: not permitted

There must be no gap between the air intake-optimised base panel and the hob. A gap causes more warm air to be drawn in. The hob is not adequately cooled.

Installation

Positions and cut-outs of the ventilation openings

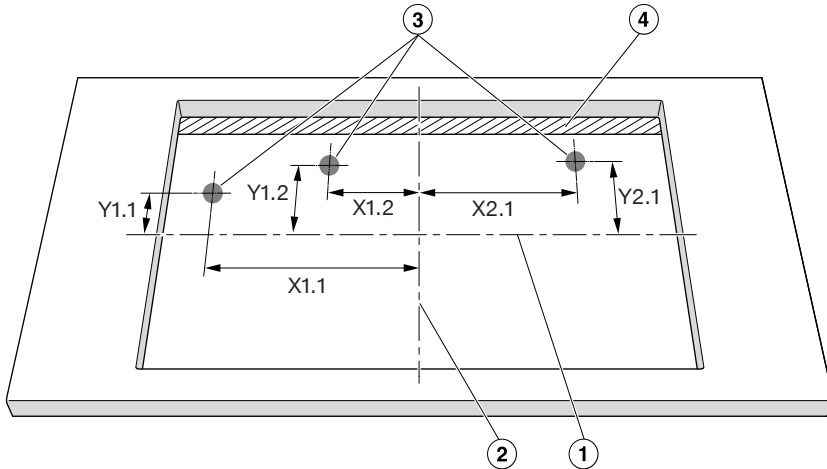

Not to scale. View from above. Surface-mounted cut-out shown. Also applies to flush-fit installation.

- ① Middle of the cut-out height
- ② Middle of the cut-out width
- ③ Cut-out for fan, round (\varnothing 55–70 mm)
- ④ Gap (\geq 15 mm)

X1.1	Y1.1	X1.2	Y1.2	X2.1	Y2.1
Distance from the middle of the cut-out in mm					
164	108	251	81	167	93

Position the hob so that the fans are above the cut-outs.
 If the fans are not positioned above the cut-outs, the air flow may be obstructed.
 The hob is not adequately cooled.

Safety distance from the niche cladding

If niche cladding is installed, a minimum safety distance must be maintained between the worktop cut-out and the cladding. High temperatures can alter or damage these materials.

Flush-fit installation

Surface-mounted installation

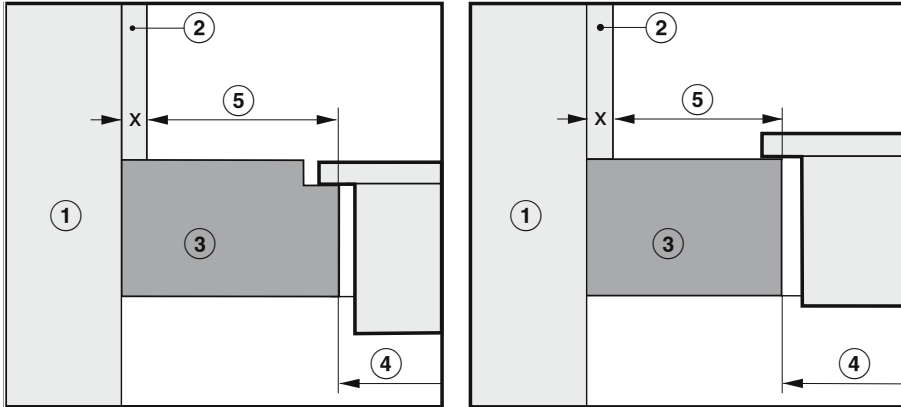

- ① Masonry
- ② Dimension x = thickness of the niche cladding material
- ③ Worktop
- ④ Worktop cut-out
- ⑤ Minimum safety distance to
 - combustible materials** (e.g. wood)
 - non-combustible materials** (e.g. metal, natural stone, ceramic tiles)

	Side		Opposite side	
Material	Combustible	Non-combustible	Combustible	Non-combustible
Back	50 mm	50 mm minus dimension x	–	–
Right	50 mm	50 mm minus dimension x	200 mm	200 mm minus dimension x
Left	50 mm	50 mm minus dimension x	200 mm	200 mm minus dimension x

See “Installation – Safety distances”

Example: 15 mm thick non-combustible niche cladding

50 mm minus 15 mm = minimum safety distance of 35 mm

Installation

Building-in dimensions for surface-mounted installation

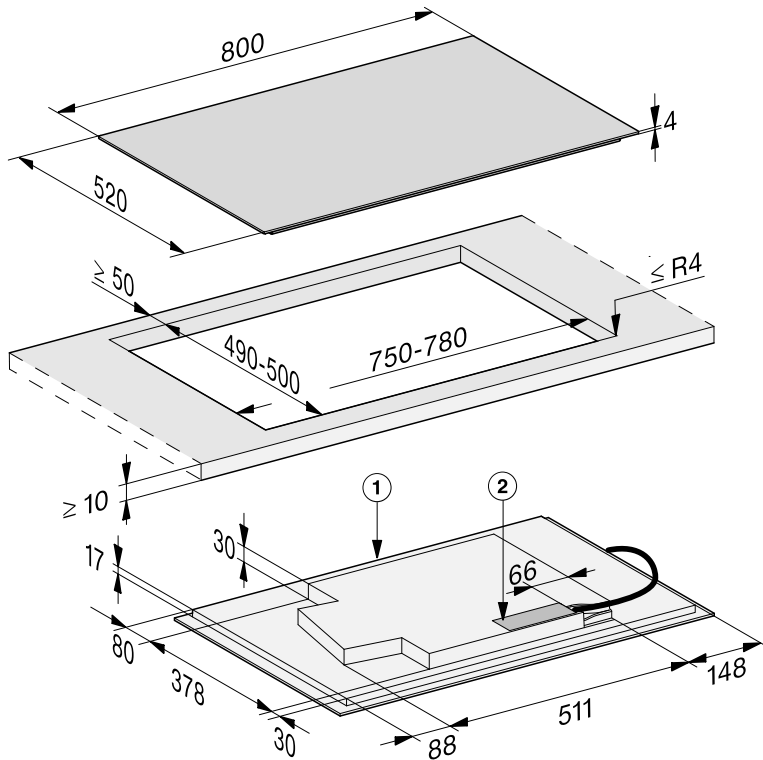

All dimensions are given in mm.

① Front

② Mains connection box

The mains connection cable (L = 1,440 mm) is supplied loose

Installation dimensions for flush-fit installation

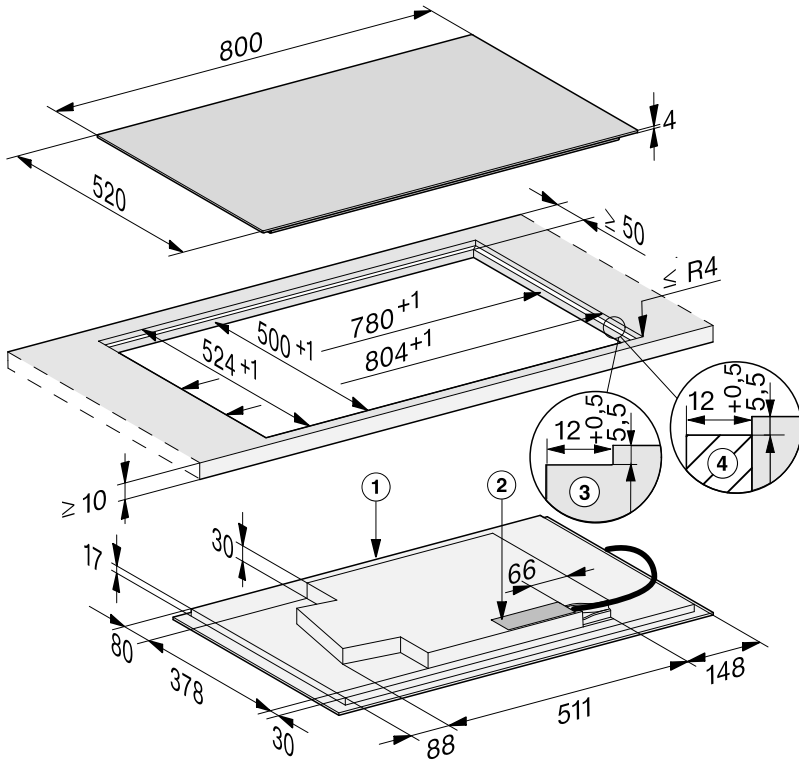

All dimensions are given in mm.

- ① Front
- ② Mains connection box
The mains connection cable (L = 1,440 mm) is supplied loose
- ③ Stepped cut-out, natural stone worktop
- ④ Wooden batten 12 mm (not supplied)

Installation

Installing a surface-mounted hob

Preparing the worktop for surface-mounted installation

- Remember to maintain the minimum safety distances (see “Installation – Safety distances”).
- Create the worktop cut-out.
- Wooden worktops:
Seal any cut surfaces with a special varnish, silicone sealant or resin to prevent the wood from swelling as a result of moisture ingress. The sealant must be heat-resistant.

Make sure that the sealant does not come into contact with the top of the worktop.

Installing a surface-mounted hob

- Attach the sealing strip provided underneath the edge of the hob. Do not apply the sealing strip under tension.

 Risk of damage from incorrect connection.

The hob electronic module may be damaged if a short circuit occurs. The mains connection cable must be connected to the hob by a qualified electrician.

- Connect the mains connection cable to the hob by following the instructions in the wiring diagram (see “Installation – Electrical connection”).
- Feed the mains connection cable for the hob down through the worktop cut-out.
- Place the hob centrally in the cut-out. When doing this, make sure that the sealing strip of the appliance sits flush with the worktop on all sides. This is important to ensure an effective seal all round.
- If the sealing strip does not sit flush with the worktop in the corners, the corner radius ($\leq R4$) can be carefully cut to fit using a jigsaw.
- If an air intake-optimised base panel is installed, position the hob so that the fans are located above the cut-outs.
- Connect the hob to the electricity supply (see “Installation – Electrical connection”).
- Check that the hob is working.

Installing the hob flush with the worktop

Preparing the worktop for flush-fit installation

- Remember to maintain the minimum safety distances (see “Installation – Safety distances”).
- Create the worktop cut-out.
- Solid wood and tiled worktops:
Fix the wooden battens 5,5 mm below the top edge of the worktop (see “Installation – Installation dimensions for flush-fit installation”).

Installing a flush-fit hob

- Attach the sealing strip provided underneath the edge of the hob. Do not apply the sealing strip under tension.

 Risk of damage from incorrect connection.

The hob electronic module may be damaged if a short circuit occurs. The mains connection cable must be connected to the hob by a qualified electrician.

- Connect the mains connection cable to the hob by following the instructions in the wiring diagram (see “Installation – Electrical connection”).
- Feed the power cable for the hob down through the worktop cut-out.

The gap between the ceramic surface and the worktop must be at least 2 mm wide.

This is required so that the hob can be sealed.

- Centre the hob in the cut-out.
- If an air intake-optimised base panel is installed, position the hob so that the fans are located above the cut-outs.
- Connect the hob to the electricity supply (see “Installation – Electrical connection”).
- Check that the hob is working.
- Seal the gap between the hob and worktop with a silicone sealant that is heat-resistant to at least 160 °C.

Installation

Electrical connection



Risk of damage from incorrect connection.

Unauthorised installation, maintenance and repairs can cause considerable danger for the user. Miele cannot be held liable for damage or injury caused by unauthorised installation, maintenance or repair work, or by an inadequate or faulty on-site earthing system (e.g. electric shock).

This hob must be connected to the electrical supply by a qualified electrician.

The electrician must be familiar with and comply with the national regulations and any additional regulations of the local electricity provider.

After installation, ensure that all electrical components are shielded and cannot be accessed by users.

Total power rating

See data plate

Connection data

The connection data is quoted on the data plate. Please ensure these match the household mains supply.

Please see wiring diagrams for connection.

Residual current device

For extra safety, it is advisable to protect the appliance with a suitable residual current device (RCD) with a trip range of 30 mA.

Disconnecting devices

It must be possible to disconnect the hob from the mains at all poles using disconnecting devices. A contact distance of at least 3 mm must be observed in the switched-off state. The disconnecting devices are overcurrent protection devices and residual current protection devices.

Disconnecting from the mains



Risk of electric shock.

There is a risk of electric shock if the appliance is connected to the mains supply during repair or service work. After disconnection, ensure the appliance cannot be switched back on by mistake.

To disconnect the appliance from the mains power supply, do one of the following depending on installation:

Safety fuses

- Completely remove fuses.

Automatic circuit breakers

- Press the (red) test button until the middle (black) button springs out.

Built-in circuit breakers

- Circuit breakers at least type B or C: Switch the lever from 1 (on) to 0 (off).

Residual current device (RCD)

- Switch the main switch from 1 (on) to 0 (off) or press the test button.

Mains connection cable

The hob must be connected to the electrical supply with a special connection cable, type H 05 VV-F (PVC insulated) with a suitable diameter.

Please see wiring diagrams for connection. (N.B. This appliance is supplied single phase only in the UK / AUS / NZ).

See the data plate on the hob for the correct voltage and rated load.

Replacing the mains connection cable



Risk of electric shock.

Incorrect connection to the power supply may result in an electric shock.

The mains cable must only be replaced by a qualified electrician.

When replacing the mains cable only use cable type H 05 VV-F (PVC insulated) with a suitable cross section. A suitable connection cable is available to order from Miele.

Installation

Wiring diagram

Some connection methods are not permitted in all installation locations. Ensure compliance with national regulations and any additional regulations issued by the local electricity provider.

The maximum load per connected live conductor is 3650 W.

Hob with < 5 cooking zones (≤ 7400 W)

The first and second live conductors are required for connecting the hob. Further appliances can be connected to the third live conductor.

Hob with ≥ 5 cooking zones (> 7400 W)

All 3 live conductors are required for connecting the hob. No further appliances can be connected to the live conductors.

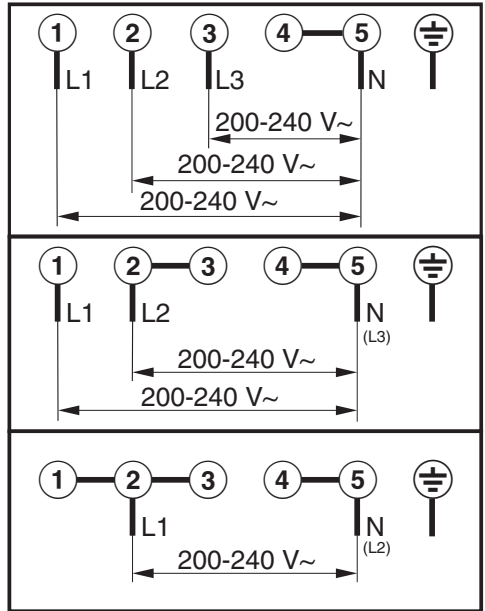

Hong Kong, China
Miele (Hong Kong) Ltd.

41/F - 4101, Manhattan Place
23 Wang Tai Road
Kowloon Bay
Hong Kong
Tel: (852) 2610 1025
Fax: (852) 3579 1404
E-mail: customerservices@miele.com.hk
Website: www.miele.hk

Miele Experience Centre

UG/F & 1/F, Henry House
42 Yun Ping Road
Causeway Bay
Hong Kong
Tel: (852) 2890 1018
Fax: (852) 3579 1401
E-mail: ExperienceCentre@miele.com.hk

International Head Office

Miele & Cie. KG
Carl-Miele-Straße 29
33332 Gütersloh
Germany

Hong Kong, China
Miele (Hong Kong) Ltd.

香港九龍灣宏泰道23號
Manhattan Place 41樓4101室
電話: (852) 2610 1025
傳真: (852) 3579 1404
電郵地址: customerservices@miele.com.hk
網址: www.miele.hk

Miele陳列室

香港銅鑼灣恩平道42號亨利中心UG及一樓
電話: (852) 2890 1018
傳真: (852) 3579 1401
電郵地址: ExperienceCentre@miele.com.hk

KM 7679-1 FL

en-HK

M.-Nr. 12 610 540 / 01