















Operating instructions Commercial washing machine PWM 927 PWM 935

Always read the operating instructions before setting up, installing and commissioning the machine. This prevents both personal injury and damage to the machine.

en-IE

Contents

Safety instructions and warnings	6
Explanation of the safety notes and warnings on the machine	6
Appropriate use	6
Foreseeable misuse	7
Technical safety	7
Correct use.....	9
Chlorine and component damage.....	10
Accessories	10
Caring for the environment	11
Description of the machine	12
Description of the machine.....	12
Control panel.....	13
Operation	14
Sensor controls and touch display.....	14
Main menu	14
Examples of how to operate the machine	14
Operating a laundrette machine.....	17
Washing	18
Preparing for use	18
Loading and switching on the washing machine	19
Washing with detergent drawer	19
Selecting a programme	21
Selecting programme settings	22
Selecting Extras.....	27
Pre-wash 	27
Soak 	27
Rinse plus 	27
Rinse hold 	27
Filling stop 	27
Intensive 	27
Water plus 	28
Programme start – programme end	28
Timer	30
Special features in the programme sequence	31
Spinning.....	31
Anti-crease	31
Skip.....	31
Manual control.....	31
Switching to manual control	31
Water intake 	33
Dispensing 	33
Washing and heating 	33
Drain with agitation 	33
Spin 	33
Function combinations	33
Weighing system	35
Resetting the load display to zero	35

Changing the programme sequence	36
Changing a programme	36
Altering the wash programme.....	36
Interrupting a programme	36
Switching on the washing machine after an interruption to the power supply	36
Adding or removing laundry	37
Problem solving guide	38
Troubleshooting	38
Contact in case of malfunction.....	40
Problem solving guide.....	40
The wash programme does not start	40
Programme cancellation and fault message	41
The display shows a message	41
Insufficient wash results	42
General problems with the washing machine.....	43
The door will not open or close	44
To continue a programme after an interruption to the power supply	44
Cleaning and care	45
Build-up of rust.....	45
Cleaning the detergent drawer, detergent compartments and siphons	46
Installation	48
Installing the washing machine	48
Securing the machine	48
General operating conditions	48
For easy maintenance.....	49
Water connection.....	50
UK, Australia and New Zealand only	50
Steam connection	51
Dispensing pump connections.....	52
Drainage.....	53
Electrical connection	53
Supervisor level	54
Opening the supervisor level	54
Opening the Supervisor level (self-service)	54
Access via code	54
Changing the code	54
Closing the Settings menu.....	54





Contents

Controls / Display.....	55
Language.....	55
Language entry.....	55
Set languages.....	56
Time.....	56
Date.....	56
Logo.....	56
Start screen.....	56
Mode.....	56
Display brightness.....	56
Display off status.....	56
Appliance off status.....	57
Volume.....	57
Visibility parameters.....	57
Delay start.....	57
Memory.....	57
Manual control.....	57
Change order.....	57
Measuring system.....	57
Supervisor code.....	57
WiFi.....	58
Programme selection.....	58
Controls.....	58
Programme packages.....	58
Favourite programmes.....	58
Sort programmes.....	59
Prog. colour allocation.....	59
Expert code.....	59
Process technology.....	59
Anti-crease.....	59
Automatic drainage.....	59
Service.....	60
Service interval.....	60
External applications.....	60
Payment system lock.....	60
Connector box.....	60
FOC programmes.....	60
WRG.....	60
Automatic dispensing.....	60
Dosage.....	60
Peak load prevention.....	61
WiFi.....	61
Appliance parameters.....	61
Maximum spin speed.....	61
Max. possible temperature.....	61
Legal information.....	61
Payment system.....	61
Setting for payment systems.....	61

Connectivity	62
Pairing instructions	62
Network connection.....	62
Opening the supervisor level	62
Initial network setup.....	62
Setting up a network connection manually	63
Establishing the network connection via WPS	64
Establishing the network connection via soft AP	65
Establishing the network connection using a LAN cable.....	65
WiFi/LAN interface configured.....	66
Technical data	66
Technical data	68
PWM 927 machine data	68
Installation dimensions.....	68
Electrical connection.....	68
Weight and floor load.....	68
Emission values.....	68
Product safety	68
WiFi.....	68
PWM 935 machine data.....	69
Installation dimensions.....	69
Electrical connection.....	69
Weight and floor load.....	69
Emission values.....	69
Product safety	69
WiFi.....	69
EU declaration of conformity.....	70
UK declaration of conformity.....	70
WiFi data protection	71
Data protection and data security	71
Factory default settings for network configuration	71
Copyright and licences	71

Safety instructions and warnings

Explanation of the safety notes and warnings on the machine

	Read the operating instructions
	Warning, hot surfaces
	Warning, voltage up to 1000 volts
	Protective earthing
	Equipotential bonding

This washing machine complies with all current local and national safety requirements. Inappropriate use can, however, lead to personal injury and material damage.

Read the operating instructions carefully before using the washing machine. They contain important information on safety, installation, use and maintenance. This prevents both personal injury and damage to the washing machine.

Miele expressly and strongly advises that you read and follow the instructions in the section on installing the washing machine as well as the safety notes and warnings.

Miele cannot be held liable for injury or damage caused by non-compliance with these instructions.

Keep these operating instructions in a safe place and pass them on to any future owner.

When instructing other people how to use the washing machine, they must be made aware of these safety notes and warnings.

Appropriate use

- ▶ The washing machine is only suitable for washing fabrics with a care label stating that they are suitable for machine washing. Any other applications may be dangerous. The manufacturer cannot be held liable for damage resulting from incorrect or improper use or operation of the machine.
- ▶ This washing machine must be used as described in the operating instructions and must be checked on a regular basis to make sure it is functioning correctly. Maintenance must be carried out when necessary.
- ▶ The washing machine is not suitable for outdoor use.
- ▶ Do not install the washing machine in a room where there is a risk of frost. Frozen hoses are at risk of tearing or bursting. The reliability of the electronic module may be impaired at temperatures below freezing point.
- ▶ This washing machine is intended only for use in a commercial environment.

- ▶ If the machine is used in a commercial environment it may only be operated by instructed/trained personnel. If the machine is used in a publicly accessible area, the supervisor must ensure that it can be operated safely without risk of danger.
- ▶ The washing machine must not be used in a non-stationary installation site (e.g. on a ship).
- ▶ This washing machine can only be used by people with reduced physical, sensory or mental capabilities, or lack of experience or knowledge, if they are supervised whilst using it or have been shown how to use it in a safe way and understand and recognise the consequences of incorrect operation.
- ▶ Children under the age of 8 must not be allowed near the washing machine unless they are constantly supervised.
- ▶ Children over the age of 8 may only use the washing machine without supervision if its operation has been clearly explained to them and they are able to use it safely. Children must be able to understand and recognise the possible dangers caused by incorrect operation.
- ▶ Children may not carry out cleaning or maintenance on the washing machine unsupervised.
- ▶ Always supervise any children in the vicinity of the washing machine. Never allow children to play with the washing machine.
- ▶ Disinfection programmes must not be interrupted, as this can have a limiting effect on the disinfection result. It is the operator's responsibility to ensure that the standard of disinfection in thermal as well as chemo-thermal procedures is maintained by carrying out suitable validation tests.

Foreseeable misuse

- ▶ Never use solvent-based cleaning agents, e.g. those containing benzene, in this machine. Doing so may result in damage to component parts and create toxic steam and fumes. **Risk of fire and explosion!**
 - ▶ Do not damage, remove or bypass the safety features or control elements of this washing machine.
 - ▶ Water used for washing in this machine consists of suds and is not drinking water! Drain the suds into a proper drainage system.
 - ▶ Always make sure that the drum is stationary before reaching in to remove laundry. Reaching into a moving drum is extremely dangerous.
 - ▶ Be careful not to put your hands in the gap between door and frame when closing the drum door.
- Please note:** the drum door is locked automatically as soon as the washing machine starts.
- ▶ It is particularly important to follow the manufacturer's instructions when using a combination of cleaning agents and special application products. Products must only be used for applications approved by the manufacturer to avoid any material damage or the occurrence of strong chemical reactions.

Technical safety

- ▶ Before setting up the washing machine, check it for any externally visible damage. Do not install or use a damaged washing machine.

Safety instructions and warnings

▶ The electrical safety of this washing machine can only be guaranteed when correctly earthed. It is most important that this basic safety requirement is tested and in case of any doubt the on-site wiring system should be inspected by a specialist. Miele cannot be held liable for the consequences of an inadequate earthing system.

▶ Unauthorised repairs could result in unforeseen dangers for the user, for which the manufacturer cannot accept liability. Repairs should only be undertaken by a Miele authorised technician, otherwise any subsequent damage will not be covered by the warranty.

▶ Do not make any alterations to the washing machine, unless authorised to do so by Miele.

▶ Disconnect the washing machine from the power supply in the event of a fault, for maintenance work and for cleaning and care. The washing machine is only electrically disconnected from the power supply when:

- the mains plug of the washing machine is unplugged, or
- the mains fuse is disconnected, or
- the screw-in fuse has been completely removed

See also “Installation – Electrical connection”.

▶ The washing machine may only be connected to the water supply using the set of hoses supplied with the machine. Old sets of hoses must not be re-used. Check the sets of hoses regularly for signs of wear. Change the sets of hoses in good time to avoid the risk of leaks and subsequent water damage.

▶ The cause of any leaks must be dealt with before the washing machine is restarted. Disconnect the washing machine immediately if any water leaks out.

▶ Steam heating malfunctions can result in high temperatures at the door, the dispenser and inside the drum (in particular at the edge of the drum). There is a risk of slight burns.

This only applies to machines with steam heating.

▶ Faulty components must only be replaced by genuine Miele spare parts. Miele can only guarantee the safety standards of the machine when Miele spare parts are used.

▶ All relevant national provisions and regulations (DGUV in Germany) relating to accident insurance are applicable to this machine. It is recommended to carry out testing in accordance with the regulatory framework described in DGUV 100-500/Chapter 2.6/Section 4. The test book required for the documentation is available from the Miele Customer Service Department.

▶ Follow the instructions in “Installation”.

▶ If the washing machine is connected using a mains plug, the mains plug must always be kept accessible so that the washing machine can be easily disconnected from the power supply.

▶ If the machine is to be hard-wired, there must be a means of disconnecting all poles from the power supply. The mains isolator must be close to the washing machine and be clearly identifiable, unobstructed and easily accessible at all times.

▶ Machines with damaged control elements or cable insulation may only be replaced by the manufacturer/Customer Service or a qualified electrician.

▶ A damaged mains connection cable must be replaced by a specialist authorised by Miele.

Correct use

▶ The maximum load size for PWM 927 is 27 kg and for PWM 935 is 35 kg. See the “Programme overview” for the maximum recommended load sizes for individual programmes.

▶ Before using the washing machine for the first time, check that the transport safety devices have been removed (see “Installation – Removing the transport safety devices”). If the transport safety device is not removed, it may cause damage to adjacent furniture or appliances during the spin cycle.

▶ Never try to open the drum door of the washing machine using force. If the door is locked, it can only be opened when a corresponding message appears in the display.

▶ Do not push the suspended drum unit while the machine is running.

▶ When closing the drum door there is a danger of crushing and shearing between the door frame and the drum opening and also at the hinges.

Caution: the drum door locks automatically when the machine is started.

▶ Close the water inlet if the washing machine is to be left for any length of time (e.g. while on holiday), especially if there is no floor drain (gully) in the immediate vicinity.

▶ Take care to ensure that foreign objects (e.g. nails, pins, coins, paper clips) do not find their way into the machine with the laundry. Foreign objects may damage components of the machine (e.g. suds container, drum). Damaged components can damage the laundry.

▶ If the correct amount of detergent is dispensed, the washing machine should not need to be descaled. If, however, you do wish to descale your washing machine, only use proprietary non-corrosive descaling agents. Special descaling agent is available from your Miele dealer or from the Miele Customer Service Department. Strictly observe the instructions for the descaler.

▶ Solvent-based cleaning agents must not be used.

▶ Do not store or use petrol, paraffin or any easily flammable substances near the washing machine. Do not use the machine lid as storage space.

Risk of fire and explosion!

▶ Do not store chemicals (liquid detergents, additives) on the machine lid. They may cause discolouration or lacquer damage. Accidentally spilled chemicals should be removed from the surface immediately with a wet cloth.

▶ There are ventilation slots on the back of the machine. The ventilation slots must not be closed or covered. Please observe the minimum safety distance on the installation plan.

▶ Only use dyes, dye removers and descalers suitable for use in a washing machine. The manufacturer’s instructions on the packaging must be observed.

▶ Dye removers contain sulphur compounds which can cause damage such as corrosion. Do not use these products in this washing machine.

▶ Avoid contact between stainless steel surfaces and liquid detergents or disinfecting agents containing chlorine or sodium hypochlorite. These agents can have a corrosive effect on stainless steel. Aggressive chlorine bleach vapours can also be corrosive. Do not store open containers of these agents near the machine.

Safety instructions and warnings

- ▶ Do not use a pressure washer or hose to clean the washing machine.

Chlorine and component damage

- ▶ Frequent use of chlorine products increases the risk of damage to components.
- ▶ The use of substances containing chlorine, such as sodium hypochlorite and chlorine bleach in powder form, can result in damage to the protective layer of stainless steel and corrosion on components. Therefore, refrain from using substances containing chlorine. Use oxygen-based bleaching agents instead.
If, however, chlorine bleaching agents are used, an anti-chlorine treatment must always be carried out. Otherwise, both the washing machine components and the laundry may suffer persistent and irreparable damage.

▶ Anti-chlorine treatment must be carried out immediately after chlorine bleaching agents have been used. Hydrogen peroxide as well as oxygen-based detergents and bleaching agents are suitable for anti-chlorine treatment. The suds must not be drained in between. Treatments with thiosulphates can result in gypsum-like deposits particularly when used in combination with hard water. This gypsum can build up in the washing machine or cause incrustations on the laundry. Treatment with hydrogen peroxide is recommended over treatment with thiosulphates because hydrogen peroxide neutralises chlorine. The exact dispensing quantities and the treatment temperatures required must be set and tested on site in accordance with the dispensing recommendations of the detergent and cleaning agent manufacturers. The laundry must also be tested to check whether it contains any active chlorine residues.

Accessories

- ▶ Accessory parts may only be fitted when expressly approved by Miele. If other parts are used, warranty, performance and/or product liability claims will be invalidated.

Caring for the environment

Disposal of the packaging material

The packaging is designed to protect the washing machine against transportation damage. The packaging materials used are selected from materials which are environmentally friendly for disposal and can therefore be recycled.

Recycling the packaging material reduces the use of raw materials in the manufacturing process and also reduces the amount of waste in landfill sites. Your dealer will take the packaging material away.

Disposing of your old appliance

Old electrical and electronic appliances often contain valuable materials. However, they also contain harmful substances which were essential for their correct functioning and safety. These could be hazardous to human health and to the environment if disposed of with general waste or if handled incorrectly. Please do not, therefore, dispose of your old appliance with household waste.

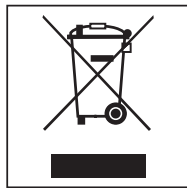

Instead, please make use of officially designated collection and disposal points to dispose of and recycle electrical and electronic appliances in your local community. Consult your dealer.

Please ensure that your old appliance poses no risk to children while being stored for disposal.

► Ensure that the door locks are unusable when disposing of or scrapping old washing machines. This will prevent the risk of children accidentally locking themselves in while playing and endangering their lives.

Miele cannot be held liable for damage caused by non-compliance with these safety notes and warnings.

Energy saving tips

Energy and water consumption

- To get the most out of your machine, load the **maximum** dry load size for the wash programme you are using. Energy and water consumption is most efficient when a full load is washed.
- If suitable, use programmes from the ECO programme package. The programmes are characterised by particularly low energy consumption.

Detergents

- Do not exceed the amounts of detergent recommended by the manufacturer on the packaging.
- Reduce the amount of detergent for smaller load sizes.

When drying with a tumble dryer

Select the highest possible spin speed for the wash programme to save energy in the subsequent tumble dryer cycle.

Description of the machine

Description of the machine

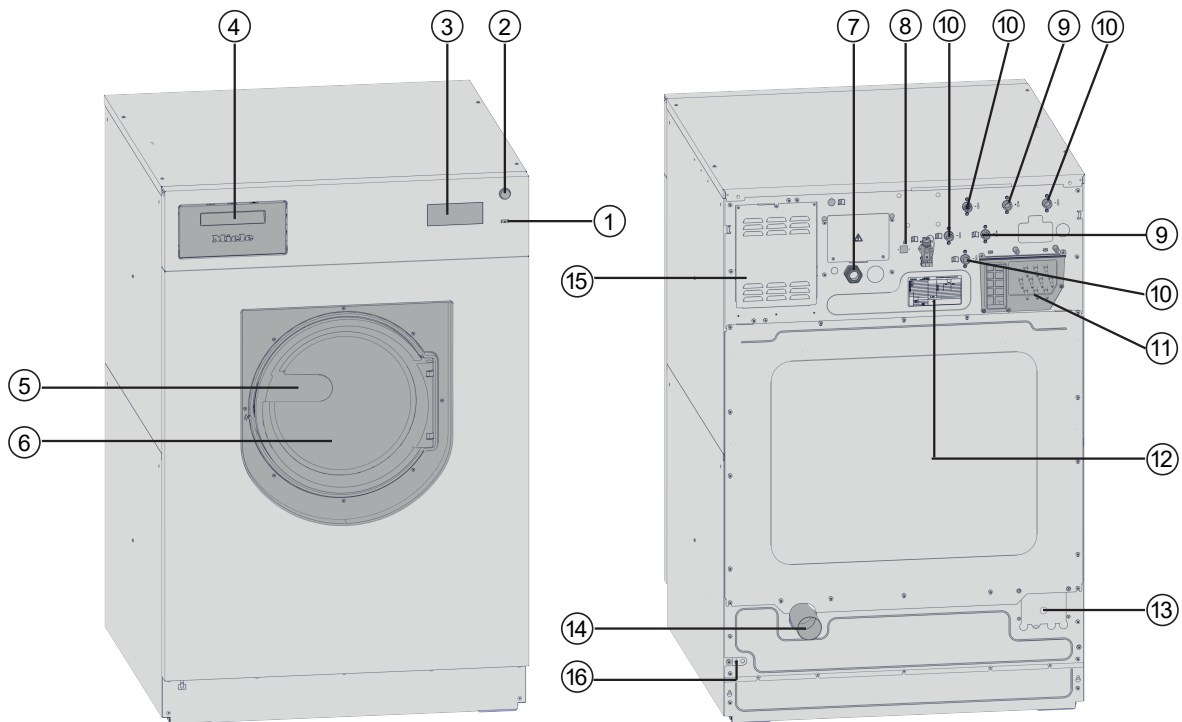

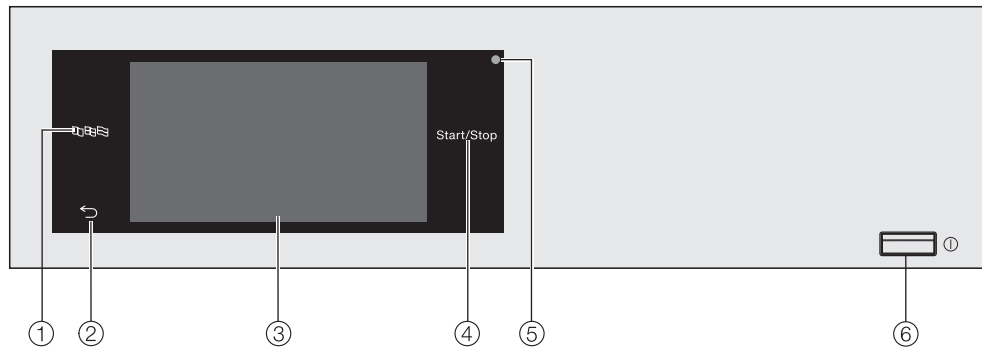

- ① ⏻ button
- ② Emergency stop
- ③ Display (further information can be found in the “Operation” section)
- ④ Detergent drawer
- ⑤ Door handle
- ⑥ Drum door
- ⑦ Electrical connection
- ⑧ Interface for Connector Box (optional second interface)
- ⑨ Hot water connection
- ⑩ Cold water connection
- ⑪ Connections for external dispensing agent supply
- ⑫ Data plate
- ⑬ Connection option for direct/indirect steam (depending on model)
- ⑭ Drain connection DN 70
- ⑮ Ventilation slots
- ⑯ Equipotential bonding

Control panel



- ① **Language sensor control**
For selecting the current user language. The supervisor language is displayed again at the end of the programme.
- ② **Back sensor control** ↩
Takes you back one level in the menu.
- ③ **Touch display**
- ④ **Start/Stop sensor control**
For starting the wash programme selected and cancelling a programme once it has started. The programme selected can be started as soon as the sensor control starts flashing.
- ⑤ **Optical interface**
For the Customer Service Department.
- ⑥ **button**
For switching the washing machine on and off.

Sensor controls and touch display

The sensor controls ,  and *Start/Stop* and the elements in the display respond to finger tip contact. Every touch of a sensor control is confirmed with an audible keypad tone. You can adjust the volume of the keypad tone or switch it off (see “Supervisor level”).

The control field with sensor controls and the touch display can be scratched by pointed or sharp objects, e.g. pens.
Only touch the control field with your fingers.

Main menu

After switching on the washing machine, the main menu will appear in the display.

You can access all the important sub-menus from the main menu.

Touch the  symbol at any time to return to the main menu. Values set previously are not saved.

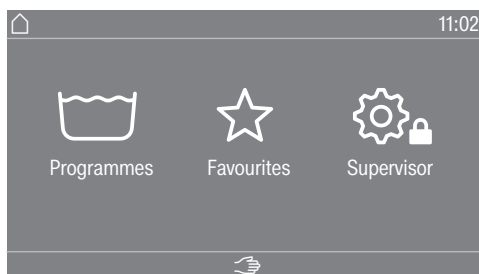

“Programmes” menu

In this menu, you can select the wash programmes.

“Favourites” menu

In this menu, you can select 1 favourite programme from a total of 24 favourite programmes. The wash programmes can be set up and saved by the supervisor in the Favourites menu (see “Favourite programmes” under “Supervisor level”).

“Supervisor” menu

You can alter the washing machine’s user interface to suit changing requirements in the supervisor level (see “Supervisor level”).

Examples of how to operate the machine

Lists

“Programmes” menu (single selection)

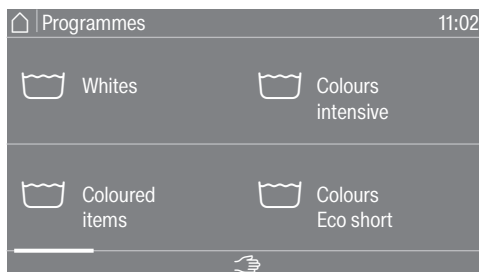

You can scroll right or left by swiping your finger across the screen. To do this, place your finger on the touch display and swipe it in the direction you want.

The orange scroll bar indicates that further options follow.

Touch a programme name to select the wash programme.

The display will change to the standard menu for that programme.

“Extras” menu (multiple selection)

To access the level for selecting Extras, you first need to select a programme, e.g. White items.

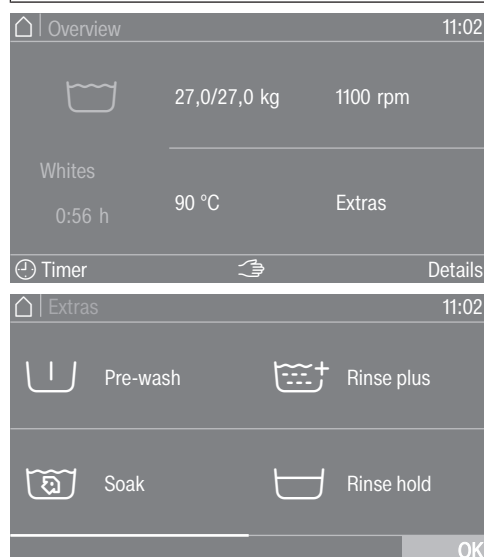

Touch one or several *Extras* to select it/them.

Currently selected *Extras* are marked orange.

To deselect an *Extra*, simply touch the *Extra* again.

Use the *OK* symbol to activate all selected *Extras*.

Setting numerical values

You can set numerical values in some menus.

The following example shows how to set the time of day. The “Supervisor level” section describes how to get to this level.

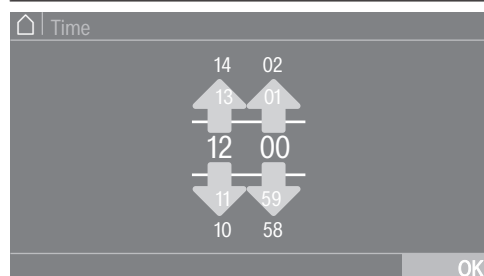

Enter the numbers by swiping up or down.

Place your finger on the number that you want to change and move your finger in the direction you want. Use the *OK* symbol to accept the set numerical value.

Tip: A numerical keypad may also appear to adjust the value for some settings.

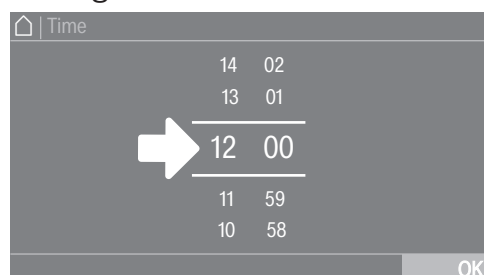

Operation

Briefly touching a number between the two lines will bring up the numerical keypad.

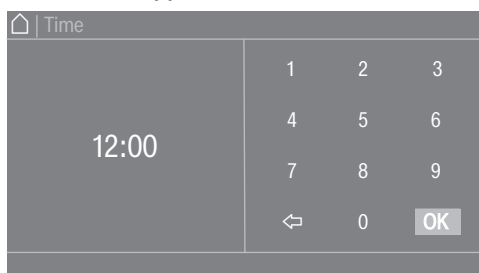

Once a valid number has been entered, the *OK* symbol will be highlighted green.

Pull-down info

The following example describes the display for an ongoing wash programme. The “Programme start – programme end” section describes how to get to this level.

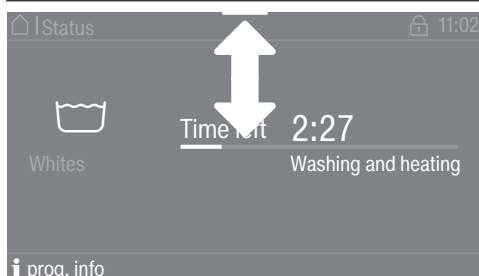

If an orange bar appears at the top of the screen in the middle of the display, you can open the pull-down menu. Drag the bar downwards to display it. To hide it, slide the bar upwards again.

Exiting a menu level

- Touch the ↶ symbol to return to the previous screen.

Entries you have made before this which have not yet been confirmed with *OK* will not be saved.

Operating a laundrette machine

The main menu will vary depending on the programming status (see “Supervisor level”).

Shortcuts are the easiest way to operate the machine. Operating staff are unable to change pre-set programmes.

Laundrette, basic

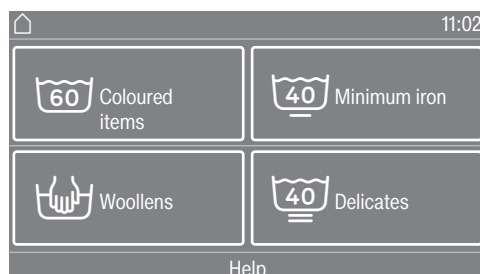

Between 4 and 24 pre-set programmes are available. These programmes cannot be changed by the user.

Laundrette logo

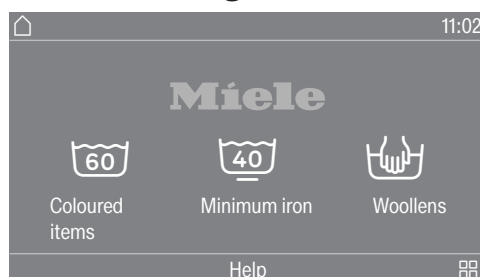

Up to 24 pre-set programmes are available. The first 3 programmes can be selected directly. The remaining programmes are selected from a list . These programmes cannot be changed by the user.

Washing

Preparing for use

Emptying pockets

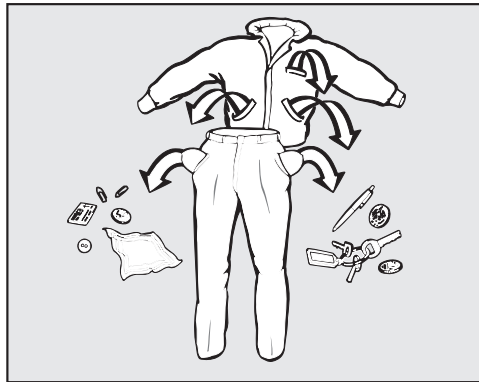

- Empty all pockets.

⚠ Damage due to foreign objects.
Nails, coins, paper clips, etc. can cause damage to garments and components inside the machine.
Check laundry before washing and remove any foreign objects.

Sorting laundry

- Sort the laundry according to colour and the garment care label.

Preparing the laundry items

- Shake mops, cleaning cloths and pads out well to get rid of coarse soiling before placing them in the washing machine drum.

Pre-treating stains

- Badly soiled areas and stains should be cleaned as soon as possible. Stains should be carefully dabbed off using a soft, colourfast cloth.

General tips

- Do not machine wash items which are specified by the manufacturer as not washable on the care label (.
- Curtains: remove rollers and lead weights or place in a laundry bag.
- Sew in or remove any loose underwiring in bras.
- Turn garments inside out, if recommended by the manufacturer.
- Close any zips and velcro fasteners before washing.
- Fasten duvet covers and pillow cases to prevent small items from becoming rolled up inside them.
- Please refer to the Programme overview for more tips and tricks.

Loading and switching on the washing machine

Loading the washing machine

- Switch on the washing machine with the  button.
- Pull the door handle to open the drum door.
- Unfold the laundry and load loosely into the drum. Mixing both large and small items gives better wash results and also helps to distribute the load evenly during spinning.

The most efficient energy and water consumption is achieved when a full load is washed. However, do not overload as this makes cleaning less effective and causes creases.

Closing the drum door

- Close the drum door by pressing it until the pre-latch engages.



 Make sure that no items are caught between the drum door and the sealing ring.

The drum door engages, but is not securely locked yet. The drum door locks automatically as soon as the machine starts.

Washing with detergent drawer

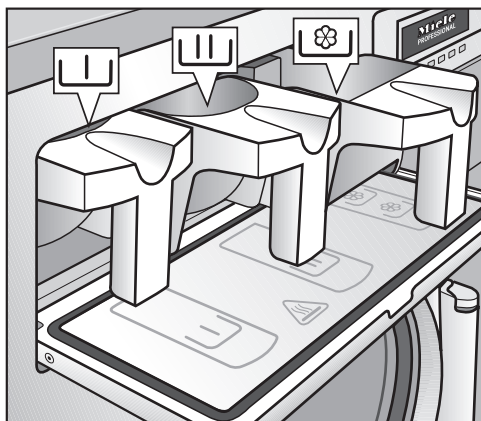
Adding detergent using the detergent drawer



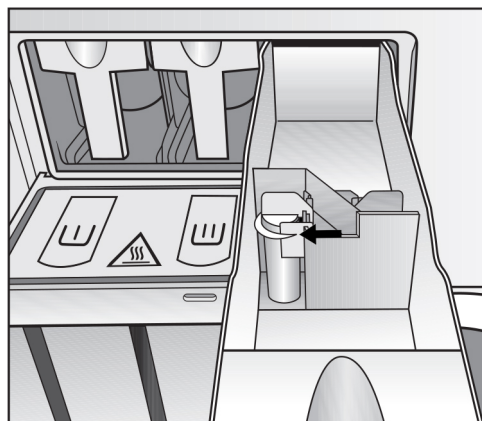

- For standard programmes, add the powder detergent for the main wash to the  drawer and if desired, add detergent for a pre-wash to the  drawer. Add fabric conditioner to the front of the  drawer.

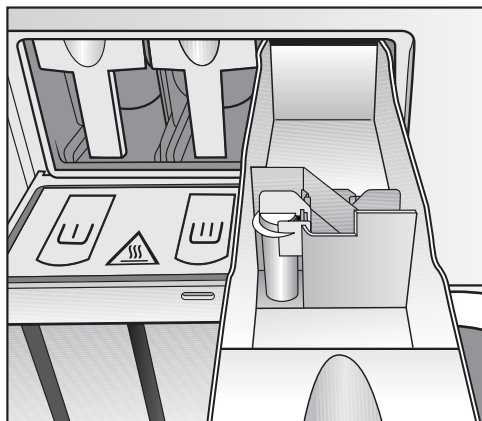

- Add any other detergent additives to the back of the  drawer (if this has been programmed).

Washing



Do not fill the  drawers above the level marker with detergent additives. Otherwise they will run straight through the siphon into the suds container.

Bleaching agent

Only use bleaching agents on fabrics with the Δ symbol on the wash care label.

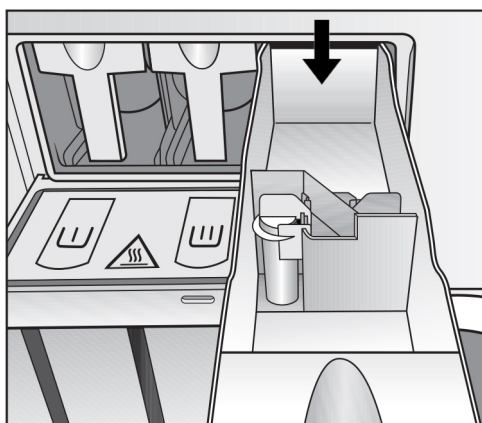

Liquid bleaching agents must only be dispensed through the designated dispenser drawer. The agent will then be dispensed automatically during the second rinse. Liquid bleaching agents should only be used on coloured items which have a wash care label stating that they are colourfast and suitable for bleaching.

 Frequent use of chlorine products increases the risk of damage to components.

Dyes, dye removers and descalers

Proprietary dyes, dye removers and descalers may only be used in this washing machine if the manufacturer expressly states that they are suitable for use in a washing machine. The manufacturer's instructions on the packaging must be observed.

Detergent dispensing

Avoid dispensing more than the required amount as this can cause excessive foaming.

- Only use low foaming detergents.
- Dispense according to the detergent manufacturer's recommendations.

The dispensing amount will depend on:

- The amount of laundry
- The water hardness
- The degree of soiling of the laundry

Detergent dispensing quantity

Please dispense according to water hardness levels and follow the detergent manufacturer's instructions.

Water hardness levels

Water hardness level	Total hardness in mmol/l	German scale °dH
I (soft)	0–1.5	0–8.4
II (medium)	1.5–2.5	8.4–14
III (hard)	above 2.5	above 14

Check with your local water supplier if you do not know the water hardness level in your area.

Selecting a programme

Programmes

There are different ways to select a programme.

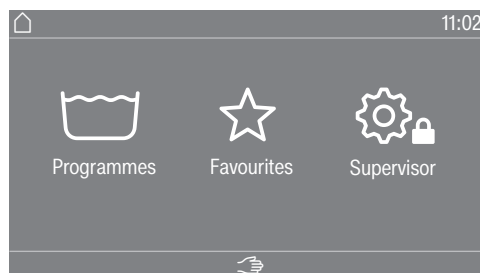

You can select a programme from the Programmes menu.

- Touch the Programmes selection area.

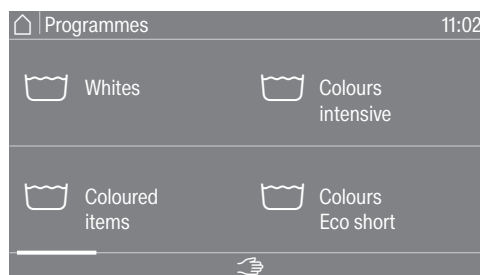

- Scroll to the right in the display until the programme you want appears.
- Touch the required programme on the touch display.

The display will change to the standard menu for that wash programme.

Washing

Favourites

Alternatively, you can select a programme from the Favourites menu.

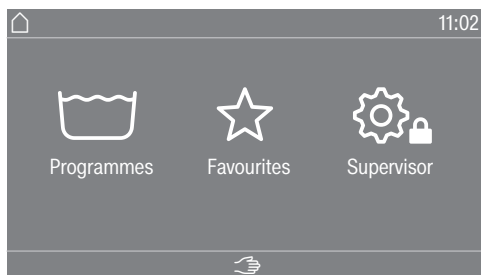

- Touch the Favourites selection area.

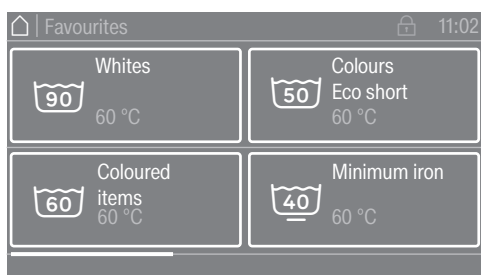

- Scroll to the right in the display until the programme you want appears.
- Touch the required programme on the touch display.

The display will change to the standard menu for that wash programme.

In the case of favourite programmes, the majority of the programme settings are already fixed and cannot be changed.

Selecting programme settings

Selecting the load size

To enable load-specific external dispensing and an adapted programme sequence, you can specify the load size for some programmes.

- Touch the Weight (kg) selection area.

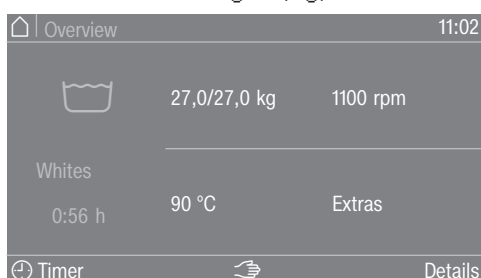

- Enter a valid value for the load size.

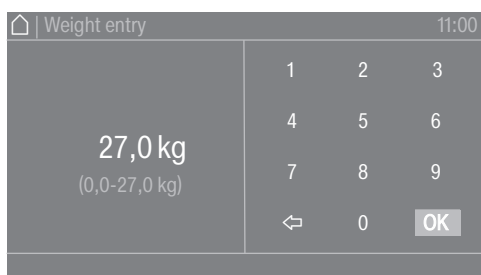

- Press the OK symbol.

The display will change to the Overview menu.

Selecting a temperature

You can alter the pre-set temperature of a wash programme.

- Touch the Temperature (°C) selection area.

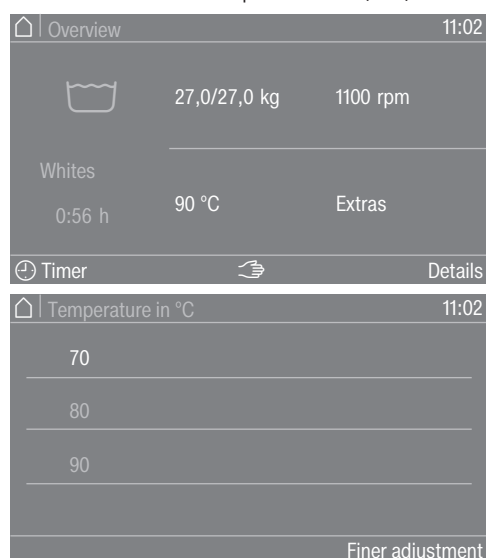

- Select the desired temperature from the presets.

The display will change back to the Overview menu.

If you select the Finer adjustment selection area, you can set additional temperatures within the available temperature range by entering them directly.

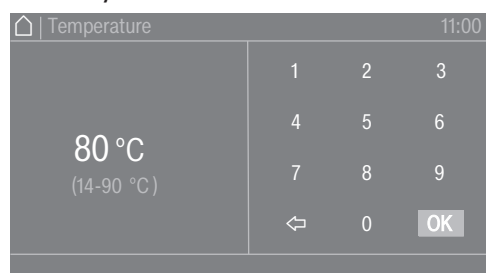

- Select the desired value using the keypad.
- Press the OK symbol.

The display will change back to the Overview menu.

The temperature can only be selected within the range specified below the current setting (e.g. 14–90 °C).

Selecting a spin speed

You can alter the preset spin speed of a wash programme.

- Touch the Spin speed (rpm) selection area.

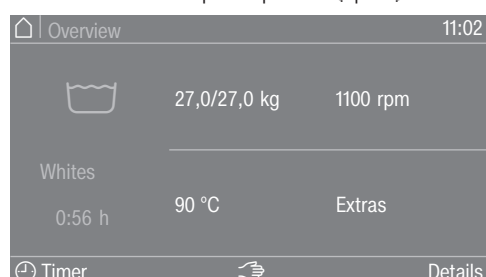

Washing

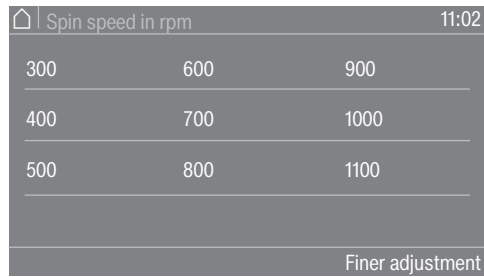

- Select the spin speed you want from the presets.

The display will change back to the Overview menu.

If you select the Finer adjustment selection area, you can set additional speeds within the available speed range.

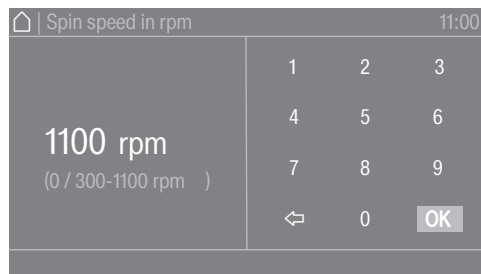

- Select the desired value using the keypad.
- Press the OK symbol.

The display will change back to the Overview menu.

The speed can only be selected within the range specified below the current setting, e.g. 0/300–1100 rpm for PWM 927 and 0/300–1060 rpm for PWM 935.

BoostSpin

With certain machine types, the Boost Spin function is activated at the end of a wash programme. As a result, the laundry has the lowest possible residual moisture due to the maximum spin speed. BoostSpin is activated ex works but is displayed as **not** visible.

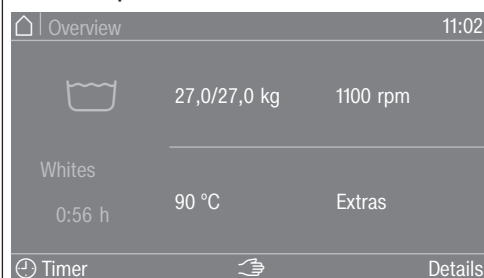

If the Boost Spin function is active and visible, the Extras are displayed under the  symbol.

- Touch the  symbol to select further Extras.

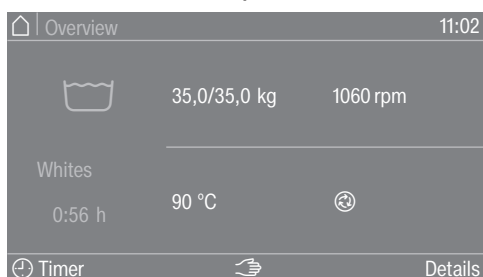

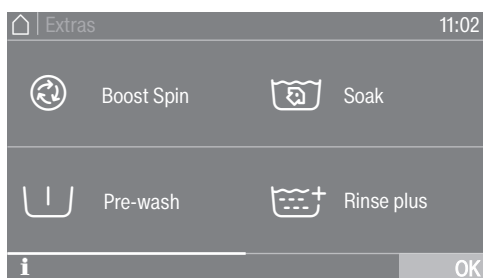

The Boost Spin function cannot be selected or deselected in the Extras sub-menu. The symbol is displayed as active but cannot be changed.

- You can select further Extras.



Information on BoostSpin can be found under **i**.

If the  symbol is to be displayed, this setting can be adjusted at supervisor level. The Extras are then displayed under the  symbol.

- Open the Supervisor level (see “Supervisor level”).
- Open the Controls / Display menu.
- Select Visibility parameters and activate the BoostSpin parameter.

Washing

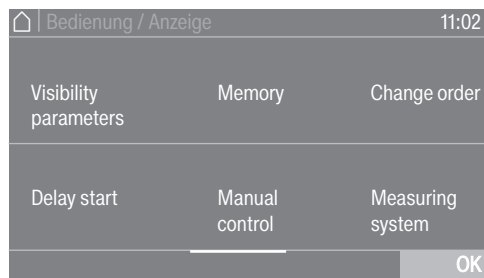

The BoostSpin visibility can be deactivated again in the order specified above.

If the BoostSpin visibility is deactivated, the text under the Extras is no longer displayed. The Extras are displayed again in the overview.

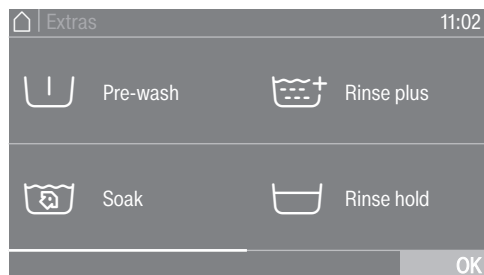



Selecting Extras

Selecting Extras

You can select Extras for some wash programmes.

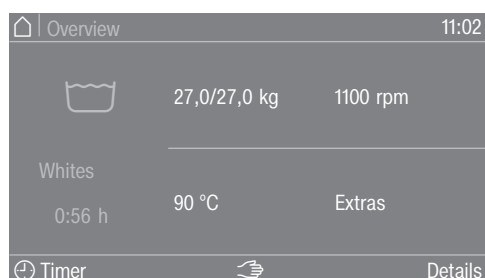
- Touch the Extras selection area.



If the Boost Spin function is active and visible, you can access the Extras by selecting the  symbol.

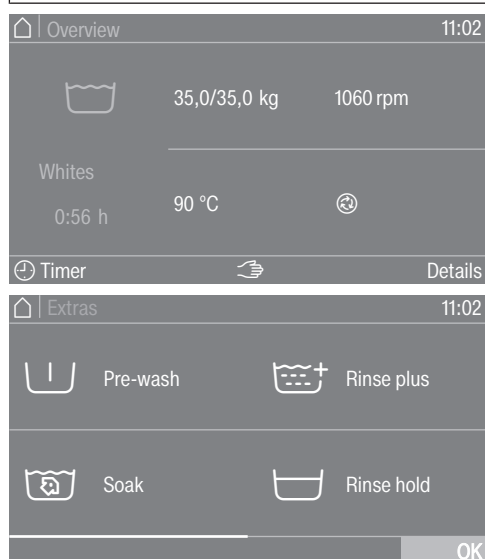

- Select one or more Extras.
- Press the OK symbol.

The display will change to the Overview menu.

Pre-wash

A pre-wash can be added for heavily soiled laundry. Coarse soiling is loosened and removed before the main wash.

Soak

For heavily soiled and stained items with protein stains. The soak duration is 10 minutes.

Rinse plus

An extra rinse can be activated to achieve a better wash result.

Rinse hold

The laundry is not spun after the final rinse cycle and remains in the rinse water. This helps to prevent creasing if the laundry is not going to be removed from the washing machine immediately after the end of the programme.

Filling stop

Water is drained out of the machine before the final rinse and the programme stops. The required starch, dye, proofing agent, etc. is added directly to the washing machine drum. The programme is continued with the *Start/Stop* sensor control.

Intensive

For hard-wearing laundry that is very heavily soiled. Extending the main wash increases cleaning efficiency.

Washing

Water plus

The water level in the wash cycle will be increased.

Starting a programme

Programme start – programme end

The programme can be started as soon as the *Start/Stop* sensor control is flashing on and off.

- Touch the *Start/Stop* sensor control.

The door will lock () and the wash programme will start.

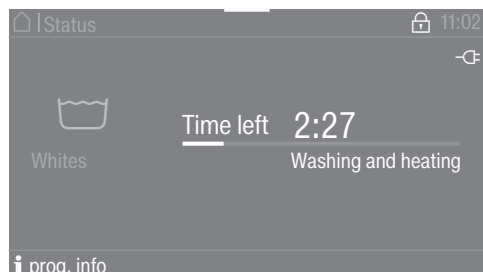

Tip: You can use the pull-down menu to display the selected temperature, spin speed and any selected Extras.

If a delay start period () Timer) has been selected, this will appear in the display at the bottom left.

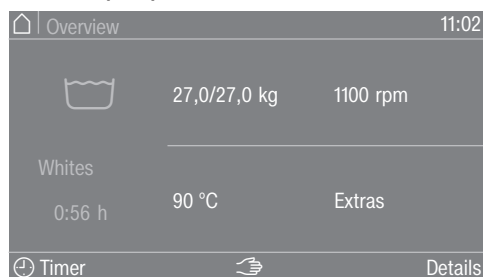

If you select the **i prog. info** selection area, all programme-related information will be displayed.

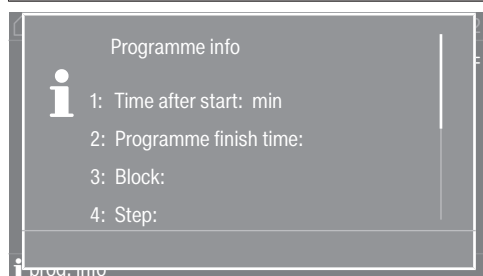

Once the delay start period has elapsed (if applied), the programme running time will appear in the display; otherwise, the running time will appear straight away. The programme sequence is also shown in the display.

End of the programme

Depending on the setting selected in the supervisor level or in the programme, the machine will switch to the anti-crease action cycle at the end of the programme. The door remains locked. The door can be unlocked at any time by touching the *Start/Stop* sensor control.

Removing the laundry

- Pull open the door.
- Remove the laundry.

Items left in the drum could discolour other items in the next wash or become discoloured themselves.
Remove all items from the drum.

- Check the door sealing ring for any foreign objects.

Tip: Leave the door slightly open to allow the drum to dry.

- Switch the washing machine to standby with the  button.

Tip: Leave the detergent drawer slightly open to allow it to dry.

Timer

The timer can be used to select a programme start date, programme start time or programme end time. This mode is also referred to as delay start.

Setting the timer

- Touch the  Timer selection area.

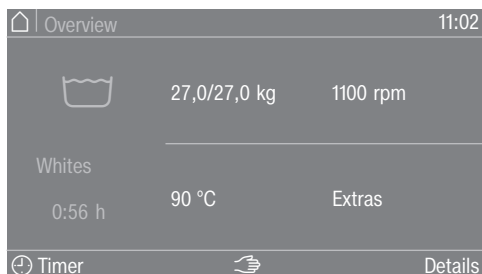

- Select the Finish at, Start date or Start at option.

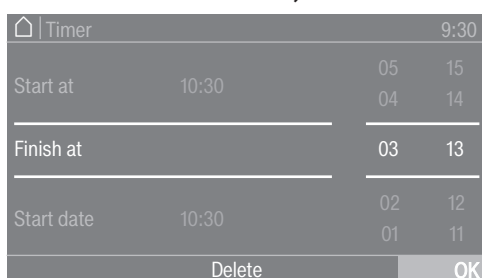

- Set the hours and the minutes or the date and confirm with the  OK symbol.

Deleting the timer

The selected delay start period can be cancelled before the programme starts.

- Touch the selection area with the selected settings in the timer field, e.g. 01.01. 11:00.

The selected delay start period will appear in the display.

- Touch the Delete selection area.
- Confirm with the  OK symbol.

The selected delay start period is deleted.

Starting the timer

- Touch the *Start/Stop* sensor control.

The door will lock and the time until the programme starts will appear in the display.

After the programme has started, the selected delay start period can only be changed or cancelled by interrupting the programme.

The programme can be started immediately at any time.

- Touch the Start immediately selection area.

Spinning

Final spin speed

When a programme is selected, the maximum spin speed for this wash programme is shown in the display in the pre-start menu.

You can reduce the final spin speed.

Depending on the programme, it may also be possible to increase the speed. The setting options are displayed when you tap the spin speed.

Rinse-spin

There is a spin cycle after the main wash and between the rinse cycles. A reduction in the final spin speed will also reduce the interim spin speed as appropriate.

Anti-crease

At the end of the programme, the drum continues to turn at intervals for up to 30 minutes to help prevent creasing.

The drum door cannot be opened until the programme has ended.

Anti-crease is programme-dependent. The option can be switched on or off in the supervisor level.

Skip

The Skip function enables users to skip forwards or backwards in the programme sequence. The programme sequence is continued from the selected step.

If a programme is interrupted using the *Start/Stop* sensor control, the Skip ⇨ function is available in the programme stop screen.

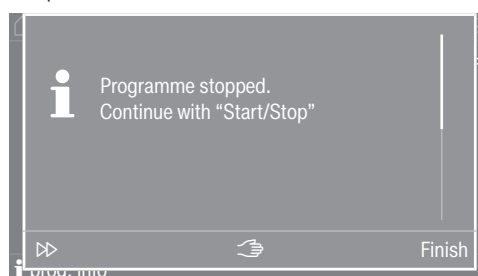

If the Skip ⇨ function is selected, the required programme step can be selected via the display.

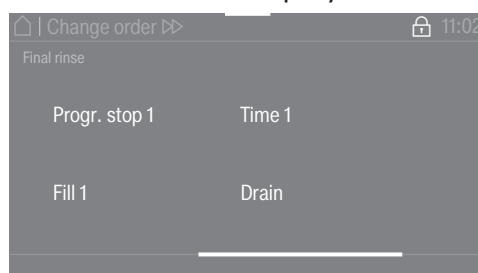

The programme can then be continued with the *Start/Stop* sensor control.

Manual control

Manual control is possible either before a programme is started or when a programme has been stopped.

Switching to manual control

- Press the ⇨ “Manual control” button to access the password entry screen.

Special features in the programme sequence

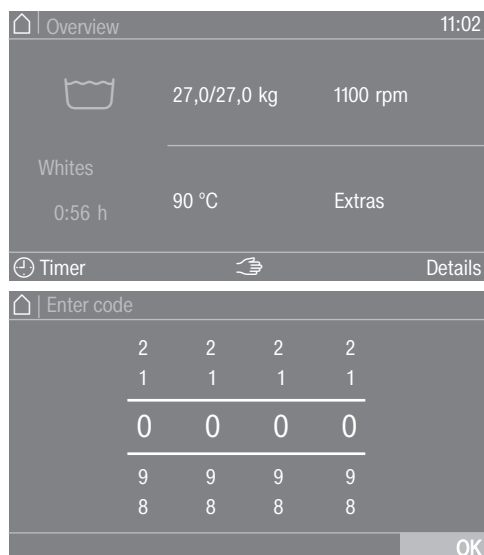

- Enter the password.
- Confirm the password entry with the OK symbol.

The Manual control menu is displayed:

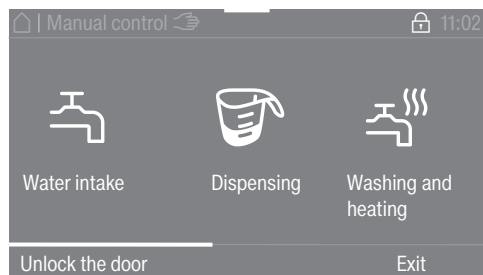

The individual functions of the machine can be selected individually and the parameters can be set.

The current level, spin speed and temperature statuses of the machine appear orange.

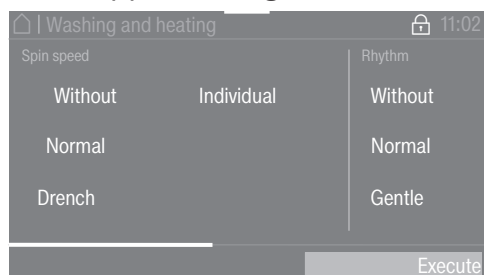





When a function has been selected, the sub-menu for adjusting the parameters appears.

- Select the desired setting.
- Confirm the entry with Execute.

The sub-menus appear in various operating modes. See “Examples of how to operate the machine” for an in-depth description.

Special features in the programme sequence

The function buttons are assigned with specific manual control functions:

- Water inlet 
- Dispensing 
- Washing and heating 
- Drain with drum rotation 
- Spin 

- Press the button again to end a selected function.

Water intake

Water intake valves and the water level can be set.

- Press the  Water intake function button.
- Select the desired value.
- Confirm your selection with the Execute sensor control.

If a higher numerical value is set, the values below this will no longer be displayed.

The wash programme will start or continue.

Dispensing

The dispensing quantity for the various dispensing pumps can be set.

This function is only possible if the Connector Box, the dispensing pumps and automatic dispensing have been selected in the supervisor level, see “Supervisor level” section.

- Press the  Dispensing function button.
- Select the desired dispensing pump and dispensing quantity, e.g. D1 50 ml.
- Confirm your selection with the Execute sensor control.

The wash programme will start or continue.

Washing and heating

Spin speed, rhythm and temperature can be set.

- Press the  Washing and heating function button.
- Select the desired settings.

The selected setting will appear in orange in the multiple selection.

- Confirm your selection with the Execute sensor control.

The wash programme will start or continue.

Drain with agitation

Drain path, spin speed and rhythm can be set.

- Press the  Drain with agitation function button.
- Select the desired settings.

The selected setting will appear in orange in the multiple selection.

- Confirm your selection with the Execute sensor control.

Spin





The spin speed can be set.

- Press the  Spin function button.
- Select the desired value.
- Confirm your selection with the Execute sensor control.

The wash programme will start or continue.

Special features in the programme sequence

Function combinations Water inlet, dispensing, washing and heating can be selected simultaneously in any combination*.

 Water inlet	 Dispensing	 Washing and heating	 Drainage with agitation	 Spinning
<input checked="" type="checkbox"/>	<input checked="" type="checkbox"/>	<input type="checkbox"/>	<input type="checkbox"/>	<input type="checkbox"/>
<input type="checkbox"/>	<input checked="" type="checkbox"/>	<input checked="" type="checkbox"/>	<input type="checkbox"/>	<input type="checkbox"/>
<input checked="" type="checkbox"/>	<input type="checkbox"/>	<input checked="" type="checkbox"/>	<input type="checkbox"/>	<input type="checkbox"/>
<input checked="" type="checkbox"/>	<input checked="" type="checkbox"/>	<input checked="" type="checkbox"/>	<input type="checkbox"/>	<input type="checkbox"/>

* possible function combinations

Weighing system

If the machine is equipped with a weighing plinth, the load size is displayed in 0.2 kg increments during loading. The maximum load size for the selected programme is displayed beside it.

Resetting the load display to zero

Do not place any items on the machine. Do not lean against the machine.

This can influence the result of the measurement.

If the load display does not show “0.0” with an empty drum, set the display to 0 using the Tare button.

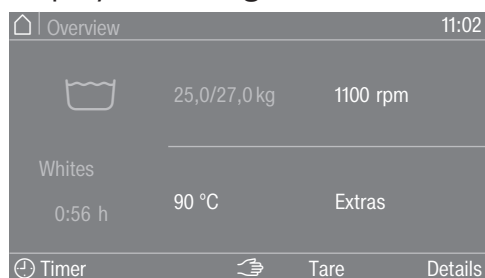

- If after resetting to 0 (taring), you discover an overlooked item of laundry in the drum, the following will appear in the display:

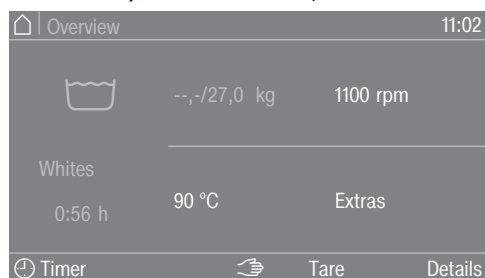

- Reset the display to 0 using the Tare button.

Tip: If the machine is overloaded, for example when laundry is wet, it will operate in accordance with the nominal load after the programme starts. This value is also saved in the operating data module.

If the weighing system is not working correctly, a message is displayed. The nominal load of the machine is assumed. The weight input can be entered manually.

Changing the programme sequence

Changing a programme

Altering the wash programme

You will need to cancel the current programme before you can select a new one.

Interrupting a programme

You can cancel a wash programme at any time after it has started.

If the programme is locked, the disinfection programmes or payment programmes can only be cancelled by entering a code.

- Touch the *Start/Stop* sensor control.

The following appears in the display:

i Programme stopped. Continue with "Start/Stop"

The following appears in the display:



- Select Finish.

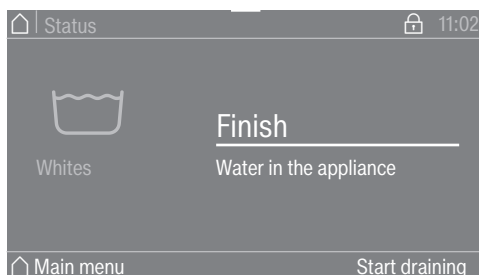

The suds are not drained so they can be used again in a subsequent programme. Once the programme has ended, the programme end screen is displayed. It is possible to switch to the main menu while the suds are in the drum or to drain the suds by pressing the *Start draining* control. If permanent automatic water drainage is required, Automatic drainage can be activated at supervisor level.

The drum door remains locked while there is water in the machine.

The door can be opened under the condition Programme end without water. If the temperature is too high, wait until it has cooled down so that the door can be opened.

- Wait until the door unlocks.
- Pull open the door.
- Remove the laundry.

Switching on the washing machine after an interruption to the power supply

If the washing machine is switched off with the  button during a wash programme, the programme will be interrupted.

- Switch the washing machine back on with the  button.
- Note the message in the display.
- Touch the *Start/Stop* sensor control.

The programme continues.

Changing the programme sequence

Adding or removing laundry

You can add or remove laundry items for a short period immediately after the programme has started.

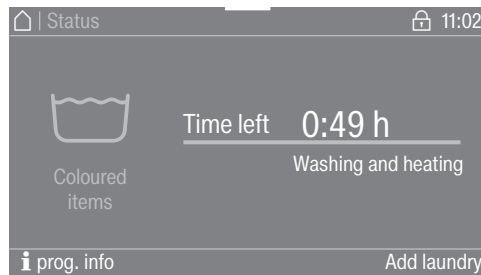

- Touch the Add laundry selection area.

If the message Add laundry is not visible in the display then it is no longer possible to add items of laundry.

The wash programme will stop and the door will unlock.

 Risk of chemical burns from detergent.
When adding or removing laundry, your skin may come into contact with detergent, particularly if the detergent is dispensed externally. Take care when placing your hands inside the drum.
If suds have come into contact with the skin, rinse off immediately with plenty of lukewarm water.

- Pull open the door.
- Add laundry or remove individual items.
- Close the door.
- Touch the *Start/Stop* sensor control.

The wash programme will continue.

Problem solving guide

Troubleshooting

Power cut during the wash process

- Disconnect the machine from the mains power supply (see “Safety notes”).
- Close the on-site shut-off valves for water or steam.

If there is water in the machine, first open the drain valve manually and then manually unlock the drum door to remove the laundry.

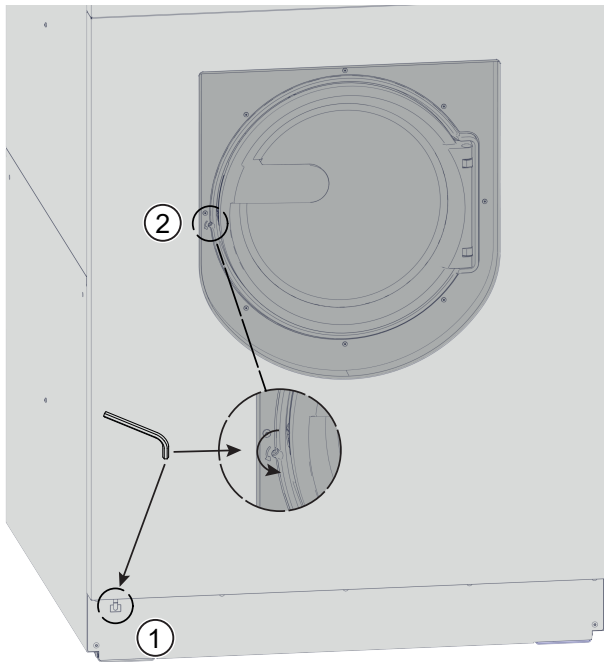

- Guide the T 40 Torx wrench for the emergency door release through the eye ① on the front of the machine.
- Open the drain valve by pulling the eye ② using the Torx wrench.
- Keep pulling the eye until the suds have drained away completely.

The suds will drain away.

The emergency drain closes automatically when the Torx wrench is removed from the eye.

- Push the eye ① back in as far as it will go.

Unlocking the door

The drum door cannot be opened in the event of a power cut.

⚠ Danger from rotating drum and danger of scalding.

Before inserting the Torx wrench, make sure that the machine is disconnected from the electricity supply, the drum has stopped and there is no water in the machine.

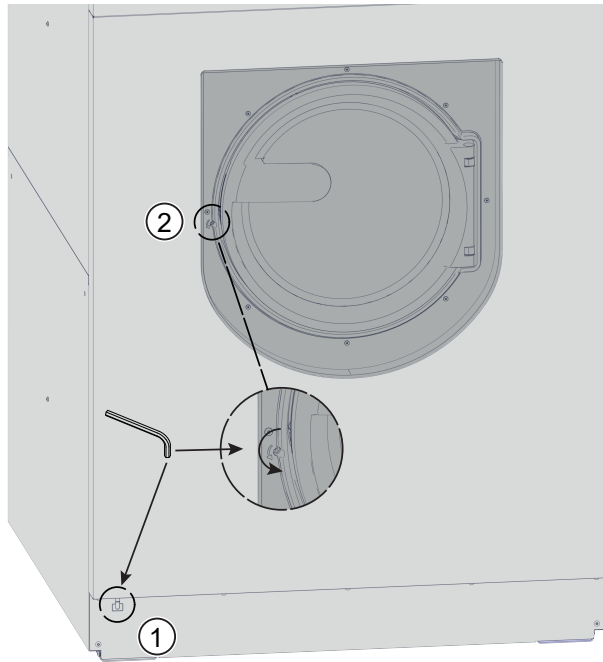

- Using a T 40 Torx wrench, turn the release element with the inner hexagon ② two whole revolutions **anti-clockwise**.

Tip: Pushing on the door at the same time makes it easier to turn the emergency release element.

The release element is opposite the door hinge at the same height as the door handle (see diagram).

The release element must not be turned in the opposite direction to the arrow.
The door lock is damaged.

The turn resistance will noticeably reduce. When the emergency release element moves freely, the door is unlocked.

Tip: It is not necessary to screw the emergency release element back in.

The door can now be opened.

Suitable protective clothing
Suitable protective clothing must be worn when unloading the drum.

Problem solving guide

Contact in case of malfunction

In the event of any faults which you cannot remedy yourself, please contact your Miele Dealer or Miele Service.

Contact information for Miele Service can be found at the end of this document.

Please note that telephone calls may be monitored and recorded for training purposes and that a call-out charge will be applied to service visits where the problem could have been resolved as described in this booklet.

Please quote the model and serial number of your appliance when contacting Miele. This information can be found on the data plate.

The data plate is on the back of the machine at the top and on the inside of the drum door.

Problem solving guide

The majority of faults and problems that arise during day-to-day use can be remedied without external assistance. You can save time and money in many cases, as you do not need to call the Miele Customer Service Department.





The following tables are designed to help you to find the cause of a malfunction or a fault and to resolve it. You should, however, note the following:

⚠ Repair work to electrical appliances should only be carried out by an authorised technician. Repairs by unqualified persons can cause considerable danger to users.



The wash programme does not start

Problem	Cause and remedy
The display remains dark, and the <i>Start/Stop</i> sensor control does not light up or flash.	There is no power to the washing machine. <ul style="list-style-type: none">■ Check whether the washing machine is switched on.■ Check whether the washing machine is connected to the power supply.■ Check whether the fuse has tripped.
	The washing machine has switched off automatically to save energy. <ul style="list-style-type: none">■ Switch the washing machine back on with the  button.
The following appears in the display: F - Door lock fault. You can continue by pressing the "Start/Stop" button	The door has failed to lock. <ul style="list-style-type: none">■ Close the door again.■ Start the programme again. If the fault message appears again, contact the Customer Service Department.
The display is dark and the <i>Start/Stop</i> sensor control is flashing slowly.	If the standby function has been activated at supervisor level, the display switches off automatically to save energy. <ul style="list-style-type: none">■ Touch any of the controls. The display switches back on.
The programme is on the pre-start screen and the <i>Start/Stop</i> sensor control is not flashing.	The drum door has been pushed to but is not closed correctly. <ul style="list-style-type: none">■ Check whether the drum door is closed correctly.

Programme cancellation and fault message

Problem	Cause and remedy
 F - Water drainage fault. If restart fails, call Service.	The drain is blocked or restricted. <ul style="list-style-type: none"> ■ Check the drainage paths and clean them if necessary.
 F - Water intake fault. If restart fails, call Service.	The water inlet is blocked or restricted. <ul style="list-style-type: none"> ■ Check whether the water inlet is turned on properly. ■ Check the water inlet hoses for leaks. ■ Check whether the water connection pressure is sufficient. ■ Check whether the water inlet hoses are kinked.
	The water inlet filters are blocked. <ul style="list-style-type: none"> ■ Clean the filters.
 Disinfection temperature not reached	The required temperature was not reached during the disinfection programme. <ul style="list-style-type: none"> ■ The washing machine has not carried out the disinfection cycle correctly. ■ Start the programme again.
 Fault F. If restart fails, call Service	There may be a fault. <ul style="list-style-type: none"> ■ Disconnect the washing machine from the electricity supply. ■ Wait at least 2 minutes before reconnecting the washing machine to the electricity supply. ■ Switch the washing machine on again. ■ Start the programme again. If the fault message appears again, contact the Customer Service Department.
Emergency release. Programme stopped. Please close the door and switch the machine off and back on again.	The door emergency release has been activated. <ul style="list-style-type: none"> ■ Close the door and switch the machine off and on. <p>The interrupted programme can be continued once the machine has been restarted.</p>

The display shows a message

Problem	Cause and remedy
 Container empty	One of the liquid dispensing detergent containers is empty. <ul style="list-style-type: none"> ■ Refill the detergent container.
 Container empty. You can continue without automatic dispensing via "Start/Stop"	One of the liquid dispensing detergent containers is empty; the programme is stopped. <ul style="list-style-type: none"> ■ Refill the detergent container and press the Start/Stop button to continue the wash programme. ■ If it is not possible to refill the detergent container, press the Start/Stop button to continue the wash programme without detergent. <div style="border: 1px solid gray; padding: 5px; margin-top: 10px;"> <p>Insufficient disinfection Disinfection programmes must be cancelled as no disinfectant can be added.</p> </div>



Problem solving guide

Problem	Cause and remedy
i Hygiene info: run a programme of at least 60°C	<p>During the last wash, a wash programme with a temperature below 60 °C was selected.</p> <ul style="list-style-type: none"> ■ Start a programme with a minimum temperature of 60 °C or the Clean machineExtrasIntensive programme.
Weighing system defective. Please enter the weight manually.	<p>The weighing system is defective.</p> <ul style="list-style-type: none"> ■ Enter the weight manually.

Insufficient wash results

Problem	Cause and remedy
Liquid detergent does not give the required result.	<p>Liquid detergents usually contain no bleaching agents. They do not remove fruit, coffee or tea stains.</p> <ul style="list-style-type: none"> ■ Use a general purpose powder detergent containing a bleaching agent. ■ Pour stain remover powder into drawer  in the dispenser compartment and liquid detergent into a dispenser ball. ■ Never put stain remover powder and liquid detergent together in the detergent drawer.
White residues which look like powder detergent are seen on dark textiles after washing.	<p>The detergent contained compounds (zeolites) to aid water softening which are not soluble in water. These have ended up on the laundry.</p> <ul style="list-style-type: none"> ■ Try to brush off the residues with a soft brush once the laundry is dry. ■ In future, wash dark textiles using a detergent which contains no zeolites. Liquid detergents usually contain no zeolites.
Textiles with particularly greasy soiling are not properly clean.	<ul style="list-style-type: none"> ■ Select a programme with pre-wash. Use liquid detergent for the pre-wash. ■ Continue to use universal powder detergent for the main wash.
	<p>The use of heavy-duty detergent is recommended in the main wash for very heavily soiled workwear. Please seek advice from the detergent manufacturer.</p>
Grey, greasy particles cling to washed laundry.	<p>Insufficient amounts of detergent were used. The laundry was heavily soiled with grease (oils, ointments).</p> <ul style="list-style-type: none"> ■ Use more detergent or use liquid detergent with this type of soiled laundry. ■ Before washing the next load run a 60 °C programme with liquid detergent but without a load.

General problems with the washing machine

Problem	Cause and remedy
The washing machine vibrates during the spin cycle.	<p>The appliance does not stand straight.</p> <ul style="list-style-type: none"> ■ The washing machine must be secured to the floor on site according to the instructions on the installation plan.
Large amounts of detergent residue remain in the detergent drawer.	<p>The water flow pressure is too low.</p> <ul style="list-style-type: none"> ■ Clean the water inlet filters.
	<p>Powder detergent used in conjunction with water softeners tends to become sticky.</p> <ul style="list-style-type: none"> ■ Clean the detergent drawer and, in the future, add washing powder in the compartment first, and then add the water softener.
Fabric conditioner is not completely dispensed or too much water remains in the  compartment.	<p>The siphon is not correctly positioned or is clogged.</p> <ul style="list-style-type: none"> ■ Clean the siphon, see “Cleaning and care – Cleaning the detergent drawer”.
The display is in a different language.	<p>A different language has been selected.</p> <ul style="list-style-type: none"> ■ Switch the washing machine off and on again. <p>The selected supervisor language appears in the display.</p>
	<p>The supervisor language has been changed.</p> <ul style="list-style-type: none"> ■ Select the language you require (see “Language” under “Supervisor level”).
The laundry has not been spun properly. The laundry is still wet.	<p>The machine detected a high level of imbalance during the final spin and reduced the spin speed automatically.</p> <ul style="list-style-type: none"> ■ Include both large and small items in the load as this will achieve better distribution.
The drum remains stationary but the programme keeps running.	<p>Fault in the programme sequence</p> <ul style="list-style-type: none"> ■ Switch the washing machine off and then back on with the  button. ■ Note the message in the display. ■ Touch the <i>Start/Stop</i> sensor control. <p>The drum continues to spin and the programme continues.</p>

Problem solving guide

The door will not open or close

Problem	Cause and remedy
The door will not open.	There is no power to the washing machine. <ul style="list-style-type: none"> ■ Check whether the washing machine is switched on. ■ Check whether the washing machine is connected to the power supply. ■ Check whether the fuse has tripped.
	Power cut <ul style="list-style-type: none"> ■ Open the drum door as described in “Troubleshooting”.
	The water in the washing machine cannot be drained. <ul style="list-style-type: none"> ■ Check whether the drainage system is blocked. Clean the drainage system.
	The door is locked during the wash process. <ul style="list-style-type: none"> ■ Touch the <i>Start/Stop</i> sensor control. ■ Select Programme cancellation or Add laundry. <p>The door will unlock and you will be able to pull it open.</p>
	For safety reasons the drum door cannot be opened if the suds temperature is higher than 50 °C.
Cool down appears in the display at the end of the programme or after a programme has been cancelled.	To protect the user against scalding, the door cannot be opened if the suds temperature is higher than 50 °C. <ul style="list-style-type: none"> ■ Wait until the temperature in the drum has decreased and the message has gone out in the display.
The following appears in the display: F -Door lock fault. Call Service.	The door lock has jammed. <ul style="list-style-type: none"> ■ Contact the Miele Customer Service Department.

To continue a programme after an interruption to the power supply

If a running programme is interrupted, e.g. by a power cut, the programme can be continued when the supply voltage is restored.

- Switch on the washing machine with the  button.
- Then press the “START” button and follow the instructions on the display.

The programme will then continue with the next programme stage of the last active programme sequence.

- Carry out cleaning and maintenance of the washing machine after use if possible.

Do not use a pressure washer or hose to clean the machine.

- Clean the **machine casing, control panel and plastic parts** with a mild, non-abrasive cleaning agent or with a soft, damp cloth only. Wipe dry with a soft cloth.

Scouring agents will scratch the surface.

- Clean stainless steel parts of the casing with a commercially available stainless steel cleaner.
- Remove any deposits from the door seal with a damp cloth.

Penetration of cleaning agents into electrical components.

- When disinfecting the surfaces, use a moist cloth only to clean the front and around the door lock. Do not spray any liquids.

Build-up of rust

The drum is manufactured from rust-free stainless steel. Water or foreign objects containing ferrous substances (e.g. paper clips, metal buttons or metal swarf) which are placed in the machine with the laundry can cause a build-up of rust in the drum. Clean the drum regularly in this case and if rust occurs, remove it immediately with a proprietary stainless steel care product. Check the door seals for ferrous residues and clean thoroughly as described above. This must be carried out regularly.

Cleaning and care

Cleaning the detergent drawer, detergent compartments and siphons

- Clean the detergent drawer and the detergent compartments thoroughly with hot water as required to remove detergent residues and incrustations.
- If the machine is not going to be used for a long time, leave the flap of the detergent drawer open.
- Also clean the siphons in the compartments for cleaning agents.

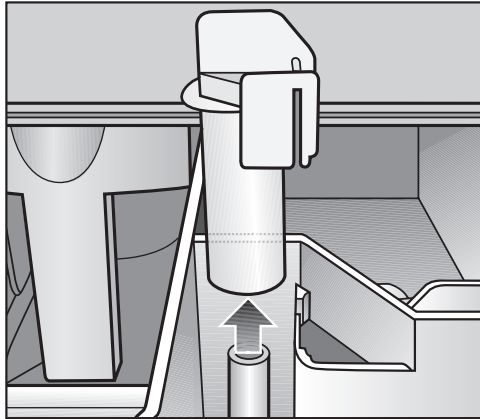

- Remove the siphon. Clean the siphon with hot water and reinsert it.

Cleaning the drip channel and siphon

- Open the flap on the detergent drawer to an angle of 45° and lift out the flap of the detergent drawer on the right side.

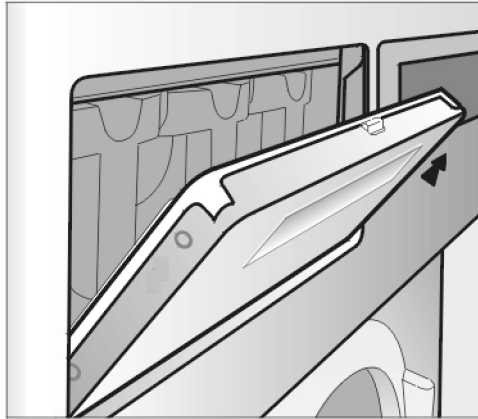

If the drip channel and associated drain connection are blocked, clean them.

- Check the vapour extraction grille on the rear of the machine for contamination from time to time and clean when necessary.

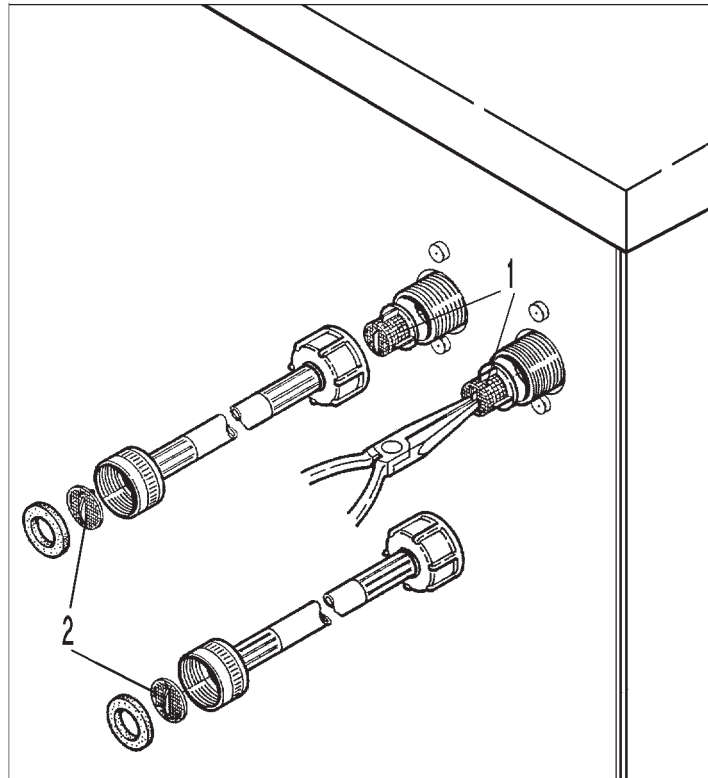

- The filters in the water intake valves (1) and the inlet hoses (2) must be checked for contamination from time to time and cleaned as necessary.

Installing the washing machine

The washing machine must be installed by Miele Customer Service Department or by an authorised dealer. Please observe the information on the installation plan.

This washing machine is only intended for items of laundry that have not been proofed with dangerous or inflammable substances.

- To avoid the risk of frost damage, the machine must not be located in rooms which may be subject to very low temperatures.
- Transport the machine on a pallet truck inside the room.
- Remove the packaging carefully with a suitable tool.
- Lift the machine off the pallet using a lifting device.

Securing the machine

- The washing machine must be secured to the floor using the fixtures and fastenings supplied.

The fastenings included are for bolting the machine to a concrete floor. For other types of flooring at the installation site, please purchase suitable fastening materials separately.

General operating conditions

This washing machine is intended only for use in a commercial environment and must only be operated indoors.

- Ambient temperature: 0-40 °C
- Relative humidity: non-condensing
- Maximum height above sea level of location site: 2000 m

Depending on the nature of the installation site, sound emissions and vibration may occur.

Tip: Have the installation site inspected and seek the advice of a professional in instances where increased noise may cause a nuisance.

For easy maintenance

To facilitate future maintenance and servicing by Customer Service, the minimum dimensions and distance to the wall must be observed to enable access.

- Observe the specified minimum dimensions and distance to the wall and ceiling.

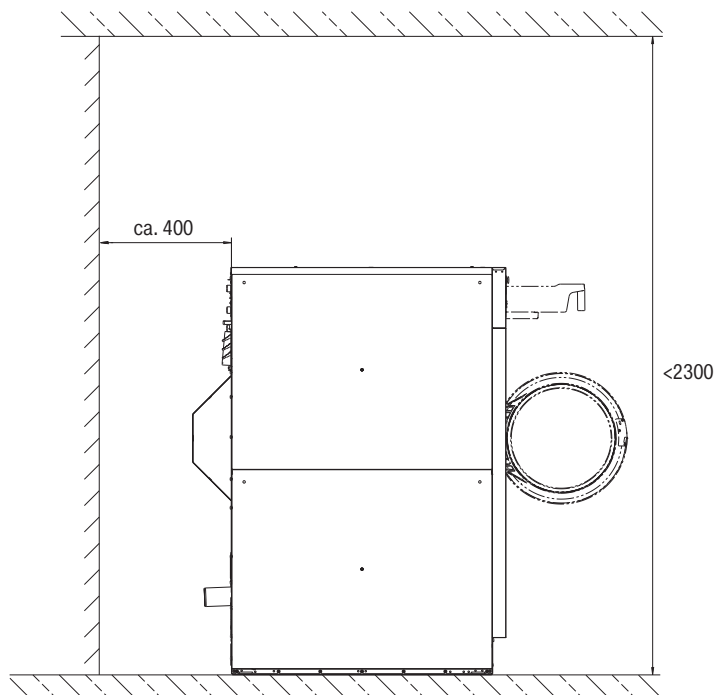

Dimensions in millimetres

Minimum safety distance to the wall approx. 400 mm to allow for maintenance. The ceiling height must be at least 2300 mm.

- Adjust the washing machine until the machine is level.

The washing machine must be completely level to ensure smooth operation.

Water connection

Water pressure (flow pressure) of a minimum of 100 kPa (1 bar)/ maximum of 1000 kPa (10 bar) is required to guarantee a problem-free programme sequence.

The machine must be connected to the water supply using the water inlet hoses provided.

Hoses must be replaced with hoses tested for a burst pressure of at least 7000 kPa (70 bar) and for water temperatures of a minimum of 90 °C.

This also applies for associated connection fittings. Original spare parts meet these requirements.

Tip: The hot water supply must not exceed a maximum temperature of 60 °C. For machines with reduced heater rating and external heating, the incoming hot water must not exceed a temperature of 90 °C. Special hot water gas connection hoses must be used for this purpose.

UK, Australia and New Zealand only

To comply with water regulation requirements, this machine must be connected to the potable to the water supply via the non-return check valve supplied with the machine.

For Germany only

For the protection of drinking water, a non-return valve must be installed between the stopcock and the water connection of the washing machine. If the building's plumbing has been installed correctly, the connections required for this (e.g. angle valve) will already have this safety feature. Make sure that a non-return valve is fitted in the plumbing.

When using a separate non-return valve, observe the following sequence:

1. Attach the non-return valve to the water connection.
2. Attach the water inlet hose to the non-return valve.

 Health risk and risk of damage due to contaminated incoming water.

The quality of the incoming water must correspond to the drinking water specification of the country in which the washing machine is being operated.

Always connect the washing machine to the mains water supply.

 The connection points are subject to water supply pressure.

Turn on the stopcocks slowly and check for leaks. Correct the position of the seal and screw thread if appropriate.

Steam connection

For steam-heated machine variants, the steam connection must only be carried out by an authorised installation technician. The steam valve and the condensate separator are available from the Miele Customer Service Department.

Dispensing pump connections

Up to 12 dispensing pumps can be connected to the washing machine.

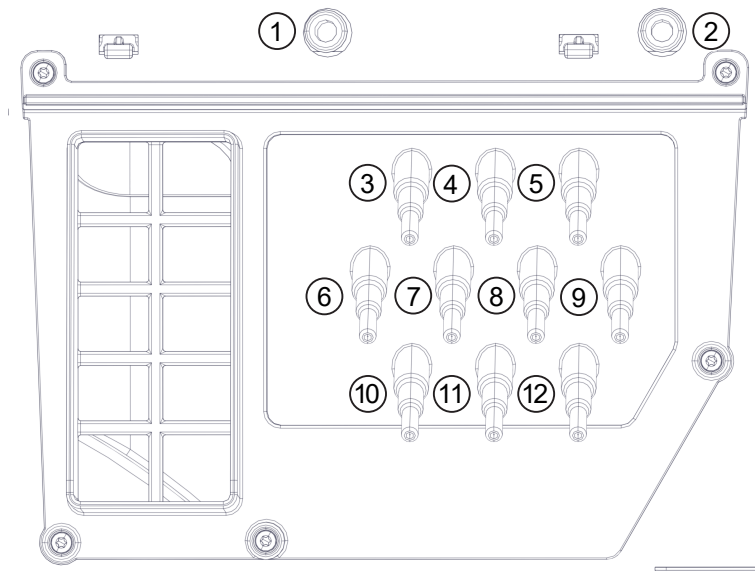

Dispensing pump connections on the back of the machine

Connections **1** and **2** are provided for viscous agents and can also be used for high-pressure dispensing systems with water injection. The dispensing systems must be fitted with a separate drinking water safety mechanism in accordance with EN 61770 and EN 1717. The maximum flow rate is 1500 ml/min with a maximum flow pressure of 300 kPa.

These connectors are sealed and need to be drilled open using a 8 mm drill bit before connecting.

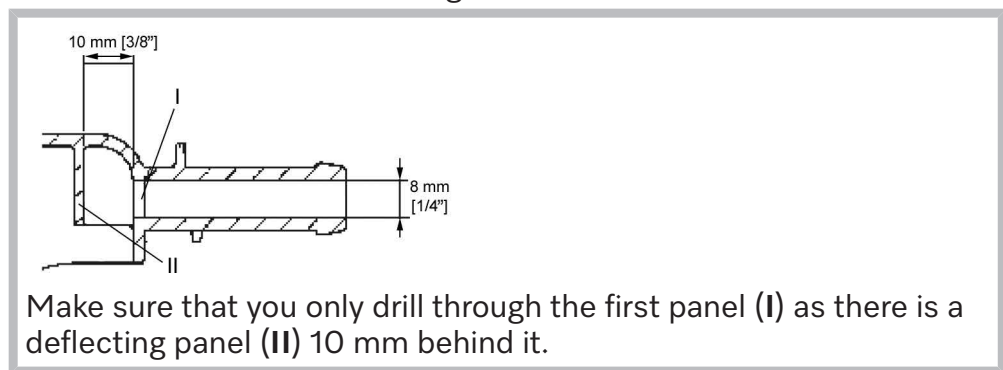

Connections **3** to **12** are provided for liquid detergent. High-pressure dispensing systems with water injection must not be connected to these connections. The connectors are sealed and must be cut to the diameter of the hose with a small saw before they are connected.

If opened connectors are no longer required, they must be resealed using a suitable sealant (e.g. silicone).

External dispensing pumps are connected and calibrated via the Connector Box, which is available as an option.

A flowmeter or flow sensors can also be connected for monitoring the dispensing quantity precisely.

Connections for level monitoring are available for every agent dispensed.

Drainage

Drain valve DV on machine side DN 70, on-site socket DN 70. Flow rate temporary 200 l/min.

If the slope for drainage is extremely steep, the piping must be vented to prevent a vacuum from forming in the washing machine's drainage system.

Electrical connection

The electrical connection must only be carried out by a suitably qualified electrician in accordance with local and national regulations, such as VDE (Germany), ÖVE (Austria) and SEV (Switzerland), and the regulations of the responsible power supply company.

Tip: The connection terminal is located behind the flap on the top rear panel (connecting strip).

If it is necessary to install a residual current device (RCD) in accordance with local regulations, a **residual current device type B** (sensitive to universal current) must be used.

The electrical components of this machine comply with DIN EN 60335-1, DIN EN 50571. The appliance must not be connected to devices such as clocks/timers which would switch it off automatically.

The voltage is stated on the data plate.

For machines with a hard-wired connection, an all-pole means of deactivation must be provided on site. Switches with a minimum contact gap greater than 3 mm are suitable disconnectors. These include circuit breakers, fuses and contactors (VDE 0660).

Automatic switch-off devices (e.g. clock/timers) must not be installed.

The plug connection or isolator switch should be easily accessible at all times.

If the machine is disconnected from the mains power supply, the disconnector must be lockable or the point of disconnection must be monitored at all times.

Supervisor level

Opening the supervisor level

- Switch on the washing machine.

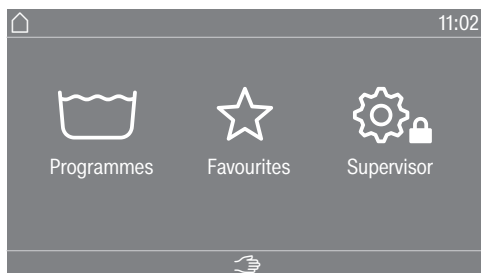

- Touch the Supervisor  sensor control.

The display will change to the Supervisor level menu.

Opening the Supervisor level (self-service)

- Switch on the washing machine and open the door.
- ① Touch the *Start/Stop* sensor control and hold it down whilst carrying out steps ②—③.
- ② Close the washing machine door.
- ③ The *Start/Stop* sensor control will now be flashing quickly; wait until it lights up constantly.
- ④ Release the *Start/Stop* sensor control when the *Start/Stop* sensor control lights up constantly.

Access via code

The supervisor level is accessed using a code.

The code is **8000** (factory default).

After entering the code, you will be in the supervisor level. The individual setting options are described in the following sections.

Changing the code

You can alter the supervisor level access code to protect the washing machine from unauthorised access.

Please inform the Miele Customer Service Department if you have forgotten your new code. The Customer Service Department will have to reset the code.

Make a note of your new code and store it in a safe place.

Closing the Settings menu

- Touch the  symbol.

The display will then go back to the previous menu level.

- Touch the  symbol.

The display will change to the main menu.

Controls / Display

Language

The display contents can be displayed in a variety of languages. To select the permanent supervisor language you want, go to the Languages sub-menu.

When a programme is running, you can change the user language using the  sensor control.

Language entry

The display can be set to one of several different user languages. This setting allows you to determine how languages can be selected.

International

6 languages are available. The  sensor control is not active. Note the setting *Set languages*.

Language selection

The  sensor control can be used to select a language. All languages are available (factory default).

You can change the order of the first 4 languages. These slots are allocated to the most commonly used languages.

Standard language

The user language cannot be changed. The user language is the same as the supervisor language. The  sensor control is not active.

Supervisor level

Set languages

The languages for the setting Language entry International can be changed.

6 languages can be selected. All languages are available.

If you wish to add a new language to the language menu:

- First select the language you want to replace.

All available languages are displayed.

- Select and confirm the language to replace the previous language.

The new language appears instead of the old one.

Time

After selecting the clock format, you can set the time of day.

Time format

- 24 h clock
- 12 h clock
- No clock

Set

- The time can be set.

Date

The date can be set after selecting the date format.

Date format

- DD.MM.YYYY
- YYYY.MM.DD
- MM.DD.YYYY

Date

- The date can be set.

Logo

Different logos can be selected for the user interface.

Start screen

Different views can be selected for the start screen. The start screen is displayed after exiting a sub-menu.

Mode

Different supervisor modes can be selected.

Display brightness

The brightness of the display can be altered. The setting depends on the various lighting conditions in the place of installation.

It can be set to one of 10 different levels.

Display off status

In order to save energy, the display can be set to switch to standby mode automatically after the end of the programme or if no further selection is made. In the default setting, the machine will not switch to standby mode automatically.

Changing this factory default setting leads to increased energy consumption.

- Off
- On (10 min.) Not curr.prog.
- Logo (10 min.) Not curr.prog.
- On after 10 min.
- On (30 min.) Not curr.prog.

	<ul style="list-style-type: none">- Logo (30 min.) Not curr.prog.- On after 30 min.
Appliance off status	<p>In order to save energy, the washing machine can be set to switch to standby mode automatically after the end of the programme or if no further selection is made. In the default setting, the machine will not switch to standby mode automatically.</p> <p>Changing this setting leads to increased energy consumption.</p> <ul style="list-style-type: none">- No switch-off (factory default)- Switch-off after 15 minutes- Switch-off after 20 minutes- Switch-off after 30 minutes
Volume	<p>The volume for various sounds can be changed.</p> <p>It can be set to one of 7 different levels or switched off altogether.</p> <ul style="list-style-type: none">- Finish tone- Keypad tone- Welcome tone- Fault tone <p>The fault tone can be activated or deactivated.</p>
Visibility parameters	<p>Various parameters, such as the temperature, spin speed, Extras, etc., are displayed when a programme is selected. You can decide which parameters should not be displayed. The parameters cannot be changed/are no longer displayed.</p> <p>Factory default: all parameters are visible (marked in orange)</p>
Sorting Extras	<p>Under the setting Visibility parameters, Sort Extras appears in the bottom line. Touch the sensor control to change the sequence of Extras (see "Arranging programmes" under "Supervisor level").</p>
Delay start	<p>The delay start (timer) display can be switched on or off.</p> <p>Factory default: on</p>
Memory	<p>The washing machine will save the settings (temperature, spin speed and some of the options) which have been selected for a wash programme after the programme has started.</p> <p>When the wash programme is chosen again, the saved settings will appear on the washing machine's display.</p> <p>Factory default: off</p>
Manual control	<p>The manual control function can be switched on or off. Switch-on can be carried out with or without identification.</p>
Change order	<p>The skip function can be switched on or off.</p>
Measuring system	<p>You can choose whether the temperature and weight are displayed in metric or imperial units.</p>

Supervisor level

Supervisor code

You can alter the access code to the supervisor level. The supervisor code and the expert code are two separate codes.

- Enter the current code.
- Enter a new code.

When creating a new code, number sequences such as 1234 and four-digit numbers such as 2222 are not permitted.

WiFi

In this menu, you control the networking of your washing machine (see “Networking”).

Programme selection

Controls

Tip: Start by configuring all necessary settings and changes to the washing machine before adjusting any of the options below.

If “Laundrette, basic” or “Laundrette Logo” is selected, the supervisor level can no longer be opened from the display after the *Supervisor level* menu is closed. Please follow the instructions below for special access to the supervisor level if you wish to change any other settings.

Standard (factory default).

All functions and programmes can be displayed.

Laundrette, basic

Up to 24 programmes are available. Go to *Favourite programmes* to select which programmes are to be listed.

Laundrette logo

Up to 24 programmes are available. Go to *Favourite programmes* to select which programmes are to be listed.

External programme selection

Programmes are selected using a communication module with Ethernet, e.g. via an external terminal.

Programme packages

The selection of programmes can be expanded by activating single programmes from the target group programme packages.

The programmes selected from the programme packages (marked in orange) are displayed during programme selection.

Favourite programmes

After switching on, you can also select a programme via: ☆ Favourites.

24 programmes can be stored as favourites based on your own priorities and requirements.

These favourites will also be made available in the control options

- *Laundrette logo*

- *Laundrette, basic* control options.

You can specify the control option under *Controls*.

Tip: You can assign a separate coloured frame to each programme. In this case, the “Colour allocation programme setting must be set to *On*.”

Changing favourite programmes

- Select the programme you wish to change or replace.
 - Confirm the programme or the setting to be changed.
- Another menu opens, enabling you to select a new programme or change the parameters.

- Confirm by touching the **Save** selection area.

Your selection is now active.

Sort programmes

Programmes can be moved within the programme list and in the favourites list.

Factory default: off

Moving programmes

- Touch the selection area for the programme you want to move.
- Press and hold the selection area until the frame changes.
- Drag the programme to the required place.

Prog. colour allocation

You can assign a frame to a favourite programme. In the list of favourites, each favourite programme is given a coloured frame, which can be adjusted.

Factory default: on

Expert code

A code has to be entered to cancel a disinfection programme. The code can be modified.

The expert code and the supervisor level code are two separate codes.

The code is: 8 0 0 0

Make a note of your new code if you ever change it.

Process technology

Anti-crease

The Anti-crease function reduces creasing after the end of the programme. At the end of the programme, the drum continues to turn at intervals for up to 30 minutes.

The washing machine door can be opened at any time.

Factory default: on

Automatic drainage

Automatic water drainage can be switched on or off. Automatic water drainage means that the suds are always drained away after the end of a programme. This is also the case for programmes that reach the programme end with water still in the drum.

Factory default: off

Supervisor level

Service

Service interval

Service information can appear in the display. You can configure whether a date or the number of operating hours is displayed.

You can select up to 2 messages with their own text.

Your message is displayed at the end of the programme and can be acknowledged with *OK*. The same message appears at the end of the next programme.

Settings

This setting allows you to determine the interval (by hours or date) at which the message appears.

- Factory default: off
- By time
You can then select a time interval from 1–9999 hours.
- By date
You can then enter a date.

Message text

Enter your message for your planned maintenance work.

Reset display

The message appears until the display is permanently reset. The message then appears again once the next interval is reached.

External applications

Payment system lock

The payment device lock can be switched on or off. When the lock is switched on, the duration until locking can be selected from various time intervals.

Connector box

External hardware is connected via the Connector Box. This can be switched on or off.

The Connector Box must be selected in order for settings to be made in the Dispensing menu.

FOC programmes

The free programmes option can be switched on or off.
Off: It is not possible to run programmes free of charge.
On: The programmes configured as free can be run.

WRG

The water from the machine is fed into the water recovery system. This option can be switched on or off.

Automatic dispensing

Automatic dispensing can be switched on or off.
Automatic dispensing can be activated via the Connector Box or the COM module.

Dosage

The Connector Box must be switched on in order for settings to be adopted in the Dispensing menu.

1–6 dispensing pumps can be switched on.
Further settings can be made after activating the dispensing pump.

- Deactivate disp. pump
- Calibration

- Flow rate (new): ml/min
- Correction factor
- Container size
- Adv. warning level reminder
- Reset adv. warning
- Level reminder
- Flow meter

Peak load prevention

The peak-load prevention function can be switched on or off. With this function, the execution of a wash programme is not affected when a peak-load signal is in place. The heater stays switched on.

WiFi

In this menu, you control the networking of your washing machine (see "Networking").

Appliance parameters

Maximum spin speed

The maximum spin speed can be set via a keypad.

Max. possible temperature

The maximum temperature can be set via a keypad.

Legal information

Open source licences

You can view information here (see WiFi data protection).

Payment system

The Miele Connector Box accessory unit or the COM module is required to connect a payment device.

- No payment system
The next settings are skipped.
- CB timed operation
The washing machine operates in time mode via the Connector Box.
- COM reserve operation
The washing machine operates in IP booking mode based via the COM module.
- CB prog. control
The washing machine operates in programme mode via the Connector Box.
- COM prog. control
The washing machine operates in IP programme mode based via the COM module.

Setting for payment systems

If you wish to change the settings after the commissioning process, please contact Miele Service.

Connectivity

Pairing instructions

Follow the steps below to connect the washing machine to your network.

Network connection

Miele Professional washing machines can be integrated into local networks to utilise Miele's digital solutions or communicate with external systems. The washing machines are equipped with an integrated WiFi module for this purpose. In addition, the washing machines each have an Ethernet connection at the rear for setting up wired interfaces.

⚠ Unauthorised access poses a health risk.

Settings in the washing machine, e.g. parameters for disinfection or the dispensing of process chemicals, may be changed as a result of unauthorised access via the network. Under no circumstances should it be possible to access the washing machine via the Internet or other public or unsecured networks, either directly or indirectly (e.g. using port forwarding).

1. The washing machine should be operated only in a separate network segment which meets one of the following requirements:
 - It is physically separated from other network segments
 - Access to the segment is restricted by a firewall or a router which has been configured accordingly
2. Limit access to this separate network segment to persons requiring access in the course of their work.
3. Use strong passwords to protect access to systems that are connected to the washing machine.
4. Configure the Ethernet interface.

Opening the supervisor level

- Select the Supervisor menu option in the appliance display.
- Select the Access via code menu option.
- Enter the 4-digit supervisor code.

Initial network setup

- Select the External applications menu option from the Supervisor level menu.
- Select WiFi / LAN.

The options in the WiFi / LAN menu vary depending on whether the WiFi interface is already set up or needs to be set up.

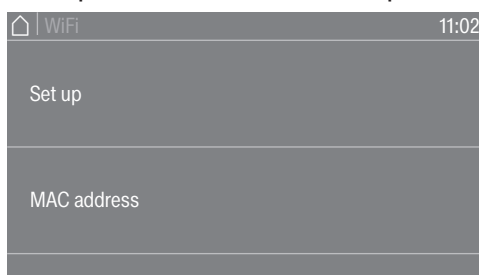

- Select Set up to connect the machine to a network.

The message Set up only appears if the washing machine has not yet been connected to a WiFi network. Various options are available for setting up the WiFi interface.

- Select MAC address to read out the MAC addresses of the network adapters.

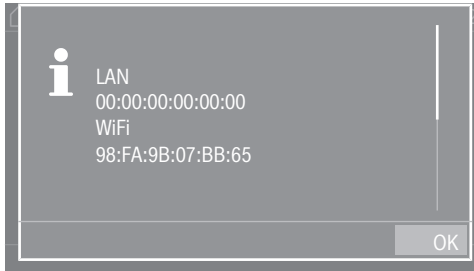

The MAC address of the network adapters is displayed. No settings can be made.

Setting up a network connection manually

- Select the External applications menu option from the Supervisor level menu.
- Then select the WiFi / LAN menu option.
- Select Set up.
- Select the Manual connection method.

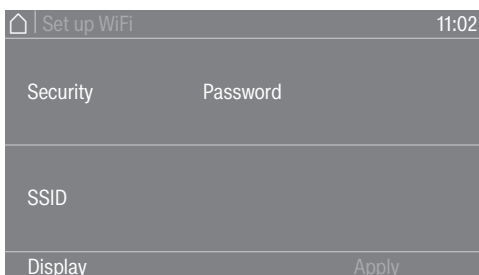
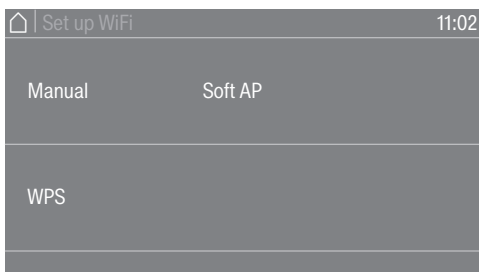

- Select Security to set the security standard for the wireless connection.
- Select Password to enter the WiFi password.
- Select SSID to enter the network name (SSID).

You can view all settings for Security, Password and SSID under Display.

- Save all settings with Apply.

Connectivity

Establishing the network connection via WPS

- Select the External applications menu option from the Supervisor level menu.
- Then select the WiFi / LAN menu option.
- Select Set up.
- Select the Via WPS connection method.
- Now press the WPS button on your router and confirm with OK in the appliance display.

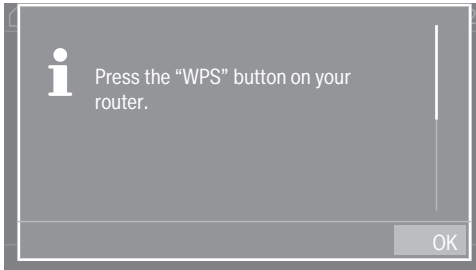

A timer starts. The network connection via WPS is being established.

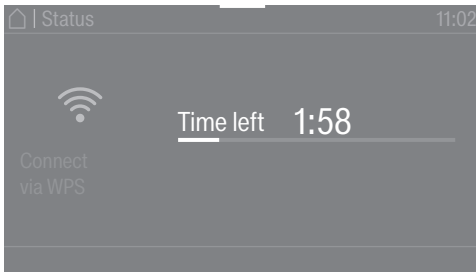

The appliance is now successfully connected.

- Touch OK to confirm.

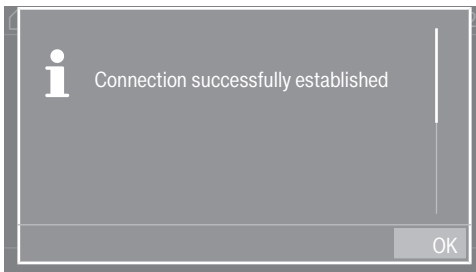

Establishing the network connection via soft AP

- Select the External applications menu option from the Supervisor level menu.
- Then select the WiFi / LAN menu option.
- Select Set up.
- Select the Via Soft AP connection method.
- Confirm by pressing OK and follow the instructions in the external application.

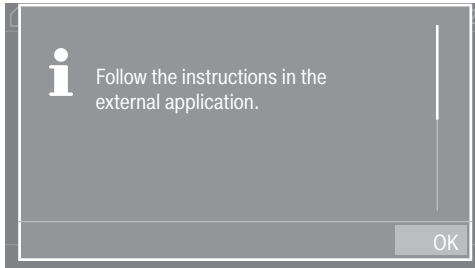

The display shows the message *Waiting for connection for approx. 10 minutes*. If the connection is successful, a message is then displayed. If the connection has failed, the message *Connection failed* is displayed.

- If the connection fails, confirm with OK and start a new connection attempt.

Establishing the network connection using a LAN cable

- Connect the appliance to your router/switch using the network cable.

The appliance is now successfully connected.

Connectivity

WiFi/LAN interface configured

Once the network connection has been successfully set up, you can select further options in the menu.

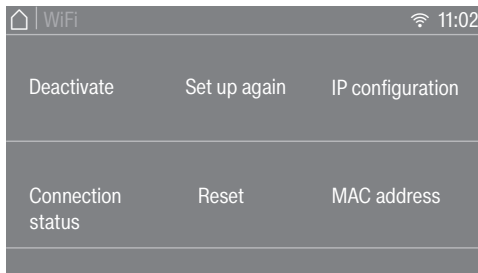

- The WiFi function is switched off with Deactivate (visible when the network is activated). The network remains set up.
- The WiFi function is reactivated with Activate (visible when the network is deactivated).
- All network parameters are displayed under Connection status.
- You can set up the WiFi interface again under Set up again.
- Use Reset to disconnect the network setup. The WiFi function is deactivated and the WiFi connection will be reset to the factory default. A new connection has to be established in order to use the network again.
- You can configure the IP settings manually under IP configuration. The interface can be set up via a Dynamic Host Configuration Protocol (DHCP). If you deactivate the DHCP setting, you can configure the interface using the following parameters:
 - IP address
 - Subnet mask
 - Gateway
 - DNS Auto
 - DNS server 1
 - DNS server 2
- The address of the network adapters is displayed under MAC address.

Technical data

System requirements for WiFi

- WiFi 802.11b/g/n
- 2.4 GHz band
- WPA/WPA2 encryption
- DHCP activated
- Multicast DNS / Bonjour / IGMP snooping activated
- Ports 443, 80, 53 and 5353 open
- IP DNS server = IP standard gateway/router
- Mesh/repeater use: same SSID and password as standard gateway/router
- SSID must be permanently visible



System requirements for LAN

- DHCP activated
- Multicast DNS / Bonjour / IGMP snooping activated
- Ports 443, 80, 53 and 5353 open
- IP DNS server = IP standard gateway/router

WiFi signal strength – Guide values

The WiFi signal strength is only a rough guide. These details do not provide absolute certainty.

The WiFi signal strength can be read directly on the machine.

WiFi signal strength		Meaning
	 *	
76–100 %	3/3**	Generally, reliable operation possible
51–75 %	2/3	
26–50 %	1/3	Generally, operation possible
1–25 %	0/3	Generally, reliable operation not possible
0 %		Operation not possible

* Displayed on the machine

** Number of bars  3/3–0/3

The signal strength can be adversely affected by many factors, including:

- People in the room
- Open or closed doors
- Moved objects
- Varying radio signal sources or interference
- Other equipment with Bluetooth or WiFi wireless technology

Technical data

PWM 927 machine data

Installation dimensions

Casing width (without add-on components)	1090 mm
Casing height (without add-on components)	1643 mm
Appliance depth (without add-on components)	1106mm
Overall machine width	1090 mm
Overall machine height	1646 mm
Overall machine depth	1228 mm
Minimum width of transport opening	1190mm
Minimum safety distance between wall and machine front	1800 mm
Diameter of door opening	415mm
Door opening angle	180°

Electrical connection

Supply voltage	See data plate
Frequency	See data plate
Power rating	See data plate
Current consumption	See data plate
Fuse rating	See data plate
Heater rating	See data plate

Weight and floor load

Net weight	see installation plan
Max. floor load in operation	see installation plan

Emission values

Emission sound pressure level in workplace in accordance with EN ISO 11204/11203	< 70 dB(A) re 20 µPa
Sound power level, EN ISO 9614-2	< 83.6 dB(A)

Product safety

Product safety standard	EN 60335-1, EN 50571, IEC 60335-1, IEC 60335-2-7
-------------------------	--

WiFi

Frequency range of the WiFi module	2.400–2.4835 GHz
Maximum transmission power of the WiFi module	< 100 mW

PWM 935 machine data

Installation dimensions

Casing width (without add-on components)	1090 mm
Casing height (without add-on components)	1643 mm
Appliance depth (without add-on components)	1106 mm
Overall machine width	1090 mm
Overall machine height	1646 mm
Overall machine depth	1275 mm
Minimum width of transport opening	1190 mm
Minimum safety distance between wall and machine front	1800 mm
Diameter of door opening	415 mm
Door opening angle	180°

Electrical connection

Supply voltage	See data plate
Frequency	See data plate
Power rating	See data plate
Current consumption	See data plate
Fuse rating	See data plate
Heater rating	See data plate

Weight and floor load

Net weight	see installation plan
Max. floor load in operation	see installation plan

Emission values

Emission sound pressure level in workplace in accordance with EN ISO 11204/11203	< 70 dB(A) re 20 µPa
Sound power level, EN ISO 9614-2	< 83.6 dB(A)

Product safety

Product safety standard	EN 60335-1, EN 50571, IEC 60335-1, IEC 60335-2-7
-------------------------	--

WiFi

Frequency range of the WiFi module	2.400–2.4835 GHz
Maximum transmission power of the WiFi module	< 100 mW

Technical data

EU declaration of conformity

Miele hereby declares that this washing machine complies with Directive 2014/53/EU. The complete text of the EU declaration of conformity is available from one of the following Internet addresses:

- Or go to <http://www.miele.de/professional/gebrauchsanweisungen-177.htm> and enter the name of the product or the serial number

UK declaration of conformity

UKCA mark (UK only)

The Supply of Machinery (Safety) Regulations 2008

Miele hereby declares that this washing machine complies with UK Radio Equipment Regulations 2017, as amended.

The complete text of the UK declaration of conformity is available from one of the following internet addresses:

- Products, Downloads from www.miele.co.uk
- For service, information, operating instructions etc: go to www.miele.co.uk and enter the name of the product or the serial number

This **Statement of Compliance** confirms this Miele product fully complies with the **Product Security and Telecommunications Infrastructure (Security Requirements for Relevant Connectable Products) Regulations 2023**.

- 1) Professional Appliance – *Washing machine, commercial PW013, PW014*
- 2) Manufactured by: Miele & Cie KG,
Carl Miele Street 29, 33332 Gutersloh Germany
Imported by and contact point: Miele Company Ltd, Fairacres, Marcham Road,
Abingdon, Oxon, OX14 ITW Great Britain
- 3) The defined support period at the time of first supply is 10 years
- 4) To report vulnerabilities and cybersecurity issues please contact: psirt@miele.com

- 5) Signature 
Name: **Paul Wright**
Company Position: **Head of Technical Management**
Date of signature: **19th March 2024**
Place of signature: **Abingdon, Oxfordshire**

Data protection and data security

When you activate the networking function and connect your machine to the Internet, your machine sends the following data to the Miele Cloud:

- Machine serial number
- Machine model and technical features
- Machine status
- Information about the software status of your machine

Initially, this data cannot be assigned to a specific user and is not saved permanently. Data cannot be saved permanently or assigned to a specific user until after you have linked your machine to a user. Data transmission and processing are governed by Miele's strict security standards.

Factory default settings for network configuration

You can reset all of the settings on the communication module or your integrated WiFi module to the factory default settings. The network configuration should be reset whenever a machine is being disposed of or sold, or if a used machine is being put into operation. This is the only way to ensure that all personal data has been removed and the previous owner will no longer be able to access the machine.

Copyright and licences

For the purpose of operating and controlling the communication module, Miele uses proprietary or third-party software that is not covered by open source licensing terms. This software/these software components are protected by copyright. The copyrights held by Miele and third parties must be respected.

Furthermore, this communication module contains software components which are distributed under open source licensing terms. The open source components contained in the machine along with the corresponding copyright notices, copies of the licensing terms valid at the time and any further information can be accessed locally by IP using a web browser (*https://<IP address>/Licenses*). The liability and warranty arrangements for the open source licences displayed in this location only apply in relation to the respective rights holders.

United Kingdom

Miele Co. Ltd., Fairacres, Marcham Road
Abingdon, Oxon, OX14 1TW
Professional Sales, Tel: 0845 365 6608
E-mail: professional@miele.co.uk
Internet: www.miele-professional.co.uk

Australia

Miele Australia Pty. Ltd.
ACN 005 635 398, ABN 96 005 635 398
Level 4, 141 Camberwell Road, Hawthorn East, VIC 3123
Tel: 1300 731 411
Internet: www.miele-professional.com.au
E-mail: professional.sales@miele.com.au

China Mainland

Miele Electrical Appliances Co. Ltd.
No. 82, Shimenyi Road, JingAn District,
Shanghai, China, P.R.C, Post Code: 200040
Phone: +86 21 6157 3500, Fax: +86 21 6157 3511
E-mail: info@miele.cn, Internet: www.miele.cn

Hong Kong, China

Miele (Hong Kong) Ltd.
41/F - 4101, Manhattan Place
23 Wang Tai Road, Kowloon Bay, Hong Kong
Tel: (852) 2610 1025, Fax: (852) 3579 1404
Email: customerservices@miele.com.hk
Website: www.miele.hk

India

Miele India Pvt. Ltd.
1st Floor, Copia Corporate Suites,
Commercial Plot 9, Mathura Road, Jasola,
New Delhi - 110025
E-mail: customercare@miele.in, Website: www.miele.in

Ireland

Miele Ireland Ltd.
2024 Bianconi Ave., Citywest Business Campus,
Dublin 24
Tel: (01) 461 07 10, Fax: (01) 461 07 97
E-Mail: info@miele.ie, Internet: www.miele-professional.ie

Malaysia

Miele Sdn Bhd
Suite 12-2, Level 12
Menara Sapura Kencana Petroleum
Solaris Dutamas No. 1, Jalan Dutamas 1
50480 Kuala Lumpur, Malaysia
Phone: +603-6209-0288
Fax: +603-6205-3768

New Zealand

Miele New Zealand Limited
IRD 98 463 631
8 College Hill
Freemans Bay, Auckland 1011, NZ
Tel: 0800 464 353
Internet: www.miele-professional.com.au
E-mail: professional.sales@miele.com.au

Singapore

Miele Pte. Ltd.
29 Media Circle, #11-04 ALICE@Mediapolis
Singapore 138565
Tel: +65 6735 1191, Fax: +65 6735 1161
E-Mail: info@miele.com.sg
Internet: www.miele.sg

South Africa

Miele (Pty) Ltd
63 Peter Place, Bryanston 2194
P.O. Box 69434, Bryanston 2021
Tel: (011) 875 9000, Fax: (011) 875 9035
E-mail: info@miele.co.za
Internet: www.miele.co.za

United Arab Emirates

Miele Appliances Ltd.
Showroom 1, Eiffel 1 Building
Sheikh Zayed Road, Umm Al Sheif
P.O. Box 114782 - Dubai
Tel. +971 4 3044 999, Fax. +971 4 3418 852
800-MIELE (64353)
E-Mail: info@miele.ae
Website: www.miele.ae



Manufacturer: Miele & Cie. KG, Carl-Miele-Straße 29, 33332 Gütersloh, Germany