













Operating and installation instructions Commercial washer-dryer stack PDW 909 GB

Always read the operating instructions before setting up, installing and commissioning the machine. This prevents both personal injury and damage to the machine.

en-GB

Contents

Caring for the environment	8
Disposing of your old machine	8
Safety instructions and warnings	9
Explanation of the safety notes and warnings on the machine	9
Appropriate use	10
Foreseeable misuse	11
Technical safety	12
Correct use.....	14
Chlorine and component damage.....	17
Accessories	18
Disposing of your old machine	18
Description of the machine	19
Description of the machine.....	19
Operation	21
Control panel.....	21
Sensor controls and touch display.....	22
Main menu	22
Main menu	23
“  Programmes” menu.....	23
“  Favourites” menu.....	23
“  Supervisor” menu	23
Examples of how to operate the machine	23
Operating a laundrette machine.....	26
Washing	27
Preparing for use	27
Loading and switching on the washing machine	27
Loading the washing machine	27
Washing with detergent drawer	30
Adding detergent using the detergent drawer.....	30
Adding fabric conditioner or liquid starch separately.....	30
Adding starch separately	30
Selecting a programme	32
Selecting programme settings	33
Selecting Extras	36
Pre-wash 	36
Soak 	36
Rinse plus 	36
Rinse hold 	36
Filling stop 	36
Intensive 	36
Water plus 	36
Programme start – programme end	37
Timer	38
Special features in the programme sequence.....	38
Spinning	38
Anti-crease	39
Skip	40
Manual control	40

Drying	43
1. Notes on correct laundry care	43
Washing before drying	43
Removing foreign objects	43
Care symbols	43
2. Loading the tumble dryer	44
3. Selecting a programme	44
Switching on the tumble dryer	44
4. Selecting programme settings	45
Select the drying level	45
Selecting extra options	45
5. Starting a programme	47
Payment device (optional)	47
Calling up current programme parameters	47
Programme running time/Time left estimation	47
End of the programme	48
End of programme	48
Removing the laundry	48
Care notes	48
Timer	48
Prerequisite for setting the timer	48
Setting the timer	48
Changing the programme sequence	49
Washing machine	49
Changing a programme	49
Interrupting a programme	49
Switching on the washing machine after an interruption to the power supply	49
Adding or removing laundry	51
Tumble dryer	52
Changing a programme once it has started	52
Cancelling the current programme	52
Adding laundry	52
Time left	52
Problem solving guide	54
Troubleshooting	54
Customer service	55
Problem solving guide	55
A programme cannot be started	55
Programme cancellation and fault message	56
The display shows a message	56
Insufficient wash results	57
Insufficient drying results	57
General problems with the washer-dryer stack	59
The door will not open or close	60
Opening the door in the event of a blocked drain outlet and/or power cut	61
Cleaning and care	63
Build-up of rust	63
Cleaning the detergent drawer, detergent compartments and siphons	64
Cleaning the water inlet filters	66

Contents

Cleaning the fluff filter	67
Removing the fluff filter	67
Dismantling the fluff filter	67
Cleaning the fluff filter parts (dry)	68
Cleaning the fluff filter parts (wet)	68
Inserting the fluff filter	68
Cleaning the air supply area	70
Rapid cleaning	70
Additional cleaning	70
Installation	73
General operating conditions	73
For ease of maintenance	74
PDW 909	74
Installing the washer-dryer stack	75
Transit bars	77
Levelling	79
Securing the machine	80
Water connection	82
Use of non-return valves	82
Cold water connection	83
Using the machine in cold water mode	83
Hot water connection	83
Using the machine in hot water mode	83
Electrical connection	84
Supply air and exhaust air management	85
Ventilation	85
Exhaust air management	85
Calculating the total ducting length	86
Exhaust duct dimensions	87
Exhaust air management with plug-in pipes	88
Exhaust air management with flexible aluminium hose	88
Shared exhaust air ducts	89
Reference to external machines	90
Optional accessories	90
Washing machine accessories	90
Tumble dryer accessories	92
Washing machine supervisor level	93
Opening the supervisor level	93
Access via code	93
Changing the code	93
Closing the Settings menu	93

Controls / Display.....	94
Language.....	94
Language entry.....	94
Set languages.....	94
Time.....	94
Date.....	94
Logo.....	95
Start screen.....	95
Mode.....	95
Display brightness.....	95
Display off status.....	95
Appliance off status.....	95
Volume.....	95
Visibility parameters.....	95
Delay start.....	96
Memory.....	96
Manual control.....	96
Change order.....	96
Measuring system.....	96
Supervisor code.....	96
WiFi.....	96
Programme selection.....	97
Controls.....	97
Programme packages.....	98
Favourite programmes.....	98
Sort programmes.....	98
Prog. colour allocation.....	98
Expert code.....	98
Process technology.....	99
Anti-crease.....	99
Automatic drainage.....	100
Service.....	100
Service interval.....	100
External applications.....	100
Payment system lock.....	100
Connector box.....	100
Automatic dispensing.....	100
Dosage.....	100
Peak load prevention.....	101
Appliance parameters.....	101
Maximum spin speed.....	101
Max. possible temperature.....	101
Legal information.....	101
Tumble dryer supervisor level.....	102
Opening the Supervisor level.....	102
Access via code.....	102
Change code.....	102
Closing the settings menu.....	102

Contents

Controls / Display.....	102
Language.....	102
Language entry.....	102
Set languages.....	103
Display brightness.....	103
Clock display.....	103
Date.....	103
Volume.....	103
Res. moisture display.....	104
Visibility parameters.....	104
Display off status.....	104
Machine off status.....	104
Delay start.....	104
Memory.....	105
Temperature unit.....	105
Weight unit.....	105
Change code.....	105
Programme selection.....	105
Controls.....	105
Programme packages.....	106
Favourite programmes.....	106
Special programmes.....	107
Sort programmes.....	108
Prog. colour allocation.....	108
Process technology.....	108
Anti-crease.....	108
Drying levels.....	108
Further cooling.....	109
Cooling down temperature.....	109
Fan pulsed operation.....	109
Service.....	109
Clean out the airways.....	109
Clean the filters.....	110
Service interval.....	110
External applications.....	111
External exhaust flap.....	111
Additional fan.....	111
Pressure sensor.....	111
Peak load signal.....	111
Peak load prevention.....	111
COM module selection.....	112
Availability of Miele digital products.....	112
WiFi / LAN.....	112
Network time.....	112
Remote.....	113
Remote update.....	113
SmartGrid.....	113
Machine parameters.....	114
Legal information.....	114
Payment system.....	114
Setting for payment systems.....	114

Connectivity	115
Pairing instructions	115
Network connection.....	115
Opening the supervisor level	115
Initial network setup.....	115
Setting up a network connection manually	116
Establishing the network connection via WPS	117
Establishing the network connection via soft AP	118
Establishing the network connection using a LAN cable.....	118
WiFi/LAN interface configured.....	119
Technical data	119
Technical data	121
PDW 909 machine data	121
Electrical connection.....	121
Installation dimensions.....	121
Weight and floor load.....	121
Plumbing.....	121
Air intake	121
Vented system	122
Emission values.....	122
Product safety	122
WiFi.....	122
EU declaration of conformity.....	123
WiFi data protection	124
Data protection and data security	124
Factory default settings for network configuration	124
Copyright and licences	124

Caring for the environment

Disposal of the packing material

The packaging is designed to protect the appliance from damage during transportation. The packaging materials used are selected from materials which are environmentally friendly for disposal and should be recycled.

Recycling the packaging reduces the use of raw materials in the manufacturing process and also reduces the amount of waste in landfill sites.

Disposing of your old machine

Old electrical and electronic machines often contain valuable materials. However, they also contain harmful substances which were essential for their correct functioning and safety. These could be hazardous to human health and to the environment if disposed of with household waste or if handled incorrectly. Please do not, therefore, dispose of your old machine with household waste.

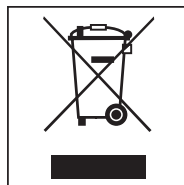

Please dispose of it at your local community waste collection/recycling centre. Consult your dealer if necessary. Please ensure that your old machine poses no risk to children while being stored for disposal.

Energy saving tips

Energy and water consumption

- To get the most out of your machine, load the **maximum** dry load size for the wash programme you are using. Energy and water consumption is most efficient when a full load is washed.
- If suitable, use programmes from the ECO programme package. The programmes are characterised by particularly low energy consumption.

Detergents

- Do not exceed the amounts of detergent recommended by the manufacturer on the packaging.
- Reduce the amount of detergent for smaller load sizes.





When drying with a tumble dryer

Select the highest possible spin speed for the wash programme to save energy in the subsequent tumble dryer cycle.

Safety instructions and warnings

Original operating instructions

Explanation of the safety notes and warnings on the machine

	Read the operating instructions
	Warning, hot surfaces
	Warning, voltage up to 1000 volts
	Protective earthing
	Equipotential bonding

This washer-dryer stack complies with all relevant current safety requirements. Inappropriate use can, however, lead to personal injury and material damage.

Read the operating instructions carefully before using the washer-dryer stack. They contain important information on safety, installation, use and maintenance. This prevents both personal injury and damage to the washer-dryer stack.

In accordance with standard IEC 60335-1, Miele expressly and strongly advises that you read and follow the instructions in the chapter on installing the washer-dryer stack as well as the warnings and safety notes.

Miele cannot be held liable for injury or damage caused by non-compliance with these instructions.

Keep these operating instructions in a safe place and pass them on to any future owner.

When instructing other people how to use the washer-dryer stack, they must be made aware of these warnings and safety notes.

Safety instructions and warnings

Appropriate use

- ▶ The washing machine is only suitable for washing fabrics with a care label stating that they are suitable for machine washing. Any other applications may be dangerous. The manufacturer cannot be held liable for damage resulting from incorrect or improper use or operation of the machine.
- ▶ This tumble dryer is only intended for drying fabrics which have been washed in a water solution, and marked on the manufacturer's care label as being suitable for tumble drying. "Dry cleaning kits" for freshening up garments in a tumble dryer are increasingly available on the market. If using, do so at your own risk, and follow the instructions provided on the packaging. Any other applications may be dangerous. Miele cannot be held liable for damage resulting from incorrect or improper use or operation.
- ▶ The washer-dryer stack must be used as described in the operating instructions and must be checked on a regular basis to make sure it is functioning correctly.
- ▶ The washer-dryer stack is not suitable for outdoor use.
- ▶ Do not install the washer-dryer stack in a room where there is a risk of frost. Frozen hoses are at risk of tearing or bursting. The reliability of the electronic module may be impaired at temperatures below freezing point.
- ▶ This washer-dryer stack is intended only for use in a commercial environment.
- ▶ If the machine is used in a commercial environment it may only be operated by instructed/trained personnel. If the machine is used in a publicly accessible area, the supervisor must ensure that it can be operated safely without risk of danger.
- ▶ The washer-dryer stack must not be used in a non-stationary installation site (e.g. on a ship).
- ▶ This washer-dryer stack can only be used by people with reduced physical, sensory or mental capabilities, or lack of experience or knowledge, if they are supervised whilst using it or have been shown how to use it in a safe way and understand and recognise the consequences of incorrect operation.
- ▶ Children under the age of 8 must not be allowed near the washer-dryer stack unless they are constantly supervised.
- ▶ Children aged 8 and older may only use the washer-dryer stack without supervision if they have been shown how to use it and are able to do so in a safe manner. Children must be able to understand and recognise the possible dangers caused by incorrect operation.
- ▶ Children may not carry out cleaning or maintenance on the washer-dryer stack unsupervised.
- ▶ Always supervise any children in the vicinity of the washer-dryer stack. Never allow children to play with the washer-dryer stack.
- ▶ Disinfection programmes must not be interrupted, as this can have a limiting effect on the disinfection result. It is the operator's responsibility to ensure that the standard of disinfection in thermal as well as chemo-thermal procedures is maintained by carrying out suitable validation tests.

Foreseeable misuse

▶ Never use solvent-based cleaning agents, e.g. those containing benzene, in the washer-dryer stack. Doing so may result in damage to component parts and create toxic steam and fumes. **Risk of fire and explosion!**

▶ When washing with high temperatures, remember that the porthole glass becomes hot. Do not let children touch it during the wash process.

Danger of burning!

▶ Close the drum door after each wash or drying cycle. This is to avoid the risk of children trying to climb into the washer-dryer stack or hide things in it, and animals getting into it.

▶ Do not damage, remove or bypass the safety features or control elements of the washer-dryer stack.

▶ Machines with damaged control elements or cable insulation may only be replaced by the manufacturer/Customer Service or a qualified electrician.

▶ Water used for washing in this machine consists of suds and is not drinking water! Drain the suds into a proper drainage system.

▶ Always make sure that the drum is stationary before reaching in to remove laundry. Reaching into a moving drum is extremely dangerous.

▶ Be careful not to put your hands in the gap between door and frame when closing the drum door.

Please note: the drum door is locked automatically as soon as the washing machine starts.

▶ It is particularly important to follow the manufacturer's instructions when using a combination of cleaning agents and special application products. Products must only be used for applications approved by the manufacturer to avoid any material damage or the occurrence of strong chemical reactions.

Technical safety

- ▶ Before setting up the washer-dryer stack, check it for any externally visible damage. Do not install or use a damaged washer-dryer stack.
- ▶ The electrical safety of this washer-dryer stack can only be guaranteed when correctly earthed. It is essential that this standard safety requirement is observed and regularly tested. If in any doubt, please have the electrical installation inspected by a specialist. Miele cannot be held liable for the consequences of an inadequate earthing system.
- ▶ Unauthorised repairs could result in unforeseen dangers for the user, for which the manufacturer cannot accept liability. Repairs should only be undertaken by a Miele authorised technician, otherwise any subsequent damage will not be covered by the warranty.
- ▶ Do not make any alterations to the washer-dryer stack, unless authorised to do so by Miele.
- ▶ Disconnect the washer-dryer stack from the power supply in the event of a fault and for cleaning and maintenance. The washer-dryer stack is only electrically disconnected from the power supply when:
 - Both washer-dryer stack plugs have been disconnected from the socket or
 - The mains fuses for both machine parts are disconnected or
 - The mains fuses for both machine parts have been completely removed.

See “Installation and connection – Electrical connection”.

- ▶ The washing machine may only be connected to the water supply using the set of hoses supplied with the machine. Old sets of hoses must not be re-used. Check the sets of hoses regularly for signs of wear. Change the sets of hoses in good time to avoid the risk of leaks and subsequent water damage.
- ▶ The cause of any leaks must be dealt with before the washer-dryer stack is restarted. Disconnect the washer-dryer stack immediately if any water leaks out.
- ▶ Faulty components must only be replaced by genuine Miele spare parts. Miele can only guarantee the safety standards of the machine when Miele spare parts are used.
- ▶ All relevant national provisions and regulations (DGUV in Germany) relating to accident insurance are applicable to this washer-dryer stack. It is recommended to carry out testing in accordance with the regulatory framework described in DGUV 100-500/Chapter 2.6/Section 4. The test book required for the documentation is available from the Miele Customer Service Department.
- ▶ Please observe the instructions in “Installation and connection” and “Technical data”.
- ▶ The plugs for the washer-dryer stack must always be kept accessible so that the washer-dryer stack can be easily disconnected from the power supply.
- ▶ For hard-wired machines, an all-pole means of deactivation must be provided on site.
- ▶ If the washer-dryer stack is to be hard-wired, there must be a means of disconnecting all poles from the power supply. The mains isolators must be close to the washer-dryer stack and be clearly identifiable, unhindered and easily accessible at all times.
- ▶ The tumble dryer may only be operated when the ducting has been installed and the room is sufficiently ventilated.

► The vent ducting must never be installed in any of the following flues or shafts:

- Chimneys or smokestacks that are in use.
- Shafts that are used to ventilate installation rooms with fireplaces.
- Flues that are used by third parties.

Smoke or exhaust gas that is fed back into the flue or shaft may be toxic.

► Regularly check all components in the vent ducting (e.g. wall pipe, external grille, bends, elbows, etc.) to make sure air can move through them and to ensure that they are working properly. Clean components when necessary. Fluff deposits in the vent ducting system will prevent the air from being extracted properly and, as a result, will stop the tumble dryer from working properly.

If existing vent ducting is due to be used, it must be checked before being connected to the tumble dryer.

Low pressure must not occur in the vent ducting.

► There is a risk of suffocation and poisoning due to exhaust gases being sucked back if gas-powered flow heaters, gas-powered room heaters, coal-burning stoves with a flue connection, etc., are installed in the same room, in the same flat or in neighbouring rooms and the negative pressure is 4 Pa or more.

The following measures for suitable room ventilation (examples) can help to prevent negative pressure in the installation area:

- Install suitably sized vents that cannot be closed in the exterior walls.

Please always seek approval from your building regulations inspector to confirm that the appliance can be operated without risk and that negative pressure of over 4 Pa can be prevented.

► If multiple tumble dryers are to be connected to one vent ducting, a non-return flap must be installed directly on the duct for each tumble dryer.

If this requirement is not observed, the tumble dryers may be damaged and their electrical safety could be affected.

► Follow the instructions in “Installation of the ducting”.

Safety instructions and warnings

Correct use

- ▶ The maximum dry laundry load size is 10 kg. See the “Programme chart” for the maximum recommended load sizes for individual programmes.
- ▶ Before commissioning the washing machine, check that the transport safety devices have been removed (see “Installation – Removing the Transport safety devices”). During spinning, transport safety devices which are still in place may result in damage to both the washer-dryer stack and adjacent furniture or machines.
- ▶ Never try to open the drum door of the washing machine using force. If the door is locked, it can only be opened when a corresponding message appears in the display.
- ▶ Do not push the suspended drum unit while the machine is running.
- ▶ When closing the drum door there is a danger of crushing and shearing between the door frame and the drum opening and also at the hinges.
Caution: the drum door locks automatically when the machine is started.
- ▶ Close the water inlet if the washing machine is to be left for any length of time (e.g. while on holiday), especially if there is no floor drain (gully) in the immediate vicinity.
- ▶ Take care to ensure that foreign objects (e.g. nails, pins, coins, paper clips) do not find their way into the machine with the laundry. Foreign objects may damage components of the machine (e.g. suds container, drum). Damaged components can damage the laundry.
- ▶ If the correct amount of detergent is dispensed, the washing machine should not need to be descaled. If, however, you do wish to descale your washing machine, only use proprietary non-corrosive descaling agents. Special descaling agent is available from your Miele dealer or from the Miele Customer Service Department. Strictly observe the instructions for the descaler.
- ▶ Textiles which have been pre-treated in solvent-based cleaning agents must be rinsed in clean water before being washed in the machine. Note that solvent residues may only be discharged into waste water in compliance with local legislation.
- ▶ Never use solvent-based cleaning agents, e.g. those containing benzene, in this machine. Doing so may result in damage to component parts and create toxic steam and fumes. **Risk of fire and explosion!**
- ▶ Do not store or use petrol, paraffin or any easily flammable substances near the washing machine. Do not use the machine lid as storage space.
Risk of fire and explosion!
- ▶ Do not store chemicals (liquid detergents, additives) on the machine lid. They may cause discolouration or lacquer damage. Accidentally spilled chemicals should be removed from the surface immediately with a wet cloth.
- ▶ Only use dyes, dye removers and descalers suitable for use in a washing machine. The manufacturer’s instructions on the packaging must be observed.
- ▶ Dye removers contain sulphur compounds which can cause damage such as corrosion. Do not use these products in this washing machine.

Safety instructions and warnings

▶ Avoid contact between stainless steel surfaces and liquid detergents or disinfecting agents containing chlorine or sodium hypochlorite. These agents can have a corrosive effect on stainless steel. Aggressive chlorine bleach vapours can also be corrosive. Do not store open containers of these agents near the machine.

▶ Do not use a pressure washer or water jet to clean the washer-dryer stack.

▶ Never operate the tumble dryer without the fluff filter or with a damaged fluff filter. This could lead to malfunctions. Fluff can clog the air channels, heating elements and vent ducting, which could result in a fire. In this case, stop the tumble dryer immediately and replace the damaged fluff filter.

▶ The fluff filter must be cleaned on a regular basis.

▶ To ensure problem-free operation of the tumble dryer:

- Clean the surface of the fluff filter after each drying cycle.
- In addition, the fluff filter and the air passages must be cleaned when prompted by the display.

▶ To prevent the risk of fire, the following items must not be dried in this tumble dryer:

- Items which have not been washed.
- Items which have not been thoroughly cleaned and are still soiled with grease, oil or other deposits (such as kitchen linens or cosmetics cloths with cooking oils, grease, lotions, etc). If items have not been thoroughly cleaned, there is a danger that they might ignite when heated, even after they have been removed from the tumble dryer at the end of the programme.
- Items (e.g. mops and floor cloths) that have been treated with inflammable cleaning agents or which contain residues of acetone, alcohol, benzene, petrol, kerosene, stain remover, turpentine, wax and wax remover or other chemicals.
- Items which have been splashed with hair lacquer, hair spray, nail varnish remover or similar substances.

Wash heavily soiled items thoroughly by increasing the amount of detergent and selecting a high washing temperature. If in doubt, wash the items several times.

▶ Remove all items from the pockets of the laundry to be dried (e.g. lighters, matches, keys).

▶ In many programmes, the heating phase is followed by a cooling down phase to ensure that the items are not too hot to handle when you remove them (this also avoids the danger of the laundry self-igniting). The programme is not finished until the cooling down phase is complete. Ensure that you always wait until the end of the programme before removing the laundry.

▶ Fire hazard.

This tumble dryer must not be connected to a controllable socket (e.g. a timer or a peak-load switch-off device).

The tumble dryer may only be operated with a peak-load device if this is connected to the tumble dryer via the Miele XCI box and the relevant settings have been configured on the tumble dryer.

There is a risk of the laundry igniting itself if the drying programme is cancelled before the cooling phase has finished.

Safety instructions and warnings

- ▶ To prevent the risk of fire, the following textiles must not be dried in this tumble dryer:
 - items which have been cleaned using chemicals (e.g. professional dry-cleaning agents).
 - fabrics which contain a large proportion of rubber, foam rubber or rubber-like materials. For example, products made from latex foam rubber, shower caps, waterproof textiles, rubberised articles and items of clothing and pillows with foam rubber filling.
 - Fabrics which contain damaged padding or fillings (e.g. pillows, jackets). When damaged, the filling can get out with the risk of it igniting in the dryer.
- ▶ Do not expose the dryer to air which is contaminated with vapour of chlorine, fluorine or other solvents. Danger of fire.
- ▶ Many programmes are followed by the cooling phase to ensure that the items of laundry are kept at a temperature that will not cause them damage (for instance to prevent the risk of the laundry self-igniting). Always remove all items of laundry from the tumble dryer immediately after the cooling phase.

Chlorine and component damage

► Frequent use of chlorine products increases the risk of damage to components.

► The use of substances containing chlorine, such as sodium hypochlorite and chlorine bleach in powder form, can result in damage to the protective layer of stainless steel and corrosion on components. Therefore, refrain from using substances containing chlorine. Use oxygen-based bleaching agents instead.

If, however, chlorine bleaching agents are used, an anti-chlorine treatment must always be carried out. Otherwise, both the washing machine components and the laundry may suffer persistent and irreparable damage.

► Anti-chlorine treatment must be carried out immediately after chlorine bleaching agents have been used. Hydrogen peroxide as well as oxygen-based detergents and bleaching agents are suitable for anti-chlorine treatment. The suds must not be drained in between.

Treatments with thiosulphates can result in gypsum-like deposits particularly when used in combination with hard water. This gypsum can build up in the washing machine or cause incrustations on the laundry. Treatment with hydrogen peroxide is recommended over treatment with thiosulphates because hydrogen peroxide neutralises chlorine.

The exact dispensing quantities and the treatment temperatures required must be set and tested on site in accordance with the dispensing recommendations of the detergent and cleaning agent manufacturers. The laundry must also be tested to check whether it contains any active chlorine residues.

Safety instructions and warnings

Accessories

▶ Accessory parts may only be fitted when expressly approved by Miele. If other parts are used, warranty, performance and/or product liability claims will be invalidated.

Disposing of your old machine

▶ Ensure that the door locks are unusable when disposing of or scrapping old washer-dryer stacks. This will prevent the risk of children playing accidentally locking themselves in and endangering their lives.

Miele cannot be held liable for damage caused by non-compliance with these safety notes and warnings.

Description of the machine

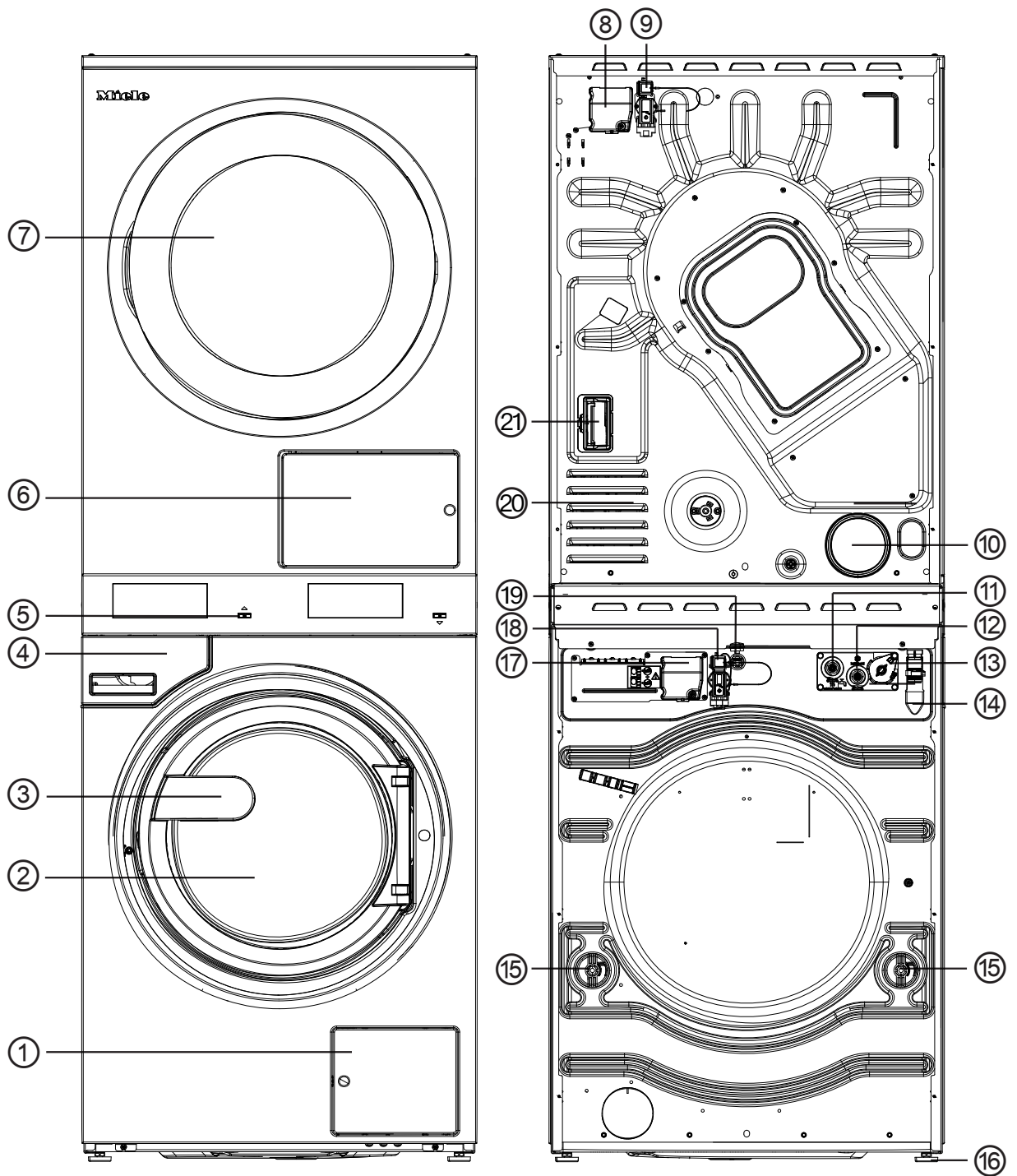



Description of the machine

- ① Access flap to drain filter and drain pump
- ② Washing machine drum door
- ③ Door handle
- ④ Detergent drawer
- ⑤ Display (further information can be found in the “Operation” section)
- ⑥ Fluff filter flap
- ⑦ Tumble dryer drum door
- ⑧ Tumble dryer electrical connection
- ⑨ Interface for communication box
- ⑩ Exhaust duct Ø 100 mm
- ⑪ Hot water connection
- ⑫ Cold water connection
- ⑬ Interface for external dispensing
- ⑭ Drain hose connection (for drain pump variant)
- ⑮ Transport safety devices
- ⑯ 4 height-adjustable screw feet
- ⑰ Washing machine electrical connection
- ⑱ Interface for Connector Box (optional second interface)
- ⑲ Interface for LAN
- ⑳ Intake vents for drying air
- ㉑ Communication module slot

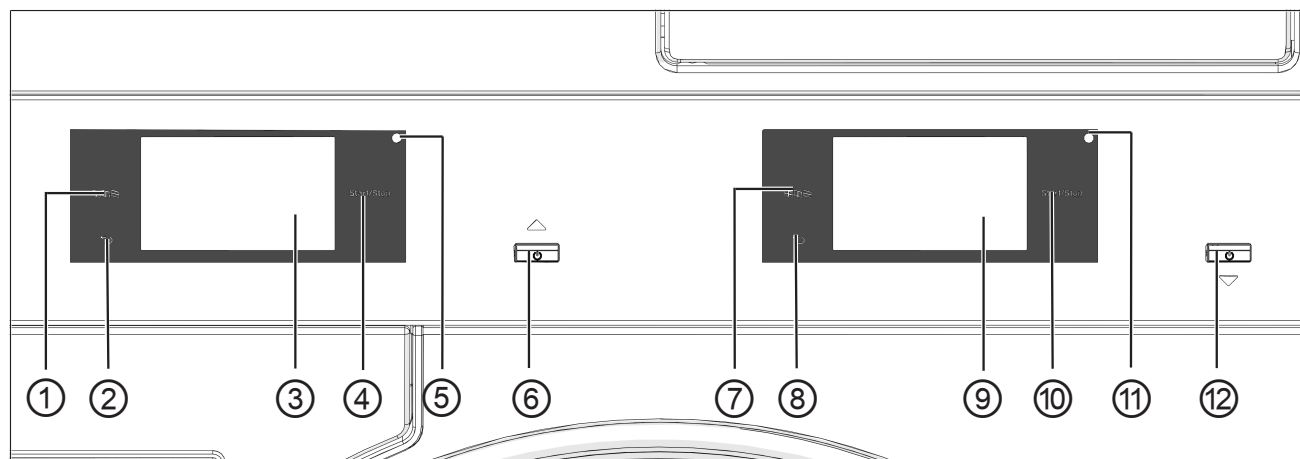
Control panel





- ① **Tumble dryer language sensor control** 

For selecting the current user language. The supervisor language is displayed again at the end of the programme.
- ② **Tumble dryer back sensor control** 

Takes you back one level in the menu.
- ③ **Tumble dryer touch display**
- ④ **Start/Stop tumble dryer sensor control**

For starting the programme selected and cancelling a programme once it has started. The programme selected can be started as soon as the sensor control starts flashing.
- ⑤ **Tumble dryer optical interface**

For the Customer Service Department.
- ⑥ **Tumble dryer button** 

For switching the tumble dryer on and off. The tumble dryer switches off automatically to save energy. It is switched off an adjustable time after the end of the programme/Anti-crease phase, or after being switched on if no further selection is made.
- ⑦ **Washing machine language sensor control** 

For selecting the current user language. The supervisor language is displayed again at the end of the programme.
- ⑧ **Washing machine back sensor control** 



Takes you back one level in the menu.
- ⑨ **Washing machine touch display**
- ⑩ **Start/Stop washing machine sensor control**

For starting the programme selected and cancelling a programme once it has started. The programme selected can be started as soon as the sensor control starts flashing.
- ⑪ **Washing machine optical interface**

For the Customer Service Department.
- ⑫ **Washing machine button** 

For switching the washing machine on and off.

Sensor controls and touch display

The sensor controls ,  and *Start/Stop* and the elements in the display respond to finger tip contact. Every touch of a sensor control is confirmed with an audible keypad tone. You can adjust the volume of the keypad tone or switch it off (see “Supervisor level”).

The control field with sensor controls and the touch display can be scratched by pointed or sharp objects, e.g. pens.
Only touch the control field with your fingers.

Main menu

After switching on the washing machine, the main menu will appear in the display.

You can access all the important sub-menus from the main menu.

Touch the  symbol at any time to return to the main menu. Values set previously are not saved.

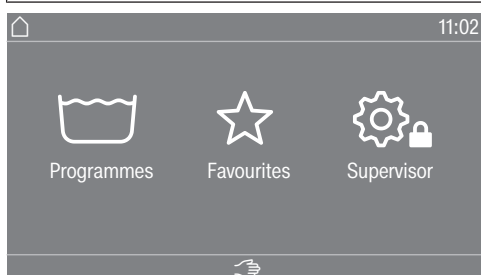

 Programmes” menu In this menu, you can select the wash programmes.

 Favourites” menu In this menu, you can select 1 favourite programme from a total of 24 favourite programmes. The wash programmes can be set up and saved by the supervisor in the Favourites menu (see “Favourite programmes” under “Supervisor level”).

 Supervisor” menu You can alter the washing machine’s user interface to suit changing requirements in the supervisor level (see “Supervisor level”).

Main menu

After switching on the tumble dryer, the main menu will appear in the display. You can access all the important submenus from the main menu.

Touch the sensor control  at any time to return to the main menu. Values set previously are not saved.

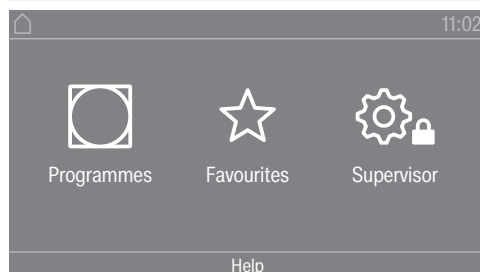

Main menu

“Programmes” menu

In this menu, you can select the drying programmes.

“Favourites” menu

In this menu, you can select 1 favourite programme from a total of 12 favourite programmes. The drying programmes can be set up and saved by the supervisor in the Favourites menu (see “Favourite programmes” under “Supervisor level”).

“Supervisor” menu

You can alter the tumble dryer’s electronic module to suit changing requirements in the supervisor level (see “Supervisor level”).

Examples of how to operate the machine

Selection lists

“Programmes” menu (single selection)

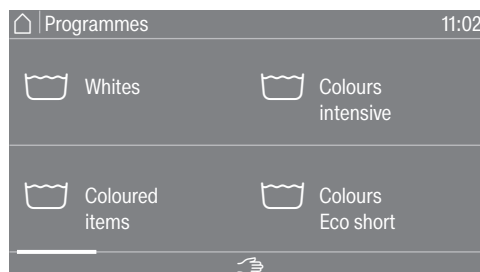

You can scroll right or left by swiping your finger across the screen. To do this, place your finger on the touch display and swipe it in the direction you want.

The orange scroll bar shows that there are further options to choose from.

Touch a programme name to select the wash programme.

The display will change to the standard menu for that programme.

“Extras” menu (multiple selection)

To access the level for selecting Extras, you first need to select a programme, e.g. Whites.

Operation

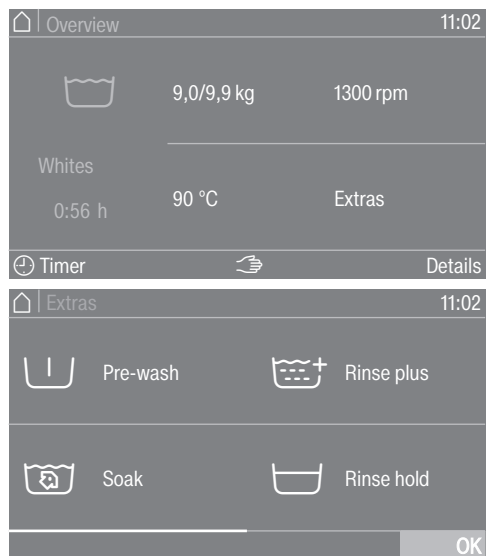

Touch one or several *Extras* to select it/them.
Currently selected *Extras* are marked orange.
To deselect an *Extra*, simply touch the *Extra* again.
Use the *OK* sensor control to activate all selected *Extras*.

Setting numerical values

You can set numerical values in some menus.

The following example shows how to set the time of day. The “Supervisor level” section describes how to get to this level.

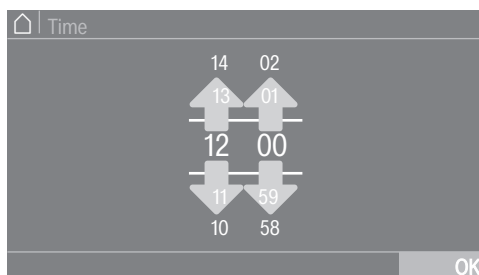

Enter the numbers by swiping up or down.

Place your finger on the number that you want to change and move your finger in the direction you want. Use the *OK* symbol to accept the set numerical value.

Tip: A numerical keypad may also appear to adjust the value for some settings.

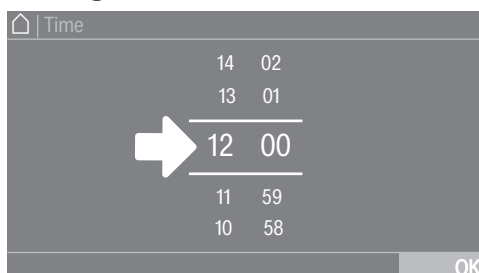

Briefly touching a number between the two lines will bring up the numerical keypad.

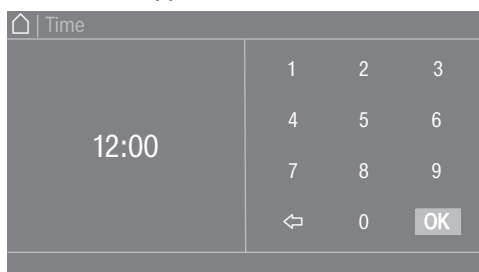

Once a valid number has been entered, the *OK* symbol will be highlighted green.

Operation

Pull-down menu

The following example describes the display for an ongoing wash programme. The “Programme start – programme end” section describes how to get to this level.

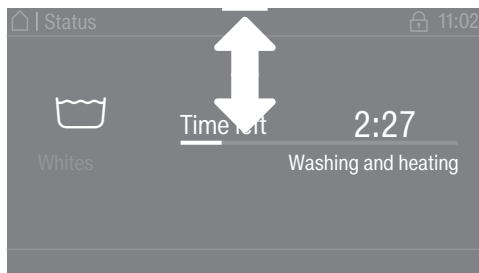

If an orange bar appears at the top of the screen in the middle of the display, you can open the pull-down menu. Touch the bar and drag it down with your finger on the display.

Exiting a menu level

- Touch the ↶ symbol to return to the previous screen.

Entries you have made before this which have not yet been confirmed with *OK* will not be saved.

Help display

With some menus, Help appears along the bottom line of the display.

- Touch the Help selection area to display the text.
- Touch the Close selection area to return to the previous screen.

Operating a laundrette machine

The main menu will vary depending on the programming status (see “Supervisor level”).

Shortcuts are the easiest way to operate the machine. Operating staff are unable to change pre-set programmes.

Laundrette, basic

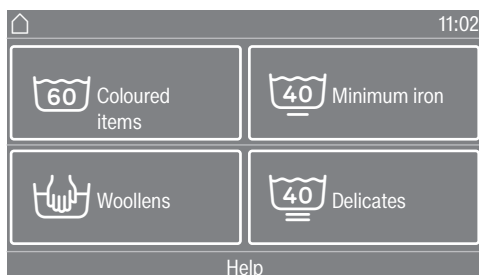

Between 4 and 24 pre-set programmes are available. These programmes cannot be changed by the user.

Laundrette logo



Up to 24 pre-set programmes are available. The first 3 programmes can be selected directly. The remaining programmes are selected from a list . These programmes cannot be changed by the user.

Preparing for use

Emptying pockets

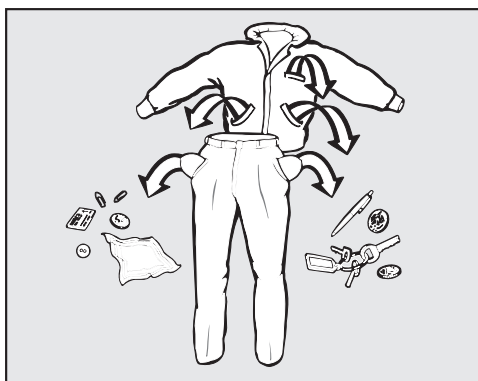

- Empty all pockets.

⚠ Damage due to foreign objects.
Nails, coins, paper clips, etc. can cause damage to garments and components inside the machine.
Check laundry before washing and remove any foreign objects.

Sorting laundry

- Sort the laundry according to colour and the garment care label.

Preparing the laundry items

- Shake mops, cleaning cloths and pads out well to get rid of coarse soiling before placing them in the washing machine drum.

Pre-treating stains

- Badly soiled areas and stains should be cleaned as soon as possible. Stains should be carefully dabbed off using a soft, colourfast cloth.

General tips

- Do not machine wash items which are specified by the manufacturer as not washable on the care label (☒).
- Curtains: remove rollers and lead weights or place in a laundry bag.
- Sew in or remove any loose underwiring in bras.
- Turn garments inside out, if recommended by the manufacturer.
- Close any zips and velcro fasteners before washing.
- Fasten duvet covers and pillow cases to prevent small items from becoming rolled up inside them.
- Please refer to the Programme overview for more tips and tricks.

Loading and switching on the washing machine

Loading the washing machine

- Prepare the washing machine.
- Switch on the washing machine with the ⏻ button. The welcome screen will light up.
- Open the drum door with the handle.

Washing

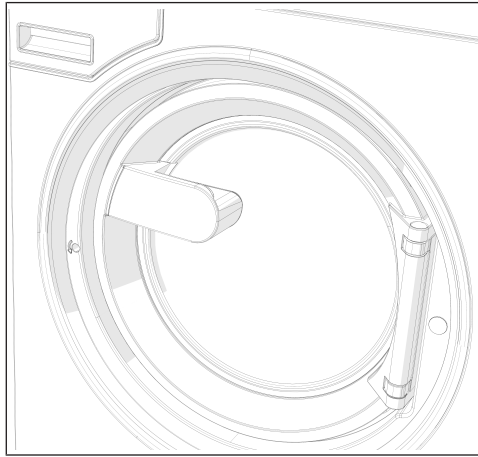

- Unfold the laundry and load loosely into the drum.

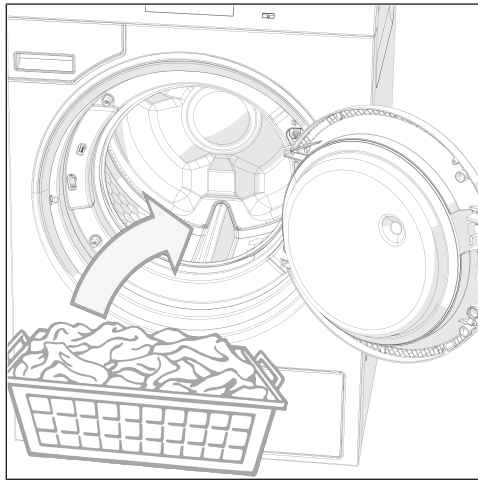

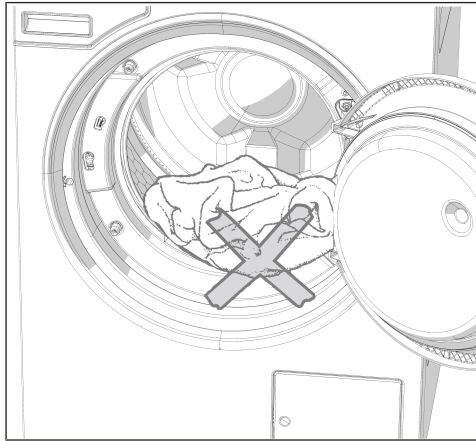

⚠ Make sure that no items are caught between the drum door and the opening.

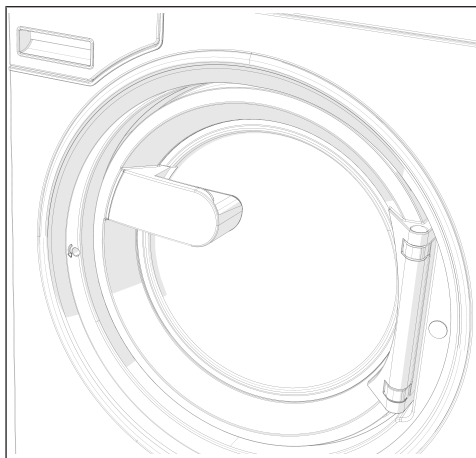





■ Close the drum door by pressing it until the pre-latch engages.

The drum door engages, but is not locked yet. The drum door locks automatically as soon as the machine starts.

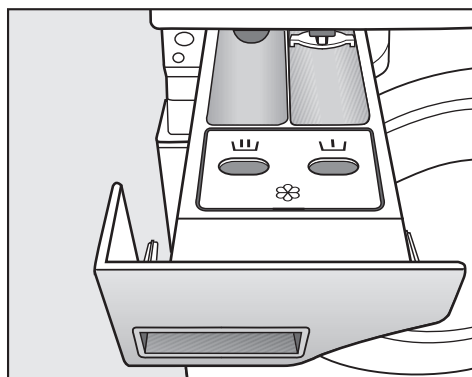
Washing with detergent drawer

Adding detergent using the detergent drawer



- For the standard programmes, add powder detergent to the  drawer for the main wash. If desired, add detergent for a pre-wash to the  drawer. Add fabric conditioner to the front of the  drawer.

Adding fabric conditioner or liquid starch separately

- Select the *Separate rinse* programme.
- Change the spin speed if necessary.

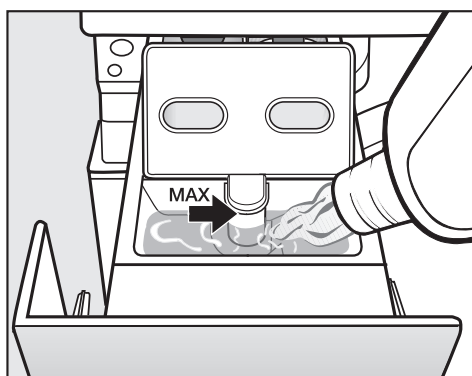

- Add fabric conditioner or liquid starch to the  compartment. **Do not exceed the maximum level mark.**
- Touch the *Start/Stop* sensor control.

Adding starch separately

- Prepare the starch solution in accordance with the manufacturer's instructions on the packaging.
- Select the *Starch* programme.
- Add the prepared starch to the  compartment.
- Touch the *Start/Stop* sensor control.

Tip: If starching separately or automatically, thoroughly clean the detergent drawer regularly.

Dyes, dye removers and descalers

Proprietary dyes, dye removers and descalers may only be used in this washing machine if the manufacturer expressly states that they are suitable for use in a washing machine. The manufacturer's instructions on the packaging must be observed.

Detergent dispensing

Avoid dispensing more than the required amount as this can cause excessive foaming.

- Only use low foaming detergents.
- Dispense according to the detergent manufacturer's recommendations.

The dispensing amount will depend on:

- The amount of laundry
- The water hardness
- The degree of soiling of the laundry

Detergent dispensing quantity

Please dispense according to water hardness levels and follow the detergent manufacturer's instructions.

Water hardness levels

Water hardness level	Total hardness in mmol/l	German scale °dH
I (soft)	0–1.5	0–8.4
II (medium)	1.5–2.5	8.4–14
III (hard)	above 2.5	above 14

Check with your local water supplier if you do not know the water hardness level in your area.

Selecting a programme

Programmes

There are different ways to select a programme.

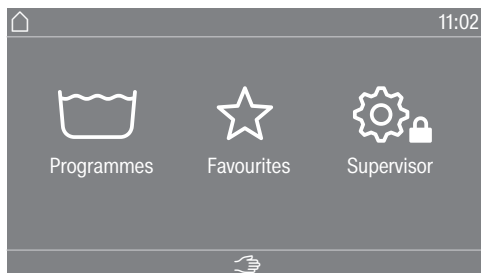

You can select a programme from the Programmes menu.

- Touch the Programmes selection area.

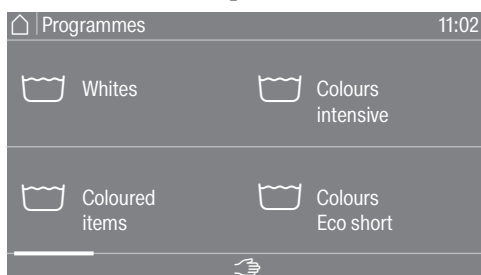

- Scroll to the right in the display until the programme you want appears.
- Touch the required programme on the touch display.

The display will change to the standard menu for that wash programme.

Favourites

Alternatively, you can select a programme from the Favourites menu.

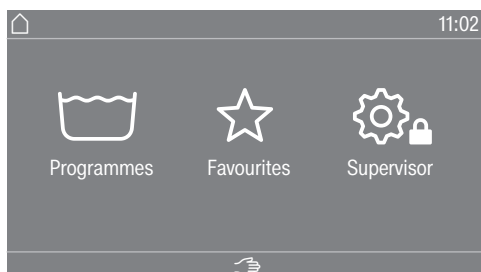

- Touch the Favourites selection area.

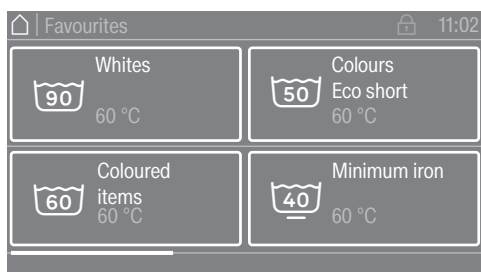

- Scroll to the right in the display until the programme you want appears.
- Touch the required programme on the touch display.

The display will change to the standard menu for that wash programme.

In the case of favourite programmes, the majority of the programme settings are already fixed and cannot be changed.

Selecting programme settings

Selecting the load size

To enable load-specific external dispensing and an adapted programme sequence, you can specify the load size for some programmes.

- Touch the Weight (kg) selection area.

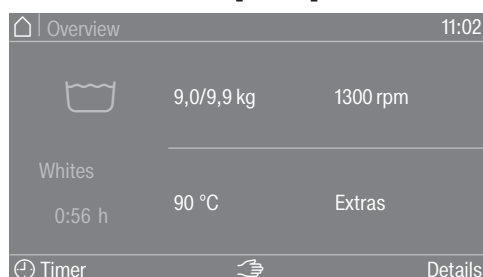

- Enter a valid value for the load size.

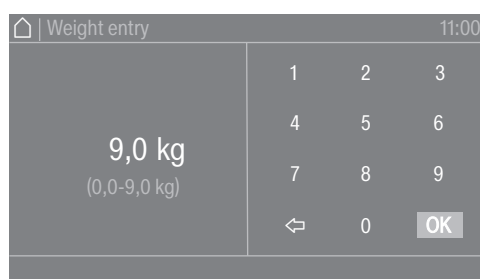

- Press the OK symbol.

The display will change to the Overview menu.

Washing

Selecting a temperature

You can alter the pre-set temperature of a wash programme.

- Touch the Temperature (°C) selection area.



- Select the desired temperature from the presets.

The display will change back to the Overview menu.

If you select the **Finer adjustment** selection area, you can set additional temperatures within the available temperature range by entering them directly.

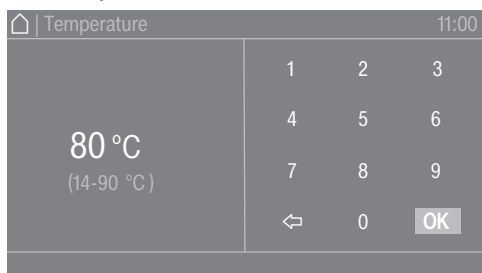

- Select the desired value using the keypad.
- Press the OK symbol.

The display will change back to the Overview menu.

The temperature can only be selected within the range specified below the current setting (e.g. 14–90 °C).

Selecting a spin speed

You can alter the pre-set spin speed of a wash programme.

- Touch the Spin speed (rpm) selection area.



- Select the spin speed you want from the presets.

The display will change back to the Overview menu.

If you select the Finer adjustment selection area, you can set additional speeds within the available speed range.

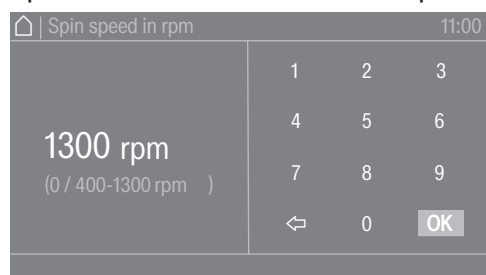

- Select the desired value using the keypad.

- Press the OK symbol.

The display will change back to the Overview menu.

The speed can only be selected within the range specified below the current setting (e.g. 0 / 400–1300 rpm).

Selecting Extras

Selecting Extras

You can select Extras for some wash programmes.

- Touch the Extras selection area.

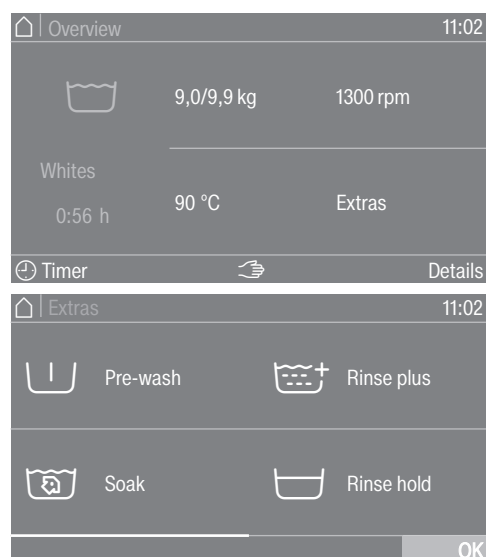

- Select one or more Extras.
- Press the OK symbol.

The display will change to the Overview menu.

Pre-wash

A pre-wash can be added for heavily soiled laundry. Coarse soiling is loosened and removed before the main wash.

Soak

For heavily soiled and stained items with protein stains. The soak duration is 10 minutes.

Rinse plus

An extra rinse can be activated to achieve a better wash result.

Rinse hold

The laundry is not spun after the final rinse cycle and remains in the rinse water. This helps to prevent creasing if the laundry is not going to be removed from the washing machine immediately after the end of the programme.

Filling stop

Water is drained out of the machine before the final rinse and the programme stops. The required starch, dye, proofing agent, etc. is added directly to the washing machine drum. The programme is continued with the *Start/Stop* sensor control.

Intensive

For hard-wearing laundry that is very heavily soiled. Extending the main wash increases cleaning efficiency.

Water plus

The water level in the wash cycle will be increased.

Programme start – programme end

Starting a programme

The programme can be started as soon as the *Start/Stop* sensor control is flashing on and off.

- Touch the *Start/Stop* sensor control.

The door will lock (🔒 symbol) and the wash programme will start.

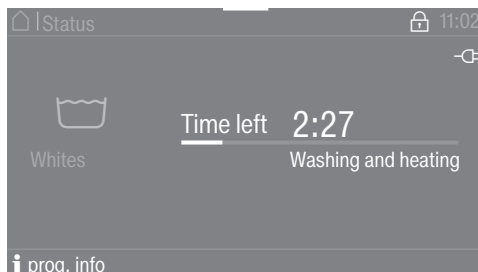

Tip: You can use the pull-down menu to display the selected temperature, spin speed and any selected Extras.

If a delay start period (⌚ Timer) has been selected, this will appear in the display at the bottom left.

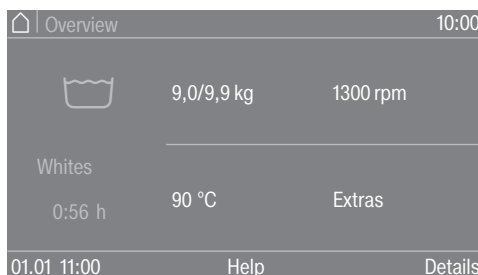

If you select the **i prog. info** selection area, all programme-related information will be displayed.

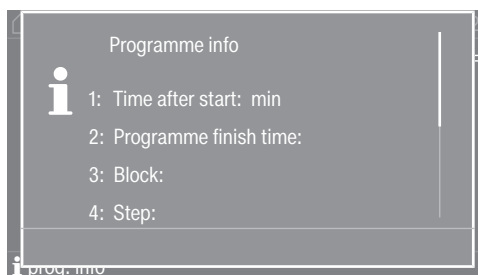

Once the delay start period has elapsed (if applied), the programme running time will appear in the display; otherwise, the running time will appear straight away. The programme sequence is also shown in the display.

End of the programme

Depending on the setting selected in the supervisor level or in the programme, the machine will switch to the anti-crease action cycle at the end of the programme. The door remains locked. The door can be unlocked at any time by touching the *Start/Stop* sensor control.

Removing the laundry

- Pull open the door.
- Remove the laundry.

Items left in the drum could discolour other items in the next wash or become discoloured themselves.
Remove all items from the drum.

Washing

- Check the door sealing ring for any foreign objects.
- Switch the washing machine off with the  button.

Tip: Leave the detergent drawer slightly open to allow it to dry.

Timer

The timer can be used to select a programme start date, programme start time or programme end time. This mode is also referred to as delay start.

Setting the timer

- Touch the  Timer selection area.

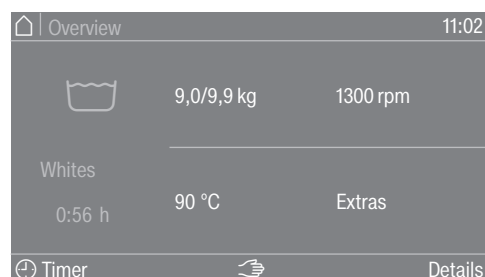

- Select option Finish at, Start date or Start at.

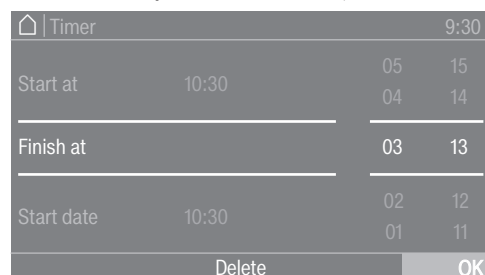

- Set the hours and the minutes or the date and confirm with the  symbol.

Deleting the timer

The selected delay start period can be cancelled before the programme starts.

- Touch the selection area with the selected settings in the timer field, e.g. 01.01. 11:00.

The selected delay start period will appear in the display.

- Touch the Delete selection area.
- Confirm with the  symbol.

The selected delay start period is deleted.

Starting the timer

- Touch the *Start/Stop* sensor control.

The door will lock and the time until the programme starts will appear in the display.

After the programme has started, the selected delay start period can only be changed or cancelled by interrupting the programme.

The programme can be started immediately at any time.

- Touch the Start immediately selection area.

Special features in the programme sequence

Spinning

- Final spin speed** When a programme is selected, the maximum spin speed for this wash programme is shown in the display in the pre-start menu. You can reduce the final spin speed. Depending on the programme, it may also be possible to increase the speed. The setting options are displayed when you tap the spin speed.
- Rinse-spin** There is a spin cycle after the main wash and between the rinse cycles. A reduction in the final spin speed will also reduce the interim spin speed as appropriate.
- Anti-crease** At the end of the programme, the drum continues to turn at intervals for up to 30 minutes to help prevent creasing. The drum door cannot be opened until the programme has ended.

Anti-crease is programme-dependent. The option can be switched on or off in the supervisor level.

Washing

Skip

The Skip function enables users to skip forwards or backwards in the programme sequence. The programme sequence is continued from the selected step.

If a programme is interrupted using the *Start/Stop* sensor control, the Skip ⇨ function is available in the programme stop screen.



If the Skip ⇨ function is selected, the required programme step can be selected via the display.

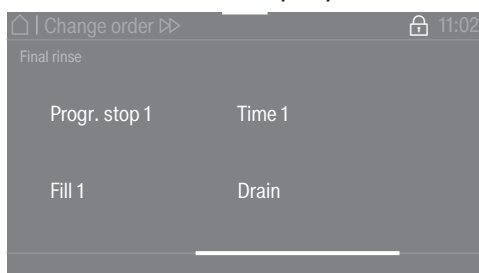

The programme can then be continued with the *Start/Stop* sensor control.

Manual control

Manual control is possible either before a programme is started or when a programme has been stopped.

Switching to manual control

Manual control is possible before a programme is started or when a programme has been stopped.

- Press the ⇨ “Manual control” button to access the password entry screen.

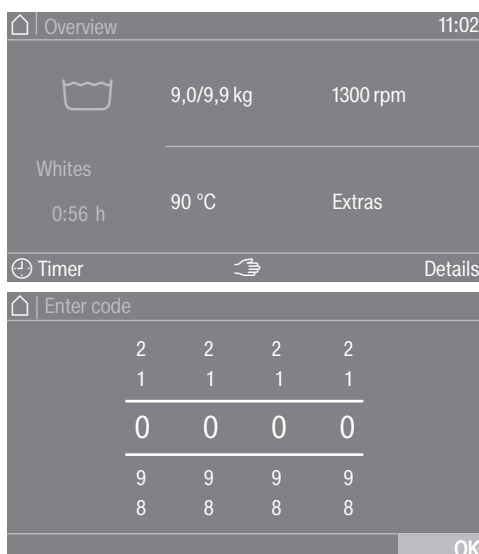

- Enter the password.
- Confirm the password entry with the OK sensor control.

The Manual control menu is displayed:

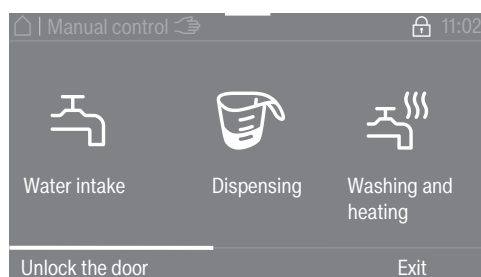

The current level, spin speed and temperature statuses of the machine appear orange.

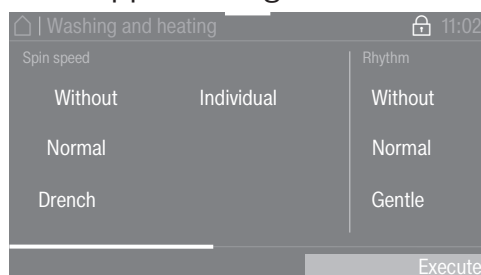

- Select the desired setting.
- Confirm the entry with the Execute sensor control.

The sub-menus appear in various operating modes. See “Examples of how to operate the machine” for an in-depth description.

The function buttons are assigned with specific manual control functions:

- Water inlet
- Dispensing
- Washing and heating
- Drain with drum rotation
- Spin

- Press the button again to end a selected function.

Water intake

Water intake valves and the water level can be set.

- Press the Water intake function button.
- Select the desired value.
- Confirm your selection with the Execute sensor control.

If a higher numerical value is set, the values below this will no longer be displayed.

The wash programme will start or continue.

Dispensing

The dispensing quantity for the various dispensing pumps can be set.

This function is only possible if the Connector Box, the dispensing pumps and automatic dispensing have been selected in the supervisor level, see “Supervisor level” section.

- Press the Dispensing function button.
- Select the desired dispensing pump and dispensing quantity, e.g. D1 50 ml.
- Confirm your selection with the Execute sensor control.

Washing

The wash programme will start or continue.

Washing and heating  Spin speed, rhythm and temperature can be set.

- Press the  Washing and heating function button.
- Select the desired settings.

The selected setting will appear in orange in the multiple selection.

- Confirm your selection with the **Execute** sensor control.

The wash programme will start or continue.

Drain with agitation  Drain path, spin speed and rhythm can be set.

- Press the  Drain with agitation function button.
- Select the desired settings.

The selected setting will appear in orange in the multiple selection.





- Confirm your selection with the **Execute** sensor control.

Spin  The spin speed can be set.

- Press the  Spin function button.
- Select the desired value.
- Confirm your selection with the **Execute** sensor control.

The wash programme will start or continue.

Function combinations Water inlet, dispensing, washing and heating can be selected simultaneously in any combination*.

 Water inlet	 Dispensing	 Washing and heating	 Drainage with agitation	 Spinning
<input checked="" type="checkbox"/>	<input checked="" type="checkbox"/>	<input type="checkbox"/>	<input type="checkbox"/>	<input type="checkbox"/>
<input type="checkbox"/>	<input checked="" type="checkbox"/>	<input checked="" type="checkbox"/>	<input type="checkbox"/>	<input type="checkbox"/>
<input checked="" type="checkbox"/>	<input type="checkbox"/>	<input checked="" type="checkbox"/>	<input type="checkbox"/>	<input type="checkbox"/>
<input checked="" type="checkbox"/>	<input checked="" type="checkbox"/>	<input checked="" type="checkbox"/>	<input type="checkbox"/>	<input type="checkbox"/>

* possible function combinations

1. Notes on correct laundry care

Washing before drying

Heavily soiled laundry must be washed particularly thoroughly. Use sufficient detergent and select a high wash temperature. If in doubt, wash the items several times.

The tumble dryer must not be used for drying items of laundry which have been cleaned using industrial chemicals.

New and coloured items must be washed thoroughly and separately. Do not dry new and coloured items with light coloured garments. There is the risk of colours running and discolouring other garments or even plastic components in the tumble dryer. Dark coloured fluff can also settle on light coloured garments and vice versa.

Removing foreign objects







Before drying, ensure that there are no foreign objects in the laundry.

 Damage due to foreign objects which were not removed from the laundry.
Foreign objects in the laundry can melt, burn or explode.
Ensure that any foreign objects (e.g. detergent dispensing aids, lighters, etc.) have been removed from the laundry.

Check seams and stitching to ensure that the items of laundry are intact. This way you will avoid the danger of fillings coming out and causing a fire. Sew in or remove underwiring from bras.

 Risk of fire due to incorrect use and operation.
The laundry can burn and destroy the tumble dryer and the surroundings.
See the section on “Warnings and safety notes” for further information.

Care symbols

Drying	
	Normal/higher temperature
	Low temperature*
* Select Low temperature.	
	Do not tumble dry
Ironing	
	Very hot
	Hot
	Warm
	Do not iron

Loading laundry into the tumble dryer

2. Loading the tumble dryer

Textiles may be damaged.
Before loading, read chapter “1. Notes on correct laundry care” first.

- Open the door.
- Load laundry into the tumble dryer.

Risk of damage with laundry getting trapped.
Laundry can be damaged by getting trapped when closing the door.
When closing the door, make sure that laundry does not get trapped in the door opening.

Do not overload the drum. Overloading can cause unnecessary wear and tear to the laundry and cause a disappointing drying result. It can also cause more creasing.

Closing the door

⚠ Damage caused by laundry getting trapped.
Laundry can be damaged by getting trapped when closing the door.
When closing the door, make sure that laundry does not get trapped in the door opening.

- Shut the door gently.

Switching on the tumble dryer

3. Selecting a programme

- Press the  button.

The welcome screen will light up.

There are different ways to select a drying programme in the main menu.

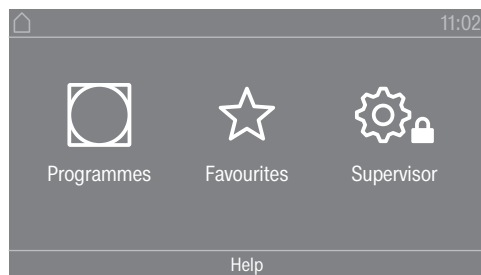

- Touch the  Programmes sensor control.

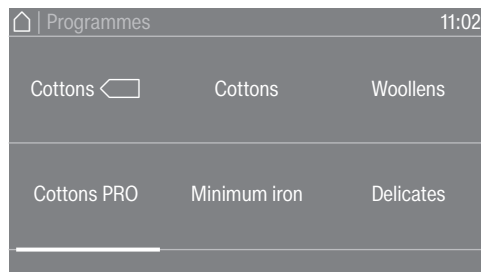

- With your finger, swipe to the left until you reach the required programme.
- Touch the sensor control for that programme.

The display will change to the standard menu for that drying programme.

Alternatively, you can select a programme from the Favourites list. The preset programmes under ☆ Favourites cannot be changed via the Supervisor level.

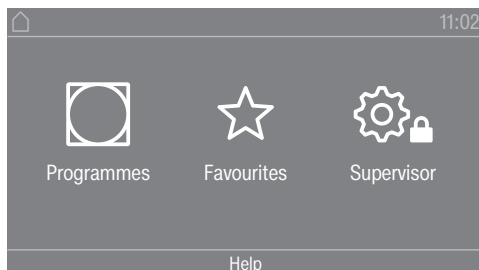

- Touch the ☆ Favourites sensor control.

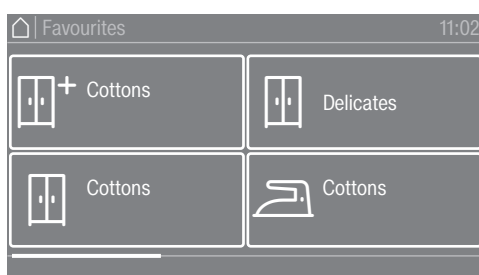

- With your finger, swipe to the left until you reach the required programme.
- Touch the required programme.

The display will change to the standard menu for that drying programme.

4. Selecting programme settings

Select the drying level

With many programmes, you can change the preset drying level. Depending on the programme, you can select different drying levels.

Selecting extra options

The drying programmes can be augmented with various Extras. Some Extras can only be selected for certain drying programmes.

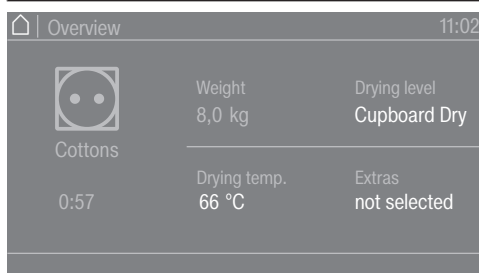

- Touch the Extras sensor control.

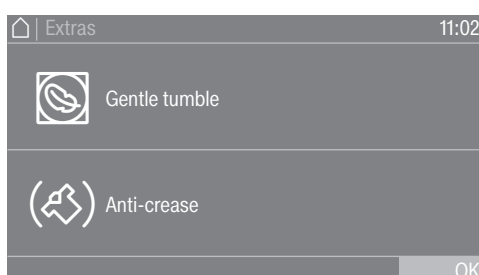

- Touch the sensor control for the extra you want.

Drying

- Only press OK when the extra appears on the display.

The relevant symbol for the required extra (☉ or ☼) lights up.

☉ Low temperature

Delicate fabrics (with the ☉ symbol on the care label, e.g. acrylic garments) are dried at a lower temperature. The programme duration is also longer.

☼ Gentle tumble

Sensitive items are dried with fewer drum rotations and a lower drying temperature.

☼ Anti-crease

At the end of the programme, the drum will continue to rotate in a certain rhythm, depending on the selected programme. This helps to prevent creasing at the end of the programme.

The Anti-crease function is switched off as the factory default setting. The Anti-crease function can be switched on in the supervisor level with a variable duration of up to 12 hours. You can find this setting in the supervisor level under the Process technology/Anti-crease menu.

5. Starting a programme

Payment device (optional)

If your machine is connected to a payment device, the amount of payment required will appear in the display.

Money may be lost if the drum door is opened or the programme is cancelled.

Depending on the settings, money may be lost in the payment device if the drum door is opened or the programme is cancelled.

Do not open the door once the programme has started.

Do not cancel a drying programme while it is running.

Starting the programme

The programme can be started as soon as the *Start/Stop* sensor control is flashing on and off.

- Touch the *Start/Stop* sensor control.

If a delay start period has been selected, this will appear in the display.

The drying programme will start either straight away or once the delay start period has elapsed. The programme time left is shown in the display.

Calling up current programme parameters

During the programme running time, you can use the pull-down menu to view the parameters of the current drying programme (e.g. drying level, load size, selected extras, drying temperature).

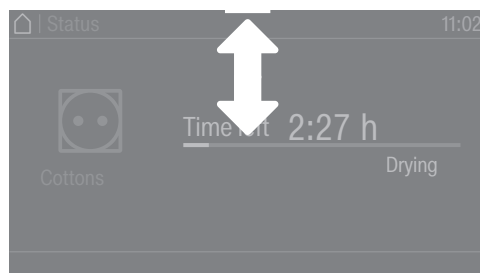

- To call up the pull-down menu, swipe your finger from top to bottom during the programme running time.



The pull-down menu displays the parameters of the drying programme.

- To close the pull-down menu again, swipe your finger from bottom to top or press the ↶ sensor control.

Programme running time/Time left estimation

The programme running time depends on the quantity of laundry, the type of fabric and the residual moisture in the laundry. The displayed programme running time for drying level programmes can therefore vary or “jump”. The tumble dryer’s electronic module adapts during the ongoing drying programme. The displayed programme running time becomes more and more accurate.

When using the programmes for the first time, the displayed time sometimes deviates significantly from the real time left. The difference between the estimated and achieved time becomes smaller if the corresponding programme is run more often. If different load sizes are dried in one programme, the time left display can only show an approximate time.

End of the programme

End of programme The laundry will be cooled down after the end of the programme. The message *Finish/Cool down* will appear on the display during the cooling phase. The laundry can now be removed.

After the cooling phase and the drying programme are completed, the message *Finish* is displayed.

The tumble dryer will switch off automatically after the set time after the end of a programme.

If the Anti-crease (🌀)* extra has been selected, the drum continues to rotate in intervals after the end of the programme. This reduces creasing if the laundry cannot be removed straight away.

* The Anti-crease function is switched off as the factory default setting and can be activated in the supervisor level.

Removing the laundry

- Open the door.
- Remove everything from the drum.

Items left in the tumble dryer could be damaged by overdrying when the tumble dryer is used the next time.
Always remove all items from the drum.

- Switch the tumble dryer off by pressing the ⏻ button.

Care notes

This tumble dryer requires regular maintenance, particularly if it is used on a continuous basis. Please see “Cleaning and care” for details.

Timer

Prerequisite for setting the timer

The Delay start must be activated in the Supervisor level in the Controls / Display menu so that the Timer can be selected. Before the programme starts, the Timer can be used to select a programme start time or programme end time.

Setting the timer

- Touch the Timer sensor control.
- Select the *Finish at*, *Start in* or *Start at* option.
- Set the hours and the minutes and confirm your entry with the OK sensor control.

Washing machine

Changing a programme

Altering the wash programme

You will need to cancel the current programme before you can select a new one.

Interrupting a programme

You can cancel a wash programme at any time after it has started.

If the programme is locked, the disinfection programmes or payment programmes can only be cancelled by entering a code.

- Touch the *Start/Stop* sensor control.

The following appears in the display:

i Programme stopped. Continue with "Start/Stop"

The following appears in the display:

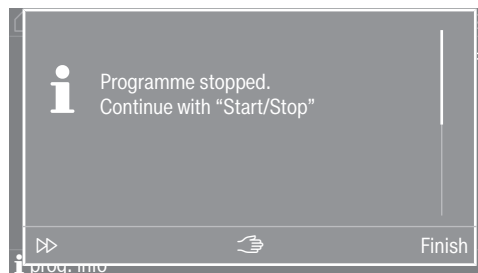

- Select Finish.

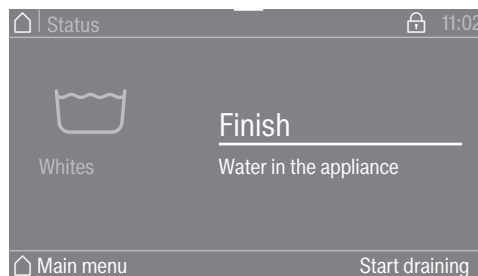

The suds are not drained so they can be used again in a subsequent programme. Once the programme has ended, the programme end screen is displayed. It is possible to switch to the main menu while the suds are in the drum or to drain the suds by pressing the Start draining control. If permanent automatic water drainage is required, Automatic drainage can be activated at supervisor level.

The drum door remains locked while there is water in the machine.

The door can be opened under the condition Programme end without water. If the temperature is too high, wait until it has cooled down so that the door can be opened.

- Wait until the door unlocks.
- Pull open the door.
- Remove the laundry.

Switching on the washing machine after an interruption to the power supply

If the washing machine is switched off with the  button during a wash programme, the programme will be interrupted.

- Switch the washing machine back on with the  button.
- Note the message in the display.

Changing the programme sequence

- Touch the *Start/Stop* sensor control.
The programme continues.

Changing the programme sequence

Adding or removing laundry

You can add or remove laundry items for a short period immediately after the programme has started.

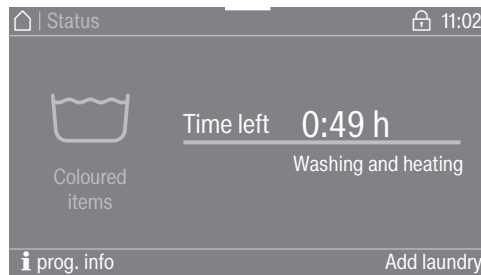

- Touch the Add laundry selection area.

If the message Add laundry is not visible in the display then it is no longer possible to add items of laundry.

The wash programme will stop and the door will unlock.

 Risk of chemical burns from detergent.
When adding or removing laundry, your skin may come into contact with detergent, particularly if the detergent is dispensed externally. Take care when placing your hands inside the drum.
If suds have come into contact with the skin, rinse off immediately with plenty of lukewarm water.

- Pull open the door.
- Add laundry or remove individual items.
- Close the door.
- Touch the *Start/Stop* sensor control.

The wash programme will continue.

Changing the programme sequence

Tumble dryer

Changing a programme once it has started

You cannot change to another programme once a programme has started (this prevents unintentional alterations). You will need to cancel the current programme before you can select a new one.

 Risk of fire due to incorrect use and operation. The laundry can burn and destroy the tumble dryer and the surroundings. See the section on “Warning and safety” for further information.

Cancelling the current programme

- Touch the *Start/Stop* sensor control. The following message appears in the display: Cancel programme?
- Touch the *Yes* sensor control to cancel the current programme.

 Risk of burns by touching hot laundry or the tumble dryer drum. Touching the hot laundry or the tumble dryer drum may cause burns. Let the laundry cool down and remove it carefully.

Opening the door of the tumble dryer during the programme sequence will cancel the current programme. If the Door opening status/Interrupt programme function is selected in the supervisor level, the current programme will be interrupted when the door is opened. In the case of an interruption, the tumble dryer will remain in the current programme. The interrupted programme will be continued when the door is closed and the *Start/Stop* sensor control is pressed.

Reselecting a cancelled programme

- Open and close the door.
- Select and start a new programme.

Adding laundry

- Open the door.

 Risk of burns by touching hot laundry in the tumble dryer drum. The laundry and the tumble dryer drum are still hot and can cause burns if they are touched. Let the laundry cool down and remove it carefully.

- Add the laundry.
- Close the door.
- Start the programme.

Adding laundry during ongoing Delay start period

You can open the door to add or remove laundry.

- All programme settings will be saved.
- You can change the drying level, if required.
- Open the door.
- Add or remove laundry.
- Close the door.
- Touch the *Start/Stop* sensor control so that the Delay start period continues.

Changing the programme sequence

Time left

Altering the programme sequence can cause the programme duration shown in the display to be adjusted.

Problem solving guide

Troubleshooting

Opening the door in an emergency in the event of a power cut

The drum door cannot be opened.

⚠ Warning! Danger from rotating drum and danger of scalding.
Before inserting the Torx wrench, make sure that the machine is disconnected from the electricity supply, the drum has stopped and there is no water in the machine.

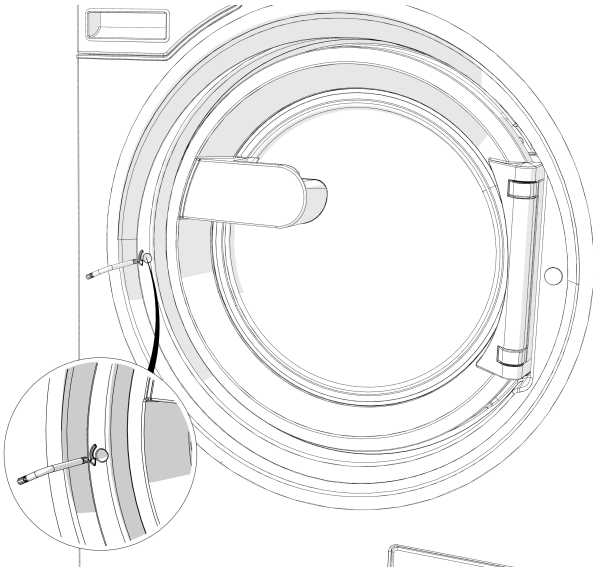

- Using a T 40 Torx wrench, turn the release element with the inner hexagon 2 whole revolutions **in the direction of the arrow**.

Tip: Pushing on the door at the same time makes it easier to turn the emergency release element.

The release element is opposite the door hinge at the same height as the door handle (see diagram).

The release element must not be turned in the opposite direction to the arrow.
Danger of damage to the door lock.

The turn resistance will noticeably reduce. When the emergency release element moves freely, the door is unlocked.

Tip: It is not necessary to screw the emergency release element back in.

The door can now be opened.

Customer service

In the event of a fault, contact the Miele Customer Service Department.

When contacting the Customer Service Department, please quote the model, serial number (SN) and material number (mat. no.) of your machine. This information can be found on the data plate. The data plate is visible in the door ring when the drum door is open, or on the back of the machine at the top:

Please also pass on the fault message appearing in the machine display to the Customer Service Department.

Use only original Miele spare parts. The Miele Customer Service Department will also require the model, serial number (SN) and material number (mat. no.) when ordering.

Problem solving guide

The majority of faults and problems that arise during day-to-day use can be remedied without external assistance. You can save time and money in many cases, as you do not need to call the Miele Customer Service Department.

The following tables are designed to help you to find the cause of a malfunction or a fault and to resolve it. You should, however, note the following:





 Repair work to electrical appliances should only be carried out by an authorised technician. Repairs by unqualified persons can cause considerable danger to users.

A programme cannot be started





Problem	Cause and remedy
The display remains dark, and the <i>Start/Stop</i> sensor control does not light up or flash.	No power is being supplied to the washer-dryer stack. <ul style="list-style-type: none"> ■ Check whether the washer-dryer stack is switched on. ■ Check whether the washer-dryer stack is connected to the power supply. ■ Check whether the fuse has tripped.
	The washer-dryer stack has switched off automatically to save energy. <ul style="list-style-type: none"> ■ Switch the washer-dryer stack back on with the  button.
The following appears in the display: F -Door lock fault. You can continue by pressing the "Start/Stop" button	The door has failed to lock. <ul style="list-style-type: none"> ■ Close the door again. ■ Start the programme again. If the fault message appears again, contact the Customer Service Department.
The display is dark and the <i>Start/Stop</i> sensor control is flashing slowly.	If the standby function has been activated at supervisor level, the display switches off automatically to save energy. <ul style="list-style-type: none"> ■ Touch any of the controls. The display switches back on.
The programme is on the pre-start screen and the <i>Start/Stop</i> sensor control is not flashing.	The drum door has been pushed to but is not closed correctly. <ul style="list-style-type: none"> ■ Check whether the drum door is closed correctly.

Problem solving guide

Programme cancellation and fault message

Problem	Cause and remedy
 F - Water drainage fault. If restart fails, call Service.	<p>The drain is blocked or restricted. The drain hose has been fixed too high.</p> <ul style="list-style-type: none"> ■ Clean the drain filter and the drain pump. ■ The maximum delivery head is 1 m.
 F - Water intake fault. If restart fails, call Service.	<p>The water inlet is blocked or restricted.</p> <ul style="list-style-type: none"> ■ Check whether the water inlet is turned on properly. ■ Check the water inlet hoses for leaks. ■ Check whether the water connection pressure is sufficient. ■ Check whether the water inlet hoses are kinked.
	<p>The water inlet filters are blocked.</p> <ul style="list-style-type: none"> ■ Clean the filters.
 Disinfection temperature not reached	<p>The required temperature was not reached during the disinfection programme.</p> <ul style="list-style-type: none"> ■ The washing machine has not carried out the disinfection cycle correctly. ■ Start the programme again.
 Fault F. If restart fails, call Service	<p>There is a fault.</p> <ul style="list-style-type: none"> ■ Disconnect the washer-dryer stack from the electricity supply. ■ Wait at least 2 minutes before reconnecting the washer-dryer stack to the electricity supply. ■ Switch the washer-dryer stack on again. ■ Start the programme again. If the fault message appears again, contact the Customer Service Department.

The display shows a message

Problem	Cause and remedy
 Container empty	<p>One of the liquid dispensing detergent containers is empty.</p> <ul style="list-style-type: none"> ■ Refill the detergent container.
 Hygiene info: run a programme of at least 60°C	<p>During the last wash, a wash programme with a temperature below 60 °C was selected.</p> <ul style="list-style-type: none"> ■ Start a programme with a minimum temperature of 60 °C or the Clean machineExtrasIntensive programme.
 F - Water intake fault. If restart fails, call Service.	<p>The hot water supply is blocked or restricted.</p> <ul style="list-style-type: none"> ■ Check whether the hot water stopcock has been properly opened. ■ Check whether the water inlet hose is kinked.
 Laundry not properly spun	<p>The selected spin speed was not reached during the final spin due to excessive imbalance.</p> <ul style="list-style-type: none"> ■ Check that the washing machine is level. ■ Start the spin cycle again.

Problem	Cause and remedy
i Machine is leaking	<p>The washing machine or drain valve is leaking.</p> <ul style="list-style-type: none"> ■ Close the stopcock. ■ Contact the Miele Customer Service Department.

Insufficient wash results

Problem	Cause and remedy
Liquid detergent does not give the required result.	<p>Liquid detergents usually contain no bleaching agents. They do not remove fruit, coffee or tea stains.</p> <ul style="list-style-type: none"> ■ Use a general purpose powder detergent containing a bleaching agent. ■ Pour stain remover powder into drawer  in the dispenser compartment and liquid detergent into a dispenser ball. ■ Never put stain remover powder and liquid detergent together in the detergent drawer.
White residues which look like powder detergent are seen on dark textiles after washing.	<p>The detergent contained compounds (zeolites) to aid water softening which are not soluble in water. These have ended up on the laundry.</p> <ul style="list-style-type: none"> ■ Try to brush off the residues with a soft brush once the laundry is dry. ■ In future, wash dark textiles using a detergent which contains no zeolites. Liquid detergents usually contain no zeolites.
Textiles with particularly greasy soiling are not properly clean.	<ul style="list-style-type: none"> ■ Select a programme with pre-wash. Use liquid detergent for the pre-wash. ■ Continue to use universal powder detergent for the main wash.
	<p>The use of heavy-duty detergent is recommended in the main wash for very heavily soiled workwear. Please seek advice from the detergent manufacturer.</p>
Grey, greasy particles cling to washed laundry.	<p>Insufficient amounts of detergent were used. The laundry was heavily soiled with grease (oils, ointments).</p> <ul style="list-style-type: none"> ■ Use more detergent or use liquid detergent with this type of soiled laundry. ■ Before washing the next load run a 60 °C programme with liquid detergent but without a load.

Insufficient drying results

Problem	Cause and remedy
Adjust the load The drum is empty or the laundry is too dry.	<p>This is not a fault. In some programmes, if the drum has been underloaded or is empty, the programme will be cancelled. This can also happen if the items are already dry.</p> <ul style="list-style-type: none"> ■ Use the hot air drying programme to dry individual items. ■ Delete the message: <ul style="list-style-type: none"> – Open the door.

Problem solving guide



Problem	Cause and remedy
Power failure; programme stop. Please press OK button	<p>The tumble dryer was switched off or the power failed during the drying process.</p> <ul style="list-style-type: none"> ■ Press the <i>OK</i> button after switching the tumble dryer back on/resuming the power and start the programme again.
Clean air channels. Clean the fluff filter. Check the air guide.	<p>Reminder to clean the fluff filter.</p> <ul style="list-style-type: none"> ■ Clean the fluff filter. ■ Delete the problem message: <ul style="list-style-type: none"> – Press <i>OK</i>.
	<p>A defect in the air guide was identified.</p> <ul style="list-style-type: none"> ■ Clean the fluff filter. ■ Check all possible causes described under “The drying process goes on too long or even switches off”. ■ Delete the problem message: <ul style="list-style-type: none"> – Open and close the door.
	<p>The vent ducting may be very long, but this is not a fault.</p> <ul style="list-style-type: none"> ■ If the vent ducting is very long, the programme times will be longer and energy consumption will be higher.
	<p>A significant defect in the air guide was identified.</p> <ul style="list-style-type: none"> ■ See above. ■ Delete fault message: <ul style="list-style-type: none"> – Press <i>OK</i>.
The laundry is not sufficiently dry.	<p>The load consisted of different types of fabric.</p> <ul style="list-style-type: none"> ■ Finish drying using the Warm air programme. ■ Select a more suitable programme next time, see the “Programme overview” document.
Feather-filled pillows smell after drying.	<p>Feathers tend to develop a build-up of their own smell or smells from other sources when they are heated.</p> <ul style="list-style-type: none"> ■ Smells can be reduced through natural ventilation after drying.
Items made of synthetic fibres are charged with static electricity after drying.	<p>Synthetic fibres tend to attract static charge.</p> <ul style="list-style-type: none"> ■ Static charge can be reduced by adding a fabric softener to the final rinse in the washing programme.
There is a build-up of fluff.	<p>Fluff is principally the result of friction when garments are being worn and to some extent when they are being washed. By contrast, the tumble dryer exerts barely any stress on the garments, which means it hardly affects their lifespan.</p> <ul style="list-style-type: none"> ■ Fluff is collected by the fluff filter and can be easily removed (see “Cleaning and care”).
Condensation is forming in the drum.	<p>The tumble dryer is installed on a shared exhaust air duct.</p> <ul style="list-style-type: none"> ■ The tumble dryer must always be installed with a non-return flap when using a combined line. ■ Check the non-return flap for possible defects on a regular basis and replace the flap if necessary.

Problem	Cause and remedy
The drying process goes on too long or even switches off.	In some circumstances, you may be asked to clean the air channels/air guide. <ul style="list-style-type: none"> ■ Please check all the possible causes described below.
	The fluff filter is clogged with fluff. <ul style="list-style-type: none"> ■ Remove the fluff.
	The air guide area is clogged with hair and fluff, for example. <ul style="list-style-type: none"> ■ Clean the air guide area. ■ You can remove the cover in the loading area to clean the air guide area underneath.
	The vent ducting or its openings are clogged with hair and fluff, for example. <ul style="list-style-type: none"> ■ Check and clean all components in the vent ducting (e.g. wall pipe, external grille, bends, elbows, etc.).
	The flow of air is insufficient (e.g. because it is installed in a small room). <ul style="list-style-type: none"> ■ When drying, open a door or window to ensure sufficient ventilation.
	The laundry has not been spun sufficiently. <ul style="list-style-type: none"> ■ Make sure that your laundry is thoroughly spun at the appropriate spin speed in the washing machine.
	The dryer has been overloaded. <ul style="list-style-type: none"> ■ Do not exceed the maximum load size for the drying programme selected.
	Metallic components, e.g. zips, have prevented the tumble dryer from registering the correct laundry moisture level. <ul style="list-style-type: none"> ■ Open any zips next time. ■ If the problem occurs again, dry garments with long zips using the hot air drying programme.

General problems with the washer-dryer stack

Problem	Cause and remedy
The washer-dryer stack shakes during the spin cycle.	The machine feet are not level and not secured. <ul style="list-style-type: none"> ■ Level the washer-dryer stack and adjust the feet correctly.
Strange pump noises can be heard.	Not a fault. These slurping noises occur at the start and end of a pump sequence as a normal part of the operation.
Large amounts of detergent residue remain in the detergent drawer.	The water flow pressure is too low. <ul style="list-style-type: none"> ■ Clean the water inlet filters.
	Powder detergent used in conjunction with water softeners tends to become sticky. <ul style="list-style-type: none"> ■ Clean the detergent drawer and, in the future, add washing powder in the compartment first, and then add the water softener.

Problem solving guide

Problem	Cause and remedy
Fabric conditioner is not completely dispensed or too much water remains in the  compartment.	The siphon is not correctly positioned or is clogged. <ul style="list-style-type: none"> ■ Clean the siphon, see “Cleaning and care – Cleaning the detergent drawer”.
The display is in a different language.	A different language has been selected. <ul style="list-style-type: none"> ■ Switch the washer-dryer stack off and on again. The selected supervisor language appears in the display.
	The supervisor language has been changed. <ul style="list-style-type: none"> ■ Select the language you require (see “Language” under “Supervisor level”).
The laundry has not been spun properly. The laundry is still wet.	The machine detected a high level of imbalance during the final spin and reduced the spin speed automatically. <ul style="list-style-type: none"> ■ Include both large and small items in the load as this will achieve better distribution.
The drum remains stationary but the programme keeps running.	Fault in the programme sequence <ul style="list-style-type: none"> ■ Switch the washing machine off and then back on with the  button. ■ Note the message in the display. ■ Touch the <i>Start/Stop</i> sensor control. The drum continues to spin and the programme continues.

The door will not open or close

Problem	Cause and remedy
The door cannot be opened.	The door is locked during the wash process. <ul style="list-style-type: none"> ■ Touch the <i>Start/Stop</i> sensor control. ■ Select Programme cancellation or Add laundry. The door will unlock and you will be able to pull it open.
	There is still water in the drum and the washing machine is unable to drain. <ul style="list-style-type: none"> ■ Empty the drainage system as described in “Troubleshooting”.
Cool down appears in the display at the end of the programme or after a programme has been cancelled.	To protect the user against scalding, the door cannot be opened if the suds temperature is higher than 50 °C. <ul style="list-style-type: none"> ■ Wait until the temperature in the drum has decreased and the message has gone out in the display.
The following appears in the display: F - Door lock fault. Call Service.	The door lock has jammed. <ul style="list-style-type: none"> ■ Contact the Miele Customer Service Department.

Opening the door in the event of a blocked drain outlet and/or power cut

⚠ Disconnect the machine from the mains electricity supply.

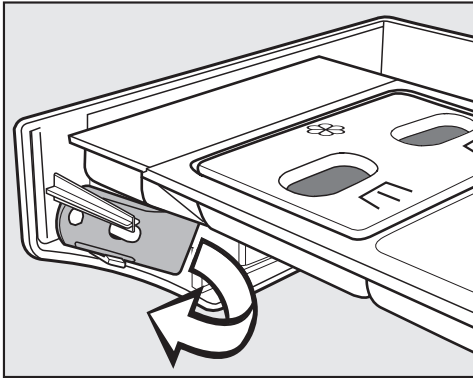

- There is a lever behind the detergent drawer panel which opens the access panel to the drainage system.
The lever is provided in the companion pack/as an accessory for models with a locked detergent drawer.
Remove the lever.

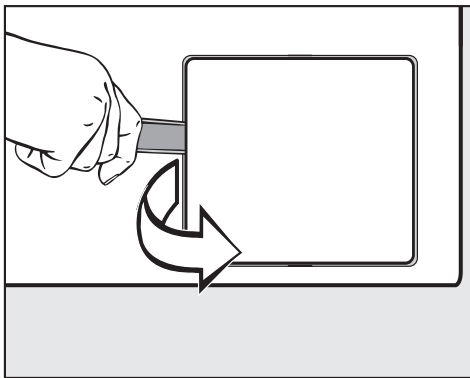

- Open the access panel to the drainage system.

If the drain outlet is clogged, a large amount of water may be retained in the washing machine.

⚠ If laundry has been washed at a high temperature, water draining out of the machine will still be hot.

- Place a suitable container under the access panel.

Do not unscrew the drain filter completely.

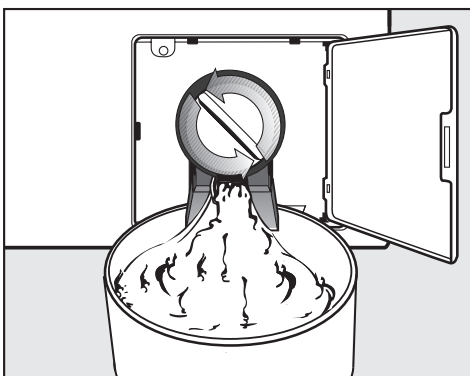

Problem solving guide

- Unscrew the drain filter to let the water out.
- Tighten the drain filter back up again if you need to interrupt the flow of water.

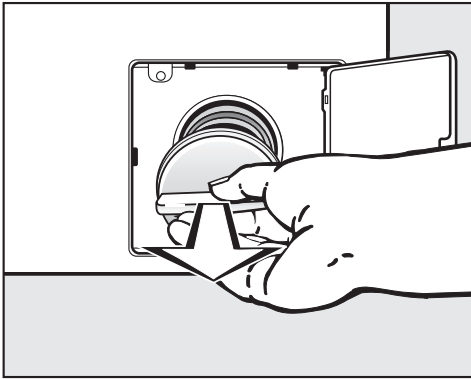

- If no water flows out, unscrew the drain filter completely.
- Clean the drain filter thoroughly.

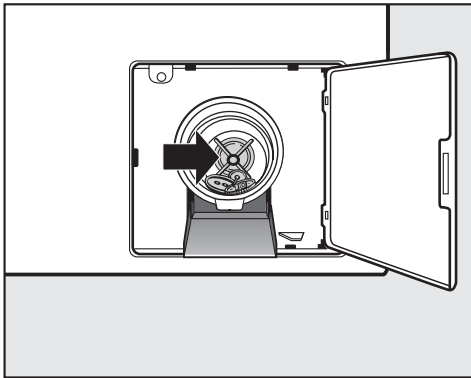

- Remove any foreign objects (e.g. buttons, coins, etc.) and clean the interior. Turn the impellers by hand to check that they rotate freely.
- Put the drain filter back in place and screw it tight.

⚠ Make sure the drain filter is reinserted and securely tightened. Otherwise there is a risk of water leakage during use.

⚠ Disconnect the washer-dryer stack from the mains electricity supply.

- Carry out cleaning and maintenance of the washer-dryer stack after use if possible.

Do not use a pressure washer or water jet to clean the washer-dryer stack.

- Clean the **casing, control panel and plastic parts** with a mild, non-abrasive cleaning agent or with a soft, damp cloth only. Wipe dry with a soft cloth.

Scouring agents will scratch the surface.

- Clean stainless steel casing parts with a commercially available stainless steel cleaner.
- Remove any deposits from the door seal with a damp cloth.

Penetration of cleaning agents into electrical components.

- When disinfecting the surfaces, use a moist cloth only to clean the front and around the door lock. Do not spray any liquids.

Build-up of rust

The drum is manufactured from rust-free stainless steel. Water or foreign objects containing ferrous substances (e.g. paper clips, metal buttons or metal swarf) which are placed in the machine with the laundry can cause a build-up of rust in the drum. Clean the drum regularly in this case and if rust occurs, remove it immediately with a proprietary stainless steel care product. Check the door seals for ferrous residues and clean thoroughly as described above. This must be carried out regularly.

Cleaning the detergent drawer, detergent compartments and siphons

- Clean the detergent drawer and the detergent compartments thoroughly with hot water as required to remove detergent residues and incrustations.
- If the machine is not going to be used for a long time, leave the flap of the detergent drawer open.

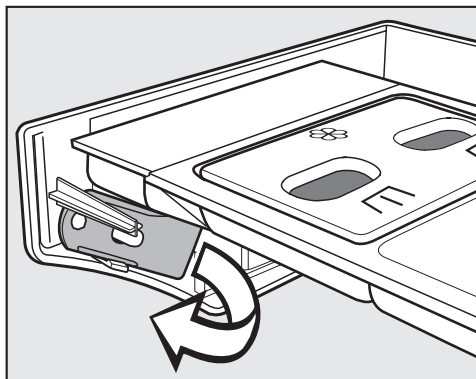

- There is a yellow lever behind the detergent drawer panel.
- Remove the lever.

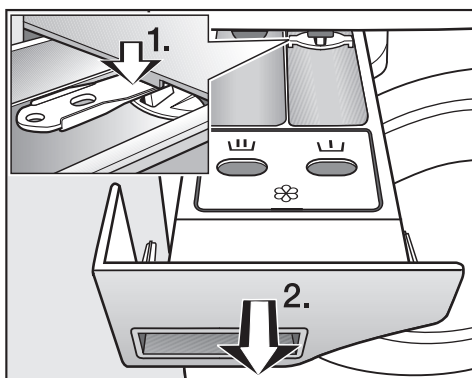

- Pull out the detergent drawer until a resistance is felt.
1. Use the lever to push down and release the lock.
 2. Remove the detergent drawer.

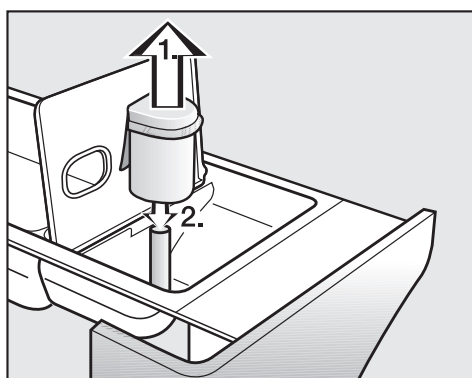

- Clean the siphon.
1. Remove the siphon from the  compartment and rinse under warm running water. Clean the siphon tube in the same way.
 2. Refit the siphon.

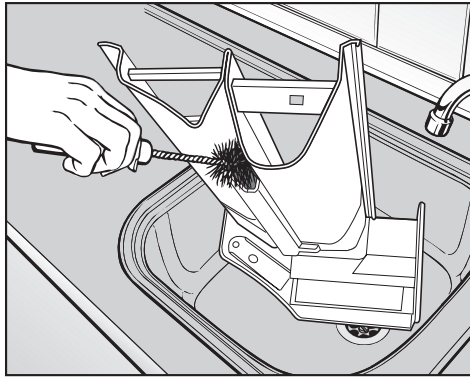

- Clean the fabric conditioner channel using a brush and warm water.

Clean the siphon and fabric conditioner channel particularly thoroughly after using liquid starch a few times. Liquid starch results in clogging.

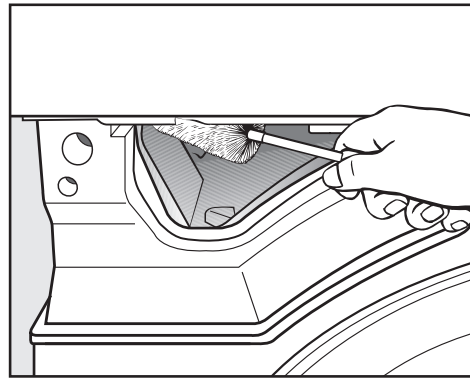

- Use a bottle brush to remove detergent residues and limescale from the jets inside the detergent drawer.

Cleaning and care

Cleaning the water inlet filters

The washing machine has filters to protect the water intake valves. You should inspect the filters approximately every 6 months. Perform this check more often if there are frequent interruptions to the external water supply.

Cleaning the filters in the inlet hoses

- First turn off the stopcock.
- Unscrew the water inlet hose from the stopcock.

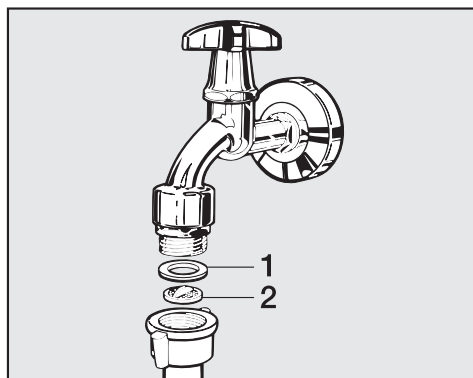

- Remove the rubber seal (1) from the recess.
- Using pointed pliers, take hold of the plastic filter bar (2) and remove it.
- Clean the plastic filter.
- Reassemble in reverse order.

Turn on the stopcock and check the connection is watertight. If water drips out, tighten the connection.

Cleaning the filters in the water intake valves

- Using pliers, carefully loosen the ribbed plastic nut on the intake valve and unscrew.

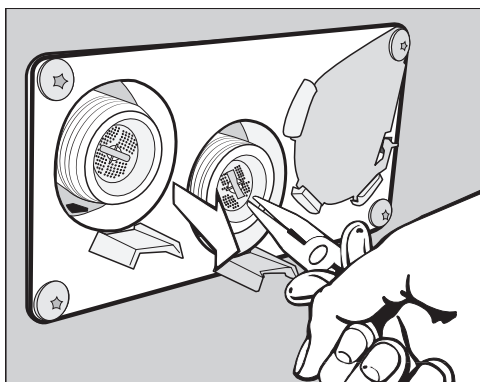

- Use pointed pliers to withdraw the filter by the bar and clean it. Reassemble in reverse order.

The filters must be reinserted after cleaning.

Cleaning the fluff filter

A two-part fluff filter in the air supply area collects fluff released by textiles. Remove and dismantle the fluff filter for cleaning.

Check and clean the fluff filter at the latest when the *Clean out airways* message appears.

Tip: You can also use a vacuum cleaner so that you can remove the fluff without touching it.

Removing the fluff filter

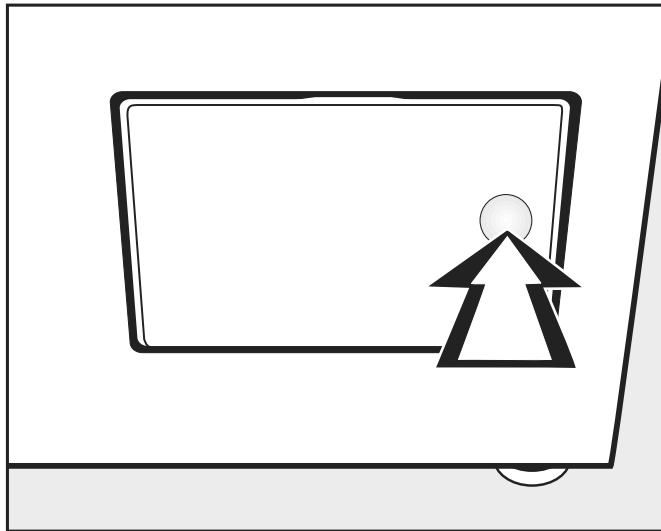

- To open, press against the right side of the fluff filter flap.

When pulling out the fluff filter, do not rotate the handle (see below) as this will dismantle the filter.

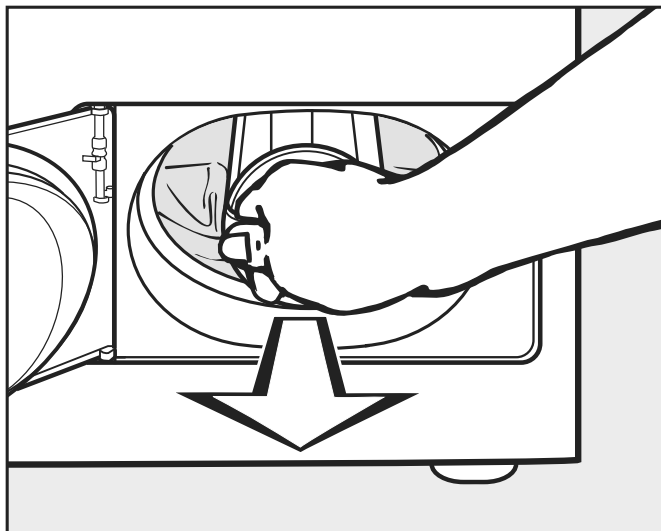

- Use the handle to pull out the fluff filter.

Cleaning and care

Dismantling the fluff filter

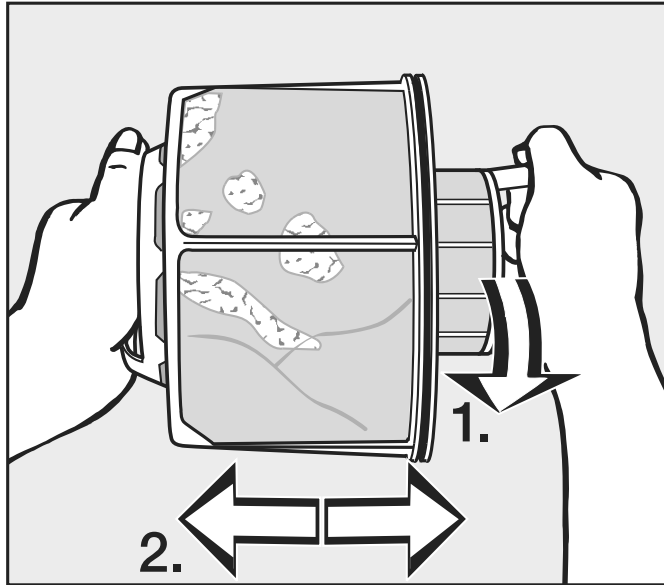

- Hold the fluff filter by the handles.
- 1. Rotate the inner part of the fluff filter (1).
- 2. Pull the two parts of the fluff filter apart (2).

Cleaning the fluff filter parts (dry)

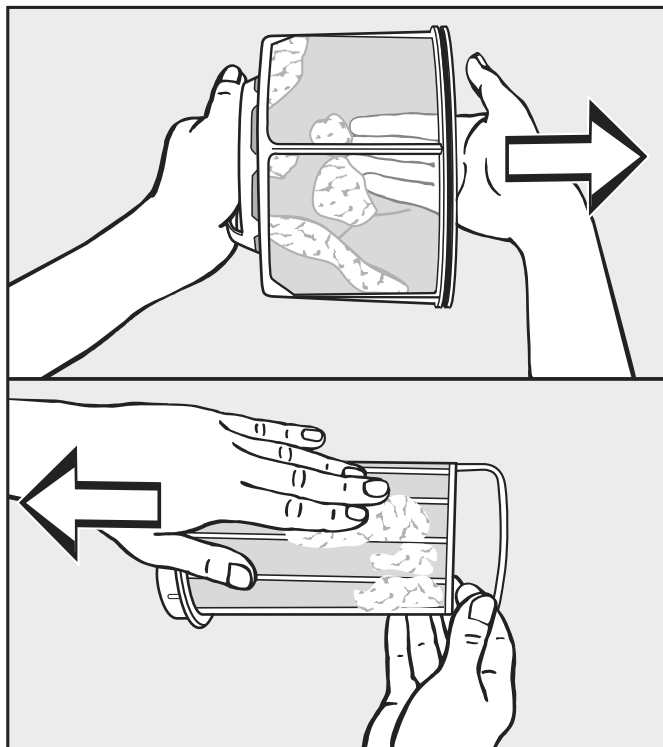

- Shake out the fluff and/or pick it off with your fingers.

Cleaning the fluff filter parts (wet)

- Only clean the fluff filter parts under warm running water if there is a lot of compacted fluff on them.

Dry the fluff filter parts before reassembling them. A wet fluff filter could cause operational faults while drying.

Inserting the fluff filter

If there is a lot of visible fluff, clean the air supply area before reinserting the cleaned fluff filter. See next page.

- Insert the inner fluff filter part into the outer part.
- Turn the inner part of the fluff filter clockwise slightly until you feel it engage.
- Hold the fluff filter by its handle and push it as far as it will go into the lower air supply area.

Do not rotate the handle as this will dismantle the filter.

- Close the fluff filter flap.

Cleaning and care

Cleaning the air supply area

Check the air supply area from time to time and clean it if there is a lot of fluff present.

Rapid cleaning

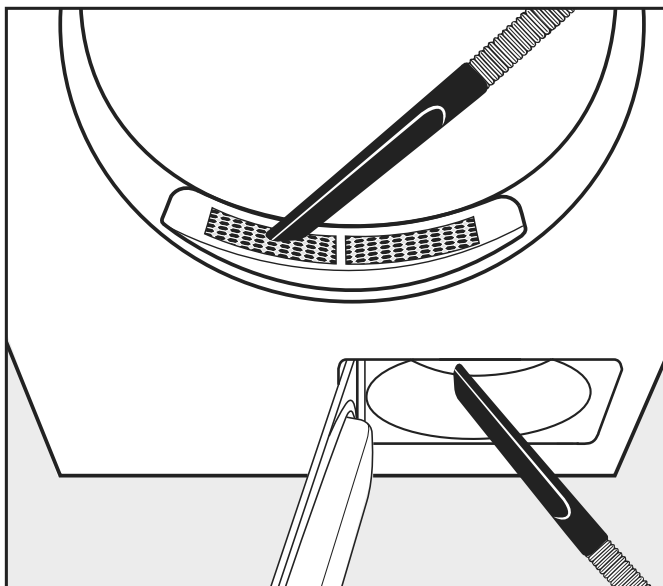

- Use a vacuum cleaner to remove fluff.
 - From cover in door area (top).
 - From air supply area in front of the fan impeller (bottom) after first removing and cleaning the fluff filter.

Additional cleaning

Fan impeller

The fan impeller behind the fluff filter flap may be soiled with detergent residues and fluff.

Check the fan impeller from time to time and clean it if it is heavily soiled.

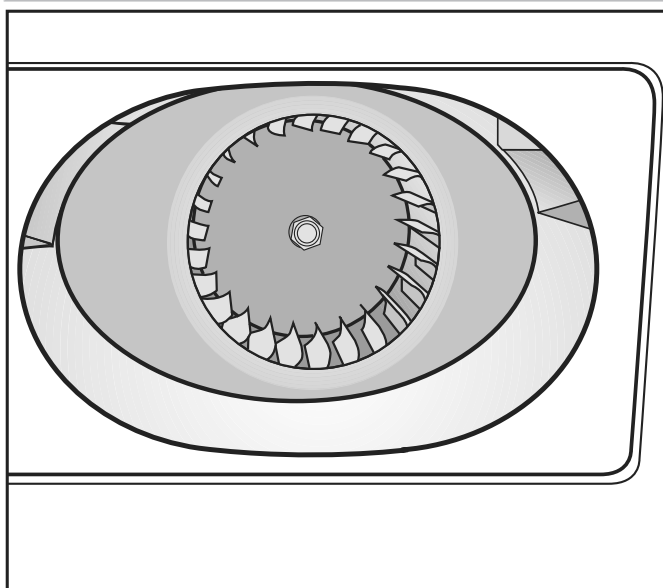

- Using a damp cleaning cloth, carefully remove the coating on the fan impeller.

- Also clean the area in front of the fan impeller.
- Use a vacuum cleaner to remove fluff.
- Remove any fluff from the inside of the open fluff filter flap and the sealing element. Be careful not to damage the sealing element.

Cover in door area

Only remove the cover in the door area in the event of a major blockage.

Removing the cover

- Look in the drum.

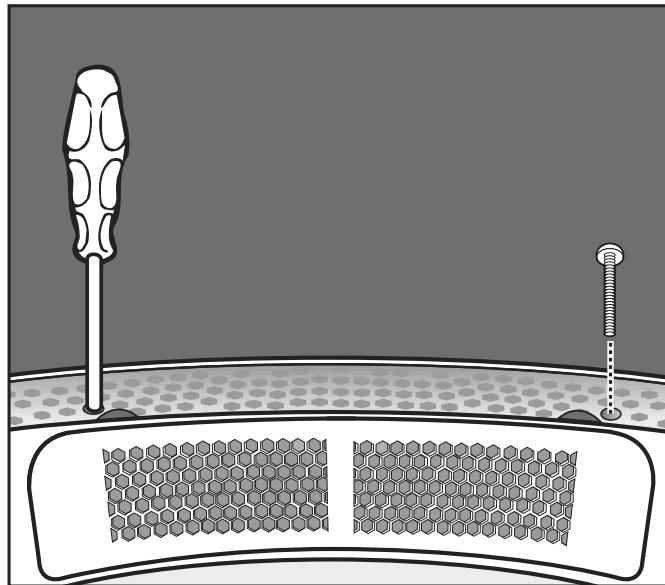

- Underneath the cover on the left and right, unscrew the Torx screws through the round holes.

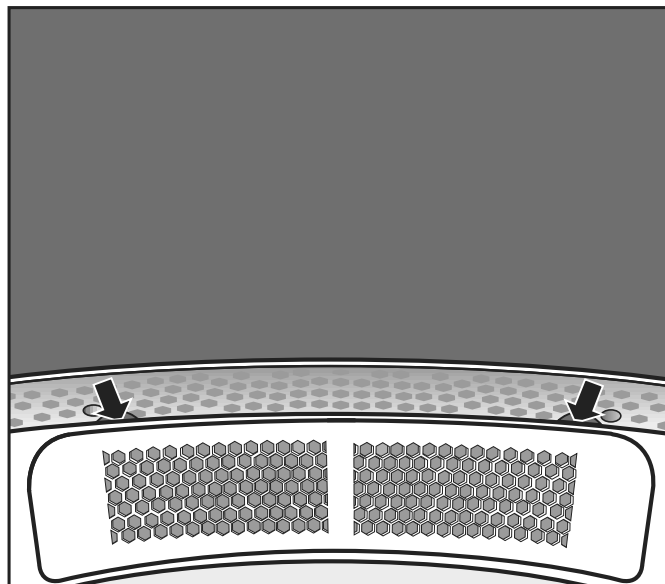

- Reach under the edge of the cover (see arrows) and lift off the cover.
- Clean the air supply area underneath the cover with a vacuum cleaner.
- Clean the cover.
- Clean the air supply area in front of the fan impeller (open the fluff filter flap).

Cleaning and care

- Refitting
- Carefully position the cover on the left or right side of the opening.
 - Press down the cover until it engages on the opposite side.
- Securing the cover
- Look in the drum.
 - Underneath the cover on the left and right, screw in the Torx screws through the round holes.

- To avoid the risk of frost damage, the washer-dryer stack must not be located in rooms which may be subject to very low temperatures.

General operating conditions

This washer-dryer stack is intended only for use in a commercial environment and must only be operated indoors.

- Ambient temperature: 0-40 °C
- Relative humidity: non-condensing
- Maximum height above sea level of location site: 2000 m

Depending on the nature of the installation site, sound emissions and vibration may occur.

Tip: Have the installation site inspected and seek the advice of a specialist in instances where increased noise may cause a nuisance.

- Transport the machine on a pallet truck inside the room.

Machines with feet must not be pushed to move them.
This could damage them.

- Remove the packaging carefully with a suitable tool.
- Lift the individual machines in the washer-dryer stack off the pallet using a lifting device.

Installation

For ease of maintenance

For ease of future maintenance and servicing, the minimum dimensions and distance to the wall must be observed to enable access.

- The minimum dimensions and distance to the wall must be observed.

Minimum safety distance to the wall approx. 400 mm to allow for maintenance.

Minimum safety distance to the side 300 mm (wall or other machines).

- Adjust the washer-dryer stack's adjustable feet until the machine is level.

The washer-dryer stack must be completely level to ensure smooth operation.

PDW 909

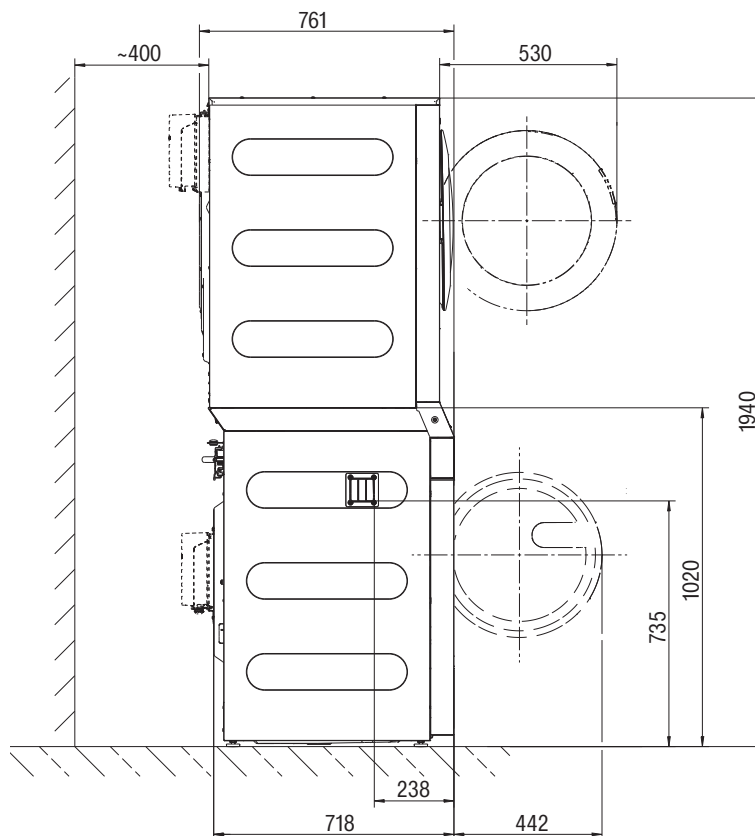

Installing the washer-dryer stack

The washer-dryer stack must be installed by the Miele Customer Service Department or by an authorised dealer. Please observe the information on the installation plan.

This washer-dryer stack is only intended for items of laundry that have not been proofed with dangerous or inflammable substances.

The washing machine or tumble dryer must not be operated as individual machines.

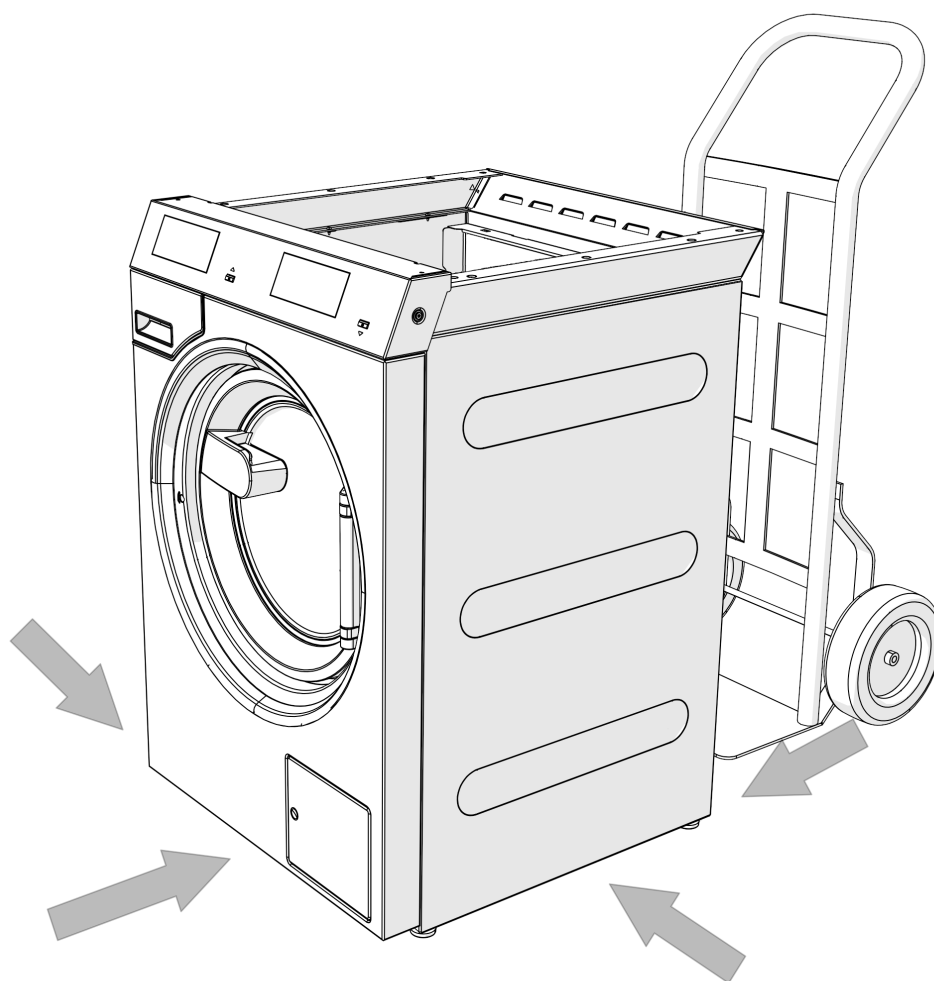

- Transport the washing machine and the dryer in the washer-dryer stack to the installation site one at a time.

⚠ During transportation of the machines, ensure their stability.

⚠ Do not pick them up by the drum door.

- You can also transport the washer-dryer stack to its installation site once it has been assembled.

The assembled washer-dryer stack weighs 209 kg.

Installation

 During transportation of the complete washer-dryer stack, ensure its stability. The height and centre of gravity present a risk of tipping over.

Transit bars

Removing the transit bars

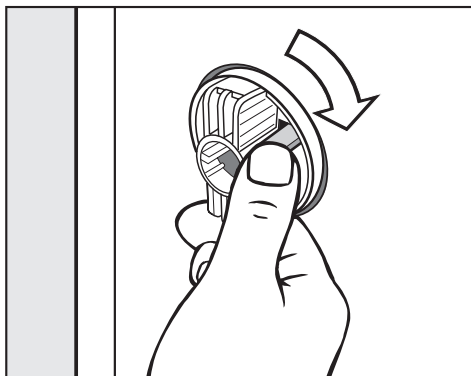

- Release the catch and turn the left-hand transit bar 90° clockwise.

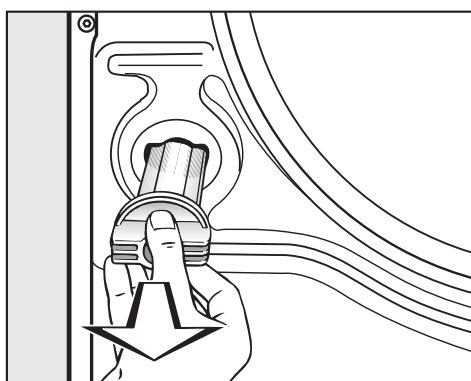

- Pull out the transit bar.

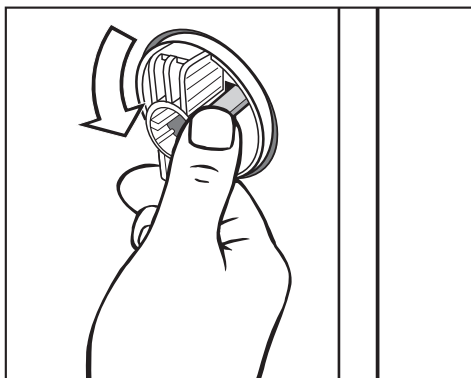

- Release the catch and turn the right-hand transit bar 90° anti-clockwise.

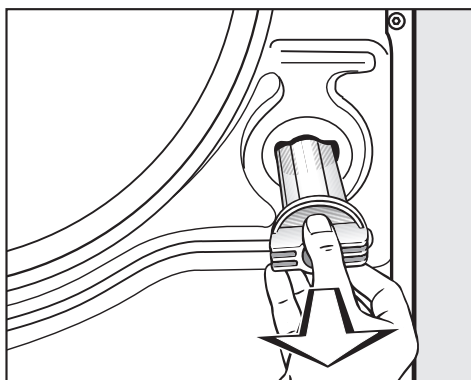

- Pull out the transit bar.

Installation

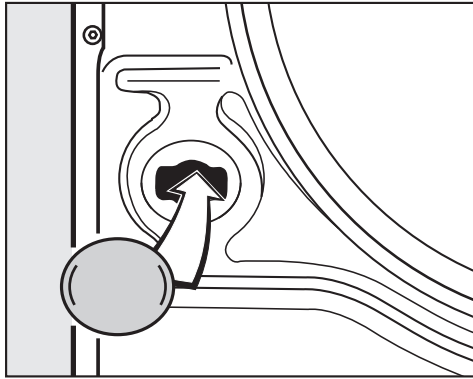

- Fit the supplied stoppers onto the two holes.

Retain the transit bars. They need to be refitted should the machine ever need to be moved again.

Refitting the transit bars

- Refitting is carried out by reversing the procedure.

Levelling

Ensure that the machine feet and the installation surface are dry to prevent the machine from slipping during the spin cycle.

Incorrect installation may increase water and energy consumption and may cause the washing machine to move about.

The four adjustable feet are used to level the washing machine. The machine is supplied with all feet screwed in.

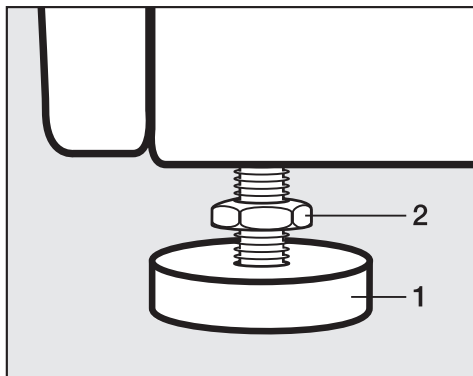

- Using the open spanner supplied, turn the counter nut (2) in a clockwise direction. Then turn the counter nut (2) together with the foot (1) to unscrew.

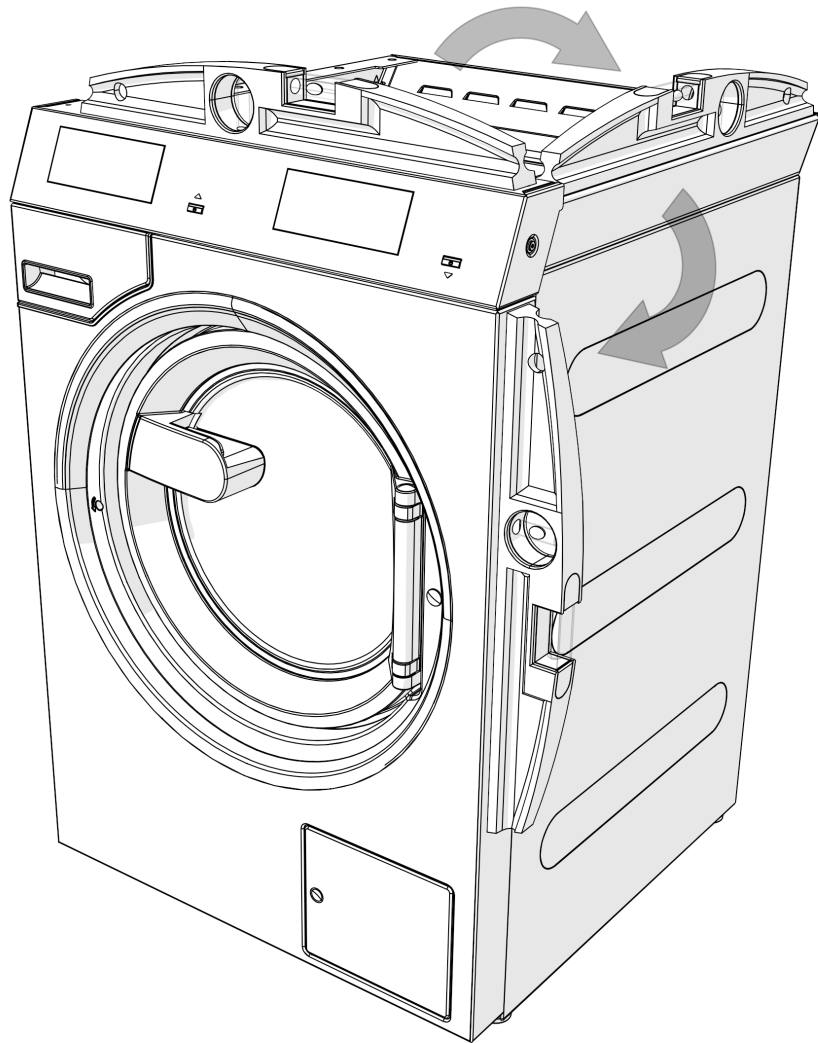

- Use a spirit level to check the washing machine is standing level.
- Hold the foot (1) securely with a pipe wrench. Turn the counter nut (2) again using the open spanner supplied until it sits firmly up against the casing.

All four counter nuts must sit firmly up against the housing. Please also check this for the feet which did not need adjustment. Otherwise there is the danger of the washer-dryer stack moving about.

Securing the machine

- The feet of the washing machine must be secured to the concrete plinth using the fixtures and fastenings supplied.

Fittings supplied are for installation on a concrete floor. For other types of flooring, please purchase suitable fastening materials separately.

 The washer-dryer stack must be secured using tensioning strips during installation.

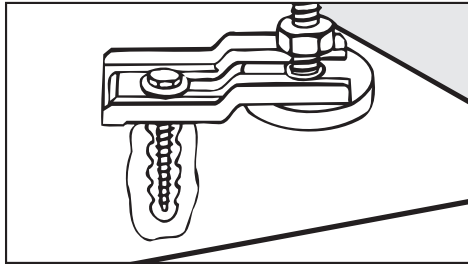

- Secure all four feet of the washer-dryer stack with the tensioning strips that are included.
- Follow the installation instructions supplied.

Installation

Water connection

For compliance to The Water Supply (Water Fittings) Regulations 1999, please fit the double check valves included in the scope of supply to the on-site water supply for every water inlet hose used. The double check valves prevent water from the inlet hoses flowing back into the on-site drinking water supply.

Non-return valves are included in the scope of supply.

The flow pressure must be a minimum of 100 kPa and must not exceed 1000 kPa. If the flow pressure is higher than 1000 kPa, a pressure reducing valve must be used.

The machine must be connected to the water supply using the inlet hoses included in the scope of supply.

⚠ The connection points are subject to water supply pressure. Turn on the stopcock slowly and check for leaks. Correct the position of the seal and screw thread if appropriate.

The enclosed double non-return valves must be installed on the stopcock in every water inlet.

Use of non-return valves

In Germany, the machine must be connected to the water supply using the non-return valve.

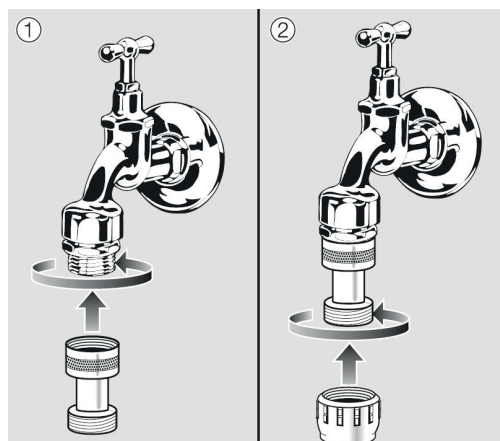

- Screw the non-return valve onto the stopcock.
- Screw the water inlet hose onto the thread of the non-return valve.

⚠ Health risk and risk of damage due to contaminated incoming water.

The quality of the incoming water must correspond to the drinking water specification of the country in which the washing machine is being operated.

Always connect the washing machine to the drinking water supply.

Cold water connection

For the cold water connection one stopcock each with a $\frac{3}{4}$ " screw thread is required.

If a water connection is not available, only a qualified installer may connect the washing machine to the mains water supply.

The water inlet hose for cold water is not suitable for connection to a hot water supply.

In the event that hot water is not available on site, a cold water supply must be used for the hot water connection.

The required amount of hot water should be added to the cold water volume.

Alternatively, the hot water connection should be blocked using the blind stopper supplied with the machine and the machine controls should be set to cold water intake by the service technician.

Using the machine in cold water mode

For cold water mode, a cold water connection must be established at the cold and hot water valve.

Alternatively, the hot water valve can be deactivated by the technician. The following steps must be performed.

The service technician must deactivate the hot water valve.

- Unscrew the hot water hose.
- Screw on a stopper.

Hot water connection

The same connection requirements as for cold water also apply to hot water up to 60 °C.

A suitable connection hose with a threaded union is supplied with the machine.

The machine with hot water connection also requires a cold water connection.

Using the machine in hot water mode

For hot water mode, connect the hot water and cold water connections to the relevant valves. Both connections are required.

Installation

Drain pump (depending on model)

In machines with drain pump, the suds are drained through a drain pump with a delivery head of max. 1 m.

The drain hose must be installed free of kinks for the suds to drain freely.

There are the following options for draining the machine:

- Drain hose connected to a plastic drain pipe with a rubber sleeve (there is no need to use a siphon)
- Drain hose connected securely to a sink with a plastic nipple
- Connected securely to a floor drain (gully)

If required, the hose can be extended to a length of up to 5 m. The corresponding accessories are available from the Miele Customer Service Department or your Miele dealer.

For a drain height of more than 1 m, a replacement drain pump for a delivery head of max. 1.8 m is available from the Miele Customer Service Department or from your Miele dealer.

Special regulations for Austria

The washing machine can be connected directly to the drain pipe if the sewer system meets the requirements of Austrian standard ÖNORM 2501.

Electrical connection

The electrical connection must only be carried out by a suitably qualified electrician in accordance with local and national regulations such as BS 7671 in the UK.

It is recommended to connect the electrical supply with suitably rated plugs and sockets so that both the washer and dryer are capable of full isolation.

A **residual current device (RCD) type B** (sensitive to universal current) must be used if one is being installed.

The electrical components of the machine comply with EN 60335-1, EN 50571.

The voltage is stated on the data plate.

If the machine is hard-wired, an all pole means of isolation must be provided on site. Switches with a minimum contact gap greater than 3 mm are suitable disconnectors. These include circuit breakers, fuses and contactors (VDE 0660).

The plug connections or disconnectors must be accessible at all times.

If the machine is disconnected from the power supply, the disconnectors must be lockable or the points of disconnection must be monitored at all times.

Preventing hazards

If one of the mains connection cables for this machine is damaged, it must be replaced by the manufacturer, its Customer Service Department or a similarly qualified person to avoid risks.

Observe the enclosed wiring diagram.

Supply air and exhaust air management

Ventilation

The air required for drying is taken from the room where the tumble dryer is installed.

Ensure sufficient room ventilation, e.g. by means of ventilation openings that cannot be closed in the exterior wall.

- It must not be possible to seal off ventilation openings.
- The room ventilation is only working properly if no low pressure occurs. Avoid low pressure, e.g. by means of ventilation openings in the exterior wall.
- For each tumble dryer, there must be a cross section of 339 cm² per ventilation opening.

The tumble dryer draws in air at the back. Therefore, there must be a sufficiently large gap between the back of the machine and the wall.

This would otherwise hinder a sufficient flow of air as well as the operational performance of the tumble dryer.

Observe the necessary spacing between the machine and the wall.

Do not reduce the gap between the bottom of the tumble dryer and the floor (e.g. plinth facings, deep pile carpet).

Exhaust air management

The tumble dryer must only be operated if the humid exhaust air generated during drying is led outside through an installed vent ducting.

Exceptions regarding the design of the exhaust air management system must be designed in accordance with the applicable local building regulations. Seek approval from the relevant building inspector.

The tumble dryer exhaust should be finished with a suitable terminal, we recommend a 90° downward facing elbow.

- While installing the ducting, keep the tumble dryer disconnected from the mains power supply.
- Make sure that the duct connections are fully sealed.
- Only use heat-resistant materials with a temperature resistance of at least 80 °C.
- Condensation will form in the exhaust air management system. A condensate drain must therefore be placed at the lowest point in the system.

The opening of the vent ducting (e.g. a wall pipe) must be arranged in such a way that the humid exhaust air:

- Does not flow back into the room where the tumble dryer is installed.
- Does not cause damage or unacceptable disturbance.

Installation

The air required for drying is taken from the room where the dryer is installed. You must therefore ensure that the room is sufficiently ventilated. Otherwise, there is a risk of suffocation due to exhaust gases being sucked back from other technical systems or fuel-burning installations, and the drying time will be much longer.

The following should be avoided:

- Long vent ducting
 - Too many tight bends or elbows
- This will help to stop a reduced dryer performance and excessive time and energy requirements.

Use:

- For the vent ducting: exhaust hose* or a plastic waste water pipe (e.g. HT piping systems) with a minimum diameter of 100 mm.
- *optional accessories

Calculating the total ducting length

The friction of the vent ducting with its bends and various components provides resistance to the flow of air. This friction resistance is expressed as a relative pipe length. The **relative pipe length** indicates how much greater the resistance of a bend is, for example, when compared to 1 metre of a straight plastic waste water pipe (table I).

Adding together the relative pipe lengths for all of the components gives the **total ducting length**. The total ducting length expresses the resistance of the entire exhaust air system.

As a larger **duct diameter** has a lower flow resistance, a longer duct requires a greater duct diameter (table II).

Procedure

1. Measure the length needed for the straight sections of ducting. Multiply this value by the corresponding relative pipe length from **table I**.
2. Calculate the number of bends and components needed. Use **Table I** to help you add together their relative pipe lengths.
3. Add together all of the relative pipe lengths calculated above in order to calculate the total ducting length.
4. Refer to **Table II** for the pipe diameter needed for the total ducting length.

Table I	
Components	Relative pipe length
Exhaust air hose (flexible aluminium)* / pipe (temperature resistance min. 80 °C)	
– 1 m laid straight or 1 m straight pipe	1.0 m
– 45° bend (radius of bend = 0.25 m)	0.6 m
– 90° bend (radius of bend = 0.25 m)	0.8 m
Non-return flap*	14.3 m
* optional accessories	

Table II	
Maximum permissible total ducting length	Required diameter
20 m	100 mm
40 m	125 mm
80 m	150 mm

Sample calculation

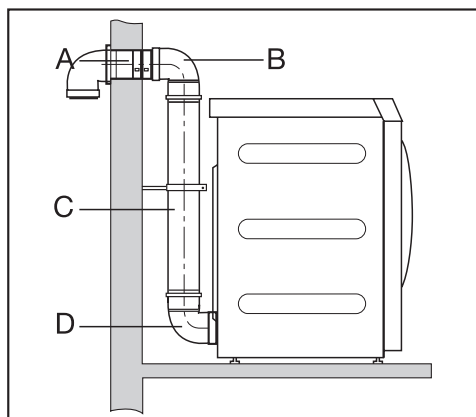

A	1 bend, 90° = 1 x 0.8 m relative pipe length	= 0.8 m
B/D	2 bends, 90° = 2 x 0.8 m relative pipe length	= 1.6 m
C	0.5 m pipe = 0.5 x 1 m relative pipe length	= 0.5 m
Total ducting length		= 2.9 m

Result: the total ducting length is less than 20 m (as per Table II). A pipe diameter of 100 mm will therefore suffice.

Exhaust duct dimensions

View from above

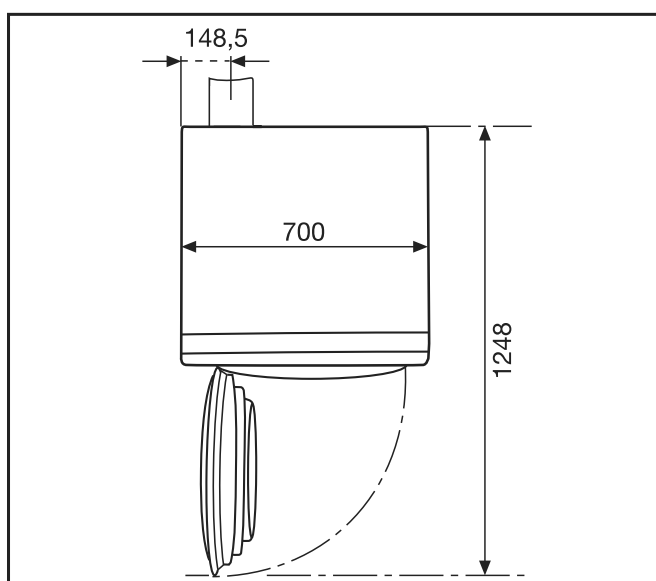

Rear view

Installation

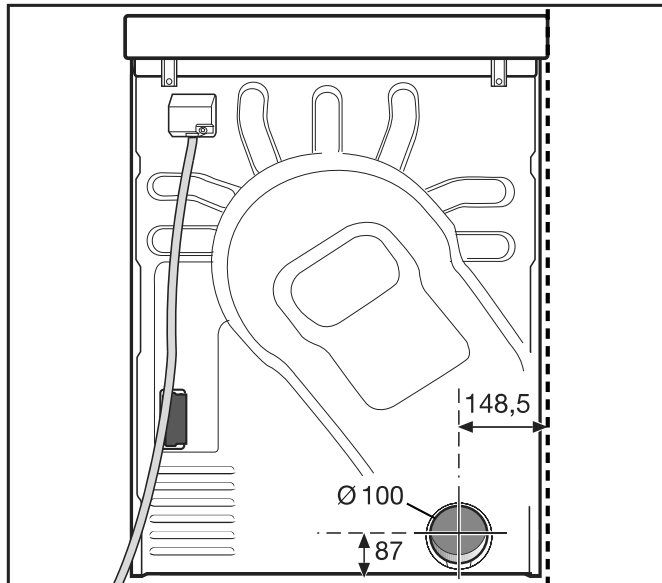

Exhaust air management with plug-in pipes

You will need

- the connector (supplied).
- pipes and connecting pieces from a suitable retailer.

Only use heat-resistant materials with a temperature resistance of at least 80 °C.

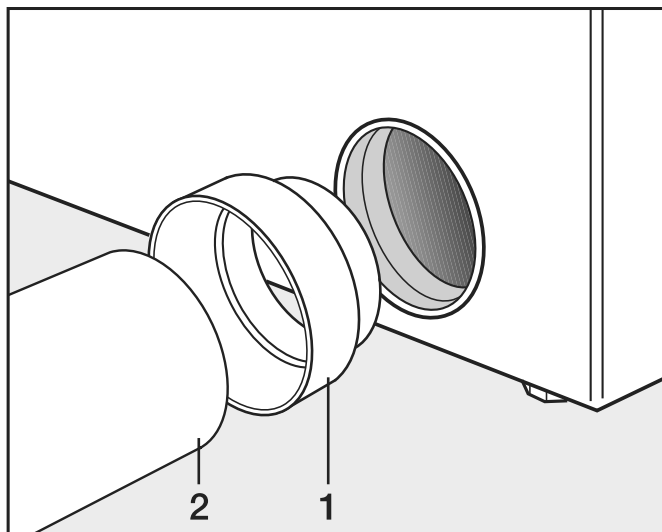

- Install the connector (1) and the pipe (2).

⚠ Wrap heat-resistant metallic tape around plug connections.

Exhaust air management with flexible aluminium hose

You will need

- the adapter (supplied).
- Flexible aluminium exhaust air hose (optional accessory).

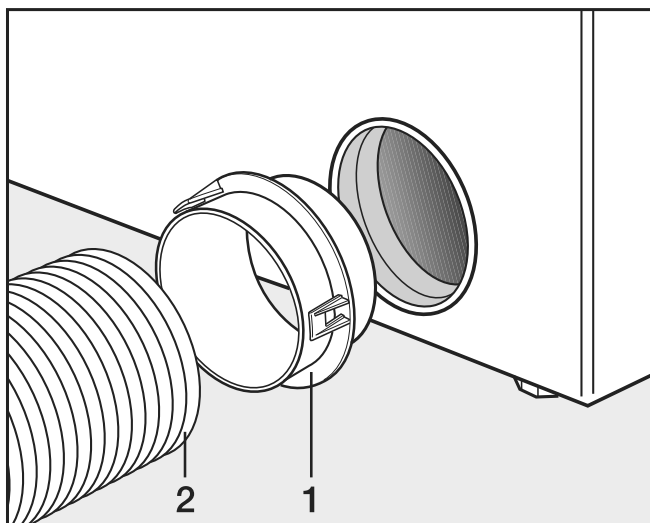

- Install the adapter (1) and the flexible aluminium exhaust air hose (2).



Wrap heat-resistant metallic tape around plug connections.

Shared exhaust air ducts

A shared exhaust air duct is only permitted in exceptional cases. The shared exhaust air duct must be approved by the relevant building inspector.



A non-return flap must be installed for each tumble dryer. Otherwise, the tumble dryers may be damaged by a backflow of condensation and their electrical safety could be affected.

If 3–5 tumble dryers are installed on one shared exhaust air duct, the pipe diameter **D** must be increased.

Number of tumble dryers	Factor for increasing the pipe diameters from Table II
3	1.25
4–5	1.5

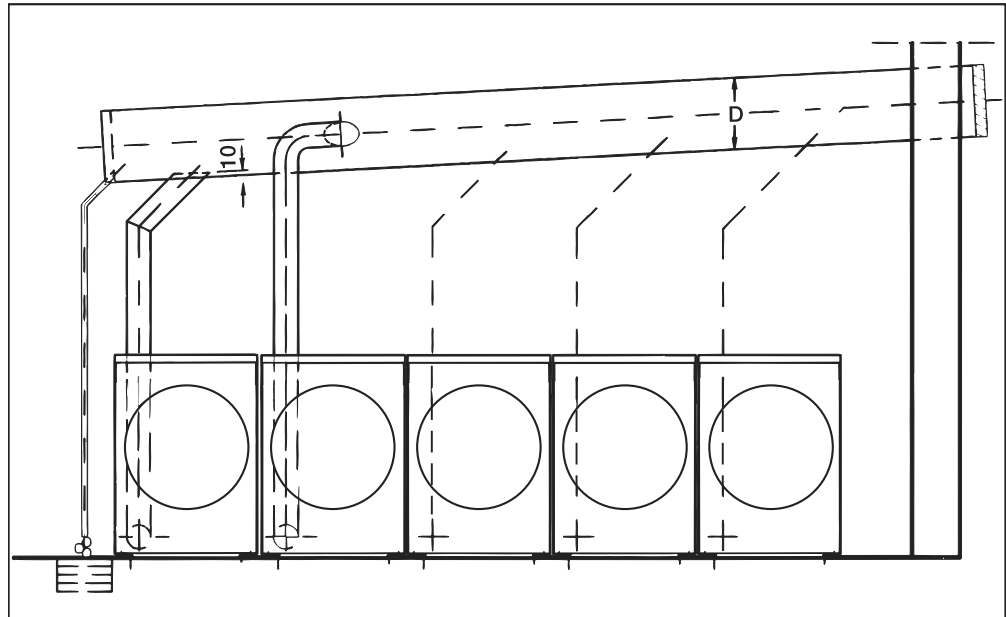

Reference to external machines

A reference to external hardware appears.

- Confirm with the *OK* symbol.

If using a Connector Box, connect it before initial commissioning. The washing machine must be disconnected from the mains to do this. Then start the commissioning process.

Optional accessories

Only use genuine Miele spare parts and accessories with this machine.

Using spare parts or accessories from other manufacturers will invalidate the warranty, and Miele cannot accept liability.

Washing machine accessories

Connector Box

The Connector Box allows external hardware from Miele and other suppliers to be connected to the Miele Professional washing machine. The Connector Box is supplied with mains voltage by the Miele Professional washing machine.

The separately available set consists of the Connector Box and fasteners for installation on the machine or on the wall.

Peak load / energy management

A peak-load or energy management system can be connected via the Connector Box.

The energy management system monitors the energy consumption of a system and deactivates individual pieces of equipment temporarily by means of the peak-load negotiation in order to ensure that certain total load limits are not exceeded.

When the peak-load function is activated, the heating is deactivated and the programme stopped. A message appears in the display to inform you of this.

	<p>The programme is resumed automatically when the peak-load function finishes.</p>
Payment device	<p>The washing machine can be fitted with a single-machine payment system as an optional accessory via the Connector Box.</p> <p>The programming required for connecting a payment system can be carried out during the initial commissioning process. After initial commissioning, changes may only be carried out by your Miele dealer or the Miele Customer Service Department.</p> <div style="border: 1px solid black; padding: 5px;"><p>Please note that the status of the Connector Box must be set to “on” in the supervisor level as required. The payment system settings can be configured at the supervisor level.</p><p>The payment system is not activated via the supervisor level.</p></div>
WiFi/LAN interface	<p>The washing machine is equipped with a WiFi/LAN interface for exchanging data.</p> <p>The data interface provided on the LAN connection complies with SELV (Safety Extra Low Voltage). The LAN connection uses a RJ45 connector in accordance with EIA/TIA 568-B.</p> <div style="border: 1px solid gray; padding: 5px;"><p>Connected machines must also comply with SELV.</p></div>

Installation

Tumble dryer accessories

Communication box

The optional communication box allows external hardware from Miele and other suppliers to be connected to the Miele Professional machine. External hardware includes, e.g. payment system, peak-load system, pressure sensor or an external vent flap.

The communication box is supplied with mains voltage by the Miele Professional machine.

The separately available set consists of the communication box and fasteners for installation on the machine or on the wall.

Payment systems

This tumble dryer can be fitted with a payment system (optional Miele accessory). In this case, a Miele Customer Service technician must programme the relevant settings in the tumble dryer's electronics and connect the payment system.

APCL106

The optional Miele communication module can be used to establish a data connection between a Miele Professional machine and a data processor in accordance with the Ethernet or WiFi standard.

This communication module fits into the communication slot which is a standard feature on all machines. The communication module offers the option of intelligent app-based communication with external systems (such as central smart payment terminals or payment systems). In addition, it can display detailed machine and programme status information.

This module forms the basis for wired communication with Miele MOVE.

It is not possible to integrate the machine into the "Miele@home" app for domestic installations.

The communication module is intended exclusively for commercial use and is supplied with mains voltage directly via the Miele Professional machine. No additional power connection is required. The Ethernet interface provided via the communication module complies with SELV (safety extra low voltage) requirements in accordance with EN 60950. Connected external machines must also comply with SELV.

Opening the supervisor level

- Switch on the washing machine.

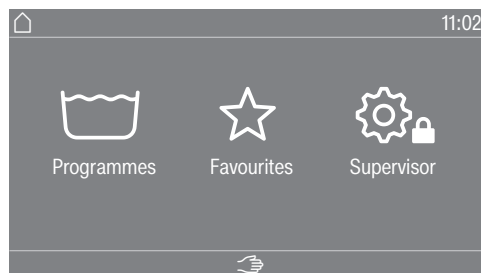

- Touch the Supervisor  sensor control.

The display will change to the Supervisor level menu.

Access via code

The supervisor level is accessed using a code.

The code is **8000** (factory default).

After entering the code, you will be in the supervisor level. The individual setting options are described in the following sections.

Changing the code

You can alter the supervisor level access code to protect the washing machine from unauthorised access.

Please inform the Miele Customer Service Department if you have forgotten your new code. The Customer Service Department will have to reset the code.

Make a note of your new code and store it in a safe place.

Closing the Settings menu

- Touch the  symbol.

The display will then go back to the previous menu level.

- Touch the  symbol.

The display will change to the main menu.

Washing machine supervisor level

Controls / Display

Language

The display contents can be displayed in a variety of languages. To select the permanent supervisor language you want, go to the Languages sub-menu.

When a programme is running, you can change the user language using the  sensor control.

Language entry

The display can be set to one of several different user languages. This setting allows you to determine how languages can be selected.

International

6 languages are available. The  sensor control is not active. Note the setting *Set languages*.

Language selection

The  sensor control can be used to select a language. All languages are available (factory default).

You can change the order of the first 4 languages. These slots are allocated to the most commonly used languages.

Standard language

The user language cannot be changed. The user language is the same as the supervisor language. The  sensor control is not active.

Set languages

The languages for the setting *Language entry International* can be changed.

6 languages can be selected. All languages are available.

If you wish to add a new language to the language menu:

- First select the language you want to replace.

All available languages are displayed.

- Select and confirm the language to replace the previous language.

The new language appears instead of the old one.

Time

After selecting the clock format, you can set the time of day.

Time format

- 24 h clock
- 12 h clock
- No clock

Set

- The time can be set.

Date

The date can be set after selecting the date format.

Date format

- DD.MM.YYYY
- YYYY.MM.DD
- MM.DD.YYYY

Date

- The date can be set.

Washing machine supervisor level

Logo	Different logos can be selected for the user interface.
Start screen	Different views can be selected for the start screen. The start screen is displayed after exiting a sub-menu.
Mode	Different supervisor modes can be selected.
Display brightness	<p>The brightness of the display can be altered. The setting depends on the various lighting conditions in the place of installation.</p> <p>It can be set to one of 10 different levels.</p>
Display off status	<p>In order to save energy, the display can be set to switch to standby mode automatically after the end of the programme or if no further selection is made. In the default setting, the machine will not switch to standby mode automatically.</p> <p>Changing this factory default setting leads to increased energy consumption.</p> <ul style="list-style-type: none">- Off- On (10 min.) Not curr.prog.- Logo (10 min.) Not curr.prog.- On after 10 min.- On (30 min.) Not curr.prog.- Logo (30 min.) Not curr.prog.- On after 30 min.
Appliance off status	<p>In order to save energy, the washing machine can be set to switch to standby mode automatically after the end of the programme or if no further selection is made. In the default setting, the machine will not switch to standby mode automatically.</p> <p>Changing this setting leads to increased energy consumption.</p> <ul style="list-style-type: none">- No switch-off (factory default)- Switch-off after 15 minutes- Switch-off after 20 minutes- Switch-off after 30 minutes
Volume	<p>The volume for various sounds can be changed.</p> <p>It can be set to one of 7 different levels or switched off altogether.</p> <ul style="list-style-type: none">- Finish tone- Keypad tone- Welcome tone- Fault tone <p>The fault tone can be activated or deactivated.</p>
Visibility parameters	<p>Various parameters, such as the temperature, spin speed, Extras, etc., are displayed when a programme is selected. You can decide which parameters should not be displayed. The parameters cannot be changed/are no longer displayed.</p> <p>Factory default: all parameters are visible (marked in orange)</p>

Washing machine supervisor level

Sorting Extras	<p>Under the setting <i>Visibility parameters</i>, <i>Sort Extras</i> appears in the bottom line. Touch the sensor control to change the sequence of Extras (see “Arranging programmes” under “Supervisor level”).</p>
Delay start	<p>The delay start (timer) display can be switched on or off.</p> <p>Factory default: on</p>
Memory	<p>The washing machine will save the settings (temperature, spin speed and some of the options) which have been selected for a wash programme after the programme has started.</p> <p>When the wash programme is chosen again, the saved settings will appear on the washing machine’s display.</p> <p>Factory default: off</p>
Manual control	<p>The manual control function can be switched on or off. Switch-on can be carried out with or without identification.</p>
Change order	<p>The skip function can be switched on or off.</p>
Measuring system	<p>You can choose whether the temperature and weight are displayed in metric or imperial units.</p>
Supervisor code	<p>You can alter the access code to the supervisor level. The supervisor code and the expert code are two separate codes.</p> <ul style="list-style-type: none">■ Enter the current code.■ Enter a new code. <p>When creating a new code, number sequences such as 1234 and four-digit numbers such as 2222 are not permitted.</p>
WiFi	<p>In this menu, you control the networking of your washing machine (see “Networking”).</p>

Programme selection

Controls

Tip: Start by configuring all necessary settings and changes to the washing machine before adjusting any of the options below.

If “Laundrette, basic” or “Laundrette Logo” is selected, the supervisor level can no longer be opened from the display after the *Supervisor level* menu is closed. Please follow the instructions below for special access to the supervisor level if you wish to change any other settings.

Standard (factory default).

All functions and programmes can be displayed.

Laundrette, basic

Up to 24 programmes are available. Go to Favourite programmes to select which programmes are to be listed.

Laundrette logo

Up to 24 programmes are available. Go to Favourite programmes to select which programmes are to be listed.

External programme selection

Programmes are selected using a communication module with Ethernet, e.g. via an external terminal.

Washing machine supervisor level

Programme packages

The selection of programmes can be expanded by activating single programmes from the target group programme packages.

The programmes selected from the programme packages (marked in orange) are displayed during programme selection.

Favourite programmes

After switching on, you can also select a programme via: ☆ Favourites.

24 programmes can be stored as favourites based on your own priorities and requirements.

These favourites will also be made available in the control options

- *Launderette logo*

- *Launderette, basic* control options.

You can specify the control option under *Controls*.

Tip: You can assign a separate coloured frame to each programme. In this case, the “Colour allocation programme setting must be set to *On*.

Changing favourite programmes

- Select the programme you wish to change or replace.

- Confirm the programme or the setting to be changed.

Another menu opens, enabling you to select a new programme or change the parameters.

- Confirm by touching the *Save* selection area.

Your selection is now active.

Sort programmes

Programmes can be moved within the programme list and in the favourites list.

Factory default: off

Moving programmes

- Touch the selection area for the programme you want to move.

- Press and hold the selection area until the frame changes.

- Drag the programme to the required place.

Prog. colour allocation

You can assign a frame to a favourite programme. In the list of favourites, each favourite programme is given a coloured frame, which can be adjusted.

Factory default: on

Expert code

A code has to be entered to cancel a disinfection programme. The code can be modified.

The expert code and the supervisor level code are two separate codes.

The code is: 8 0 0 0

Make a note of your new code if you ever change it.

Process technology

Anti-crease

The Anti-crease function reduces creasing after the end of the programme. At the end of the programme, the drum continues to turn at intervals for up to 30 minutes.

The washing machine door can be opened at any time.

Factory default: on

Washing machine supervisor level

Automatic drainage Automatic water drainage can be switched on or off. Automatic water drainage means that the suds are always drained away after the end of a programme. This is also the case for programmes that reach the programme end with water still in the drum.

Factory default: off

Service

Service interval

Service information can appear in the display. You can configure whether a date or the number of operating hours is displayed.

You can select up to 2 messages with their own text.

Your message is displayed at the end of the programme and can be acknowledged with *OK*. The same message appears at the end of the next programme.

Settings

This setting allows you to determine the interval (by hours or date) at which the message appears.

- Factory default: off
- By time
You can then select a time interval from 1–9999 hours.
- By date
You can then enter a date.

Message text

Enter your message for your planned maintenance work.

Reset display

The message appears until the display is permanently reset. The message then appears again once the next interval is reached.

External applications

Payment system lock

The payment device lock can be switched on or off. When the lock is switched on, the duration until locking can be selected from various time intervals.

Connector box

External hardware is connected via the Connector Box. This can be switched on or off.

The Connector Box must be selected in order for settings to be made in the Dispensing menu.

Automatic dispensing

Automatic dispensing can be switched on or off. Automatic dispensing can be activated via the Connector Box or the COM module.

Dosage

The Connector Box must be switched on in order for settings to be adopted in the Dispensing menu.

1–6 dispensing pumps can be switched on.

Further settings can be made after activating the dispensing pump.

- Deactivate disp. pump
- Calibration

- Flow rate (new): ml/min
- Correction factor
- Container size
- Adv. warning level reminder
- Reset adv. warning
- Level reminder
- Flow meter

Peak load prevention

The peak-load prevention function can be switched on or off. With this function, the execution of a wash programme is not affected when a peak-load signal is in place. The heater stays switched on.

Appliance parameters

Maximum spin speed

The maximum spin speed can be set via a keypad.

Max. possible temperature

The maximum temperature can be set via a keypad.

Legal information

[Open source licences](#)

You can view information here (see WiFi data protection).

Tumble dryer supervisor level

Opening the Supervisor level

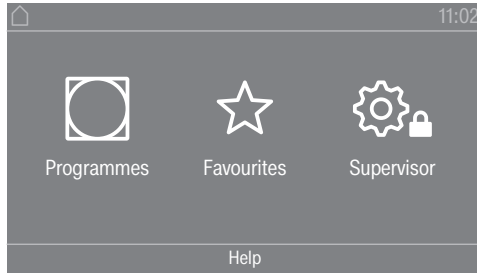

Touching the  sensor control takes you to the Supervisor level.

Access via code

Supervisor level is accessed using a code.

Factory default: The code is **000**.

Change code

You can alter the Supervisor level access code to protect the dryer from unauthorised access.

Be careful when entering a new code.
You will need to inform Miele Service if you forget your new code.
Miele Service will have to reset the code.
Make a note of your new code and store it in a safe place.

Closing the settings menu

- Touch the  sensor.

The display will then go back to the previous menu level.

- Touch the  sensor.

The display will change to the main menu.

Controls / Display

Language

The display can be set to appear in one of several different languages. To select the language you want, go to the *Languages* sub-menu.

You can change the language as follows:

- Permanently using the supervisor level (= "Supervisor language").
- For the duration of the current programme only using the  sensor control. The supervisor language is displayed again at the end of the programme.

Language entry

The display can be set to one of several different user languages. This setting allows you to determine how languages can be selected.

You can change the language as follows:

International

6 languages are available. The  sensor control is not active. Note the setting *Set languages*.

Language setting

The  sensor control can be used to select a language. All languages are available (factory default).

You can change the order of the first 4 languages. These slots are allocated to the most commonly used languages.

Standard language

The user language cannot be changed. The user language is the same as the supervisor language. The  sensor control is not active.

Set languages

The languages for the International lang. entry setting can be changed.

Six languages can be selected. All languages are available.

If you wish to add a new language to the language menu:

Six languages can be selected. All languages are available.

If you wish to add a new language to the language menu:

- First select the language you want to replace.

All available languages are displayed.

- Select and confirm the language to replace the previous language.

The new language appears instead of the old one.

Display brightness

The brightness of the display can be altered. The setting depends on the various lighting conditions in the place of installation.

- It can be set to one of 10 different levels.

Clock display

After selecting the clock format, you can set the time of day.

Clock format

- Factory default: 24-hour display

- 12-hour display

- No clock

Set

- The time can be set.

Date

The date can be set after selecting the date format.

- Date format

The date can be shown starting with the day, month or year.

- Date

The date is set.

Volume

The volume for various sounds can be changed.

The volume can be changed for the following tones:

- Finish tone

The finish tone signals the end of the drying programme.

- Keypad tone

- Welcome tone

- Fault alarm

The fault tone signals a fault and can be switched off. The volume of the fault tone cannot be adjusted.

Tumble dryer supervisor level

Res. moisture display

In addition to displaying the drying level, the residual moisture can also be indicated as a percentage.

- Factory default: Without % value
- With % value

Visibility parameters

Various parameters are offered/displayed when a programme is selected. You can decide which parameters should not be displayed. These parameters can then not be edited during programme selection.

- Residual moisture
- Duration
- Low temperature
- Anti-crease
- Load size
- Drying temperature

Display off status

The display switches off to save energy; only the *Start/Stop* sensor flashes slowly. You can change this setting.

Changing this setting leads to increased energy consumption.

- Off
No switching off
- On (10 min.) Not curr.prog.
The display will remain on during the programme sequence but will go out 10 minutes after the end of the programme.
- Logo (10 min.) Not curr.prog.
The display will remain on during the programme sequence but the logo will light up 10 minutes after the end of the programme.
- Factory default: On after 10 min.
The display is switched off after 10 minutes.
- On (30 min.) Not curr.prog.
The display will remain on during the programme sequence but will go out 30 minutes after the end of the programme.
- Logo (30 min.) Not curr.prog.
The display will remain on during the programme sequence but the logo will light up 30 minutes after the end of the programme.
- On after 30 min.
The display will go out after 30 minutes.

Machine off status

In order to save energy, the tumble dryer will switch off automatically after the end of the programme or if no further selection is made. You can change this setting.

Changing this setting leads to increased energy consumption.

- No switch off
- Factory default: Switch off after 15 minutes
- Switch off after 20 minutes
- Switch off after 30 minutes

Tumble dryer supervisor level

Delay start The delay start (timer) can be activated or deactivated.

- Factory default: Off
- On

Memory The tumble dryer saves the settings that were last selected for a drying programme (drying stage and/or extra option, or the duration for some programmes).

- Factory default: Off
- On

Temperature unit You can select the unit for the temperature display.

- Factory default: °C
- °F

Weight unit You can decide whether load quantities are displayed in “kg” or “lbs”.

- Factory default: kg
- lb

Change code You can alter the access code to the Supervisor level.

- Enter the current code.
- Enter a new code.

Programme selection

Controls You can select whether the tumble dryer is operated as a “laundrette” machine. Shortcuts are the easiest way to operate the machine. Operating staff are unable to change pre-set programmes.

Tip: Start by configuring all necessary settings and changes to the tumble dryer before adjusting any of the options below.

Caution: When activating any of these options, the Supervisor level will no longer be available. You will no longer be able to access the Supervisor level via the display. Please follow the instructions below if you wish to change any other settings.

Opening the Supervisor level (laundrette version)

- Switch the tumble dryer on and open the dryer door.
- ① Touch the *Start/Stop* sensor and hold it down whilst carrying out steps ②-③.
- ② Close the dryer door.
- ③ Wait until the *Start/Stop* sensor, which will now be flashing quickly, lights up constantly ...
- ④ ... and then release the *Start/Stop* sensor.
- Standard
 - Factory default: all (selected) programmes are available.
- Laundrette, basic
 - 12 programmes are available.

Tumble dryer supervisor level

Under Favourite programmes, you can set which of the 12 programmes to select or modify.

- Laundrette Logo

12 programmes are available.

Under Favourite programmes, you can set which 12 programmes to select/modify.

- Laundrette Logo ext. time

4 timed drying programmes* with different temperature levels are time-controlled via an external payment system.

The set value indicates the programme running time and cannot be modified by the user.

* The maximum programme running time is specified during initial commissioning.

- Laundrette Logo int. time

4 timed drying programmes* with different temperature levels are time-controlled via the tumble dryer electronic module.

The set value indicates the maximum programme running time and can be modified by the user.

* The maximum programme running time is specified during initial commissioning.

- External prog. selection

A communication module can be used to select the programme from an external terminal.

Programme packages

This allows you to specify the scope of the tumble dryer programme. You can select all of the programmes or individual programmes from the relevant programme packages.

The tumble dryer's additional scope of programmes can be configured. The programmes are listed under "Programme chart".

Favourite programmes

After switching on, you can also select a programme via: ☆ Favourites.

12 programmes can be stored as favourites based on your own priorities and requirements.

These favourites will also be made available in the control options

- *Launderette ext. (12 prog)*
- *Launderette, basic (4 prog)* (the first 4 of the 12 favourites).

You can specify the control option under Controls.

Tip: You can assign a different colour to each programme. In this case, the Prog. colour allocation setting must be set to *On*.

Changing Favourite programmes

- Select the programme you wish to change or replace.
- Confirm the programme or the setting to be changed.

Another menu opens, enabling you to select a new programme or change the parameters.

Special programmes

- Confirm with the **Save sensor control**.

Your selection is now active.

You can put together 5 special residual moisture or time-controlled programmes and assign your own programme names.

First, enter the programme name.

- Select the special programme you want to change.

The **Save as** menu opens.

- Use the letters and symbols below the line to enter the name.
- Touch the **Save sensor control**.

You can now enter the parameters for a **Res. moisture programme** or **Timed drying**.

The 5 special programmes are pre-programmed at the factory. You can change these special programmes.

The special programmes are added to the programme packages. Enter the name and settings of your special programme into the “Special programmes” table in the “Programme overview” chapter.

Res. moisture programme:

- Final residual moisture:
6 % (dry) – 40 % (damp)
- Extra drying time:
0–60 minutes
- Temperature (Process air):
cold – 75 °C
- Cooling down temperature (Process air):
40–55 °C
 - Drum rotation, main direction:
20–600 seconds
 - Pause:
2–15 seconds
 - Drum reversal:
20–600 seconds
- Anti-crease
 - Drum rotation, main direction:
0–500 seconds
 - Pause:
100–3000 seconds
 - Drum reversal:
0–500 seconds

Timed drying:

- Running time:
5–180 minutes
- Temperature (Process air):
cold – 75 °C

Tumble dryer supervisor level

- Cooling down temperature (Process air):
40–55 °C
 - Drum rotation, main direction:
20–600 seconds
 - Pause:
2–15 seconds
 - Drum reversal:
20–600 seconds
- Anti-crease
 - Drum rotation, main direction:
0–500 seconds
 - Drum reversal:
0–500 seconds
 - Pause:
100–300 seconds

Sort programmes

Programmes can be moved within the programme list and in the Favourites list.

- Factory default: Off
- On

Moving programmes/favourites

You can move/change the order of the programmes (programme menu – single option list). You can also move and change the order of the favourites that you edit in the *Supervisor level* under *Favourite programmes*.

- Touch the programme that you wish to move.
- Press and hold the sensor until the frame changes.
- Drag the programme to the required place.

Prog. colour allocation

You can assign a specific colour to a favourite programme. In the list of favourites, each favourite programme is given a coloured frame, which can be adjusted.

- Factory default: Off
- On

Process technology

Anti-crease

At the end of the programme, the drum will continue to rotate at intervals if the laundry is not removed immediately.

Changing this setting leads to increased energy consumption.

The setting for Anti-crease (🌀) can either be switched off or a time between 1 and 12 hours can be selected.

Factory default: 2 hours

Drying levels

Changing this setting leads to increased energy consumption.

You can alter the drying levels for the Cottons, Minimum iron and Automatic plus programmes.

Drying levels Cottons, Minimum iron and Automatic plus can be set to one of 7 different levels.

Factory default: normal

The residual moisture in drying level Machine iron can be set in 11 levels from 16 % (dryer) to 26 % (damper).

Factory default: 20 %

Further cooling

If extended cooling is activated, the drum temperature is checked approx. 1 minute before the machine goes into standby mode at the end of the programme. If the temperature is above 55 °C, the dryer will carry out cooling until it is below 55 °C.

Changing this setting leads to increased energy consumption.

- Factory default: off

- On

Cooling down temperature

The laundry will be cooled down automatically after the end of the programme. The automatic cooling phase can be set at a cooler level for all programmes. This means that the cooling phase is extended.

Changing this setting leads to increased energy consumption.

The setting can be changed from 40 °C–55 °C.

Factory default: 55 °C

Fan pulsed operation

The fan operates intermittently to release laundry that is stuck in front of the inner drum door. With heat-pump dryers, the fan function operates intermittently to dry duvets.

The fan is switched on and off at certain intervals.

Deact. pulsed operation

Pulsed delay after start

Fan down time

Reversing cycle

Service

Clean out the airways

The tumble dryer's electronic module calculates the degree to which fluff or detergent residues in the fluff filters and vent ducting are impairing performance. A message to check the contamination appears. You can decide at what level of fluff this reminder should be emitted.

If the message appears on the display even though the fluff filter is clean, the vent ducting is regarded as borderline. Miele recommends improving the vent ducting. Poor vent ducting will result in longer programme running times and greater energy consumption.

This reminder, which you can configure, is displayed: Clean out the airways

- Off

The reminder does not appear. However, if there is a very severe blockage in the ducting, the programme will be cancelled regardless of this option.

Tumble dryer supervisor level

- Heavy
The reminder only appears when there is a heavy build-up of fluff.
- Factory default: normal
- Light
The reminder appears when there is only a small build-up of fluff.

Clean the filters

The fluff filter in the air duct area must be cleaned on a regular basis. You can set an hourly interval for the reminder.

The selected hourly interval depends on how much fluff tends to build up and how often you wish to clean the filter, e.g. for hygiene purposes.

You can adjust this reminder: Clean the filters

- Time interval of 5–55 hours
- Factory default: after 55 hours
- Off

Service interval

The tumble dryer shows a custom message at a selected interval to prompt you to undertake specific maintenance tasks.

Three different messages can be created: 1/2/3. Each message is created in the language and alphabet of the current supervisor language. Your message is displayed at the end of the programme and can be acknowledged with OK. The same message appears at the end of the next programme.

Settings

This setting allows you to determine the interval (by hours or date) at which the message appears.

- Factory default: Off
- By time
You can then select a time interval from 1–9999 hours.
- By date
You can enter a date.

Message text

Enter your message for your planned maintenance work. You can edit one, two or all three of the 1/2/3 messages.

Reset display

The message appears until the display is permanently reset. The message then appears again once the next interval is reached.

External applications

External exhaust flap

External hardware is connected via the Miele Connector Box.

The time delay between the external exhaust air flap's activation point and the switch-on time for the drum/fan motor is regulated.

A message appears in the display while the exhaust air flap is open.

- Factory default: off

This option must always be selected if there is no exhaust air flap to activate. This prevents the programme from being cancelled.

- On (1 second to 5 minutes)

Additional fan

External hardware is connected via the Miele Connector Box.

The additional fan is switched on by the dryer (via Connector Box) in parallel with the internal fan.

- Off

- On

Pressure sensor

External hardware is connected via the Miele Connector Box.

When using a shared exhaust air duct, one tumble dryer may have to be switched off or suppressed from the outset if certain pressure levels have built up in the ducting. The external pressure sensor is only checked if the external exhaust air flap and/or the external additional fan is set to "on".

A message appears in the display while the exhaust air flap is open.

- Off = Not active

- Normally open contact = Active
Responds to **high potential**

- Norm. closed contact = Active
Responds to **low potential**

Peak load signal

External hardware is connected via the Miele Connector Box.

The peak-load negotiation function enables the tumble dryer to be connected to an energy management system. When a signal is registered, the tumble dryer's heater is switched off for a short period or the machine is prevented from being switched on. A peak-load signal can be issued via the Connector Box or via the COM module.

- Factory default: No function

- Peak load with 230 V

- Peak load with 0 V

- COM module

Peak load prevention

With this function, the application of a hygiene programme is not amended when a peak load signal is in place. The heater stays switched on.

- Factory default: Off

Tumble dryer supervisor level

	<ul style="list-style-type: none">- On
COM module selection	<div style="border: 1px solid black; padding: 5px;"><p>This tumble dryer is equipped with an integrated WiFi module. However, the dryer can also be equipped with an external module.</p></div> <ul style="list-style-type: none">- Factory default:<ul style="list-style-type: none">Off- Internal module The internal WiFi module is used.- External module An XKM module is inserted into the module slot.
Availability of Miele digital products	<p>The ability of Miele digital products depends on the availability of the services in your country.</p> <p>The different services are not available in all countries.</p> <p>For information about availability, please visit www.miele.com.</p>
WiFi / LAN	<div style="border: 1px solid black; padding: 5px;"><p>Control the networking of your tumble dryer.</p><p>Networking of the tumble dryer for use with the digital Professional tools is only possible with the external module. The internal module can only be used by the Miele Customer Service Department.</p></div> <ul style="list-style-type: none">- Deactivate (visible when the network is activated) The network remains set up; the WiFi function is switched off.- Activate (visible when the network is deactivated) The WiFi function is reactivated.- Connection status (visible when the network is activated) The following values are displayed:<ul style="list-style-type: none">– the quality of WiFi reception– the network name– the IP address- Set up again (visible when set up) Resets the WiFi login (network) to immediately re-establish a new connection.- Reset (visible when set up) The network is no longer set up. A new connection has to be established in order to use the network again.<ul style="list-style-type: none">– The WiFi is switched off.– The WiFi connection will be reset to the factory default setting.
Network time	<div style="border: 1px solid black; padding: 5px;"><p>The date and time can be synchronised over the network.</p></div> <ul style="list-style-type: none">- Off The date and time are not synchronised over the network.- As master The machines are in a network but are not connected to the Internet. A machine is declared as the master and sends data to the <i>slave</i> devices.- As slave

Tumble dryer supervisor level

The machines are in a network and are connected to the Internet. All machines are configured as *slaves*. Data is synchronised over the Internet.

Remote

External programme selection is possible via an external terminal (programme may only be started on the machine). However, programmes may also be selected and started on the machine.

Factory default: on

Remote update

The RemoteUpdate function is used for updating the software in your tumble dryer.

RemoteUpdate is activated by default.

If you do not install a RemoteUpdate, you can continue to use your tumble dryer in the usual way. However, Miele recommends installing RemoteUpdates.

Miele's RemoteUpdate function can only be used if the tumble dryer is connected to a WiFi/LAN network and you have an account in the Miele Professional app. The tumble dryer must be registered in the app.

See the Miele Professional app for terms of use.

If a RemoteUpdate is available for your washing machine, it will be displayed automatically when the Operator level is open.

You can choose to start the RemoteUpdate immediately or wait until later. If you select "Start later", the prompt to run the RemoteUpdate will be displayed again the next time you switch on your washing machine.

The RemoteUpdate can take a few minutes.

Please note the following information about the RemoteUpdate function:

- You will only receive a message when a RemoteUpdate is available.
- Once a RemoteUpdate has been installed, it cannot be undone.
- Do not switch off the tumble dryer during a RemoteUpdate. Otherwise, the RemoteUpdate will be aborted and will not be installed.

SmartGrid

The SmartGrid setting is only visible if a WiFi network has been set up and activated. This function can be used for starting your Miele Professional machine automatically at a time when your energy supplier's electricity tariffs are most economical.

Activating SmartGrid gives the Timer sensor control a new function. Use the Timer sensor control to set SmartStart. The tumble dryer will then start within the timeframe specified when it receives a signal from the energy supplier. If it has not received a signal from the energy supplier by the latest start time set, the tumble dryer will start automatically.

Factory default: off

Tumble dryer supervisor level

Machine parameters

Legal information

Open source licences

Copyright and licences

You can view information here.

For the purpose of operating and controlling the machine, Miele uses proprietary or third-party software that is not covered by open source licensing conditions. This software/these software components are protected by copyright. The copyrights held by Miele and third parties must be respected.

Furthermore, this machine contains software components which are distributed under open source licensing conditions. You can access these open source components along with the corresponding copyright notices, copies of the licensing conditions valid at the time and any further information. This information can be found under the menu option Settings/ Machine parameters/Legal information/Open source licences. The liability and warranty arrangements for the open source licences displayed in this location only apply in relation to the respective rights holders.

Payment system

The Miele communication box accessory unit or the COM module is required to connect a payment device.

Setting for payment systems

If you wish to change the settings after the commissioning process, please contact Miele Service.

- No payment system

The next settings are skipped.

- Programme control

The machine is operated using a coin box. The user purchases a programme.

- Timed operation

The tumble dryer is coin-operated using a time meter. The user purchases a time-controlled programme.

- Timed op. + impul.counter

For payment devices where the usage time is increased each time a coin is inserted.

- COM module

Operation is IP-based.

Pairing instructions

Follow the steps below to connect the washing machine to your network.

Network connection

Miele Professional washing machines can be integrated into local networks to utilise Miele's digital solutions or communicate with external systems. The washing machines are equipped with an integrated WiFi module for this purpose. In addition, the washing machines each have an Ethernet connection at the rear for setting up wired interfaces.

⚠ Unauthorised access poses a health risk.

Settings in the washing machine, e.g. parameters for disinfection or the dispensing of process chemicals, may be changed as a result of unauthorised access via the network. Under no circumstances should it be possible to access the washing machine via the Internet or other public or unsecured networks, either directly or indirectly (e.g. using port forwarding).

1. The washing machine should be operated only in a separate network segment which meets one of the following requirements:
 - It is physically separated from other network segments
 - Access to the segment is restricted by a firewall or a router which has been configured accordingly
2. Limit access to this separate network segment to persons requiring access in the course of their work.
3. Use strong passwords to protect access to systems that are connected to the washing machine.
4. Configure the Ethernet interface.

Opening the supervisor level

- Select the Supervisor menu option in the appliance display.
- Select the Access via code menu option.
- Enter the 4-digit supervisor code.

Initial network setup

- Select the External applications menu option from the Supervisor level menu.
- Select WiFi / LAN.

The options in the WiFi / LAN menu vary depending on whether the WiFi interface is already set up or needs to be set up.

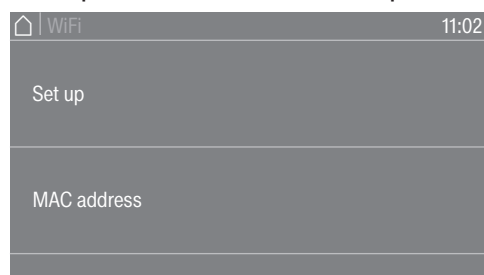

- Select Set up to connect the machine to a network.

The message Set up only appears if the washing machine has not yet been connected to a WiFi network. Various options are available for setting up the WiFi interface.

Connectivity

- Select MAC address to read out the MAC addresses of the network adapters.

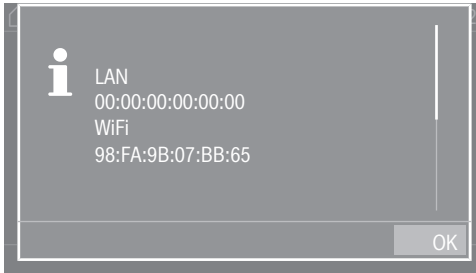

The MAC address of the network adapters is displayed. No settings can be made.

Setting up a network connection manually

- Select the External applications menu option from the Supervisor level menu.
- Then select the WiFi / LAN menu option.
- Select Set up.
- Select the Manual connection method.

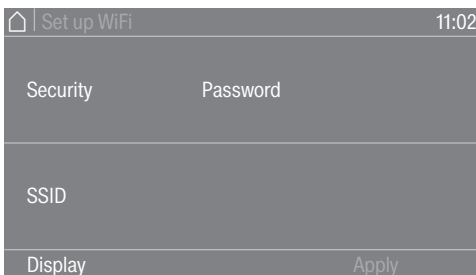
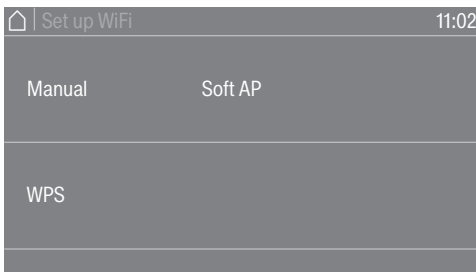

- Select Security to set the security standard for the wireless connection.
- Select Password to enter the WiFi password.
- Select SSID to enter the network name (SSID).

You can view all settings for Security, Password and SSID under Display.

- Save all settings with Apply.

Establishing the network connection via WPS

- Select the External applications menu option from the Supervisor level menu.
- Then select the WiFi / LAN menu option.
- Select Set up.
- Select the Via WPS connection method.
- Now press the WPS button on your router and confirm with OK in the appliance display.

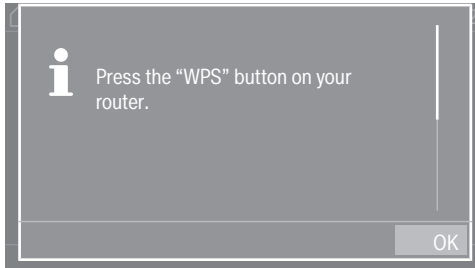

A timer starts. The network connection via WPS is being established.

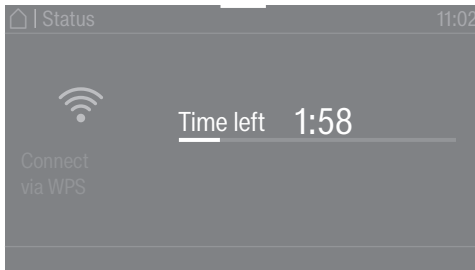

The appliance is now successfully connected.

- Touch OK to confirm.

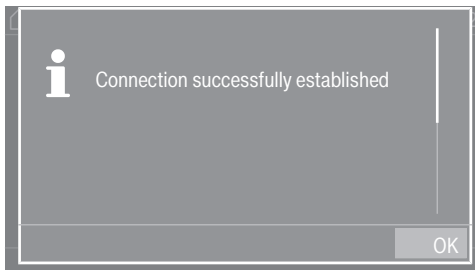

Connectivity

Establishing the network connection via soft AP

- Select the External applications menu option from the Supervisor level menu.
- Then select the WiFi / LAN menu option.
- Select Set up.
- Select the Via Soft AP connection method.
- Confirm by pressing OK and follow the instructions in the external application.

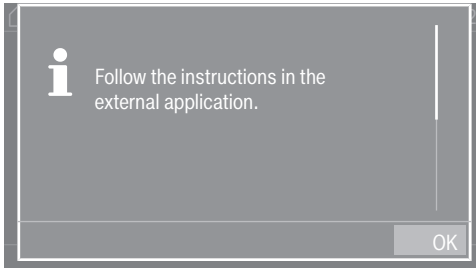

The display shows the message *Waiting for connection for approx. 10 minutes*. If the connection is successful, a message is then displayed. If the connection has failed, the message *Connection failed* is displayed.

- If the connection fails, confirm with OK and start a new connection attempt.

Establishing the network connection using a LAN cable

- Connect the appliance to your router/switch using the network cable.

The appliance is now successfully connected.

WiFi/LAN interface configured

Once the network connection has been successfully set up, you can select further options in the menu.

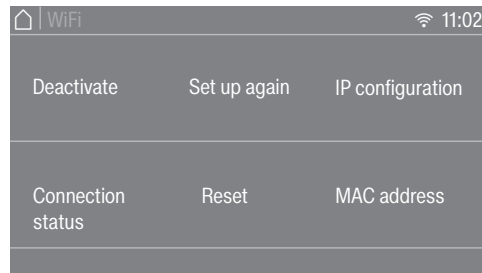

- The WiFi function is switched off with Deactivate (visible when the network is activated). The network remains set up.
- The WiFi function is reactivated with Activate (visible when the network is deactivated).
- All network parameters are displayed under Connection status.
- You can set up the WiFi interface again under Set up again.
- Use Reset to disconnect the network setup. The WiFi function is deactivated and the WiFi connection will be reset to the factory default. A new connection has to be established in order to use the network again.
- You can configure the IP settings manually under IP configuration. The interface can be set up via a Dynamic Host Configuration Protocol (DHCP). If you deactivate the DHCP setting, you can configure the interface using the following parameters:
 - IP address
 - Subnet mask
 - Gateway
 - DNS Auto
 - DNS server 1
 - DNS server 2
- The address of the network adapters is displayed under MAC address.

Technical data

System requirements for WiFi

- WiFi 802.11b/g/n
- 2.4 GHz band
- WPA/WPA2 encryption
- DHCP activated
- Multicast DNS / Bonjour / IGMP snooping activated
- Ports 443, 80, 53 and 5353 open
- IP DNS server = IP standard gateway/router
- Mesh/repeater use: same SSID and password as standard gateway/router
- SSID must be permanently visible

System requirements for LAN



- DHCP activated
- Multicast DNS / Bonjour / IGMP snooping activated
- Ports 443, 80, 53 and 5353 open
- IP DNS server = IP standard gateway/router

Connectivity

WiFi signal strength – Guide values

The WiFi signal strength is only a rough guide. These details do not provide absolute certainty.

The WiFi signal strength can be read directly on the machine.

WiFi signal strength		Meaning
	 *	
76–100 %	3/3**	Generally, reliable operation possible
51–75 %	2/3	
26–50 %	1/3	Generally, operation possible
1–25 %	0/3	Generally, reliable operation not possible
0 %		Operation not possible

* Displayed on the machine

** Number of bars  3/3–0/3

The signal strength can be adversely affected by many factors, including:

- People in the room
- Open or closed doors
- Moved objects
- Varying radio signal sources or interference
- Other equipment with Bluetooth or WiFi wireless technology

PDW 909 machine data

Electrical connection

Supply voltage	See data plate
Frequency	See data plate
Power rating	See data plate
Current consumption	See data plate
Fuse rating	See data plate
Heater rating	See data plate

Installation dimensions

Casing width (without add-on components)	692 mm
Casing height (without add-on components)	1940 mm
Casing depth (without add-on components)	761 mm
Overall machine width	692 mm
Overall machine height	1942 mm
Overall machine depth	851 mm
Minimum width of transport opening	800 mm
Minimum safety distance between wall and back of machine	400 mm
Diameter of door opening	370 mm
Door opening angle	180°

Weight and floor load

Net weight	see installation plan
Max. floor load in operation	see installation plan

Plumbing

Cold water connection

Required flow pressure	100 - 1000 kPa (1 - 10 bar)
Maximum flow rate	10 l/min
Threaded union required (male thread, to be provided by customer in accordance with DIN 44991, flat sealing)	3/4"
Length of water inlet hose included in scope of supply	2000 mm

Hot water connection

Maximum permissible hot water temperature	60 °C
Required flow pressure	100 - 1000 kPa (1 - 10 bar)
Maximum flow rate	10 l/min
Threaded union required (male thread, in accordance with DIN 44991, flat sealing)	3/4"
Length of water inlet hose supplied	2000 mm

Drainage (DP)

Maximum waste water temperature	95 °C
Drain connection (on machine)	External diameter 22 (DN 22)
Maximum drainage rate	26 l/min

Air intake

Recommended free air intake cross-section into the room: (equivalent to 3 times the exhaust air cross-section of an appliance).	237 cm ²
--	---------------------

There must be sufficient air intake to the installation site to match the air outlet volume.

Technical data

Vented system

Maximum nominal volume flow rate	320 m ³ /h
Maximum permitted pressure loss	420 Pa
Connector on machine side (external diameter)	100 mm
Connection pipe provided on site (internal diameter)	100 mm
Maximum exhaust air temperature	80 °C

As relative humidity inside the exhaust ducting can be as high as 100 %, suitable measures must be taken to prevent a backflow of condensate into the appliance.

Emission values

Emission sound pressure level in workplace in accordance with EN ISO 11204/11203	< 70 dB(A) re 20 µPa
Sound power level, EN ISO 9614-2	< 80 dB(A)

Product safety

Product safety standard	EN 60335-1, EN 50571, IEC 60335-1, IEC 60335-2-7
-------------------------	--

WiFi

Frequency range of the WiFi module	2.400–2.4835 GHz
Maximum transmission power of the WiFi module	< 100 mW

Miele hereby declares that this washing machine complies with UK Radio Equipment Regulations 2017, as amended.

The complete text of the UK declaration of conformity is available from one of the following internet addresses:

- Products, Downloads from www.miele.co.uk
- For service, information, operating instructions etc: go to www.miele.co.uk and enter the name of the product or the serial number

This **Statement of Compliance** confirms this Miele product fully complies with the **Product Security and Telecommunications Infrastructure (Security Requirements for Relevant Connectable Products) Regulations 2023**.

- 1) Professional Appliance – *Wash-dryer combination, commercial PW015*
- 2) Manufactured by: Miele & Cie KG,
Carl Miele Street 29, 33332 Gutersloh Germany
Imported by and contact point: Miele Company Ltd, Fairacres, Marcham Road,
Abingdon, Oxon, OX14 ITW Great Britain
- 3) The defined support period at the time of first supply is 10 years
- 4) To report vulnerabilities and cybersecurity issues please contact: psirt@miele.com
- 5) Signature 
Name: **Paul Wright**
Company Position: **Head of Technical Management**
Date of signature: **19th March 2024**
Place of signature: **Abingdon, Oxfordshire**

EU declaration of conformity

Miele hereby declares that this washer-dryer stack complies with Directive 2014/53/EU. The complete text of the EU declaration of conformity is available from one of the following Internet addresses:

- Under “Products”, “Download” at www.miele.de/professional/index.htm
- Or go to <http://www.miele.de/professional/gebrauchsanweisungen-177.htm> and enter the name of the product or the serial number

Data protection and data security

When you activate the networking function and connect your machine to the Internet, your machine sends the following data to the Miele Cloud:

- Machine serial number
- Machine model and technical features
- Machine status
- Information about the software status of your machine

Initially, this data cannot be assigned to a specific user and is not saved permanently. Data cannot be saved permanently or assigned to a specific user until after you have linked your machine to a user. Data transmission and processing are governed by Miele's strict security standards.

Factory default settings for network configuration

You can reset all of the settings on the communication module or your integrated WiFi module to the factory default settings. The network configuration should be reset whenever a machine is being disposed of or sold, or if a used machine is being put into operation. This is the only way to ensure that all personal data has been removed and the previous owner will no longer be able to access the machine.

Copyright and licences

For the purpose of operating and controlling the communication module, Miele uses proprietary or third-party software that is not covered by open source licensing terms. This software/these software components are protected by copyright. The copyrights held by Miele and third parties must be respected.

Furthermore, this communication module contains software components which are distributed under open source licensing terms. The open source components contained in the machine along with the corresponding copyright notices, copies of the licensing terms valid at the time and any further information can be accessed locally by IP using a web browser (*https://<IP address>/Licenses*). The liability and warranty arrangements for the open source licences displayed in this location only apply in relation to the respective rights holders.

United Kingdom

Miele Co. Ltd., Fairacres, Marcham Road
Abingdon, Oxon, OX14 1TW
Professional Sales, Tel: 0845 365 6608
E-mail: professional@miele.co.uk
Internet: www.miele-professional.co.uk

Australia

Miele Australia Pty. Ltd.
ACN 005 635 398, ABN 96 005 635 398
Level 4, 141 Camberwell Road, Hawthorn East, VIC 3123
Tel: 1300 731 411
Internet: www.miele-professional.com.au
E-mail: professional.sales@miele.com.au

China Mainland

Miele Electrical Appliances Co. Ltd.
No. 82, Shimenyi Road, JingAn District,
Shanghai, China, P.R.C, Post Code: 200040
Phone: +86 21 6157 3500, Fax: +86 21 6157 3511
E-mail: info@miele.cn, Internet: www.miele.cn

Hong Kong, China

Miele (Hong Kong) Ltd.
41/F - 4101, Manhattan Place
23 Wang Tai Road, Kowloon Bay, Hong Kong
Tel: (852) 2610 1025, Fax: (852) 3579 1404
Email: customerservices@miele.com.hk
Website: www.miele.hk

India

Miele India Pvt. Ltd.
1st Floor, Copia Corporate Suites,
Commercial Plot 9, Mathura Road, Jasola,
New Delhi - 110025
E-mail: customercare@miele.in, Website: www.miele.in

Ireland

Miele Ireland Ltd.
2024 Bianconi Ave., Citywest Business Campus,
Dublin 24
Tel: (01) 461 07 10, Fax: (01) 461 07 97
E-Mail: info@miele.ie, Internet: www.miele-professional.ie

Malaysia

Miele Sdn Bhd
Suite 12-2, Level 12
Menara Sapura Kencana Petroleum
Solaris Dutamas No. 1, Jalan Dutamas 1
50480 Kuala Lumpur, Malaysia
Phone: +603-6209-0288
Fax: +603-6205-3768

New Zealand

Miele New Zealand Limited
IRD 98 463 631
8 College Hill
Freemans Bay, Auckland 1011, NZ
Tel: 0800 464 353
Internet: www.miele-professional.com.au
E-mail: professional.sales@miele.com.au

Singapore

Miele Pte. Ltd.
29 Media Circle, #11-04 ALICE@Mediapolis
Singapore 138565
Tel: +65 6735 1191, Fax: +65 6735 1161
E-Mail: info@miele.com.sg
Internet: www.miele.sg

South Africa

Miele (Pty) Ltd
63 Peter Place, Bryanston 2194
P.O. Box 69434, Bryanston 2021
Tel: (011) 875 9000, Fax: (011) 875 9035
E-mail: info@miele.co.za
Internet: www.miele.co.za

United Arab Emirates

Miele Appliances Ltd.
Showroom 1, Eiffel 1 Building
Sheikh Zayed Road, Umm Al Sheif
P.O. Box 114782 - Dubai
Tel. +971 4 3044 999, Fax. +971 4 3418 852
800-MIELE (64353)
E-Mail: info@miele.ae
Website: www.miele.ae



Manufacturer: Miele & Cie. KG, Carl-Miele-Straße 29, 33332 Gütersloh, Germany