

Miele



Operating and installation instructions Commercial heat-pump dryers PDR 914/918/922 HP

To avoid the risk of accidents or damage to the machine, it is **essential** to read these instructions before it is installed and used for the first time.

en-GB

M.-Nr. 11 864 650

Contents

Caring for the environment	5
Warning and Safety instructions	6
Appropriate use	6
Foreseeable misuse	7
Technical safety	7
Correct use.....	8
Accessories	9
Description of the machine	10
Operating the tumble dryer	11
Control panel.....	11
Sensor controls and touch display with sensor controls.....	12
Main menu	12
“☐ Programmes” menu.....	12
“☆ Favourites” menu.....	12
“⚙ Supervisor” menu	12
Operating examples	12
Selection lists.....	12
Setting numerical values	13
Pull-down menu.....	14
Exiting the menu	14
Help display.....	14
Initial commissioning	15
Switching on the tumble dryer	15
Reference to optional external devices	16
Setting the display brightness	16
Setting the date	16
Confirming the time of day display query	16
Selecting programme packages	17
Completing the initial commissioning process	18
Drying	19
1. Notes on correct laundry care	19
Washing before drying	19
Removing foreign objects.....	19
Care symbols.....	19
2. Loading the tumble dryer.....	20
3. Selecting a programme	21
Switching on the tumble dryer	21
4. Selecting programme settings.....	22
Select the drying level.....	22
Selecting extra options	22
5. Starting a programme	23
Payment device (optional).....	23
Calling up current programme parameters	23
Programme running time/Time left estimation.....	23
End of the programme	24
End of programme	24
Removing the laundry	24
Care notes	24

Timer	24
Prerequisite for setting the timer	24
Setting the timer	24
Changing the programme sequence.....	25
Changing a programme once it has started	25
Cancelling the current programme	25
Reselecting a cancelled programme.....	25
Time left	25
Supervisor level.....	26
Opening the Supervisor level.....	26
Access via code	26
Change code	26
Closing the settings menu	26
Controls / Display.....	26
Language.....	26
Language entry.....	26
Set languages.....	27
Display brightness	27
Clock display	27
Date	27
Volume	27
Res. moisture display.....	28
Visibility parameters.....	28
Display off status	28
Machine off status.....	29
Delay start	29
Memory.....	29
Temperature unit.....	29
Weight unit	29
Change code	29
Programme selection.....	29
Controls.....	29
Programme packages.....	30
Favourite programmes	31
Special programmes	31
Sort programmes.....	32
Prog. colour allocation	33
Process technology.....	33
Anti-crease	33
Drying levels	33
Further cooling	33
Cooling down temperature.....	33
Service	34
Clean out the airways	34
Clean the filters.....	34
Service interval.....	34

Contents

External applications.....	35
External exhaust flap.....	35
Additional fan.....	35
Pressure sensor.....	35
Peak load signal.....	35
Peak load prevention.....	36
COM module selection.....	36
Availability of Miele digital products.....	36
WiFi / LAN.....	36
Remote.....	37
Remote update.....	37
Machine parameters.....	37
Legal information.....	37
Payment system.....	38
Setting for payment systems.....	38
Connectivity.....	39
Pairing instructions.....	39
Opening the supervisor level.....	39
Establishing the network connection via WPS.....	39
Establishing the network connection via soft AP.....	39
Establishing the network connection using a LAN cable.....	39
Technical data.....	40
Cleaning and maintenance.....	41
Cleaning the fluff filter.....	41
Tumble dryer.....	42
Heat exchanger.....	43
Problem solving guide.....	45
Fault diagnosis.....	45
Contact in case of malfunction.....	46
Installation.....	47
Installation requirements.....	47
General operating conditions.....	47
Transport.....	47
Installing the heat-pump.....	48
Installation.....	50
Electrical connection.....	52
Air intake vent.....	53
Air outlet vent.....	55
Condensate drainage.....	55
Optional accessories.....	56
Communication box.....	56
APCL106.....	56
Payment systems.....	57
Technical data.....	58
Technical data.....	58
EU declaration of conformity.....	58
UK declaration of conformity.....	58

Disposal of the packing material

The packaging is designed to protect the appliance from damage during transportation. The packaging materials used are selected from materials which are environmentally friendly for disposal and should be recycled.

Recycling the packaging reduces the use of raw materials in the manufacturing process and also reduces the amount of waste in landfill sites.

Disposing of your old appliance

Old electrical and electronic appliances often contain valuable materials. However, they also contain harmful substances which were essential for their correct functioning and safety. These could be hazardous to human health and to the environment if disposed of with general waste or if handled incorrectly. Please do not, therefore, dispose of your old appliance with household waste.

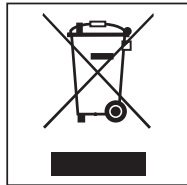

Instead, please make use of officially designated collection and disposal points to dispose of and recycle electrical and electronic appliances in your local community. Consult your dealer.

Please ensure that your old appliance poses no risk to children while being stored for disposal.

Warning and Safety instructions

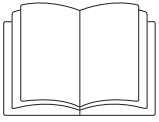

- ▶ It is essential to read these instructions.

This tumble dryer complies with all current local and national safety requirements. However, inappropriate use can lead to personal injury and damage to property.

Read the operating instructions carefully before using the tumble dryer. They contain important information on safety, installation, use and maintenance. This prevents both personal injury and damage to the tumble dryer.

In accordance with standard IEC 60335-1, Miele expressly and strongly advises that you read and follow the instructions in the chapter on installing the tumble dryer as well as the safety instructions and warnings.

Miele cannot be held liable for damage caused by non-compliance with these instructions.

Keep these operating instructions in a safe place and pass them on to any future owner.

When instructing other people how to use the tumble dryer, they must be made aware of these safety and warning instructions.

Appropriate use

- ▶ The tumble dryer is intended for installation in a commercial environment.
- ▶ This tumble dryer is only intended for drying fabrics which have been washed in a water solution, and marked on the manufacturer's care label as being suitable for tumble drying. "Dry cleaning kits" for freshening up garments in a tumble dryer are increasingly available on the market. If using, do so at your own risk, and follow the instructions provided on the packaging. Any other applications may be dangerous. Miele cannot be held liable for damage resulting from incorrect or improper use or operation.
- ▶ The tumble dryer is not intended for outdoor use.
- ▶ Do not install the tumble dryer in a room where there is a risk of frost. At temperatures around freezing point, the tumble dryer may not be able to operate properly. The permitted room temperature is between 10 °C and 40 °C.
- ▶ If the machine is used in a commercial environment it may only be operated by instructed/trained personnel. If the machine is used in a publicly accessible area, the supervisor must ensure that it can be operated safely without risk of danger.
- ▶ This appliance can only be used by people with reduced physical, sensory or mental capabilities, or lack of experience or knowledge, if they are supervised whilst using it or have been shown how to use it in a safe way and understand and recognise the consequences of incorrect operation.
- ▶ Children under 8 years of age must be kept away from the tumble dryer unless they are constantly supervised.
- ▶ Children 8 years and older may only use the tumble dryer unsupervised if they have been shown how to use it safely and recognise and understand the consequences of incorrect operation.
- ▶ Children must not be allowed to clean or maintain the tumble dryer unsupervised.
- ▶ Please supervise children in the vicinity of the tumble dryer and do not let them play with it.
- ▶ This tumble dryer may also be operated in public areas.
- ▶ Any uses other than those listed above are prohibited. The manufacturer accepts no liability in such cases.

Foreseeable misuse

- ▶ Do not make any alterations to the tumble dryer, unless authorised to do so by Miele.
- ▶ Do not use a pressure washer or water jet to clean the tumble dryer.
- ▶ Benzene, petrol, paraffin, or any easily flammable liquid must not be stored or used near the machine. Danger of explosion.
- ▶ Do not expose the dryer to air which is contaminated with vapour of chlorine, fluorine or other solvents. Danger of fire.
- ▶ Fire hazard due to controllable socket. This tumble dryer must not be connected to a controllable socket (e.g. a timer). There is a risk of the laundry self-igniting if the tumble dryer's cooling phase is interrupted.
- ▶ To prevent the risk of fire, the following items must not be dried in this tumble dryer:
 - Items which have not been washed.
 - Items which have not been thoroughly cleaned and are still soiled with grease, oil or other deposits (such as kitchen linens or cosmetics cloths with cooking oils, grease, lotions, etc). If items have not been thoroughly cleaned, there is a danger that they might ignite when heated, even after they have been removed from the tumble dryer at the end of the programme.
 - Items (e.g. mops and floor cloths) that have been treated with inflammable cleaning agents or which contain residues of acetone, alcohol, benzene, petrol, kerosene, stain remover, turpentine, wax and wax remover or other chemicals.
 - Items which have been splashed with hair lacquer, hair spray, nail varnish remover or similar substances.

Wash heavily soiled items thoroughly by increasing the amount of detergent and selecting a high washing temperature. If in doubt, wash the items several times.

- ▶ In many programmes, the heating phase is followed by a cooling down phase to ensure that the items are not too hot to handle when you remove them (this also avoids the danger of the laundry self-igniting). The programme is not finished until the cooling down phase is complete. Ensure that you always wait until the end of the programme before removing the laundry.
- ▶ Never operate the tumble dryer without the fluff filter or with a damaged fluff filter. This could lead to malfunctions. Fluff can clog the air channels, heating elements and vent ducting, which could result in a fire. In this case, stop the tumble dryer immediately and replace the damaged fluff filter.
- ▶ Do not lean on the tumble-dryer door. Otherwise, the tumble dryer may tip over, causing injury to yourself or others.

Technical safety

- ▶ Before setting up the tumble dryer, check it for any externally visible damage. Do not install or use a damaged tumble dryer.
- ▶ Do not connect the tumble dryer to the power supply by an extension lead (fire hazard due to overheating).
- ▶ The electrical safety of this tumble dryer can only be guaranteed when correctly earthed. It is essential that this standard safety requirement is observed and regularly tested. If in any doubt, please have the electrical installation inspected by a specialist. Miele cannot be held liable for the consequences of an inadequate earthing system.
- ▶ Unauthorised repairs could result in unforeseen dangers for the user, for which Miele cannot accept liability. Repairs should only be undertaken by a Miele authorised technician, otherwise any subsequent damage will not be covered by the warranty.

Warning and Safety instructions

- ▶ Faulty components may only be replaced by genuine Miele spare parts. Miele can only guarantee the safety standards of the appliance when Miele replacement parts are used.
- ▶ To ensure the correct performance of the tumble dryer and to prevent the risk of faults and fire, it is important to carry out maintenance on a regular basis.
- ▶ In the event of a fault, when replacing components and for cleaning and maintenance purposes, the tumble dryer must be disconnected from the power supply. The tumble dryer is only disconnected from the power supply, if:
 - It is switched off at the wall socket or the plug is withdrawn.
 - The mains fuse is disconnected.
 - The mains fuses have been completely removed.
- ▶ The tumble dryer must not be used in non-stationary installation sites (e.g. on a ship).
- ▶ Follow the instructions in “Installation” and “Technical data”.
- ▶ There is a risk of suffocation and poisoning due to exhaust gases being sucked back if gas-powered flow heaters, gas-powered room heaters, coal-burning stoves with a flue connection, etc., are installed in the same room, in the same flat or in neighbouring rooms and the negative pressure is 4 Pa or more.

The following measures for suitable room ventilation (examples) can help to prevent negative pressure in the installation area:

- Install suitably sized vents that cannot be closed in the exterior walls.

Please always seek approval from your building regulations inspector to confirm that the appliance can be operated without risk and that negative pressure of over 4 Pa can be prevented.

- ▶ The plug must be easily accessible so that the tumble dryer can be disconnected from the power supply at any time. The operator must be able to check from any access point that the plug is still removed.
- ▶ If the appliance is hard wired, adequate provision must be made on site to switch off all poles to disconnect the tumble dryer from the power supply.
- ▶ Do not block the gap between the bottom of the tumble dryer and the floor with plinth facings, deep pile carpet etc.
- ▶ Ensure that no closeable door, sliding door or an oppositely hinged door is installed that would hinder the drum door being opened in any way.
- ▶ If the mains connection cable is faulty it must always be replaced by a Miele authorised technician to protect the user from danger.

Correct use

- ▶ Always close the drum door after each drying cycle. This will prevent:
 - Children climbing into the tumble dryer or hiding things in it.
 - Pets or other small animals climbing into the tumble dryer.
- ▶ Keep the room where the tumble dryer is located free from dust and fluff. If the air that is taken into the machine contains dirt particles, this can cause blockages. A fault may then occur and there is a risk of fire.
- ▶ The fluff filter must be cleaned on a regular basis.
- ▶ To ensure problem-free operation of the tumble dryer:
 - Clean the surface of the fluff filter after each drying cycle.
 - In addition, the fluff filter and the air passages must be cleaned when prompted by the display.
- ▶ Remove all items from the pockets of the laundry to be dried (e.g. lighters, matches, keys).

Warning and Safety instructions

▶ Many programmes are followed by the cooling phase to ensure that the items of laundry are kept at a temperature that will not cause them damage (for instance to prevent the risk of the laundry self-igniting). Always remove all items of laundry from the tumble dryer immediately after the cooling phase.

▶ Fabric conditioner and similar products must be used according to the instructions on the manufacturer's packaging.

▶ For tumble dryers with stainless steel surfaces:

The stainless steel surfaces must not come into contact with liquid cleaning and disinfecting agents which contain chlorine or sodium hypochlorite. These agents can have a corrosive effect on stainless steel.

Aggressive vapours containing chlorine can also be corrosive.

Do not store containers of these agents near the tumble dryer.

Accessories

▶ Accessory parts may only be fitted when expressly approved by Miele. If other parts are used, warranty, performance and product liability claims will be invalidated.

▶ Make sure that you order the correct plinth for this tumble dryer (available from Miele as an optional accessory).



 Miele cannot be held liable for damage caused by non-compliance with these Warning and Safety instructions.

Description of the machine

- ① Control panel with touch display
- ② Door
- ③ Fluff filter flap
- ④ 4 height-adjustable screw feet
- ⑤ Electrical connection
- ⑥ Air outlet vent
- ⑦ Air intake vent (cool air)
- ⑧ Condensate drainage

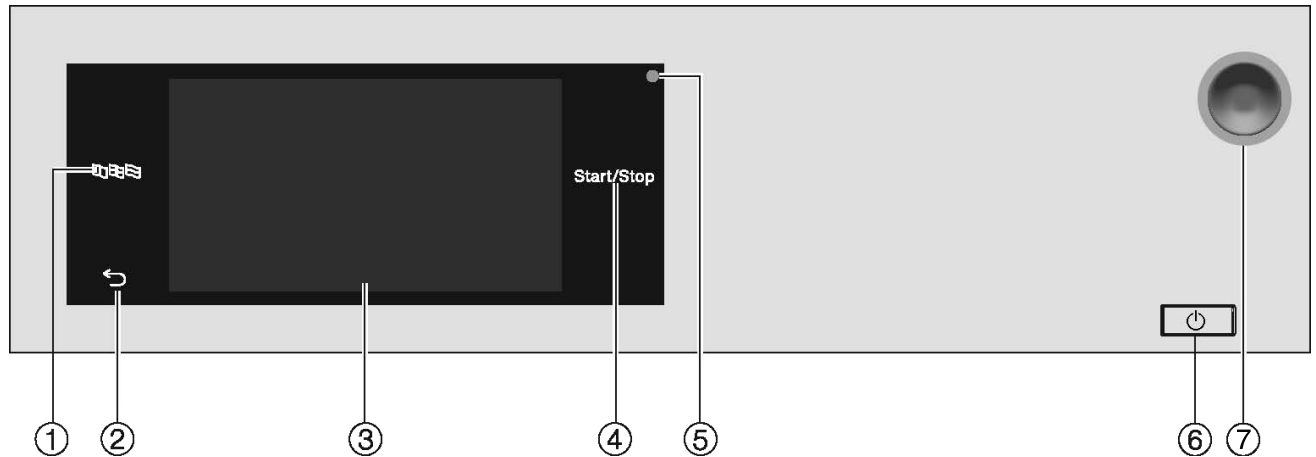































Control panel



- ①  **sensor control**
For selecting the current user language
At the end of the programme, the language is automatically reset to the language set at the supervisor level.
- ②  **sensor control**
Takes you back one level in the menu.
- ③ **Touch display**
- ④ **Start/Stop sensor control**
For starting the selected drying programme and cancelling a programme once it has started. The programme selected can be started as soon as the sensor control starts flashing.
- ⑤ **Optical interface**
For the Customer Service Department
- ⑥  **button**
For switching the tumble dryer on and off. Depending on the programming at supervisor level, the tumble dryer switches off automatically to save energy. It is switched off an adjustable time after the end of the programme/Anti-crease phase, or after being switched on if no further selection is made.
- ⑦ **Emergency off switch**
It should only be activated in the event of danger or in order to prevent danger. When this switch is activated, the machine is immediately switched off and put in a safe condition. Once the danger has been averted, the switch can be unlocked again by turning the knurled dial to the right.

Operating the tumble dryer

Sensor controls and touch display with sensor controls

The sensor controls , , , , , , , , , , , , , , , , , , , , , , , , , , , , , , , , , , , , , , , , , , , , , , , , , , , , , , , , , , , , , , , , , , , , , , , , , , , , , , , , , , , , , , , , , , , , , , , , , , , , , , , , , , , , , , , , , , , , , , , , , , , , , , , , , , , , , , , , , , , , , , , , , , , , , , , , , , , , , , , , , , , , , , , , , , , , , , , , , , , , , , , , , , , , , , , , , , , , , , , , , , , , , , , , , , , , , , , , , , , , , , , , , , , , , , , , , , , , , , , , , , , , , , , , , , , , , , , , , , , , , , , , , , , , , , , , , , , , , , , , , , , , , , , , , , , , , , , , , , , , , , , , , , , , , , , , , , , , , , , , , , , , , , , , , , , , , , , , , , , , , , , , , , , , , , , , , , , , , , , , , , , , , ,

The orange scroll bar in the bottom display area shows that there are further options to choose from.

- To select the required drying programme, touch the programme name with your finger. The display will now change to the standard menu for that programme.

“Extras” menu (multiple selection)

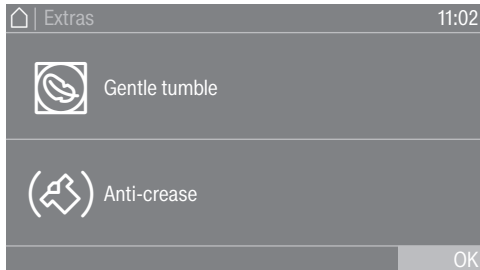

To select one or more *Extras*, touch the required *Extras* with your finger.

Currently selected *Extras* are marked orange. To deselect an *Extra* simply touch the *Extra* again.

Setting numerical values

You can set numerical values in some menus. You can set the numerical values by swiping your finger up and down on the display.

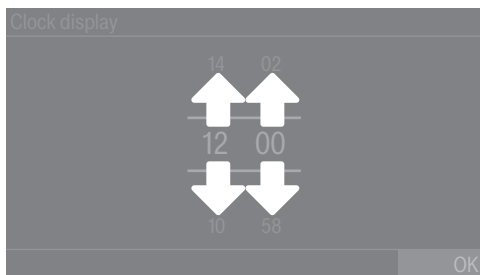

- Place your finger on the number that you want to change.
- To set the required number, swipe your finger up or down on the display.
- Confirm the set numerical value by touching the OK sensor control.

Tip: For some settings, depending on the value range and increments, the value can also be set using a numerical keypad. Briefly touching the numbers will bring up the numerical keypad. Once a valid number has been entered, the OK sensor control will be highlighted green.

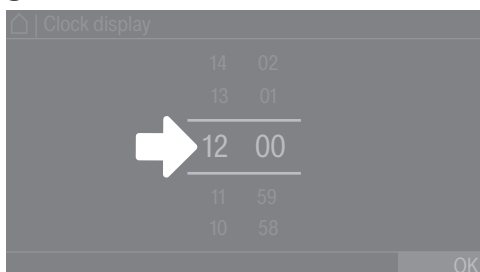

- Briefly touch a number between the two lines with your finger. The numeric block will appear.

Operating the tumble dryer

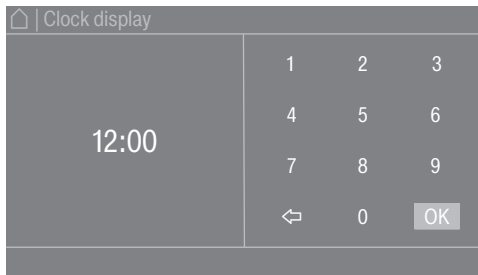

- To enter the numerical value, touch the numbers on the right-hand side and then confirm with OK.

Pull-down menu

The pull-down menu can be used to display information (e.g. about a drying programme).

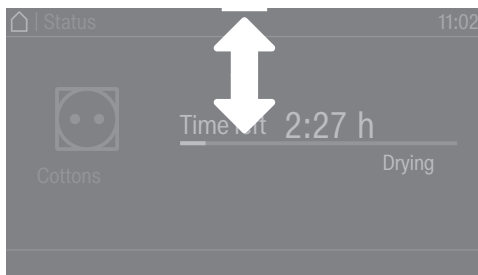

If an orange bar appears at the top of the screen in the middle of the display, you can open the pull-down menu. Touch the bar and drag it down with your finger on the display.

To close the pull-down menu again, touch the orange bar and drag it up with your finger on the display.

Exiting the menu

- Touch the ↶ sensor control to return to the previous screen.

Entries made before this which have not been confirmed with OK will not be saved.

Help display

With some menus, Help appears along the bottom line of the display.

- If you need more information about the current menu, touch the Help sensor control. The additional information is shown in the display.
- Touch the ↶ sensor control to return to the previous screen.

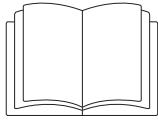

⚠ Risk of injury or damage to property due to improper installation. Incorrect installation of the tumble dryer can lead to personal injury or damage to property.

Before commissioning the tumble dryer for the first time, make sure it has been installed correctly.

Connect the tumble dryer correctly.

Please follow the instructions in “Installation”.

⚠ Damage caused to tumble dryers with heat pumps by switching the machine on too soon after commissioning.

Commissioning the machine too quickly can damage the heat pump inside the tumble dryer.

After installing the tumble dryer, wait for at least one hour before starting a drying programme.

Complete the initial commissioning process. During the initial commissioning process, you will need to define the settings for daily use of the tumble dryer. Some settings can only be modified during the initial commissioning process. After that, they can only be changed by the Miele Customer Service Department.

These settings are also described under “Supervisor level”.

Switching on the tumble dryer

- Press the  button.

The welcome screen will light up.

Setting the display language

You will be asked to select the display language. You can change the language at any time (see “Language” under “Supervisor level”).

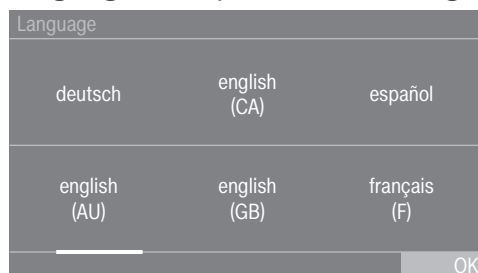

- Swipe left or right across the display with your finger until the language you want appears.
- Briefly touch the required language with your finger.

The selected language will be highlighted in orange and the display will change to the next setting.

Reference to optional external devices

If there are external devices (e.g. peak-load systems or payment devices), connect the communication box and/or slide a communication module into the slot on the back of the tumble dryer before initial commissioning. For this purpose, the tumble dryer must be disconnected from the power supply. Then start the commissioning process.

A reference to optional external hardware appears. Confirm the information with the OK sensor control.

Setting the display brightness

You will be asked to select the brightness of the display.

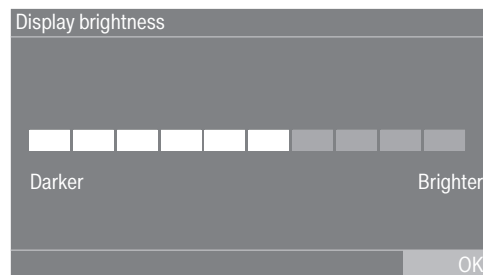

- Touch the segment bar for the required level of brightness. The selected level of brightness is represented by the length of the segment bar.

- Confirm with the OK sensor control.

The display will change to the next setting.

Setting the date

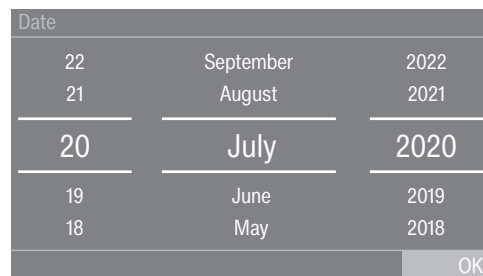

- Place your finger on the value that you want to change and move your finger upwards or downwards.
- Once all values have been selected, confirm your entry with the OK sensor control.

The display will now change to the next setting.

Confirming the time of day display query

The following question appears in the display: Should the time of day display not be shown?

- Touch the Yes or No sensor control.

If you select Yes, the system will skip the Time settings menu.

If you select No, the display will switch to the Time settings menu.

Setting the time

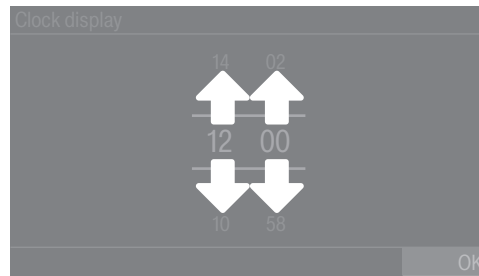

- Place your finger on the number that you want to change and move your finger upwards or downwards.
- Confirm with the OK sensor control.

The display will change to the next setting.

Selecting programme packages

You can select various programmes from the programme packages. Any programmes already active are highlighted in orange.

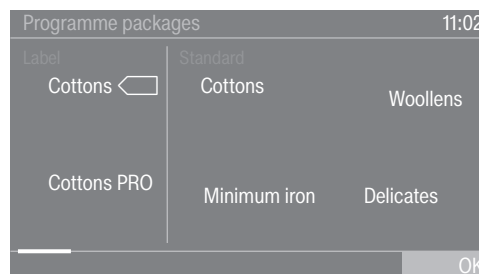

- Swipe to the left with your finger until you reach a programme that is not highlighted in orange.
- Touch the programme to be activated.

The selected programme is now active and highlighted in orange.

You can select further programmes if required.

- If you do not want to select any more programmes, confirm with OK.

The display will change to the next setting.

Tip: You can disable a selected programme by touching the programme again. Exception: The Cottons  and Cottons PRO programmes cannot be disabled.

Setting up a payment device

If you wish to set up a payment device, read the “Payment system” section of the “Supervisor level” chapter. You can only make these settings during initial commissioning. If you wish to change the settings after the commissioning process, please contact the Miele Customer Service Department.

If you do not wish to set up a payment device, you can skip this step.

Initial commissioning

Skipping payment device set-up

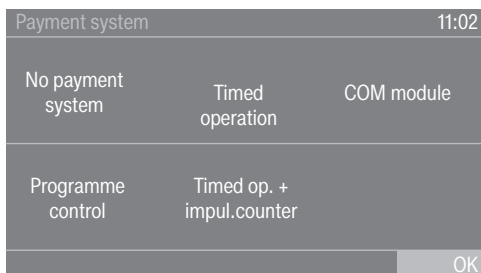

- Touch the No payment system sensor control.
- Touch OK to confirm.

The display will change to the next setting.

Completing the initial commissioning process

The commissioning process is complete when a programme lasting longer than 10 minutes has been carried out in full.

If the power is interrupted prior to the start of the first drying programme (e.g. if the machine is switched off with the  button), the initial commissioning process can be completed again. Once a drying programme has been running for over 10 minutes, the initial commissioning process cannot be performed again.

- In the main menu, touch the  Programmes sensor control.

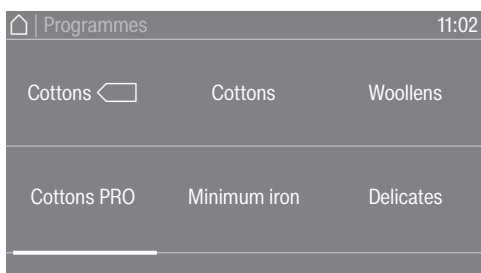

- Swipe to the left with your finger until the Timed drying cool air programme is displayed.

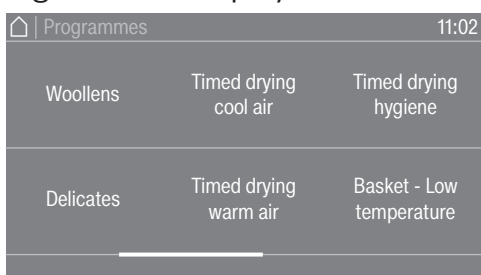

- Touch the Timed drying cool air programme.
- Touch the flashing *Start/Stop* sensor control.

After this programme has finished, the tumble dryer is ready for use.

1. Notes on correct laundry care

Washing before drying

Heavily soiled laundry must be washed particularly thoroughly. Use sufficient detergent and select a high wash temperature. If in doubt, wash the items several times.

The tumble dryer must not be used for drying items of laundry which have been cleaned using industrial chemicals.

New and coloured items must be washed thoroughly and separately. Do not dry new and coloured items with light coloured garments. There is the risk of colours running and discolouring other garments or even plastic components in the tumble dryer. Dark coloured fluff can also settle on light coloured garments and vice versa.

Removing foreign objects







Before drying, ensure that there are no foreign objects in the laundry.

 Damage due to foreign objects which were not removed from the laundry.
Foreign objects in the laundry can melt, burn or explode.
Ensure that any foreign objects (e.g. detergent dispensing aids, lighters, etc.) have been removed from the laundry.

Check seams and stitching to ensure that the items of laundry are intact. This way you will avoid the danger of fillings coming out and causing a fire. Sew in or remove underwiring from bras.

 Risk of fire due to incorrect use and operation.
The laundry can burn and destroy the tumble dryer and the surroundings.
See the section on “Warnings and safety notes” for further information.

Care symbols

Drying	
	Normal/higher temperature
	Low temperature*
* Select Low temperature.	
	Do not tumble dry
Ironing	
	Very hot
	Hot
	Warm
	Do not iron

2. Loading the tumble dryer

Loading laundry into the tumble dryer

Preventing damage to fabrics.
Before loading, read chapter “1. Notes on correct laundry care” first.

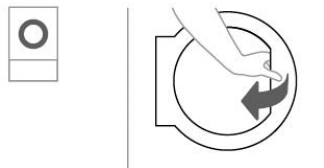

- Open the door.
- Load laundry into the tumble dryer.

Risk of damage with laundry getting trapped.
Laundry can be damaged by getting trapped when closing the door.
When closing the door, make sure that laundry does not get trapped in the door opening.

Do not overload the drum. Overloading can cause unnecessary wear and tear to the laundry and cause a disappointing drying result. It can also cause more creasing.

Closing the door

⚠ Damage caused by laundry getting trapped.
Laundry can be damaged by getting trapped when closing the door.
When closing the door, make sure that laundry does not get trapped in the door opening.

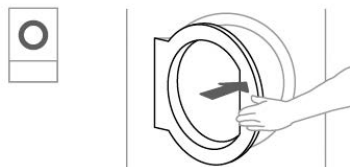

- Shut the door gently.

Switching on the tumble dryer

3. Selecting a programme

- Press the  button.

The welcome screen will light up.

There are different ways to select a drying programme in the main menu.

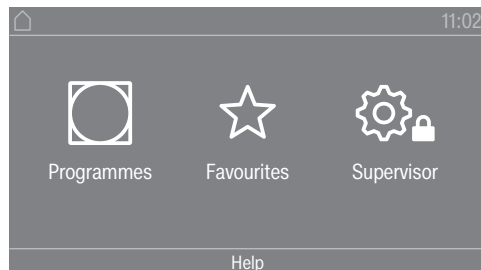

- Touch the  Programmes sensor control.

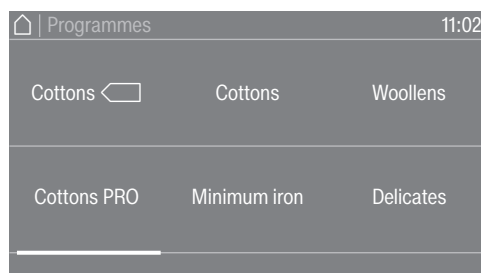

- With your finger, swipe to the left until you reach the required programme.
- Touch the sensor control for that programme.

The display will change to the standard menu for that drying programme.

Alternatively, you can select a programme from the Favourites list. The preset programmes under  Favourites cannot be changed via the Supervisor level.

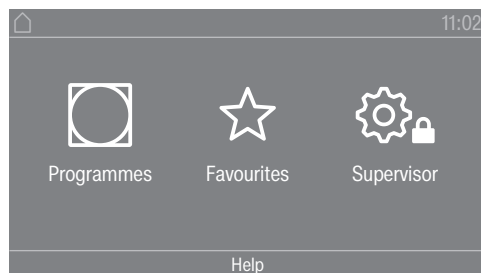

- Touch the  Favourites sensor control.

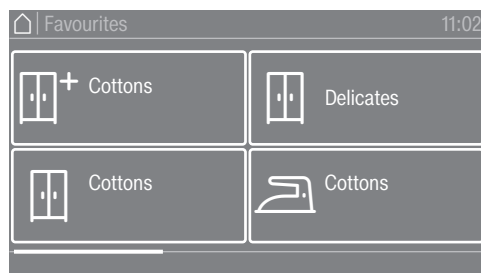

- With your finger, swipe to the left until you reach the required programme.

- Touch the required programme.

The display will change to the standard menu for that drying programme.

4. Selecting programme settings

Select the drying level

With many programmes, you can change the preset drying level. Depending on the programme, you can select different drying levels.

Selecting extra options

The drying programmes can be augmented with various Extras. Some Extras can only be selected for certain drying programmes.

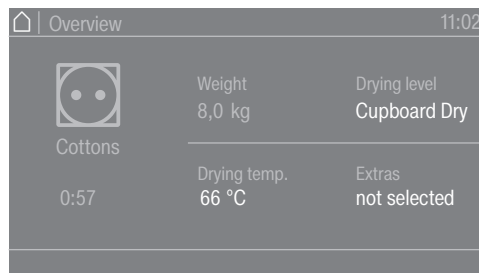

- Touch the Extras sensor control.

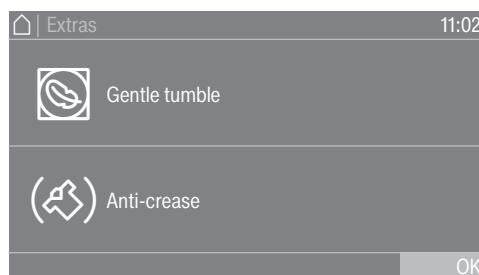

- Touch the sensor control for the extra you want.
- Only press OK when the extra appears on the display.

The relevant symbol for the required extra (☰ or ⚡) lights up.

☰ Low temperature

Delicate fabrics (with the ☰ symbol on the care label, e.g. acrylic garments) are dried at a lower temperature. The programme duration is also longer.

☰ Gentle tumble

Sensitive items are dried with fewer drum rotations and a lower drying temperature.

⚡ Anti-crease

At the end of the programme, the drum will continue to rotate in a certain rhythm, depending on the selected programme. This helps to prevent creasing at the end of the programme.

The Anti-crease function is switched off as the factory default setting. The Anti-crease function can be switched on in the supervisor level with a variable duration of up to 12 hours. You can find this setting in the supervisor level under the Process technology/Anti-crease menu.

5. Starting a programme

Payment device (optional)

If your machine is connected to a payment device, the amount of payment required will appear in the display.

Money may be lost if the drum door is opened or the programme is cancelled.

Depending on the settings, money may be lost in the payment device if the drum door is opened or the programme is cancelled.

Do not open the door once the programme has started.

Do not cancel a drying programme while it is running.

Starting the programme

The programme can be started as soon as the *Start/Stop* sensor control is flashing on and off.

- Touch the *Start/Stop* sensor control.

If a delay start period has been selected, this will appear in the display.

The drying programme will start either straight away or once the delay start period has elapsed. The programme time left is shown in the display.

Calling up current programme parameters

During the programme running time, you can use the pull-down menu to view the parameters of the current drying programme (e.g. drying level, load size, selected extras, drying temperature).

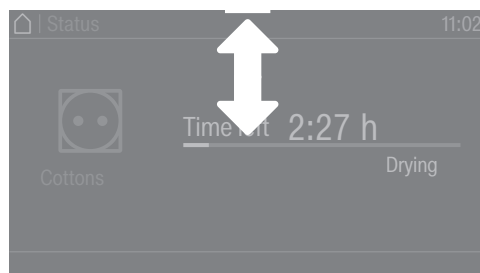

- To call up the pull-down menu, swipe your finger from top to bottom during the programme running time.



The pull-down menu displays the parameters of the drying programme.

- To close the pull-down menu again, swipe your finger from bottom to top or press the ↶ sensor control.

Programme running time/Time left estimation

The programme running time depends on the quantity of laundry, the type of fabric and the residual moisture in the laundry. The displayed programme running time for drying level programmes can therefore vary or “jump”. The tumble dryer’s electronic module adapts during the ongoing drying programme. The displayed programme running time becomes more and more accurate.

When using the programmes for the first time, the displayed time sometimes deviates significantly from the real time left. The difference between the estimated and achieved time becomes smaller if the corresponding programme is run more often. If different load sizes are dried in one programme, the time left display can only show an approximate time.

End of the programme

End of programme The laundry will be cooled down after the end of the programme. The message *Finish/Cool down* will appear on the display during the cooling phase. The laundry can now be removed.

After the cooling phase and the drying programme are completed, the message *Finish* is displayed.

The tumble dryer will switch off automatically after the set time after the end of a programme.

If the Anti-crease (🌀)* extra has been selected, the drum continues to rotate in intervals after the end of the programme. This reduces creasing if the laundry cannot be removed straight away.

* The Anti-crease function is switched off as the factory default setting and can be activated in the supervisor level.

Removing the laundry

- Open the door.
- Remove everything from the drum.

Items left in the tumble dryer could be damaged by overdrying when the tumble dryer is used the next time.
Always remove all items from the drum.

- Switch the tumble dryer off by pressing the ⏻ button.

Care notes

This tumble dryer requires regular maintenance, particularly if it is used on a continuous basis. Please see “Cleaning and care” for details.

Timer

Prerequisite for setting the timer

The Delay start must be activated in the Supervisor level in the Controls / Display menu so that the Timer can be selected. Before the programme starts, the Timer can be used to select a programme start time or programme end time.

Setting the timer

- Touch the Timer sensor control.
- Select the *Finish at, Start in or Start at* option.
- Set the hours and the minutes and confirm your entry with the OK sensor control.

Changing a programme once it has started

You cannot change to another programme once a programme has started (this prevents unintentional alterations). You will need to cancel the current programme before you can select a new one.

 Risk of fire due to incorrect use and operation.
The laundry can burn and destroy the tumble dryer and the surroundings.
See the section on “Warning and safety” for further information.

Cancelling the current programme

- Touch the *Start/Stop* sensor control.

The following message appears in the display: Cancel programme?

- Touch the *Yes* sensor control to cancel the current programme.

 Risk of burns by touching hot laundry or the tumble dryer drum.
Touching the hot laundry or the tumble dryer drum may cause burns.
Let the laundry cool down and remove it carefully.

Opening the door of the tumble dryer during the programme sequence will cancel the current programme.

If the *Door opening status/Interrupt programme* function is selected in the supervisor level, the current programme will be interrupted when the door is opened. In the case of an interruption, the tumble dryer will remain in the current programme.

The interrupted programme will be continued when the door is closed and the *Start/Stop* sensor control is pressed.

Reselecting a cancelled programme

- Open and close the door.
- Select and start a new programme.

Adding laundry during ongoing Delay start period

You can open the door to add or remove laundry.

- All programme settings will be saved.

- You can change the drying level, if required.

- Open the door.
- Add or remove laundry.
- Close the door.
- Touch the *Start/Stop* sensor control so that the Delay start period continues.

Time left

Altering the programme sequence can cause the programme duration shown in the display to be adjusted.

Supervisor level

Opening the Supervisor level

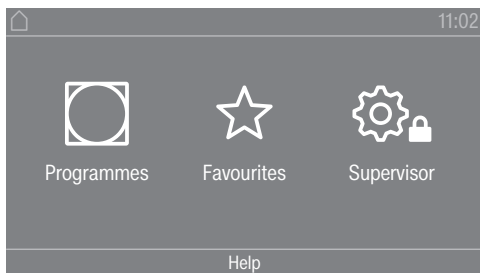

Touching the  sensor control takes you to the Supervisor level.

Access via code

Supervisor level is accessed using a code.

Factory default: The code is **000**.

Change code

You can alter the Supervisor level access code to protect the dryer from unauthorised access.

Be careful when entering a new code.

You will need to inform Miele Service if you forget your new code. Miele Service will have to reset the code.

Make a note of your new code and store it in a safe place.

Closing the settings menu

- Touch the  sensor.

The display will then go back to the previous menu level.

- Touch the  sensor.

The display will change to the main menu.

Controls / Display

Language

The display can be set to appear in one of several different languages. To select the language you want, go to the *Languages* sub-menu.

You can change the language as follows:

- Permanently using the supervisor level (= “Supervisor language”).
- For the duration of the current programme only using the  sensor control. The supervisor language is displayed again at the end of the programme.

Language entry

The display can be set to one of several different user languages. This setting allows you to determine how languages can be selected.

You can change the language as follows:

International

6 languages are available. The  sensor control is not active. Note the setting Set languages.

Language setting

The  sensor control can be used to select a language. All languages are available (factory default).

You can change the order of the first 4 languages. These slots are allocated to the most commonly used languages.

Standard language

The user language cannot be changed. The user language is the same as the supervisor language. The  sensor control is not active.

Set languages

The languages for the International lang. entry setting can be changed.

Six languages can be selected. All languages are available.

If you wish to add a new language to the language menu:

Six languages can be selected. All languages are available.

If you wish to add a new language to the language menu:

- First select the language you want to replace.

All available languages are displayed.

- Select and confirm the language to replace the previous language.

The new language appears instead of the old one.

Display brightness

The brightness of the display can be altered. The setting depends on the various lighting conditions in the place of installation.

- It can be set to one of 10 different levels.

Clock display

After selecting the clock format, you can set the time of day.

Clock format

- Factory default: 24-hour display
- 12-hour display
- No clock

Set

- The time can be set.

Date

The date can be set after selecting the date format.

- Date format

The date can be shown starting with the day, month or year.

- Date

The date is set.

Volume

The volume for various sounds can be changed.

The volume can be changed for the following tones:

Supervisor level

- Finish tone
The finish tone signals the end of the drying programme.
- Keypad tone
- Welcome tone
- Fault alarm
The fault tone signals a fault and can be switched off. The volume of the fault tone cannot be adjusted.

Res. moisture display

In addition to displaying the drying level, the residual moisture can also be indicated as a percentage.

- Factory default: Without % value
- With % value

Visibility parameters

Various parameters are offered/displayed when a programme is selected. You can decide which parameters should not be displayed. These parameters can then not be edited during programme selection.

- Residual moisture
- Duration
- Low temperature
- Anti-crease
- Load size
- Drying temperature

Display off status

The display switches off to save energy; only the *Start/Stop* sensor flashes slowly. You can change this setting.

Changing this setting leads to increased energy consumption.

- Off
No switching off
- On (10 min.) Not curr.prog.
The display will remain on during the programme sequence but will go out 10 minutes after the end of the programme.
- Logo (10 min.) Not curr.prog.
The display will remain on during the programme sequence but the logo will light up 10 minutes after the end of the programme.
- Factory default: On after 10 min.
The display is switched off after 10 minutes.
- On (30 min.) Not curr.prog.
The display will remain on during the programme sequence but will go out 30 minutes after the end of the programme.
- Logo (30 min.) Not curr.prog.
The display will remain on during the programme sequence but the logo will light up 30 minutes after the end of the programme.
- On after 30 min.
The display will go out after 30 minutes.

Machine off status

In order to save energy, the tumble dryer will switch off automatically after the end of the programme or if no further selection is made. You can change this setting.

Changing this setting leads to increased energy consumption.

- No switch off
- Factory default: Switch off after 15 minutes
- Switch off after 20 minutes
- Switch off after 30 minutes

Delay start

The delay start (timer) can be activated or deactivated.

- Factory default: Off
- On

Memory

The tumble dryer saves the settings that were last selected for a drying programme (drying stage and/or extra option, or the duration for some programmes).

- Factory default: Off
- On

Temperature unit

You can select the unit for the temperature display.

- Factory default: °C
- °F

Weight unit

You can decide whether load quantities are displayed in “kg” or “lbs”.

- Factory default: kg
- lb

Change code

You can alter the access code to the Supervisor level.

- Enter the current code.
- Enter a new code.

Programme selection

Controls

You can select whether the tumble dryer is operated as a “laundrette” machine. Short-cuts are the easiest way to operate the machine. Operating staff are unable to change pre-set programmes.

Tip: Start by configuring all necessary settings and changes to the tumble dryer before adjusting any of the options below.

Supervisor level

Caution: When activating any of these options, the Supervisor level will no longer be available.

You will no longer be able to access the Supervisor level via the display. Please follow the instructions below if you wish to change any other settings.

Opening the Supervisor level (laundrette version)

■ Switch the tumble dryer on and open the dryer door.

① Touch the *Start/Stop* sensor and hold it down whilst carrying out steps ②-③.

② Close the dryer door.

③ Wait until the *Start/Stop* sensor, which will now be flashing quickly, lights up constantly ...

④ ... and then release the *Start/Stop* sensor.

- Standard

Factory default: all (selected) programmes are available.

- Laundrette, basic

12 programmes are available.

Under Favourite programmes, you can set which of the 12 programmes to select or modify.

- Laundrette Logo

12 programmes are available.

Under Favourite programmes, you can set which 12 programmes to select/modify.

- Laundrette Logo ext. time

4 timed drying programmes* with different temperature levels are time-controlled via an external payment system.

The set value indicates the programme running time and cannot be modified by the user.

* The maximum programme running time is specified during initial commissioning.

- Laundrette Logo int. time

4 timed drying programmes* with different temperature levels are time-controlled via the tumble dryer electronic module.

The set value indicates the maximum programme running time and can be modified by the user.

* The maximum programme running time is specified during initial commissioning.

- External prog. selection

A communication module can be used to select the programme from an external terminal.

Programme packages

This allows you to specify the scope of the tumble dryer programme. You can select all of the programmes or individual programmes from the relevant programme packages.

The tumble dryer's additional scope of programmes can be configured. The programmes are listed under "Programme chart".

Favourite programmes

After switching on, you can also select a programme via: ☆ Favourites.
12 programmes can be stored as favourites based on your own priorities and requirements.

These favourites will also be made available in the control options

- *Launderette ext. (12 prog)*
- *Launderette, basic (4 prog)* (the first 4 of the 12 favourites).

You can specify the control option under Controls.

Tip: You can assign a different colour to each programme. In this case, the Prog. colour allocation setting must be set to *On*.

Changing Favourite programmes

- Select the programme you wish to change or replace.
- Confirm the programme or the setting to be changed.

Another menu opens, enabling you to select a new programme or change the parameters.

- Confirm with the *Save sensor control*.

Your selection is now active.

Special programmes

You can put together 5 special residual moisture or time-controlled programmes and assign your own programme names.

First, enter the programme name.

- Select the special programme you want to change.

The *Save as* menu opens.

- Use the letters and symbols below the line to enter the name.
- Touch the *Save sensor control*.

You can now enter the parameters for a Res. moisture programme or Timed drying.

The 5 special programmes are pre-programmed at the factory. You can change these special programmes.

The special programmes are added to the programme packages. Enter the name and settings of your special programme into the “Special programmes” table in the “Programme overview” chapter.

Res. moisture programme:

- Final residual moisture:
6 % (dry) – 40 % (damp)
- Extra drying time:
0–60 minutes
- Temperature (Process air):
cold – 75 °C
- Cooling down temperature (Process air):
40–55 °C
 - Drum rotation, main direction:
20–600 seconds

Supervisor level

- Pause:
2–15 seconds
- Drum reversal:
20–600 seconds
- Anti-crease
 - Drum rotation, main direction:
0–500 seconds
 - Pause:
100–3000 seconds
 - Drum reversal:
0–500 seconds

Timed drying:

- Running time:
5–180 minutes
- Temperature (Process air):
cold – 75 °C
- Cooling down temperature (Process air):
40–55 °C
 - Drum rotation, main direction:
20–600 seconds
 - Pause:
2–15 seconds
 - Drum reversal:
20–600 seconds
- Anti-crease
 - Drum rotation, main direction:
0–500 seconds
 - Drum reversal:
0–500 seconds
 - Pause:
100–300 seconds

Sort programmes

Programmes can be moved within the programme list and in the Favourites list.

- Factory default: Off
- On

Moving programmes/favourites

You can move/change the order of the programmes (programme menu – single option list). You can also move and change the order of the favourites that you edit in the *Supervisor level* under *Favourite programmes*.

- Touch the programme that you wish to move.
- Press and hold the sensor until the frame changes.
- Drag the programme to the required place.

Prog. colour allocation

You can assign a specific colour to a favourite programme. In the list of favourites, each favourite programme is given a coloured frame, which can be adjusted.

- Factory default: Off
- On

Process technology

Anti-crease

At the end of the programme, the drum will continue to rotate at intervals if the laundry is not removed immediately.

Changing this setting leads to increased energy consumption.

The setting for Anti-crease (🌀) can either be switched off or a time between 1 and 12 hours can be selected.

Factory default: 2 hours

Drying levels

Changing this setting leads to increased energy consumption.

You can alter the drying levels for the Cottons, Minimum iron and Automatic plus programmes.

Drying levels Cottons, Minimum iron and Automatic plus can be set to one of 7 different levels.

Factory default: normal

Further cooling

If extended cooling is activated, the drum temperature is checked approx. 1 minute before the machine goes into standby mode at the end of the programme. If the temperature is above 55 °C, the dryer will carry out cooling until it is below 55 °C.

Changing this setting leads to increased energy consumption.

- Factory default: off
- On

Cooling down temperature

The laundry will be cooled down automatically after the end of the programme. The automatic cooling phase can be set at a cooler level for all programmes. This means that the cooling phase is extended.

Changing this setting leads to increased energy consumption.

The setting can be changed from 40 °C–55 °C.

Factory default: 55 °C

Supervisor level

Service

Clean out the airways

The tumble dryer's electronic module calculates the degree to which fluff or detergent residues in the fluff filters and vent ducting are impairing performance. A message to check the contamination appears. You can decide at what level of fluff this reminder should be emitted.

If the message appears on the display even though the fluff filter is clean, the vent ducting is regarded as borderline. Miele recommends improving the vent ducting. Poor vent ducting will result in longer programme running times and greater energy consumption.

This reminder, which you can configure, is displayed: Clean out the airways

- Off

The reminder does not appear. However, if there is a very severe blockage in the ducting, the programme will be cancelled regardless of this option.

- Heavy

The reminder only appears when there is a heavy build-up of fluff.

- Factory default: normal

- Light

The reminder appears when there is only a small build-up of fluff.

Clean the filters

The fluff filter in the air duct area must be cleaned on a regular basis. You can set an hourly interval for the reminder.

The selected hourly interval depends on how much fluff tends to build up and how often you wish to clean the filter, e.g. for hygiene purposes.

You can adjust this reminder: Clean the filters

- Time interval of 5–55 hours

- Factory default: after 55 hours

- Off

Service interval

The tumble dryer shows a custom message at a selected interval to prompt you to undertake specific maintenance tasks.

Three different messages can be created: 1/2/3. Each message is created in the language and alphabet of the current supervisor language.

Your message is displayed at the end of the programme and can be acknowledged with OK. The same message appears at the end of the next programme.

Settings

This setting allows you to determine the interval (by hours or date) at which the message appears.

- Factory default: Off

- By time

You can then select a time interval from 1–9999 hours.

- By date

You can enter a date.

Message text

Enter your message for your planned maintenance work. You can edit one, two or all three of the 1/2/3 messages.

Reset display

The message appears until the display is permanently reset. The message then appears again once the next interval is reached.

External applications

External exhaust flap

External hardware is connected via the Miele Connector Box.

The time delay between the external exhaust air flap's activation point and the switch-on time for the drum/fan motor is regulated.

A message appears in the display while the exhaust air flap is open.

- Factory default: off

This option must always be selected if there is no exhaust air flap to activate. This prevents the programme from being cancelled.

- On (1 second to 5 minutes)

Additional fan

External hardware is connected via the Miele Connector Box.

The additional fan is switched on by the dryer (via Connector Box) in parallel with the internal fan.

- Off

- On

Pressure sensor

External hardware is connected via the Miele Connector Box.

When using a shared exhaust air duct, one tumble dryer may have to be switched off or suppressed from the outset if certain pressure levels have built up in the ducting. The external pressure sensor is only checked if the external exhaust air flap and/or the external additional fan is set to "on".

A message appears in the display while the exhaust air flap is open.

- Off = Not active

- Normally open contact = Active
Responds to **high potential**

- Norm. closed contact = Active
Responds to **low potential**

Peak load signal

External hardware is connected via the Miele Connector Box.

Supervisor level

The peak-load negotiation function enables the tumble dryer to be connected to an energy management system. When a signal is registered, the tumble dryer's heater is switched off for a short period or the machine is prevented from being switched on. A peak-load signal can be issued via the Connector Box or via the COM module.

- Factory default: No function
- Peak load with 230 V
- Peak load with 0 V
- COM module

Peak load prevention

- Factory default: Off
- On

COM module selection

This tumble dryer is equipped with an integrated WiFi module. However, the dryer can also be equipped with an external module.

- Factory default:
 - Off
- Internal module
 - The internal WiFi module is used.
- External module
 - An XKM module is inserted into the module slot.

Availability of Miele digital products

The ability of Miele digital products depends on the availability of the services in your country.

The different services are not available in all countries.

For information about availability, please visit www.miele.com.

WiFi / LAN

Control the networking of your tumble dryer.

Networking of the tumble dryer for use with the digital Professional tools is only possible with the external module. The internal module can only be used by the Miele Customer Service Department.

- Deactivate (visible when the network is activated)
 - The network remains set up; the WiFi function is switched off.
- Activate (visible when the network is deactivated)
 - The WiFi function is reactivated.
- Connection status (visible when the network is activated)
 - The following values are displayed:
 - the quality of WiFi reception
 - the network name
 - the IP address
- Set up again (visible when set up)
 - Resets the WiFi login (network) to immediately re-establish a new connection.
- Reset (visible when set up)

The network is no longer set up. A new connection has to be established in order to use the network again.

- The WiFi is switched off.
- The WiFi connection will be reset to the factory default setting.

Remote

External programme selection is possible via an external terminal (programme may only be started on the machine). However, programmes may also be selected and started on the machine.

Factory default: on

Remote update

The RemoteUpdate function is used for updating the software in your tumble dryer.

RemoteUpdate is activated by default.

If you do not install a RemoteUpdate, you can continue to use your tumble dryer in the usual way. However, Miele recommends installing RemoteUpdates.

Miele's RemoteUpdate function can only be used if the tumble dryer is connected to a WiFi/LAN network and you have an account in the Miele Professional app. The tumble dryer must be registered in the app.

See the Miele Professional app for terms of use.

If a RemoteUpdate is available for your washing machine, it will be displayed automatically when the Operator level is open.

You can choose to start the RemoteUpdate immediately or wait until later. If you select "Start later", the prompt to run the RemoteUpdate will be displayed again the next time you switch on your washing machine.

The RemoteUpdate can take a few minutes.

Please note the following information about the RemoteUpdate function:

- You will only receive a message when a RemoteUpdate is available.
- Once a RemoteUpdate has been installed, it cannot be undone.
- Do not switch off the tumble dryer during a RemoteUpdate. Otherwise, the RemoteUpdate will be aborted and will not be installed.

Machine parameters

Legal information

Open source licences

You can view information here.

Copyright and licences

For the purpose of operating and controlling the machine, Miele uses proprietary or third-party software that is not covered by open source licensing conditions. This software/these software components are protected by copyright. The copyrights held by Miele and third parties must be respected.

Furthermore, this machine contains software components which are distributed under open source licensing conditions. You can access these open source components along with the corresponding copyright notices, copies of the licensing conditions valid at the time and any further information. This information can be found under the menu option Set-

Supervisor level

tings/ Machine parameters/Legal information/Open source licences. The liability and warranty arrangements for the open source licences displayed in this location only apply in relation to the respective rights holders.

Payment system

The Miele communication box accessory unit or the COM module is required to connect a payment device.

Setting for payment systems

If you wish to change the settings after the commissioning process, please contact Miele Service.

- No payment system

The next settings are skipped.

- Programme control

The machine is operated using a coin box. The user purchases a programme.

- Timed operation

The tumble dryer is coin-operated using a time meter. The user purchases a time-controlled programme.

- Timed op. + impul.counter

For payment devices where the usage time is increased each time a coin is inserted.

- COM module

Operation is IP-based.

Pairing instructions

Follow the steps below to connect the tumble dryer to your network.

Opening the supervisor level

- Select the Supervisor menu option in the appliance display.
- Select the Access via code menu option.
- Enter the 3-digit supervisor code.

Establishing the network connection via WPS

- Select the Supervisor level menu option from the External applications menu.
- Then select the COM module selection menu option.
- If you are using an external communication module, select the External module menu option.
Otherwise, select the Internal module menu option.
- Select WiFi.
- Select Set up.
- Select the connection method Via WPS.
- Now press the WPS button on your router and confirm with OK in the appliance display. A timer starts. The network connection via WPS is being established. The appliance is now successfully connected.
- Touch OK to confirm.

Establishing the network connection via soft AP

- Select the External applications menu option from the Supervisor level menu.
- Then select the COM module selection menu option.
- If you are using an external communication module, select the External module menu option.
Otherwise, select the Internal module menu option.
- Select WiFi.
- Select Set up.
- Select the connection method Via Soft AP.
- Confirm pressing OK and follow the instructions in the external application.

Establishing the network connection using a LAN cable

- Select the External applications menu option from the Supervisor level menu.
- Then select the COM module selection menu option.
- If you are using an external communication module, select the External module menu option.
Otherwise, select the Internal module menu option.
- Connect the appliance to your router/switch using the network cable. The router/switch must be connected to the Internet.

The appliance is now successfully connected.

Connectivity

Technical data

System requirements for WiFi

- WiFi 802.11b/g/n
- 2.4 GHz band
- WPA/WPA2 encryption
- DHCP activated
- Multicast DNS / Bonjour / IGMP snooping activated
- Ports 443, 80, 53 and 5353 open
- IP DNS server = IP standard gateway/router
- Mesh/repeater use: same SSID and password as standard gateway/router
- SSID must be permanently visible



System requirements for LAN

- DHCP activated
- Multicast DNS / Bonjour / IGMP snooping activated
- Ports 443, 80, 53 and 5353 open
- IP DNS server = IP standard gateway/router

WiFi signal strength – Guide values

The WiFi signal strength is only a rough guide. These details do not provide absolute certainty.

The WiFi signal strength can be read via the MDU or directly on the appliance.

WiFi signal strength		Meaning
MDU	 *	
76–100 %	3/3**	Generally, reliable operation possible
51–75 %	2/3	
26–50 %	1/3	Generally, operation possible
1–25 %	0/3	Generally, reliable operation not possible
0 %		Operation not possible

* Displayed on the appliance

** Number of bars  3/3–0/3

The signal strength can be adversely affected by many factors:

- People in the room
- Open or closed doors
- Moved objects
- Varying radio signal sources or interference
- Other appliances with Bluetooth or WiFi wireless technology

Cleaning the fluff filter

⚠ Risk of fire if the tumble dryer is operated without a fluff filter.

If there is no fluff filter, the air channels, heating elements and vent ducting can become clogged during drying and may catch fire.

The fluff filter must not be removed for cleaning.

Never use the tumble dryer without the fluff filter in place.

Always replace a damaged fluff filter immediately.

The fluff filter catches any fluff that accumulates and must be cleaned at least once per working day, as well as when the corresponding prompt appears in the display.

To reset the display prompt for cleaning the filter, the fluff filter flap must remain open for at least 10 seconds. In the event of a heavy build-up of fluff, the fluff filter should be cleaned several times per day.

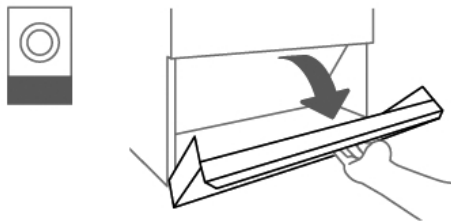

- Open the fluff filter flap.

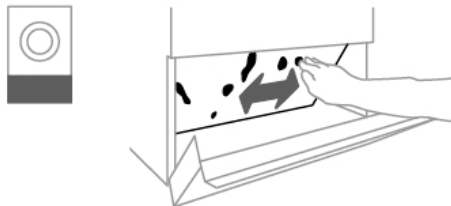

- Remove the fluff from the fluff filter using your hands.

Do not use pointed or sharp-edged objects to clean the fluff filter.
They can damage the fluff filter.

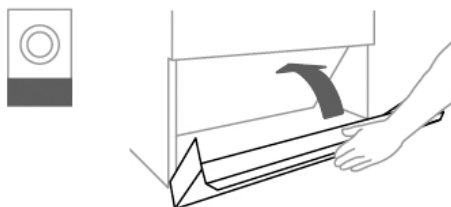

- Close the fluff filter flap after cleaning the fluff filter.

Cleaning and maintenance

Tumble dryer

The tumble dryer must be switched off at the main switch (on site) before any cleaning or maintenance work.

⚠ Do not use a pressure washer or hose to clean the tumble dryer. Otherwise, there is a risk of death due to electric shock.

- Clean the tumble dryer casing, control panel and plastic parts with a **mild** cleaning agent or with a soft, damp cloth only. Wipe dry with a soft cloth.

Abrasive cleaning agents must not be used to clean the tumble dryer.

- The tumble dryer drum must be wiped clean with a soft, damp cloth after drying items that have been starched.
- Check the seal.
- Check the latches on the drum door, fluff compartment and service panel.
- Check the joint between the tumble dryer and heat-pump.

The air intake to the heat-pump and the ventilation openings are located at the back of the machine and on the machine lid. Under no circumstances should these vents be sealed or covered by blankets or towels. Keep the area around the heat-pump dryer – in particular the air intake – clear of fluff.

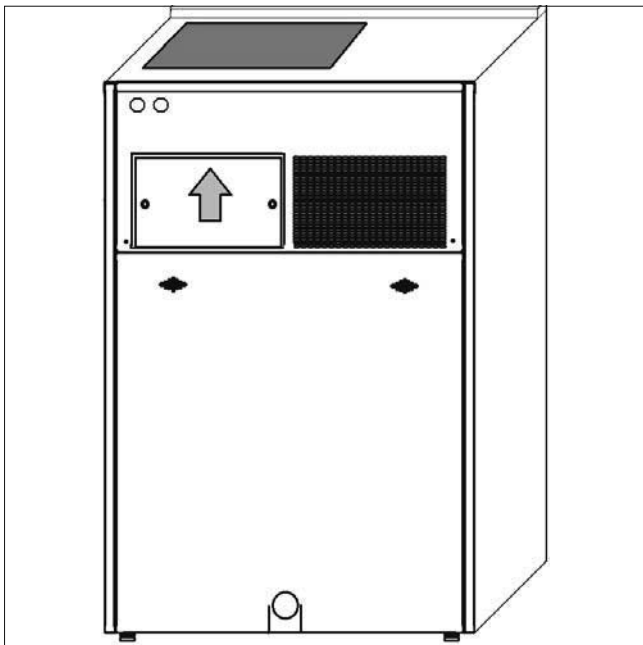

- Push the cover of the air intake vent upwards.
- Remove the cover in a forward direction.
- Clean the louvres using a brush or vacuum cleaner.
- Then re-cover the air intake vent.

Miele Service must check the interior of the tumble dryer and the impellers in the ventilation openings for fluff deposits **once per year** and clean the machine if necessary.

Heat exchanger

While the heat-pump is running, fluff, cleaning agent residue and other components contained in the steam collect in the heat exchangers. Soiling of the heat exchangers reduces heat transfer to the air and minimises the efficiency of the system. The heat exchangers must therefore be checked and cleaned at regular intervals.

A cleaning nozzle for water hoses with a $\frac{3}{4}$ " screw connection is included in the scope of delivery for the heat-pump dryer.

⚠ Water may only be used to clean the heat exchangers (behind the service panel). Other areas of the heat-pump dryer must never be cleaned with water. This poses a risk of death due to electric shock. Ensure that the tumble dryer is disconnected from the mains supply before cleaning the heat exchangers.

- Disconnect the system from the mains supply.
- Open the service panel on the back of the heat-pump.

⚠ There is a trip hazard and risk of injury when opening the service panel. Store the service panel in a safe location.

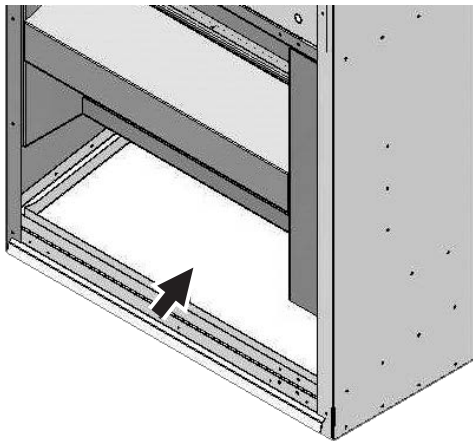

Position of the condensate tray

- Clean the condensate tray to remove coarse soiling.

This prevents the drain from becoming blocked.

⚠ Maintenance must always be conducted in a timely and professional manner. Otherwise, there is a potential risk of loss in performance, faults and fire.

Cleaning and maintenance

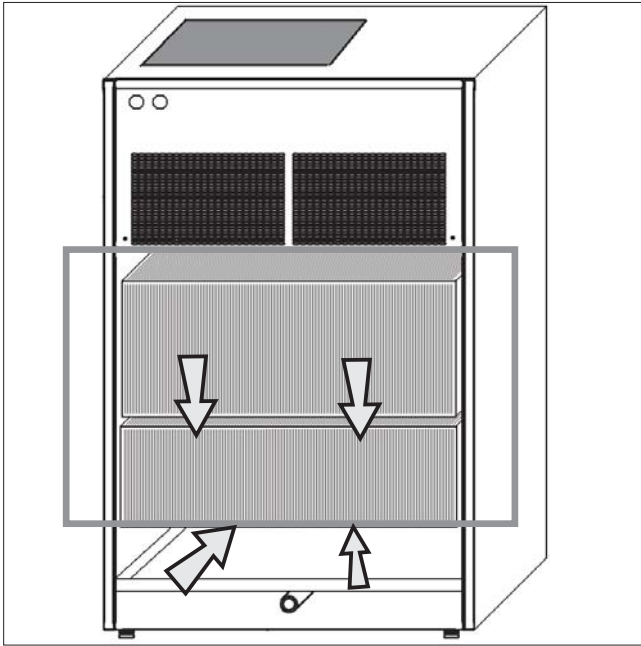

Area of the heat exchangers to be cleaned – behind the service panel (at the back of the machine)

- Using a brush, clean the heat exchangers in the area marked with arrows. Take care not to bend or damage the louvres.
- Screw the supplied cleaning nozzle onto a water hose with a $\frac{3}{4}$ " screw connection.
- Rinse out the heat exchangers thoroughly for several minutes using a hose (≤ 4 bar). Water may only enter the machine in the area of the heat exchangers marked with a grey frame (see graphic).

Pressure washers as well as detergents containing chlorine, sand, soda and acid are not permitted.

- Ensure that the cleaning water is sufficiently drained to prevent the tumble dryer or installation site from flooding.
- Remove any soiling which is not rinsed out.
- Clean the condensate tray and check the drain for blockages.
- Seal the heat exchangers with the service panel before restarting the system.
- Before switching on the power supply, ensure that no electrical parts have come into contact with the rinse water.
- To protect the louvres, avoid direct contact and wear gloves to avoid being cut.

Fault diagnosis

Message	Cause and remedy
The display remains dark.	<p>There is no power to the tumble dryer.</p> <ul style="list-style-type: none"> ■ Check the mains plug, main switch and fuses (on site).
Problem	Cause and remedy
Condensate is escaping from an unexpected location.	<p>The drain is dirty.</p> <ul style="list-style-type: none"> ■ Inspect the drain and remove any soiling if necessary. The drain can be accessed via the rear service panel in the floor area.
The efficiency of the tumble dryer decreases.	<p>The fluff filter in the tumble dryer is dirty.</p> <ul style="list-style-type: none"> ■ Check the fluff filter in the tumble dryer for soiling and clean it if necessary.
	<p>The heat exchangers in the heat-pump are dirty.</p> <ul style="list-style-type: none"> ■ Clean the heat exchangers (e.g. with a vacuum cleaner).
	<p>The connection between the tumble dryer and the heat-pump unit is leaking.</p> <ul style="list-style-type: none"> ■ Check whether the connection between the tumble dryer and the heat-pump unit is leakproof. ■ Call Service, if necessary.
	<p>Insufficient ventilation</p> <ul style="list-style-type: none"> ■ Ensure that the air intake to the heat-pump and the ventilation openings are not sealed or blocked by objects.
	<p>Room temperature too high (>45 °C)</p> <ul style="list-style-type: none"> ■ Ensure adequate ventilation of the installation site. ■ If necessary, connect the tumble dryer to external ducting with a fresh air supply.
	<p>The heat-pump dryer is designed for a room temperature of up to 40 °C. Trouble-free operation above this temperature is sometimes possible. If the temperatures are constantly above 45 °C, an external cool air supply must be provided. You can reduce the wear and tear sustained by the heat-pump dryer by ensuring that the heat exchangers are always free from fluff and other soiling.</p>
Feather-filled pillows smell after drying.	<p>Feathers tend to develop a build-up of their own smell or smells from other sources when they are heated.</p> <ul style="list-style-type: none"> ■ Smells can be reduced through natural ventilation after drying.
Items made of synthetic fibres are charged with static electricity after drying.	<p>Synthetic fibres tend to attract static charge.</p> <ul style="list-style-type: none"> ■ Static charge can be reduced by adding a fabric softener to the final rinse in the washing programme.
Fluff builds up during drying.	<p>Fluff is principally the result of friction when garments are being worn and to some extent when they are being washed. Tumble drying hardly causes any fluff to form. Fluff is collected by the fluff filter and can be removed easily.</p> <ul style="list-style-type: none"> ■ See "Cleaning and care".

Problem solving guide

Problem	Cause and remedy
The drying process goes on too long or even switches off.	You are prompted to clean the air guide area. ■ Please check all the possible causes described below.
	The fluff filter is clogged with fluff. ■ Remove the fluff.
	The air guide area is clogged with hair and fluff, for example. ■ Clean the air guide area. ■ To clean the air guide area under the door opening, remove the cover.
	The vent ducting or its openings are clogged with hair and fluff, for example. ■ Check and clean all components in the vent ducting (e.g. wall pipe, external grille, bends, elbows, etc.).
	The flow of air is insufficient (e.g. because it is installed in a small room). ■ When drying, open a door or window to ensure sufficient ventilation.
	The laundry has not been spun sufficiently. ■ Make sure that your laundry is thoroughly spun at the appropriate spin speed in the washing machine.
	The tumble dryer has been overloaded. ■ Do not exceed the maximum load size for the drying programme selected.
	Metal zips can prevent the tumble dryer from registering the correct laundry moisture content. ■ Open any zips next time. ■ If the problem occurs again, dry garments with long zips using the hot air drying programme.
Condensation is forming in the drum.	The tumble dryer is installed on a shared exhaust air duct. ■ The tumble dryer must always be installed with a non-return flap when using a combined line. ■ Check the non-return flap for possible defects on a regular basis and replace the flap if necessary.

Contact in case of malfunction

In the event of any faults which you cannot remedy yourself, please contact your Miele Dealer or Miele Service.

Contact information for Miele Service can be found at the end of this document.

Please note that telephone calls may be monitored and recorded for training purposes and that a call-out charge will be applied to service visits where the problem could have been resolved as described in this booklet.

Please quote the model and serial number of your appliance when contacting Miele. This information can be found on the data plate.

Installation requirements

The heat-pump dryer must only be installed and commissioned by a Miele Service engineer or a Miele-authorized Service dealer.

- ▶ The heat-pump dryer must be installed in accordance with all relevant regulations and applicable standards.
- ▶ This heat-pump dryer must only be operated in a room that has sufficient ventilation and which is frost-free.

General operating conditions

This heat-pump dryer is intended only for use in a commercial environment and must only be operated indoors.

Ambient temperature for optimum heat-pump operation:
+10 °C to +40 °C

The ambient temperature for the heat-pump dryer must be at least 10 °C.

At lower ambient temperatures, there is a risk of ice forming on the lower heat exchanger. This can also result in unexpected condensate formation.

Depending on the nature of the installation site, sound emissions and vibrations may occur.

Tip: Have the installation site inspected and seek the advice of a professional in instances where increased noise may cause a nuisance.

Transport

The tumble dryer and heat pump must be separated from one another before being transported. The machines may be damaged if they are transported without being separated.

The tumble dryer and the heat pump must not be transported without transport pallets.

Suitable transport aids must always be used during transportation.

Tilting the heat pump by more than 30° should be avoided if at all possible.

After the heat pump has been transported, it should be left to stand for approximately one hour before commissioning. If the heat pump is subjected to especially strong vibrations or is tilted by more than 30°, it should be left to stand for up to 24 hours.

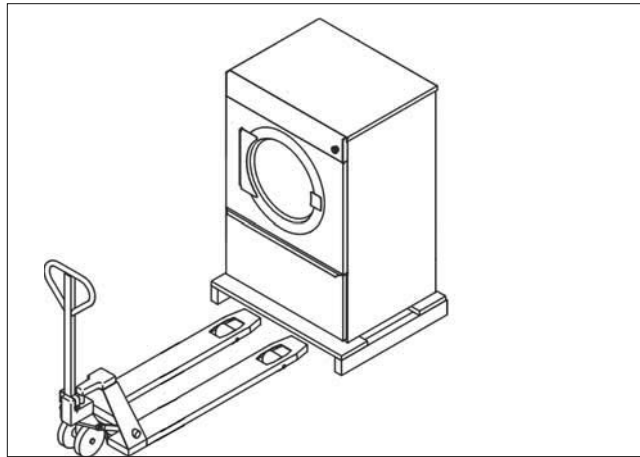

At the next installation site, the tumble dryer and the heat pump must be lifted off the transport pallet using suitable lifting gear.

Installing the heat-pump

Before the heat-pump dryer is used for the first time, the tumble dryer and heat-pump must be connected with one another. The following steps describe how to install the heat-pump on the tumble dryer:

- Firstly, set up the heat-pump at the designated installation site. When installing the heat-pump dryer, please note that the specified minimum distance from the wall of at least 500 mm must be observed.

The air intake vent and the condensate drain are found on the back of the heat-pump.

Before installation, position the heat-pump at the installation site in such a way that the air intake vent and the condensate drain are not pointing in the direction of the tumble dryer.

- Position the tumble dryer parallel in front of the heat-pump, leaving a little distance between the two. The rear of the tumble dryer must be facing the heat-pump.
- Remove the tumble dryer lid.
- Feed the electrical connection cable through the heat-pump and connect it to the tumble dryer (see Electrical connection).
- Insert the plug into the socket on the tumble dryer.

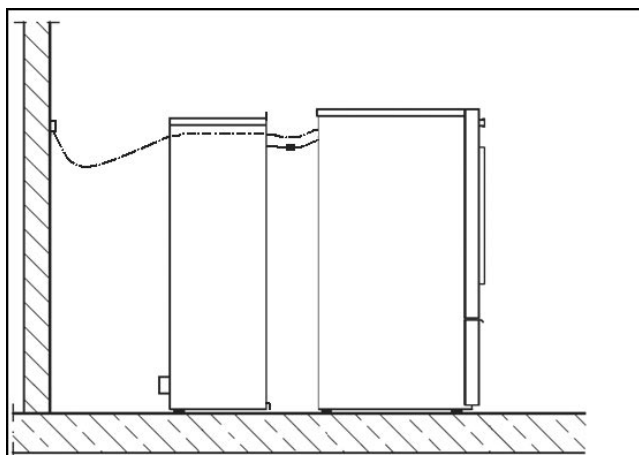

- Position the tumble dryer in front of the heat-pump air openings.
- Align the tumble dryer and heat-pump above the machine feet horizontally and parallel to one another.

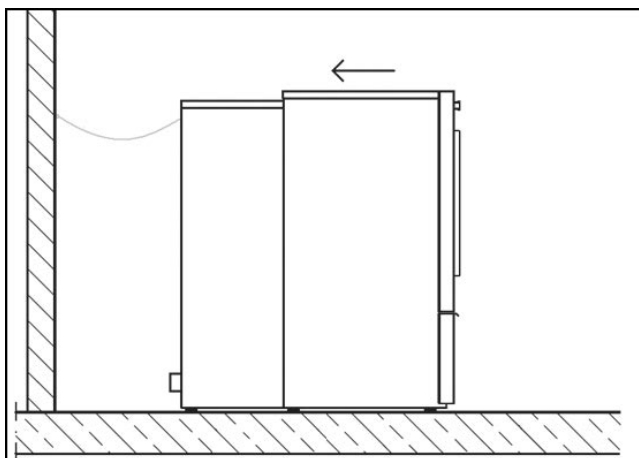

- Tilt the heat-pump backwards slightly and move the tumble dryer towards the heat-pump until the lower clamping lug on the heat-pump is above the lower bevelled edge on the tumble dryer.

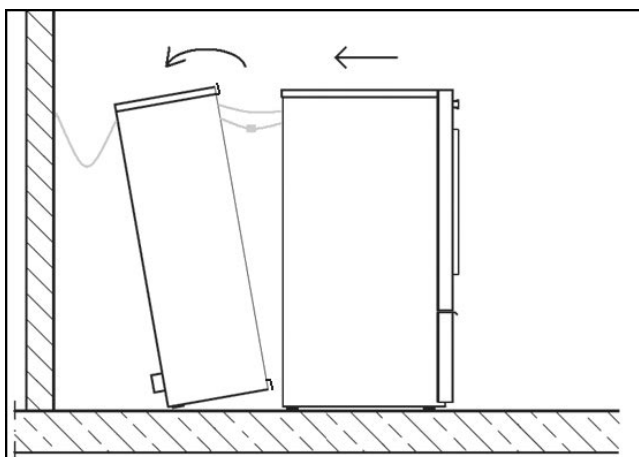

- Now carefully tilt the heat-pump forwards again so that the clamping lug hooks in behind the bevelled edge on the tumble dryer.

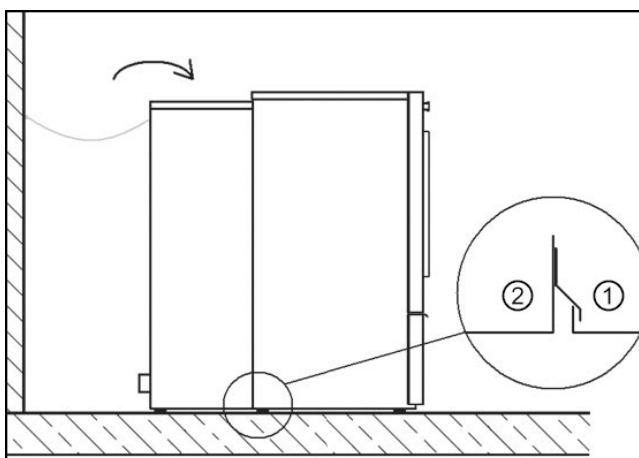

① Tumble dryer

② Heat-pump

Installation

The clamping lug connects the heat-pump to the tumble dryer. Once this step is complete, the tumble dryer should no longer be able to move away.

- Put the tumble dryer lid on top of the tumble dryer and clamp the upper clamping lug of the heat-pump beneath the tumble dryer lid.
- Then firmly screw on the tumble dryer lid.

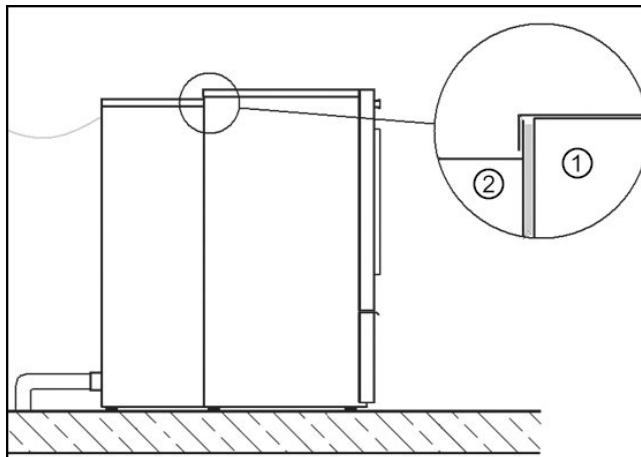

① Tumble dryer

② Heat-pump

Installation

- Place the heat-pump dryer on a totally level, secure and horizontal surface that is able to withstand the specified floor load.

The floor load created by the heat-pump dryer is concentrated and transferred to the installation footprint via the machine feet. A base is not required. However, an uneven floor surface must be compensated for.

- Place the heat-pump dryer as close as possible to a cold water connection so that you can easily clean the heat exchangers with a hose, if required (water pressure up to a maximum of 4 bar is permitted).

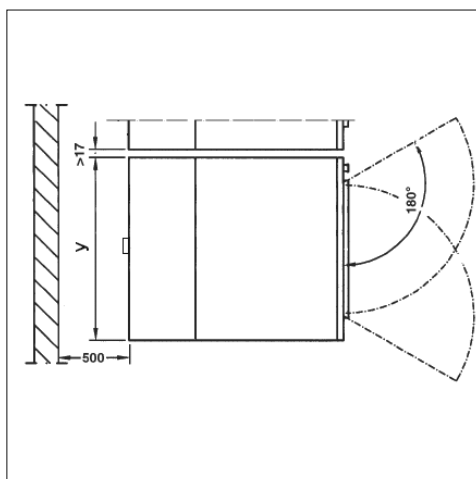

y 906 mm

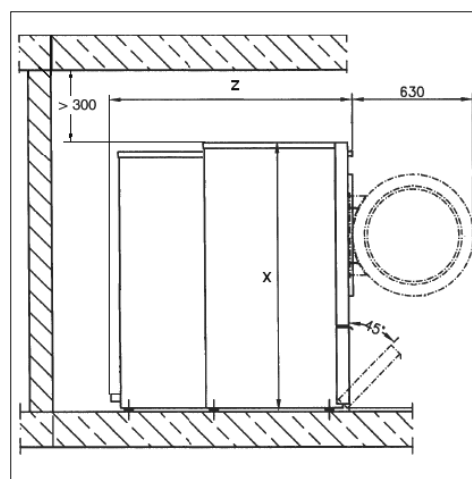

x 1400 mm

z PDR 914: 1210 mm / PDR 918:
1413 mm / PDR 922: 1522 mm

- To facilitate any future maintenance work, a maintenance corridor with a width of at least 500 mm must be set up behind the machine and must be accessible at all times. The distance between the machine and any walls must not fall below the specified minimum values.
- Adjust the heat-pump dryer screw feet until the machine is level. After the machine has been aligned, screw the washers tightly to the base plate using a screwdriver.

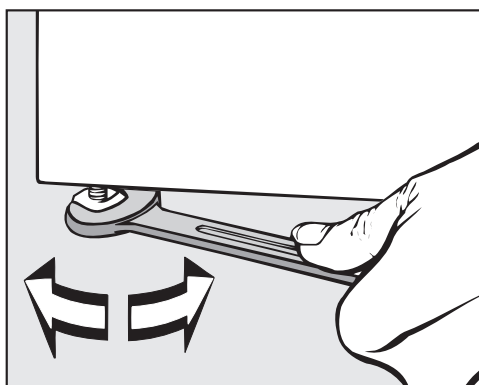

Tip: Use a spirit level to ensure correct alignment.

Installation

If the heat-pump unit is tilted **up to a maximum of 30°** during transportation, it must be left to stand for at least one hour after it has been installed before the heat-pump dryer can be operated.

If the heat-pump unit was tilted by an angle **exceeding 30°** or if it was subjected to strong vibrations, the machine must be left to stand for 24 hours before commissioning.

After transportation and installation, downtime of at least one hour is required before connecting the tumble dryer to the electricity supply.
Insufficient downtime before commissioning can damage the heat pump.

Electrical connection

 Danger caused by improper electrical connection.
There is a risk of serious damage, injury or even death if installation work is carried out incorrectly.
All electrical connection work must be carried out by a qualified electrician in accordance with local and national safety regulations.

The electrical installation must be carried out in accordance with IEC 60364-4-41 or the local regulations.

The required supply voltage, power rating and fuse rating can be found on the data plate on the tumble dryer. Ensure that the supply voltage matches the voltage quoted on the data plate before establishing the electrical connection to the tumble dryer.
Connection to a supply voltage other than the one quoted on the data plate can damage the tumble dryer if the voltage is too high.

If more than one voltage is specified on the data plate, the tumble dryer can be converted for connection to the relevant input voltage. This conversion must be performed by the Miele Customer Service Department or by an authorised dealer. During the conversion, the wiring instructions given on the wiring diagram must be followed.

It is recommended to connect the tumble dryer with a suitably rated plug and socket in accordance with IEC 60309-1, or if required it can be hard-wired. For hard wired connection, an all-pole isolation device must be available at the installation site.

An isolation device is a switch which ensures a contact opening of more than 3 mm. These include circuit breakers, fuses and contactors (IEC/EN 60947).

If the energy supply cannot be permanently disconnected, the isolation device (including plug and socket) must be safeguarded against being switched on either unintentionally or without authorisation.

Tip: We recommend connecting the tumble dryer to the power supply via a suitably rated plug and socket so that it is easier to conduct electrical safety checks (e.g. during maintenance or repair work).

► The tumble dryer must not be connected to devices such as clocks/timers which would switch it off automatically.

Limitations to dryer operation due to reconnecting/removing jumpers.

Modifying/removing jumpers at the heater elements in order to set lower heater ratings may result in limitations to dryer operation. Depending on the type of laundry, length of vent ducting, and outside temperature, the desired drying results may no longer be achieved. In the event of a reduction, the specified consumption data will no longer be achieved.

► For added safety, a type B residual current device must be connected upstream of the machine in accordance with the installation plan. Installation must be carried out on site by the operator.

⚠ Loud noises and risk of damage due to incorrect phase connection on heat-pump dryers.

An incorrect phase position causes a lot of noise in tumble dryers with heat pumps and can cause damage to the compressor.

When connecting a heat-pump dryer to the power connection, ensure the correct phase position according to the wiring diagram.

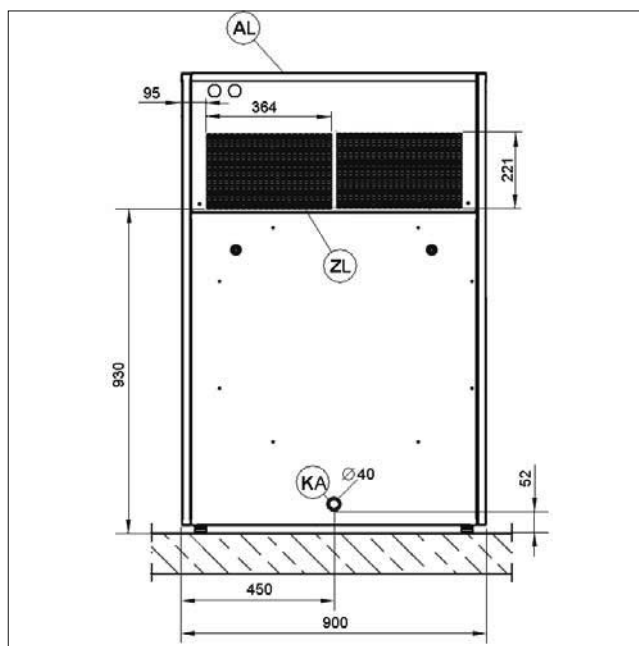

AL Extracted air (air outlet vent)

ZL Supply air (air intake vent)

KA Condensate drainage

Air intake vent

During tumble dryer operation, the installation site must constantly be supplied with sufficient cool, fresh air. If the ambient temperature frequently exceeds 45 °C, the cooling circuit in the heat-pump must be connected to external air intake and outlet vent ducting to ensure that heat-pump functionality is not impaired.

Air is supplied via the air intake vent on the rear of the heat-pump dryer. This vent must always be kept clear and must not be covered.

Installation

During operation, fluff can be drawn in through the air intake vent. Fluff sucked into the dryer will settle on the heat exchangers and impair the efficiency of the heat-pump. Keep the area (in particular the air intake to the heat-pump) as clear of fluff as possible. Clean the heat exchangers regularly.

Air outlet vent

Because the heat-pump dryer operates with a closed air circuit, separate exhaust ducting is not required.

The warm air expelled from the machine as a result of cooling down the heat-exchanger warms the room air. It is essential to ensure the room has adequate ventilation, e.g. by providing ventilation openings that cannot be closed whilst the machine is in use. Insufficient ventilation in the room increases the time required for drying, which in turn will increase the amount of energy required for the drying process.

The ventilation openings must, on no account, be closed or blocked by objects.

Condensate drainage

The heat-pump in this tumble dryer operates according to the principle of condensation. A separate floor drain must be provided in the installation room for condensate produced during the drying process.

The condensate drainage point is located at the back of the heat-pump dryer. Condensate can be fed via a downwards pointing pipe to the floor drain. It must be ensured that condensate cannot flow back into the machine.

 Risk of electric shock and injury due to using the tumble dryer without the complete casing.
If the casing is dismantled, it is possible to come into contact with live or rotating machine parts.
Once the tumble dryer has been installed, replace all the casing parts that were removed.

Optional accessories

► Accessory parts may only be fitted when expressly approved by Miele. If other parts are used, warranty, performance and product liability claims will be invalidated.

Communication box

The optional communication box allows external hardware from Miele and other suppliers to be connected to the Miele Professional machine. External hardware includes, e.g. payment system, peak-load system, pressure sensor or an external vent flap.

The communication box is supplied with mains voltage by the Miele Professional machine. The separately available set consists of the communication box and fasteners for installation on the machine or on the wall.

APCL106

The optional Miele communication module can be used to establish a data connection between a Miele Professional machine and a data processor in accordance with the Ethernet or WiFi standard.

This communication module fits into the communication slot which is a standard feature on all machines. The communication module offers the option of intelligent app-based communication with external systems (such as central smart payment terminals or payment systems). In addition, it can display detailed machine and programme status information.

This module forms the basis for wired communication with Miele MOVE.

It is not possible to integrate the machine into the “Miele@home” app for domestic installations.

The communication module is intended exclusively for commercial use and is supplied with mains voltage directly via the Miele Professional machine. No additional power connection is required. The Ethernet interface provided via the communication module complies with SELV (safety extra low voltage) requirements in accordance with EN 60950. Connected external machines must also comply with SELV.

Data protection and data security

When you activate the networking function and connect your machine to the Internet, your machine sends the following data to the Miele Cloud:

- Machine serial number
- Machine model and technical features
- Machine status
- Information about the software status of your machine

Initially, this data cannot be assigned to a specific user and is not saved permanently. Data cannot be saved permanently or assigned to a specific user until after you have linked your machine to a user. Data transmission and processing are governed by Miele's strict security standards.

Factory default settings for network configuration

You can reset all of the settings on the communication module or your integrated WiFi module to the factory default settings. The network configuration should be reset whenever a machine is being disposed of or sold, or if a used machine is being put into operation. This is the only way to ensure that all personal data has been removed and the previous owner will no longer be able to access the machine.

Copyright and licences

For the purpose of operating and controlling the communication module, Miele uses proprietary or third-party software that is not covered by open source licensing terms. This software/these software components are protected by copyright. The copyrights held by Miele and third parties must be respected.

Furthermore, this communication module contains software components which are distributed under open source licence conditions. The open source components contained in the machine along with the corresponding copyright notices, copies of the licensing terms valid at the time and any further information can be accessed locally by IP using a web browser (*https://<IP address>/Licenses*). The liability and warranty arrangements for the open source licences displayed in this location only apply in relation to the respective rights holders.

Payment systems

This tumble dryer can be fitted with a payment system (optional Miele accessory). In this case, a Miele Customer Service technician must programme the relevant settings in the tumble dryer's electronics and connect the payment system.

The Miele communication box accessory unit or the COM module is required to connect a payment device.

Technical data

Technical data

	PDR 914 HP	PDR 918 HP	PDR 922 HP
Height	1400 mm	1400 mm	1400 mm
Width	906 mm	906 mm	906 mm
Depth	1232 mm	1415 mm	1544 mm
Depth with door open	1852 mm	2055 mm	2164 mm
Net weight	156.354 kg	169.5 kg	180.2 kg
Drum volume	250 l	325 l	400 l
Maximum load size (dry weight)	14 kg	18 kg	22 kg
Supply voltage	See data plate	See data plate	See data plate
Fuse rating (on site)	See data plate	See data plate	See data plate
Power rating	See data plate	See data plate	See data plate
Test certifications awarded	See data plate	See data plate	See data plate
Max. floor load in operation	1740 N	1928 N	2092 N
Product safety standard	IEC 335-1, IEC 335-2-11, IEC 335-2-40		
Sound pressure level, EN ISO 11204	<70 dB (A)	<70 dB (A)	<70 dB (A)
Sound power level, EN ISO 9614-2	<80 dB (A)	<80 dB (A)	<80 dB (A)
Frequency range	2.4000–2.4835 GHz		
Maximum transmission power	< 100 mW		

EU declaration of conformity

Miele hereby declares that this PT 015 tumble dryer complies with Directive 2014/53/EU. The complete text of the EU declaration of conformity is available from one of the following Internet addresses:

- Under “Products”, “Download” at www.miele.de/professional/index.htm
- Or go to <http://www.miele.de/professional/gebrauchsanweisungen-177.htm> and enter the name of the product or the serial number

UK declaration of conformity

UKCA mark (UK only) The Supply of Machinery (Safety) Regulations 2008

Miele hereby declares that this tumble dryer complies with UK Radio Equipment Regulations 2017, as amended.

The complete text of the UK declaration of conformity is available from one of the following internet addresses:

- Products, Downloads from www.miele.co.uk
- For service, information, operating instructions etc: go to www.miele.co.uk and enter the name of the product or the serial number

This **Statement of Compliance** confirms this Miele product fully complies with the **Product Security and Telecommunications Infrastructure (Security Requirements for Relevant Connectable Products) Regulations 2023**.

- 1) Professional Appliance – *Tumble Dryer, commercial PT011, PT012, PT016, PT018*
- 2) Manufactured by: Miele & Cie KG, *PT013, PT014, PT015, PT017*
Carl Miele Street 29, 33332 Gutersloh Germany
Imported by and contact point: Miele Company Ltd, Fairacres, Marcham Road,
Abingdon, Oxon, OX14 ITW Great Britain
- 3) The defined support period at the time of first supply is 10 years
- 4) To report vulnerabilities and cybersecurity issues please contact: psirt@miele.com

5) Signature 

Name: **Paul Wright**

Company Position: **Head of Technical Management**

Date of signature: **19th March 2024**

Place of signature: **Abingdon, Oxfordshire**

United Kingdom

Miele Co. Ltd., Fairacres, Marcham Road
Abingdon, Oxon, OX14 1TW
Professional Sales, Tel: 0845 365 6608
E-mail: professional@miele.co.uk
Internet: www.miele.co.uk/professional

Australia

Miele Australia Pty. Ltd.
ACN 005 635 398, ABN 96 005 635 398
Level 4, 141 Camberwell Road, Hawthorn East, VIC 3123
Tel: 1300 731 411
Internet: www.miele.com.au/professional
E-mail: professional.sales@miele.com.au

China Mainland

Miele Electrical Appliances Co. Ltd.
No. 82, Shimenyi Road, JingAn District,
Shanghai, China, P.R.C, Post Code: 200040
Phone: +86 21 6157 3500, Fax: +86 21 6157 3511
E-mail: info@miele.cn, Internet: www.miele.cn

Hong Kong, China

Miele (Hong Kong) Ltd.
41/F - 4101, Manhattan Place
23 Wang Tai Road, Kowloon Bay, Hong Kong
Tel: (852) 2610 1025, Fax: (852) 3579 1404
Email: customerservices@miele.com.hk
Website: www.miele.hk

India

Miele India Pvt. Ltd.
1st Floor, Copia Corporate Suites,
Commercial Plot 9, Mathura Road, Jasola,
New Delhi - 110025
E-mail: customercare@miele.in, Website: www.miele.in

Ireland

Miele Ireland Ltd.
2024 Bianconi Ave., Citywest Business Campus,
Dublin 24
Tel: (01) 461 07 10, Fax: (01) 461 07 97
E-Mail: info@miele.ie, Internet: www.miele.ie

Malaysia

Miele Sdn Bhd
Suite 12-2, Level 12
Menara Sapura Kencana Petroleum
Solaris Dutamas No. 1, Jalan Dutamas 1
50480 Kuala Lumpur, Malaysia
Phone: +603-6209-0288
Fax: +603-6205-3768

New Zealand

Miele New Zealand Limited
IRD 98 463 631
8 College Hill
Freemans Bay, Auckland 1011, NZ
Tel: 0800 464 353
Internet: www.miele.com.au/professional
E-mail: professional.sales@miele.com.au

Singapore

Miele Pte. Ltd.
29 Media Circle, #11-04 ALICE@Mediapolis
Singapore 138565
Tel: +65 6735 1191, Fax: +65 6735 1161
E-Mail: info@miele.com.sg
Internet: www.miele.sg

South Africa

Miele (Pty) Ltd
63 Peter Place, Bryanston 2194
P.O. Box 69434, Bryanston 2021
Tel: (011) 875 9000, Fax: (011) 875 9035
E-mail: info@miele.co.za
Internet: www.miele.co.za

United Arab Emirates

Miele Appliances Ltd.
Showroom 1, Eiffel 1 Building
Sheikh Zayed Road, Umm Al Sheif
P.O. Box 114782 - Dubai
Tel. +971 4 3044 999, Fax. +971 4 3418 852
800-MIELE (64353)
E-Mail: info@miele.ae
Website: www.miele.ae



Manufacturer: Miele & Cie. KG, Carl-Miele-Straße 29, 33332 Gütersloh, Germany