

Operating Instructions Washing machine



It is **essential** to read these operating instructions before installation or use of this appliance. This prevents both personal injury and damage to the appliance.





Contents

Caring for the environment	6
Important safety instructions	7
Operating the washing machine	12
Control panel	12
Touch display and sensor buttons	12
Main menu	13
Appliance operation examples	14
Moving programs	14
Environmentally friendly washing	16
Feedback	17
EcoFeedback	17
Before using for the first time	18
Miele@home	19
1. Setting the language	20
2. Setting up Miele@home	20
3. Setting the clock format	21
4. Removing the shipping struts	21
5. Commissioning TwinDos	22
Determining the water hardness	22
6. Starting the calibration program	25
1. Preparing the laundry	26
2. Selecting a program	27
3. Selecting program settings	28
4. Loading the washing machine	30
5. Adding detergent	31
TwinDos	31
TwinDos	31
Detergent dispenser drawer	32
Using chlorine bleach	33
Adding powder detergent	33
Using detergent tablets or pods	35
CapDosing	36
6. Starting a program	38
Adding laundry during a program sequence (AddLoad)	38
7. Program end	39

Spinning	40
Program chart	42
Extra options	50
SingleWash	50
Eco	50
SoftSteam	50
Extra Gentle.....	50
Pre-wash	50
Soak	50
ExtraRinse	51
AllergoWash	51
Rinse Hold.....	51
Wash program chart – extra options	52
Program sequence	54
Changing the program sequence	57
Changing a program (child lock)	57
Interrupting a program.....	57
Cancelling a program	57
Favourite programs	58
Washing assistant	59
Timer	60
SmartStart	61
Detergent	62
Recommended Miele Detergents.....	62
General detergent recommendations.....	63
Replacing the TwinDos cartridge	64
Cleaning and care	65
Cleaning the housing and control panel.....	65
Cleaning the detergent dispensing drawer	65
Cleaning the drum (Hygiene info).....	68
TwinDos maintenance	68
Cleaning the water inlet filter	69

Contents

Problem solving guide	70
The wash program will not start	70
Fault message after a program has been interrupted	71
Fault message after the end of the program	72
Messages or faults affecting the TwinDos system	74
General problems with the washing machine	76
An unsatisfactory wash result	78
The door will not open.....	79
Opening the door in the event of a blocked drain outlet and/or power failure ...	80
Technical Service	82
Contact in the event of a fault	82
Optional accessories.....	82
Warranty	82
Installation	83
Front view	83
Rear view.....	84
Installation surface	85
Transporting the washing machine to its installation site.....	85
Removing the shipping struts	86
Installing the shipping struts	88
Levelling the machine.....	89
Unscrewing and adjusting the feet.....	89
Installing under a countertop	90
Washer-dryer stack	90
Additional installation requirements	91
Installing under a countertop	91
Setting up the cabinet	91
For closets at room height	92
Product dimensions	92
Dimensions.....	92
Installation on a plinth	93
Washer-dryer stack	93
The Miele water protection system	94
Water intake	95
Drainage	96
Fitting the elbow.....	96
Electrical connection.....	97
Technical data	98

Settings	99
Selecting settings	99
Changing a setting	99
Closing the Settings menu	99
Controls / Display 	100
Language 	100
Code	100
Memory	100
Clock display	100
Volume	101
Display Brightness	101
Temperature unit	101
“Display” off status	101
Program Sequence	102
TwinDos	102
Soiling	102
Maximum rinse level	102
Soak duration	102
Extra Gentle	102
Anti-crease	103
Bleach	103
Network	104
Miele@home	104
SmartGrid	105
Remote Control	105
RemoteUpdate	106
Appliance parameters	107
Legal Information	107
Copyrights and licenses for operator and control software	107
Copyrights and licenses for the communication module	107
Water intake	108
Installation requirements	109
Low water pressure	109
Suds cooling	109
Temperature reduction	109
Detergents and care products	110
Detergent	110
Special-purpose detergents 	111
Fabric care 	112
Additives 	112
Machine care	112

Caring for the environment

Disposal of the packaging material

The cardboard box and packaging materials protect the appliance during shipping. They have been designed to be biodegradable and recyclable.

Recycling the packaging reduces the use of raw materials in the manufacturing process and also the amount of waste.

Disposal of your old appliance

Electronic and electrical appliances contain many valuable materials. They also contain certain materials, compounds and components which were essential for the proper functioning and safe use of the equipment. These could be hazardous to your health and to the environment if disposed of with general waste or if handled incorrectly. Therefore, please do not dispose of your old appliance with general waste.



Consult with local authorities, dealers or Miele in order to dispose of and recycle electrical and electronic appliances. Miele assumes no responsibility for deleting any personal data left on the appliance being disposed. Please ensure that your old appliance is kept away from children until removal. Observe safety requirements for appliances that may tip over or pose an entrapment hazard.

Important safety instructions

Warning

In order to reduce the risk of fire, electric shock, or injuries, persons operating the appliance must adhere to the following safety precautions:

▶ It is essential to read the operating instructions before using the washing machine.

▶ GROUNDING INSTRUCTIONS

The washing machine must be grounded. Connecting the appliance to ground reduces the danger of electric shock in the event of a malfunction. The grounding is a protective conductor which provides a path of least resistance for the current. The washing machine comes complete with a power cord and plug with the corresponding protective conductor. The power cord plug must be inserted into a suitable outlet that has been installed and grounded in compliance with all applicable local codes.

▶ **WARNING:** Incorrect grounding of the appliance will run the risk of electric shock. In case of doubt, get in touch with a qualified electrician and arrange to have your cabling inspected.

▶ Do not replace or make any changes to the plug supplied. If there is no suitable socket available, a socket must be installed by a qualified electrician.

▶ Do not use a damaged washing machine.

▶ Do not expose the washing machine to outdoor weather conditions.

▶ Do not install the washing machine in an area where there is a risk of freezing conditions. Frozen hoses may burst or split, and the reliability of the electronic control unit may be impaired at temperatures below freezing point.

Important safety instructions

- ▶ Before connecting the washing machine, make sure that the connection data on the data plate (voltage and connected load) match the domestic electricity supply. If in doubt, request the connection data from a qualified electrician.
- ▶ Do not connect the washing machine to the domestic electricity supply by a multi-socket adapter, extension lead or similar. These do not guarantee the required safety of the machine (fire hazard due to the risk of overheating).
- ▶ The washing machine is not intended for maritime applications or for use in mobile units such as motor homes or aircraft. However, installation in such scenarios may be possible under certain conditions. Get in touch with Miele's Technical Service department regarding these specific requirements.
- ▶ Do not make any changes or repairs on the washing machine if this is not expressly permitted in these operating instructions.
- ▶ Only Miele is permitted to replace a damaged power cord. Miele service technicians use original power cords from Miele.
- ▶ If hot-water systems are not used for longer than two weeks, there may be a buildup of hydrogen under certain conditions. **HYDROGEN IS EXPLOSIVE.** If the hot-water systems have not been in use for longer than two weeks, allow hot water to run from all valves for several minutes before operating the washing machine. This reduces the formation of hydrogen. Refrain from smoking and keep away from naked flames while the water valves are open. The gas will be flammable during this time.
- ▶ Remove the door or destroy the door lock before disposing of the washing machine.

Important safety instructions

Use

- ▶ Children are not allowed to play with, on, or inside the washing machine. If you are operating the washing machine in the presence of children, the children must be supervised at all times.
- ▶ The temperature of the porthole glass becomes very high during washing. Danger of burning! Refrain from touching the porthole glass. You must therefore keep children away from the porthole glass during the wash cycle.
- ▶ Only use the washing machine for washing fabrics with a care label stating that they are suitable for machine washing. Other applications may be dangerous.
- ▶ Do not wash any fabrics which have been cleaned, washed, or soaked with cleaning agents containing solvents (e.g. benzine) or other flammable substances. These fabrics release vapours which can ignite or explode. Do not add these kinds of fabric to a load of washing.
- ▶ Do not use any solvents or other flammable substances or explosive materials in the washing machine. These materials can release vapours which can ignite or explode.
- ▶ Never use solvent based cleaning agents on or in the washing machine. Surfaces are damaged on contact with cleaning agents.
- ▶ Always make sure that the drum is stationary before reaching in to remove laundry. Do not touch the drum whilst it is still rotating.
- ▶ Do not make any alterations to the machine.

KEEP THESE OPERATING INSTRUCTIONS IN A SAFE PLACE

Important safety instructions

- ▶ Miele tumble dryers and Miele washing machines can be installed as a washer-dryer stack. A Miele washer-dryer connection kit is required as an optional accessory for this. Please ensure that the washer-dryer connection kit is suitable for the Miele tumble dryer and the Miele washing machine.
- ▶ If installing the machine on a Miele plinth (available as an optional accessory), please make sure you order the correct one for this washing machine.
- ▶ Should detergent enter the eyes, rinse out immediately with plenty of lukewarm water. If accidentally ingested, seek medical advice immediately. People who have sustained damage to the skin or who have sensitive skin should avoid contact with the detergent.
- ▶ Be careful when opening the door following use of the steam function. There is a danger of burning due to escaping steam and the high temperature of the surface of the drum as well as the porthole glass. Step back and wait until the steam has dissipated.
- ▶ The maximum dry laundry weight is 17.6 lb (8 kg). See the “Program chart” for the maximum recommended loads for individual programs.
- ▶ Temporary or permanent operation on an autonomous power supply system or a power supply system that is not synchronized with the grid power supply (e.g., island networks, back-up systems) is possible. A prerequisite for operation is that the power supply system complies with the specifications of EN 50160 or an equivalent local standard.

The function and operation of the protective measures provided in the domestic electrical installation and in this Miele product must also be maintained in isolated operation or in operation that is not synchronized with the grid power supply, or these measures must be replaced by equivalent measures in the installation. As described, for example, in the current version of VDE-AR-E 2510-2 or an equivalent local standard.

Important safety instructions

▶ This washing machine is supplied with a special lamp to cope with particular conditions (e.g. temperature, moisture, chemical resistance, abrasion resistance, and vibration). This special lamp must only be used for the purpose for which it is intended. It is not suitable for room lighting. Replacement lamps may only be fitted by a person authorized by Miele or by Miele Technical Service.

FCC Declaration of Conformity

▶ These devices comply with FCC Rules Part 15. This equipment has been tested and found to be in compliance with the limits for a Class B digital device, pursuant to Part 15 of the FCC Rules of Operation and is subject to the following conditions:
These devices may not cause harmful interference.
These devices must accept any interference received, including interference that may cause undesired operation.

FCC Radiation Exposure Statement

▶ This equipment complies with FCC radiation exposure limits set forth for an uncontrolled environment. This equipment should be installed and operated with minimum distance 8" (20 cm) between the radiator and your body.

Industry Canada Statement

▶ This digital apparatus does not exceed the Class B limits for Radio Noise Emissions from digital apparatus set out in the Radio Interference Regulations of the Canadian Department of Communications.

Complies with Canadian ICES-003 Class B specifications.

Operating the washing machine

Control panel

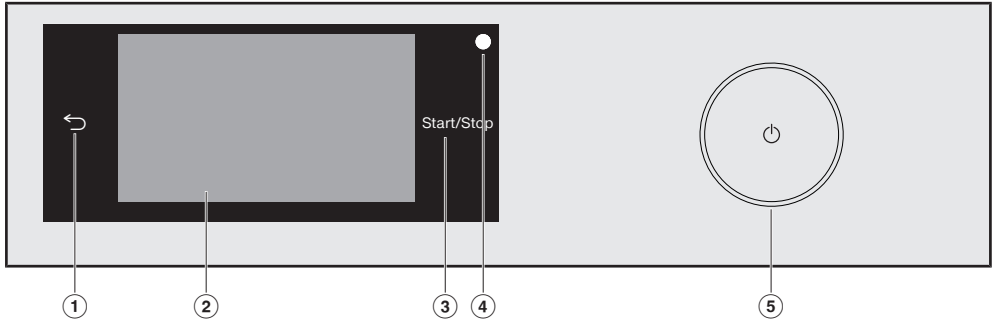

- ① **↶ sensor button**
Takes you back one level in a menu.
- ② **Touch display**
- ③ **Start/Stop sensor button**
Touching the *Start/Stop* sensor button starts the selected program or cancels a program that has already been started. The program can be started as soon as the sensor button is flashing on and off. The sensor button lights up constantly once the program has started.
- ④ **Optical interface**
This is used by the Service department as a transmission point.
- ⑤ **⏻ button**
For switching the washing machine on and off. To save energy, the washing machine will switch off automatically. This occurs 15 minutes after the end of the program / Anti-crease phase, or after being switched on if no further selection is made.

Touch display and sensor buttons

The ↶ and *Start/Stop* sensor buttons and the sensor buttons in the display react to finger tip contact.

The touch display can be scratched by pointed or sharp objects, e.g., pens. Only touch the display with your fingers.

Operating the washing machine

Main menu

After switching on the washing machine, the main menu will appear on the display.

You can access all the important sub-menus from the main menu.

Touch the  sensor button at any time to return to the main menu. Values set previously are not saved.

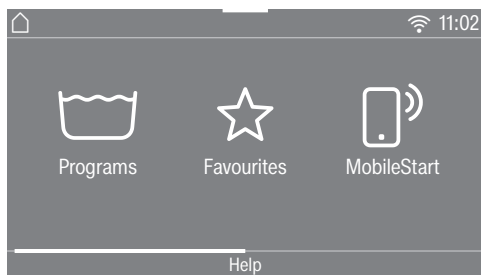

Main menu page 1

You can scroll to the second page of the main menu by swiping your finger across the display.

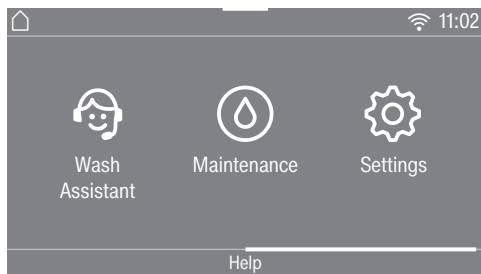

Main menu page 2

The  symbol next to the time of day is displayed when the washing machine is connected to a network.

Programs

You can select the various wash programs.

Favourites

You can save up to 12 of your own customized wash programs (see “Favourites”).

MobileStart

MobileStart enables you to operate your washing machine remotely with the Miele app.

The Remote Control setting must be switched on.

Touch the MobileStart sensor button and follow the instructions in the display.

Wash Assistant

The *Wash Assistant* provides a step-by-step guide to selecting the optimum wash program for your laundry (see “Washing assistant”).

Maintenance

Maintenance options for the TwinDos system and the Clean Machine program are located in the Maintenance menu (see “Cleaning and care”).

Settings

You can alter the washing machine’s electronics to suit changing requirements in the *Settings* menu (see “Settings”).

Operating the washing machine

Appliance operation examples

Option lists

Programs menu (single selection)

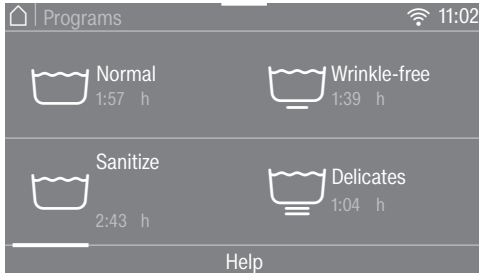

You can scroll right or left by swiping your finger across the screen. Place your finger on the touch display and swipe it in the direction you want.

The orange scroll bar under the pictures shows that there are further options to choose from.

To select a wash program, touch a program name.

The display will change to the standard menu for that program.

Options menu (multiple selection)

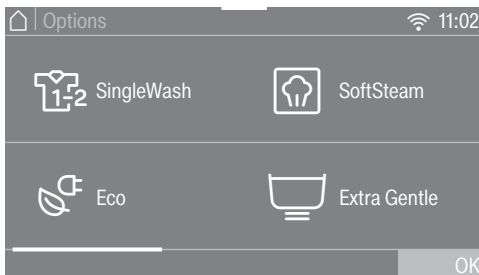

You can scroll right or left by swiping your finger across the screen. Place your finger on the touch display and swipe it in the direction you want.

The orange scroll bar under the pictures shows that there are further options to choose from.

To select *extra options*, touch one or more sensor buttons with *extra options*.

Currently selected *extra options* are marked orange.

To deselect an *extra option*, simply touch the *extra option* sensor button again.

Touch the OK sensor button to activate all selected *extra options*.

Moving programs

You can move the programs around in the menu to change the sequence in which they are displayed.

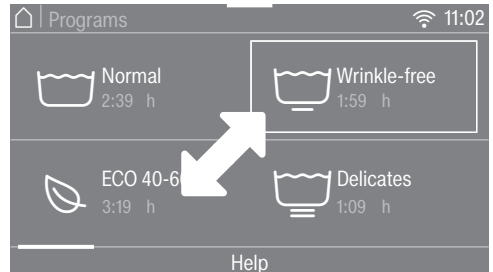

- Place your finger on the program you wish to move until a border is displayed around it.
- To move the program, swipe your finger in the required direction.
- Remove your finger when the program reaches the new location.

The program has moved.

Operating the washing machine

Setting numerical values

You can set numerical values in some menus.

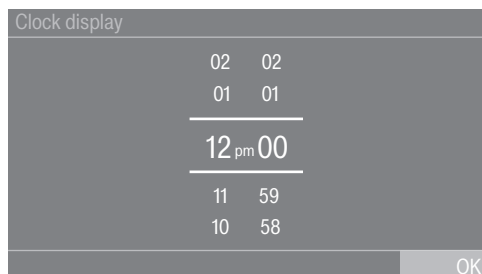

Enter the numbers by swiping up or down. Place your finger on the number that you want to change and move your finger in the direction you want. Touch the OK sensor button to accept the set numerical value.

Useful tip: Briefly touching the numbers will bring up the numerical keypad. Once a valid number has been entered, the OK sensor button will be highlighted green.

Pull-down menu

The pull-down menu can be used to display information, e.g., about a wash program.

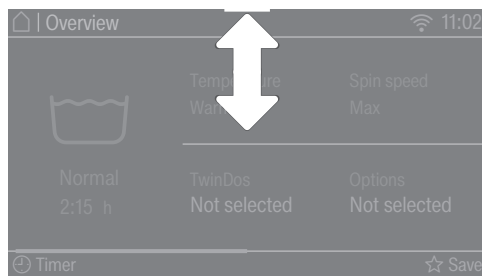

Touch the top edge of the screen in the middle and drag down with your finger.

Help display

Help appears along the bottom line of the display in the main menu and the Programs menu.

- Touch the Help sensor button to display the text.
- Touch the Close sensor button to return to the previous screen.

Exiting a menu

- Touch the ↶ sensor button to return to the previous screen.

Entries made before this which have not been confirmed with OK will not be saved.

Environmentally friendly washing

Energy and water consumption

- To get the most out of your machine, load the maximum dry load for the program you are using. The energy and water consumption will then be the lowest in relation to the size of the load.
- When smaller amounts of laundry are washed, the washing machine's automatic load recognition system will reduce the amount of water and energy used.
- Use the *Express* program for small, lightly soiled loads.
- Modern detergents make it possible to wash at lower temperatures (e.g., 20°C). Using the corresponding temperature settings will save energy.
- Washing at low temperatures and / or using liquid detergents can cause bacteria and odours to build up in the washing machine. Miele therefore recommends cleaning the washing machine once every month.

The washing machine provides you with a reminder with the message Hygiene info: select "Maintenance" and run the "Clean Machine" program in the display.

Detergent consumption

- Use the TwinDos system for exact dispensing.
- Adjust the dosage to the level of soiling of the laundry.
- Do not exceed the amounts of detergent recommended on the packaging.
- Only use highly efficient detergent with the following label:



When drying with a tumble dryer

Select the highest possible spin speed for the wash program to save energy in the subsequent tumble dryer cycle.

Environmentally friendly washing

Feedback

EcoFeedback

You can call up information about the energy and water consumption of your washing machine with the *EcoFeedback* sensor button.

The following information will appear in the display:

- an estimate of the energy and water consumption before the program begins
- the actual energy and water consumption during the program or at the end of the program

1. Estimate

The estimated energy and water consumption levels will be displayed as a bar chart on the right-hand side.

The more bars visible, the higher the energy or water consumption.

The estimate will vary depending on the wash program, temperature, and any extra options selected.

2. Actual consumption

You can view the actual amount of energy and water used by a program both during and at the end of the program.

The costs can also be displayed. See “Settings – Consumption” for more detailed information on costs.

The consumption will alter as the program progresses.

If the door is opened or the machine has switched off automatically at the end of the program, the data will revert to the estimated consumption.

Useful tip: You can view the consumption data for the last wash program and for total consumption (see “Settings – Consumption”).

Before using for the first time

 Damage from incorrect installation and connection. Installing and connecting the washing machine incorrectly will cause serious damage to property. See “Installation”.

This washing machine has undergone a complete functional test at the factory and some residual water will therefore remain in the drum from this process.

Removing the protective foil and stickers

■ Remove:

- any protective film from the door
- any stickers from the front and the lid

Please do not remove any labels (e.g. the data plate) which are visible when you open the door.

Remove the detergent cartridges and the drain hose elbow from the drum

Two detergent cartridges for automatic detergent dispensing and an elbow piece for the drain hose are stored in the drum.



- Pull open the door.
- Take the two cartridges and the elbow piece out of the drum.

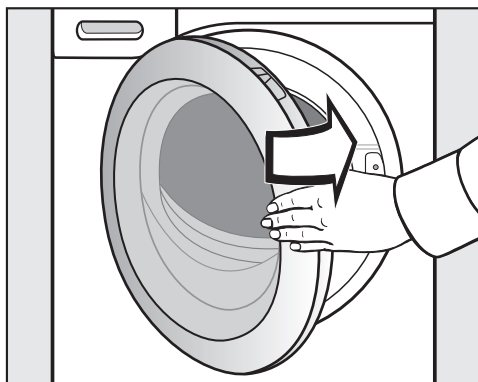

- Shut the door with a gentle swing.

Before using for the first time

Miele@home

Your washing machine is equipped with an integrated WiFi module.

To use this feature, you will need:

- A WiFi network
- The Miele@mobile app
- A Miele user account. The user account can be created via the Miele@mobile app.

The Miele@mobile app will guide you as you connect your washing machine to your home WiFi network.

Once your washing machine is connected to your WiFi network, you can use the app, for example, to carry out the following activities:

- Operate your washing machine remotely
- Access information about the operating status of your washing machine
- Access information about a program sequence on your washing machine

Connecting your washing machine to your WiFi network will increase energy consumption, even when the washing machine is switched off.

Before installing the washing machine in its final location, ensure the signal strength is sufficient for your WiFi network.

Availability of the WiFi connection

The WiFi connection shares a frequency range with other appliances (including microwave ovens and remote control toys). This may result in sporadic or even complete connection failures. Therefore, the availability of featured functions cannot always be guaranteed.

Miele@home availability

The ability to use the Miele app depends on the availability of the Miele@home service in your country.

The Miele@home service is not available in every country.

For information about availability, please visit www.miele.ca.

Miele app

The Miele App is available to download free of charge from the Apple App Store® or from the Google Play™ store.



Before using for the first time

Switching on the washing machine

- Press the  button.

The welcome screen will light up.

The display will guide you through the **6 steps** of the initial commissioning.

1. Setting the language

You will be asked to set the display language. It is possible to change the language at any time via the Settings menu.

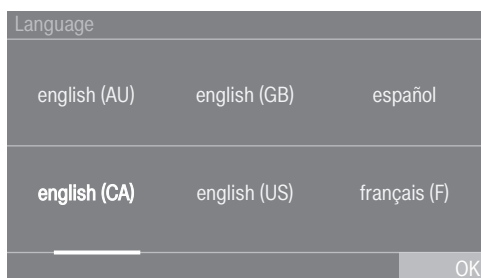

- Scroll to the left or the right until the language you want appears.
- Touch the sensor button for the language you want.

The selected language will be highlighted in orange and the display will change to the menu for setting up Miele@home.

2. Setting up Miele@home



- To set up Miele@home now: touch the **Continue** sensor button.

Useful tip: To postpone setup until later: touch the **Skip** sensor button. The following message will then appear in the display:

i It is possible to set up later in “Settings / TwinDos”.

Confirm with the **OK** sensor button.

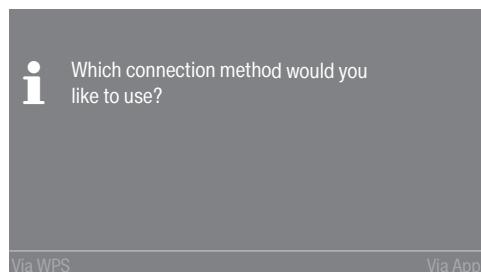

- Select the connection method you wish to use.

You will then be guided by the display and the Miele app.

3. Setting the clock format

The time of day can be displayed in 12-hour or 24-hour clock format.

- Select the clock format you want and confirm this with the OK sensor button.

The display will then bring up the screen for setting the time of day.

Setting the time

This message only appears if the washing machine has not yet been connected to a Wi-Fi network.

The time is set automatically when a connection is established with a Wi-Fi network.

Clock display

02 02

01 01

12_{pm}00

11 59

10 58

OK

- Place your finger on the number that you want to change and move your finger in the direction you want.
- Confirm with the OK sensor button.

4. Removing the shipping struts

 Damage resulting from failure to remove the transit bars.

Failure to remove the shipping struts can result in damage to the washing machine and to adjacent cabinetry or appliances.

Remove the shipping struts as described in “Installation and connection”.

- Touch the OK sensor button to confirm that the shipping struts have been removed.

The following message will then appear in the display:

 Remove shipping struts and observe the Important Safety Instructions in the Operating Instructions.

- Confirm the message with the OK sensor button.

The display will then change to the screen for setting up TwinDos.

Before using for the first time

5. Commissioning TwinDos

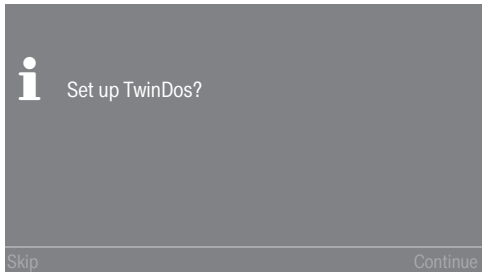

- Touch the Continue sensor button to set TwinDos up straight away.

Useful tip: To postpone setup until later: touch the Skip sensor button. The following message will then appear in the display:

i It is possible to set up later in "Settings / TwinDos".

Confirm with the OK sensor button.

Determining the water hardness

Water hardness is an indication of the amount of minerals dissolved in water. The more minerals in the water, the higher the water hardness and more detergent must be dispensed.

Useful tip: You can measure the water hardness yourself using the enclosed test strip. Alternatively, your local water authority will be able to tell you the hardness of water in your area.

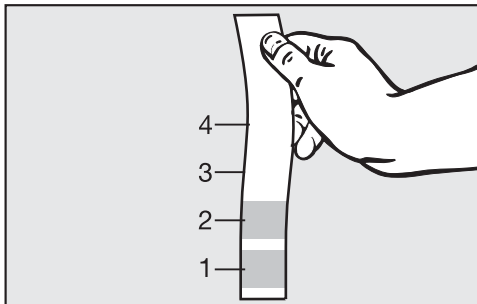

- Dip the test strip in the water for approx. 1 second. Shake excess water off the test strip.

After approx. 1 minute, and based on the coloration, you will be able to read the water hardness from the table below.

Test strip	Hardness range
4 green areas	🚰 Hardness level I
1 red area	
2 red areas	🚰 Hardness level II
3 red areas	🚰 Hardness level III
4 red areas	

Before using for the first time

Settings for compartment ①

The procedure for Miele UltraPhase 1 and Miele UltraPhase 2 is described below.

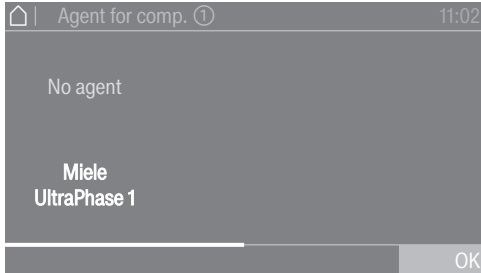

- Touch the Miele UltraPhase 1 sensor button.



The following message will then appear in the display:

i Please enter the dosing recommendation of your detergent for a wash with normal soiling. Note your water hardness level.

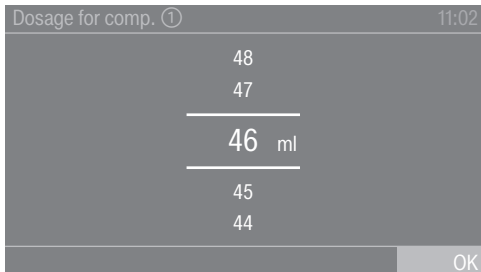
The dispensing quantity for UltraPhase 1 for  (hardness range I) is pre-set.



- Confirm the pre-set value with the OK sensor button, or change the value.

UltraPhase 1		
	Hardness level I	46 ml
	Hardness level II	58 ml
	Hardness level III	70 ml

The following will appear in the display:

i Insert container ①

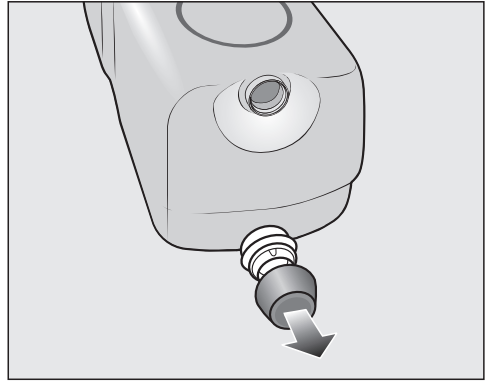

- Remove the cover cap from the **UltraPhase 1** detergent cartridge included with the delivery.

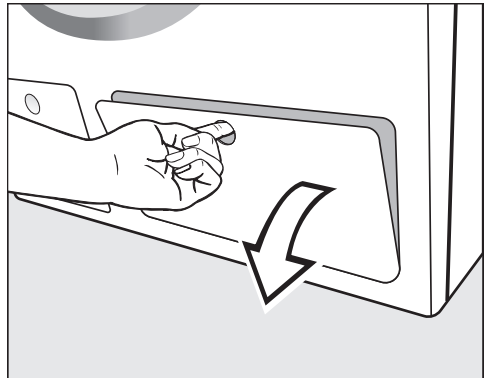

- Open the TwinDos flap.

Before using for the first time

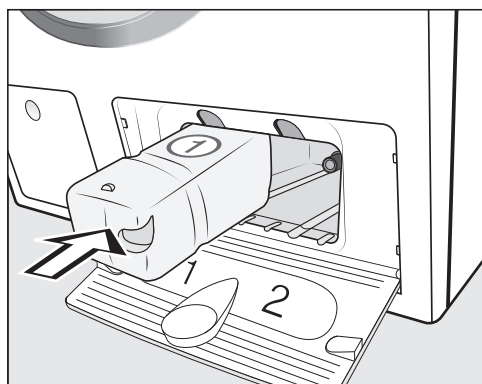

- Push the **UltraPhase 1** detergent cartridge into **compartment 1** until it locks into position.

The following message appears in the display:



- Now enter the settings for UltraPhase 2.

Settings for compartment ②

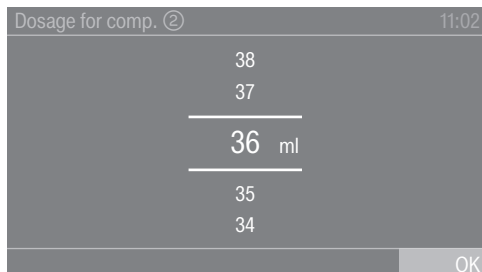
The dispensing quantity for UltraPhase 2 for  (**hardness range I**) is pre-set.



- Confirm the pre-set value with the **OK** sensor button, or change the value.

UltraPhase 2		
	Hardness level I	36 ml
	Hardness level II	45 ml
	Hardness level III	54 ml

The following will appear in the display:

- Insert container ②

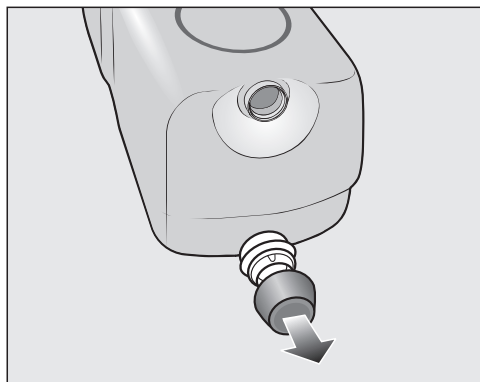

- Remove the cover cap from the **UltraPhase 2** detergent cartridge included with the delivery.

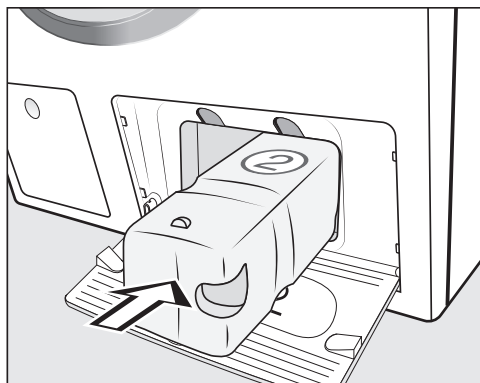

- Push the **UltraPhase 2** detergent cartridge into **compartment 2** until it locks into position.

When the cartridge is pushed in, the message in the display changes to:

- **TwinDos** is set up. Corrections can be made in "Settings / TwinDos".

- Confirm with the **OK** sensor control.
- Close the **TwinDos** flap.

The display will then change to the calibration program.

Before using for the first time

6. Starting the calibration program

For optimum water and energy consumption and excellent wash results, it is important to calibrate the washing machine.

To do this, the *Normal* program **must** be run without laundry.

No other programs can be started until calibration has been carried out.

The following message will then appear in the display:

i Open the water supply and start the Normal program with an empty drum

- Confirm with the OK sensor button.

The display will then change to the standard menu for the *Normal* program.

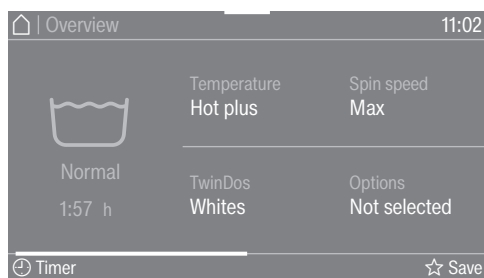

- Touch the *Start/Stop* sensor button.

The washing machine calibration program has started. It will take approximately 2 hours.

At the end of the program the following message will appear in the display:

i Setup complete

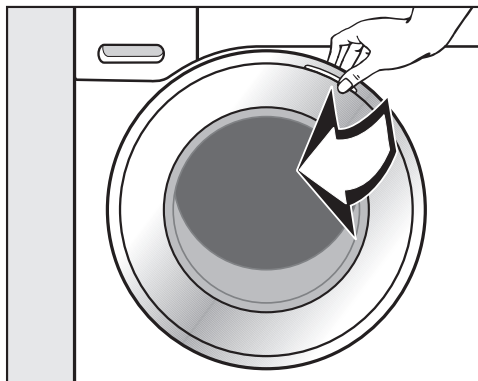

- Take hold of the door and pull it open.

Useful tip: Leave the door slightly open to allow the drum to dry.

- Switch the washing machine off with the  button.

1. Preparing the laundry

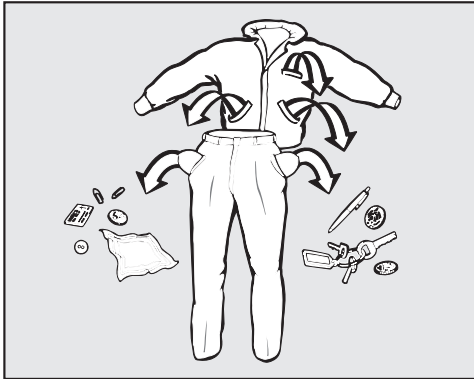

- Empty all pockets.

⚠ Damage due to foreign objects. Nails, coins, paper clips, and so on can cause damage to garments and components in the machine. Check the laundry before washing and remove any such foreign objects.

Sorting the laundry

- Sort the laundry by colour and by care label. Most garments have a fabric care label in the collar or side seam.

Useful tip: Dark fabrics often contain excess dye and should be washed separately several times before being included in a mixed load. Wash light and dark coloured items separately.

Pre-treating stains

- Badly soiled areas and stains should be cleaned as soon as possible, preferably whilst still fresh. Stains should be carefully dabbed off using a soft, colourfast cloth. Do not rub!

Useful tip: Stains (e.g. blood, egg, coffee, tea) can be pre-treated using some handy tricks which can be found in the Miele guide to laundry care. Please contact Miele directly or submit a request via Internet page to obtain or view a copy of this manual.

⚠ Damage due to solvent-based cleaning agents. Cleaning agents containing benzene, stain remover, etc., can damage plastic parts. When pre-treating a stain, make sure that plastic parts do not come into contact with cleaning agents.

⚠ Risk of explosion due to solvent-based cleaning agents. When using solvent-based cleaning agents, an explosive mixture may develop. Never use solvent-based cleaning agents in the washing machine.

General tips

- Curtains: Remove lead weights first or place in a laundry bag.
- Remove or sew in any loose underwiring in bras or shirt collar stiffeners.
- Close any zips, attach Velcro fasteners, fasten hooks and eyes etc. before washing.
- Fasten duvet covers and pillow cases to prevent small items from being rolled up inside them.

Do not wash any items in this machine which are specified by the manufacturer as **not washable** on the care label (☒ symbol).

2. Selecting a program

Switching on the washing machine

- Press the  button.

The drum lighting will come on.

The drum lighting goes out automatically after 5 minutes.

Useful tip: To switch the drum lighting on again, open the pull-down menu from the overview menu and then touch the  sensor button.

The main menu will then appear in the display.

Selecting a program

- Touch the Programs sensor button.

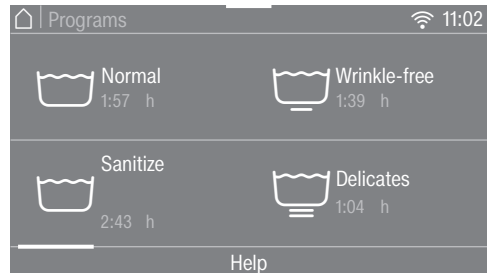

- Scroll to the right in the display until the program you want appears.
- Touch the sensor button for that program.

The display will change to the Overview menu.

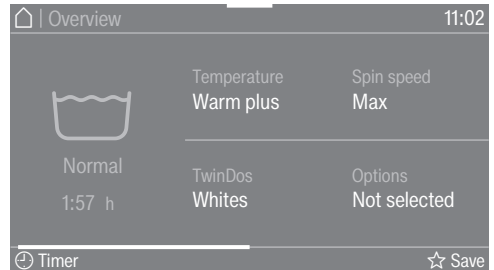

There are 3 further ways of selecting a program.

1. Favourites
2. Washing assistant
3. MobileStart

3. Selecting program settings

Selecting a temperature

You can alter the pre-set temperature of a wash program.

The temperatures reached inside the washing machine might not be the same as the temperatures selected. Perfect wash results are achieved through a combination of energy use and wash duration.

- Touch the **Temperature sensor** button.
- Select the desired temperature.

The display will change to the **Overview** menu.

Selecting a spin speed

You can alter the pre-set spin speed of a wash program.

- Touch the **Spin speed sensor** button.
- Select the spin speed you want.

The display will change to the **Overview** menu.

Activating TwinDos

TwinDos dispensing is automatically activated on all programs in which dispensing is possible.

1. Switch TwinDos on or off

- Touch the **TwinDos sensor** button and select **Off** or **On**.

2. Set the colour of the laundry

- Select **Whites** for loads of white items, or **Colours** for loads containing coloured items.

3. Select the degree of soiling

The display will ask you to enter the degree of soiling of the laundry.

- Select **Light**, **Normal**, or **Heavy**.
- Confirm your selection with the **OK sensor** button.

Automatic dispensing is switched on.

The display will change to the **Overview** menu.

See “5. Adding detergent – TwinDos” for more information.

3. Selecting program settings

Selecting extra options

You can supplement the wash programs with extra options.

- Touch the **Options** sensor button.
- Select one or more extra options.

Not all extra options can be used in combination, e.g., AllergoWash, Extra Gentle, and Extra Silent. Extras that cannot be combined are greyed out and cannot be selected.

- Confirm with the **OK** sensor button.

The display will change to the **Overview** menu.

See “Extra options” for more information.

Activating CapDosing

You can use CapDosing with this wash program.

- Touch the **CapDosing** sensor button.

The types of caps which can be used with the program will appear in the display.

- Select the type of cap you want.

CapDosing is now active.

The display will change to the **Overview** menu.

See “5. Adding detergent – CapDosing” for more information.

Selecting stains

In order to clean stained laundry more effectively, you can choose from a list of various types of stains. The wash program will then adapt to the type of stain selected.

- Touch the **Stains** sensor button.
- Select the types of stains in your load from the list.
- Confirm your selection with the **OK** sensor button.

With some stains, helpful information will also appear in the display when they are selected.

- Confirm the information with the **OK** sensor button.

The display will change to the **Overview** menu.

Timer

You can use the timer to set the finish time or the start time for a wash program.

See “Timer” for more information.

4. Loading the washing machine

Opening the door



- Take hold of the door and pull it open.

Check the drum for pets or foreign objects before loading it with laundry.

The most efficient use of energy and water consumption is achieved when a full load is washed. However, do not overload as this reduces cleaning efficiency and causes creasing.

- Unfold the laundry and load loosely into the drum.

Mixing both large and small items gives better wash results and also helps to distribute the load evenly during spinning.

Useful tip: The maximum load size for the program selected will appear in the pull-down menu.

Closing the door

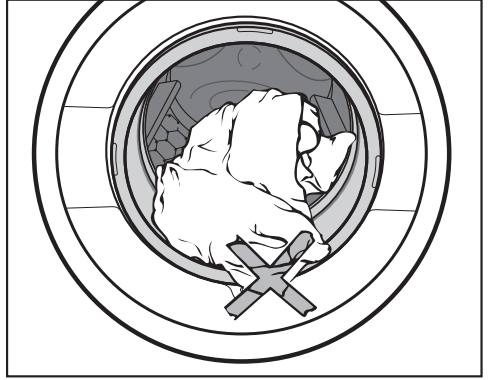

- Make sure that no items are caught between the door and the seal.

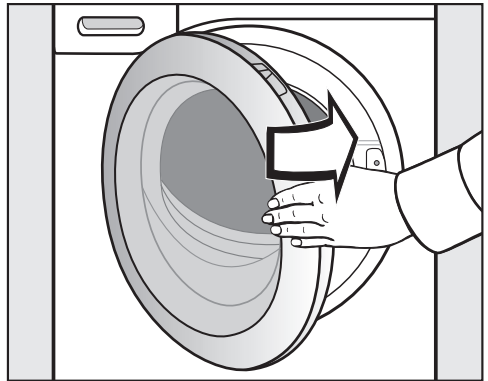

- Shut the door with a gentle swing.

5. Adding detergent

There are several options for adding detergent to the washing machine.

TwinDos

TwinDos

The washing machine is equipped with the TwinDos system.

TwinDos has to be activated as described in “Before using for the first time”.

The TwinDos system can only be operated with the Miele [UltraPhase 1](#) and [UltraPhase 2](#) Detergents.

How UltraPhase 1 and UltraPhase 2 work

UltraPhase 1 is a liquid detergent which dissolves dirt and removes the most common stains. UltraPhase 2 is a bleaching agent and removes stubborn stains. For the best washing result, these two agents are dispensed at separate times during the washing process. UltraPhase 1 and UltraPhase 2 clean white and coloured fabrics thoroughly. UltraPhase 1 and UltraPhase 2 single-use cartridges are available to order from Miele's online store or Miele Experience Centers.

Activating TwinDos dispensing

TwinDos dispensing is automatically activated on all programs in which dispensing is possible.

Useful tip: The detergent dispensing quantities are pre-set. If too much foam builds up, the dispensing quantity for UltraPhase 1 and UltraPhase 2 can be reduced via [Settings TwinDos](#).

Changing TwinDos dispensing

You can change the suggested colour composition of the laundry.

- Touch the [TwinDos](#) sensor button and select the colour composition of your laundry.

Deactivating TwinDos dispensing

- Touch the [TwinDos](#) sensor button.
- Touch the [Off](#) sensor button.

Using other methods to remove stains



If you use additional methods of stain removal, you have the following options:

- using the [Booster cap](#) and activating the [CapDosing](#)
- adding stain remover to the [U](#) compartment in the detergent dispenser drawer

5. Adding detergent

Level of soiling

The degree of soiling in laundry is divided into 3 settings:

-  Light
No visible soiling or stains
-  Normal
Visibly soiled and / or just a few slight stains
-  Heavy
Heavily soiled and / or stains clearly visible

The dispensing amount for TwinDos and the amount of water required for rinsing is pre-set for the  Normal degree of soiling.

- Touch the TwinDos sensor button to select a different degree of soiling.

The amount of detergent and water will be adjusted to suit the selected degree of soiling.

Some programs will not let you set the degree of soiling. These programs are designed for lightly soiled laundry only.

Detergent dispenser drawer

This washing machine requires particularly efficient detergent. Adhere strictly to the dispensing amounts supplied by the detergent manufacturer. The detergents must be marked with the following label:



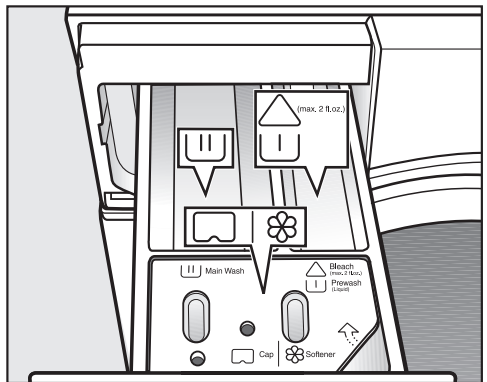

Ensure that TwinDos dispensing is deactivated.

Filling with detergent



- Pull out the detergent drawer and add detergents to the compartments.

-  Chlorine bleach for removing stains or liquid detergent for the pre-wash
-  Detergent for the main wash and soaking
-  Fabric softener, liquid starch, or capsules

5. Adding detergent

Using chlorine bleach

⚠ Damage due to chlorine bleach. Textiles may be discoloured or their fibres damaged. Only use chlorine bleach on suitable fabrics.

The “Bleach” option **must** be enabled in the settings before chlorine bleach is first used.

Chlorine bleach may be used in the following programs:

- Normal
- Sanitize
- Wrinkle-free
- Dress Shirts
- Extra White
- Table Linens/Drapes
- Baby Clothes

Dispensing chlorine bleach

Follow the manufacturer's instructions on the packaging.

The *Pre-wash* extra option **must not** be selected.

- Pour **max. 60 ml** of chlorine bleach into the $\triangle \cup$ chamber.

The chlorine bleach is added automatically 10 minutes before the end of the main wash.

Adding powder detergent

The detergent dispenser drawer contains an insert for liquid detergent in the \cup compartment as standard. This insert must be removed to use powder detergent.

It is **not possible** to use powder detergent in the $\triangle \cup$ compartment.

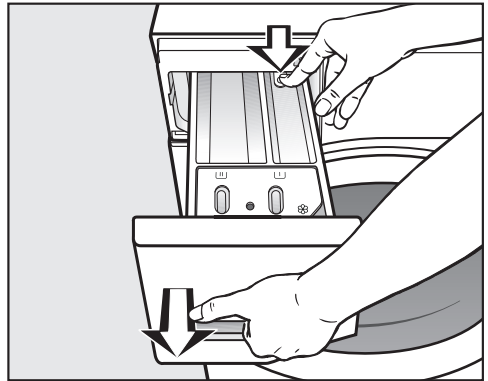

A prewash cannot be carried out when using powder detergent.

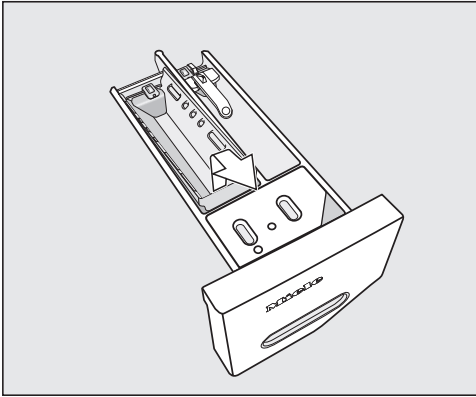

- Remove the detergent dispenser drawer.

5. Adding detergent



- Remove the insert for liquid detergents from the  compartment.
- Replace the detergent dispenser drawer.
- Add powder detergent to the  compartment.

Useful tip: Reinsert the insert into the detergent dispenser drawer before next using liquid detergent.

Useful tip: Use TwinDos dispensing if you want to run a program with the *Pre-wash* extra option.

5. Adding detergent

Adding fabric softener

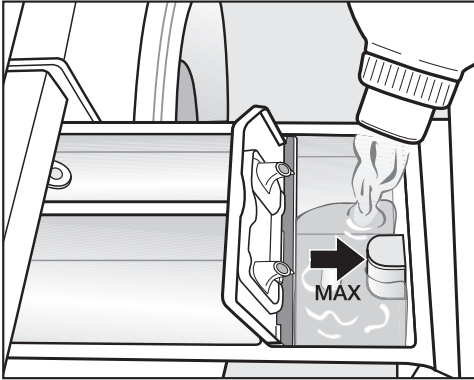

- Add the fabric softener or the liquid starch to the ☼ compartment. **Do not exceed the maximum level mark.**

It will be automatically dispensed in the final rinse cycle. At the end of the program a small amount of water remains in the ☼ compartment.

If starching frequently, clean the dispenser compartment, especially the siphon tube, regularly.

Tips for dispensing

Adjust the detergent dosage to the level of soiling of the laundry and the maximum load. Reduce the amount of detergent with smaller loads (e.g. reduce the amount of detergent by $\frac{1}{3}$ when washing a half load).

Too little detergent:

- The laundry is not cleaned properly and may become grey and hard to the touch over time.
- Can lead to a build-up of mold in the washing machine.
- Grease is not completely removed from the laundry.

- Can lead to limescale deposits on the heater elements.

Too much detergent

- Poor wash, rinse, and spin results.
- Causes higher water consumption as an extra rinse cycle is automatically activated.
- A greater burden on the environment.

Using detergent tablets or pods

Always put detergent tablets or pods directly in the drum with the laundry. They cannot be added via the detergent dispenser drawer.

See “Detergent” for further information about detergents and how much to dispense.

5. Adding detergent

CapDosing

If you selected CapDosing when setting the program, detergent will be dispensed via the cap for this wash program.

Only one cap can be selected per wash program.

3 different types of cap are available:

- ☼ = Fabric care (e.g., fabric softener, proofing agent)
- ⚗ = Additives (e.g., detergent enhancers)
- 💧 = Detergent (for the main wash only)

Depending on the setting selected, the detergent, additive, or fabric care agent will be dispensed via the cap.

Each cap contains the correct amount for one wash cycle.

Caps are available to order from Miele's online shop, Miele's customer service, or from your Miele dealer.

⚠ Capsules pose a health risk. The ingredients of capsules can be hazardous to health if they are swallowed or come into contact with skin. Keep capsules out of the reach of children.

Inserting a capsule

- Open the detergent dispenser drawer.

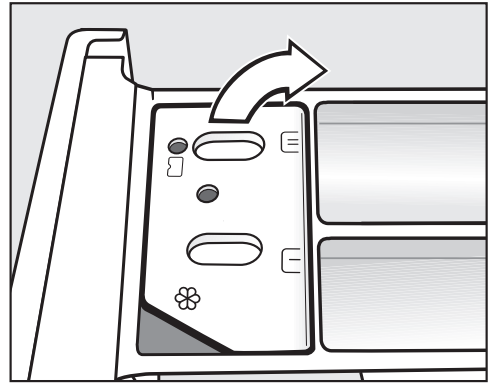

- Open the lid of the ☼/⚗ compartment.

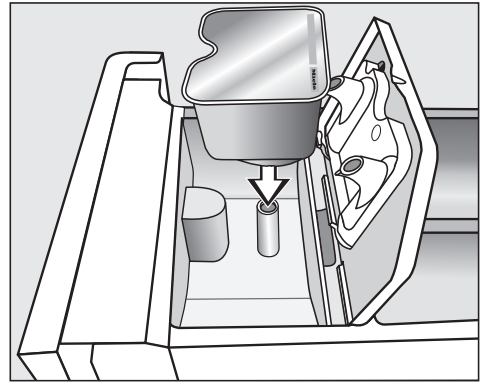

- Press the capsule in firmly.



5. Adding detergent



- Close the lid and press it firmly shut.
- Close the detergent dispenser drawer.

The capsule is opened by the act of inserting it in the detergent dispenser drawer. The contents can run out of the capsule if you then remove it from the drawer before it is used. Dispose of opened capsules.

The contents of the capsule will be added to the wash program at the correct time.

During CapDosing, water intake to the  compartment is solely via the capsule. Do not add any additional fabric softener to the  compartment.

- Remove the empty capsule at the end of the wash program.

For technical reasons, a small amount of water will remain in the capsule.

Colour run and dye removers/dyes

 Damage due to colour run/dye removers.

Colour run and dye removers can cause corrosion in the washing machine.

Do not use colour run or dye removers in this washing machine.

Dyes suitable for use in domestic washing machines can be used. However, please note that the salt used in the dyeing process can cause corrosion to stainless steel components in the machine if you use dye frequently. Always observe the dye manufacturer's instructions carefully.

6. Starting a program

Starting a program

The program can be started when the *Start/Stop* sensor button is flashing on and off.

- Touch the *Start/Stop* sensor button.

The door will lock and the wash program will start.

The program status will appear in the display.

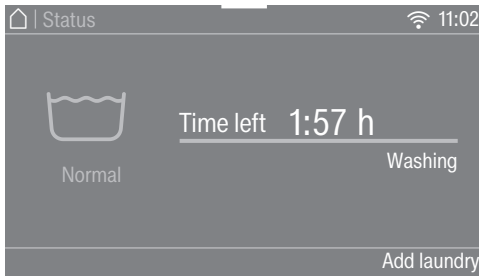

The washing machine will keep you updated on the program status and the time remaining for the program to run.

If a delay-start period has been selected, this will count down in the display until the program starts.

The drum lighting switches off once the program has started.

Energy savings

After 10 minutes, the indicators dim. The *Start/Stop* sensor button will light up, flashing.

You can reactivate the indicators:

- Touch the *Start/Stop* sensor button (this does not have any effect on a running program).

Adding laundry during a program sequence (AddLoad)

Laundry can be added or removed at any time.

- Touch the *Add laundry* sensor button.

The following appears in the display:

⋮ Please wait

The program will stop and the door will unlock.

The following appears in the display:

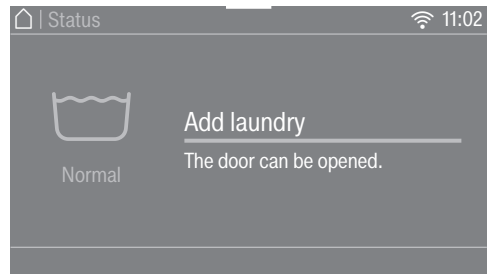

- Open the door and add or remove laundry.
- Close the door.
- Touch the *Start/Stop* sensor button.

The wash program will continue.

Laundry cannot usually be added or removed if:

- The suds temperature is above 55°C.
- The water inside the drum is above a certain level.

Items left in the drum could discolour other items in the next wash or become discoloured themselves. Remove all items from the drum.

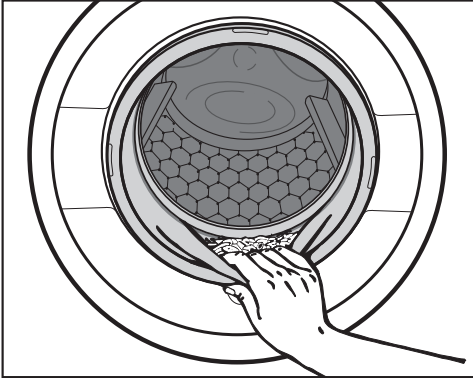

- Check the door seal for any foreign objects.

Useful tip: Leave the door slightly open to allow the drum to dry.

- Switch the washing machine off with the  button.
- If applicable, remove the used cap from the detergent dispenser drawer.

Useful tip: Leave the detergent dispenser drawer slightly open to allow it to dry.

Spinning

Final spin speed

Program	Selectable spin speeds in words and numbers				
	Max 1,600 rpm	High 1,200 rpm	Med 800 rpm	Slow 600 rpm	No Spin 0 rpm
Normal	✓	-	-	-	X
Sanitize	✓	X	-	-	X
Wrinkle-free	-	✓	X	X	X
Delicates	-	-	✓	X	X
QuickIntenseWash	✓	X	X	X	X
Express	-	✓	X	X	X
Handwash	-	✓	X	X	X
Towels	✓	X	X	X	X
Extra White	✓	X	-	-	X
Dress Shirts	-	-	✓	X	-
Denim/Jeans	-	✓	X	X	X
Darks	-	✓	X	X	X
Woolens 🐏	-	✓	X	X	X
Silks 🐏	-	-	-	✓	X
Outdoor	-	-	✓	X	X
Proofing	-	X	✓	X	X
Sportswear	-	✓	X	X	X
Sneakers	-	-	-	✓	X
Downs	-	✓	X	X	X
Pillows	-	✓	X	X	X
Table Linens/Drapes	-	✓	X	X	X
Curtains	-	-	-	✓	X
Baby Clothes	✓	X	X	X	X
Drain/Spin	✓	X	X	X	X
Quick Rinse	X	✓	X	X	X
Starch	✓	X	X	X	X
Clean Machine	-	-	-	✓	-

✓ = Optimum spin speed for program is pre-set

X = Can be selected

- = Cannot be selected

Final spin speed in the wash program

When a program is selected, the optimum spin speed for the wash program is always shown in the display.

A faster spin speed can be selected for certain wash programs.

The highest selectable spin speed is indicated in the table.

Omitting the final spin (Rinse hold)

- Select the *Rinse hold* extra option.

If Rinse hold is selected, the laundry remains in the water following the final rinse cycle. This helps prevent creasing if the laundry is not going to be removed from the washing machine immediately after the end of the program.

Ending a program with a spin cycle

The wash program is set to the optimum spin speed. You can change the spin speed.

- Touch the *Change spin speed* sensor button.
- Select the spin speed you want.
- Touch the *Start/Stop* sensor button to start the final spin.

Ending a program without a spin cycle

- Touch the *Change spin speed* sensor button.
- Select spin speed 0 rpm (no spin).
- Touch the *Start/Stop* sensor button.

Rinse-spin

There is a spin cycle after the main wash and between the rinse cycles. A reduction in the final spin speed will also reduce the interim spin speed as appropriate.

Deselecting the rinse-spin and final spin









- Touch the *Spin speed* sensor button.
- Select the 0 rpm setting.

After the last rinse cycle, the water will be pumped away and the Anti-crease phase will switch on.











An Extra Rinse cycle is carried out with this setting for certain wash programs.

Program chart















The temperature marked with ✓ is pre-set.

Temperature with garment care label symbols			Item/Tip
Normal			Full load (17.6 lb / 8 kg)
Hot plus	140°F / 60°C		Cotton, linen, and mixed fibre fabrics made of both cotton and linen.
Hot	120°F / 50°C		
Warm plus ✓	105°F / 40°C		
Warm	85°F / 30°C		
Cold	Cold		
USA test program in accordance with: DOE Federal Register 10 CFR Part 430 Appendix J2 to subpart B Canada test program in accordance with: CAN/CSA-C360-13			
Sanitize			Full load (17.6 lb / 8 kg)
Sanitize ✓	170°F / 75°C		Cotton or linen fabrics with direct skin contact or for which special hygiene requirements apply.
Wrinkle-free			Half load (8.8 lb / 4 kg)
Hot plus	140°F / 60°C		Synthetic or mixed fibre fabric, or wrinkle-free cotton.
Hot	120°F / 50°C		
Warm plus ✓	105°F / 40°C		
Warm	85°F / 30°C		
Cold	Cold		











Program chart

Temperature with garment care label symbols			Item/Tip
Delicates			Small load (6.6 lb / 3 kg)
Hot plus	140°F / 60°C		For delicate fabrics made from synthetic fibres.
Hot	120°F / 50°C		
Warm plus ✓	105°F / 40°C		
Warm	85°F / 30°C		
Cold	Cold		
QuickIntenseWash			Full load (11 lb / 5 kg)
Hot plus	140°F / 60°C		For lightly or moderately soiled fabrics which are also suitable for washing in the <i>Normal</i> program. A special wetting process and wash rhythm ensure that the laundry is cleaned particularly quickly and thoroughly.
Warm plus ✓	105°F / 40°C		
Express			Half load (7.7 lb / 3.5 kg)
Warm plus	105°F / 40°C		Cotton fabrics that have hardly been worn or are only very lightly soiled. Selecting the  Light level of soiling will reduce the washing time by 10 minutes.
Warm ✓	85°F / 30°C		
Cold	Cold		
Handwash			Small load (4.4 lb/2 kg)
Warm plus ✓	105 °F/40 °C		For delicate fabrics which are only suitable for hand washing.
Warm	85 °F/30 °C		
Cold	Cold		





Program chart

Temperature with garment care label symbols			Item/Tip
Towels			Full load (11 lb / 5 kg)
Hot plus	140°F / 60°C		For linen or cotton towels used for personal hygiene.
Hot	120°F / 50°C		
Warm plus ✓	105°F / 40°C		
Warm	85°F / 30°C		
Cold	Cold		
Extra White			Full load (17.6 lb / 8 kg)
Hot plus ✓	140°F / 60°C		For white fabrics made of cotton or linen without special hygiene requirements.
Dress Shirts			Small load (4.4 lb / 2 kg)
Hot plus	140°F / 60°C		Pre-treat collars and cuffs depending on the level of soiling.
Hot	120°F / 50°C		
Warm plus ✓	105°F / 40°C		Wash silk shirts and blouses in the <i>Silks</i>  program.
Warm	85°F / 30°C		
Cold	Cold		
Denim/Jeans			Small load (4.4 lb / 2 kg)
Hot plus	140 °F/60 °C		Textiles made from denim. - Wash inside out. - Denim often contains excess dye and may run during the first few washes. Therefore, wash light and coloured items separately.
Hot	120 °F/50 °C		
Warm plus ✓	105°F / 40°C		
Warm	85°F / 30°C		
Cold	Cold		













Program chart

Temperature with garment care label symbols			Item/Tip
Darks			Small load (4.4 lb / 2 kg)
Hot plus	140 °F/60 °C		- Wash inside out.
Hot	120 °F/50 °C		
Warm plus ✓	105°F / 40°C		
Warm	85°F / 30°C		
Cold	Cold		
Woolens 			Small load (4.4 lb / 2 kg)
Warm ✓	85°F / 30°C		Wool or wool-blend fabrics.
Cold	Cold		Reduce the final spin speed for items which crease easily.
Silks 			Very small load (2.2 lb / 1 kg)
Warm ✓	85°F / 30°C		Silks and other hand-washable fabrics with no wool content. Place tights, bras, etc., in a washing bag.
Cold	Cold		
Outdoor			Small load (5.5 lb / 2.5 kg)
Warm plus ✓	105°F / 40°C		Performance outerwear (e.g., jackets and trousers) made from membrane fabric such as Gore-Tex®, SYMPATEX®, WINDSTOPPER®, etc. - Zip up or close any jackets with Velcro before washing. - Do not use fabric softener. - If required, outerwear can be re-proofed in the <i>Proofing</i> program. Proofing after each wash cycle is not recommended.
Warm	85°F / 30°C		
Cold	Cold		







Program chart

Temperature with garment care label symbols		Item/Tip	
Proofing		Small load (5.5 lb / 2.5 kg)	
Warm plus	✓ 105°F / 40°C		Treating microfibre fabric, ski wear, or table linens made from mainly synthetic fibres to provide a finish which is resistant to water and dirt. <ul style="list-style-type: none"> - The items should be freshly laundered and spun or dried before proofing. - For best results, the items should be heat-treated afterwards. This can be achieved by drying them in the tumble dryer or ironing them.
Sportswear		Half load (6.6 lb / 3 kg)	
Hot plus	140°F / 60°C		Sportswear such as jerseys and leggings, as well as microfibre and fleece garments. <ul style="list-style-type: none"> - Do not use fabric softener. - Observe the instructions on the wash care label.
Hot	120°F / 50°C		
Warm plus	✓ 105°F / 40°C		
Warm	85°F / 30°C		
Cold	Cold		
Sneakers		Max. 2 pairs of shoes	
Warm plus	105°F / 40°C		Sport shoes only (not leather shoes) <ul style="list-style-type: none"> - Brush coarse soiling off before washing. - Do not use fabric softener. - Observe the instructions on the wash care label. - Close Velcro fasteners. - Use the dryer basket for tumble drying.
Warm	✓ 85°F / 30°C		
Cold	Cold		

Program chart

Temperature with garment care label symbols			Item/Tip
Downs			Small load (4.4 lb / 2 kg)
Hot plus	140°F / 60°C		Jackets, sleeping bags, pillows, and other down-filled items. - Remove air from the laundry before washing to prevent an excessive build-up of foam. To do this, either push the items into a narrow laundry bag to compress them or tie the items together with a washable strap. - Observe the instructions on the wash care label.
Hot	120°F / 50°C		
Warm plus ✓	105°F / 40°C		
Warm	85°F / 30°C		
Cold	65°F / 15°C		
Pillows			2 pillows (40 x 80 cm) or 1 pillow (80 x 80 cm)
Hot plus	140°F / 60°C		Washable pillows with synthetic filling - Remove air from the laundry before washing to prevent an excessive build-up of foam. To do this, either push the items into a narrow laundry bag to compress them or tie the items together with a washable strap. - Observe the instructions on the wash care label.
Hot	120°F / 50°C		
Warm plus ✓	105°F / 40°C		
Warm	85°F / 30°C		
Cold	65°F / 15°C		
Table Linens/Drapes			Full load (13.2 lb / 6 kg)
Hot plus	140°F / 60°C		Table linens and drapes made of cotton and linen.
Hot	120°F / 50°C		
Warm plus ✓	105°F / 40°C		
Warm	85°F / 30°C		
Cold	Cold		

Program chart

Temperature with garment care label symbols			Item/Tip
Curtains			Small load (4.4 lb / 2 kg)
Warm plus	105°F / 40°C		Curtains made from synthetic fibers which have been specified as machine-washable by the manufacturer <ul style="list-style-type: none"> - To remove dust, the <i>Prewash</i> extra option is selected automatically. - For curtains which crease easily, reduce the spin speed or deselect the spin. - Remove weights from curtains
Warm	✓ 85°F / 30°C		
Cold	Cold		
Baby Clothes			Full load (13.2 lb / 6 kg)
Hot plus	✓ 140°F / 60°C		Baby clothes, baby towels, bath gowns, towelling items, bibs made from cotton.
Hot	120°F / 50°C		
Warm plus	105°F / 40°C		
Warm	85°F / 30°C		
Cold	Cold		
Drain/Spin			Full load (17.6 lb / 8 kg)
			<ul style="list-style-type: none"> - Drain only: set spin speed to No Spin. - Make sure you select the appropriate spin speed.
Quick Rinse			Full load (17.6 lb / 8 kg)
			For rinsing hand-washed items. Reduce the final spin speed for fabric that creases easily.
Starch			Full load (17.6 lb / 8 kg)
			Table cloths, napkins, and workwear requiring starching. <ul style="list-style-type: none"> - Reduce the final spin speed for fabric that creases easily. - Laundry that is to be starched should be washed but not treated with fabric softener.

Maintenance

The washing machine has two maintenance programs.

1. Clean Machine for cleaning the washing machine.
2. Clean TwinDos for maintenance of the TwinDos compartments ① / ②. See “Cleaning and care – TwinDos maintenance” for more details.

Temperature with garment care label symbols		Item/Tip
Clean Machine		Without load
Sanitize ✓	170 °F/75 °C	<p>With frequent washing at low temperatures there is a danger of a build-up of bacteria in the washing machine.</p> <p>Cleaning the washing machine will significantly reduce bacteria, mold, and biofilm and prevent the build-up of unpleasant odours.</p> <ul style="list-style-type: none"> - Optimum results can be achieved by using Miele Machine Cleaner. Alternatively, a multi-purpose powder detergent can be used. - Dispense the machine cleaner or multi-purpose detergent directly into the drum. - Do not load any laundry. The drum must be empty for the Clean Machine program.

Extra options

You can supplement the wash programs with extra options.

SingleWash

For efficiently washing a very small load (< 2.2 lb/1 kg) in a normal wash program. The wash duration is reduced.

Please note!





When adding detergent manually, only use liquid detergent and use the proper amount. Use a maximum of 50 % of the specified amount of detergent for a ½ load. Chlorination is **not** possible.

Eco

The *Eco* extra option helps to save energy. The wash temperature is reduced and the wash duration is increased in return. The wash program continues to provide a deep clean.

SoftSteam

In order to reduce creasing, the laundry undergoes a smoothing process at the end of the program. Reducing the maximum load by 50% will give a better result. Please note the load information in the display. Small loads give a better result.

The garments must be suitable for drying in a tumble dryer   and suitable for ironing  .

Extra Gentle





Drum rotation and wash duration are reduced. Lightly soiled fabrics are washed more gently.

Pre-wash

For laundry with large amounts of dirt, e.g. dust and sand.

Pre-wash and chlorination is **not** possible.

The chlorine bleach is added too early.

Only liquid detergent may be added to the   chamber of the detergent dispenser drawer. Powder detergent clogs up the   chamber and water can escape from the detergent dispenser drawer.

Soak

For heavily soiled fabrics with protein stains.

A soak duration of between 30 minutes and 6 hours in 30-minute increments can be selected for the soak process. See “Settings” for more information.





The factory default setting is 30 minutes.

ExtraRinse

An extra rinse can be activated to achieve a better wash result.

AllergoWash

This option should be used where high standards of hygiene are required.

Energy consumption is increased to lengthen temperature holding times and water consumption is increased to improve rinsing efficiency. The items must be suitable for drying in a tumble dryer   and suitable for ironing  .

Rinse Hold

The laundry is not spun after the final rinse and remains in the rinse water. This helps prevent creasing if the laundry is not going to be removed from the washing machine immediately after the end of the program.

Not all the extra options can be used with every program. If an extra option is not permitted for a wash program, it will not be shown in the display. See “Wash program overview – extra options”.

Wash program chart – extra options

	SingleWash	Eco	SoftSteam	Gentle
Normal	●	●	—	●
Sanitize	●	●	●	●
Wrinkle-free	●	●	●	●
Delicates	●	●	●	●
QuickIntenseWash	●	—	●	—
Express	—	—	—	—
Handwash	●	—	—	—
Towels	—	●	—	—
Extra White	●	●	●	●
Dress Shirts	●	●	✓	●
Denim/Jeans	●	●	●	●
Darks	●	●	●	●
Woolens 🧶	●	—	—	—
Silks 🧶	●	—	—	—
Outdoor	—	●	—	—
Proofing	—	—	—	—
Sportswear	●	●	●	—
Sneakers	—	—	—	—
Downs	—	●	—	—
Pillows	—	●	—	—
Table Linens/Drapes	●	●	●	●
Curtains	—	●	●	●
Baby Clothes	●	●	●	●
Drain/Spin	—	—	—	—
Quick Rinse	—	—	●	—
Starch	—	—	—	—

Wash program chart – extra options

Pre-wash	Soak	ExtraRinse	AllergoWash	Rinse Hold
●	●	●	●	●
●	●	●	●	●
●	●	●	●	●
●	●	●	●	●
-	-	-	-	●
-	-	-	-	●
-	-	-	-	●
●	-	●	-	●
●	●	●	●	●
●	●	●	●	●
●	●	●	●	●
●	●	●	●	●
●	●	●	●	●
-	-	-	-	●
-	-	-	-	●
●	●	●	-	●
-	-	-	-	●
●	●	●	●	●
-	-	-	-	●
●	-	●	●	●
●	-	●	●	●
●	●	●	●	●
✓	-	●	●	●
●	●	●	●	●
-	-	-	-	-
-	-	-	-	●
-	-	-	-	●

● = Can be selected

✓ = Activated automatically

- = Cannot be selected

Program sequence

	Main wash		Rinses		Spinning
	Water level	Wash rhythm	Water level	Rinses	
Normal		Ⓐ		2-3 ^{1,2}	✓
Sanitize		Ⓐ		3-4 ^{1,2}	✓
Wrinkle-free		Ⓑ		2-4 ^{1,2}	✓
Delicates		Ⓒ		2-4 ^{1,2}	✓
QuickIntenseWash		Ⓐ		2	✓
Express		Ⓐ		2	✓
Handwash		Ⓔ		2	✓
Towels		Ⓐ		2-5 ^{1,2}	✓
Extra White		Ⓐ		2-5 ^{1,2}	✓
Dress Shirts		Ⓒ		3-4 ²	✓
Denim/Jeans		Ⓑ		2-4 ^{1,2}	✓
Darks		Ⓑ		3-5 ^{1,2}	✓
Woolens 		Ⓔ		2	✓
Silks 		Ⓔ		2	✓
Outdoor		Ⓒ		3-4 ²	✓
Proofing	–	Ⓑ		1	✓
Sportswear		Ⓒ		2-3 ²	✓
Sneakers		Ⓓ		2	✓
Downs ³		Ⓒ		3-4 ²	✓
Pillows ³		Ⓒ		3-4 ²	✓
Table Linens/Drapes		Ⓐ		2-3 ^{1,2}	✓
Curtains		Ⓒ		3-4 ²	✓
Baby Clothes		Ⓐ		2-3 ^{1,2}	✓
Drain/Spin	–	–	–	–	✓
Quick Rinse	–	–		2	✓
Starch		Ⓑ	–	–	✓

Please see the next page for a description of the symbols.

 = low water level

 = medium water level

 = high water level

Ⓐ = intensive rhythm

Ⓑ = normal rhythm

Ⓒ = sensitive rhythm

Ⓓ = ultra sensitive rhythm

Ⓔ = handwash rhythm

✓ = carried out

- = not carried out



This washing machine has fully electronic controls with automatic load control. The washing machine takes in the right amount of water required for the program depending on the amount of laundry and its absorbency rate.

The program sequences outlined in the chart are based on the basic program with a full load.

Special features in the programme sequence

Anti-crease:

At the end of the programme the drum continues to turn at intervals for up to 30 minutes to help prevent creasing.

Exception: There is no anti-crease phase in the *Normal*, *Woolens* , *Silks*  and *Handwash* programs.

The door can be opened at any time during the anti-crease phase.

¹ An additional rinse is carried out if:

- there is too much foam in the drum
- a spin speed lower than *Medium* (800 rpm) has been selected.

² An additional rinse is carried out if the *ExtraRinse Extra* has been selected.

- #### ³ Run-up to spin: A run-up to spin is carried out before the wash process begins to deflate down-filled items. Subsequent water intake for the main wash is through compartment .

Program sequence

PowerWash

PowerWash is a washing technique developed by Miele. It is activated in the following programs:

- Normal (with small and medium load sizes)
- Wrinkle-free
- Dress Shirts
- Delicates

How it works

Conventional washing techniques wash with more water than the laundry can absorb. This total volume of water needs to be heated.

The PowerWash washing technique only uses slightly more water than the laundry can absorb. The water which has not been absorbed by the laundry heats up the drum and the laundry and is sprayed into the laundry over and over again. This reduces energy consumption.

Activation

PowerWash is activated **automatically** in the programmes listed above.

PowerWash is deactivated if:

- CapDosing (☹, ☹) has been selected for the main wash
- Extras such as *Pre-wash* or *ExtraRinse* have been selected
- The selected final spin speed No Spin has been selected
- A large load is being washed in the *Normal* program

Special features

- Drenching phase

The washing machine will spin a few times at the beginning of the program. During spinning, the water discharged is sprayed back into the laundry in order to achieve optimum moisture penetration.

The optimum water level is set at the end of the drenching phase. If necessary, the washing machine will pump water away or take in a little more fresh water.

- Noises during the heating phase

Unusual bubbling noises can occur while the laundry and the drum are being heated.



Changing the program sequence

Changing a program (child lock)

A program, temperature, spin speed, or selected extra options cannot be changed once the machine has been successfully started. This prevents the machine being operated unintentionally, e.g., by children.

If the washing machine is switched off during active program operation, the standby function does not switch the washing machine off completely after 15 minutes. Safety functions continue to be active because there may still be water inside the drum.

Interrupting a program

- Switch the washing machine off with the  button.
- Switch the washing machine back on with the  button to continue with the same program.

Cancelling a program

You can cancel a wash program at any time after it has started.

- Touch the *Start/Stop* sensor button.

The following will appear in the display:

 Cancel the program?

- Select Yes.

The following will appear in the display:

Program cancelled.

The washing machine pumps away the suds.

- Wait until the door unlocks.
- Pull open the door.
- Remove the laundry.

Selecting another program

- Close the door.
- Select the program you want to use.
- Add detergent to the detergent dispenser drawer, if necessary.
- Touch the *Start/Stop* sensor button.

The new program will begin.

Favourite programs

Creating Favourites

You can save your own customized wash programs under names of your choice.

Option 1

- The main menu must be visible in the display. Touch the **Favourites** sensor button.

The display will change to show the **Favourites** menu.

Touch the **Create** sensor button.

The display will change to the **Create favourite** menu.

- Select the program you want to use.
- Select all the program settings you want.
- Then select **Save**.
- Enter a name.

Option 2

You can save a program which has been selected as a **Favourite** program before you start it.

- Before the program starts, touch the ☆ **Save** sensor button.
- Enter a name.

If 12 **Favourites** have already been saved, the **Create** or ☆ **Save** sensor button will not be visible. Delete an existing **Favourite** if you wish to create a new one.

Entering a name

It is best to select short, memorable names.

- Tap the letters or characters you want.
- Confirm with the **Save** sensor button.

The wash program will then be saved to the **Favourites** program list.

Changing a Favourite program

You can rename, delete, or move a **Favourite** program.

- Select the **Favourites** sensor button from the main menu.
- Touch the **Favourite** program that you wish to change until the context menu opens.
- Select **Rename**, **Delete**, or **Move**.

The washing assistant helps you with loads consisting of items with different care instructions. The washing machine will use the list of items to put together a suitable wash program.

- Scroll to the second page in the main menu.
- Touch the Wash Assistant sensor button.

A list of items will appear.

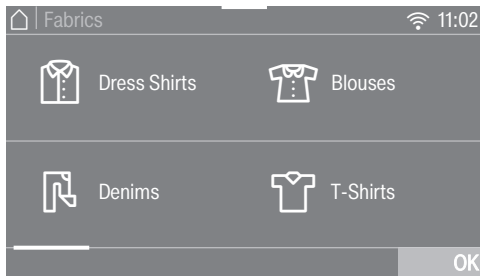

- Touch the appropriate sensor button for your item of laundry.

The item selected will be highlighted orange. You can select several items.

With some items, helpful information will also appear in the display when they are selected.

- Confirm with the OK sensor button.
- Follow the instructions in the display.

A summary of the selected parameters will then appear in the display.

- Confirm with the OK sensor button or select Change if you would like to make any changes.

The program which has been tailored to your laundry is ready to start.

Useful tip: You can add individual program settings, e.g., *Options*, before you start the program.

Timer



The timer can be used to set the time you wish a program to finish or start at. The program start can be delayed by up to 24 hours.

Setting the timer

- Touch the  Timer sensor button.
- Select the Finish at or Start at option.
- Set the hours and the minutes and confirm your entry with the OK sensor button.



Changing the timer

The selected times for the timer can be changed before the program starts.

- Touch the  or  sensor button.
- Change the specified time and confirm with the OK sensor button.

Deleting the timer

The selected time for the timer can be deleted before the program starts.

- Touch the  or  sensor button.

The selected time for the timer appears in the display.

- Touch the Delete sensor button.
- Confirm with the OK sensor button.

The selected time for the timer is now deleted.

Starting the timer

- Touch the *Start/Stop* sensor button.

The door will lock and the time until the program starts will appear in the display.

After the program has started, the selected time can only be changed or cancelled by interrupting the program.

The program can be started immediately at any time.

- Touch the Start immediately sensor button.

SmartStart

The *SmartStart* function lets you define a time period during which your washing machine will start automatically. The start takes place via a signal, e.g., from your energy supplier, that indicates that the electricity tariff is particularly economical.

This function is active when the SmartGrid setting is switched on.

The timeframe can be defined between 1 minute and 24 hours. During this period, the washing machine waits for the signal from the energy supplier. If no signal is sent during the defined period, the washing machine starts the wash program.

Setting the timeframe

If you have activated the SmartGrid function in Settings, SmartStart by or SmartFinish by will appear in the display instead of Start at or Finish at when you touch the  Timer sensor button (see “Settings – SmartGrid”).

The procedure for setting this is the same as for setting the time for delay start.

- Set the time you want and confirm with the OK sensor button.
- Touch the *Start/Stop* sensor button to start the wash program with *SmartStart*.

The selected program will start automatically, as soon as the energy supplier has sent the signal, or the latest calculated start time has been reached.

The procedure for changing or deleting the *SmartStart* function is the same as described in “Changing the timer” and “Deleting the timer”.

Detergent

Recommended Miele Detergents

Miele Detergents have been specially designed for day-to-day use in Miele Washing Machines. See “Detergents and care products” for more information about these detergents.

	Miele UltraPhase 1 and 2	Miele Caps		
				
Normal	✓	-	✓	✓
Sanitize	✓	-	✓	✓
Wrinkle-free	✓	-	✓	✓
Delicates	✓	✓	✓	-
QuickIntenseWash	✓	-	-	-
Express	✓	-	✓	-
Handwash	-	✓	✓	-
Towels	✓	-	✓	✓
Extra White	✓	-	✓	✓
Dress Shirts	✓	-	✓	✓
Denim/Jeans	✓	-	✓	-
Darks	✓	-	✓	-
Woolens 	-	✓	-	-
Silks 	-	✓	-	-
Outdoor	-	✓	-	-
Proofing	-	-	✓	-
Sportswear	-	✓	-	-
Sneakers	✓	✓	-	✓
Downs	-	✓	-	-
Pillows	✓	-	-	-
Table Linens/Drapes	✓	-	✓	✓
Curtains	✓	-	-	✓
Baby Clothes	✓	-	✓	✓
Quick Rinse	-	-	✓	-

✓ Recommendation

- No recommendation

 Special-purpose detergents (e.g., WoolCare)

 Fabric care (e.g., fabric softener)

 Additives (e.g., booster)

General detergent recommendations

The wash programs that are not listed do not have a detergent recommendation

	Universal detergent	Colour detergent	Detergent for woollens and delicates	Bleach ¹
Normal	✓	✓	-	✓
Sanitize	✓	✓	-	✓
Wrinkle-free	✓	✓	-	✓
Delicates	-	-	✓	-
QuickIntenseWash	✓	✓	-	-
Express	-	✓ ²	-	-
Handwash	-	-	✓	-
Towels	✓	✓	-	-
Extra White	✓	-	-	✓
Dress Shirts	✓	✓	-	✓
Denim/Jeans	-	✓	-	-
Darks	-	✓	-	-
Woolens 🧶	-	-	✓	-
Silks 🧶	-	-	✓	-
Outdoor	-	-	✓	-
Sportswear	-	-	✓	-
Sneakers	-	-	✓	-
Downs	-	-	✓ ²	-
Pillows	-	-	✓ ²	-
Table Linens/Drapes	✓	✓	-	✓
Curtains	✓ ³	-	-	-
Baby Clothes	✓	✓	-	✓
Clean Machine	✓ ³	-	-	-

✓ Recommended

- Not recommended

1 If the “Chlorination” setting has been activated

2 Liquid detergent

3 Powder detergent

Replacing the TwinDos cartridge

A message will appear in your washing machine display if a detergent cartridge is empty.

Preparing the cartridge

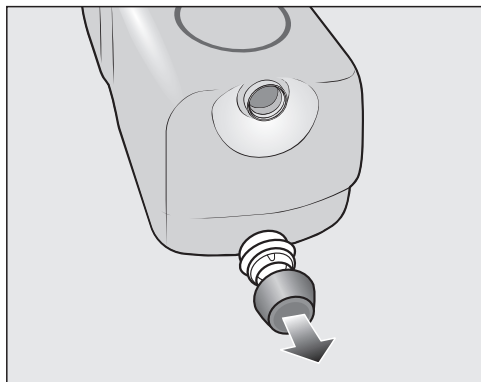

- Remove the cover cap from the cartridge.

or

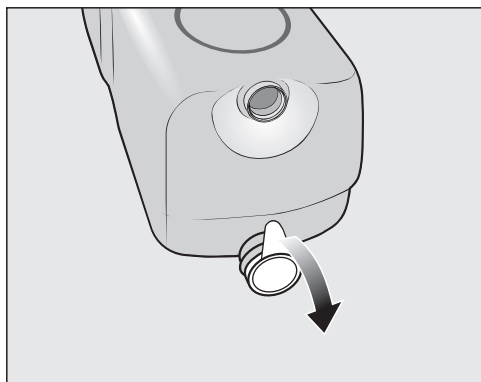

- Remove the film seal from the cartridge completely.

 Risk of damage from film seal
If the film seal is not removed completely, leaks can occur in the TwinDos system.

Remove the film seal from the suction port on the cartridge completely before inserting the new cartridge.

Replacing the cartridge

- Switch on the washing machine.

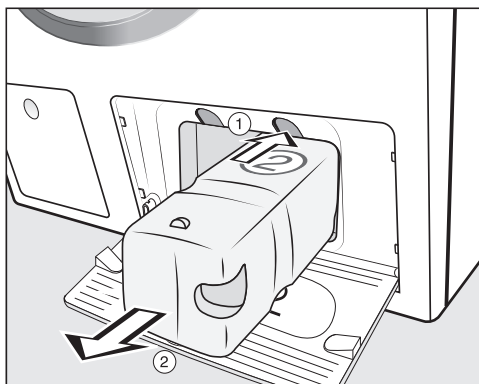

① To release the lock, press the yellow button above the cartridge.

② Remove the cartridge.

- Insert a new cartridge.

- Confirm the messages in the display.

The counter is set to 0.

Cleaning the housing and control panel

⚠ Risk of electric shock.
Voltage is present when the washing machine is switched off
Disconnect the machine from the electricity supply before cleaning or maintenance.

⚠ Risk of damage due to ingress of water.
The pressure of a water jet can cause water to get into the washing machine, resulting in damage to components.
Do not spray the washing machine with a water jet.

- Clean the housing and control panel with a mild cleaning agent or soap and water and dry both with a soft cloth.
- The drum can be cleaned using a suitable stainless steel cleaning agent following the manufacturer's instructions on the packaging.

⚠ Damage due to cleaning agents.
Solvent-based cleaning agents, abrasive cleaners, glass cleaners or multi-purpose cleaning agents can cause damage to plastic surfaces and other parts.
Do not use any of these cleaning agents.

Cleaning the detergent dispensing drawer

Washing at low temperatures and the use of liquid detergent can lead to a build-up of bacteria in the detergent dispensing drawer.

- Clean the entire drawer at regular intervals for hygiene reasons, even if you are using the TwinDos system exclusively.

Removing the detergent dispenser drawer

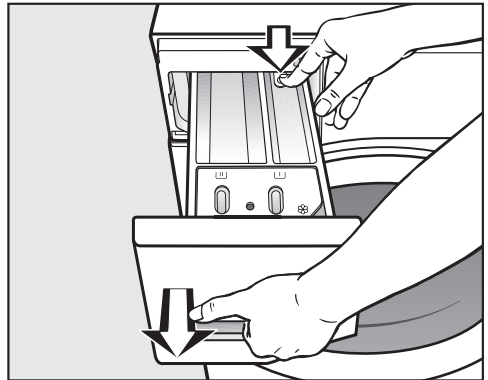

- Pull out the detergent dispenser drawer until a resistance is felt. Press down the release button and at the same time pull the drawer right out of the machine.

Cleaning and care

Removing and cleaning the insert for liquid detergents

An insert for liquid detergents is located in the  compartment of the detergent dispenser drawer.

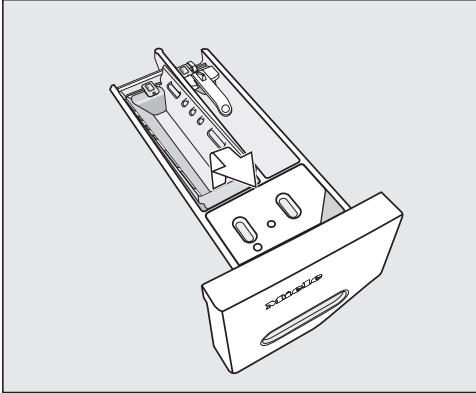

- Remove the insert. Clean the insert thoroughly with warm water.

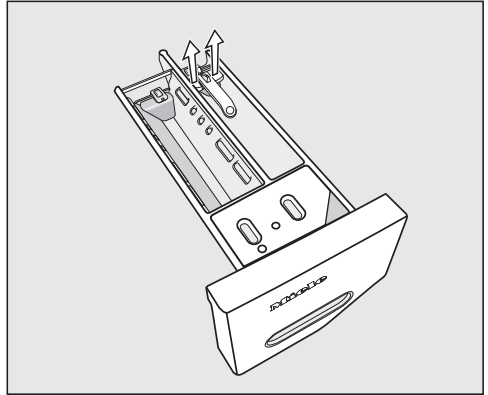

Cleaning the compartment

Compartment 1 has a siphon for better dispensing of the chlorine bleach.



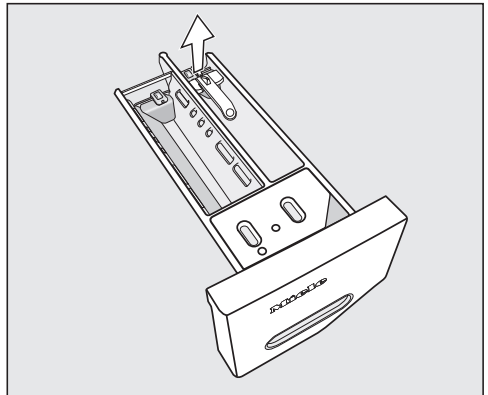

- Remove the release catch.



- Remove and clean the siphon.
- Clean the  and  compartments with warm water.

Cleaning the siphon and the / compartment channel

Liquid starch results in clogging. The siphon in the  /  compartment no longer works and the compartment can overflow.

Clean the siphon particularly thoroughly after using liquid starch a few times.

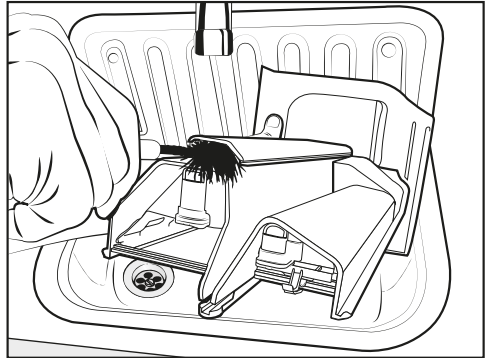

- Clean the fabric softener channel with a brush and warm water.

Cleaning the detergent dispenser drawer housing

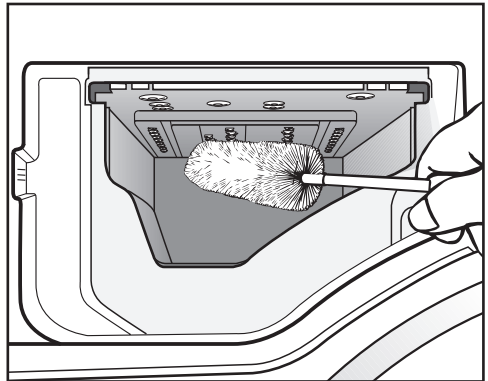

- Use a bottle brush to remove detergent residues and limescale from the jets inside the detergent dispenser drawer housing.
- Replace the detergent dispenser drawer.

Useful tip: Leave the detergent dispenser drawer slightly open to allow it to dry.

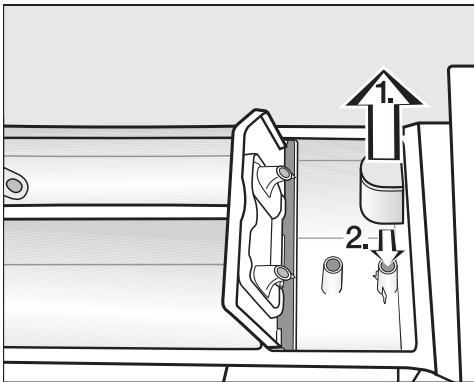

1. Remove the siphon from the  compartment and clean under warm running water. Clean the siphon tube in the same way.
2. Refit the siphon.

Cleaning and care

Cleaning the drum (Hygiene info)

Washing at low temperatures and / or using liquid detergent can cause bacteria and unpleasant odours to build up in the washing machine. Use the Clean Machine program to clean the washing machine. Run this program regularly or at the latest when the Hygiene info: select "Maintenance" and run the "Clean Machine" program message appears in the display.

TwinDos maintenance

 Damage resulting from dried laundry detergent.

If the system has not been used for a long time (more than 2 months), detergent in the hoses can become viscous or dry out. The hoses can become blocked and would then need to be cleaned by Miele Service. Clean the TwinDos system.

To clean the system, you need a "TwinDosCare" cleaning cartridge, which is available from www.miele.ca.

The washing machine has a cleaning program for the TwinDos system. Running the cleaning program will clean the hoses inside the washing machine.

Starting the maintenance program

- Switch on the washing machine.
- Scroll to the second page in the main menu.
- Touch the Maintenance sensor button.

The display will then change to show the *Maintenance* menu.

- Select Clean TwinDos.
- Touch the sensor button for the container you want to clean.
- Confirm Start Maintenance program? with the Yes sensor button.
- Follow the instructions in the display.

The hoses will now be cleaned. The TwinDos system can be used again at any time.

Cleaning the removable compartment

Detergent residue can cause clogging.

- Use a damp cloth to clean the compartment interior when you change the cartridges or container.

Cleaning the water inlet filter

The washing machine has 2 filters to protect the inlet valve. Check these filters every 6 months or so. Check the filters more often if there are frequent interruptions to the external water supply.

Cleaning the filter in the inlet hose

- First turn off the faucet.
- Unscrew the inlet hose from the faucet.

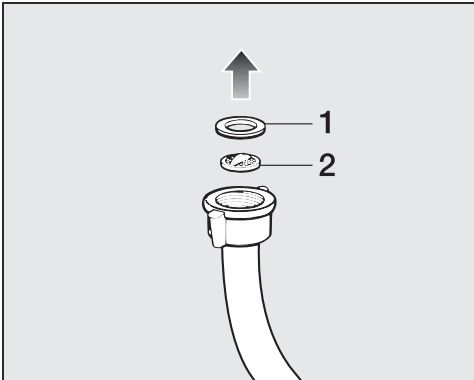

- Remove the rubber seal **1** from the connector.
- Using needle nose pliers, take hold of the plastic filter bar **2** and remove the plastic filter.
- Clean the filter.
- Reassemble in reverse order.

Cleaning the filter in the inlet valve

- Using pliers, carefully loosen the ribbed plastic nut on the inlet valve and unscrew.

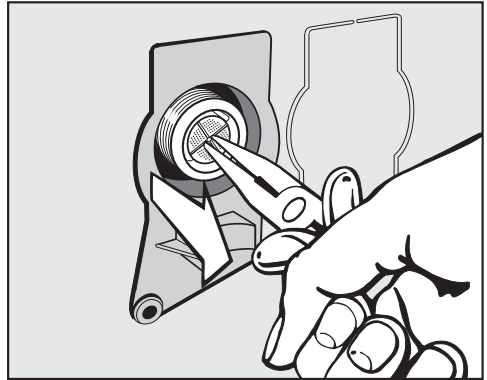

- Use needle nose pliers to withdraw the filter by the bar.
- Clean the filter.
- Reassemble in reverse order.

The filters must be put back in place after cleaning.

- Screw the screw thread securely back onto the faucet.
- Turn on the faucet.

Make sure there is no water leaking from the screw thread.
Tighten the screw thread.



Problem solving guide

Many malfunctions and errors that can occur in daily operation can be easily remedied. You can save time and money in many cases, as you do not need to contact Miele Customer Service.





Information to help you rectify malfunctions yourself can be found at www.miele.com/service.

The following tables are designed to help you to find the cause of a malfunction or an error and to resolve it.

The wash program will not start

Problem	Possible cause and solution
The display remains dark and the Start/Stop button indicator light does not come on.	There is no power to the washing machine. <ul style="list-style-type: none">■ Check whether the plug is plugged in.■ Check whether the fuse has tripped.
	The washing machine has switched off automatically to save energy. <ul style="list-style-type: none">■ Switch it back on with the  button.
The display prompts you to enter a PIN code.	The PIN code is active. <ul style="list-style-type: none">■ Enter the code and confirm the entry. Deactivate the PIN code if you do not wish this message to appear in the display the next time the machine is switched on.
The following appears in the display:  Door will not lock. Contact Service.	The door is not closed properly. The door lock could not engage. <ul style="list-style-type: none">■ Close the door again.■ Start the program again. If the error message appears again, contact Miele Service.

Fault message after a program has been interrupted

Problem	Possible cause and solution
 Drainage fault. Clean drain filter and pump. Check the drain hose.	The drain is blocked or restricted. The drain hose has been fixed too high. <ul style="list-style-type: none"> ■ Clean the filter and the pump. ■ The maximum drain height is 1.0 m.
 Water intake fault. Open the water supply.	The water inlet is blocked or restricted. <ul style="list-style-type: none"> ■ Check whether the faucet is turned on properly. ■ Check whether the inlet hose is kinked. ■ Check whether there is sufficient water pressure. The filter in the water inlet is blocked. <ul style="list-style-type: none"> ■ Clean the filter.
 Fault F. If restart fails, call Service.	There is a fault. <ul style="list-style-type: none"> ■ Disconnect the washing machine from the electrical supply. Unplug the appliance or switch off the circuit breaker. ■ Wait at least 2 minutes before reconnecting the washing machine to the electrical supply. ■ Then switch the washing machine on again. ■ Restart the program. If the error message appears again, contact Miele Service.
 Waterproof system activated. Close water supply and contact Service.	The water protection system has reacted. <ul style="list-style-type: none"> ■ Close the faucet. ■ Contact the Service department.

To switch off the fault message: switch the washing machine off with the  button.

Problem solving guide

Fault message after the end of the program

Problem	Possible cause and solution
i Check dosage	Excessive foam has built up during washing. <ul style="list-style-type: none">■ Check the amount of detergent dispensed.■ With automatic detergent dispensing, check the dispensing quantity set.■ Observe the instructions on the detergent packaging and the level of soiling on the laundry.■ If necessary, reduce the dispensing quantity by increments of 10%.
i Hygiene info: select "Maintenance" and run the "Clean Machine" program	A wash program using a temperature above 60°C has not been run for a long period of time. <ul style="list-style-type: none">■ In order to prevent bacteria and unpleasant odours building up in the washing machine, run the <i>Clean Machine</i> program using the Miele Machine Cleaner or a universal powder detergent.

The messages will appear at the end of the program and when the washing machine is switched on, and need to be confirmed with the *OK* sensor button.

Fault message after the end of the program

Problem	Possible cause and solution
<p>i Intensive flow: Clean the filter and jet or remove foreign objects from the pump housing.</p>	<p>The pumps are dirty.</p> <ul style="list-style-type: none"> ■ Clean the pumps as described in “Problem solving guide – Opening the door in the event of a blocked drain outlet and / or power failure”. ■ Start a wash program again after cleaning. <p>The jet in the top of the door ring is blocked with fluff.</p> <ul style="list-style-type: none"> ■ Remove the fluff with your finger. Do not use any sharp or pointed tools to do this. ■ Start a wash program again after cleaning. <p>If the error message appears again, contact Miele Service. The washing machine can still be used but with reduced functionality.</p>
<p>i Align the machine. Laundry not properly spun</p>	<p>The SoftSteam extra option which runs at the end of the program could not be carried out properly.</p> <ul style="list-style-type: none"> ■ Check whether the washing machine is aligned correctly (see “Installation – Levelling the machine”). ■ Check whether the maximum drain height of 1 m has been exceeded. <p>If the error message appears again, contact Miele Service. The washing machine can still be used but with reduced functionality.</p>

The messages will appear at the end of the program and when the washing machine is switched on, and need to be confirmed with the *OK* sensor button.

Problem solving guide

Messages or faults affecting the TwinDos system

Problem	Possible cause and solution
i Only a few more wash cycles can be run. Please order a new cartridge for compartment ①.	The detergent in the cartridge is running low. There are between 4 and 8 wash cycles remaining. ■ Order a new cartridge.
i “TwinDos” ① is empty. Check the wash result.	The cartridge is empty. ■ Replace the cartridge. ■ Check whether the laundry is clean. If it is not, there may not have been enough detergent. Wash the laundry again if necessary.
i Use TwinDos or carry out TwinDos Maintenance in the “Maintenance” menu. See Operating Instructions for more information.	TwinDos or automatic dispensing via compartment ① and / or ② has not been used for a long time. ■ Use TwinDos for one of your next wash cycles. ■ Carry out the TwinDos maintenance program as described in “Cleaning and care – TwinDos maintenance”.
 TwinDos Maintenance for compartment ① must be started in the Maintenance menu. See the Operating Instructions for more information	TwinDos or automatic dispensing via compartment ① and / or ② has not been used for a long time. It is possible that detergent has dried inside the hoses. ■ Immediately carry out the TwinDos maintenance program as described in “Cleaning and care – TwinDos maintenance”.
The messages shown on this page are examples. They may differ depending on whether they refer to compartment ① or ②.	

The messages will appear at the end of the program and when the washing machine is switched on, and need to be confirmed with the OK sensor button.

Messages or faults affecting the TwinDos system

Problem	Possible cause and solution
<p>A new detergent cartridge has been inserted, but the cartridge is identified as empty when the machine is switched on.</p>	<p>The washing machine was switched off when the detergent cartridge was replaced.</p> <ul style="list-style-type: none"> ■ Switch on the washing machine. ■ Remove the detergent cartridge and then reinsert it into the compartment. <p>The counter is set to 0.</p>
<p>There are dark specks in the liquid detergent.</p>	<p>Mold has developed in the detergent.</p> <ul style="list-style-type: none"> ■ Pour the liquid detergent out of the container and then clean the container thoroughly.
<p>No detergent and / or fabric softener was dispensed during the wash program.</p>	<p>TwinDos was not activated.</p> <ul style="list-style-type: none"> ■ Touch the TwinDos sensor button before running the next program. <p>TwinDos is activated.</p>
	<p>No detergent and / or fabric softener was dispensed when TwinDos was selected.</p> <ul style="list-style-type: none"> ■ Try again. ■ If detergent is still not dispensed, call the Service department.

Problem solving guide

General problems with the washing machine

Problem	Possible cause and solution
The washing machine smells.	The hygiene info was not observed. A wash program using a temperature above 60 °C has not been run for a long period of time. <ul style="list-style-type: none">■ In order to prevent bacteria and unpleasant odours building up in the machine, run the <i>Clean machine</i> program using Miele dishwasher and washing machine cleaner or powder detergent.
	The door and detergent dispenser drawer were closed after washing. <ul style="list-style-type: none">■ Leave the door and the detergent dispenser drawer slightly open to allow them to dry.
The machine shakes during the spin cycle.	The machine feet are not level. <ul style="list-style-type: none">■ Level the machine and adjust the feet correctly.
The laundry has not been spun properly and the laundry is still wet.	The machine detected an imbalance during the final spin and reduced the spin speed automatically. <ul style="list-style-type: none">■ Wash large and small items together in order to achieve a more even load distribution.
Strange pump noises can be heard.	Not a fault. Slurping noises occur at the start and end of the pump sequence as a normal part of operation.
The drum lighting does not come on.	The drum lighting goes out automatically after 5 minutes. <ul style="list-style-type: none">■ Open the pull-down menu from the overview menu and then touch the  sensor button.
	The drum lighting is faulty. <ul style="list-style-type: none">■ Contact Miele Service.

General problems with the washing machine

Problem	Possible cause and solution
Fabric softener is not completely dispensed or too much water remains in the  compartment.	<p>The siphon tube is not correctly positioned or clogged.</p> <ul style="list-style-type: none"> ■ Clean the siphon (see “Cleaning and care – Cleaning the detergent dispensing drawer”).
At the end of the program there is still liquid in the capsule.	<p>The small pipe in the detergent dispenser drawer onto which the capsule is placed is blocked.</p> <ul style="list-style-type: none"> ■ Clean the small pipe. <hr/> <p>Not a fault. For technical reasons, a small amount of water will remain in the capsule.</p>
There is water next to the cap in the fabric softener compartment.	<p>CapDosing was not activated or an empty cap was not removed at the end of the last wash program.</p> <ul style="list-style-type: none"> ■ Make sure that you remember to activate CapDosing the next time you insert a cap. ■ Remove and then dispose of the empty cap at the end of each wash cycle. <hr/> <p>The small pipe in the detergent dispenser drawer onto which the cap is placed is blocked.</p> <ul style="list-style-type: none"> ■ Clean the small pipe.

Problem solving guide

An unsatisfactory wash result

Problem	Possible cause and solution
Liquid detergent is not achieving the required results.	<p>Liquid detergents do not usually contain bleaching agents. Consequently, fruit, coffee, and tea stains cannot always be removed.</p> <ul style="list-style-type: none">■ Use the Miele 2-phase system. The deliberate addition of UltraPhase 2 during the wash process removes stains effectively.■ Use powder detergent containing a bleaching agent.
White residues which look like powder detergent are seen on dark fabrics after washing.	<p>The detergent contained compounds (zeolites) to aid water softening which are not soluble in water. These have ended up on the laundry.</p> <ul style="list-style-type: none">■ Try and brush off the residues with a soft brush once the laundry is dry.■ In future, wash dark fabrics using a detergent which contains no zeolites. Liquid detergents do not usually contain zeolites.■ Use the <i>Darks</i> program to wash the textiles.
Grey, greasy particles cling to washed laundry.	<p>Insufficient amounts of detergent were used. The laundry was heavily soiled with grease (oils, ointments).</p> <ul style="list-style-type: none">■ Use more detergent or liquid detergent with this type of soiled laundry.■ Before washing the next load, run the <i>Clean Machine</i> wash program using Miele clean machine or a universal powder detergent.

The door will not open

Problem	Possible cause and solution
<p>The door cannot be pulled open during a program.</p>	<p>The drum is locked during a program.</p> <ul style="list-style-type: none"> ■ Touch the <i>Start/Stop</i> sensor button to cancel the program. <p>The program is cancelled, the door will unlock, and you will be able to pull it open.</p> <hr/> <p>There is still water in the drum and the machine is unable to drain.</p> <ul style="list-style-type: none"> ■ Clean the drain filter and drain pump as described in “Problem solving guide – Opening the door in the event of a blocked drain outlet and / or power failure”.
<p>Comfort Cooling appears in the display after a program has been cancelled.</p>	<p>To protect the user against scalding, the door cannot be opened if the suds temperature is higher than 55°C.</p> <ul style="list-style-type: none"> ■ Wait until the temperature in the drum has decreased and the message has gone out in the display.
<p>The following appears in the display:  The door lock is jammed. Contact Service.</p>	<p>The door lock has jammed.</p> <ul style="list-style-type: none"> ■ Contact the Service department.

Problem solving guide

Opening the door in the event of a blocked drain outlet and/ or power failure

- Turn off the washing machine.



- Open the drain pump flap.

Blocked drain outlet

If the drain outlet is blocked, a larger quantity of water can remain in the washing machine.

 Risk of scalding due to hot suds. Escaping suds will be hot if laundry has been washed at high temperatures. Carefully allow all suds to drain off.

Draining the washing machine

Remove the drain filters, though not completely.

- Place a suitable container under the flap, e.g. a Miele universal oven tray.

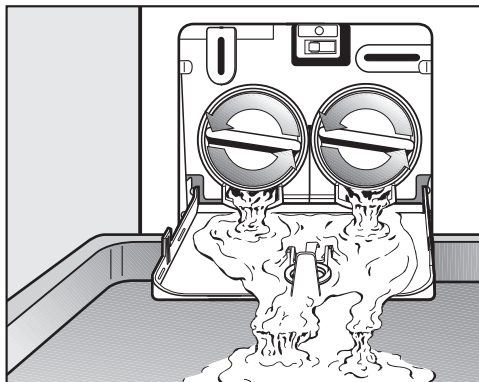

- Slowly unscrew the drain filters to let the water out.
- Tighten the drain filters back up again if you need to interrupt the flow of water.

Once the flow of water stops:

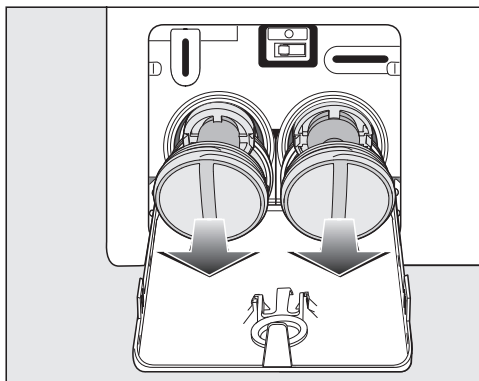

- Remove the drain filters completely.

Problem solving guide

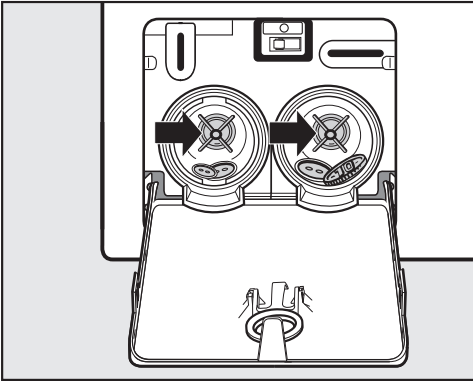

- Clean the drain filters thoroughly.
- Remove any foreign objects (e.g. buttons, coins, etc.) and clean the interior. Turn the impellers by hand to check that they rotate freely.

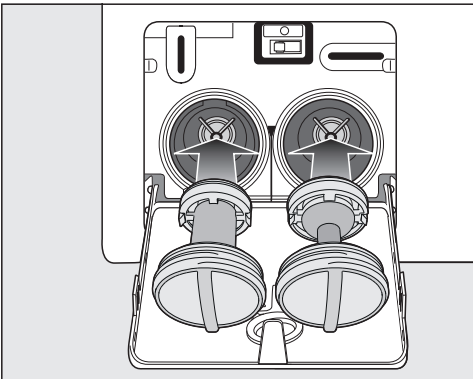

- Replace the drain filters correctly (on the right and left) and tighten them securely.
- Close the drain pump flap.

Opening the door

⚠ Risk of injury due to rotating drum.

Reaching into a rotating drum is extremely dangerous.

Always make sure that the drum is stationary before reaching in to remove laundry.

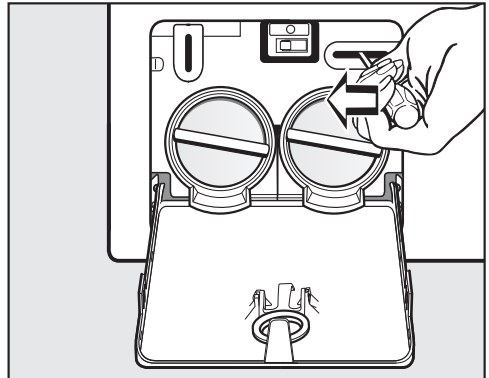

- Use a screwdriver to unlock the door.
- Pull open the door.

⚠ Risk of water damage

Make sure the filters are securely tightened. Otherwise there is a risk of water leakage during use.

Replace the drain filters correctly and tighten them securely.

Technical Service

Information to help you rectify malfunctions yourself and about Miele spare parts can be found at www.miele.com/service.

Contact in the event of a fault

In the event of a fault which you cannot remedy yourself, please contact your Miele dealer or Miele Service.

Contact information for Miele Service can be found at the end of this document.

Please quote the model identifier and serial number of your appliance (SN) when contacting Miele Service. This information can be found on the data plate.

The data plate is found above the porthole glass when the door is opened.

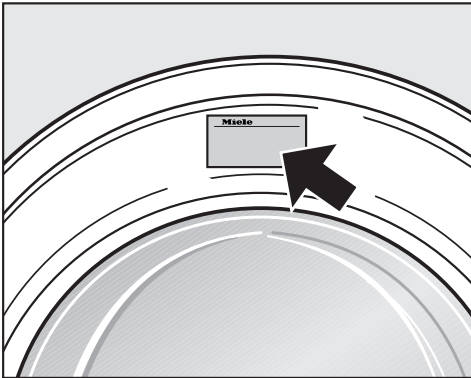

Optional accessories

Optional spare parts and accessories for this washing machine are available from Miele.

Warranty

For further information, please refer to your warranty booklet.

Front view

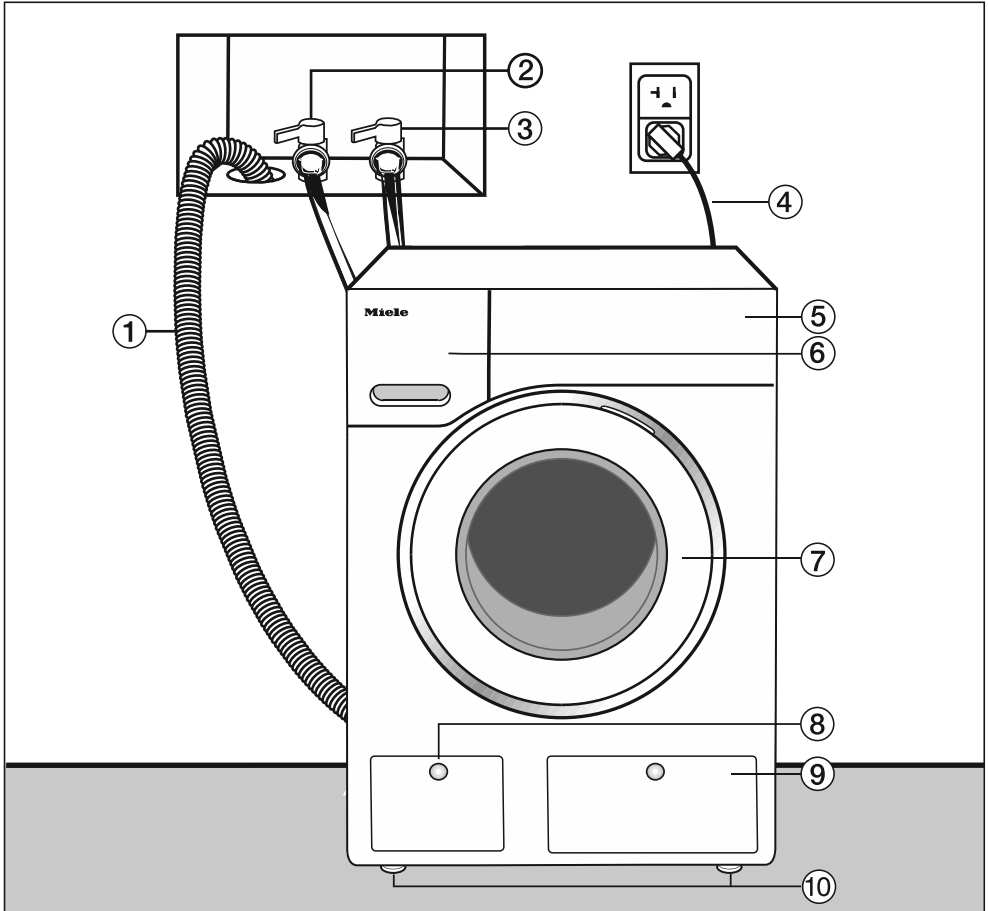

- ① Drain hose
- ② Hot-water inlet hose (pressure-proof to 1,015 psi/7,000 kPa)
- ③ Cold-water inlet hose (pressure-proof to 1,015 psi/7,000 kPa)
- ④ Electrical connection
- ⑤ Control panel
- ⑥ Detergent dispenser drawer
- ⑦ Door
- ⑧ Flap for drain filters, drain pumps, and emergency release
- ⑨ Flap for TwinDos cartridges
- ⑩ Four height-adjustable feet

Installation

Rear view

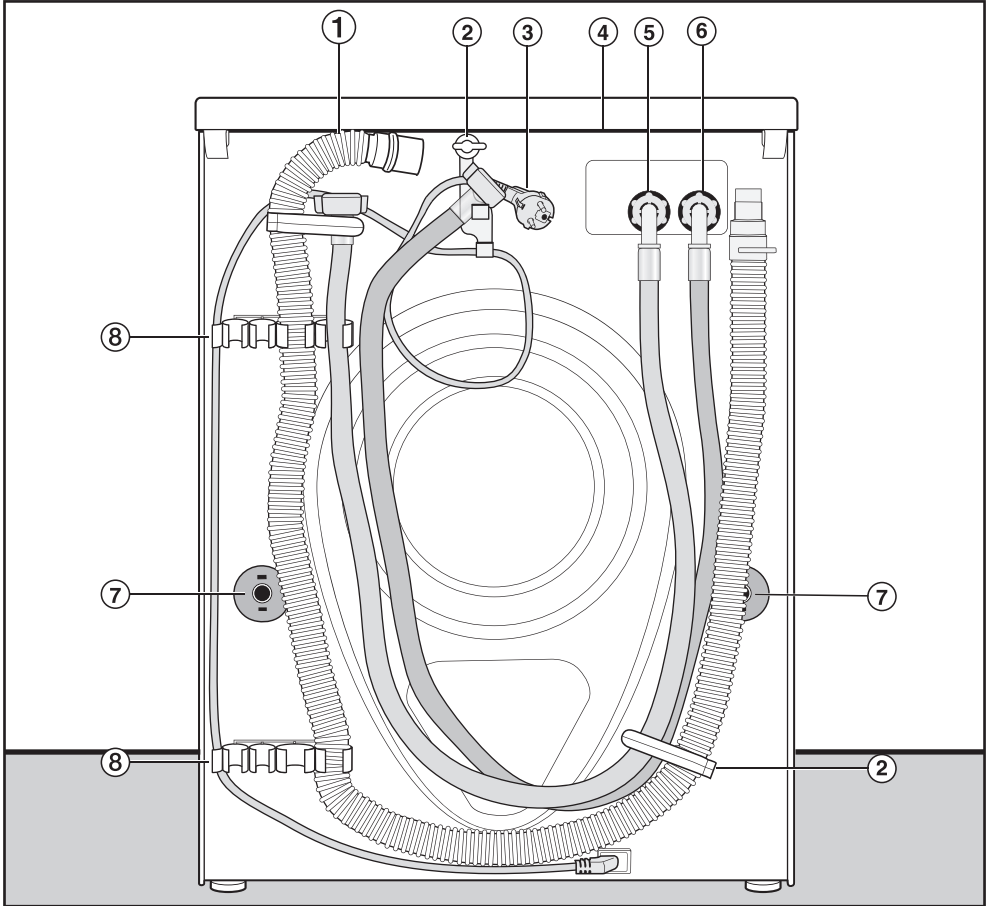

- ① Drain hose
- ② Transport clips for inlet and drain hoses and electrical supply cable
- ③ Electrical connection
- ④ Protruding lid for holding when moving the machine
- ⑤ Cold-water inlet hose (pressure-proof to 1,015 psi/7,000 kPa)
- ⑥ Hot-water inlet hose (pressure-proof to 1,015 psi/7,000 kPa)
- ⑦ Safety caps for transit bars
- ⑧ Transport clips for inlet and drain hoses and for storing transit bars when not in use

Installation surface

A concrete floor is the most suitable installation surface. It is far less prone to vibration during the spin cycle than wooden floorboards or a carpeted surface.

Please note:

- The machine must be level and securely positioned.
- To avoid vibrations during spinning, the machine should not be installed on soft floor coverings.

If installing on a wooden joist floor:

- Install the machine on a plywood base (at least 59 x 52 x 3 cm). The base should span several joists and be bolted to the joists, not just the floorboards.

Useful tip: If possible, install the machine in a corner. This is usually the most stable part of the floor.

 Injury can occur if the washing machine has not been adequately secured.

During installation, the washing machine must be secured on a plinth to be made available on site (concrete or brick), in order to ensure it cannot fall or slip.

Secure the washing machine using a clamp/fastening bracket (MTS floor mounting kit – available from your Miele dealer or Miele Service department).

Transporting the washing machine to its installation site

 Danger of injury due to unsecure lid.

The fixings at the back of the lid may become brittle due to external circumstances. There is a danger of the lid being pulled off when carrying the appliance.

Before carrying the appliance, check that the lid is secure where it protrudes at the back of the appliance.

- Carry the washing machine by the front feet and by the lid where it protrudes at the back of the appliance.

Installation

Removing the shipping struts

Removing the left-hand shipping strut

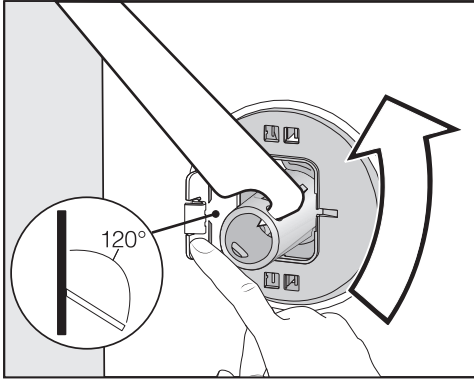

- Open out the cover and use the open spanner supplied with the washing machine to turn the shipping strut 90°.

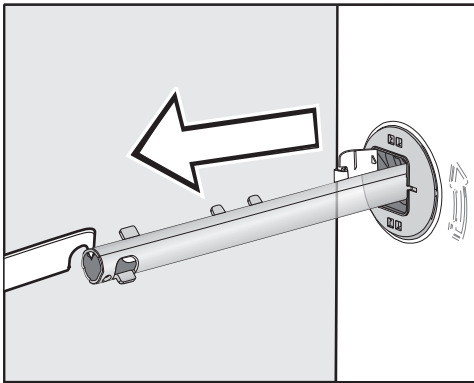

- Pull out the shipping strut.

Removing the right-hand shipping strut

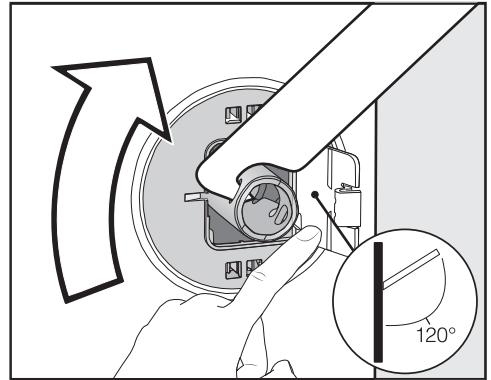

- Open out the cover and use the open spanner supplied with the washing machine to turn the shipping strut 90°.

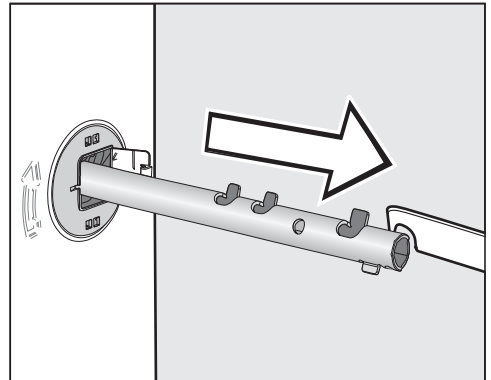

- Pull out the shipping strut.

Covering the holes

 Risk of injury from sharp edges. There is a risk of injury from reaching into holes that are not covered. Cover the holes for the shipping struts after they have been removed.

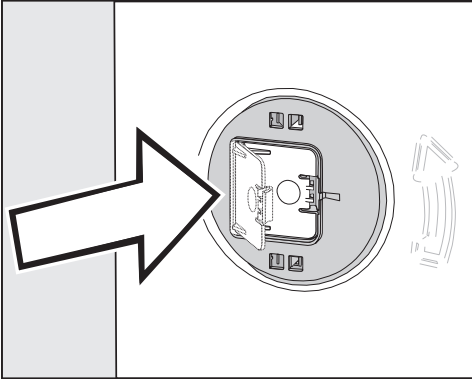

- Press the covers firmly shut until they click into place.

Securing the shipping struts

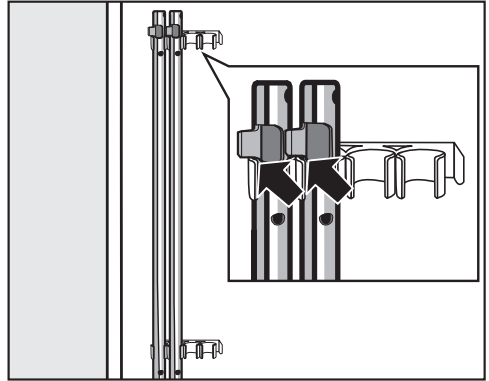

- Secure the shipping struts to the back of the washing machine. Make sure that the top catch is located above the holder.

 Risk of damage from incorrect transport.

The washing machine may become damaged if moved without the shipping struts in place.

Keep the struts in a safe place. Install them again if the washing machine is to be moved (when moving to a new house, for example).

Installation

Installing the shipping struts

Opening the covers

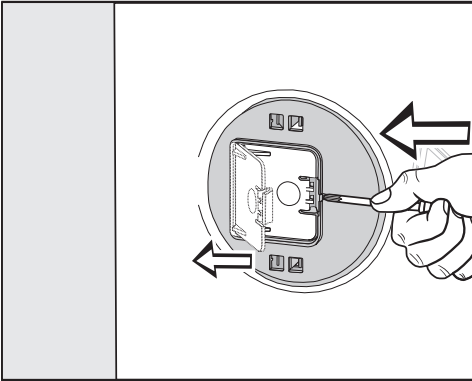

- Press against the catch with a sharp object (a narrow screwdriver, for example).

The cover opens.

Installing the shipping struts

- Install the shipping struts by following the instructions for their removal in reverse order.

Useful tip: The struts will slide in more easily if you lift the drum slightly.

Levelling the machine

The washing machine must stand perfectly level on all four feet to ensure safe and proper operation.

Incorrect installation may increase electric and water consumption and may cause the machine to move about.

Unscrewing and adjusting the feet

The four adjustable screw feet are used to level the washing machine. All four feet are screwed in when the washer-dryer is delivered.

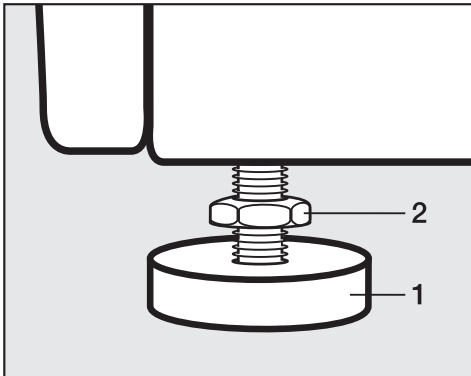

- Using the wrench supplied, turn counter nut **2** in a clockwise direction. Then turn counter nut **2** together with foot **1** to unscrew.

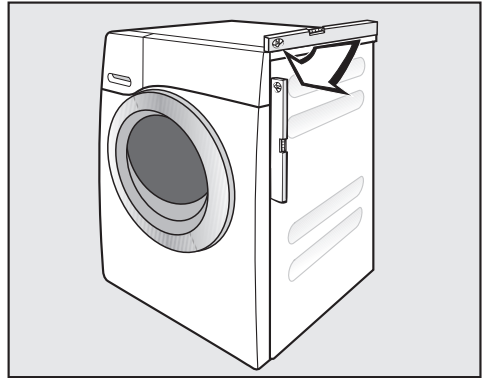

- Use a level to check that the washing machine is standing level.
- Hold foot **1** securely with a pipe wrench. Turn counter nut **2** again using the wrench supplied until it sits firmly up against the housing.

 Risk of damage due to incorrectly aligned washing machine. There is a danger of the washing machine moving about if the feet are not secured. Turn all four counter nuts for the feet until they sit firmly up against the housing. Please also check this for the feet which did not need adjustment.

Installation

Installing under a countertop

 Risk of electric shock due to exposed cables

There is a risk of coming into contact with live parts while the lid is removed.

Do not remove the washing machine lid.

This washing machine (with lid intact) can be pushed under a countertop if there is space to do so.

Washer-dryer stack

The washing machine can be installed as a washer-dryer stack together with a Miele Tumble Dryer. A WTV stacking kit* is required for this.

Parts marked with * are available from your Miele dealer or Miele Service.

Please note:

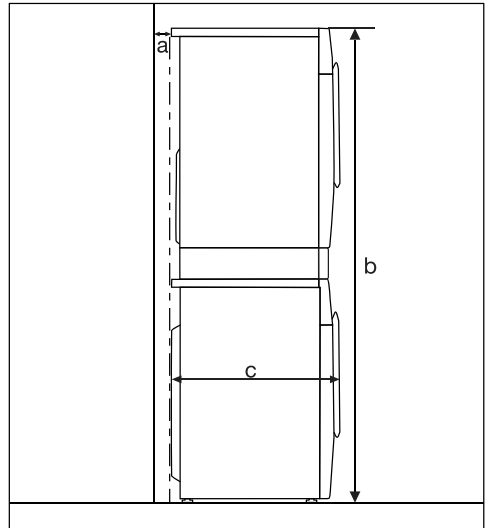

a = at least 2 cm

b = WTV without drawer: 172 cm
WTV with drawer: 181 cm

c = 65 cm

Additional installation requirements

The washing machine must be installed in accordance with the relevant local regulations.

⚠ Damage resulting from failure to remove the transit bars.

Failure to remove the shipping struts can result in damage to the washing machine and to adjacent cabinetry or appliances.

Remove the shipping struts as described in “Installation and connection”.

Installing under a countertop

⚠ Risk of electric shock due to exposed cables

There is a risk of coming into contact with live parts while the lid is removed.

Do not remove the washing machine lid.

This washing machine (with lid intact) can be pushed under a countertop if there is space to do so.

Setting up the cabinet

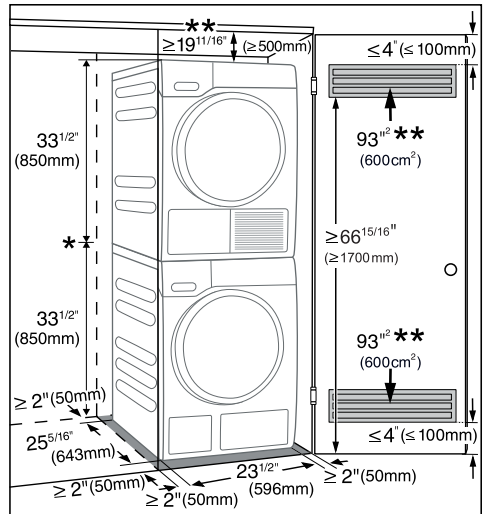

* Height with Stacking Kit
 WTV502 = 67 3/8" (1711 mm)
 WTV512 = 71 1/8" (1806 mm)

** If it is not possible to fulfill the dimension specification you may have longer drying and process time.

Installation

For closets at room height

You can also insert a ventilation opening at the top of the closet. In addition, you must also provide an opening on the bottom side of the door.

⚠ Risk of damage due to overheating of the washing machine. The air supply must not be hindered by an additional closet or shelf. Please ensure that air is able to circulate freely at the top of the closet.

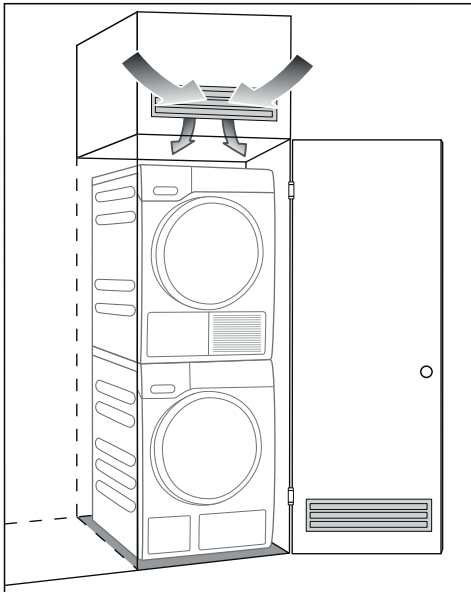

Product dimensions

Dimensions

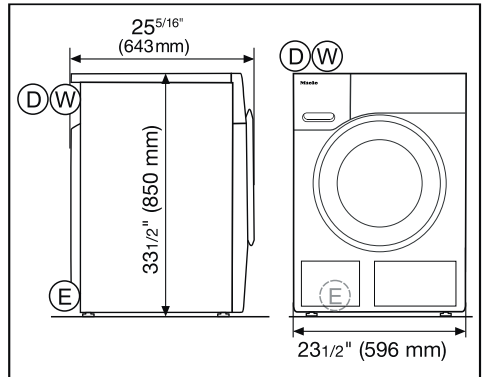

- ⓓ = 1.50 m drain hose with connection to the top left on the rear
- ⓔ = 2.00 m electrical cord with plug for 120 V, 15 A (NEMA 5-15 configuration) to the top left on the rear
- Ⓦ = 1.60 m hot and cold-water intake hoses to the top left on the rear

Installation on a plinth

- WTS 510 (only available in white)

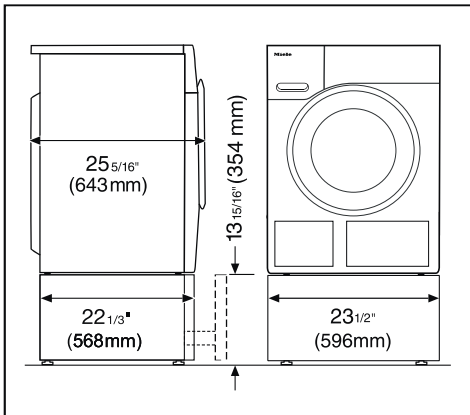

Washer-dryer stack

- WTV 512 and WTV 502 washer-dryer stacking kit

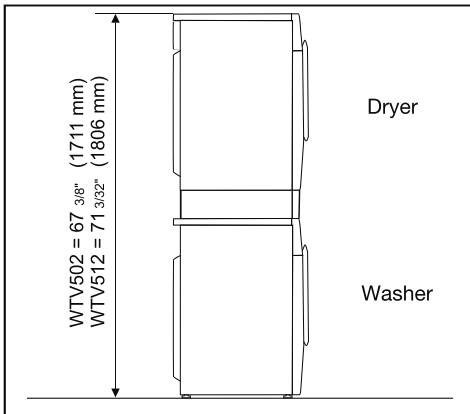

Installation

The Miele water protection system

The Miele water protection system protects all parts of the washing machine and its surroundings from water damage.

The system mainly consists of the following components:

- the inlet hose
- the electronic unit, and the drainage and overflow protection
- the drain hose

Inlet hoses

- Protection against the hoses bursting
The inlet hose can withstand pressure of more than 1,015.26 psi/ 7,000 kPa.

Electronic unit and machine housing

- Sump: Any leaking water from the washing machine is collected in a sump in the base of the machine. A float switches off the water inlet valves. This shuts off the water intake and prevents any more water from flowing into the machine. Water in the suds container is pumped away.
- Overflow protection: This prevents the washing machine from taking in too much water and overflowing. If the water level exceeds a certain level, the drain pump switches on and pumps the excess water away.

Water intake

 Health risk and risk of damage due to contaminated incoming water. The quality of the incoming water must correspond to the drinking water specification of the country in which the washing machine is being operated. Always connect the washing machine to the drinking water supply.

The washing machine should be connected to a domestic water supply in accordance with current local and national safety regulations. The German authorities do not require it to have a non-return valve as the washing machine has been designed to comply with DIN regulations.

The flow pressure must be at least 100 kPa and must not exceed an overpressure of 1,000 kPa. If it is higher than 1,000 kPa, a pressure reduction valve must be installed.

For the connection, a water tap with a $\frac{3}{4}$ " screw thread is required. If not available, only a qualified installer may connect the washing machine to the water supply.

The connection points are subject to water supply pressure. Turn on the tap slowly and check for leaks. Correct the position of the seal and union if necessary.

Maintenance

Only use a genuine Miele hose that has been tested to withstand pressure of over 1,015.26 psi/7,000 kPa should you ever need a replacement.

 A filter is located in the open end of the inlet hose and another in the intake point to protect the inlet valve. Neither filter may be removed.

Hose extension

Longer hoses of 2.5 m or 4.0 m in length are available from your Miele dealer or Miele Technical Service as optional accessories.

Installation

Drainage

The suds are drained through a drain pump with a 1 m delivery head. For the water to drain freely, the hose must be installed free of kinks.

If required, the hose can be extended to a length of up to 5 m. Accessories are available from your Miele dealer or Miele Service.

For a delivery head of more than 1 m (up to a max. of 1.8 m), a replacement drain pump will need to be installed. Please contact Miele Service for advice. For a delivery head of 1.8 m, the hose can be extended to a length of up to 2.5 m. Accessories are available from your Miele dealer or Miele Service.

Drainage options:

1. Direct into a sink or basin:

Please note:

- Hook the hose over the edge and secure!
- If the water is pumped into a sink, be sure that it can drain away quickly enough. Otherwise there is a risk of water overflowing or of some of the drained water being sucked back into the machine.

2. Connected securely to a plastic drain pipe with a rubber nipple (there is no need to use a non-return valve).

3. Connected securely to a floor drain.

4. Connected securely to a sink with a plastic nipple.

Fitting the elbow

Use the elbow supplied to stop the drain hose from slipping.

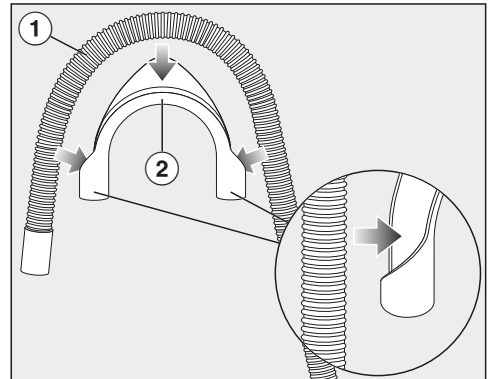

- Attach the elbow ② to the drain hose ①.

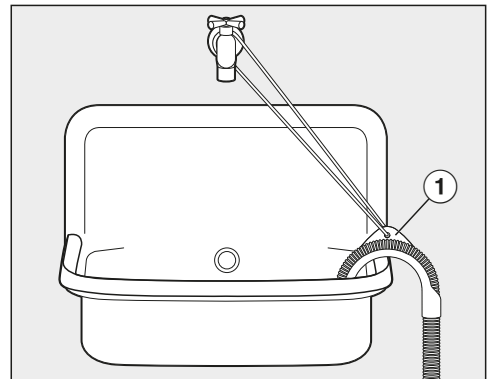

- Place the end of the drain hose in a sink.
- Use a strap and the eye ① to stop the elbow from slipping.

Electrical connection

GROUNDING INSTRUCTIONS

The washing machine must be grounded. Connecting the appliance to ground reduces the danger of electric shock in the event of a malfunction. The grounding is a protective conductor which provides a path of least resistance for the current. The washing machine comes complete with a power cord and plug with the corresponding protective conductor. The plug must be inserted into a suitable socket.

The socket must be installed and grounded in accordance with the locally applicable regulations.

WARNING! Incorrectly connected ground conductors will pose the danger of electric shock. Contact a qualified electrician or customer service staff if you have any doubts as to whether the washing machine has been grounded properly.

Do not replace or make any changes to the plug supplied. If there is no suitable socket available, one must be installed by a qualified electrician.

Instructions for electrical connection

The installation must be carried out by an experienced and qualified specialist in accordance with local regulations.

The washing machine is equipped with a 5' 3" (1.6 m) long, 3-wire cable with a NEMA-5-15 plug, which is ready for connection to a 120 V, 15 A, 60 Hz AC power supply.

The manufacturer recommends operating the washing machine on a dedicated circuit to avoid overloading the electrical circuit.

A suitable socket can be furnished by an electrical retailer.

Technical data

Height	33 7/16" (850 mm)
Width	23 7/16" (596 mm)
Depth	25 1/16" (636 mm)
Depth with door open	41 1/2" (1054 mm)
Height for building under	32 5/16" (+5/16"/-1/16") (820 mm)
Width for building under	23 5/8" (600 mm)
Weight	Approx. 220.5 lb (100 kg)
Capacity	17,6 lb/8 kg dry laundry
Connection voltage	See data plate
Rated load	See data plate
Fuse rating	See data plate
Minimum water flow pressure	14.5 psi (100 kPa)
Maximum water flow pressure	145 psi (1,000 kPa)
Inlet hose length	63" (1.6 m)
Drain hose length	59 1/16" (1.5 m)
Power cord length	78 3/4" (2 m)
Maximum drain height	39 3/8" (1 m)
Maximum drainage length	196 7/8" (5 m)
LEDs	Class 1
Test certificates awarded	See data plate
Frequency band	2.412 GHz–2.462 GHz
Maximum transmitting power	< 100 mW

You can use the settings to alter the washing machine's electronics to suit changing requirements.

The settings can be altered at any time.

Calling up settings

- Switch on the washing machine.
- Scroll to the second page in the main menu.
- Touch the **Settings** sensor button.

The display will change to show the Settings menu.

Selecting settings

The settings are grouped into different areas.

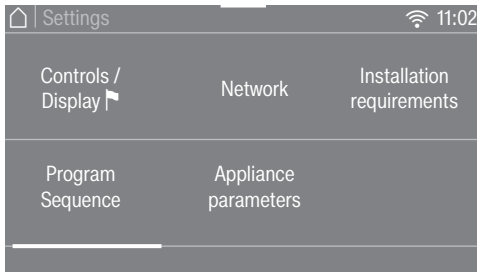

- Select the required area.
- Scroll through the list until the setting you want appears.
- Touch the sensor to select the setting you require.

Changing a setting

- Change the value displayed and confirm with **OK**.

or

- Touch an option to select it.

An option which is selected will be highlighted orange.

The option is saved. The display will then switch to the Settings menu, or go back to the previous menu level.

Closing the Settings menu

- Touch the **↶** sensor button.

The display will then go back to the previous menu level.

- Touch the **🏠** sensor button.

The display will change to the main menu.

Settings

Controls / Display ▾

Language ▾

The display can be set to appear in one of several different languages.

The flag ▾ after the word *Language* acts as a guide in case a language which is not understood is set.

The language selected is saved to memory.

Code

The PIN code prevents the washing machine being used without your knowledge.

Options

- Activate
When the PIN code has been activated, you have to enter the PIN code after switching the washing machine on. Otherwise the washing machine cannot be operated.
The factory default PIN code is 125.
- Change
However, you can set a different, three-digit PIN code.

 Do not forget the PIN code you have set.

Without a PIN code, only Miele Technical Service can unlock the washing machine.

Make a note of the new PIN code.

- Deactivate
The washing machine is to be operated again without entering the PIN code. This only appears if the PIN code has been activated previously.

Memory

The washing machine will save the last settings (temperature, spin speed, and some of the extra options) selected for a program after the program has started.

When the program is chosen again, the saved settings will appear in the display.

Memory is deactivated as standard.

Clock display

After selecting the clock format, you can set the time of day.

Clock format

- 24 h clock (factory default)
- 12 h clock

Time

- The time can be set.

Volume

Program end tone

The volume of the audible signal that sounds at the end of the program can be changed.

It can be set to one of 7 different levels or switched off altogether.

Keypad tone

The volume of the audible signal that sounds when a sensor button is touched can be changed.

It can be set to one of 7 different levels or switched off altogether.

Display Brightness

The brightness of the display can be altered.

It can be set to one of 7 different levels.

Temperature unit

The temperature and spin speed values can be displayed in different ways.

Options

- Clear text (factory default)
The values are displayed as words.
- °C / Celsius
The temperatures are displayed as figures in °C.
- °F / Fahrenheit
The temperatures are displayed as figures in °F.

“Display” off status

The display and the sensor button lighting is switched off to save energy. The *Start/Stop* sensor button flashes slowly.

Options

- Off
The lighting remains switched on.
- On (factory default)
The lighting switches off after 10 minutes.
- On -not in current prog.
The lighting remains switched on throughout the program. The lighting switches off 10 minutes after the program has ended.

Settings

Program Sequence

TwinDos

You can set and check the dispensing quantities.

Select type of detergent

You can either use UltraPhase 1 and UltraPhase 2, or switch TwinDos dispensing off.

Use the **No agent** setting to switch TwinDos dispensing off.

Change dosage

The set values for dispensing UltraPhase 1 and UltraPhase 2 detergent can be checked and corrected.

Soiling

Allows selection of default setting for level of soiling.

The following soiling levels are available to choose from:

- Light
- Normal
- Heavy

The factory default setting is: Normal

Maximum rinse level

The water level in the rinse can be permanently set to the highest value.

This function is important for allergy sufferers as it achieves excellent wash results. The water consumption will be increased.

The maximum rinse level is deactivated as standard.

Soak duration

You can set a duration for the soak process of between 30 minutes and 6 hours.

A duration can be selected in 30-minute increments. When the *Soak* extra option is selected, the laundry will be soaked for the duration selected.

A duration of 0:30 h is set as standard.

Extra Gentle

With gentle action activated, drum rotation is reduced. In this way, lightly soiled items can be washed more gently.

Gentle action can be activated for the *Normal* and *Wrinkle-free* programs.

Gentle action is deactivated as standard.

Anti-crease

The Anti-crease function reduces creasing after the end of the program.

At the end of the program, the drum continues to turn at intervals for up to 30 min. The washing machine door can be unlocked and then opened at any time by touching the *Start/Stop* sensor button.

Anti-crease is activated as standard.

Bleach

You can activate the automatic addition of chlorine bleach at the end of the main wash.

Chlorine bleach may only be used in some programs. See “5. Adding detergent – Using chlorine bleach” for more detailed information.

Activating chlorine bleach extends the program duration by approximately 10 minutes.

The washing machine is delivered with the chlorine bleach setting deactivated.

Settings

Network

Miele@home

Control the networking of your washing machine with your Wi-Fi network.

The following points may appear in the sub-menu:

Set up

This message only appears if the washing machine has not yet been connected to a Wi-Fi network.

Please refer to “Initial commissioning” for instructions on how to set up the connection.

Activate

(visible if Miele@home is deactivated)

The Wi-Fi function is reactivated.

Deactivate

(visible if Miele@home is activated)

Miele@home remains set up; the Wi-Fi function is turned off.

Connection status

(visible if Miele@home is activated)

The following values are displayed:

- the quality of Wi-Fi reception
- the network name
- the IP address

Set up again

(visible if set up)

Resets the Wi-Fi login (network) to immediately re-establish a new connection.

Reset

(visible if set up)

- The Wi-Fi is switched off.
- The Wi-Fi connection will be reset to the factory default setting.

The network configuration should be reset whenever a washing machine is being disposed of or sold, or if a used washing machine is being put into operation. This is the only way to ensure that all personal data has been removed and the previous owner will no longer be able to access the washing machine.

A new connection setup has to be carried out in order to use the Miele@home setting again.

SmartGrid

The SmartGrid setting is only visible if the Miele@home setting is set up and activated.

You can set your washing machine to start automatically based on an external signal within a certain time period.

Activating SmartGrid gives the *Timer* sensor button a new function. Use the *Timer* sensor button to set *SmartStart*. The washing machine will then start within the time period specified by you when it receives an external signal. If an external signal has not been received by the latest start time set, the washing machine will start automatically (see “Delay start”).

SmartGrid is deactivated as standard.

Remote Control

The Remote Control setting is only visible if the Miele@home setting is set up and activated.

Once the Miele app has been installed on your mobile device, you can check the status of your washing machine from anywhere and start it remotely. You can also control it remotely via the *MobileStart* program.

You can switch off the *Remote Control* setting if you do not want to operate the washing machine with your mobile device.

If *Remote Control* is not switched on, the app can still be used to cancel a program.

Use the *Timer* sensor button to set a timeframe within which you want to start the washing machine, and start the timer (see “*Timer*”).

The washing machine will then start within the timeframe specified when it receives your signal.

If it has not received a start signal by the latest start time set, the washing machine will start automatically.

Remote control is activated by default.

Settings

RemoteUpdate

The RemoteUpdate menu option is only displayed and can only be selected if the requirements for using Miele@home have been met (see “Initial commissioning – Miele@home”).

The RemoteUpdate function updates the software in your washing machine. If an update is available for your washing machine, it will automatically download it. Updates will not be installed automatically. They must be initiated manually.

If you do not install an update, you can continue to use your washing machine in the usual way. However, Miele recommends installing updates.

Activating / deactivating

The RemoteUpdate function is activated as standard. Available updates will be downloaded automatically but will only be installed if you initiate installation manually.

Deactivate RemoteUpdate if you do not want any updates to be downloaded automatically.

Running a RemoteUpdate

Information about the content and scope of an update is provided in the Miele app.

A message will appear in your washing machine display if a software update is available.

You can install the update immediately or postpone this until later. When the washing machine is switched on again, you will be reminded about the update.

Deactivate RemoteUpdate if you do not want to install the update.

The update may take several minutes.

Please note the following information about the RemoteUpdate function:

- You will only receive a message when an update is available.
- Once an update has been installed, it cannot be undone.
- Do not switch off the washing machine during an update. Otherwise, the update will be aborted and will not be installed.
- Some software updates can only be carried out by Miele Service.

Appliance parameters

Legal Information

[Open Source Licenses](#)

You can view information here.

Copyrights and licenses for operator and control software

For the purpose of operating and controlling the appliance, Miele uses proprietary or third-party software that is not covered by open source licensing terms. These items of software/software components are protected by copyright. The copyright powers of Miele and third parties must be respected.

In addition, the appliance contains software components which are distributed under open source licensing terms. You can access these open source components along with the associated copyright notices, copies of the valid licensing terms, and any further information in the appliance under the menu option [Settings | Appliance parameters | Legal information | Open source licences](#). **The liability and warranty arrangements for the open source licences displayed at this location only apply in relation to the respective rights holders.**

Copyrights and licenses for the communication module

For the purpose of operating and controlling the communication module, Miele uses proprietary or third-party software that is not covered by open source licensing terms. These items of software/software components are protected by copyright. The copyrights held by Miele and third parties must be respected.

In addition, the communication module contains software components which are distributed under open source licensing terms. The open source components contained in the appliance along with the corresponding copyright notices, copies of the licensing terms valid at the time, and any further information can be accessed locally via IP using a web browser (<http://<IP address>/Licenses>). The liability and warranty arrangements for the open source licences displayed in this location only apply in relation to the respective rights holders.

Settings

Water intake

You can program 2 options for the water inlet. The water inlet is controlled by the two inlet hoses.

Options

- Cold water
The washing machine will be operated with cold water only.
- Hot main wash (factory setting)
Hot water is used in the main wash to save energy.
You can heat up your water with cheaper, primary energy sources, e.g. gas, solar power, oil. The temperature must be below 140 °F (60 °C).

 For technical reasons, the washing machine **must** always be connected to cold water.

Installation requirements

Low water pressure

If the water pressure is below 100 kPa (1 bar), the program will be cancelled and the fault message *Water intake fault*. Open the water supply. **will appear.**

If the on-site water pressure cannot be increased, activating this function will prevent the program from being cancelled.

Low water pressure is deactivated as standard.

Suds cooling

Additional water flows into the drum at the end of the main wash to cool the suds down.

Suds cooling takes place when a Normal program with a temperature of 70°C or higher is selected.

Suds cooling should be activated:

- to prevent the danger of scalding if the drain hose is hooked over the edge of a sink or basin
- where the drainage pipes do not comply with DIN 1986

Suds cooling is deactivated as standard.

Temperature reduction

At high altitudes, water has a lower boiling point. Miele recommends activating the reduced-temperature setting at altitudes of 2,000 m or above to prevent water from boiling. The maximum temperature is reduced to 80°C, even if a higher temperature is selected.

The reduced-temperature setting is deactivated as standard.

Detergents and care products

Detergent, fabric care products, additives, and machine care products are available for this washing machine. All the products have been designed for Miele Washing Machines.

These and many other useful products can be ordered via the Miele online shop, from your Miele dealer, or from Miele directly.

Detergent

Miele UltraPhase 1 and 2

- 2-component detergent for whites and colours
- For brilliant colours and spotlessly white laundry
- Excellent stain removal even at low temperatures

Miele UltraPhase 1 and 2 Sensitive

- 2-component detergent for whites and colours
- No fragrances or colorants – particularly kind to the skin
- Eco-friendliness verified by Nordic Swan
- Excellent stain removal even at low temperatures

UltraWhite (powder detergent)

- Best results at 20 / 30 / 40 / 60 / 75°C
- Radiant white laundry thanks to powerful formula with active oxygen
- Excellent stain removal even at low temperatures

UltraColor (liquid detergent)

- Best wash results at 20 / 30 / 40 / 60°C
- With colour-protection formula for brilliant colours
- Excellent stain removal even at low temperatures

WoolCare delicates detergent (liquid detergent)

- For wool, silks, and delicates
- Special care complex based on wheat protein and with colour-protection formula
- Best wash results at 20 / 30 / 40 / 60°C

Special-purpose detergents

These special-purpose detergents are available as convenient single-use caps.

Caps Sport

- For synthetic fabrics
- Neutralizes unpleasant odours thanks to odour absorber
- Prevents static charge in clothes
- Retains the shape and breathability of synthetic fabrics

Caps DownCare

- For down-filled items
- Retains the elasticity and breathability of down
- Lanolin for effective cleaning and gentle care
- Down does not clump and remains fluffy

Caps Woolcare

- Wool and delicates detergent
- Special wheat-protein-based agents
- Fibre-protection technology to help prevent pilling
- Colour-protection formula for gentle cleaning

Caps CottonRepair

- Special-purpose detergent for cotton fabrics
- Visibly renews fabrics with just one wash
- Special Miele formula with Novozymes technology
- Removes pilling and renews colour intensity and brightness
- Depending on fabric do not use more than 1–2 times per year

Detergents and care products

Fabric care

These fabric care products are available as convenient single-use caps.

Fabric softener cap

- Fabric softener for freshly scented laundry
- Pure and thorough cleanliness with a fresh scent
- For soft, bouncy laundry
- Prevents static charge in clothes

Additives

Additives are available as convenient single-use caps.

Cap Booster

- Highly effective stain remover
- Enzyme technology to help remove stubborn stains
- Suitable for whites and colours
- For best wash results even at low temperatures

Machine care

TwinDosCare

- Cleaning agent for the TwinDos dispensing system
- For use prior to a longer pause in use (at least 2 months)
- For use prior to changing to a different product

Descaling agent

- Removes heavy limescale deposits
- Mild and gentle with natural citric acid
- Gentle on heater elements, drum, and other components

IntenseClean

- For hygienic cleanliness in washing machines
- Removes grease, bacteria, and associated unpleasant odours
- Effective thorough cleaning

Water softener tablets

- Reduces quantities of detergent for hard water
- Less detergent residue in fabrics
- Less chemicals in waste water due to reduced amount of detergent

**Please have the model and serial number
of your appliance available when
contacting Customer Service.**

**Canada
Importer
Miele Limited**

Headquarters and Miele Centre

161 Four Valley Drive
Vaughan, ON L4K 4V8
www.miele.ca

Customer Care Centre

Phone: 1-800-565-6435
customercare@miele.ca

**Germany
Manufacturer**

Miele & Cie. KG
Carl-Miele-Straße 29
33332 Gütersloh

WXR 860

en-CA

M.-Nr. 11 669 431 / 03