

## Operating Instructions Dishwashers



To prevent accidents and machine damage, read these instructions before installation or use.

# Contents

---

<b>IMPORTANT SAFETY INSTRUCTIONS</b> .....	<b>5</b>
<b>Notes on the operating instructions</b> .....	<b>13</b>
Notes on the layout.....	13
<b>Scope of delivery</b> .....	<b>14</b>
<b>Guide to the appliance</b> .....	<b>15</b>
Appliance overview .....	15
Lower basket.....	16
Control field.....	17
Display functions .....	18
<b>Caring for the environment</b> .....	<b>19</b>
<b>Before using for the first time</b> .....	<b>20</b>
Opening the door .....	20
Closing the door .....	21
Miele@home (depending on model) .....	22
Basic settings.....	23
Setting the language .....	23
Setting up Miele@home (depending on model) .....	23
Setting the water hardness .....	24
Activating AutoDos.....	24
Reactivation salt .....	26
Filling the salt reservoir .....	27
Refilling the salt.....	28
Rinse aid .....	29
Adding rinse aid.....	30
Filling the rinse-aid reservoir.....	30
<b>Settings</b> .....	<b>31</b>
Opening the settings menu .....	31
Changing settings.....	31
Closing the settings menu .....	31
Language  .....	32
Water hardness.....	32
AutoDos (AutoDos).....	33
Rinse Aid.....	34
Save Extras.....	34
Miele@home (depending on the model).....	34
Performing Scan & Connect.....	35
Remote control (depending on the model) .....	37
Remote update (depending on the model) .....	37
Display brightness.....	38
Buzzer.....	38

Refill reminders .....	39
AutoOpen .....	39
2nd interim rinse .....	40
Hygiene cycle.....	40
Water connection.....	40
Information.....	40
Showroom program .....	41
Factory default.....	41
Copyrights and licenses for the communication module.....	41
<b>Caring for the environment .....</b>	<b>42</b>
Energy-saving dishwashing.....	42
<b>Loading the dishwasher.....</b>	<b>43</b>
General information .....	43
Loading examples.....	45
Upper basket.....	47
Adjusting the upper basket .....	49
Lower basket.....	50
Cutlery tray.....	54
Loading the 3D MultiFlex Tray.....	54
<b>Detergents .....</b>	<b>55</b>
Active ingredients .....	55
Detergent dispensing.....	56
Automatic dispensing/AutoDos.....	57
Activating AutoDos.....	57
Inserting a PowerDisk.....	58
Manual detergent dispensing.....	60
Detergent dispensing.....	60
Adding detergent .....	60
<b>Operation .....</b>	<b>62</b>
Turning on the dishwasher .....	62
Selecting a program .....	62
Display of program duration .....	63
Starting a program .....	63
End of the program.....	64
Energy management .....	64
Turning off the dishwasher.....	65
Unloading the dishwasher .....	65
Interrupting a program.....	66
Canceling or changing a program.....	66
<b>Options.....</b>	<b>67</b>
⌚ Timer .....	67

# Contents

---

Activating Remote start.....	69
Operating hours display .....	69
<b>Program overview .....</b>	<b>70</b>
<b>Options.....</b>	<b>74</b>
Selecting Extras .....	74
<b>Cleaning and care .....</b>	<b>76</b>
Cleaning the wash cabinet.....	76
Cleaning the door and the door seal .....	76
Cleaning the control field .....	76
Cleaning the reflector panel.....	76
Cleaning the appliance front.....	77
Cleaning the AutoDos assembly.....	78
Cleaning the spray arms .....	80
Checking the filters in the wash cabinet.....	84
Cleaning the filters .....	84
Cleaning the drain pump .....	86
<b>Frequently asked questions.....</b>	<b>88</b>
Technical faults .....	88
Fault messages .....	89
Door release.....	89
Water intake fault .....	90
Water drainage fault.....	91
Fault in the AutoDos (automatic dispensing).....	92
Spray arm fault.....	94
General dishwasher problems.....	94
Noises .....	95
Poor cleaning results.....	96
<b>Customer Service .....</b>	<b>100</b>
Contact in the event of a fault .....	100
Appliance warranty and product registration .....	100
<b>Optional accessories.....</b>	<b>101</b>
<b>Installation.....</b>	<b>103</b>
Water inlet.....	103
Water drainage.....	105
<b>Sound emission testing .....</b>	<b>108</b>

# IMPORTANT SAFETY INSTRUCTIONS

This dishwasher complies with all current local and national safety requirements. Inappropriate use can, however, lead to personal injury and material damage.

Please observe the installation sheet and read the operating instructions carefully before setting up the dishwasher and using it for the first time. They both contain important information on the installation, safety, use, and maintenance of the machine. This prevents both personal injury and damage to the dishwasher.

Miele expressly and strongly advises that you read and follow the instructions in the section on installing the dishwasher as well as the IMPORTANT SAFETY INSTRUCTIONS.

Miele cannot be held liable for injury or damage caused by non-compliance with these instructions.

Keep the installation sheet and the operating instructions in a safe place and pass them on to any future owner.

## Appropriate use

- ▶ This dishwasher is intended for use in the home and in similar environments, for example
  - in shops, offices, and similar work settings
  - on agricultural estates
  - by guests in hotels, motels, bed and breakfasts, and other typical home settings.
- ▶ This dishwasher is not suitable for outdoor use.
- ▶ This dishwasher is intended for use at altitudes of up to 13,000 ft (4,000 m) above sea level.
- ▶ This dishwasher must only be used for cleaning domestic dishes and cutlery. All other types of use are not permitted.
- ▶ This appliance is not intended for use by persons (including children) with reduced physical, sensory or mental capabilities, or lack of experience and knowledge.

## Safety with children

- ▶ Children must be kept away from the dishwasher unless they are constantly supervised.
- ▶ Children must not be allowed to clean or maintain the appliance.

## IMPORTANT SAFETY INSTRUCTIONS

---

- ▶ Children should be supervised in the vicinity of the dishwasher. Never allow children to play with the dishwasher. There is a danger that children might shut themselves in the dishwasher.
- ▶ If the automatic door opening mechanism is active, keep young children away from the area in which the door opens. There is a danger of injury in the unlikely event of a fault with the opening mechanism.
- ▶ Danger of suffocation. While playing, children may become entangled in packaging material (such as plastic wrapping) or pull it over their head with the risk of suffocation. Keep packaging material away from children.
- ▶ Keep children away from detergents. Detergents cause severe skin burns and severe eye damage. They can cause burning in the mouth and throat, or inhibit breathing. It is therefore important to keep children away from the dishwasher when the door is open. Detergent residues could still be present in the machine. Seek medical advice immediately if a child has swallowed or inhaled any detergents.

### Technical safety

- ▶ Unauthorized installation, maintenance, and repairs can cause considerable danger for the user. Installation, maintenance, and repairs should only be carried out by a Miele authorized technician.
- ▶ Damage to the dishwasher can compromise your safety. Before using the dishwasher and in particular following transport, check it for any visible damage. Never use a damaged dishwasher.
- ▶ The electrical safety of the dishwasher can only be guaranteed when correctly grounded. It is most important that this basic safety requirement is fulfilled. If in doubt, the electrical installation should be checked by a qualified service technician.  
Miele cannot be held liable for the consequences of an inadequate or lack of grounding system (e.g., electric shock).

## IMPORTANT SAFETY INSTRUCTIONS

---

▶ Temporary or permanent operation on an autonomous power supply system or a power supply system that is not synchronized with the grid power supply (e.g., island networks, back-up systems) is possible. A prerequisite for operation is that the power supply system complies with national and local codes.

The function and operation of the protective measures provided in the domestic electrical installation and in this Miele product must also be maintained in isolated operation or in operation that is not synchronized with the grid power supply, or these measures must be replaced by equivalent measures in the installation.

▶ Where the dishwasher is plugged into the electricity supply using a 3-pin plug with a grounding contact, the electrical socket must be easily accessible after the dishwasher is installed so that it can be disconnected from the electricity supply at any time.

▶ There must be no electrical sockets behind the dishwasher because the building-in niche may be too small. Danger of overheating and fire risk if the dishwasher were to be pushed up against a plug.

▶ The dishwasher must not be installed underneath a cooktop. The high temperatures radiated by cooktops could damage the dishwasher below. For the same reason, the dishwasher must not be installed next to open fires or other appliances that give off heat, such as heaters etc., not normally found in a kitchen.

▶ Ensure that the connection data on the dishwasher's data plate (fuse rating, frequency, and voltage) match the electricity supply. This data must correspond in order to avoid the risk of damage to the dishwasher. Compare these before connecting the appliance to the electricity supply. If in any doubt, consult a qualified service technician.

▶ Do not connect the dishwasher to the electricity supply until it has been fully installed and any adjustment has been made to the door springs.

## IMPORTANT SAFETY INSTRUCTIONS

---

▶ The dishwasher may only be operated if the door opening mechanism is working correctly. Otherwise, there could be a risk of danger while the automatic door opening mechanism is active.

To check that the door opening mechanism is working correctly:

- The door springs must be evenly adjusted on both sides. They are correctly adjusted when the door remains stationary when left half open (approx. 45° opening angle). It is also important that the door cannot fall open.
- The door locking rail automatically retracts when the door opens at the end of the drying phase.

▶ Power bars and extension cords do not guarantee the required safety of the appliance (risk of fire). Do not connect the dishwasher to the electricity supply using a power bar or an extension cord.

▶ The dishwasher must not be used in a non-stationary location (e.g., on a ship).

▶ Do not install the dishwasher in a room where there is a risk of frost. Frozen hoses are at risk of tearing or bursting. The reliability of the electronic control unit may be impaired at temperatures below freezing point.

▶ To avoid any damage to the dishwasher, it must only be operated when it is connected to a fully vented plumbing system.

▶ The built-in Miele Waterproof system offers reliable protection against water damage if the following conditions are met:

- Installation has been carried out correctly.
- The dishwasher is properly maintained and parts are replaced in case of noticeable damage.
- The water supply faucet is turned off during longer absences from the home (e.g., while on vacation).

The Waterproof system will work even when the dishwasher is switched off. However, the dishwasher must remain connected to the electricity supply.

▶ The water-connection pressure needs to be between 7.25 and 145 psi (50 and 1,000 kPa).

▶ A damaged dishwasher could be dangerous. If the dishwasher gets damaged, turn it off at the electricity supply immediately and contact your Miele dealer or Miele Customer Service.



## IMPORTANT SAFETY INSTRUCTIONS

- ▶ The manufacturer's warranty may be invalidated if the appliance is not repaired to Miele authorized service standards.
- ▶ We recommend replacing defective components with original parts. If original Miele parts are installed correctly, Miele ensures full compliance with safety requirements and the warranty remains valid.
- ▶ During installation, maintenance, and repair work, the dishwasher must be disconnected from the electricity supply (turn it off and withdraw the plug from the socket).
- ▶ If the power cord is damaged, it must only be replaced with a specific cord of the same type (available from Miele Customer Service). For safety reasons, this must only be done by Miele Customer Service or a service technician authorized by Miele.
- ▶ Do not place the dishwasher on the water inlet hose. The water inlet hose must be free of kinks and able to move freely after installation.  
Do not install the water inlet hose or the power cord next to a heat source, such as a hot water pipe.  
Do not expose the water inlet hose or the power cord to household cleaners, vapors or other corrosive substances (such as chloride).  
Damage to the power cord or water inlet hose can lead to electric shocks or water damage.  
Check the water inlet hose or the power cord for leaks and damage after installation and every 6 months thereafter. Have the water inlet hose or the power cord replaced if there are signs of damage.  
The same applies to the drain hose.

### Correct installation

- ▶ The dishwasher must be installed and connected in compliance with the supplied installation sheet.



- ▶ Be careful before and while installing the dishwasher. Some metal parts pose a risk of injury/being cut. Wear protective gloves.

- ▶ Ensure that the dishwasher is installed in a way that does not cause the doors to be blocked when the door is automatically opened (AutoOpen function).

## IMPORTANT SAFETY INSTRUCTIONS

---

▶ If the dishwasher is being used behind closed cabinet fronts (e.g., doors), ensure that the automatic door opening mechanism is not blocked.

The cabinets used must be sufficiently resistant to moisture.

The installation space must be well ventilated.

▶ The dishwasher must be correctly aligned horizontally to ensure problem-free operation.

▶ In order to ensure stability, built-under and integrated dishwashers must only be installed under a continuous countertop which is secured to adjacent cabinetry.

▶ A sink in the adjacent cabinet of the dishwasher must be carefully sealed. Regularly check for leaks to avoid damage to the dishwasher.

▶ The dishwasher must only be built into a tall cabinet if additional safety precautions are taken. In order to safely install the appliance in a tall cabinet, please use the tall cabinet installation kit and observe the installation sheet provided. Otherwise there is the danger of the cabinet tipping over.

▶ The door springs must be evenly adjusted on both sides. They are correctly adjusted when the door remains stationary when left half open (approx. 45° opening angle). It is also important that the door cannot fall open.

The machine must only be operated with properly adjusted door springs.

If the door cannot be adjusted properly, contact Miele.

The minimum/maximum weight of the front panel is quoted in the technical data for your dishwasher on the Miele website.

### Correct use

▶ Do not use solvents in the dishwasher. There is a danger of explosion.

▶ Dishwasher detergents can cause burning on the skin and in the eyes, nose, mouth, and throat. Avoid contact with detergents. Do not inhale powder detergents. Do not swallow dishwasher detergents. Seek medical attention immediately if detergent has been swallowed or inhaled.

▶ Avoid leaving the dishwasher door open unnecessarily. You could injure yourself on the opened door or trip over it.

▶ Do not sit, stand, or lean on the opened door. The dishwasher can tip over. This could injure you or damage the dishwasher.

## IMPORTANT SAFETY INSTRUCTIONS

---

- ▶ Dishes may be very hot at the end of the program. Allow the dishes to cool until they are comfortable enough to handle before unloading them.
- ▶ Only use detergent and rinse aid formulated for domestic dishwashers. Do not use liquid dish soap.
- ▶ Do not use any commercial or industrial detergents. These may cause material damage, and there is a risk of a severe explosive chemical reaction (such as an explosive oxyhydrogen gas reaction).
- ▶ Do not fill the rinse aid reservoir with powder or liquid detergent. This will cause damage to the rinse aid reservoir.
- ▶ Do not fill the AutoDos with powder or liquid detergent. Loose detergent will damage the AutoDos.
- ▶ Do not fill the salt reservoir with powder or liquid detergent. Dishwasher detergent will damage the softener assembly.
- ▶ Use only special, coarse-grained reactivation salt. Other types of salt may contain insoluble components which can cause the water softener to malfunction.
- ▶ In dishwashers with a cutlery basket (depending on model), knives and forks should be placed with the handles upwards in the basket for safety reasons. Knives and forks placed with the handles downwards pose a danger of injury.
- ▶ Plastic items which cannot withstand being washed in hot water, such as disposable plastic containers or plastic cutlery, should not be cleaned in the dishwasher. The high temperatures in the dishwasher may cause them to melt or lose shape.
- ▶ If you use the timer option, the cleaning agent compartment must be dry. Wipe dry with a cloth first if necessary. The cleaning agent will clump together if the cleaning agent compartment is not dry, and this may mean that it is not fully rinsed out.

### **Accessories and parts**

- ▶ Only use original Miele accessories. If other parts are used, warranty, performance, and, if applicable, product liability claims will be invalidated.

### **Transport**

- ▶ Damage to the dishwasher can compromise your safety. Before using the dishwasher, check it for any visible transport damage. Never use a damaged dishwasher.

## IMPORTANT SAFETY INSTRUCTIONS

---

- ▶ Only transport the dishwasher in an upright position so that no water flows into the electrical controls, as this would cause faults.
- ▶ If you wish to transport the dishwasher, empty it and securely fasten all loose parts such as baskets, hoses, and power cords.

### Disposal of your old dishwasher

- ▶ Remove the door of the dishwasher so that children cannot become trapped inside.

### California Proposition 65

#### WARNING

This product can expose you to chemicals mineral oils<sup>1</sup>, Nickel (Metallic)<sup>1</sup>, Diisononyl phthalate (DINP)<sup>1</sup> and Di-isodecyl phthalate (DIDP)<sup>2</sup>, which are known to the State of California to cause <sup>1</sup>cancer and <sup>2</sup>birth defects or <sup>2</sup>other reproductive harm.

For more information go to [www.P65Warnings.ca.gov](http://www.P65Warnings.ca.gov).

### FCC Declaration of Conformity

- ▶ These devices comply with FCC Rules Part 15. This equipment has been tested and found to be in compliance with the limits for a Class B digital device, pursuant to Part 15 of the FCC Rules of Operation and is subject to the following conditions:  
These devices may not cause harmful interference.  
These devices must accept any interference received, including interference that may cause undesired operation.

### FCC Radiation Exposure Statement

- ▶ This equipment complies with FCC radiation exposure limits set forth for an uncontrolled environment. This equipment should be installed and operated with minimum distance 8" (20 cm) between the radiator and your body.

### Industry Canada Statement

- ▶ This digital apparatus does not exceed the Class B limits for Radio Noise Emissions from digital apparatus set out in the Radio Interference Regulations of the Canadian Department of Communications. Complies with Canadian ICES-003 Class B specifications.

# Notes on the operating instructions

These operating instructions apply to several different dishwasher models of different heights.

The specific dishwasher models are referred to as follows:

Standard = 32 1/16" (81.5 cm) high dishwashers (integrated)  
and 33 11/16" (85.5 cm) high dishwashers (freestanding)

XXL = 33 11/16" (85.5 cm) high dishwashers (integrated).

## Notes on the layout

### Warnings

 Warnings important for safety are highlighted like this. This alerts you to the potential danger of injury to people or damage to property.

Read the warnings carefully and follow the instructions and directions.

### Notes

Notes contain information that is particularly important to follow. They are highlighted in a thick framed box.

### Additional information and comments

Additional information and comments are contained in a narrow frame.

### Instructions for the user

Instructions on how to operate the dishwasher are identified by marked operating steps. They explain the procedure step by step.

Operating steps are indicated by a black square bullet point.

Example:

■ Select the setting you want and press *OK* to confirm.

### Display

Information that is shown in the dishwasher display appears in a special font similar to the display text.

Example:

When the message *Close the door* appears in the display ...

## Scope of delivery

---

The following items are supplied:

- dishwasher
- operating instructions for using the dishwasher
- installation sheet for installing the dishwasher
- other installation accessories for installing the dishwasher (see installation sheet)
- funnel for filling the reactivation salt (if available)
- additional printed matter and add-ons if required

## Appliance overview

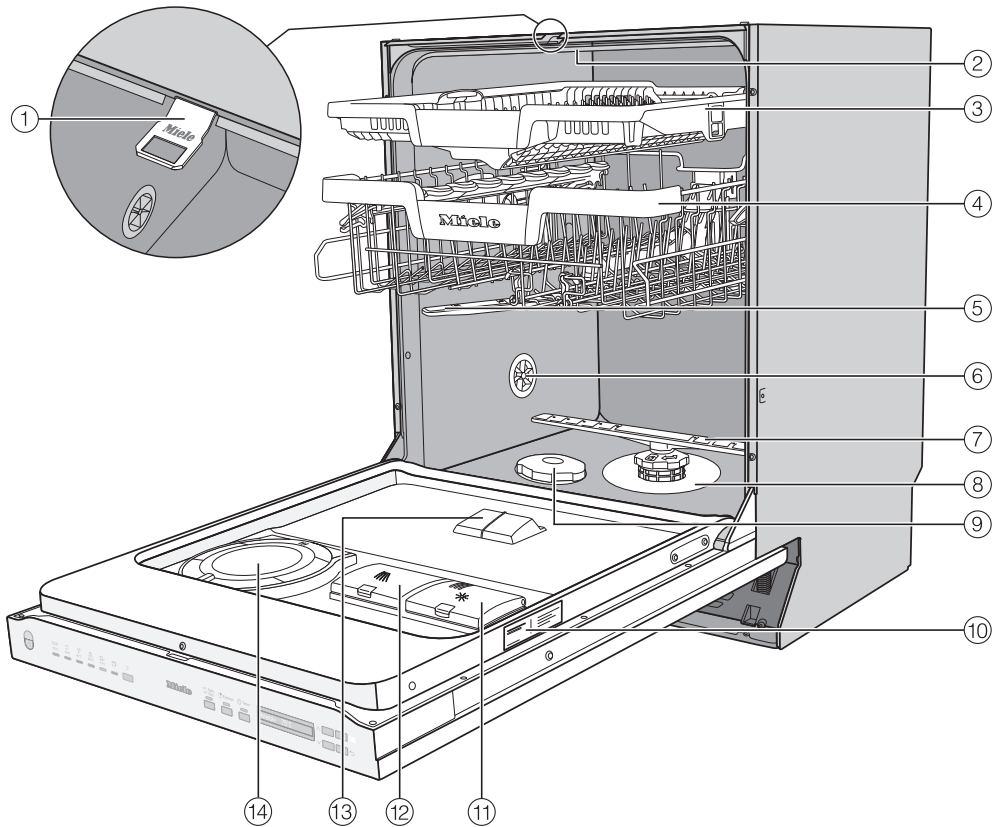

- ① Door locking pins
  - ② Top spray arm
  - ③ 3D MultiFlex cutlery tray
  - ④ Upper basket (depending on model)
  - ⑤ Middle spray arm
  - ⑥ Aeration valve
  - ⑦ Bottom spray arm
  - ⑧ Filter combination
  - ⑨ Salt reservoir
  - ⑩ Data plate
  - ⑪ Rinse aid reservoir
  - ⑫ Detergent compartment
  - ⑬ AutoDos detergent outlet
  - ⑭ AutoDos (automatic dispensing)
- Lower basket (see next page)

# Guide to the appliance

---

## Lower basket

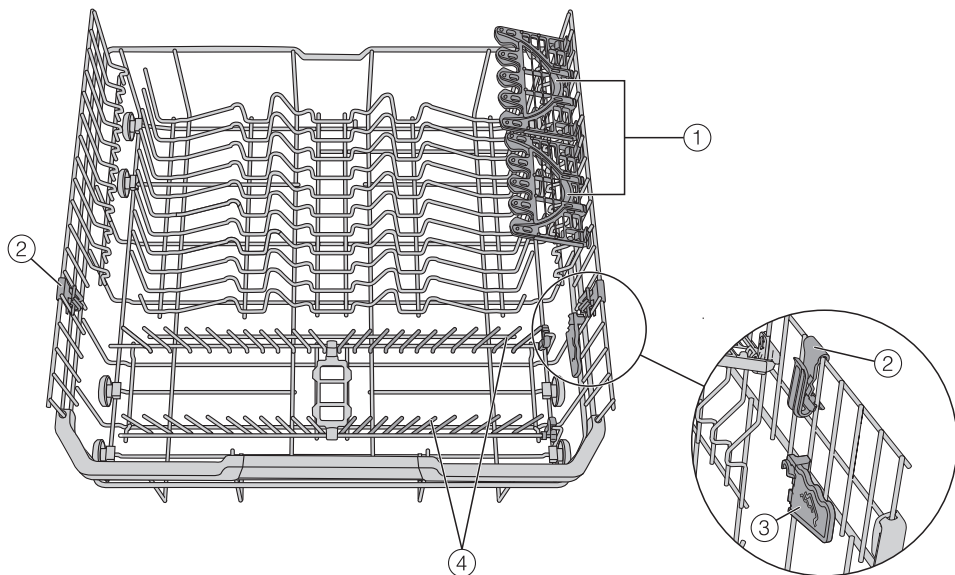

① FlexCare Glass & Bottle

② MultiClip







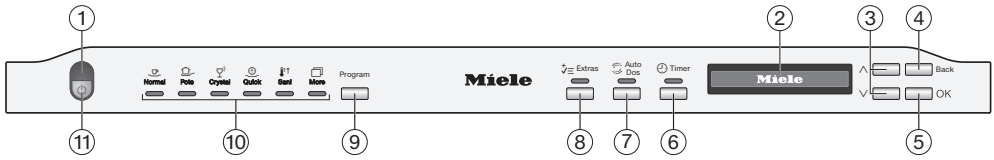

③ XL-Assist

④ Hinged spikes



## Control field



- ① In-operation indicator light  
For indicating an ongoing wash program when the door is closed.
- ② Display  
For further information, see “Display functions” under “Guide to the appliance”.
- ③ ∨∧ buttons  
For program selection.  
For changing the values displayed.  
For scrolling to other menu pages.
- ④ *Back* button  
For navigating back to the previous menu or deleting values which have been set previously.
- ⑤ *OK* button  
To select menu options and values displayed.  
To confirm messages.
- ⑥ ⏸ *Timer* button  
For selecting a later program start.
- ⑦  *AutoDos* button  
For activating/deactivating AutoDos.
- ⑧  *Extras* button  
for selecting extras
- ⑨ *Program* program selection button  
For program selection.
- ⑩ Program selection
  -  Normal = Normal
  -  Pots = Pots & Pans
  -  Crystal = China & Crystal
  -  Quick = QuickIntenseWash
  -  Sani = SaniWash
  -  More = Additional programs/ settings
- ⑪  *On/Off* button  
For turning the dishwasher on and off.

# Guide to the appliance

---

## Display functions

The display is used to select or set the following:

- the program
- the Timer
- the Settings 



The display can show the following:

- the program stage
- The estimated time left for the program to run
- Any relevant fault messages and information

To save energy, the dishwasher switches off after a few minutes if you do not press any buttons during this time.

Press the  button to switch the dishwasher back on.

The *OK* button is used to confirm a message or setting and also to move to the next menu or another level.

Under  *More*, a scroll bar  will appear in the right of the display. This offers further options. These options can be shown using the  $\nabla/\wedge$  buttons.

You can alter the dishwasher's controls to suit changing requirements in the "Settings" menu (see "Settings").

The option which is selected will have a check  next to it.

To exit a sub-menu again, press the *Back* button.

If you do not press any buttons for several seconds, the display will revert to the previous menu. You will then have to enter your settings again.

### Disposal of the packing material

The cardboard box and packing materials protect the appliance during shipping. They have been designed to be biodegradable and recyclable.

Ensure that any plastic wrappings, bags, etc. are disposed of safely and kept out of the reach of children. Danger of suffocation!

### Disposal of your old appliance

Electrical and electronic appliances contain valuable materials. They also contain certain substances, compounds and components which were essential for the proper functioning and safe use of the equipment. Handling these materials improperly by disposing of them in your household waste can be harmful to your health and the environment. Therefore, please do not dispose of your old appliance with regular household waste and follow local regulations on proper disposal.



Consult with local authorities, dealers or Miele in order to dispose of and recycle electrical and electronic appliances. Miele assumes no responsibility for deleting any personal data left on the appliance being disposed. Please ensure that your old appliance is kept away from children until removal. Observe safety requirements for appliances that may tip over or pose an entrapment hazard.

## Before using for the first time

Every dishwasher is tested at the factory. There will be residual water in the machine from this test. It is not an indication that the dishwasher has been used previously.

### Opening the door

In some programs, the door automatically opens slightly to assist the drying process.

This function can be deactivated, if preferred (see “AutoOpen” under “Settings”).

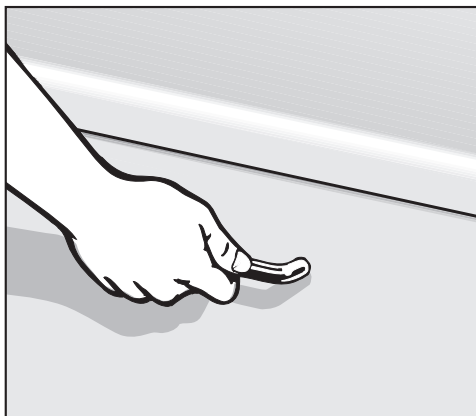

- Pull the handle hard to open the door.
- Open the door fully to disengage the locking mechanism.

At the end of the program, if the AutoOpen function is on, the door locking rail automatically retracts.

The door locking rail must be fully retracted before you close the door again.

To prevent a technical fault, do not hold the door locking rail when retracting.

If the door is opened during operation, all functions are automatically interrupted.

⚠ Risk of scalding due to hot water.  
During operation, water in the dishwasher may be very hot.  
During operation, only open the door with extreme caution.

⚠ Risk of injury due to door opening automatically.  
The door may open automatically at the end of the program.  
Keep the area around the door free of obstructions.

⚠ Caution: Avoid blocking doors.  
The automatic door opening function could cause doors to be blocked.  
Install the dishwasher so that the door does not block any other doors or cabinet fronts when it opens automatically.

### Closing the door

- Push the baskets in.
- Raise the door upward until the catch engages.

At the end of the program, if the AutoOpen function is on, the door locking rail must be fully retracted before the door is closed. Otherwise, the door locking rail will cause the door to reopen.



Risk of crushing due to the door closing.

When closing the door, you are at risk of shutting your fingers in it.

Do not put your hand inside the door as it is closing.

## Before using for the first time

---

### Miele@home (depending on model)

Your dishwasher is equipped with an integrated WiFi module.

To use this feature, you will need:

- A WiFi network
- The Miele app
- A Miele user account. The user account can be created via the Miele app

The Miele app will guide you as you connect your dishwasher to your home WiFi network.

Once your dishwasher is connected to your WiFi network, you can use the app, for example, to carry out the following activities:

- Control your dishwasher remotely
- Call up information on the operating status of your dishwasher
- Call up information on the program sequence of your dishwasher

Connecting your dishwasher to your WiFi network will increase energy consumption, even when the dishwasher is turned off.

Make sure that your WiFi network signal strength is strong enough at the installation site of your dishwasher.

### Availability of the Wi-Fi connection

The Wi-Fi connection shares a frequency range with other appliances (including microwave ovens and remote control toys). This can cause sporadic or even complete connection failures. Therefore, the availability of featured functions cannot be guaranteed.

### Miele@home availability

The ability to use the Miele app depends on the availability of the Miele@home service in your country.

The Miele@home service is not available in every country.

For information about availability, please visit [www.miele.com](http://www.miele.com).

### Miele App

The Miele App is available to download free of charge from the Apple App Store® or from the Google Play Store™.



## Basic settings

### Turning on the dishwasher

- Open the door.
- Turn the dishwasher on with the  button.

The welcome screen will appear when the dishwasher is turned on.

For more information about the display functionality, see “Display functions” under “Machine description”.

### Setting the language

The display will change automatically to the screen for setting the language.

- Select the language you want as well as the country, if applicable, using the  $\nabla/\wedge$  buttons and confirm with *OK*.

For further information on setting the language, see “Language” under “Settings”.

A check  will appear next to the language that has been set.

### Setting up Miele@home (depending on model)

The message Set up Miele@home will appear on the display.

- To set up Miele@home now, confirm by touching *OK*.

**Tip:** To postpone setup until later, select the option *Skip* and confirm with *OK*.

There are 2 ways of connecting your dishwasher to your WiFi network:

- Select the connection method you want and confirm your choice with *OK*.

1. Connect using App
2. Connect using WPS

You will then be guided by the display and the Miele app.

For further information on Miele@home, see “Miele@home” under “Settings”.

# Before using for the first time

---

## Setting the water hardness

The display changes to the screen for setting the water hardness.

- The dishwasher must be programmed to the correct water hardness for your area.
- Your local water authority will be able to advise you of the water hardness level in your area.
- Where the water hardness fluctuates, e.g., between 10-16 gpg (10–15 °dH), always program the dishwasher to the higher value (16 gpg (15 °dH) in this example).

It is useful to know your water hardness so that you can provide the service technician with this information in the event of any service calls.

Enter the water hardness below:

\_\_\_\_\_ gpg (°dH)

The dishwasher is programmed at the factory for a water hardness level 1 gpg (1 °dH).

- Set the water hardness level in your area and confirm with *OK*.

See “Water hardness” under “Settings” for more information.

## Activating AutoDos

The display changes to the settings screen for AutoDos (see “Automatic dispensing/AutoDos” under “Detergent”).

Even if you do not wish to use AutoDos, you must remove the tab from the AutoDos lid before running the first program sequence (see “Activating AutoDos” under “Detergent”).

You can activate AutoDos.

If you do not wish to use AutoDos, you can manually dispense the detergent via the detergent compartment (see “Manual detergent dispensing” under “Detergent”).

- Select the setting you want and confirm with *OK*.

Automatic dispensing is activated when the  *AutoDos* indicator light lights up.



This setting applies to all programs and can be changed at any time using the  *AutoDos* button.



## Before using for the first time

---

Finally, prompts will appear in the display.

After confirming these prompts with *OK*, the messages  Refill salt and  Refill rinse aid may appear.

- Add salt and rinse aid if necessary (see “Reactivation salt” and “Rinse aid” under “Before using for the first time”).
- Select *OK* to confirm the messages.

The program selected will appear in the display briefly and the indicator light for the program selected will come on.

The display will then show the estimated program duration for the program selected.

## Before using for the first time

---

### Reactivation salt

In order to achieve good cleaning results, the dishwasher needs to operate with soft water. Hard water results in the build-up of calcium deposits on dishes and on the inner surfaces of the machine.

Domestic water with a hardness level higher than 5 gpg (5 °dH – German scale) must be softened. This occurs automatically in the integrated water softener. The water softener is suitable for a water hardness level of up to 73 gpg (70 °dH – German scale).

In order to be reactivated, the water softener requires reactivation salt.

Depending on the water hardness level (< 22 gpg, or < 21 °dH – German scale), reactivation salt may not be required if combination detergents are being used (see “Active ingredients” under “Detergents”).

If the water in your area is very soft and constantly **lower than 5 gpg (5 °dH – German scale)**, you do **not** need to add reactivation salt. The salt refill indicator will automatically turn off after the water hardness has been set accordingly (see “Water hardness” under “Settings”).

 Damage to the water softener from detergent.

Dishwasher detergent will damage the softener assembly.

Do not fill the salt reservoir with powder or liquid detergent.

 Damage caused by using unsuitable salts.

Some types of salt may contain insoluble components which can cause the water softener to malfunction.

Use only special, coarse-grained reactivation salt.

If you only ever use combination detergent products in your dishwasher, you can turn off both refill reminders if you wish (see “Refill reminders” under “Settings”).

Please make sure that if you stop using combination detergents, you refill the reactivation salt and rinse aid. Turn the refill reminders back on if required.

## Before using for the first time

### Filling the salt reservoir

Before filling the salt reservoir for the first time, you must fill it with approx. 1.5 L of water to enable the salt to dissolve.

Once the dishwasher has been commissioned, there is always sufficient water in the salt reservoir.

- Remove the lower basket from the wash cabinet and unscrew the salt reservoir cap.

 Risk of corrosion due to saline solution.

Water or saline solution will run out of the reservoir when the cap is opened. Saline solution that runs out can cause corrosion in the wash cabinet and to the wash items.

The cap should therefore only be removed in order to refill the salt reservoir.

- Fill the salt reservoir with approx. 1.5 L of water (first use only).

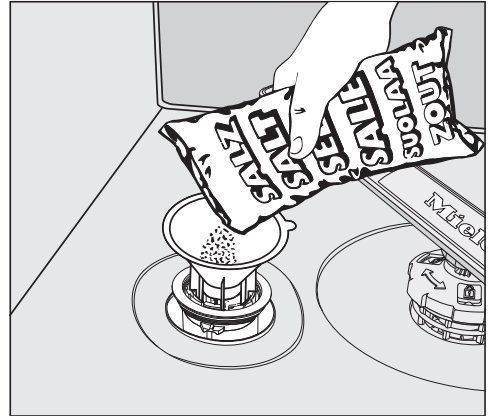

- Place the funnel provided over the salt reservoir and carefully fill with dishwasher salt until the reservoir is full. The salt reservoir holds up to 4.4 lb (2 kg) of salt, depending on the type of salt used.
- Clean off salt residues from around the salt reservoir opening. Next, screw the salt reservoir cap on again firmly.
- Immediately after filling the salt reservoir and each time you remove the salt reservoir cap, run the Rinse salt program without wash items in the dishwasher to dissolve and remove any traces of salt from the wash cabinet.

## Before using for the first time

---

### Refilling the salt

- When the refill reminder  Refill salt appears in the display, wait until the end of the program and then refill the salt reservoir.
- Confirm with *OK*.

The salt refill indicator will go out.



Risk of corrosion due to saline solution.

Saline solution that runs out can cause corrosion in the wash cabinet and to the wash items.

Immediately after filling the salt reservoir and each time you remove the salt reservoir cap, run the *Rinse salt* program without wash items in the dishwasher to dissolve and remove any traces of salt from the wash cabinet.

After the salt reservoir has been filled, the refill indicator may still appear in the display if the salt concentration has not yet reached the correct level. In this case, still confirm the message with *OK*.

The salt refill reminder will be turned off if you have programmed the dishwasher for a water hardness below 5 gr/gal (5 °dH – German scale).

## Before using for the first time

### Rinse aid

Rinse aid is necessary to ensure that water does not cling and leave marks on dishes during the drying phase, and helps dishes dry faster after they have been washed.

Rinse aid is poured into the container and the amount set is dispensed automatically.

 Liquid dish soap or detergent can cause damage.

Liquid dish soap and detergent can damage the rinse aid reservoir.

Only fill it with rinse aid formulated for domestic dishwashers.

 Risk of acid damage.

The dishwasher can be damaged by high concentrations of acid.

Under no circumstances should you use citric acid with a higher acid content.

If you only ever wish to use combination detergent products in your dishwasher, you do not need to add rinse aid.

However, for optimum rinsing and drying results, use dishwasher detergent and add reactivation salt and rinse aid separately.

If you only ever use combination detergent products containing salt and rinse aid in your dishwasher, you can turn off both refill reminders if you wish (see “Refill reminders” under “Settings”).

Please make sure that if you stop using combination detergents, you refill the reactivation salt and rinse aid. Turn the refill reminders back on if required.

## Before using for the first time

### Adding rinse aid

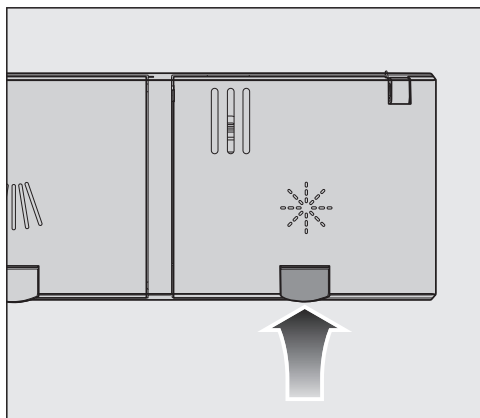

- Press the yellow button  on the lid of the rinse aid reservoir.

The lid will spring open.

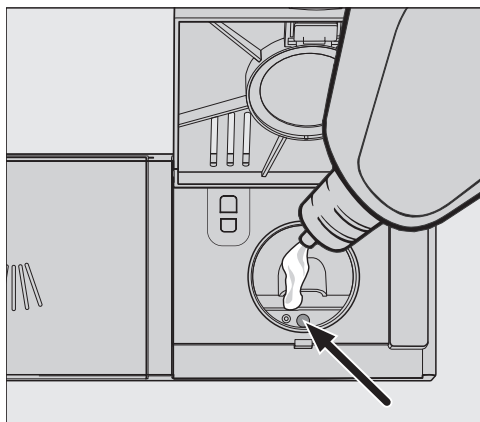

- Fill with rinse aid until the filling level indicator (arrow) changes to a dark color while the door is horizontally open.

The rinse aid reservoir holds approximately 110 ml.

- Close the lid firmly until you hear it click into place. Otherwise, water can enter the rinse aid reservoir during a program.

- Wipe up any spilled rinse aid. This prevents excess foam developing during the next program.

You can adjust the rinse aid dosage for best wash results (see “Rinse aid” under “Settings”).

### Filling the rinse-aid reservoir

When  Refill rinse aid appears in the display, the reservoir contains sufficient rinse aid for 2–3 programs only.



- Add rinse aid in plenty of time.
- Confirm with *OK*.

The rinse-aid refill indicator will go out.

You can alter the dishwasher's controls to suit changing requirements by adjusting the settings (depending on model).

The settings can be altered at any time.

## Opening the settings menu

- Turn the dishwasher on with the  button if it is turned off.
- Use the *Program* button to select the  *More* option.

The first of the additional programs will appear in the display.

- Select the *Settings*  menu option using the  $\vee/\wedge$  buttons and confirm with *OK*.

The first option in the *Settings* menu will appear in the display.

For further information about the display functionality, see “Display functions” under “Guide to the appliance”.

## Changing settings

- Use the  $\vee/\wedge$  buttons to select the menu option you want to change and confirm your selection with *OK*.

Sub-menu options that have already been selected will have a check  beside them.

- Use the  $\vee/\wedge$  buttons to select the setting you want and confirm with *OK*.
- To exit a sub-menu again, press the *Back* button.

The display will revert to the menu above.

## Closing the settings menu

- Press the *Back* button.



The display will change to the  *More* menu.

# Settings

## Language

The display can be set to appear in one of several different languages.

You can change the language used in the display and also the country via the Language  sub-menu.

The flag after the word Language  serves as a guide if a language that you do not understand has been set. In this case keep selecting the menu option that has a flag after it until you reach the Language  sub-menu.

## Water hardness

Your dishwasher is fitted with a water softener.

- The dishwasher must be programmed to the correct water hardness for your area.
- Your local water authority will be able to advise you of the water hardness level in your area.
- Where the water hardness fluctuates, e.g., between 10-16 gpg (10–15 °dH), always program the dishwasher to the higher value (16 gpg (15 °dH) in this example).

If the water hardness in your area is available in a unit other than °dH, you can convert the values as follows:  
 $1\text{ °dH} = 1.04\text{ gpg} = 0.18\text{ mmol/l} = 1.78\text{ °fH}$

°d	gr/gal	°fH	Display
1	1	2	1
2	2	4	2
3	3	5	3
4	4	7	4
5	5	9	5
6	6	11	6
7	7	13	7
8	8	14	8
9	9	16	9
10	10	18	10



°d	gr/gal	°fH	Display
11	11	20	11
12	13	22	12
13	14	23	13
14	15	25	14
15	16	27	15
16	17	29	16
17	18	31	17
18	19	32	18
19	20	34	19
20	21	36	20
21	22	38	21
22	23	40	22
23	24	41	23
24	25	43	24
25	26	45	25
26	27	47	26
27	28	49	27
28	29	50	28
29	30	52	29
30	31	54	30
31	32	56	31
32	33	58	32
33	34	59	33
34	35	61	34
35	36	63	35
36	38	65	36
37-45	39-47	66-80	37-45
46-59	48-62	82-105	46-59
60	63	107	60
61-70	64-73	109-125	61-70

## Setting the water hardness

- Select the water hardness level in your area and confirm with *OK*.

## AutoDos (AutoDos)

AutoDos automatically adjusts the amount of detergent to the selected program.

If you want to extend the service life of the PowerDisk, you can reduce the dispensing quantity. The program's cleaning performance may decrease as a result.

If you want to improve the cleaning performance, you can increase the dispensing quantity. This reduces the service life of the PowerDisk.

## Setting the Dosage amount

For best results, you can adjust the dispensing quantity of the PowerDisk.

- Select the Dosage amount menu option.
- Select the setting you want.

# Settings

---

## Rinse Aid

You can adjust the rinse aid dosage for best results.

The rinse aid dosage can be set from 0 to 6 ml.

3 ml is the factory default setting.

The rinse aid dosage can turn out to be higher than the set value due to the automatic adjustment of the program.

If spots appear on dishes and glassware:

- Increase the rinse aid dosage.

If clouding or smearing appears on dishes and glassware:

- Decrease the rinse aid dosage.

## Save Extras

You can set whether the selected extras are to remain permanently activated for the respective program.

## Miele@home (depending on the model)

Your dishwasher is equipped with an integrated Wi-Fi module.

You can connect your dishwasher to your Wi-Fi network.

This will increase the energy consumption, even when the dishwasher is turned off.

The Settings and Miele@home settings menus will be added as additional menu options.

Make sure that your Wi-Fi network signal strength is strong enough at the installation site of your dishwasher.

There are a number of ways of connecting your dishwasher to your Wi-Fi network:

## Performing Scan & Connect

Initial commissioning has been carried out without Miele@home having been set up.

- Scan the QR code.

If you have installed the Miele app and have a user account, you will be taken directly to the networking steps.

If you have not yet installed the Miele app, you will be taken to the Apple App Store® or the Google Play Store™.

- Install the Miele app and set up a user account.
- Scan the QR code again.

The Miele app will guide you through the setup process.



## Connect using App

The Miele app is available to download free of charge from the Apple App Store® or from the Google Play Store™.



- Select the Connect using App menu option and confirm with *OK*.
- Follow the instructions in the app.

Once your dishwasher is connected to your WiFi network, you can use the app to carry out the following tasks:

- Control your dishwasher remotely

- Call up information on the operating status of your dishwasher
- Call up information on the program sequence of your dishwasher
- Set up a Miele@home network with other WiFi-enabled Miele appliances

## Connect using WPS

As an alternative to networking via the Miele app, you can connect your dishwasher to your Wi-Fi network using WPS (Wireless Protected Setup).

Your WiFi router must support WPS.

- Select the Connect using WPS menu option and confirm with *OK*.
- Confirm the message Press WPS button with *OK*.
- Activate the WPS function on your router within 2 minutes.
- Once the connection has been established, confirm the message with *OK*.

If the connection fails, you have probably not activated WPS on your router quickly enough. Repeat the steps above.

## Deactivate

If you do not wish to use the Wi-Fi module of your dishwasher, you can turn it off.

- Select the Deactivate menu option.

In the Miele@home menu, the Activate menu option will now be displayed instead of Deactivate.

## Activate

If you wish to connect your dishwasher to your Wi-Fi network, you can turn on the Wi-Fi module.

- Select the Activate menu option.

# Settings

---

In the Miele@home menu, the Deactivate menu option will now be displayed instead of Activate.

## Displaying Connection status

You can call up the current connection status of your dishwasher.

- Select the Connection status menu option and confirm with *OK*.
- Use the  $\vee/\wedge$  buttons to consecutively call up the WiFi signal strength, the name of your router and the associated IP address.
- Select *OK* to confirm the messages.

## Set up again

This menu option only appears if you have already connected your dishwasher to your Wi-Fi network.

## Connect using App

- Select the Connect using App menu option.
- Follow the user navigation in the app.

## Connect using WPS

- Select the Connect using WPS menu option.
- Follow the instructions on the display.

## Reset

This menu option only appears if you have already connected your dishwasher to your WiFi network.

You can use this menu option to reset all WiFi module settings to the factory default settings.

The network configuration should be reset whenever a dishwasher is being disposed of or sold, or if a used dishwasher is being put into operation. This is the only way to ensure that all personal data

has been removed and the previous owner will no longer be able to access the dishwasher.

- Select the Reset menu option and confirm with *OK*.

## Remote control (depending on the model)

This menu option will only be displayed if you have connected your dishwasher to your Wi-Fi network (see “Miele@home” under “Settings”).

If you have switched on the Remote control option, the MobileStart menu option is displayed under  *More*.

If you wish to permanently turn off the Remote control option, you can do this under this menu option. The MobileStart menu option will then no longer be displayed.

Even if the Remote control option is switched off, you can use the Miele app to call up information about your appliance. However, you cannot start any programs or change any settings from it.

## Remote update (depending on the model)

The RemoteUpdate menu option is only displayed and can only be selected if the requirements for using Miele@home have been met (see “Miele@home” under “Before using for the first time”).

The RemoteUpdate function is used for updating the software in your dishwasher. If an update is available for your dishwasher, it will automatically download it. Updates will not be installed automatically. They must be initiated manually.

If you do not install an update, you can continue to use your dishwasher as usual. However, Miele recommends installing updates.

### Activating/deactivating

The RemoteUpdate function is activated as standard. Available updates will be downloaded automatically but will only be installed if you initiate installation manually.

Deactivate RemoteUpdate if you do not want any updates to be downloaded automatically.

# Settings

---

## Running RemoteUpdate

Information about the content and scope of a RemoteUpdate will be provided in the Miele app.

A message will appear in your dishwasher display if a software update is available.

You can install the update immediately or postpone this until later. When the appliance is turned on again, you will be reminded about the update.

Deactivate RemoteUpdate if you do not want to install the update.

The update may take several minutes.

Please note the following information about the RemoteUpdate function:

- You will only receive a message when an update is available.
- Once an update has been installed, it cannot be undone.
- Do not turn the dishwasher off during the update. Otherwise, the update will be aborted and will not be installed.
- Some software updates can only be carried out by Miele Customer Service.

## Display brightness

You can set the display brightness to one of 7 different levels.

## Buzzer

A sequence of audible signals will sound at the end of the program or if there is a fault, provided that the audible signals have been activated.

The audible signals at the end of the program and the alarm tone in the event of a fault will sound 4 times at intervals with a short pause between each set.

You can activate or deactivate the audible signal that sounds at the end of the program if you wish.

The alarm tone that sounds when there is a fault cannot be deactivated.

## Refill reminders

If you only ever use combination detergent products or automatic dispensing using Miele PowerDisks (if available), you can turn off the refill reminders for reactivation salt and rinse aid if you wish.

Please make sure that if you stop using combination detergents, you refill the reactivation salt and rinse aid. Turn the refill reminders back on.

## AutoOpen

In some programs, the door automatically opens slightly to assist the drying process.

This function can be deactivated if you wish. However, this negatively affects the drying process in most cases.

 Risk of injury due to door opening automatically.

The door may open automatically at the end of the program.

Keep the area around the door free of obstructions.

 Risk of damage due to steam.

Steam from the dishwasher could damage the edges of delicate cabinets and countertops when you open the door at the end of the program if the fan is no longer running.

If you have deactivated the automatic door opening function but would like to open the door at the end of the program, make sure that you open the door fully.

# Settings

---

## 2nd interim rinse

You can choose this function to increase the cleaning performance of the programs with a second interim rinse.

When this function is activated, water consumption may increase.

If this function is switched on, it will be applied to all programs until it is switched off again.

## Hygiene cycle

If you mainly use low-temperature programs, there is a risk of bacteria and unpleasant odors building up in the wash cabinet (see “Hygiene cycle” under “Cleaning and care”).

If this function is switched on, a message will be displayed recommending the use of a high-temperature program after several low-temperature programs have been run.

## Water connection

You can set your water connection type.

- If you select *Automatic*, the dishwasher detects which water connection is currently being used and automatically selects the right setting.
- Select *Cold water*, if you are only using a cold water connection.
- Select *Warm water*, if you are only using a hot water connection.

## Information

You can display the following information about your dishwasher:

- Operating hours (see also “Displaying the operating hours” under “Options”)
- Program sequences
- Total consumption
- Fault memory
- Data plate
- Software version



## Showroom program

For demonstration purposes only.

The dishwasher is equipped with a demo mode for showroom use.

## Factory default

You can reset all dishwasher settings to the factory default settings.

WiFi module settings (where applicable) have to be reset separately (see “Miele@home” under “Settings”).

- Select **Reset** and confirm with **OK**.

## Copyrights and licenses for the communication module

For the purpose of operating and controlling the communication module, Miele uses proprietary or third-party software that is not covered by open source licensing terms. This software/ these software components are protected by copyright. The copyrights held by Miele and third parties must be respected.

This communication module contains software components which are distributed under open source license conditions. The open source components contained in the appliance along with the corresponding copyright notices, copies of the licensing terms valid at the time, and any additional information can be accessed locally via *http://<IP address>/Licenses*. The liability and warranty arrangements for the open source licenses displayed in this location only apply in relation to the respective rights holders.

# Caring for the environment

---

## Energy-saving dishwashing

This dishwasher is exceptionally economical in its use of water and electricity.

You can make the most of your machine by following these tips:

- Washing in a dishwasher generally uses less water and energy than washing by hand.
- There is no need to pre-rinse items under running water, and this unnecessarily increases water and energy consumption.
- Make full use of the basket capacity without overloading the dishwasher. This results in the most economical dishwashing in terms of energy and water consumption.
- Choose a program that best suits the degree of soiling and the type of dishes being washed (see “Program overview”).
- Select the *Normal* program for energy-saving dishwashing. This program is the most efficient in terms of its combined energy and water consumption for cleaning dishware with a normal level of soiling.
- Follow the detergent manufacturer’s recommendations on detergent dosage.
- When using powder or liquid detergent, you can use  $\frac{1}{3}$  less detergent if baskets are only half full.
- You can connect the dishwasher to a hot-water supply. A hot water connection is particularly suitable with energy-saving water heating sources, such as solar energy with a circulation system.

If the water is heated by electricity, we would recommend connection to cold water.

## General information

Remove coarse food residues from dish-ware.

There is no need to pre-rinse items under running water.

 Damage can be caused by ash, sand, wax, lubricant, or paint.

These substances will contaminate the dishwasher and can then no longer be removed.

Do not wash items soiled with these substances in the dishwasher.

Dishes can be loaded anywhere in the baskets. The following notes should be observed:

- Do not place dishware or cutlery inside other pieces. They will cover one another.
- Load the dishware so that water can access all surfaces. This ensures that dishware will be properly cleaned.
- Make sure that all items are securely positioned.
- Hollow items such as cups, glasses, pans, etc., must be inverted in the baskets.
- Tall, narrow, hollow items such as champagne glasses should be placed in the center of the basket rather than in the corners. This ensures the hollow items are more easily accessed by the water jets.
- Concave items such as mugs or bowls should be placed at an angle so that the water can run off.
- The spray arms must not be blocked by items which are too tall or hang through the baskets. Test for free movement by manually rotating the spray arms.

- Make sure that small items cannot fall through the holders in the baskets. Small items such as lids should therefore be placed in the 3D MultiFlex Tray.

Some foods such as carrots, tomatoes, or ketchup may contain natural dyes. These dyes can discolor plastic items in the dishwasher if large quantities of these foods are in contact with the dishware inside the appliance. The stability of plastic items is not affected by this discoloration.

Washing silverware can also cause plastic items to discolor.

# Loading the dishwasher

## Wash items not suitable for dishwashers:

- Wooden cutlery and dishes or items with wooden parts. These may discolor and fade. Additionally, the glue used in these items is not dishwasher safe and wooden handles may come loose after being washed in a dishwasher.
- Craft items, antiques, valuable vases, and decorative glasses. Such items are not dishwasher-safe.
- Plastic items that are not heat resistant. The high temperatures in the dishwasher may cause them to melt or lose shape.
- Copper, brass, tin, and aluminum items. These may discolor or become dull.
- Colors painted over a glaze. This type of decoration may fade after a number of rinses.
- Delicate glasses and glassware containing lead crystal. Clouding may occur over time.

## Silver

 Damage caused by using unsuitable cleaning agents.

If silverware is cleaned using an unsuitable cleaning agent, it can be irreparably damaged.

Silverware that has been in contact with foods containing sulfur can discolor. These include egg yolk, onions, mayonnaise, mustard, pulses, fish, fish brine, and marinades.

**Silverware** previously cleaned with a **silver polish** may still be damp or spotted at the end of a program, where water has not run off smoothly.

**Tip:** Rub the silver dry with a cloth.

 Damage due to caustic alkaline detergents.

Aluminum parts (e.g., the grease filters of ventilation hoods) can be damaged by caustic alkaline detergents. In extreme cases, there is a risk of an explosive chemical reaction (such as an explosive oxyhydrogen gas reaction).

Aluminum components must not be cleaned in the dishwasher with caustic alkaline commercial or industrial detergents.

**Tip:** When purchasing new dishware and cutlery, make sure they are dishwasher-safe if you want to wash them in the dishwasher.

## Glass care

- Clouding may occur on glasses after frequent washing in the dishwasher. When washing delicate glassware in the dishwasher, ensure that only a special glass-care program with very low temperatures is selected (see “Program overview”). This will reduce the risk of clouding.
- Purchase glassware that is dishwasher-safe (e.g., Riedel glassware).
- Use detergents with glass protective additives.

# Loading the dishwasher

## Loading examples

### Loading for 10 standard place settings with cutlery tray

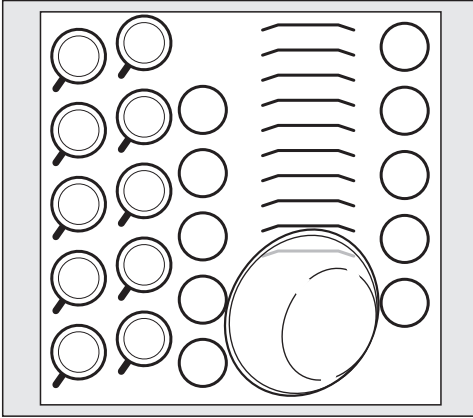

Upper basket

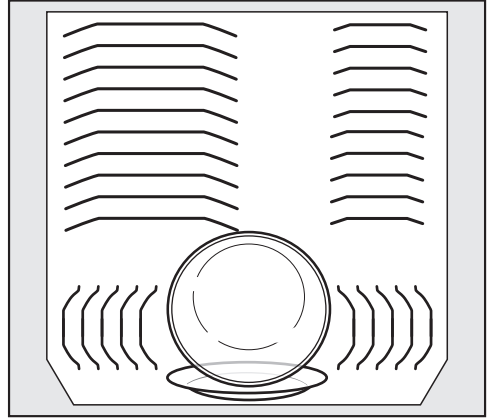

Lower basket

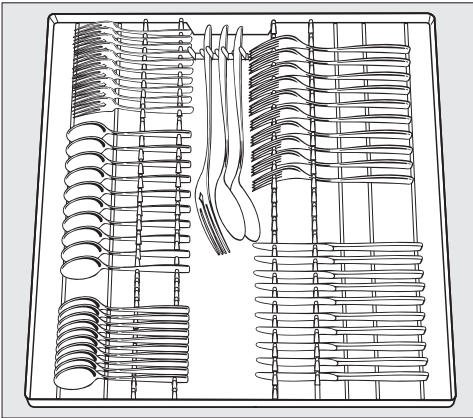

Cutlery tray

# Loading the dishwasher

## Loading for 16 standard place settings with cutlery tray

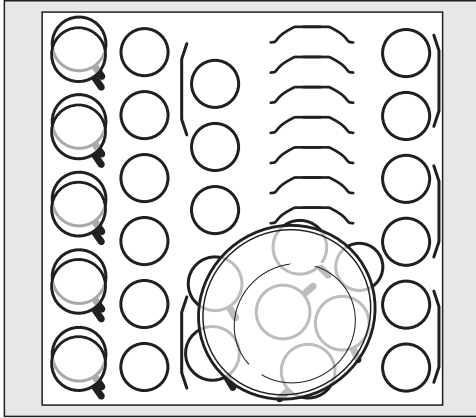

Upper basket

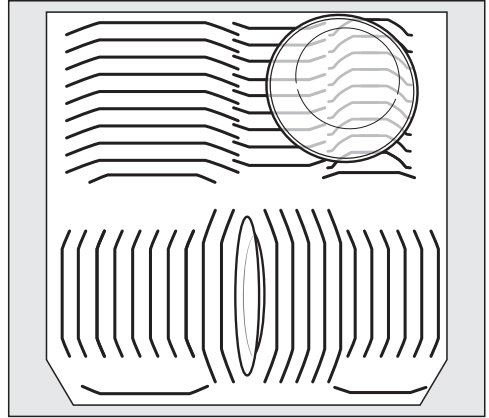

Lower basket

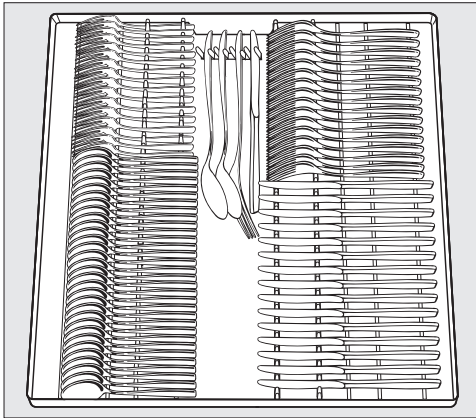

Cutlery tray

# Loading the dishwasher

## Upper basket

### Loading the upper basket

 Risk of damage due to water leakage.

If you run the dishwasher without the upper basket, water can leak out of the dishwasher.

Only run the dishwasher with the upper basket in place (except during the Tall items program, if available).

- Use the upper basket for small, lightweight, and delicate items such as cups, saucers, glasses, dessert bowls, etc. Shallow pans or casserole dishes can also be placed in the upper basket.
- Long items such as soup ladles and mixing spoons should be placed lying down across the front of the upper basket.

### Loading the FlexCare cup rack

You can put cups, small bowls, and flat dishes on the FlexCare cup rack.

Glasses can be arranged along the FlexCare cup rack so they sit securely during the program.

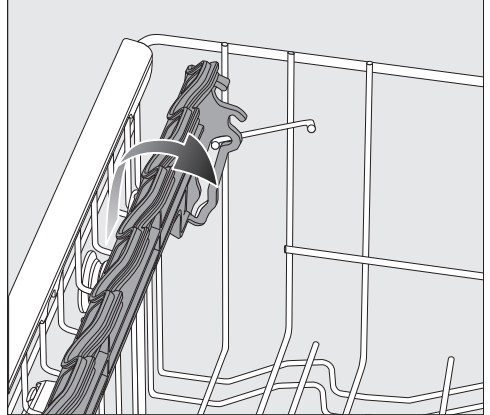

- Lower the FlexCare cup rack to do so.
- Raise the FlexCare cup rack upward to make room for tall items.

# Loading the dishwasher

## Adjusting the FlexCare cup rack

You can set the height and depth of the cup rack at 2 different levels so that it can accommodate larger cups and so that taller items can be placed underneath it.

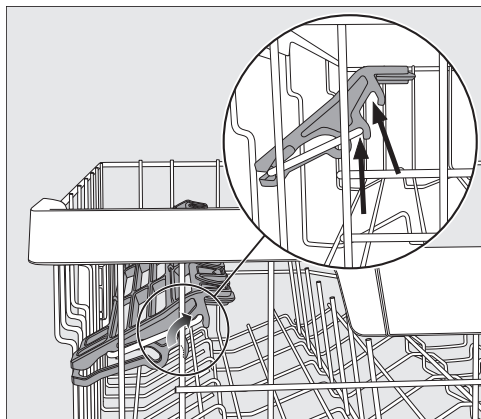

- Pull the cup rack upwards and click it into the desired position (see arrow).

## Lowering the spikes

On both front right-hand rows of spikes, you can lower every other spike to make it easier to arrange larger dishes, like cereal bowls.

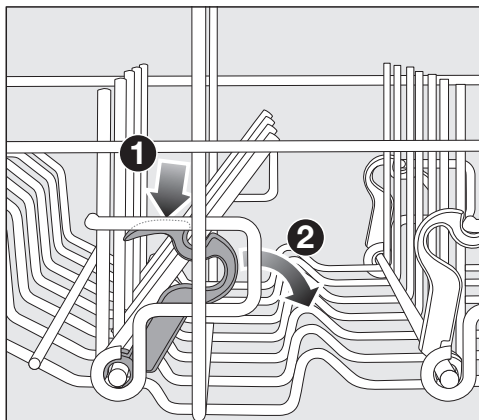

- Press the yellow lever downward ①, and then lower the dark gray spikes ②.
- Place the bowls vertically in the row of spikes.



## Adjusting the upper basket

In order to gain more space for taller items in the lower basket or upper basket, the upper basket can be adjusted on 3 levels with 3/4" (2 cm) between each level.

The upper basket can also be set at an angle so that water can run off freely from recesses. Make sure, however, that the basket can slide smoothly in and out of the wash cabinet.

- Pull out the upper basket.

### Raise the upper basket:

- Lift the basket until it clicks into place.

### Lower the upper basket:

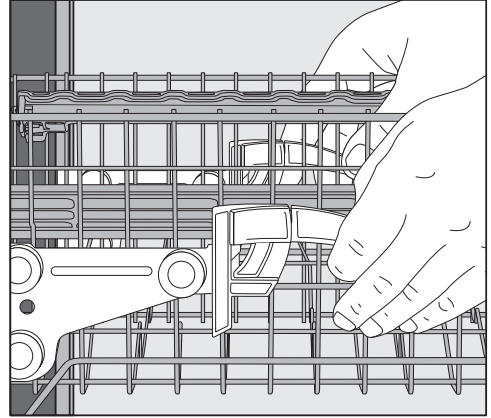

- Pull upwards on the levers at either side of the upper basket.
- Adjust the basket to the desired height and then push the levers securely back down into position.

When adjusting the upper basket, make sure that tall plates in the lower basket do not block the middle spray arm.

# Loading the dishwasher

## Lower basket

### Loading the lower basket

- Place larger and heavier items such as plates, serving platters, saucepans, bowls, etc., in the lower basket. Glasses, cups, and small plates and saucers can also be placed in the lower basket.

### Loading the MultiComfort area

The rear section of the lower basket is used for washing cups, glasses, plates, and pots.

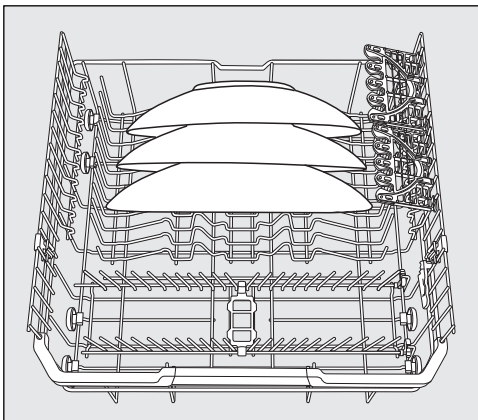

- Place very large plates in the center of the lower basket.

**Tip:** When tilted, plates up to 13 3/4" (35 cm) in diameter can be accommodated.

### Lowering the spikes

The rows of spikes at the front are used for loading plates, soup bowls, platters, dessert bowls, and saucers.

Both right-hand rows of spikes can be lowered to make more room for large items such as pots, pans, and serving dishes.

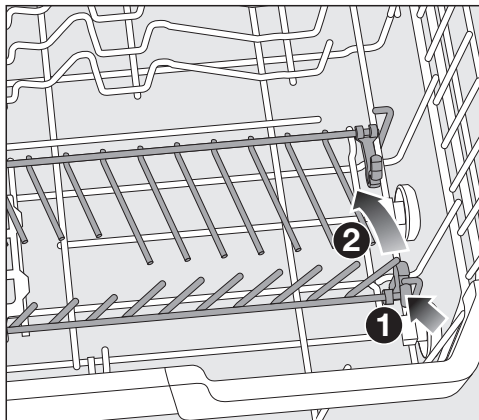

- Press the yellow lever downward ①, and then lower the row of spikes ②.

# Loading the dishwasher

## FlexCare Glass & Bottle

The glass and bottle holders are used to wash stemware, tall glasses, and bottles.

## Adjusting the FlexCare Glass & Bottle

You can set the glass and bottle holders at 2 different heights.

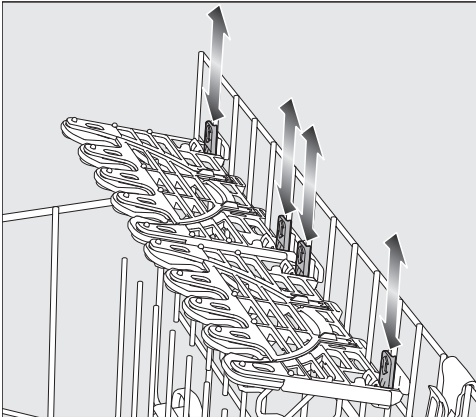

- Slide the glass and bottle holder to the desired height until the catches click into place at the top or the bottom.
- The glass and bottle holders can be raised to make more room for tall items.

## Loading the glass holder

The silicone elements in the glass holder provide a stable and secure hold for delicate stemware.

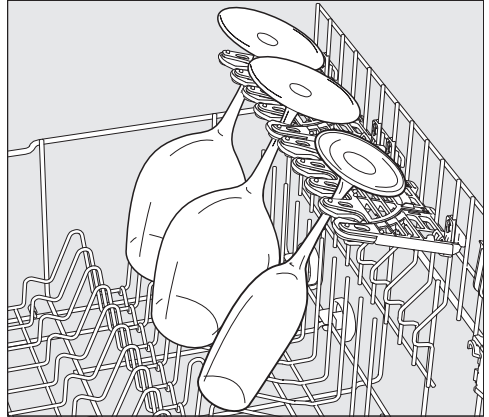

- Stemware such as wine glasses, champagne flutes, and beer glasses can be pinned into the openings of the glass holders.

# Loading the dishwasher

## Loading the FlexCare Glass & Bottle

The glass and bottle holders can be used to keep tall, narrow, and hollow containers, e.g., beer glasses, bottles, vases, secure during a program.



- The inserts in the glass and bottle holders can be raised to make more room for tall glasses or bottles.

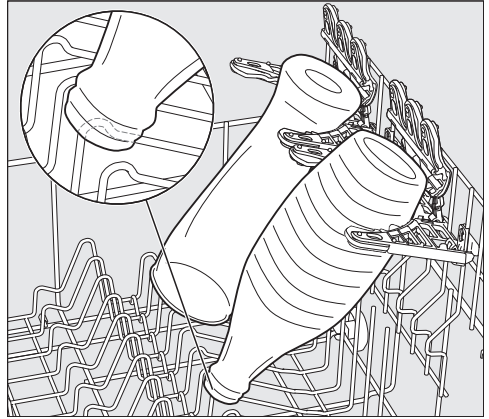

- Lean the containers into the holders.

**Tip:** For the best cleaning results, use the “BottleClean” extras (see “Bottle-Clean” under “Extras”).

## Loading the dishwasher

### MultiClip

The MultiClips enable you to fasten light wash items such as those made from plastic.

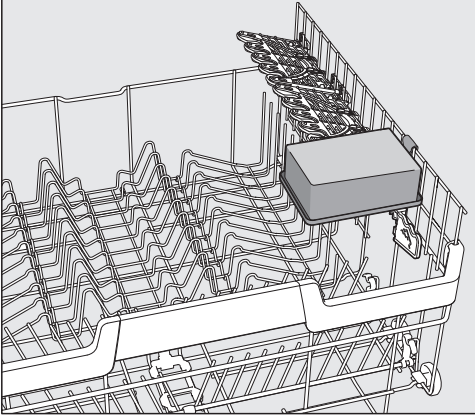

- Secure light items to the MultiClips.

Make sure that dishware does not obstruct the middle spray arm.

### XL-Assist

The XL Assist is used to secure large wash items, e.g., pots and pans.

This allows the dishware to be tilted for better drying results. Smaller items of dishware can be positioned under the large items.

#### Loading the XL-Assist

Unfold the XL-Assist to support large items of dishware on it.

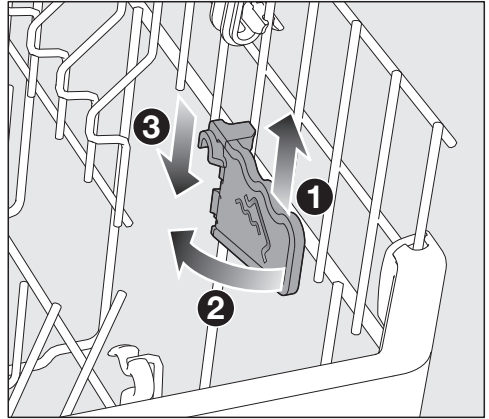

- Slightly lift the XL-Assist ①, fold it out ②, and hook it back in the new position ③.

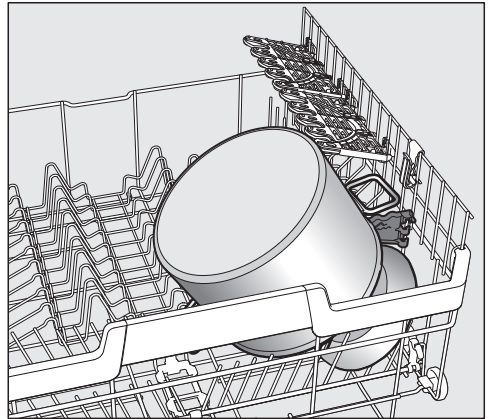

- Place the edges of large dishware on the XL-Assist.

# Loading the dishwasher

## Cutlery tray

- Arrange the cutlery in the cutlery tray as shown.

### Loading the 3D MultiFlex Tray

To make unloading easier, utensils should be grouped in zones, one for knives, one for forks, one for spoons, etc.

Spoon heads should be placed in contact with at least one of the serrated retainers on the base of the cutlery tray to ensure that water runs off them freely.

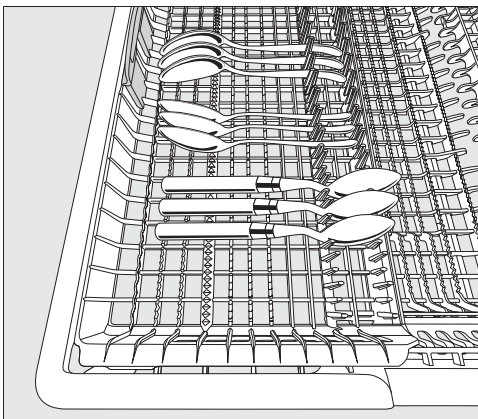

- If spoon handles do not fit between the holders, then lay them the other way round.

You can push the left insert to the middle in order to accommodate tall items and long stemmed glasses in the upper basket.

You can put large and long utensils in the recessed center part of the tray.

Arrange tall items (such as cake server) so that they do not block the upper spray arm.

You can adjust the height of the right-hand insert to create more space in the right-hand part of the tray for larger utensils or smaller dishes.

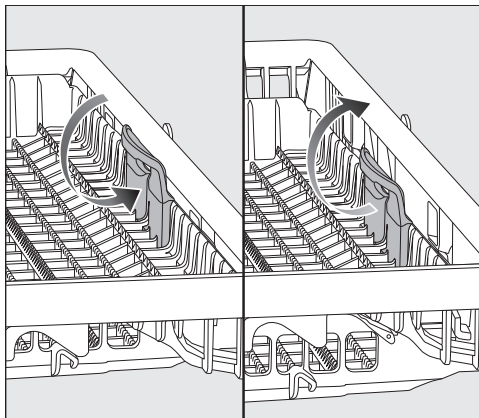

- Pull the insert inward by the yellow handle and click it into place in one of the two positions.

## Active ingredients

 Damage caused by using unsuitable cleaning agents.

Cleaning agents that are not suitable for domestic dishwashers can cause damage to the dishwasher or to the wash items.

Only use cleaning agents formulated for domestic dishwashers.

Modern cleaning agents contain various active ingredients, the most important of which are:

- Water softening complexing agents to prevent limescale.
- Alkalis to aid removal of dried-on soiling.
- Enzymes to break down starch and loosen protein.
- Oxygen-based bleaching agents to remove colored stains (e.g., tea, coffee, tomato sauce).

Most dishwasher cleaning agents are mildly alkaline and contain enzymes and oxygen-based bleaching agents.

There are different types of cleaning agent:

- Powder and liquid gel cleaning agents. These cleaning agents allow you to adjust the amount dispensed according to the load size and the level of soiling.
- Tab cleaning agents. These are suitable for most levels of soiling.

As well as the usual cleaning agents, combination products are also available. These contain rinse aid and water softener (reactivation salt).

Only use these combination cleaning agents for the water hardness levels recommended by the manufacturer on the packaging.

The cleaning and drying performance of these combination cleaning agents can vary greatly.

Please make sure that if you stop using combination cleaning agents, you refill the reactivation salt and rinse aid. Turn the refill reminders back on if required.

For optimum cleaning and drying results, use dishwasher cleaning agent and add salt and rinse aid separately.

# Detergents

---

 Risk of chemical burns from detergent.

Dishwasher detergents can cause burning on the skin and in the eyes, nose, mouth, and throat.

Avoid contact with detergents.

Do not inhale or ingest powder detergents. Do not swallow dishwasher detergents. Seek medical attention immediately if detergent has been swallowed or inhaled.

Keep children away from detergents. Detergent residues could still be present in the dishwasher. Keep children away from the dishwasher when the door is open. Do not fill the detergent dispenser until just before starting the program.

## Detergent dispensing

There are 2 ways of dispensing the detergent.

During automatic dispensing, the AutoDos function will automatically dispense the required amount of detergent for each program sequence once a PowerDisk has been inserted (see “Automatic dispensing/AutoDos” under “Detergent”).

If you do not wish to use AutoDos, you can manually dispense the detergent into the detergent compartment. This means you will have to fill the required amount of detergent into the detergent compartment before each program (see “Manual detergent dispensing” under “Detergent”).



## Automatic dispensing/AutoDos

Before you can use AutoDos, you must insert a PowerDisk containing powder detergent into the PowerDisk compartment.

One PowerDisk contains enough detergent for approx. 20 rinse cycles, depending on the chosen program.

PowerDisks are available to order directly from Miele's online store, Miele Customer Service, or from your Miele dealer.

 Risk of chemical burns from residual detergent.

Detergents have a caustic effect. This can cause health problems and damage to surfaces. If AutoDos is used incorrectly, residual detergent may drip onto the floor area in front of the dishwasher.

Always remove residual detergent from in front of the dishwasher immediately.

## Activating AutoDos

- Turn the dishwasher on with the  button.
- Before you first use AutoDos, remove the tab from the AutoDos lid and dispose of the tab appropriately.
- Insert a PowerDisk (see "Inserting a PowerDisk" under "Automatic dispensing/AutoDos").

The  *AutoDos* function will be activated automatically.

The message *AutoDos Activated* will appear on the display.

This setting applies to all programs and can be changed at any time using the  *AutoDos* button.

If no program is started for 48 hours, the PowerDisk will automatically be rotated so that the detergent does not clump together. If this happens, the message *Powder refreshing* will be shown in the display when the dishwasher is turned on. No detergent will be dispensed.

# Detergents

## Inserting a PowerDisk

Only replace the PowerDisk when the message PowerDisk empty Deactivate AutoDos with OK, appears.

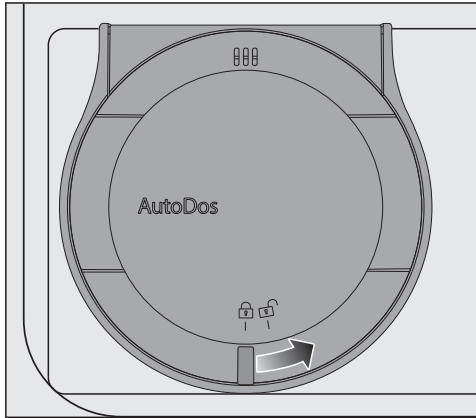

- Turn the AutoDos lid to  and open it.

The message AutoDos lid open will appear on the display.

- Remove the empty PowerDisk.

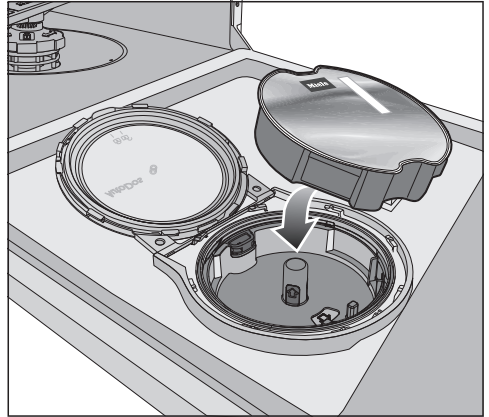

- Insert the new PowerDisk and press it evenly downward until it sits flush.

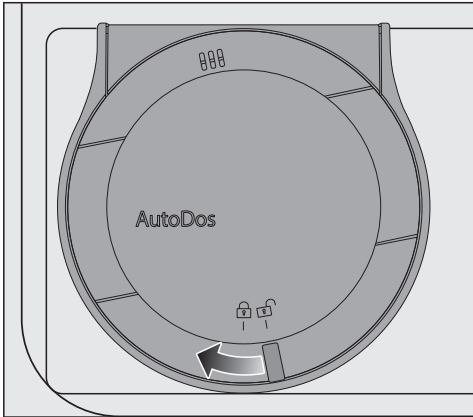

- Close the AutoDos lid and turn it until the lid handle is directly below the  symbol.

This activates the *AutoDos* function.

If the PowerDisk is not in the correct starting position, it will be rotated automatically.

Wait until this procedure ends before you start a program.

The AutoDos lid must be closed to prevent damage to the AutoDos. Always close the AutoDos lid before you close the dishwasher door. Otherwise, the AutoDos may become damaged.

Programs cannot start when the AutoDos lid is open.

The detergent powder must be dry so that it does not clump together. Do not fill the AutoDos system with any type of fluid.

It is not permitted to refill the PowerDisk with powder detergent. This will invalidate the warranty.

In order to ensure that the AutoDos function works at its best, check it each time you replace the PowerDisk and clean it if needed (see “Cleaning the AutoDos” under “Cleaning and care”).

# Detergents

## Manual detergent dispensing

Detergent must be manually dispensed if you have deactivated automatic dispensing using the  *AutoDos* button.

## Detergent dispensing

The detergent compartment holds a maximum of 3 1/2" tablespoons.

There are marks in the detergent compartment to aid with dispensing: 1 1/4, 2 tablespoons (20, 30 ml). When the door is opened to a horizontal position, they show the approximate fill level in ml and the maximum fill height.

- Follow the detergent dosage recommended by the manufacturer on the packaging.
- Unless directed otherwise, use one detergent tab or add 1 1/4 to 2 tablespoons (20 to 30 ml) of detergent to the detergent compartment, depending on the level of soiling of the dishware.

If you use less than the recommended amount of detergent, the dishware may not get properly clean.

Some tabs may not dissolve completely when the program *QuickIntenseWash* is used.

## Adding detergent

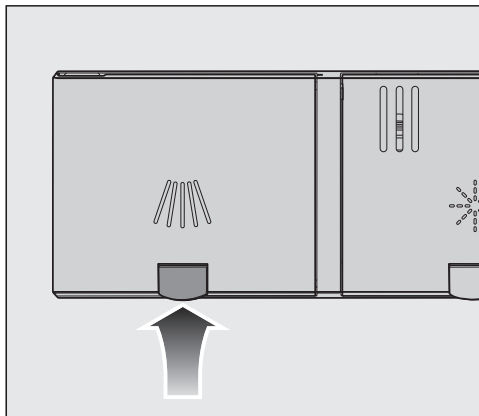

- Press the yellow button  on the lid of the detergent compartment.

The lid will spring open.

The lid will also open at the end of the program.

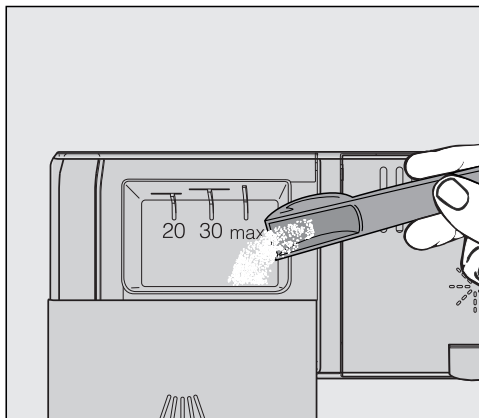

- Add the detergent to the detergent compartment.
- Push the lid shut until you hear it click into place.

The detergent must not cause the detergent compartment lid to get stuck. This can prevent the lid from opening during the program sequence.

Do not overfill the detergent compartment.

- If you wish, deactivate automatic dispensing/AutoDos.
- Ensure that the detergent packaging is properly closed after use. This prevents the detergent from getting damp and clumping together.

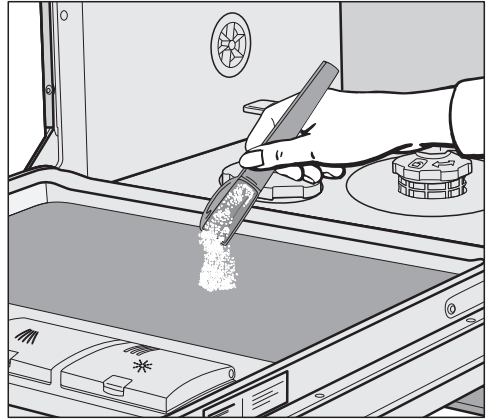

- You can also apply a small amount of detergent to the inner panel of the door in programs that have a pre-rinse stage (see “Program overview”).

# Operation

---

## Turning on the dishwasher

- Turn on the water supply if it is turned off.
- Open the door.
- Make sure the spray arms can rotate freely.
- Press the  button.

The program selected will appear in the display briefly and the indicator light for the program selected will come on. Then the display will show the estimated duration for the selected program.

## Selecting a program

Choose your program according to the type of load and the degree of soiling.

The different programs and their uses are described in the **Program overview** later on in this booklet.

- Use the *Program* program selector to select the program required.

The indicator light next to the program selected will come on.

Additional programs can be selected under  *More*.

- Use the *Program* program selector to select the  *More* option.

The first of the additional programs will appear in the display.

- Use the  $\vee/\wedge$  buttons in the display to select the program you want.





You can now select the options (see “Options”).

If any extras are selected, the appropriate indicator lights will also light up.

## Display of program duration

The estimated duration of the selected program appears on the display before the program begins. If the door is opened during the program, the time left until the end of the program is displayed.

Each program phase is indicated by a symbol:

-  Pre-rinse/Soak
-  Main wash
-  Interim rinse
-  Final rinse
-  Drying
-  Finish

The displayed duration may vary for the same program. It is influenced by, for example, the temperature of the incoming water, the reactivation cycle of the water softener, the detergent type, and the amount of dishes and how soiled they are.

When a program is selected for the first time, the display will show the average program duration for a cold water connection.

The program durations shown under “Program overview” refer to standard test loads and temperatures.

Each time a program is run, the control module calculates the program duration required depending on the temperature of the water taken into the dishwasher and the amount of dishes.

## Starting a program

- Start the program by closing the door. If necessary, confirm the previously displayed message with *OK*.

The in-operation indicator light comes on to show that a program sequence has been started.

During a program sequence, you can use *OK* to display the name of the program that is currently running when the door is open.

 Risk of scalding due to hot water. During operation, water in the dishwasher may be very hot. During operation, only open the door with extreme caution.

# Operation

---

## End of the program

At the end of the program, the in-operation indicator light will be flashing slowly with the door shut. The audible signal may also be sounding.

The in-operation indicator light will go out 10 minutes after the end of the program if the door is closed.

The program has ended when the display shows the message  Ready.

In some programs, if the AutoOpen function is activated, the door will automatically open slightly (see “AutoOpen” under “Settings”). This improves the drying process.

The drying fan may continue to run for a few minutes at the end of the program.

If you are not satisfied with the cleaning or drying results, you can activate the Extra Clean or Extra Dry functions to boost the performance of the programs (see “Extra Clean” or “Extra Dry” under “Extras”).

 Risk of damage due to steam.

Steam from the dishwasher could damage the edges of delicate cabinets and countertops when you open the door at the end of the program if the fan is no longer running.

If you have deactivated the automatic door opening function (see “AutoOpen” under “Settings”), but would still like to open the door at the end of the program, then make sure that you open the door fully.

## Energy management

To save energy, the dishwasher will switch off automatically 10 minutes after the last time a button is pressed or after the end of a program.

You can turn the dishwasher back on again with the  button.

The dishwasher will not turn itself off while a program is running or if there is a fault.



## Turning off the dishwasher

- Open the door.
- The dishwasher can be turned off at any time using the  button.

Turning the dishwasher off during a program stops the program.

- Use the  button to select the Turn appliance off option.
- Confirm the query Turn appliance off with *OK*.

You can also do this to stop an ongoing timer.



Risk of damage from leaking water.

Leaking water can cause damage.

If the dishwasher is not going to be used for a longer period of time, e.g., during vacations, the faucet should be turned off.

## Unloading the dishwasher

Dishes tend to break and chip more easily when they are hot. Allow the dishes to cool until they are comfortable enough to handle before unloading them.

The dishes will cool much faster if you open the door when the program has ended.

- First unload the lower basket, then the upper basket, and finally the 3D MultiFlex Tray (if present). This will prevent water drops from the upper basket and 3D MultiFlex Tray from falling onto the dishes in the lower basket.

# Operation

---

## Interrupting a program

A program will be interrupted as soon as the door is opened.

If the door is closed again, the program will continue from the point it was at before the door was opened.

 Risk of scalding due to hot water.

During operation, water in the dishwasher may be very hot.



During operation, only open the door with extreme caution.

## Canceling or changing a program

If a program is canceled, important program stages may be missed.

A program should only be canceled in the first few minutes of the program sequence.

If a program has already started and you wish to cancel it, proceed as follows:

- Open the door.
- Turn the dishwasher off with the  button.
- Use the  button to select the Turn appliance off option.
- Confirm the query Turn appliance off with *OK*.

If you would like to select another program:

- Turn the dishwasher on again with the  button.
- If you have dispensed detergent manually, check whether the detergent compartment is still closed. If the lid is already open, fill it with detergent again and close the lid.
- Select the program you want, and then start it by shutting the door.

The in-operation indicator light comes on to show that a program sequence has been started.

## Timer

You can set the start time of a program. The program start time can be delayed for between 30 minutes and 24 hours. With start-time delays between 30 minutes and 3 hours, the delay can be set in 30 minute stages. It is set in hours for periods longer than this.

During manual detergent dispensing, the detergent will clump together if the detergent compartment is not dry, and this may mean it is not fully rinsed out.



When using the timer function, make sure that the detergent compartment is dry before adding detergent. Wipe dry with a cloth first, if necessary. Do not use any liquid detergents. These can leak out.

 Danger to health due to detergent.

To prevent children coming into contact with dishwasher detergent:

Do not fill the detergent dispenser **until just before starting the program**, i.e., before you activate the timer.

## Activating the timer

- Open the door.
- Turn the dishwasher on with the  button.
- Select the program you want to use.
- Press the  *Timer* button.

The most recently set “Start in” time will be shown on the display. The  *Timer* indicator light will light up.

- Set the required time after which the program should start automatically using the  $\vee/\wedge$  buttons.

Pressing and holding buttons  $\vee$  or  $\wedge$  will automatically adjust the time.

- Confirm with *OK*.
- Close the door.

## Options

---

After you have activated the timer, all the displays will turn off after a few minutes to save energy.

Press the  button to switch the display back on again for a few minutes.

- Open the door if you need to check how long the timer has left to run.



The time up until the program starts will count down in the display in hours for durations above 10 hours, and in minutes for durations below 10 hours.

At the end of the delay period, the program selected begins automatically. The time left will appear in the display and the  *Timer* indicator light will go out.

### **Starting a program before the time for the timer has elapsed:**

A program can be started before the time for the timer has elapsed.



Proceed as follows:

- Open the door.
- Turn the dishwasher off with the  button.
- Turn the dishwasher on again with the  button.
- Select the program you want.
- Start the program by closing the door.

The in-operation indicator light comes on to show that a program has been started.

## Activating Remote start

You can start your dishwasher remotely using the Miele app. To do this, you first need to install the app on your mobile device, connect the dishwasher to your WiFi network (see “Miele@home” under “Settings”), and, if applicable, activate the Remote control option (see “Remote control” under “Settings”).

- Open the door.
- Turn the dishwasher on with the  button.
- Select  *Additional programs/Settings*.
- Select the MobileStart menu option.
- Confirm with *OK*.
- Select the setting you want.
- Confirm with *OK*.

The message *MobileStart active* will appear on the display.

- Turn the dishwasher off with the  button.
- Close the door.

The dishwasher can now be operated remotely using the Miele app.

The Remote start option will remain activated until you deactivate it again under  *Additional programs/Settings*. The option will also remain active if you turn the dishwasher off and back on again in the meantime.

Even if the Remote start option is not active, you can check the status of your dishwasher and apply settings using the Miele app.

If you start a program by closing the dishwasher door, the Remote start option will automatically be activated for the duration of the program.

## Operating hours display

You can display how many hours the dishwasher has been in operation so far.

- Open the door.
- Turn the dishwasher on with the  button.
- If necessary, confirm the messages and refill reminders with *OK*.
- Press the *Program* program selector for 5 seconds.

The operating hours are displayed.

- Use the *Back* or *OK* buttons to return to the program menu.

## Program overview

Program	When to use	Program sequence				
		Pre-rinse	Main wash °F/°C	Interim rinse	Final rinse °F/°C	Drying
Normal <sup>1</sup>	Program for regular use to completely wash a full load of normally soiled dishware with the ability to adjust energy and water consumption based on the soiling of the dishes.	✓	122–167/50–75	✓	133–149/56–65	✓
Pots & Pans	For heavily soiled dishware and normally soiled pots, pans, and cutlery with dried-on residue; use 20% more detergent than recommended.	✓	167/75	✓	131–158/55–70	✓
China & Crystal	For temperature-sensitive glasses and dishware with light soiling. Use 50% of the recommended detergent. GlassCare program for temperature-sensitive glasses and dishware with light soiling.	✓	113/45	✓	131–158/55–70	✓
Quick Intense-Wash	“Quick program” for standard dishware soiling that has not dried on.	-	131/55	✓	140/60	✓
SaniWash	To sanitize dishes, e.g., baby bottles, cutting boards, and preparation dishware.	-	167/75	✓	167/75	✓

<sup>1</sup> This program is used for energy labeling purposes.

## Program overview

Consumption <sup>2</sup>			Duration <sup>2</sup>	
Energy		Water		
Cold water 50°F/10°C kWh	Hot water 120°F/49°C kWh	Gallons/Liters	Cold water 50°F/10°C h:min	Hot water 120°F/49°C h:min
0.97	1.05	3.2/12.1	3:01	2:43
1.40	1.55	3.4/13.0	3:29	3:11
0.85	1.05	3.3/12.5	2:51	2:25
1.00	1.10	2.8/10.5	1:18	0:58
1.45	1.55	2.4/9.0	2:43	2:27

<sup>2</sup> Values were calculated under standardized testing conditions. In practice, the selected settings, program options, or operating conditions may result in different consumption values.

In practice, the selected settings, extras, or operating conditions may result in different values (see “Displaying the program cycle times” under “Operation”).

The energy consumption with a hot water connection includes the energy used to heat the water.

# Program overview

Program	When to use	Program sequence				
		Pre-rinse	Main wash °F/°C	Interim rinse	Final rinse °F/°C	Drying
Rinse & Hold	For performing a final rinse of dishware when a complete program is not needed.	✓	-	-	-	-
Extra Quiet	Extra Quiet program for mixed loads with standard, slightly dried-on food residue with a longer program cycle time.	-	122/50	✓	131–158/55–70	✓
Clean Machine	Special cleaning program to remove grease deposits from the dishwasher.	-	167/75	✓✓	158/70	✓
Rinse salt	Program for rinsing the wash cabinet after filling the salt reservoir.	✓	-	-	-	-



## Program overview

Consumption <sup>2</sup>			Duration <sup>2</sup>	
Energy		Water		
Cold water 50°F/10°C kWh	Hot water 120°F/49°C kWh	Gallons/Liters	Cold water 50°F/10°C h:min	Hot water 120°F/49°C h:min
0.01	0.20	1.1/4.0	0:21	0:21
0.95	1.15	2.4/9.0	4:16	3:58
1.75	2.00	5.0/19.0	2:37	2:07
0.01	0.40	2.2/8.5	0:13	0:13

<sup>2</sup> Values were calculated under standardized testing conditions. In practice, the selected settings, program options, or operating conditions may result in different consumption values.

In practice, the selected settings, extras, or operating conditions may result in different values (see “Displaying the program cycle times” under “Operation”).

The energy consumption with a hot water connection includes the energy used to heat the water.

# Options

---

## Selecting Extras

You can use options to adjust the programs.

To do this, you can select or deselect the extras before starting the selected program.

- Press the  *Extras* button.
- Select the extra you want and confirm with *OK*.

Extras that cannot be combined with the selected program or extra are indicated by a  lock symbol.

If necessary, a corresponding message appears on the display.

- In this instance, confirm the message with *OK*.
- Start the program by closing the door.

You can set whether the selected extras are to remain permanently activated for the respective program (see “Saving extras” under “Settings”).

## Express

You can reduce the program cycle time using the *Express* extra.

The time by which the program cycle time is shortened varies according to the selected program.

In order to achieve optimum wash results, the temperature, and therefore the energy consumption, will slightly increase with this option.

The *Express* extra may take precedence over other selected options.

## **BottleClean**

You can select the *BottleClean* extra to increase the cleaning performance of the programs for tall, narrow hollow containers, e.g., beer glasses, drinking bottles. Wash items that have been placed in the glass and bottle holders in the lower basket are cleaned particularly thoroughly (see “FlexCare Glass & Bottle” under “Loading the dishwasher”).

When this extra is activated, the program cycle time is extended and the cleaning temperature may increase. This will increase the water consumption and energy consumption.

## **IntenseZone**

You can select the *IntenseZone* extra to increase the cleaning performance of the programs in the lower basket.

When this extra is activated, the program cycle time is extended and the cleaning temperature increases. This will increase the water consumption and energy consumption.

## **Extra Clean**

You can select this option to increase the cleaning performance of the programs.

When this extra is activated, the program cycle time is extended and the cleaning temperature increases. This will increase the water consumption and energy consumption.

## **Extra Dry**

You can select this option in order to increase the program drying performance.

When this extra is activated, the program cycle time is extended and the final rinse temperature increases. This will increase energy consumption.

# Cleaning and care

Check the condition of your dishwasher regularly (approx. every 4–6 months). This helps to avoid faults and problems.

 Damage due to unsuitable cleaning agents.

All surfaces are susceptible to scratching. Contact with unsuitable cleaning agents can alter or discolor all surfaces.

Only use cleaning agents formulated for use on the relevant surfaces.

## Cleaning the wash cabinet

The wash cabinet is largely self-cleaning, provided that the correct amount of detergent is always used.

The frequent use of low-temperature wash programs (< 122°F/50°C) increases the risk of bacteria and odors inside the wash cabinet. Run the *Pots & Pans* program once per month to clean the wash cabinet and prevent odors from developing.

However, if residues such as limescale or grease have been deposited, use the Clean Machine program to clean the dishwasher (see “Additional programs ” under “Program overview”) with dishwasher cleaner (see “Clean Machine” under “Optional accessories”). Follow the dosage recommended by the manufacturer on the packaging.

Miele cleaning and care products are available to order from Miele’s online store.

- Clean the filters in the wash cabinet regularly.

## Hygiene cycle

The frequent use of low-temperature wash programs increases the risk of bacteria and odors inside the wash cabinet. If you repeatedly use low-temperature programs, you should regularly run a high-temperature program. This is to prevent contamination and odors.

You can activate or deactivate a Hygiene info message (see “Hygiene cycle” under “Settings”).

If you deactivate this message, run the *Pots & Pans* program once per month to clean the wash cabinet and prevent odors from developing.

## Cleaning the door and the door seal

The door seal and the sides of the dishwasher door are not accessed and cleaned by the spray arm jets. As a result, mold can develop here.

- Wipe the door seals regularly with a damp cloth to remove food deposits.
- Wipe off any food or drink residues which may have dripped onto the sides of the dishwasher door before closing it.

## Cleaning the control field

- The control field should **only** be wiped with a clean, damp cloth.

## Cleaning the reflector panel

The reflector panel for the in-operation indicator light is situated on the cover sheeting underneath the countertop.

- The reflector panel should only be cleaned with a damp cloth if necessary.

### Cleaning the appliance front



Damage due to soiling.

Soiling that is left too long might become impossible to remove and could cause the external surfaces to alter or discolor.

It is therefore best to remove any soiling immediately.

- Clean the appliance front with a clean soft sponge and a solution of warm water and liquid dish soap. After cleaning, wipe the front dry using a soft cloth.  
A clean, damp microfiber cloth without detergent can also be used.

**To avoid damaging the external surfaces, do not use the following:**

- cleaning agents containing soda, ammonia, acids, or chloride
- cleaning agents containing lime scale remover
- abrasive cleaning agents, such as scouring powder, scouring liquid, or pumice stones
- cleaning agents containing solvents
- stainless steel cleaner
- dishwasher cleaner
- oven cleaner
- glass cleaner
- hard, abrasive brushes, or sponges, e.g., pot scourers, brushes, or sponges which have been previously used with abrasive cleaning agents
- eraser sponges
- sharp metal scrapers
- steel wool
- steam cleaners

# Cleaning and care

## Cleaning the AutoDos assembly

If the Clean AutoDos message is displayed, check that the AutoDos is clean, and clean it if necessary, e.g., powder residues. This helps keep the AutoDos working properly.

In order to ensure that the AutoDos function works at its best, check it each time you replace the PowerDisk and clean it if needed.

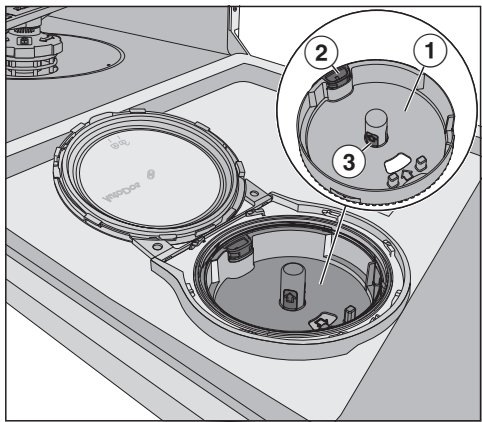

- ① PowerDisk holder
- ② yellow pull tab for unlocking the PowerDisk holder
- ③ yellow tabs on the PowerDisk holder

- Turn the AutoDos lid to  and open it.
- Remove the PowerDisk if appropriate.

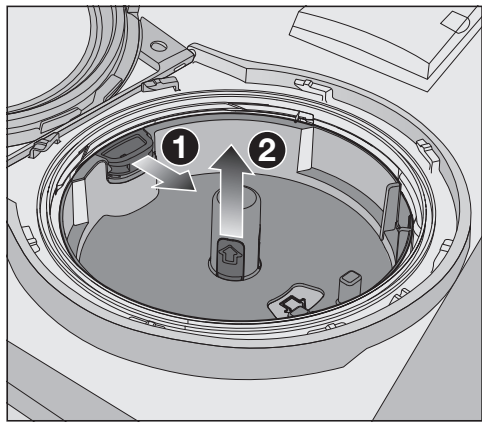

- Unlock the PowerDisk holder by pulling the yellow pull tab in the direction of the arrow ① and simultaneously pull the PowerDisk holder upward ② using the yellow tabs.
- Clean the AutoDos housing and the PowerDisk holder with a damp cloth.
- Dry all parts well so that the detergent powder does not clump together.

It is very important that no moisture stays inside the AutoDos system during cleaning.

## Cleaning and care

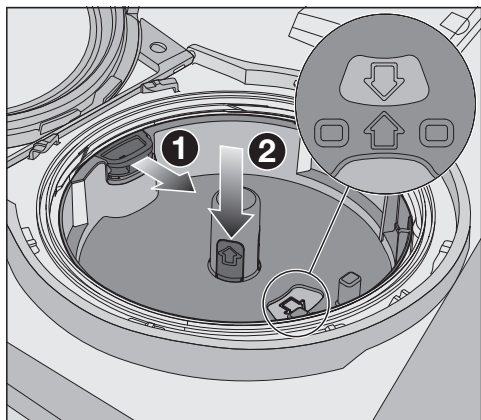

- Pull the yellow pull tab in the direction of the arrow ① and reinsert the PowerDisk holder ② at the same time. To do this, the arrows in the PowerDisk holder and in the viewing window must point toward each other. The holder must lie flat.

The AutoDos lid must close tightly so that the detergent powder does not get wet and clump together. Make sure that all seals are clean and clean them if necessary.

- Insert a filled PowerDisk and press it evenly downward until it sits flush.
- Close the AutoDos lid and turn it until the lid handle is directly below the  symbol (see “Inserting a PowerDisk” under “Detergent”).

Regularly check the lower spray arm for any blockages to ensure that the detergent outlet of the AutoDos can be fully flushed out (see “Cleaning the spray arms” under “Cleaning and care”).

## Cleaning and care

### Cleaning the spray arms

Particles of food can get stuck in the spray arm jets and bearings. The spray arms should therefore be inspected regularly (approx. every 2–4 months).

Never run a wash program without using the spray arms.

 Damage due to soiling entering the circulation system.

Without filters, soiling can enter the circulation system and cause a blockage.

Do not run a wash program without the lower spray arm or without the filters.

When cleaning the filters and spray arms, make sure that coarse soiling cannot get into the circulation system.

- Turn off the dishwasher.

### Removing the cutlery tray (if present)

In order to be able to remove the upper spray arm, you first have to remove the cutlery tray (if present).

- Pull out the cutlery tray.

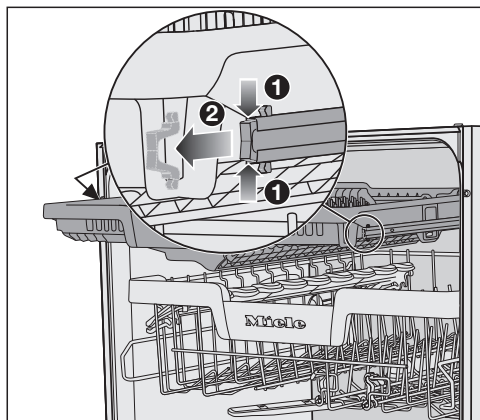

- Press the rail safety clips on both sides of the cutlery tray together **1** and remove the safety clips **2** at the same time.
- Take out the cutlery tray completely.



## Removing the upper spray arm

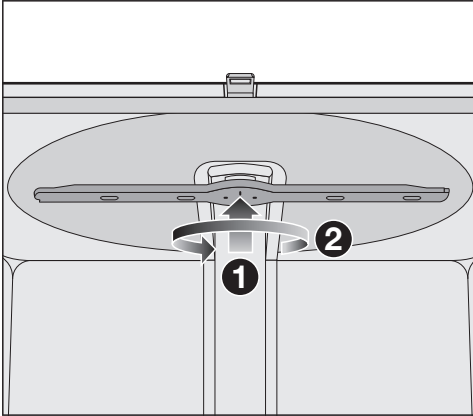

- Push the upper spray arm upward **1** to engage the inner ratchet. Then unscrew the spray arm by rotating the screw thread counterclockwise **2** (view from below).

## Removing the middle spray arm

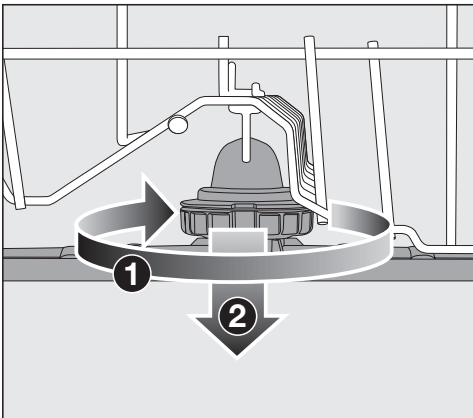

- Rotate the screw thread of the middle spray arm clockwise **1** (view from above) and remove the spray arm **2**.

## Removing the lower spray arm

- Remove the lower basket.

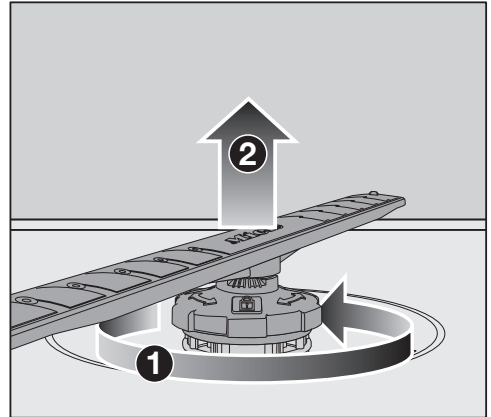

- Rotate the screw thread of the lower spray arm counterclockwise **1** (view from above) and pull the spray arm upward to remove **2**.

# Cleaning and care

## Cleaning the spray arms

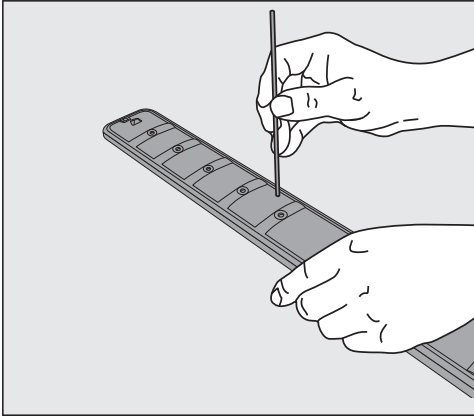

- Use a pointed object to push food particles that are stuck in the spray arm jets into the spray arm.
- Rinse the spray arm thoroughly under running water.

## Inserting the upper spray arm

- Reinstall the upper spray arm and tighten it by hand.

## Inserting the middle spray arm

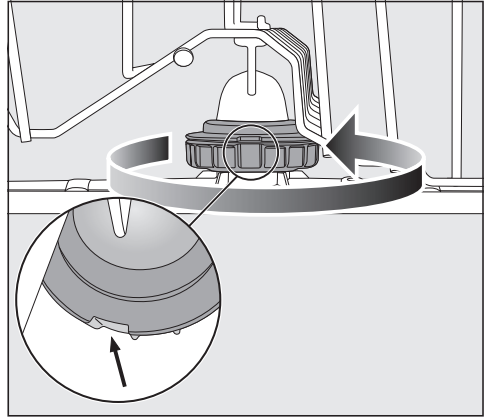



- Replace the middle spray arm and turn the screw thread counterclockwise (view from above) until it engages. Make sure that the recesses in the lock line up.

### Inserting the lower spray arm

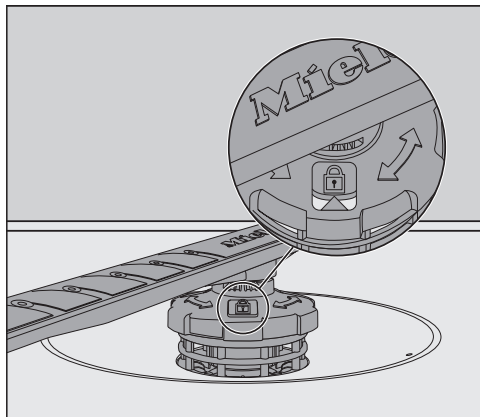
- Reinstall the lower spray arm and ensure that the filter combination lies flat in the base of the wash cabinet.



- Rotate the screw thread of the lower spray arm clockwise (view from above) until the arrow in the viewing window points to the lock symbol .
- Make sure the spray arms can rotate freely.

 Damage due to soiling entering the circulation system.

The lower spray arm is used to secure the filter combination. Without filters, coarse soiling can enter the circulation system and cause a blockage.

Do not run a wash program without the lower spray arm or without the filters.

### Inserting the cutlery tray (if present)

- Slide the cutlery tray back onto the rails from the front.
- Replace the safety clips in the rails on both sides of the cutlery tray.

## Cleaning and care

### Checking the filters in the wash cabinet

The filter combination in the base of the wash cabinet retains coarse soil from the suds solution. This prevents soiling getting into the circulation system and re-entering the wash cabinet through the spray arms.

 Damage due to soiling entering the circulation system.

Without filters, soiling can enter the circulation system and cause a blockage.

Do not run a wash program without the lower spray arm or without the filters.

When cleaning the filters and spray arms, make sure that coarse soiling cannot get into the circulation system.

The filters can become blocked by soiling that collects over time. The level of soiling and time it takes before the filters need cleaning will vary depending on use.

The message *Check filters* will appear in the display after every 50 program sequences.

- Check the filter combination.
- Clean if necessary.
- Then confirm the message with *OK*.

### Cleaning the filters

- Turn off the dishwasher.
- Remove the lower spray arm (see “Cleaning the spray arms” under “Cleaning and care”).
- Before removing the filter combination, remove any coarse soiling to prevent it from entering the circulation system.

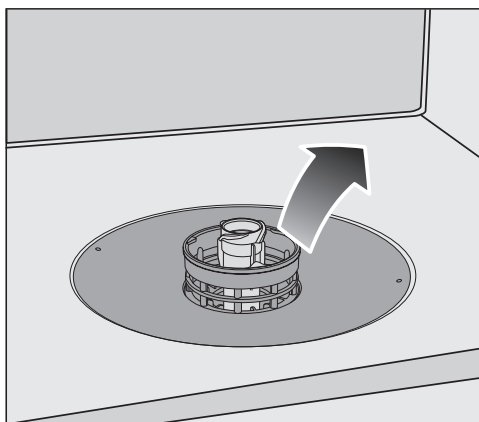

- Remove the filter combination.

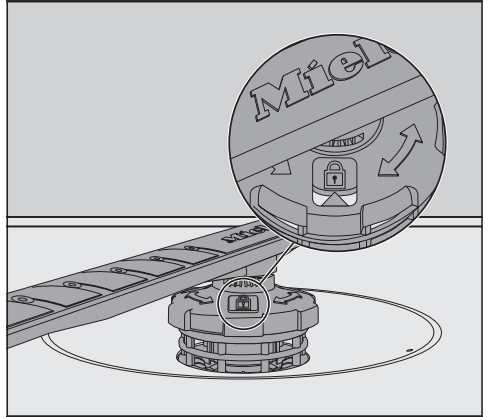
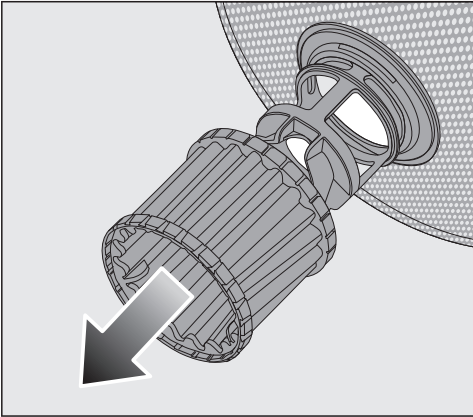

- In order to clean the inside of the filter, pull the microfilter on the plastic ring downwards and away from the filter combination.
- Rinse all of the filters under running water.  
If necessary, use a soft cleaning brush to remove soiling.
- Insert the microfilter back into the filter combination.
- Reinstall the filter combination so that it lies flat in the base of the wash cabinet.
- Refit the lower spray arm to the filter combination using the screw thread.

- Rotate the screw thread clockwise until the arrow in the viewing window points to the lock symbol .

 **Damage due to soiling entering the circulation system.**  
The lower spray arm is used to secure the filter combination. Without filters, coarse soiling can enter the circulation system and cause a blockage.  
Do not run a wash program without the lower spray arm or without the filters.

## Cleaning and care

### Cleaning the drain pump

If water remains in the wash cabinet after the end of a program, the water has not been drained off. The drain pump may be blocked by foreign objects. These foreign objects are easy to remove.

- Disconnect the dishwasher from the power supply.  
To do this, turn off the dishwasher and disconnect the electrical plug.
- Take the filter combination out of the wash cabinet (see “Cleaning the filters” under “Cleaning and care”).
- Scoop the water out of the wash cabinet using a small container.

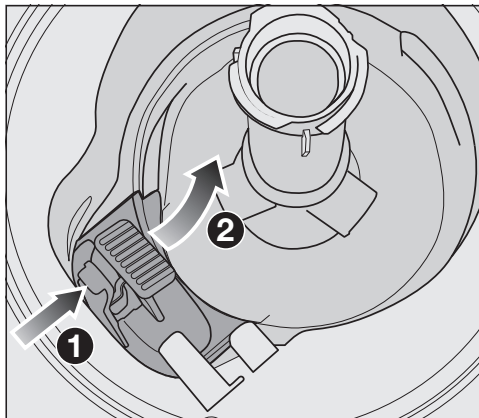

- Press the catch of the drain pump cover inward ①.
- Tip the cover inward until it is released ②.
- Rinse the cover thoroughly under running water and remove any foreign objects.

## Cleaning and care



**!** Damage due to incorrect cleaning.

The components are delicate and can be damaged during cleaning.

Take care when cleaning the drain pump.

The drain pump (see arrow) is underneath the cover.

**!** Risk of injury from glass splinters.

It is especially difficult to see glass splinters in the drain pump.

Take care when cleaning the drain pump.

- Carefully remove any foreign objects from the drain pump. Check the drain pump impeller by manually turning it. You will feel a little resistance when you turn the impeller.
- Reinstall the cover by pushing down.

Ensure that the catch engages correctly.

## Frequently asked questions





Many malfunctions and faults that can occur in daily operation can be easily remedied. You can save time and money in many cases, as you do not need to contact Miele Customer Service.

Information to help you rectify faults yourself can be found at [www.miele.com/service](http://www.miele.com/service).

The following tables are designed to help you to find the cause of a malfunction or a fault and to resolve it.



This section only lists faults that you can remedy yourself. All other faults are shown in  Fault F.

### Technical faults

Problem	Possible cause and solution
<b>The dishwasher does not start.</b>	The door is not properly closed. ■ Raise the door upward until the catch engages.
	The dishwasher is not plugged in. ■ Insert the plug.
	The circuit breaker has tripped. ■ Reset the breaker (see data plate for the correct fuse rating). ■ If the breaker trips again, contact Miele Customer Service.
	The dishwasher is not turned on. ■ Turn the dishwasher on with the  button.
<b>The  button does not respond immediately or only responds once it has been pressed several times.</b>	Energy management: the door was opened or closed shortly before the  button was pressed. As a result, the dishwasher was already switched on. The electronic module requires a few seconds to be ready for operation. ■ Wait a few seconds after opening or closing the door. ■ Then press the  button.
<b>The dishwasher stops during a program.</b>	The circuit breaker has tripped. The display is dark and the dishwasher cannot be turned on. ■ Reset the breaker (see data plate for minimum protection rating). ■ If the breaker trips again, contact Miele Customer Service.



## Fault messages

Problem	Possible cause and solution
<p><b>The in-operation indicator light is flashing quickly.</b>  <b>The alarm tone is sounding.</b>  <b>One of the following faults appears in the display:</b></p>	<p>Before remedying the fault:</p> <ul style="list-style-type: none"> <li>■ Turn off the dishwasher.</li> </ul>
<p> Fault F</p>	<p>There may be a technical fault.</p> <ul style="list-style-type: none"> <li>■ Turn the dishwasher back on after a few seconds.</li> <li>■ Select the program you want to use.</li> <li>■ Close the door.</li> </ul> <p>If the fault message appears again, there is a technical fault.</p> <ul style="list-style-type: none"> <li>■ Turn off the dishwasher.</li> <li>■ Close the faucet.</li> <li>■ Contact Miele Customer Service.</li> </ul>
<p> Waterproof</p>	<p>The Waterproof system has reacted.</p> <ul style="list-style-type: none"> <li>■ Turn off the dishwasher.</li> <li>■ Close the faucet.</li> <li>■ Contact Miele Customer Service.</li> </ul>

## Door release

Problem	Possible cause and solution
<p><b>The in-operation indicator light is flashing quickly.</b>  <b>The alarm tone is sounding.</b>  <b>The following fault is indicated via the display:</b></p>	<p>Before remedying the fault:</p> <ul style="list-style-type: none"> <li>■ Turn off the dishwasher.</li> </ul>

## Frequently asked questions

Problem	Possible cause and solution
 Door fault	<p>The door does not open automatically. There may be a technical fault.</p> <ul style="list-style-type: none"> <li>■ Open the door manually (see “Opening the door” under “Before using for the first time”) and turn the dishwasher back on again.</li> <li>■ If the same fault message appears again, contact Miele Customer Service.</li> </ul>
	<p>The door locking pins do not retract after the door is opened. There may be a technical fault.</p> <ul style="list-style-type: none"> <li>■ Turn the dishwasher back on.</li> <li>■ If the same fault message appears again, contact Miele Customer Service.</li> </ul>

## Water intake fault

Problem	Possible cause and solution
<p><b>The in-operation indicator light is flashing quickly.</b>  <b>The alarm tone is sounding.</b>  <b>One of the following messages appears in the display:</b></p>	
 Open water supply	<p>The faucet is turned off.</p> <ul style="list-style-type: none"> <li>■ Open the faucet all the way.</li> </ul>

## Frequently asked questions





Problem	Possible cause and solution
 Intake	<p>Before remedying the fault:</p> <ul style="list-style-type: none"> <li>■ Turn off the dishwasher.</li> </ul> <p>Water inlet fault.</p> <ul style="list-style-type: none"> <li>■ Open the faucet all the way and start the program again.</li> <li>■ Clean the water inlet filter (see “Cleaning the water inlet filter” under “Cleaning and care”).</li> <li>■ The water connection pressure is lower than 7.25 psi (50 kPa). Consult a plumber.</li> <li>■ The on-site connection for the water drainage may be too low and you will need to vent the water drainage (see “Water drainage” under “Installation”).</li> </ul>

### Water drainage fault





Problem	Possible cause and solution
<p><b>The in-operation indicator light is flashing quickly.</b>  <b>The alarm tone is sounding.</b>  <b>The following message appears on the display:</b>   Drain</p>	<p>Before remedying the fault:</p> <ul style="list-style-type: none"> <li>■ Turn off the dishwasher.</li> </ul> <p>Water drainage fault. There might be water in the wash cabinet.</p> <ul style="list-style-type: none"> <li>■ Clean the filter combination (see “Cleaning the filters” under “Cleaning and care”).</li> <li>■ Clean the drain pump (see “Cleaning the drain pump” under “Cleaning and care”).</li> <li>■ Remove any kink or loop in the drain hose.</li> </ul>

## Frequently asked questions

### Fault in the AutoDos (automatic dispensing)

Problem	Possible cause and solution
<p><b>The following message appears on the display:</b> Check PowerDisk</p>	<p>The  <i>AutoDos</i> function is activated. There is no PowerDisk or an empty PowerDisk has been inserted.</p> <ul style="list-style-type: none"><li>■ Confirm the message Check PowerDisk with <i>OK</i>.</li><li>■ Insert a full PowerDisk.</li><li>■ Use the <math>\vee/\wedge</math> buttons to select the Available message and confirm with <i>OK</i> (see “Automatic dispensing/ AutoDos” under “Detergent”).</li><li>■ If you do not wish to use automatic dispensing, deactivate the function using the  <i>AutoDos</i> button or by confirming the Not available message with <i>OK</i>.</li></ul>
<p><b>The in-operation indicator light is flashing quickly.</b> <b>The alarm tone is sounding.</b> <b>The program does not start or a program that has already started stops.</b> <b>The following message appears on the display:</b> AutoDos lid open</p>	<p>The AutoDos lid has not been closed properly.</p> <ul style="list-style-type: none"><li>■ Close the AutoDos lid and lock it fully (see “Automatic dispensing/AutoDos” under “Detergent”).</li><li>■ If the lid cannot be fully closed, check whether the PowerDisk holder is lying flat (see “Inserting a PowerDisk” under “Detergent”).</li><li>■ If the same fault message appears again, contact Miele Technical Service.</li></ul>
<p><b>The following message appears on the display:</b> PowerDisk empty Deactivate AutoDos with <i>OK</i>.</p>	<p>The  <i>AutoDos</i> function is active and the PowerDisk is empty.</p> <ul style="list-style-type: none"><li>■ Replace the PowerDisk (see “Automatic dispensing/ AutoDos” under “Detergent”).</li></ul> <p>If you do not wish to use automatic dispensing, deactivate the function using <i>OK</i> or the  <i>AutoDos</i> button.</p>

## Frequently asked questions

Problem	Possible cause and solution
<p><b>The in-operation indicator light is flashing quickly.</b>  <b>At the end of the program, the alarm tone might sound and the display shows the following message:</b>   Fault F601</p>	<p>There is a fault in the AutoDos.</p> <ul style="list-style-type: none"> <li>■ Turn off the dishwasher.</li> <li>■ If necessary, remove the PowerDisk holder and reinsert it (see “Automatic dispensing/AutoDos” under “Detergent”).</li> <li>■ Turn the dishwasher back on and restart the program.</li> </ul> <p>If the fault message appears again, there is a technical fault. However, you can continue using your dishwasher by removing the PowerDisk holder again and reinserting it. After closing the lid, deactivate AutoDos by pressing the  <i>AutoDos</i> button and manually dispense the detergent via the detergent compartment (see “Manual detergent dispensing” under “Detergent”).</p> <ul style="list-style-type: none"> <li>■ If you wish to use AutoDos again, contact Miele Customer Service.</li> </ul>
<p><b>The in-operation indicator light is flashing quickly.</b>  <b>At the end of the program, the alarm tone might sound and the display shows the following message:</b>  Maintenance AutoDos  <b>The dishwasher does not turn off at the end of the program.</b>  <b>The dishware may not be clean because an insufficient amount of detergent was dispensed.</b>  <b>The  <i>AutoDos</i> function is automatically deactivated during the program sequence.</b></p>	<p>No or an empty PowerDisk has been inserted or the AutoDos is blocked by residual detergent. Detergent dosage is insufficient.  The  <i>AutoDos</i> function was automatically deactivated.</p> <ul style="list-style-type: none"> <li>■ Turn the dishwasher off and back on again.</li> </ul> <p>Multiple messages appear in the display.</p> <ul style="list-style-type: none"> <li>■ Clean the AutoDos (see “Cleaning the AutoDos” under “Detergent”).</li> <li>■ Insert a full PowerDisk and close the AutoDos lid.</li> <li>■ Clean the lower spray arm (see “Cleaning the spray arms” under “Cleaning and care”).</li> <li>■ Select <i>OK</i> to confirm each message.</li> <li>■ Activate the  <i>AutoDos</i> function by confirming the message AutoDos available with <i>OK</i>.</li> <li>■ Restart the program.</li> </ul>

## Frequently asked questions

---

### Spray arm fault

Problem	Possible cause and solution
<p><b>During the program and at the end of the program, the display shows the following message:</b> Check spray arms <b>The dishwasher does not turn off at the end of the program.</b> <b>The dishware may not be clean because no detergent was dispensed.</b></p>	<p>The lower spray arm is blocked or the jets of the lower spray arm are clogged. The AutoDos detergent outlet may not be completely flushed out.</p> <ul style="list-style-type: none"><li>■ Turn the dishwasher off and back on again.</li></ul> <p>A message will appear on the display.</p> <ul style="list-style-type: none"><li>■ Perform a rotation check of the lower spray arm and rearrange the wash items if they are blocking the spray arm.</li><li>■ Clean the lower spray arm (see “Cleaning the spray arms” under “Cleaning and care”).</li><li>■ Confirm the message with <i>OK</i>.</li><li>■ Restart the program.</li></ul>

### General dishwasher problems

Problem	Possible cause and solution
<p><b>The indicator lights and the display are dark.</b></p>	<p>The dishwasher has turned off automatically to save energy.</p> <ul style="list-style-type: none"><li>■ Turn the dishwasher on again with the  button.</li></ul>
<p><b>Detergent residue is left in the detergent compartment at the end of a program.</b></p>	<p>The detergent compartment was still damp when detergent was added.</p> <ul style="list-style-type: none"><li>■ Only add the detergent when the detergent compartment is dry.</li></ul>
<p><b>The detergent compartment lid cannot be closed.</b></p>	<p>Residual detergent is blocking the catch.</p> <ul style="list-style-type: none"><li>■ Remove the residual detergent.</li></ul>
<p><b>At the end of a program there is a film of moisture on the inside of the door and possibly on the interior cabinet walls.</b></p>	<p>This is part of the normal function of the drying system. The moisture will dissipate after a short time.</p>

## Frequently asked questions

Problem	Possible cause and solution
<b>Water remains in the wash cabinet at the end of a program.</b>	Before remedying the fault: <ul style="list-style-type: none"> <li>■ Turn off the dishwasher.</li> </ul>
	The filter combination in the wash cabinet is clogged. <ul style="list-style-type: none"> <li>■ Clean the filter combination (see “Cleaning the filters” under “Cleaning and care”).</li> </ul>
	The drain pump is blocked. <ul style="list-style-type: none"> <li>■ Clean the drain pump (see “Cleaning the drain pump” under “Cleaning and care”).</li> </ul>
	The drain hose is kinked. <ul style="list-style-type: none"> <li>■ Remove any kinks from the drain hose.</li> </ul>
<b>Build-up of odors in the wash cabinet</b>	The frequent use of low-temperature wash programs (< 122°F/50°C) increases the risk of contamination and odors inside the wash cabinet. <ul style="list-style-type: none"> <li>■ Regularly run a high-temperature program. This is to prevent contamination and odors.</li> </ul>

## Noises

Problem	Possible cause and solution
<b>There is a knocking noise in the wash cabinet.</b>	A spray arm is knocking against a wash item. <ul style="list-style-type: none"> <li>■ Carefully open the door and rearrange the wash items that are obstructing the spray arm.</li> </ul>
<b>There is a rattling noise in the wash cabinet.</b>	Wash items are not secure in the wash cabinet. <ul style="list-style-type: none"> <li>■ Carefully open the door and rearrange the wash items so that they sit securely.</li> </ul>
	There is a foreign object (e.g., glass shard) in the drain pump. <ul style="list-style-type: none"> <li>■ Remove the foreign object from the drain pump (see “Cleaning the drain pump” under “Cleaning and care”).</li> </ul>
<b>Knocking noise in the water pipes</b>	This may be caused by the on-site installation or the cross-section of the piping. <ul style="list-style-type: none"> <li>■ However, this will not affect the functioning of the dishwasher in any way. If in doubt, contact a suitably qualified plumber.</li> </ul>

## Frequently asked questions

---

### Poor cleaning results

Problem	Possible cause and solution
<b>The dishware is not clean.</b>	The dishware was not loaded correctly. ■ See notes under “Loading the dishwasher”.
	The program was not powerful enough. ■ Select a more powerful program (see “Program overview”). ■ Activate the Extra clean function (see “Extra clean” under “Settings”). ■ Activate the “Second interim rinse” function (see “Settings – Second interim rinse”).
	Not enough detergent was dispensed. ■ Use more detergent during manual dispensing or change the detergent you are using. ■ Increase the dispensing quantity during automatic dispensing (if available) (see “Settings – AutoDos”).
	Items are blocking the path of the spray arms. ■ Carry out a rotation check and if needed rearrange the items so that the spray arms can rotate freely.
	The filter combination in the wash cabinet is not clean or was incorrectly installed. This may have caused the spray-arm jets to become blocked. ■ Clean and/or install the filter combination correctly. ■ Clean the spray-arm jets if necessary (see “Cleaning the spray arms” under “Cleaning and care”).
<b>There are smears on glassware and cutlery. There is a bluish sheen on the surface of glassware. The film can be wiped off.</b>	The rinse aid dosage is set too high. ■ Reduce the dosage (see “Rinse aid” under “Settings”).



## Frequently asked questions

Problem	Possible cause and solution
<p><b>The dishware is not dry or utensils and glasses are flecked.</b></p>	<p>The rinse-aid dosage is set too low or the rinse-aid reservoir is empty.</p> <ul style="list-style-type: none"> <li>■ Replenish the reservoir, increase the dosage, or change the brand of rinse aid (see “Rinse aid” under “Before using for the first time”).</li> </ul>
	<p>The dishware was taken out of the wash cabinet too soon.</p> <ul style="list-style-type: none"> <li>■ Leave the dishware in longer (see “Unloading the dishwasher” under “Operation”).</li> </ul>
	<p>The duration of the drying phase for the selected program is not sufficient for the dishware (particularly for plastic dishware).</p> <ul style="list-style-type: none"> <li>■ Select the Extra Dry function (see “Extra Dry” under “Settings”).</li> </ul>
	<p>You have used combination products that have insufficient drying performance.</p> <ul style="list-style-type: none"> <li>■ Switch to another detergent or replenish the rinse aid (see “Rinse aid” under “Before using for the first time”).</li> </ul>
<p><b>Glassware has a brown or blue tinge. The film cannot be wiped off.</b></p>	<p>Ingredients from the detergent have formed a deposit.</p> <ul style="list-style-type: none"> <li>■ Switch to another detergent straight away.</li> </ul>
<p><b>Glassware is dull and discolored. The film cannot be wiped off.</b></p>	<p>The glassware is not dishwasher-safe. The surface has altered.</p> <ul style="list-style-type: none"> <li>■ No remedy. Purchase glassware which is dishwasher-safe.</li> </ul>
<p><b>Tea or lipstick stains have not been completely removed.</b></p>	<p>The wash temperature of the selected program was too low.</p> <ul style="list-style-type: none"> <li>■ Select a program with a higher wash temperature.</li> </ul>
	<p>The bleaching effect of the detergent is too low.</p> <ul style="list-style-type: none"> <li>■ Switch to another detergent.</li> </ul>
<p><b>White residue is visible on the dishware. Clouding has occurred on glassware and utensils. The film can be wiped off.</b></p>	<p>The rinse-aid dosage is set too low.</p> <ul style="list-style-type: none"> <li>■ Increase the dosage (see “Rinse aid” under “Settings”).</li> </ul>
	<p>The salt reservoir is empty.</p>

## Frequently asked questions

Problem	Possible cause and solution
	<p>■ Fill the salt reservoir (see “Reactivation salt” under “Before using for the first time”).</p> <p>The salt-reservoir cap has not been screwed on correctly.</p> <p>■ Replace it, making sure that it screws back on correctly.</p> <p>Unsuitable combination detergents were used.</p> <p>■ Switch to another detergent. If using detergent tabs or powder detergent, do not choose combination products and ensure you refill the reactivation salt and rinse aid.</p> <p>The water softener is programmed to too low a water hardness level.</p> <p>■ Program the water softener to a higher water hardness level (see “Water hardness” under “Settings”).</p> <p>Too much detergent was dispensed.</p> <p>■ Reduce the dispensing quantity during automatic dispensing (if available) (see “Settings – AutoDos”).</p> <p>■ Activate the “Second interim rinse” function (see “Settings – Second interim rinse”).</p> <p>Not enough combination detergent was dispensed. The water softener performance is not sufficient.</p> <p>■ Increase the dispensing quantity during automatic dispensing (if available) (see “Settings – AutoDos”).</p> <p>■ Add more reactivation salt.</p>
<p><b>Plastic parts are discolored.</b></p>	<p>Natural dyes, e.g., from carrots, tomatoes, or ketchup may be the cause. The amount of detergent used or its bleaching effect was not sufficient to deal with natural dyes.</p> <p>■ Use more detergent (see “Detergent”). Parts that are already discolored will not revert to their original color.</p>

## Frequently asked questions

Problem	Possible cause and solution
<b>There are rust stains on the cutlery.</b>	<p>The affected items are not corrosion resistant.</p> <ul style="list-style-type: none"><li>■ No remedy. Purchase cutlery which is dishwasher-safe.</li></ul>
	<p>A program was not run after reactivation salt was added. Traces of salt have got into the normal wash cycle.</p> <ul style="list-style-type: none"><li>■ Immediately after filling the salt reservoir and each time you remove the salt reservoir cap, run the <b>Rinse salt</b> program without wash items in the dishwasher to dissolve and remove any traces of salt from the wash cabinet.</li></ul>
	<p>The salt reservoir cap has not been screwed on correctly.</p> <ul style="list-style-type: none"><li>■ Replace it, making sure that it screws back on correctly.</li></ul>

## Customer Service

---

Information to help you rectify faults yourself and about Miele spare parts can be found at [www.miele.com/service](http://www.miele.com/service).

### Contact in the event of a fault

In the event of a fault which you cannot remedy yourself, please contact your Miele dealer or Miele Customer Service.

You can book a Miele Service Call online at [www.miele.com/service](http://www.miele.com/service).

Contact information for Miele Customer Service can be found at the end of this document.

Please quote the model identifier and serial number of your appliance (SN) when contacting Miele Customer Service. Both pieces of information can be found on the data plate.

The data plate is located on the right side of the door.

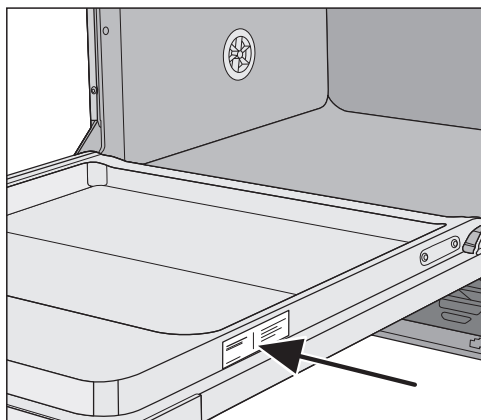

### Appliance warranty and product registration

You can register your product and/or view the manufacturer's warranty terms and conditions for Miele appliances and vacuum cleaners at [www.mieleusa.com](http://www.mieleusa.com).

Dishwasher detergent, rinse aid, and cleaning and care products are available for this dishwasher, as are optional accessories.

All the products have been designed for Miele appliances.

These and many other useful products can be ordered directly from Miele's online store, Miele Customer Service, or from your Miele dealer.

### **Dishwasher detergent, rinse aid, and salt**

You have chosen excellent quality and performance with your Miele dishwasher. To achieve optimum results all the time, it is important to use the right dishwasher detergents. Not all off-the-shelf products deliver the same results in all dishwashers.

For this reason Miele offers dishwasher products specifically designed for Miele appliances.

#### **PowerDisk**

Special Miele formula – for outstanding cleaning results in Miele dishwashers with AutoDos automatic dispensing.

- Exclusive Miele powder granulate
- With rinse aid and salt functions
- With components to protect glass
- With active oxygen for thorough cleaning
- With super-active enzymes – effective even at low temperatures

In hard water areas, we recommend using the complete Miele system: The PowerDisk, rinse aid, and salt perfectly match each other.

#### **Detergent tabs**

- Sparkling results even with stubborn food deposits
- Combination product with other functions such as rinse aid, salt, and glass protection additives
- Phosphate-free – kind to the environment
- Water-soluble wrapping – no need to unwrap

#### **Powder detergent**

- With active oxygen for thorough cleaning
- With enzymes which are effective even in low-temperature programs
- With glass-protection formula against corrosion

#### **Rinse aid**

- For sparkling glasses
- Helps dishes to dry
- With glass-protection formula against corrosion
- Specially designed cap for accurate and easy dispensing

#### **Reactivation salt**

- Prevents limescale on dishes and in the appliance
- Extra coarse-grained

# Optional accessories

---

## Appliance care

Miele cleaning and care products provide optimum care for your dishwasher.

### Dishwasher cleaner

- For use with the Clean Machine program without detergent dispensing
- Cleans the dishwasher effectively and thoroughly
- Removes grease, bacteria, and associated unpleasant odors
- Ensures excellent dishwashing results

### Descaling agent

- Removes heavy limescale deposits
- Mild and gentle with natural citric acid

### Dishwasher conditioner

- Removes odors, limescale, and light deposits
- Maintains the elasticity and leak tightness of the seals

### Dishwasher freshener

- Neutralizes unpleasant odors
- Fresh, pleasant lime and green tea scent
- Easy and convenient to attach to the dishwasher basket
- Very economical; lasts for 60 rinses

## Water inlet

 Risk to health due to wash water. Water in the dishwasher must not be used as drinking water. Do not drink any water from the dishwasher.

 Risk to health and risk of damage due to contaminated incoming water. The quality of the incoming water must correspond to the drinking water regulations of the country in which the dishwasher is being operated. Connect the dishwasher to a drinking water supply.

The dishwasher may be connected to cold or hot water (up to max. 140°F/60°C) supplies.

It is recommended to connect to a cold water connection to reduce energy consumption.

If energy-saving water-heating sources, such as solar energy circulation systems, are used, it is recommended to connect to the hot water connection.

This saves both time and electrical energy costs. Hot water is used in all programs.

The water inlet hose is approximately 5 ft (1.5 m) long. The slightly transparent corrugated hose around the water inlet hose provides protection during transportation and can be removed if necessary. However, the corrugated hose can also be left in place around the water inlet hose to provide additional protection.

A 5 ft (1.5 m) long, flexible metal extension hose (tested to 2,030 psi (14,000 kPa/140 bar) is available as an optional accessory from Miele dealers or Miele Customer Service.

## Installation

The dishwasher is supplied with a 3/8" diameter inlet (with a UNEF 9/16" – 24 female threaded nut) and requires an on-site water connection with 3/8" compression fitting and shut-off valve. If this type of faucet is not available, only a qualified installer may connect the dishwasher to the drinking water supply.

A backflow preventer is not required.

The appliance meets the requirements of the applicable DIN standards.

The water connection pressure needs to be between 7.25 and 145 psi (50 and 1,000 kPa). If the water connection pressure is too high, a pressure reducing valve must be installed.

 Risk of damage from leaking water.

The connection point is subject to water pressure. Water leaking from it can cause damage.

You should therefore open the faucet slowly and check for leaks. Correct the position of the seal and screw thread if appropriate.

 Risk of damage due to excessive pressure.

A brief increase in the water pressure can damage components of the dishwasher.

This dishwasher must only be operated when it is connected to a fully vented plumbing system.

 Risk of damage from leaking water.

The water inlet hose is under water pressure.

The water inlet hose must not be shortened or damaged in any way.

 Risk to health and risk of damage due to damaged power cord or water inlet hose

Damage to the power cord or water inlet hose can lead to electric shocks or water damage.

Do not place the dishwasher on the water inlet hose. The water inlet hose must be free of kinks and able to move freely after installation. Do not install the water inlet hose or the power cord next to a heat source, such as a hot water pipe. Do not expose the water inlet hose or the power cord to corrosive substances (such as chloride).



## Water drainage

The appliance drainage system has a non-return valve, which prevents dirty water from flowing back into the dishwasher via the drain hose.

The dishwasher is supplied with approx. 5 ft (1.5 m) of flexible drain hose with an internal diameter of 7/8" (22 mm).

The hose can be extended using a connection piece to attach a further length of hose. The drainage length must not be longer than 13 ft (4 m) and the delivery head no higher than 3 ft (1 m).

If the hose is to be directly connected to the drainage outlet on site, use the supplied hose clip (see the installation diagram).

The hose can be directed to the left or the right of the appliance.

The on-site connector for the drain hose can be used for various hose diameters. If the connector extends too far into the drain hose, it must be shortened. Otherwise, the drain hose can become clogged.

Only use a Miele approved connection piece when extending the drain line.

Only use a Miele extension drain hose.

The drain hose must not be shortened.

Lay the drain hose so that it does not kink and is not being subjected to pressure or tugged.



Risk of damage from leaking water.

Leaking water can cause damage.

After servicing the appliance, ensure that the drain does not leak.

## Venting the water drain

If the on-site drainage connection is situated lower than the guide path for the lower basket rollers in the open door, the drainage system must be vented. Otherwise, a siphoning effect during a program can cause the wash cabinet to empty itself of water.

- Open the dishwasher door fully.

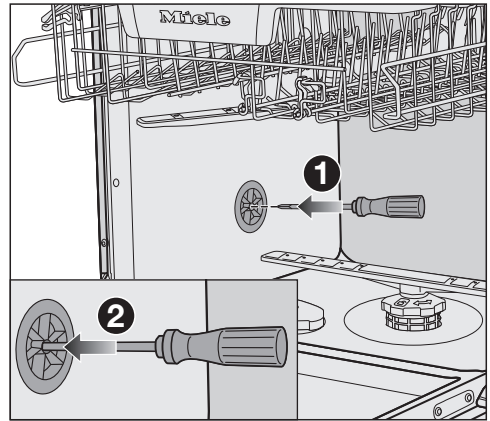

- Remove the lower basket.
- Insert a screwdriver into the middle opening of the vent valve in the left wash cabinet wall ①.
- Press the screwdriver further into the opening and push it through the membrane ② behind.

The vent opening for the water drain is now open.

# Installation

 Installation, repairs and other work by unqualified persons could be dangerous.

Check that the voltage, frequency and fuse rating shown on the data plate match the household power supply.

The power outlet must be accessible after installation. Do not use an extension cord to connect the dishwasher to the electrical supply. Danger of overheating! See data plate on the right side of the door.

A damaged power cord must only be replaced with a genuine Miele cord by a Miele service technician.

 Improper connection of the equipment grounding conductor can result in electric shock.

Do not modify the plug provided with the appliance; if it will not fit the outlet, have a proper outlet installed by a qualified electrician.

If there is any question concerning the proper electrical connection or grounding of this appliance to the power supply, please consult a licensed electrician or call Miele's Customer Service Department:  
USA: 1-888-99-MIELE(64353)  
CDN: 1-800-565-6435

## Grounding instructions

**THIS APPLIANCE MUST BE GROUNDED.**

In the event of a malfunction or breakdown, grounding will reduce the risk of electric shock by providing a path of least resistance for the electrical current. This appliance is equipped with a cord having an equipment grounding conductor and a grounding plug. The plug must be plugged into an appropriate outlet that is installed and grounded in accordance with all local codes and ordinances.

## Specifications

The dishwasher comes equipped with a 4 ft (1.2 m) power cord (measured from the rear of the dishwasher) with a molded plug for connection to 120 V, 60 Hz, 15 A grounded receptacle.

## Hardwired electrical connection

It is possible to hardwire this appliance to an existing power cable.

**⚠ CAUTION:** Before servicing, disconnect the power supply by either removing the fuse, shutting off the power main or manually “tripping” the circuit breaker.

Installation work and repairs should only be performed by a qualified technician in accordance with all applicable codes and standards. Repairs and service by unqualified persons could be dangerous and the manufacturer cannot be held responsible.

Before connecting the appliance to the power supply, make sure that the voltage and frequency listed on the data plate correspond with the household electrical supply. This data must correspond to prevent machine damage. Consult an electrician if in doubt.

## GROUNDING INSTRUCTIONS

**THIS APPLIANCE MUST BE GROUNDED.**

This appliance must be connected to a grounded metal, permanent wiring system, or an equipment-grounding conductor must be run with the circuit conductors and connected to the equipment-grounding terminal or lead on the appliance.

**⚠** Prior to making a hardwire connection to the terminal, remove the powercord. Otherwise there will be a risk of electric shock from the attached plug.

An existing flexible supply cord or cable shall have a minimum thickness of AWG 14.

120 V, 60 Hz, 15 A fuse rating

Black wire (live): connect to L

White wire (neutral): connect to N

Green wire (ground): connect to 

**⚠** After attaching the permanent power supply cord, check that all wires are correctly and securely placed in the connector and the strain relief is tightened.

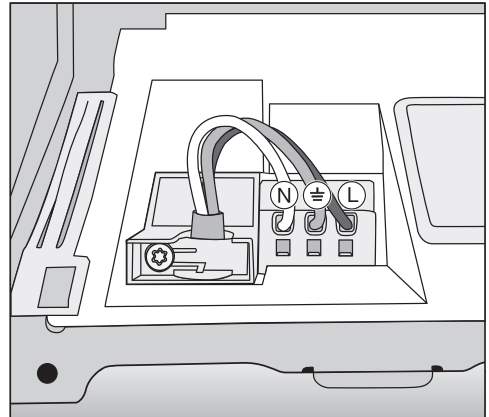

# Sound emission testing

---

## Prerequisites for sound emission tests

Load the dishwasher with **16 standard place settings** and use the *Normal* program.

## Setup for sound emission tests

The dishwasher must be set up according to the following specifications.

- Install the dishwasher into an analyzing unit.
- Secure the front panel.

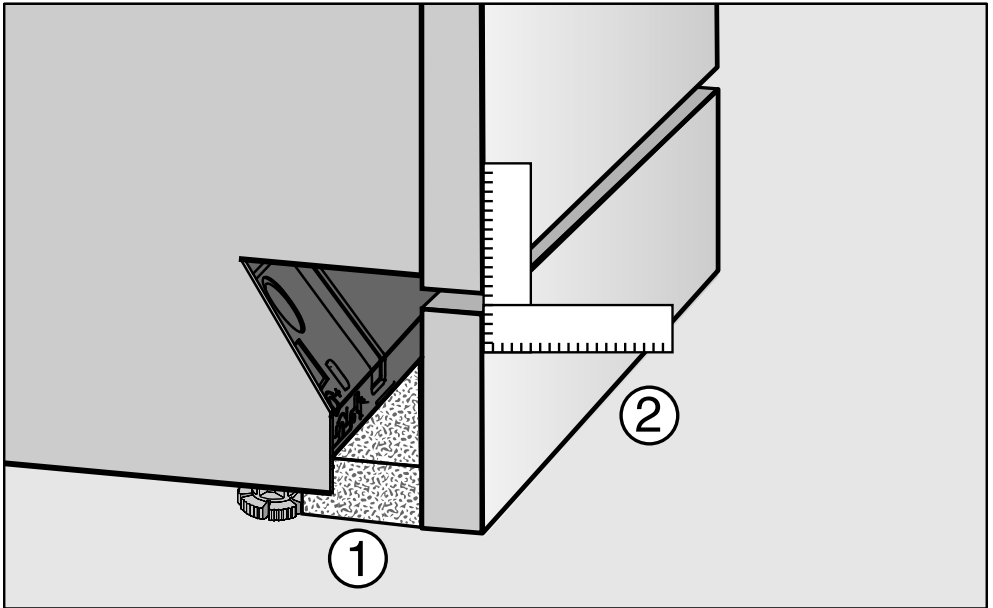

- Push the provided fleece strips (depending on model) under the base until it is flush with the appliance feet ①.
- Push the toe-kick into place in such a way that it is flush with the door panel ②.

## Sound emission testing

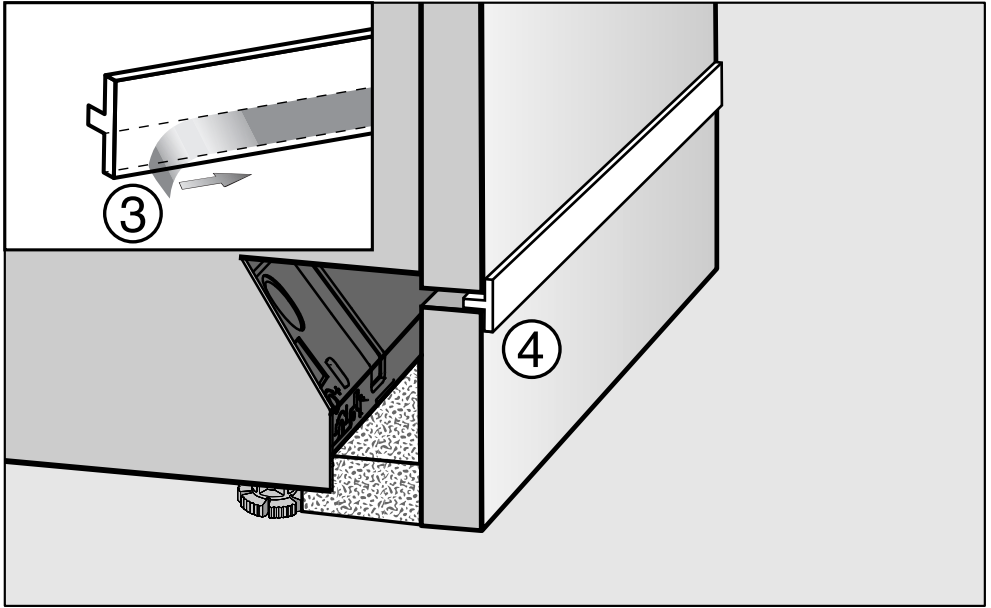

- Remove the protective film from the provided insulating strip (depending on model) ③.
- Stick the insulating strip onto the front top edge of the toe-kick board ④.



Please have the model and serial number of your appliance available when contacting Customer Service.

---

## **U.S.A.**

**Miele, Inc.**

### **National Headquarters**

9 Independence Way  
Princeton, NJ 08540  
[www.mieleusa.com](http://www.mieleusa.com)

### **Customer Support**

Phone: 888-99-MIELE (64353)  
[info@mieleusa.com](mailto:info@mieleusa.com)

### **International Headquarters**

Miele & Cie. KG  
Carl-Miele-Straße 29  
33332 Gütersloh  
Germany

## **Canada**

**Importer**  
**Miele Limited**

### **Headquarters and Miele Centre**

161 Four Valley Drive  
Vaughan, ON L4K 4V8  
[www.miele.ca](http://www.miele.ca)

### **Customer Care Centre**

Phone: 1-800-565-6435  
905-532-2272  
[customercare@miele.ca](mailto:customercare@miele.ca)

G 7186, G 7193, G 7196

en-US

M.-Nr. 12 783 760 / 00