

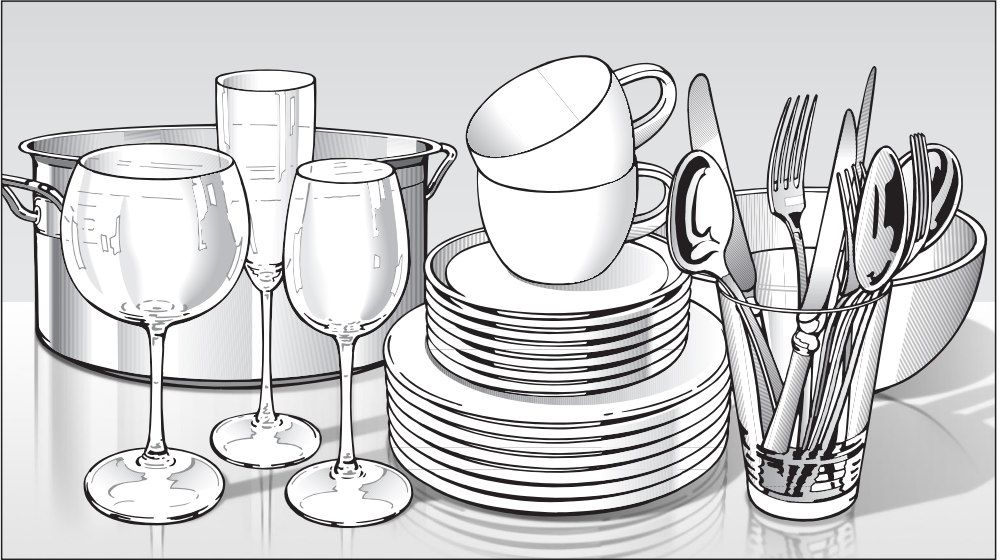

**Miele**

# OPERATING INSTRUCTIONS



## Commercial Dishwasher PFD 101 U / PFD 102i

en-US, CA

 To prevent accidents and machine damage, read these instructions **before** installation or use.

M.-Nr. 11 673 621



<b>Notes about these instructions</b> .....	<b>6</b>
Operating steps .....	6
<b>IMPORTANT SAFETY INSTRUCTIONS</b> .....	<b>7</b>
APPROPRIATE USE .....	7
<b>Machine description</b> .....	<b>17</b>
Appliance overview .....	17
Control field.....	18
Display functions.....	19
<b>Caring for the environment</b> .....	<b>20</b>
<b>Initial commissioning</b> .....	<b>21</b>
Miele@home .....	21
Opening the door .....	21
Closing the door .....	23
Activating the safety lock.....	23
Basic settings.....	24
Setting the language .....	24
Setting up Miele@home .....	24
Setting the time .....	25
Setting water hardness.....	25
Reactivation salt .....	26
Refilling the salt.....	27
Rinse aid .....	28
Adding rinse aid.....	29
Filling the rinse-aid reservoir.....	29
<b>Caring for the environment</b> .....	<b>30</b>
Energy-saving dishwashing.....	30
EcoFeedback consumption display .....	31
<b>Loading the dishwasher</b> .....	<b>32</b>
General information .....	32
Upper basket.....	34
Adjusting the upper basket .....	37
Lower basket.....	38
Cutlery.....	41
Cutlery basket (depending on model) .....	41
Loading examples.....	42
<b>Detergents</b> .....	<b>44</b>
Dispensing detergent.....	45
Adding detergent.....	46

# Contents

---

<b>Operation</b> .....	<b>47</b>
Turning on the dishwasher .....	47
Selecting a program .....	47
Display of program cycle time .....	48
Starting a program .....	48
Program end .....	49
Energy management .....	49
Turning off the dishwasher .....	50
Unloading the dishwasher .....	50
Interrupting a program .....	51
Canceling or changing a program .....	51
<b>Options</b> .....	<b>52</b>
Options .....	52
Timer ⌚ .....	53
Activating Remote start  .....	57
<b>Program chart</b> .....	<b>58</b>
<b>Cleaning and care</b> .....	<b>61</b>
USER MAINTENANCE INSTRUCTIONS .....	61
Cleaning the wash cabinet .....	61
Cleaning the door and the door seal .....	62
Cleaning the control panel .....	62
Cleaning the front of the machine .....	62
Cleaning the spray arms .....	63
Checking the filters in the wash cabinet .....	65
Cleaning the filters .....	65
Cleaning the water-inlet filter .....	67
Cleaning the drain pump .....	68
<b>Troubleshooting</b> .....	<b>70</b>
Technical faults .....	70
Fault messages .....	71
Door release .....	72
Water intake fault .....	73
Water drainage fault .....	74
General dishwasher problems .....	75
Noises .....	76
Poor cleaning results .....	77
<b>Miele Service</b> .....	<b>80</b>
Contact in the event of a fault .....	80
Program updates .....	80
<b>INSTALLATION INSTRUCTIONS</b> .....	<b>81</b>

<b>Electrical connection</b> .....	<b>82</b>
<b>Plumbing</b> .....	<b>83</b>
The Miele Waterproof system.....	83
Water inlet.....	83
Connecting the water drainage system.....	85
<b>Technical details</b> .....	<b>86</b>
<b>Settings</b> ▾.....	<b>87</b>
Opening the Settings menu.....	87
Changing settings.....	87
Language ▾.....	88
Time of day.....	88
Water hardness.....	89
Rinse Aid.....	90
Temperature unit.....	90
High-temperature final rinse.....	90
Miele@home.....	90
Remote control.....	94
RemoteUpdate.....	94
SmartStart.....	95
EcoStart.....	96
Consumption (EcoFeedback).....	98
Display brightness.....	98
Volume.....	99
Memory.....	99
Refill reminders.....	99
AutoOpen.....	100
BrilliantLight (depending on model).....	100
Software version.....	100
Showroom program.....	100
Factory default.....	100
<b>Sound emission tests</b> .....	<b>101</b>

# Notes about these instructions

---

## Warnings

 Warnings important for safety are highlighted like this. This alerts you to the potential danger of injury to people or damage to property. Read the warnings carefully and follow the instructions and directions.

## Notes

Notes contain information that is particularly important to follow. They are highlighted in a thick framed box.

## Additional information and comments

Additional information and comments are contained in a narrow frame.

## Operating steps

Instructions on how to operate the commercial dishwasher are identified by marked operating steps. They explain the procedure step by step. Operating steps are identified by a black square bullet point.

Example:

- Select the setting you want and press *OK* to confirm.

## Display

Information that is shown in the commercial dishwasher display appears in a special font similar to the display text.

Example:

When the message End or Auto Open Drying appears in the display ...

# IMPORTANT SAFETY INSTRUCTIONS

## APPROPRIATE USE

This Commercial Dishwasher complies with all current local and national safety requirements. Inappropriate use can, however, lead to personal injury and material damage.

### WARNING:

When using your dishwasher, follow basic precautions, including the following:

Read the operating instructions carefully before using the Commercial Dishwasher for the first time. They contain important information on the safety, use, and maintenance of the machine. Keep these operating instructions in a safe place and pass them on to any future user.

▶ This dishwasher with its short program cycle times and powerful cleaning performance is intended for commercial use in offices, lunch rooms, clubhouses, workshops, large kitchens, and similar professional environments.

It is also suitable for use in domestic households and in similar residential environments; for example, by customers in hotels, motels, bed and breakfasts, and other related establishments.

▶ The commercial dishwasher is subsequently referred to as a dishwasher in these operating instructions.

Glasses, cutlery and dishes are referred to generally as cookware when not more specifically defined.

▶ This dishwasher is not intended for continuous use.

▶ This dishwasher is not intended to be used to clean medical devices or products.

▶ This machine is designed exclusively for use as a “dishwasher” for cleaning wash items as described in these instructions. Conversions, modifications, and any other use are not permitted.

▶ This dishwasher is intended for stationary, indoor use only.

▶ This dishwasher is intended for use at altitudes of up to 13,000 ft (4,000 m) above sea level.

▶ The special inserts in the baskets should only be used for their specific application.

## IMPORTANT SAFETY INSTRUCTIONS

---

- ▶ This dishwasher can only be used by people with reduced physical, sensory or mental capabilities, or lack of experience or knowledge, if they are supervised while using it or have been shown how to use it in a safe way and understand and recognize the consequences of incorrect operation.
- ▶ The dishwasher is equipped with interior lighting. It is not suitable for room lighting. Replacement lamps may only be installed by a Miele-authorized specialist or by Miele Service.



# IMPORTANT SAFETY INSTRUCTIONS

## Proper installation

▶ Do not install the machine in an area where a danger of explosion or of freezing temperatures may be present.



▶ Be careful when installing the dishwasher. Wear protective gloves to avoid injury on any sharp metal components.

▶ To ensure the stability of undercounter dishwashers, these units may only be installed beneath a continuous countertop that is bolted to adjacent cabinetry.

▶ In order to reduce the risk of damage from condensation, the cabinetry in the area around the dishwasher should be designed for commercial use.

Delicate cabinetry can be protected using the damp protection set, which is available as an optional accessory.

The vapor barrier film needs to be adhered to the underside of the countertop where the dishwasher door is opened.

▶ The door springs must be evenly adjusted on both sides. They are correctly adjusted when the door remains stationary when left half open (approx. 45° opening angle). It is also important that the door cannot fall open.

The machine must only be operated with properly adjusted door springs.

If the door cannot be adjusted properly, contact the Miele Customer Service.

The maximum weight of the front panel that can be aligned with the factory-installed door springs is 22-26.5 lb (10–12 kg) (depending on model).

# IMPORTANT SAFETY INSTRUCTIONS

---

## Technical safety

- ▶ This dishwasher should be installed, commissioned, repaired, and maintained by Miele Service, a dealer, or a suitably qualified specialist. Unauthorized installation, maintenance, and repairs can cause considerable danger for the user.
- ▶ This dishwasher should only be operated by appropriately trained personnel. They should be instructed and trained regularly.
- ▶ Do not operate your dishwasher unless all enclosure panels are properly in place. Before using the dishwasher, check it for any externally visible damage. Do not use a damaged dishwasher. This could be dangerous.
- ▶ In the event of a damaged or leaking dishwasher, switch off at the power supply immediately and call Miele Technical Service, a Miele dealer, or a suitably qualified service technician.
- ▶ Faulty components should only be replaced by genuine Miele original parts. Only when these parts are fitted can Miele guarantee the safety standards of the appliance.
- ▶ **WARNING** – Improper connection of the equipment-grounding conductor can result in a risk of electric shock. Check with a qualified electrician or service representative if you are in doubt whether the appliance is properly grounded. Do not modify the plug provided with the appliance, if it will not fit the outlet, have a proper outlet installed by a qualified electrician.
- ▶ Please follow the advice on installation in these operating instructions and the installation plan.
- ▶ Ensure that the connection data on the data plate (voltage, frequency, and fuse rating) match those of your electrical supply.

## IMPORTANT SAFETY INSTRUCTIONS

▶ The dishwasher may only be operated if the door-opening mechanism is working correctly. Otherwise there could be a risk of danger while the automatic door-opening mechanism (depending on the model) is active.

The maximum weight of the front panel that can be aligned with the factory-installed door springs is 22-26.5 lb (10–12 kg) (depending on model).

To check that the door-opening mechanism is working correctly:

- The door springs must be evenly adjusted on both sides. They are correctly adjusted when the door remains stationary when left half open (approx. 45° opening angle). It is also important that the door cannot fall open.
- The door locking pins automatically retract when the door opens at the end of the drying phase.

▶ The control elements of the dishwasher must not be tampered with.

▶ **WARNING - Fire hazard!** Do not cover or crush the plug of the appliance. Ensure that the cabinet opening for the dishwasher provides ample space for the plug and cord. Installing the dishwasher in a tight space may crimp the power cord or put pressure on it. See “Electrical connection”.

▶ Do not use an extension cord to connect this machine to electricity. Extension cords do not guarantee the required safety of the machine (e.g., danger of overheating).

▶ Do not open the casing of the dishwasher. Any contact with live connections or tampering with the electrical or mechanical components of the dishwasher will endanger your safety and may lead to machine malfunctions.

▶ The dishwasher must not be used if the wire is damaged. A damaged wire may only be replaced by a suitable wire of the same type. For safety reasons, such replacement should only be carried out by Miele Technical Service or a qualified service technician.

▶ Before servicing the appliance, disconnect it from the power supply.

▶ The plastic housing of the water connection contains electrical components. It must not be dipped in water.

▶ There are live wires in the water intake hose. Do not shorten the water intake hose, even if it is too long.

## IMPORTANT SAFETY INSTRUCTIONS

---

► The built-in Waterproof system offers reliable protection against water damage if the following conditions are met:

- Installation has been carried out correctly.
- The dishwasher is properly maintained and parts are replaced in case of noticeable damage.
- The shut-off valves have been turned off during longer absences (for example, vacation).

The Waterproof system will work even when the dishwasher is switched off. However, the dishwasher must remain connected to the electricity supply.

# IMPORTANT SAFETY INSTRUCTIONS

---

## Correct use

- ▶ This dishwasher is designed for operation with water and cleaning agents suitable for use in dishwashers only. Organic solvents and flammable liquid agents must not be used. This could cause an explosion, damage rubber or plastic components in the dishwasher, and cause liquids to leak out of it.
- ▶ You could injure yourself on the open dishwasher door or trip over it. Avoid leaving the door open unnecessarily.
- ▶ Do not sit, stand, or lean on the opened door or dish rack. This could tip or damage the dishwasher.
- ▶ After any plumbing work, the water pipework to the dishwasher will need to be vented. If this is not done, components can be damaged.
- ▶ Please be aware that the dishwasher may be operating at high temperatures. When the door is opened there is a risk of burning or scalding. Wash items, baskets, and inserts must be allowed to cool down before they are unloaded. Any water remaining in containers could still be very hot. Empty them into the wash cabinet before taking them out.
- ▶ The water in the wash cabinet is NOT safe to drink!
- ▶ The pretreatment of items (for example with dishwashing liquid and other detergents), but also some types of soiling and some detergents, can cause a build-up of foam in the wash cabinet. Foam can have an adverse effect on the cleaning result.
- ▶ Depending on the properties of the flooring and footwear worn on it, liquids can cause a slipping hazard. Keep the floor dry where possible and take care to clean up any liquid spills straight away. Take the necessary precautions when cleaning up hazardous substances and hot liquids.
- ▶ Foam escaping from the wash chamber can cause damage to the dishwasher. If foam escapes, the program must be canceled immediately and the dishwasher must be disconnected from the mains electrical supply.
- ▶ When using cleaning agents and specialized products, it is essential that the manufacturer's instructions are followed. Cleaning agents must only be used for the purpose they are designed for by the manufacturer to avoid any material damage or the occurrence of strong chemical reactions (e.g., oxyhydrogen explosion).

## IMPORTANT SAFETY INSTRUCTIONS

---

- ▶ Under certain conditions, hydrogen gas might be produced in a hot-water system that has not been used for two weeks or more. **HYDROGEN GAS IS EXPLOSIVE.** If the hot-water system has not been used for such a period, before using the dishwasher turn on all hot-water faucets and let the water flow from each for several minutes. This will release any accumulated hydrogen gas. As the gas is flammable, do not smoke or use an open flame during this time.
- ▶ Miele cannot be held liable for any effect chemical detergents may have on the material of the items being cleaned. Observe the detergent manufacturer's instructions with regard to storage conditions, use, and dosage.
- ▶ Do not inhale or ingest powder detergent. Dishwasher detergents contain irritant or corrosive ingredients which can cause burning in the nose, mouth and throat if swallowed, or inhibit breathing. Seek medical attention immediately if detergent has been swallowed or inhaled.
- ▶ Powder and liquid detergents containing active chlorine must not be used. You may damage plastic parts and the seals of the dishwasher.
- ▶ To avoid material damage and corrosion, do not allow any acids or solutions containing chloride to get into the wash cabinet or onto the casing. Similarly avoid any ferrous materials with a corrosive effect.
- ▶ Do not wash items soiled with ash, sand, wax, lubricating grease, or paint in the dishwasher. These materials will cause damage to the dishwasher.
- ▶ Do not clean the dishwasher or its near vicinity with a hose or a pressure washer.
- ▶ Be careful when sorting items with sharp pointed ends and positioning them in the dishwasher so that you do not hurt yourself or create a danger for others. Cutlery should be placed in baskets in such a way that no injuries can occur.
- ▶ Arrange sharp and pointy utensils so that they cannot damage the door seal.
- ▶ Remove any coarse food deposits from the items being cleaned before loading them in the dishwasher.

# IMPORTANT SAFETY INSTRUCTIONS

## Children in the vicinity

- ▶ Children should be supervised in the vicinity of the dishwasher. Never allow children to play with the dishwasher. There is a danger that children might shut themselves in the dishwasher.
- ▶ Children must be kept away from the dishwasher unless they are constantly supervised.
- ▶ Children aged eight and older may only use the dishwasher without supervision if they have been shown how to use it in a safe manner. Children must be able to recognize and understand the potential risks of improper use.
- ▶ If the automatic door opening mechanism is active, keep young children away from the area in which the door opens. There is a danger of injury in the unlikely event of a fault with the opening mechanism.
- ▶ Keep children away from process chemicals. These contain ingredients which can cause burning in the mouth or throat, or inhibit breathing. Keep children away from the dishwasher when the door is open. There could still be residual process chemicals in the dishwasher. Seek medical advice immediately if a child has swallowed or inhaled any process chemicals.

## Accessories

- ▶ Accessories may only be fitted if approved by Miele. If other parts are used, any warranty and product liability claims shall be void.

## Transport

- ▶ Only transport the dishwasher in an upright position so that no water flows into the electrical controls, as this would cause faults.
- ▶ If you wish to transport the dishwasher, empty it and securely fasten all loose parts such as baskets, hoses, and cords.

## After use

- ▶ Remove the door to the washing compartment when removing an old dishwasher from service or discarding it.

Miele cannot be held liable for damage caused by failure to comply with these  
IMPORTANT SAFETY INSTRUCTIONS.

# IMPORTANT SAFETY INSTRUCTIONS

---

SAVE THESE INSTRUCTIONS



## Appliance overview

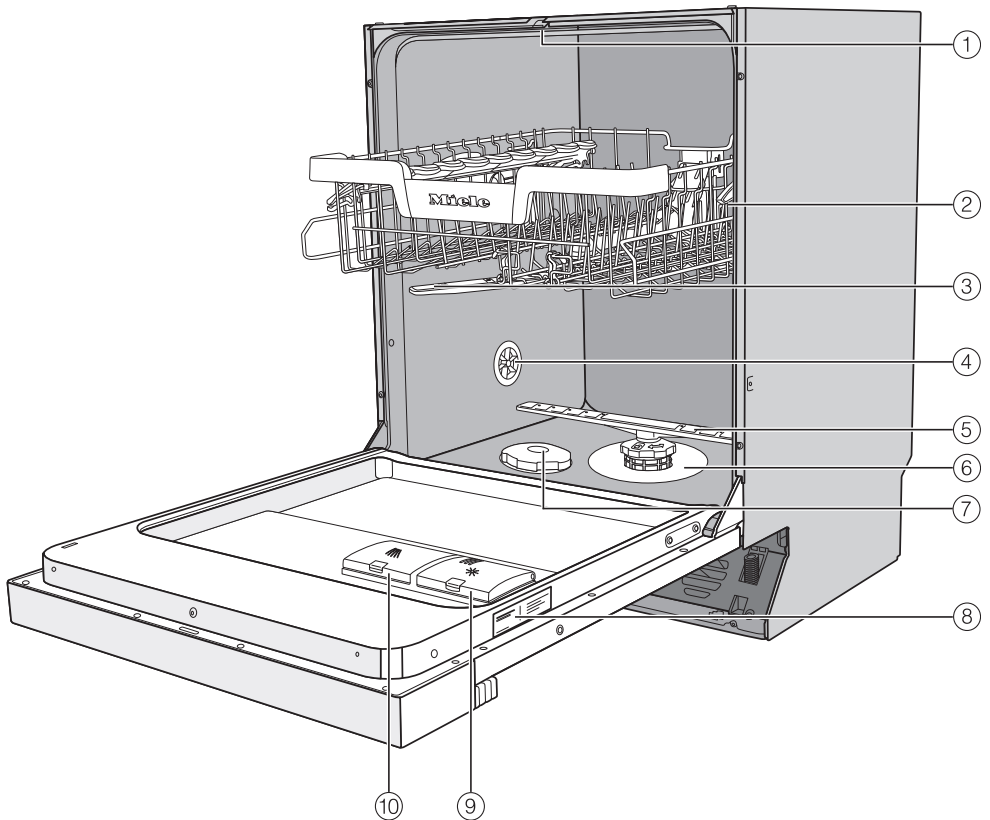

- ① Top spray arm
- ② Upper basket (depending on model)
- ③ Middle spray arm
- ④ Aeration valve
- ⑤ Bottom spray arm
- ⑥ Filter combination
- ⑦ Salt reservoir
- ⑧ Data plate
- ⑨ Rinse aid reservoir
- ⑩ Detergent compartment

# Machine description

## Control field

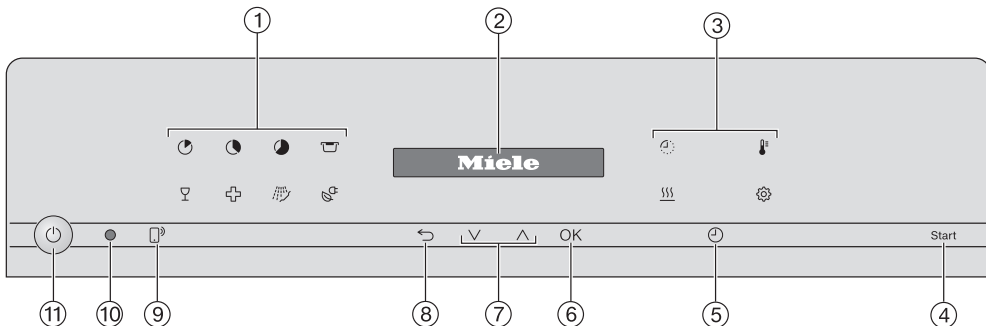

### ① Program selection

- = Short
- = Universal
- = Intensive
- = Plastics
- = Glasses
- = SaniWash
- = Cold pre-rinse
- = Economy

### ② Display

For further information, see “Display functions” under “Guide to the appliance”.

### ③ Options

- = Time left
- = Temperature
- = Additional drying
- = Settings

### ④ Start sensor button

For starting the selected program.

### ⑤ Timer sensor button

For selecting a later program start.

### ⑥ OK sensor button

To select menu options and values displayed.  
To confirm messages.

### ⑦ Sensor buttons $\nabla/\Delta$

For program selection.  
For changing the values displayed.  
For scrolling to other menu pages.

### ⑧ Back sensor button

For navigating back to the previous menu or deleting previously set values.

### ⑨ Remote start sensor button

For activating/deactivating the Remote start option.

### ⑩ Optical interface

For Customer Service.

### ⑪ On/Off sensor button

For turning the dishwasher on and off.

## Display functions

The display is used to select or set the following:



- the program
- the timer
- the Settings 

The display can show the following:

- the program stage
- the estimated time left for the program to run
- the current temperature of the program stage
- the water consumption
- any relevant fault messages and information

To save energy, the dishwasher turns off after a few minutes if you do not press any sensor buttons during this time.

Touch the  sensor button to turn the dishwasher back on.

The *OK* sensor button is used to confirm a message or setting and also to move to the next menu or another level. Under  *Settings*, a scroll bar  will appear in the right of the display. This offers additional options. These options can be shown using the  $\vee/\wedge$  sensor buttons.

You can alter the dishwasher's controls to suit changing requirements in the *Settings* menu (see "Settings").

The option which is selected will have a check  next to it.

To exit a submenu again, use the  *Back* sensor button.

If you do not press any sensor buttons for several seconds, the display will revert to the previous menu. You will then have to enter your settings again.

# Caring for the environment

---

## Disposal of the packing material

The cardboard box and packing materials protect the appliance during shipping. They have been designed to be biodegradable and recyclable.

Ensure that any plastic wrappings, bags, etc. are disposed of safely and kept out of the reach of children. Danger of suffocation!

## Disposal of your old appliance

Electrical and electronic appliances contain valuable materials. They also contain certain substances, compounds and components which were essential for the proper functioning and safe use of the equipment. Handling these materials improperly by disposing of them in your household waste can be harmful to your health and the environment. Therefore, please do not dispose of your old appliance with regular household waste and follow local regulations on proper disposal.



Consult with local authorities, dealers or Miele in order to dispose of and recycle electrical and electronic appliances. Miele assumes no responsibility for deleting any personal data left on the appliance being disposed. Please ensure that your old appliance is kept away from children until removal. Observe safety requirements for appliances that may tip over or pose an entrapment hazard.

## Miele@home

Your dishwasher is equipped with an integrated Wi-Fi module.

To use this feature, you will need:

- a Wi-Fi network
- a network solution from Miele, e.g., Miele app
- a Miele user account  
You can create a user account using the network solutions from Miele, e.g., via the Miele app.

The relevant network solution will guide you as you connect your dishwasher to your home Wi-Fi network.

Once your dishwasher is connected to your WiFi network, you can use the network solution to carry out the following tasks:

- Call up information on the operating status of your dishwasher
- Call up information on the program sequence of your dishwasher

Connecting your dishwasher to your Wi-Fi network will increase energy consumption, even when the dishwasher is turned off.

Make sure that your Wi-Fi network signal strength is strong enough at the installation site of your dishwasher.

## Availability of the WiFi connection

The Wi-Fi connection shares a frequency range with other appliances (including microwave ovens and remote control toys). This can cause sporadic or even complete connection failures. Therefore, the availability of featured functions cannot be guaranteed.

## Miele@home availability

The ability to use the Miele app, or other network solutions, depends on the availability of the Miele@home service in your country.

The Miele@home service is not available in every country.

For information about availability, please visit [www.miele.com](http://www.miele.com).

## Miele app

You can connect the dishwasher to the Miele app.

The app is available to download free of charge from the Apple App Store® or from the Google Play Store™.

## Miele app



Every dishwasher is tested at the factory. There will be residual water in the machine from this test. It is not an indication that the dishwasher has been used previously.

## Opening the door

In some programs, the door automatically opens slightly to assist the drying process.

## Initial commissioning

This function can be deactivated, if preferred (see “AutoOpen” under “Settings”).

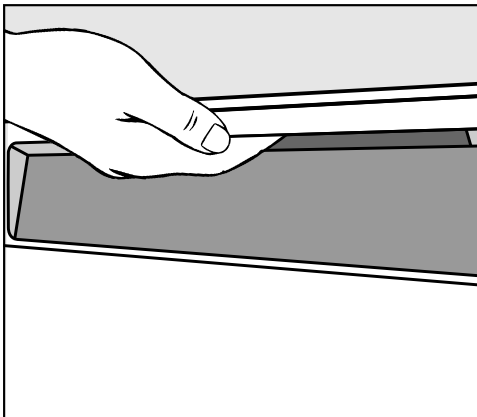

- To open the door, reach under the recessed grip and pull the handle.
- Open the door fully to disengage the locking mechanism.

At the end of the program, if the AutoOpen function is on, the door locking pins automatically retract.

To prevent a technical fault, do not hold the door locking pins firmly when they are retracting.

If the door is opened during operation, all functions are automatically interrupted.

**⚠** Risk of scalding due to hot water. During operation, water in the dishwasher may be very hot. During operation, only open the door with extreme caution.

**⚠** Risk of injury due to door opening automatically. The door may open automatically at the end of a program. Keep the area around the door free of obstructions.

## Closing the door

- Insert the baskets.
- Raise the door upwards until the catch engages.

 Risk of crushing due to the door closing.

When closing the door, you are at risk of shutting your fingers in it.

Do not put your hand inside the door as it is closing.

## Activating the safety lock

Use the safety lock to prevent children opening the dishwasher door. The door can then only be opened by using a lot of force.

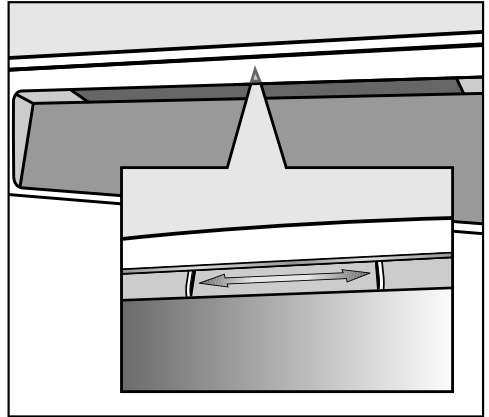

- To lock the door, push the slide underneath the recessed grip to the right.
- To unlock the door, push the slide to the left.

# Initial commissioning

---

## Basic settings

### Turning on the dishwasher

- Turn the dishwasher on using the  sensor button.

The welcome screen will appear when the dishwasher is turned on and the welcome melody will sound.

For more information about the display functionality, see “Display functions” under “Machine description”.

### Setting the language

The display will change automatically to the screen for setting the language.

- Select the language you want as well as the country, if appropriate, using the  sensor button and confirm with *OK*.

For further information on setting the language, see “Language” under “Settings”.

A check  will appear next to the language that has been set.

### Setting up Miele@home

The message Miele@home will appear on the display.

- To set up Miele@home now, confirm by touching *OK*.

**Tip:** To postpone setup until later, select the *Skip* option and confirm with *OK*.

There are 2 ways of connecting your dishwasher to your WiFi network:

- Select the connection method you want and confirm your choice with *OK*.

1. Connect using App
2. Connect using WPS  
(WPS = WiFi Protected Setup)

You will then be guided by the display and the Miele network solution.

For further information on Miele@home, see “Miele@home” under “Settings”.



## Setting the time

The time is updated automatically if a connection is established with the WiFi network.

The display will then change to the screen for setting the time.

The current time of day must be set before you can use the timer option.

- Use the  $\vee/\wedge$  sensor buttons to enter the hour and confirm your entry with *OK*.
- Then set the minutes and confirm with *OK*.

Keeping the relevant  $\vee$  or  $\wedge$  sensor button pressed will increase or decrease the time automatically.

## Setting water hardness

The display changes to the screen for setting the water hardness.

- The dishwasher must be programmed to the correct water hardness for your area.
- Your local water authority will be able to advise you of the water hardness level in your area.
- Where the water hardness fluctuates, e.g., between 10 and 16 gr/gal (10–15°dH – German scale), always program the dishwasher to the higher value (16 gr/gal or 15°dH in this example).

It is useful to know your water hardness so that you can provide the service technician with this information in the event of any service calls.

Enter the water hardness below:

\_\_\_\_\_ gpg (°dH)

The dishwasher is programmed at the factory for a water hardness level of 15 gpg (14°dH).



- Set the water hardness level in your area and confirm with *OK*.

See “Water hardness” under “Settings” for more information.

## Initial commissioning

---

Prompts will then appear in the display.

After confirming these prompts with *OK*, the messages  Refill salt and  Add rinse aid may appear.

- Add salt and rinse aid if necessary (see “Reactivation salt” and “Rinse aid” under “Before using for the first time”).
- Select *OK* to confirm the messages.

The program selected will appear briefly in the display and the appropriate sensor button will be illuminated.

Next, the estimated energy and water consumption may be shown for the selected program for several seconds.

The display will then show the estimated program duration for the program selected.

### Reactivation salt

In order to achieve good cleaning results, the dishwasher needs to operate with soft water. Hard water results in the build-up of calcium deposits on dishes and on the inner surfaces of the machine.

Tap water with a water hardness level higher than 5.2 gr/gal (5°dH – German scale) must be softened. This occurs automatically in the integrated water softener. The water softener is suitable for a water hardness level of up to 38°F (36°dH).

In order to maintain the functions of the water softener, it must be reactivated regularly. Reactivation occurs automatically every ninth program sequence. At the start of the next program, an additional 4.4 l of water is required for this process. Energy consumption increases by 0.015 kWh and the program is extended by 3 minutes.

The above only applies to the Economy program at a water hardness of 14°dH. For other programs and water hardness levels, the frequency of reactivation will differ.

In order to be reactivated, the water softener requires reactivation salt. Depending on the water hardness level (< 22 gr/gal, or < 21°dH – German scale), reactivation salt is not required if combination detergents are being used (see “Active ingredients” under “Detergents”).

Before filling the salt reservoir for the first time, you must fill it with approx. 2 l of water to enable the salt to dissolve.

Once the dishwasher has been used once, there is always sufficient water in the salt reservoir.

- Remove the lower basket from the wash cabinet and unscrew the salt reservoir cap.
- Fill the salt reservoir with approx. 2 l of water (first use only).

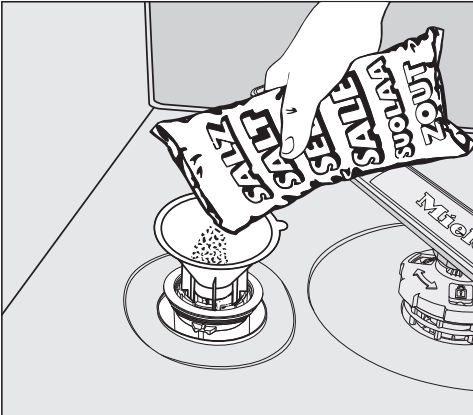

- Place the funnel provided over the salt reservoir and carefully fill with reactivation salt until the reservoir is full. The salt reservoir holds up to 2 kg of salt, depending on the type of salt used.
- Clean off salt residues from around the salt reservoir opening. Next, screw the salt reservoir cap on again firmly.

## Refilling the salt

- When the refill reminder  Refill salt appears in the display, wait until the end of the program and then refill the salt reservoir.
- Confirm with *OK*.

The salt refill indicator will go out.

 Risk of corrosion due to saline solution.

Saline solution that runs out can cause corrosion in the wash cabinet and to the wash items.

Each time you remove the salt reservoir cap, you must run the  *Cold pre-rinse* program without any wash items in the dishwasher. This will dissolve and remove any traces of salt from the wash cabinet.

After the salt reservoir has been filled, the refill indicator may still appear in the display if the salt concentration has not yet reached the correct level. In this case, still confirm the message with *OK*.

# Initial commissioning

## Rinse aid

Rinse aid is necessary to ensure that water does not cling and leave marks on dishes during the drying phase, and helps dishware dry faster after it has been washed.

Rinse aid is poured into the container and the amount set is dispensed automatically.

 Liquid dish soap or detergent can cause damage.

Liquid dish soap and detergent can damage the rinse-aid reservoir.

Commercial rinse aids are recommended.

Alternatively, you could use liquid citric acid at a concentration of up to 10%. The resulting rinsing and drying quality will not, however, be as good as when rinse aid is used.

 Risk of acid damage.

The dishwasher can be damaged by high concentrations of acid.

Under no circumstances should you use citric acid with a higher acid content.

If you only ever wish to use combination detergent products in your dishwasher, you do not need to add rinse aid.

However, for optimum rinsing and drying results, use dishwasher detergent and add reactivation salt and rinse aid separately.

If you only ever use combination detergent products containing salt and rinse aid in your dishwasher, you can turn off both refill reminders if you wish (see “Refill reminders” under “Settings”).

Please make sure that if you stop using combination detergents, you refill the reactivation salt and rinse aid. Turn the refill reminders back on if required.

# Initial commissioning

## Adding rinse aid

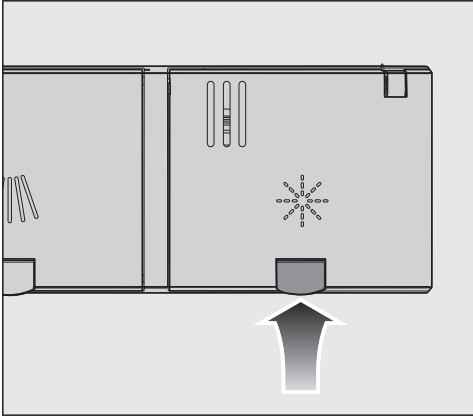

- Press the yellow button ☀ on the lid of the rinse aid reservoir.

The lid will spring open.

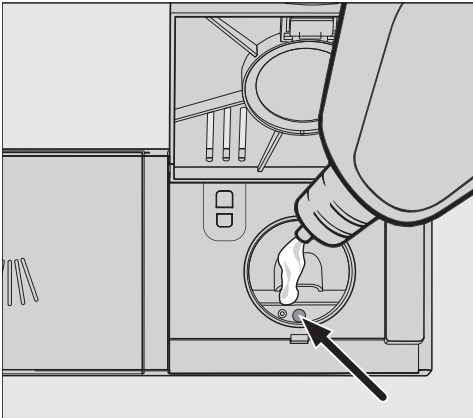

- Fill with rinse aid until the filling level indicator (arrow) changes to a dark color while the door is horizontally open.

The rinse aid reservoir holds approximately 110 ml.

- Close the lid firmly until you hear it click into place. Otherwise, water can enter the rinse aid reservoir during a program.

- Wipe up any spilled rinse aid. This prevents excess foam developing during the next program.

You can adjust the rinse aid dosage for best wash results (see “Rinse aid” under “Settings”).

## Filling the rinse-aid reservoir

When ☀ Add rinse aid appears in the display, the reservoir contains sufficient rinse aid for 2–3 programs only.

- Add rinse aid in plenty of time.
- Confirm with *OK*.

The rinse-aid refill reminder will go out.

# Caring for the environment

---

## Energy-saving dishwashing

This dishwasher is exceptionally economical in its use of water and electricity.

You can make the most of your machine by following these tips:

- Washing in a dishwasher generally uses less water and energy than washing by hand.
  - There is no need to pre-rinse items under running water, and this unnecessarily increases water and energy consumption.
  - Make full use of the basket capacity without overloading the dishwasher. This results in the most economical dishwashing in terms of energy and water consumption.
  - Choose a program that best suits the degree of soiling and the type of dishes being washed (see “Program overview”).
- Select the  *Economy* program for energy-saving dishwashing. This program is the most efficient in terms of its combined energy and water consumption for cleaning dishware with a normal level of soiling.
  - Follow the detergent manufacturer’s recommendations on detergent dosage.
  - If you are manually dosing the detergent, reduce the amount by  $\frac{1}{3}$  when using powder detergent if the baskets are only half full.

## EcoFeedback consumption display

The “Consumption” function is used for calling up information about the water consumption of your dishwasher (see “Consumption” under “Settings”).

The following information can be shown on the display:

- an estimate of the consumption before the program sequence
- the actual consumption at the end of the program
- the total consumption of the dishwasher

### 1. Estimated consumption

After a program has been selected, first the name of the program and then the estimated water consumption  $\delta$  will appear in the display for a few seconds.

The estimated consumption will be shown as a bar chart. The more bars that are visible (■■■), the higher the water consumption.

The values are influenced by the program, any program options selected, the ambient conditions, and the size of the load.

The display will change automatically from showing the estimated consumption to showing the time remaining.

The estimated consumption function is activated as standard. This function can be deactivated, however, if preferred (see “Consumption” under “Settings”).

### 2. Displaying consumption

At the end of the program, you can call up the actual water consumption for the program that has just been run.

- Confirm the message Consumption (OK) with *OK*.

Turning the dishwasher off at the end of the program will delete the actual consumption values for the program that has just been run.

### 3. Total consumption

You can view the total consumption of water for all previously used programs of your dishwasher (see “Consumption” under “Settings”).

# Loading the dishwasher

---

## General information

Remove coarse food residues from dishes.

There is no need to pre-rinse items under running water.

 Damage can be caused by ash, sand, wax, lubricating grease, or paint.

These substances will contaminate the dishwasher and can then no longer be removed.

Do not wash items soiled with these substances in the dishwasher.

Dishes can be loaded anywhere in the baskets, but the following notes should be observed:

- Do not place dishes and utensils inside other items where they will cover one another.
- Load the dishes so that water can access all surfaces. This ensures that they get properly cleaned.
- Make sure that all items are securely positioned.
- Hollow items such as cups, glasses, pans, etc., must be inverted in the baskets.
- Tall, narrow, hollow items such as champagne glasses should be placed in the center of the basket rather than in the corners. This ensures the hollow items are more easily accessed by the water jets.
- Concave items such as mugs or bowls should be placed at an angle so that the water can run off.

- The spray arms must not be blocked by items which are too tall or hang through the baskets. Test for free movement by manually rotating the spray arms.
- Make sure that small items cannot fall through the holders in the baskets. Small items such as lids should therefore be placed in cutlery basket.

Some foods such as carrots, tomatoes, or ketchup may contain natural dyes. These dyes can discolor plastic items in the dishwasher if large quantities of these foods are in contact with the dishes inside the machine. The stability of plastic items is not affected by this discoloration.  
Washing silverware can also cause plastic items to discolor.



## Wash items not suitable for dishwashers:

- Wooden cutlery and dishes or items with wooden parts. These may discolor and fade. The glue used in these items is not dishwasher-safe and wooden handles may come loose after being washed in a dishwasher.
- Craft items, antiques, valuable vases, and decorative glassware. Such items are not dishwasher-safe.
- Plastic items that are not heat resistant. The high temperatures in the dishwasher may cause them to melt or lose shape. Use only dishwasher-safe plastic containers.
- Copper, brass, tin, and aluminum items. These may discolor or become dull.
- Colors painted over a glaze. These may fade after a number of washes.
- Delicate glassware and glassware containing lead crystal. Clouding may occur over time.

## Silver

Silverware that has been in contact with foods containing sulfur can discolor. These include egg yolk, onions, mayonnaise, mustard, pulses, fish, fish brine, and marinades.

**Silverware** previously cleaned with a **silver polish** may still be damp or spotted at the end of a program, where water has not run off smoothly.

**Tip:** Rub the silver dry with a cloth.

 Damage due to caustic alkaline detergents.

Aluminum parts (e.g., the grease filters of ventilation hoods) can be damaged by caustic alkaline detergents. In extreme cases, there is a risk of an explosive chemical reaction (such as an explosive oxyhydrogen gas reaction).

Aluminum components must not be cleaned in the dishwasher with caustic alkaline commercial or industrial detergents.

**Tip:** When purchasing new dishware and cutlery, make sure they are dishwasher-safe if you want to wash them in the dishwasher.

## Glass care

- Clouding may occur on glasses after frequent washing in the dishwasher. When washing delicate glassware in the dishwasher, ensure that only a special glass-care program with very low temperatures is selected (see “Program overview”). This will reduce the risk of clouding.
- Purchase glassware that is dishwasher-safe (e.g., Riedel glassware).
- Use detergents with glass protective additives.

# Loading the dishwasher

## Upper basket

See “Loading examples” under “Loading the dishwasher” for examples of how to load dishware and utensils.

### Loading the upper basket

 Risk of damage due to water leakage.

If you run the dishwasher without the upper basket, water can leak out of the dishwasher.

Only run the dishwasher with the upper basket in place.

- Use the upper basket for small, light-weight, and delicate items such as cups, saucers, glasses, dessert bowls, etc.  
Shallow pans or casserole dishes can also be placed in the upper basket.
- Long items such as soup ladles and mixing spoons should be placed lying down across the front of the upper basket.

## Loading the FlexCare cup rack

You can put cups, small bowls, and flat dishes on the FlexCare cup rack. Glasses can be arranged along the cup rack so they sit securely during the program.

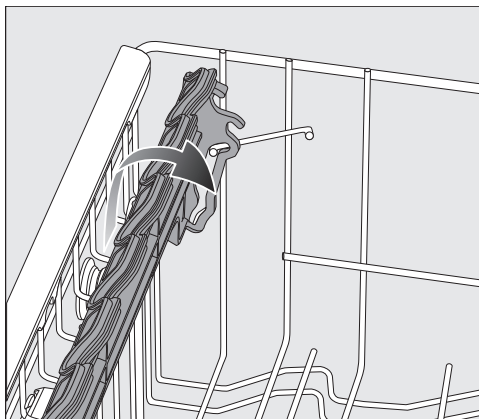

- Lower the cup rack to do so.
- Raise the cup rack upwards to make room for tall items.

## Loading the dishwasher

### Adjusting the FlexCare cup rack

You can set the height and depth of the cup rack at 2 different levels so that it can accommodate larger cups and so that taller items can be placed underneath it.

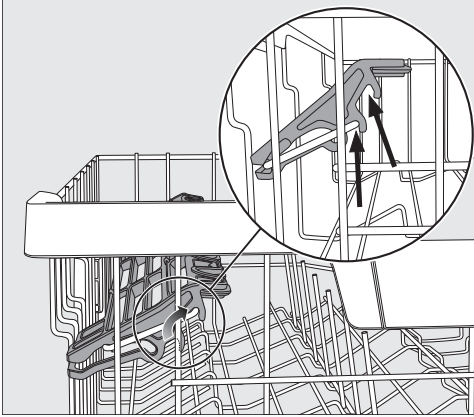

- Pull the cup rack upwards and click it into the desired position (see arrow).

### Loading the silicone elements of the FlexCare cup rack

The silicone elements in the cup rack are specially designed to hold tall glasses with long stems securely.

- Lower the cup rack and lean the glasses against the openings.

# Loading the dishwasher

---

## Lowering the spikes

On both right-hand rows of spikes, you can lower every other spike to make it easier to arrange larger dishes, like cereal bowls.

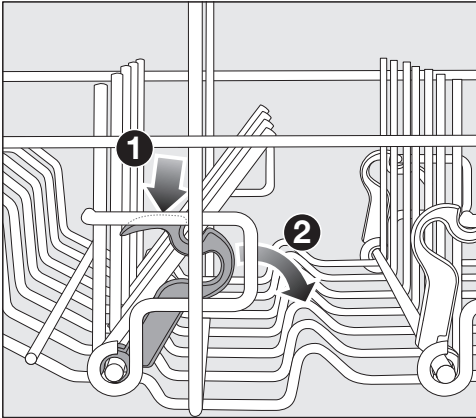

- Press the yellow lever downwards ①, and then lower the dark gray spikes ②.
- Place the bowls vertically in the row of spikes.

## Adjusting the upper basket

In order to gain more space for taller items, the upper basket can be adjusted on 3 levels with  $\frac{3}{4}$  inches (2 cm) between each level.

The upper basket can also be set at an angle so that water can run off freely from recesses. Make sure, however, that the basket can slide smoothly in and out of the wash cabinet.

- Pull out the upper basket.

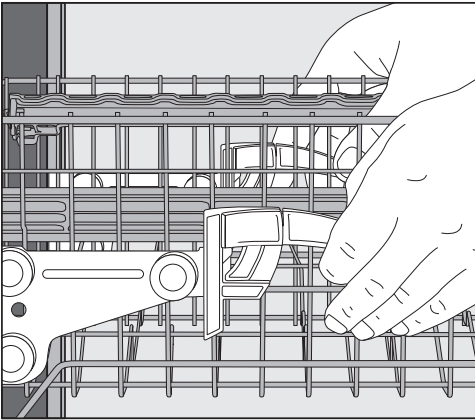

## To raise the upper basket:

- Lift the basket until it clicks into place.

## To lower the upper basket:

- Pull upwards on the levers at either side of the upper basket.
- Adjust the basket to the desired height and then push the levers securely back down into position.

When adjusting the upper basket, make sure it does not block the middle spray arm.

# Loading the dishwasher

## Lower basket

See “Loading examples” under “Loading the dishwasher” for examples of how to load dishware and utensils.

### Loading the lower basket

- Place larger and heavier items such as plates, serving platters, saucepans, bowls, etc., in the lower basket. Glasses, cups, and small plates and saucers can also be placed in the lower basket.

### Loading the MultiComfort area

The rear section of the lower basket is used for washing cups, glasses, plates, and pots.

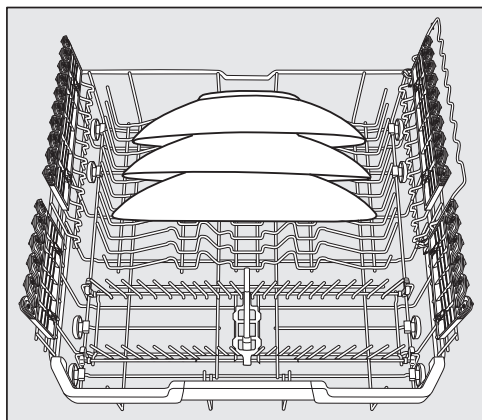

- Place very large plates in the center of the lower basket.

**Tip:** When tilted, plates up to 13 3/4" (35 cm) in diameter can be accommodated.

## Lowering the spikes

The spikes at the front are used for washing plates, soup bowls, platters, dessert bowls, and saucers.

The spikes can be lowered to make more room for large items, e.g., pots, pans, and dishes.

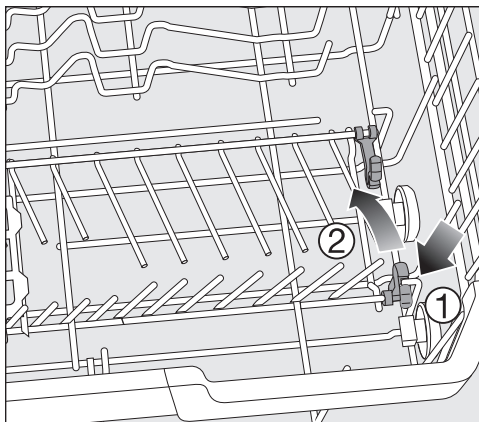

- Press the yellow lever downwards ①, and then lower the spikes ②.

## Loading the dishwasher

### Loading the FlexCare glass holder with MultiClips

The silicone elements in the glass holder provide a stable and secure hold for delicate stemware.

- Stemware such as wine glasses, champagne flutes, and beer glasses can be leaned against the glass holder or suspended from it.
- The glass holder can be raised to make more room for tall items.

You can set the glass holder at 2 different heights.

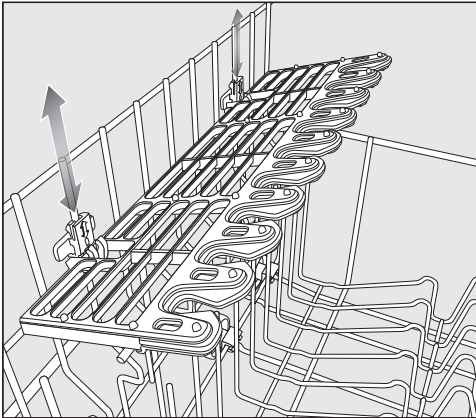

- Slide the glass holder to the desired height until the catches click into place at the top or the bottom.

The MultiClips enable you to fasten wash light items such as those made from plastic onto the glass holder.

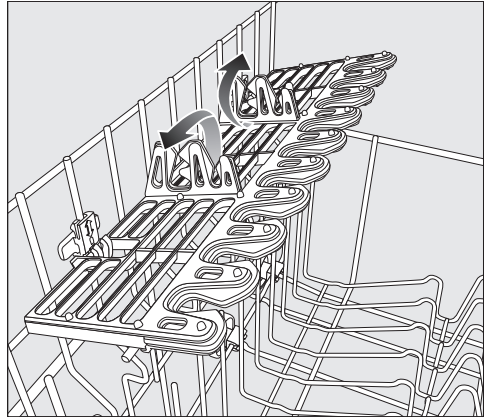

- Fold up the MultiClips.

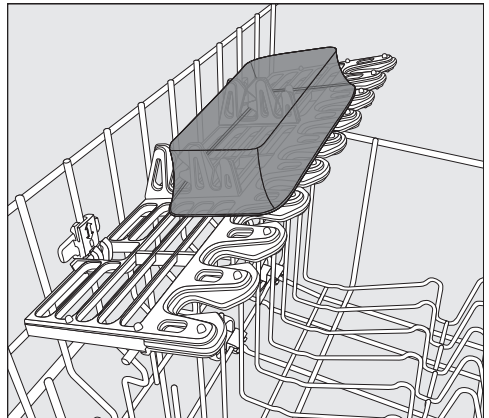

- Secure light items to the MultiClips.

# Loading the dishwasher

## Loading the glassware rail

This rail is designed to hold tall glasses and glasses with stems securely.

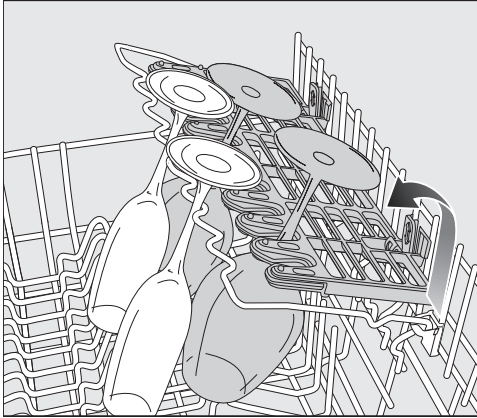

- Lower the rail and lean tall glasses against it.

## Lowering the bottle holder

The bottle holder can be used to keep narrow items such as milk and baby bottles secure during a program.

- Raise the bottle holder upwards and push it down until it clicks into place.

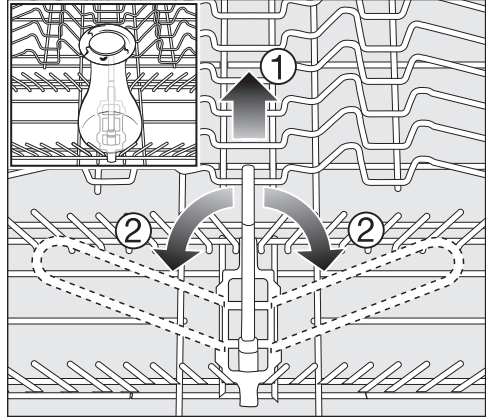

- If the bottle holder is not needed, lift it up using the yellow lever ① and fold it to the side ②.



## Cutlery

### Cutlery basket (depending on model)

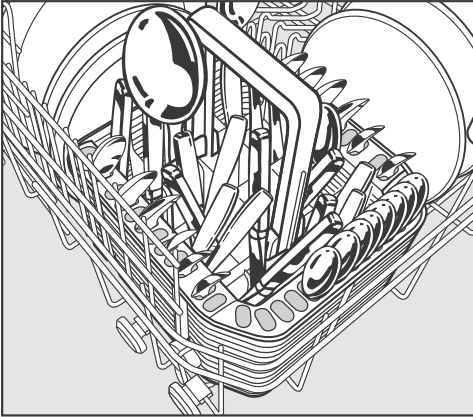

The cutlery basket can be placed anywhere on the front rows of spikes in the lower basket.

- To avoid the risk of injury, knives and forks should be placed with the handles upwards in the basket. However, cutlery placed handle down in the basket will come out cleaner and drier.
- Place small items of cutlery in the individual slots on three sides of the cutlery basket.

### Cutlery insert for the cutlery basket

Use the insert supplied for heavily soiled items of cutlery. The insert separates the items so that they can be more easily accessed by water.

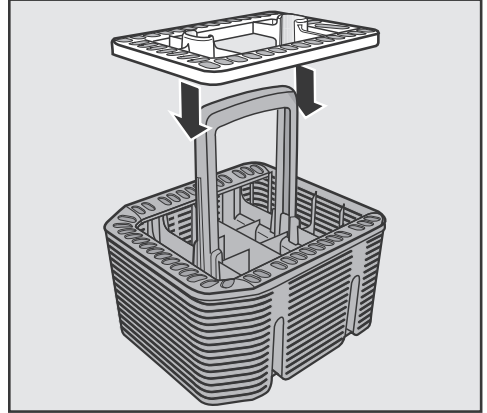

- Fit it onto the cutlery basket if required.

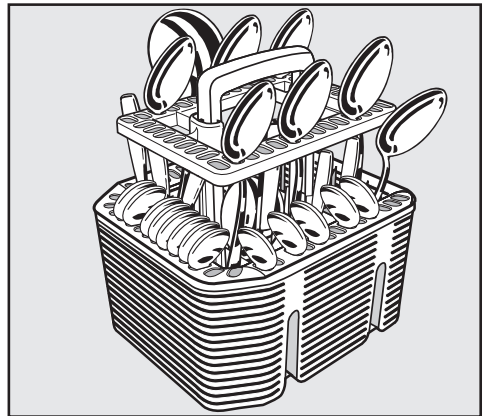

- Insert cutlery with the handles facing downwards.
- Distribute them evenly along the insert.

# Loading the dishwasher

---

## Loading examples

### Loading for 10 standard place settings with cutlery basket

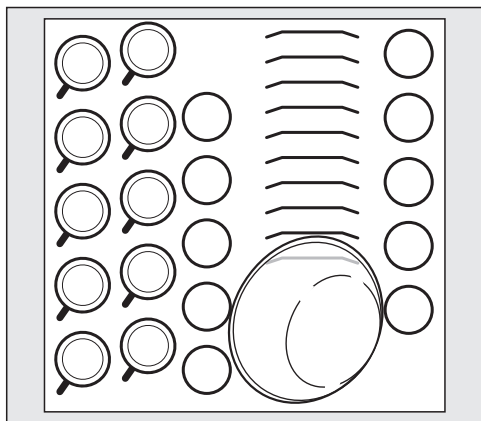

Upper basket

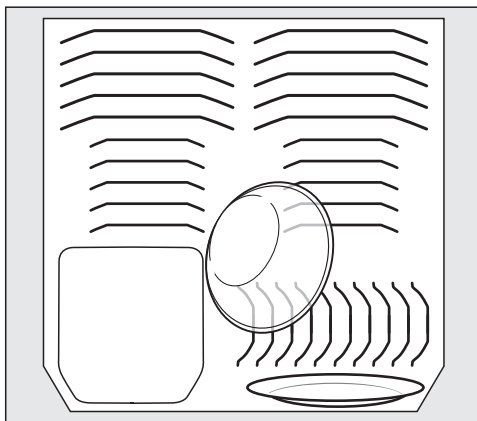

Lower basket

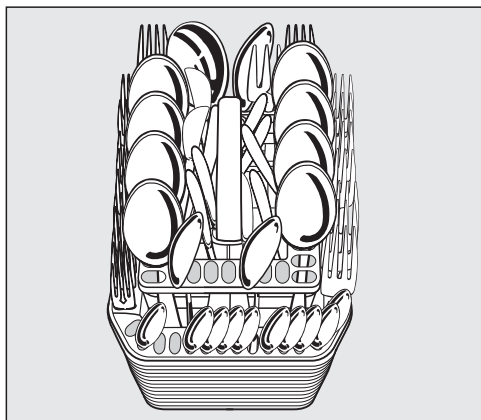

Cutlery basket

# Loading the dishwasher

## Loading for 13 standard place settings with cutlery basket

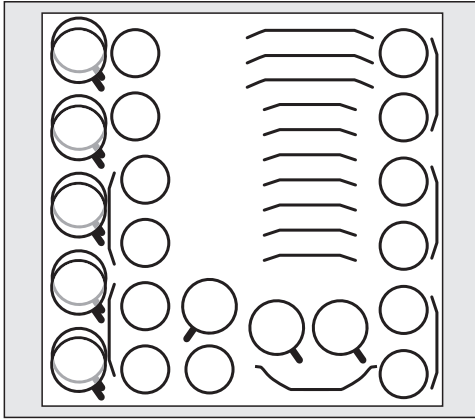

Upper basket

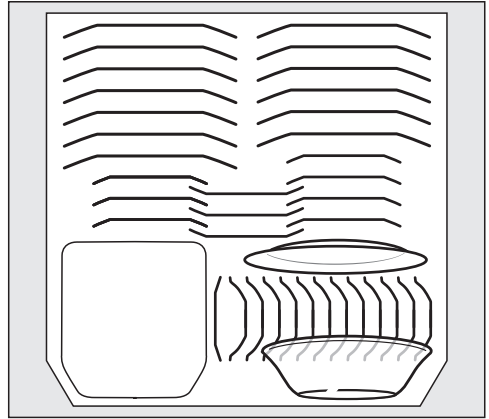

Lower basket

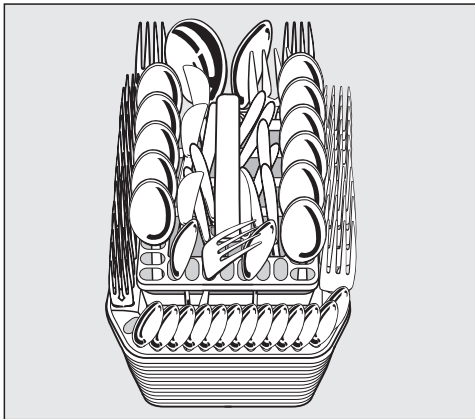

Cutlery basket

## Detergents

---

 Risk of chemical burns from detergent.

Dishwasher detergents can cause burning on the skin and in the eyes, nose, mouth, and throat.

Avoid contact with detergents.

Do not inhale or ingest powder detergents. Do not swallow dishwasher detergents. Seek medical attention immediately if detergent has been swallowed or inhaled.

Keep children away from detergents. Detergent residues could still be present in the machine. Keep children away from the dishwasher when the door is open. Do not fill the detergent dispenser until just before starting the program and activate the door safety lock (depending on model).

 Risk of damage due to detergents containing active chlorine.

Detergents containing active chlorine must not be used. You may damage plastic parts and the seals of the dishwasher.

Do not use detergents containing active chlorine.

You can easily order powder detergents and other consumables for your dishwasher for domestic use via the Miele app or the Miele website:  
<https://www.mieleusa.com/>.



## Powder detergents and detergent tabs

Use powder detergent or detergent tabs only in the door dispenser compartment.

Only use detergent tabs that are quick-dissolving. Suitable detergent tabs are available from the Miele range. When using combination detergents (tabs that offer rinse aid and water softening effects as well as cleaning), it is recommended that you also add rinse aid and reactivation salt (at a lower concentration) owing to the short program cycle times and potentially the water quality.

- Add powder detergent or detergent tabs to the detergent compartment.

## Dispensing detergent

The detergent compartment holds a maximum of 50 ml.

There are marks in the detergent compartment to aid with dispensing: 20, 30, max. When the door is opened to a horizontal position, they show the approximate fill level in ml and the maximum fill height.

They also indicate the approximate fill level in grams for powder detergents, depending on the manufacturer and the coarseness.

- Follow the detergent dosage recommended by the manufacturer on the packaging.
- Unless directed otherwise, use one detergent tab or add 20 to 30 ml of detergent to the detergent compartment, depending on the level of soiling of the dishware.

If you use less than the recommended amount of detergent, the dishware may not get properly clean.

# Detergents

## Adding detergent

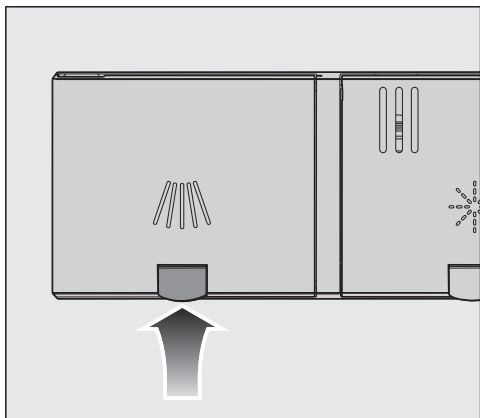

- Press the yellow button  on the lid of the detergent compartment.

The lid will spring open.  
The lid will also open at the end of a program.

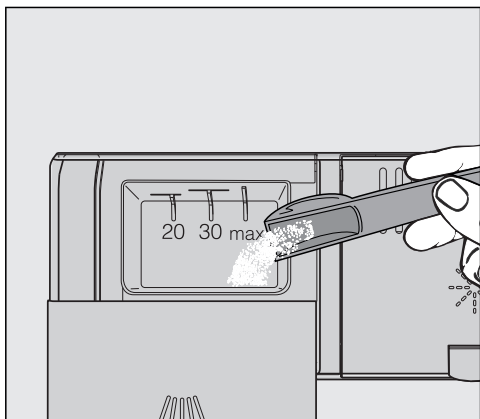

- Add the detergent to the detergent compartment.
- Push the lid shut until you hear it click into place.

The detergent must not cause the detergent-compartment lid to get stuck. This can prevent the lid from opening during the program.  
Do not overfill the detergent compartment.

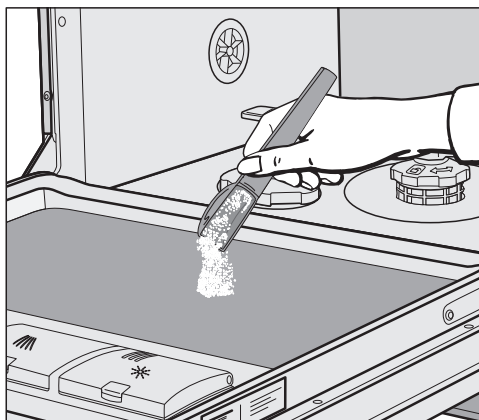

- Ensure that the detergent packaging is properly closed after use. This prevents the detergent from getting damp and clumping together.



- You can also apply a small amount of detergent to the inner panel of the door in programs that have a pre-rinse stage (see "Program overview").

Whether you use detergent, always observe the manufacturer's instructions.

## Turning on the dishwasher

- Make sure the spray arms can rotate freely.
- Close the door.
- Turn on the water supply if it is turned off.
- Touch the  sensor button.  
If the dishwasher has been turned off for longer than 1 minute, you will need to hold the  sensor button for a bit longer (wipe protection).

The  *Economy* program will appear briefly in the display and the appropriate sensor button will be illuminated. Next, the estimated energy and water consumption may be shown for the chosen program for several seconds. Then the display will show the estimated duration for the selected program.

The *Start* sensor button flashes.

## Selecting a program

Choose your program according to the type of dishware and the degree of soiling.

The different programs and their uses are described in the **Program overview** later on in this booklet.

- Touch the sensor button for the program you want.

The sensor button for the selected program will light up.

You can now select program options (see “Program options”).

If any program options are selected, the appropriate sensor buttons will light up.



# Operation

---

## Display of program cycle time

The estimated duration of the selected program appears in the display before the program starts. During the program, the time left until the end of the program is displayed.

Each program phase is indicated by a symbol:

-  Pre-rinse/Soak
-  Main wash
-  Interim rinse
-  Final rinse
-  Drying
-  Finish

The displayed duration may vary for the same program. It is influenced by, for example, the temperature of the incoming water, the reactivation cycle of the water softener, and the amount of dishware and how soiled it is.

When a program is selected for the first time, the display will show the average cycle time for a hot water connection.

The program durations shown under “Program overview” refer to standard test loads and temperatures.

Each time a program is run, the control module calculates the program duration required depending on the temperature of the water taken into the dishwasher and the amount of dishware.

## Starting a program

- Touch the *Start* sensor button.  
Confirm the previously displayed messages with *OK*.

The program starts.

The *Start* sensor button lights up.

During the program sequence, you can use *OK* to display the name of the program that is currently running.

 Risk of scalding due to hot water.  
During operation, water in the dishwasher may be very hot.  
During operation, only open the door with extreme caution.



## Program end

The audible signal might sound at the end of the program.

The program has ended when the display shows the message  Ready.

In some programs, if the AutoOpen function is activated, the door will automatically open slightly (see “AutoOpen” under “Settings”). This improves the drying process.

If the Consumption programmable function is turned on, you can now call up the actual water consumption of the program that has just finished (see “EcoFeedback consumption display” under “Caring for the environment”).

The drying fan may continue to run for a few minutes at the end of the program.



**Risk of damage due to steam.**

Steam from the dishwasher could damage the edges of delicate countertops when you open the door at the end of the program if the fan is no longer running.

If you have deactivated the automatic door-opening function (see “AutoOpen” under “Settings”), but would still like to open the door at the end of the program, then make sure that you open the door fully.

## Energy management

To save energy, the dishwasher will turn off automatically 10 minutes after the last time a sensor button is pressed or after the end of a program.

You can turn the dishwasher back on again with the  sensor button.

If the dishwasher has been turned off for longer than 1 minute, you will need to hold the  sensor button for a bit longer (wipe protection).

The dishwasher will not turn itself off while a program is running or if there is a fault.

# Operation



---

## Turning off the dishwasher

- The dishwasher can be turned off at any time using the  sensor button.

You can also stop an ongoing timer by turning off the dishwasher.

Turning the dishwasher off during a program stops the program.

- Confirm the query Turn appliance off with *OK*.
- If you have pressed the  sensor button, but in fact do not wish to cancel the program, use the  button to select the Do not turn off option on the display and confirm with *OK*.



Risk of damage from leaking water.

Leaking water can cause damage.

If the dishwasher is not going to be used for a longer period of time, e.g., during vacations, the water supply valve should be turned off.

## Unloading the dishwasher

Dishes tend to break and chip more easily when they are hot. Allow the dishes to cool until they are comfortable enough to handle before unloading them.

The dishes will cool much faster if you open the door when the program has ended.

- First unload the lower basket, then the upper.  
This will prevent water drops from the upper basket from falling onto the dishes in the lower basket.

## Interrupting a program

A program will be interrupted as soon as the door is opened.

When the door is closed again, the query *Continue with Start* appears in the display.

The program will continue from the point at which it was interrupted when you press the *Start* button.

 Risk of scalding due to hot water. During operation, water in the dishwasher may be very hot. During operation, only open the door with extreme caution.

## Canceling or changing a program

If a program is canceled, important program stages may be missed. A program should only be canceled in the first few minutes.

If a program has already started and you wish to cancel it, proceed as follows:

- Turn the dishwasher off using the  sensor button.
- Confirm the query *Turn appliance off with OK*.

If you would like to select another program:

- Turn the dishwasher back on using the  sensor button.
- If you have dispensed detergent manually, check whether the detergent compartment is still closed. If the lid is already open, fill it with detergent again and close the lid.
- Select the program you want, and then start it.

# Options

---

## Options

Options can be selected and deselected using the appropriate buttons and the display before starting the program.

The time remaining and temperature options can be changed during the program.

- Turn the dishwasher on by touching the  sensor button.

The *Start* sensor button flashes.

- Select a program.
- Press the button for the option you want.

The indicator light for the relevant button will come on if the option is available for the program selected.

If the option is not compatible with the program selected, a message to this effect will appear in the display.

- In this instance, confirm the message with *OK*.
- Press the *Start* button to start the program.

The option selected will remain active for that particular program until the setting is changed.

## Countdown indicator

The Countdown indicator  option is selected as standard and displays the time remaining until the end of the program.

You can also switch to the Temperature  option while the program is running.

## Temperature

The Temperature  option shows the current temperature of the wash block.

You can also switch to the Countdown indicator  while the program is running.

## Extra dry

The Extra dry  option improves the drying performance in programs in which this option is available.

Energy consumption is increased due to an extended fan running time.

If the AutoOpen function has been activated, the door will automatically open at the end of the program.

## Settings

The Settings  option opens the menu to enable settings to be selected on the machine and changes to be made to program parameters.

See the “Settings” chapter for more information.

## Timer

The timer  gives you several options for starting a program at a later time. The start or finish time of a program can be delayed. You can also use the EcoStart or SmartStart functions to benefit from lower electricity rates at night.

During manual detergent dispensing, the detergent will clump together if the detergent compartment is not dry, and this may mean it is not fully rinsed out.

When using the timer function, make sure that the detergent compartment is dry before adding detergent. Wipe dry with a cloth first, if necessary. Do not use any liquid detergents. These can leak out.

 **Danger to health due to detergent.**

To prevent children coming into contact with dishwasher detergent:

Do not fill the detergent dispenser **until just before starting the program**, i.e., before you activate the timer. Use the safety lock to secure the dishwasher door.

## Activating the timer

- Turn the dishwasher on using the  sensor button.

The *Start* sensor button flashes.

- Select the program you want to use.
- Touch the  sensor button.

The  sensor button lights up.

You can use the  $\nabla/\wedge$  sensor buttons to choose between the *Start at*, *Finish at*, and *EcoStart* functions, or *SmartStart* if applicable.

- Confirm selection of the function you want with *OK*.

The last time set for the timer will be displayed and the hour number block will be highlighted.

- Enter the time you want for the timer using the  $\nabla/\wedge$  sensor buttons and confirm with *OK*.

If, while you are setting the time, you do not apply any settings for several seconds, the display will revert to the previous menu. You will then have to enter your settings again.

After you have activated the timer, all the displays will turn off after a few minutes to save energy.

To turn the display back on for a few minutes, press the  sensor button.

You can also activate a timer via the Miele app.

# Options

---

## Setting “Start at”

With the *Start at* function, you set the exact time at which you want the program to start.

- Use the  $\vee/\wedge$  sensor buttons to enter the hour and confirm your entry with *OK*.

The hour will be saved and the minute number block will be highlighted.

- Use the  $\vee/\wedge$  sensor buttons to enter the minutes and confirm your entry with *OK*.

The saved start time for the selected program will appear in the display for several minutes.

When the set time is reached, the program selected will begin automatically. The time left will appear in the display, the  $\oplus$  sensor button will go out, and the *Start* sensor button will light up.

## Setting “Finish at”

Use the *Finish at* function to set the latest time by which the program selected has to be finished.

- Use the  $\vee/\wedge$  sensor buttons to enter the hour and confirm your entry with *OK*.

The hour will be saved and the minute number block will be highlighted.

- Use the  $\vee/\wedge$  sensor buttons to enter the minutes and confirm your entry with *OK*.

The estimated start time for the selected program will appear in the display for several minutes.

A message will appear in the display if the program cannot be completed by the set finish time because the cycle time is too long.

- If it appears, confirm the message with *OK*.

The program will start automatically when the estimated start time is reached.

The time left will appear in the display, the  $\oplus$  sensor button will go out, and the *Start* indicator light will light up.

## Setting EcoStart

The EcoStart function enables you to benefit from cheaper electricity rates at night. Before you can use this option, you need to set up to 3 electricity-rate time zones (see “EcoStart” under “Settings”).

Then set the time by which the selected program has to be finished.

The dishwasher will then start automatically in the most economical rate zone within the time set.

- Use the  $\vee/\wedge$  sensor buttons to enter the hour and confirm your entry with *OK*.

The hour will be saved and the minute number block will be highlighted.

- Use the  $\vee/\wedge$  sensor buttons to enter the minutes and confirm your entry with *OK*.

The estimated start time for the selected program will appear in the display for several minutes.

The program will start automatically when the estimated start time is reached.

The time left will appear in the display, the  $\oplus$  sensor button will go out, and the *Start* sensor button will light up.

## Setting SmartStart

The SmartStart function is used for starting your dishwasher automatically at a time when your energy costs are most economical.

To use this function you may need further technical accessories.

If you have activated the SmartStart function in the Settings  $\blacksquare$  menu, the *Timer*  $\oplus$  menu will no longer show the EcoStart function but will instead show SmartStart (see “Miele@home” under “Settings”).

If your energy provider offers this service, they will send a signal to your dishwasher when energy costs are at their most economical.

This signal will start the dishwasher.

You can set the time by which the program selected has to be finished. The dishwasher will then calculate the latest possible start time for the program selected and will wait until this start time for the signal from the energy provider.

## Options

---

Set the time by which the selected program has to be finished.

- Use the  $\vee/\wedge$  sensor buttons to enter the hour and confirm your entry with *OK*.

The hour will be saved and the minute number block will be highlighted.

- Use the  $\vee/\wedge$  sensor buttons to enter the minutes and confirm your entry with *OK*.

Waiting for SmartStart will appear in the display.

The *Start* sensor button lights up for a few minutes.

The selected program will start automatically as soon as the energy provider has sent the signal or the latest possible calculated start time has been reached.

The time left will appear in the display, the  $\oplus$  sensor button will go out, and the *Start* sensor button will light up.

### Changing or deleting the timer time

You can change the time set for the timer or delete it.

- Touch the  $\oplus$  sensor button.
- Use the  $\vee/\wedge$  sensor buttons to select the previously activated timer function and confirm your entry with *OK*.
- Use the  $\vee/\wedge$  sensor buttons to select the *Change* or *Delete* function and confirm with *OK*.

After confirming the *Change* function with *OK*, you can change the time set for the timer.

After confirming the *Delete* function with *OK*, the cycle time of the selected program will appear in the display.

The  $\oplus$  sensor button goes out and the *Start* sensor button flashes.

You can now start a program or turn the dishwasher off.



Turning the dishwasher off while a timer is running stops the timer.

You can also change the time set for the timer or delete it using the Miele app.



## Activating Remote start

You can start your dishwasher remotely using the Miele app. To do this, you first need to install the app on your mobile device, connect the dishwasher to your WiFi network (see “Miele@home” under “Settings”), and, if applicable, activate the Remote control option (see “Remote control” under “Settings”).

- Turn the dishwasher on using the  sensor button.
- Touch the  sensor button when the door is closed.

The  sensor button lights up.

The remote control function for the dishwasher using the Miele app must be reactivated each time the door is opened before a program is started.









The dishwasher can now be operated remotely using the Miele app.

The Remote start option will remain activated until you deactivate it again using the  sensor button. The option will also remain active if you turn the dishwasher off and back on again in the meantime.

Even if the Remote start option is not active, you can check the status of your dishwasher and apply settings using the Miele app.

If you start a program using the *Start* sensor button on the dishwasher, the Remote start option will automatically be activated for the duration of the program and the  sensor button will light up.

## Program chart

Program	Application	Detergents
		Detergent compartment  <sup>1)</sup>
 QuickIntense-Wash	For fresh, non-sticky food residues.	20–25 g or 1 detergent tab
 Universal	For normal, slightly dried food residues.	20–25 g or 1 detergent tab
 Pots & Pans	For burnt-on, stubborn, dried-on food deposits containing starch or protein <sup>1)</sup> .	20–25 g or 1 detergent tab
 Plastics	Special plastics program.	20–25 g or 1 detergent tab
 China & Crystal	Special glassware program.	20–25 g or 1 detergent tab
 SaniWash	Special SaniWash program for items that need to be hygienically clean.	20–25 g or 1 detergent tab
 Rinse & Hold	To rinse heavily soiled items, e.g., for initial removal of dirt or to prevent residues drying on to dishes when a complete program does not yet need to be run.	
 ECO *)	Energy-saving program with a long cycle time for normal, slightly dried food residues.	20–25 g or 1 detergent tab

\*) This program is used for energy labeling purposes.  
Program for regular use to completely wash a full load of normally soiled dishes.  
(Fixed program sequence which cannot be altered)

<sup>1)</sup> See “Detergents”

# Program chart

Program cycle					
Pre-rinse	Main wash	Interim rinse	Final rinse	Drying	AutoOpen
	X 140-149 °F (60-65 °C) <sup>2)</sup> 1 min	X 40 s	X 149°F (65°C) <sup>3)</sup> 30 s	(X) 20 min <sup>4)</sup>	(X)
	X 149 °F (65 °C) 6 min	X 3 min	X 149°F (65°C) <sup>3)</sup> 2 min	(X) 30 min	(X)
X 6 min	X 167 °F (75 °C) 6 min	X 3 min	X 149°F (65°C) <sup>3)</sup> 2 min	(X) 30 min	(X)
X 6 min	X 122°F (50°C) 1 min	X 5 min	X 140°F (60°C) 1 min	X 30 min	(X)
	X 122°F (50°C) 1 min	X 3 min	X 122°F (50°C) 2 min	(X) 20 min	(X)
X 8 min	X 151°F (66°C) 10 min	X 3 min	X 180°F (82°C) 2 min	X 30 min	(X)
	X Cold 10 min				
	X 129 °F (54 °C) 35 min	X 4 min	X 140 °F (60 °C) 6 min	X 30 min	(X)

X = Program stages







(X) = Optional extra program stages (See “Program options, Options”)

<sup>2)</sup> The temperature reached depends on the type and amount of wash items as well as the water inlet temperature.

<sup>3)</sup> Optional temperature increase to 180°F (82°C).

<sup>4)</sup> If the temperature is increased to 180°F (82°C), the drying time will be extended to 30 minutes.

# Program chart

Program	Consumption <sup>6)</sup>						Duration <sup>6)</sup>			
	Electrical energy				Water		Cold water 60°F (15°C)		Hot water 130°F (55°C)	
	Cold water 60°F (15°C)		Hot water 130°F (55°C)							
	1.4 kW	4.0 kW	1.4 kW	4.0 kW	1.4 kW	4.0 kW	1.4 kW	4.0 kW	1.4 kW	4.0 kW
 QuickIntenseWash	1.5 kW h	1.4 kW h	0.9 kWh		3.9 gal (14.7 l)		80 min <sup>7)</sup>	33 min <sup>7)</sup>	52 min <sup>7)</sup>	24 min <sup>7)</sup>
 Universal	1.6 kW h	1.5 kW h	1.0 kWh		3.9 gal (14.8 l)		95 min <sup>7)</sup>	43 min <sup>7)</sup>	63 min <sup>7)</sup>	35 min <sup>7)</sup>
 Pots & Pans	1.8 kW h	1.7 kW h	1.1 kW h	1.0 kW h	5 gal (19.2 l)		111 min <sup>7)</sup>	60 min <sup>7)</sup>	76 min <sup>7)</sup>	48 min <sup>7)</sup>
 Plastics	1.3 kWh		0.6 kWh	0.5 kWh	5.15 gal (19.5 l)		115 min	75 min	77 min	63 min
 China & Crystal	1.0 kWh		0.5 kWh	0.4 kWh	4 gal (15.3 l)		60 min <sup>7)</sup>	30 min <sup>7)</sup>	35 min <sup>7)</sup>	22 min <sup>7)</sup>
 SaniWash	2.2 kWh	2.0 kWh	1.5 kW h	1.3 kW h	5 gal (19.2 l)		121 min <sup>7)</sup>	66 min <sup>7)</sup>	85 min <sup>7)</sup>	54 min <sup>7)</sup>
 Rinse & Hold	0.02 kWh		0.02 kWh		1.19 gal (4.5 l)		13 min		13 min	
ECO 13 place settings	1.10 kWh		0.6 kWh		3.0 gal (11.3 l)		145 min		135 min	

<sup>6)</sup> The quoted values are calculated in accordance with EN 50242 for a connected load of 1.4 and 4.0 kW. In practice, considerable variations may be noted due to differing conditions. The duration displayed is adjusted to the on-site conditions.

<sup>7)</sup> The value is based on the wash time without drying.

## USER MAINTENANCE INSTRUCTIONS

To prolong the service life of the dishwasher, maintenance should be carried out **at least once a year** by Miele Customer Service.

Maintenance covers the following:

- Electrical safety according to national regulations
- Door mechanism and door seal
- Any screw connections and connectors in the wash cabinet
- Water inlet and drainage
- Internal and external dispensing systems
- Spray arms
- Filter combination
- Sump including drain pump and non-return valve
- All baskets and inserts

The following operational tests will be carried out as part of the maintenance:

- A program will be run as a test run
- Seals will be tested for water tightness
- All relevant measuring systems will be safety tested, including fault displays
- Safety features

Check the condition of your dishwasher regularly (approx. every 4–6 months). This way, faults and problems can be avoided.

 Damage due to unsuitable cleaning agents.

All surfaces are susceptible to scratching. Contact with unsuitable cleaning agents can alter or discolor the external surfaces.

Only use cleaning agents formulated for use on the relevant surfaces.

## Cleaning the wash cabinet

The wash cabinet is largely self-cleaning, provided that the correct amount of detergent is always used.

If, despite this, limescale or grease deposits build up in the chamber, these can be removed with a proprietary dishwasher cleaner (available from Miele). Follow the dosage recommended by the manufacturer on the packaging.

- Clean the filters in the wash cabinet regularly.

# Cleaning and care

---

## Cleaning the door and the door seal

The door seal and the sides of the dishwasher door are not accessed and cleaned by the spray arm jets.

- Wipe off any food or drink residues which may have dripped onto the sides and seals of the dishwasher door with a damp cloth on a regular basis to prevent the build-up of mold.

## Cleaning the control panel

- The control panel should **only** be wiped with a damp cloth.

## Cleaning the front of the machine



Damage due to soiling.

Soiling that is left too long might become impossible to remove and could cause the external surfaces to alter or discolor.

It is therefore best to remove any soiling immediately.

- Clean the appliance front with a clean soft sponge and a solution of warm water and washing-up liquid. After cleaning, wipe the surfaces dry using a soft cloth.

A clean, damp microfiber cloth without detergent can also be used.

## To avoid damaging the external surfaces, do not use the following:

- cleaning agents containing soda, ammonia, acids, or chloride
- cleaning agents containing lime scale remover
- abrasive cleaning agents, such as scouring powder, scouring liquid, or pumice stones
- cleaning agents containing solvents
- stainless-steel cleaning agents
- dishwasher cleaner
- oven cleaner
- glass cleaner
- hard, abrasive brushes or sponges, e.g., pot scourers, brushes, or sponges which have been previously used with abrasive cleaning agents
- eraser sponges
- sharp metal scrapers
- steel wool
- steam cleaners

## Cleaning the spray arms

Particles of food can get stuck in the spray arm jets and bearings. The spray arms should therefore be inspected regularly (approx. every 2–4 months).

 **Damage due to soiling entering the circulation system.**

Without filters, soiling can enter the circulation system and cause a blockage.

Do not run a wash program without the lower spray arm or without the filters.

When cleaning the filters and spray arms, make sure that coarse soiling cannot get into the circulation system.

- Turn off the dishwasher.

## Removing the upper and middle spray arms

- Push the upper spray arm upwards to engage the inner ratchet. Then unscrew the spray arm by rotating the screw thread counterclockwise.

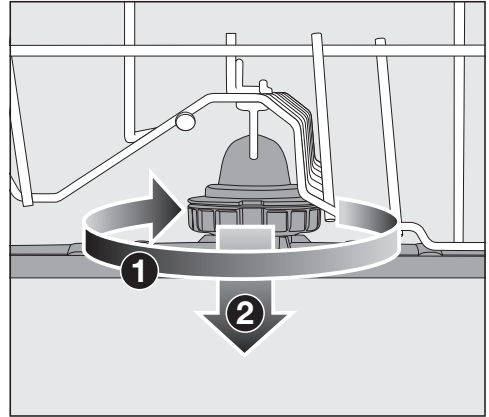

- Rotate the screw thread of the middle spray arm clockwise ① (see diagram) and remove the spray arm ②.

## Removing the lower spray arm

- Remove the lower basket.

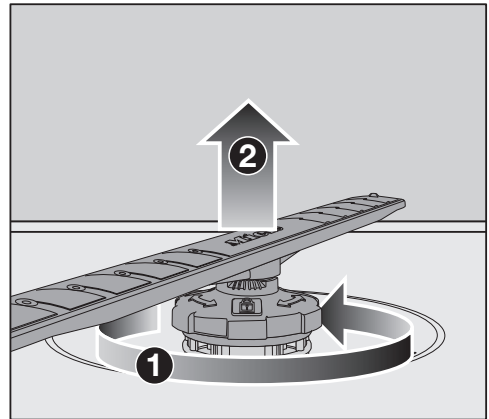

- Rotate the screw thread of the lower spray arm counterclockwise ① and pull the spray arm upwards to remove ②.

# Cleaning and care

## Cleaning the spray arms

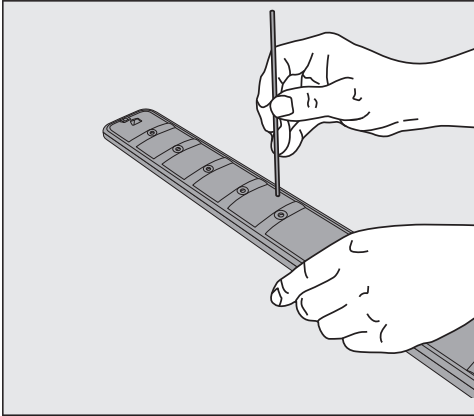



- Use a pointed object to push food particles that are stuck in the spray arm jets into the spray arm.
- Rinse the spray arm thoroughly under running water.

## Refitting the spray arms

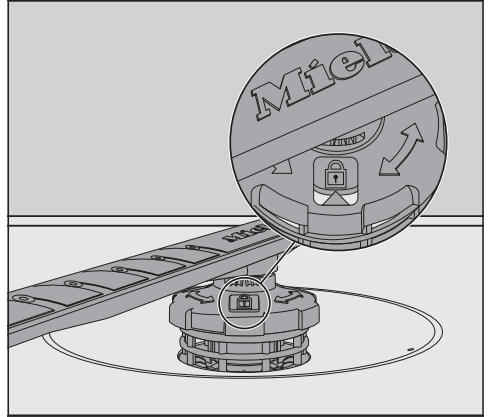
- Refit the upper and middle spray arms.
- Refit the lower spray arm and ensure that the filter combination lies flat in the base of the wash cabinet.



- Rotate the screw thread of the lower spray arm clockwise until the arrow in the viewing window points to the lock symbol .
- Make sure the spray arms can rotate freely.

 **Damage due to soiling entering the circulation system.**  
The lower spray arm is used to secure the filter combination. Without filters, coarse soiling can enter the circulation system and cause a blockage.  
Do not run a wash program without the lower spray arm or without the filters.



## Checking the filters in the wash cabinet

The filter combination in the base of the wash cabinet retains coarse soil from the suds solution. This prevents soiling getting into the circulation system and re-entering the wash cabinet through the spray arms.

 **Damage due to soiling entering the circulation system.**

Without filters, soiling can enter the circulation system and cause a blockage.

Do not run a wash program without the lower spray arm or without the filters.

When cleaning the filters and spray arms, make sure that coarse soiling cannot get into the circulation system.

The filters can become blocked by soiling that collects over time. The level of soiling and time it takes before the filters need cleaning will vary depending on use.

The message **Check filters** will appear in the display after every 50 program sequences.

- Check the filter combination.
- Clean, if necessary.
- Then confirm the message with *OK*.

## Cleaning the filters

- Turn off the dishwasher.
- Remove the lower spray arm (see “Cleaning the spray arms” under “Cleaning and care”).
- Before removing the filter combination, remove any coarse soiling to prevent it from entering the circulation system.

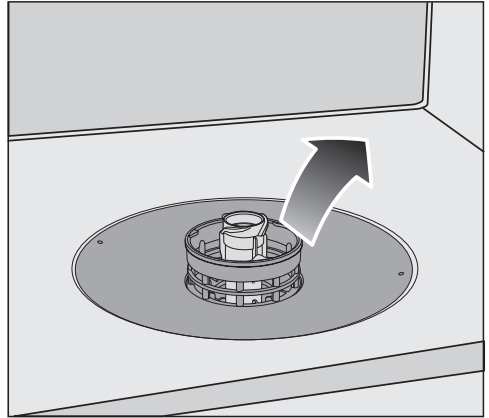

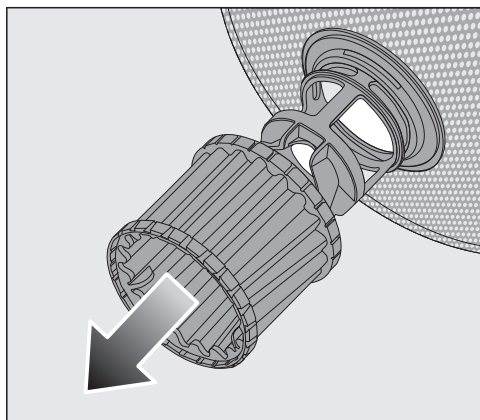

- Remove the filter combination.

## Cleaning and care

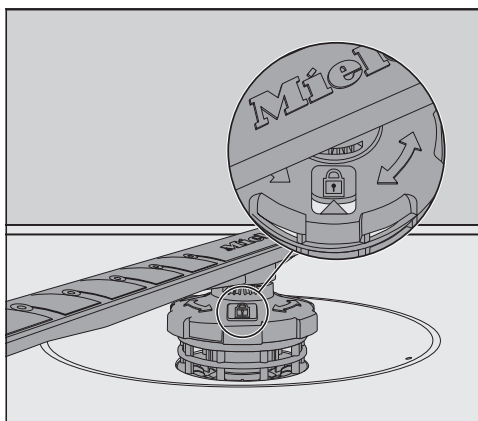

- In order to clean the inside of the filter, pull the microfilter on the plastic ring downwards and away from the filter combination.
- Rinse all of the filters under running water.  
If necessary, use a soft cleaning brush to remove soiling.
- Insert the microfilter back into the filter combination.
- Reinstall the filter combination so that it lies flat in the base of the wash cabinet.
- Refit the lower spray arm to the filter combination using the screw thread.



- Rotate the screw thread clockwise until the arrow in the viewing window points to the lock symbol .

 Damage due to soiling entering the circulation system.

The lower spray arm is used to secure the filter combination. Without filters, coarse soiling can enter the circulation system and cause a blockage.

Do not run a wash program without the lower spray arm or without the filters.

### Cleaning the water-inlet filter

A filter is incorporated in the screw connection to protect the water-intake valve. If the filter is soiled, insufficient water flows into the wash cabinet.

 Risk of electric shock from voltage.

The plastic housing of the water connection contains an electrical valve. The housing must not be dipped in water.

- Disconnect the dishwasher from the power supply.  
To do this, turn off at the socket and unplug the machine.
- Close the faucet.
- Unscrew the water-intake valve.

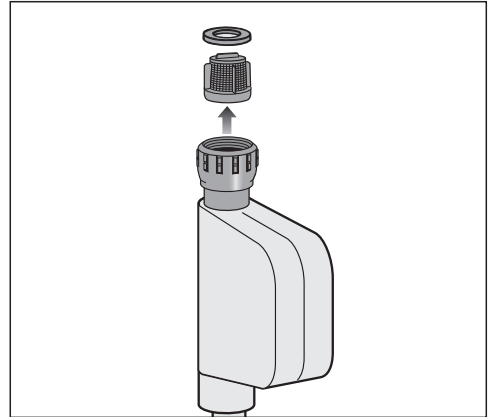

- Take the seal ring out of the screw connection.
- Using pointed pliers, take hold of the plastic filter bar and pull it through the filter.
- Rinse the filter under running water.
- Reassemble in reverse order.

Screw the screw connection securely back onto the faucet. Slowly open the faucet. If water drips out, tighten the connection.

**Never** forget to put the filter back in place after cleaning.

## Cleaning and care

### Cleaning the drain pump

If water remains in the wash cabinet after the end of a program, the water has not been pumped away. The drain pump may be blocked by foreign objects. These foreign objects are easy to remove.

- Disconnect the dishwasher from the power supply.  
To do this, turn off and unplug the dishwasher.
- Take the filter combination out of the wash cabinet (see “Cleaning the filters” under “Cleaning and care”).
- Scoop the water out of the wash cabinet using a suitable small container or utensil.

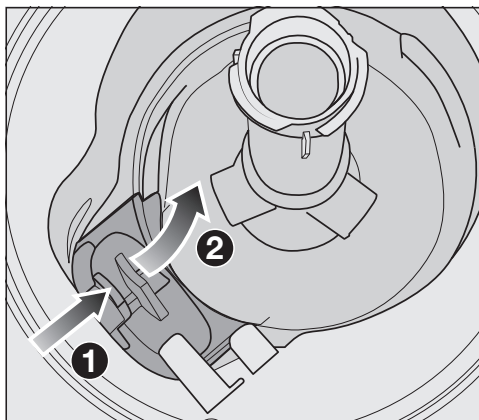

- Press the catch of the drain pump cover inwards ①.
- Tip the cover inwards until it is released ②.
- Rinse the cover thoroughly under running water and remove all foreign objects.



The drain pump (see arrow) is underneath the cover.

**!** Risk of injury from glass splinters. It is especially difficult to see glass splinters in the drain pump. Take care when cleaning the drain pump.

- Carefully remove all foreign objects from the drain pump. Check the drain pump impeller by manually turning it. You will feel a little resistance when you turn the impeller.
- Refit the cover by placing it down vertically from above.

Ensure that the catch engages correctly.

**!** Damage due to incorrect cleaning. The components are delicate and can be damaged during cleaning. Take care when cleaning the drain pump.

# Troubleshooting

With the aid of the following guide, most minor problems can be corrected without contacting Miele. You can save time and money in many cases, as you do not need to contact Miele Customer Service.

The following guide should help you to find the reason for a malfunction or fault, and to correct it. However, please note:



Danger due to incorrect repairs.



Repairs by unqualified persons can cause considerable danger to users.

Repairs must only be carried out by Miele Customer Service, an authorized Miele dealer, or a suitably qualified specialist in accordance with local and national safety regulations.

## Technical faults

Problem	Possible cause and solution
<b>The display remains dark after the dishwasher has been turned on with the  sensor button.</b>	The dishwasher is not plugged in. ■ Insert the plug.
	The circuit breaker has tripped. ■ Reset the breaker (see data plate for the correct fuse rating). ■ If the breaker trips again, contact Miele Customer Service.
<b>The dishwasher stops during a program.</b>	The circuit breaker has tripped. ■ Reset the circuit breaker (see data plate for the correct fuse rating). ■ If the circuit breaker trips again, contact Miele Technical Service.
<b>After the program has started, the in-operation indicator light is not visible.</b>	The reflector panel was not correctly fitted. ■ Re-fit the reflector panel correctly (see installation sheet).

## Fault messages

Problem	Possible cause and solution
<p><b>The alarm tone is sounding.</b>  <b>One of the following faults appears in the display:</b></p>	<p>Before remedying the fault:</p> <ul style="list-style-type: none"> <li>■ Turn off the dishwasher.</li> </ul>
<p> Fault FXX</p>	<p>There may be a technical fault.</p> <ul style="list-style-type: none"> <li>■ Turn the dishwasher back on after a few seconds.</li> <li>■ Restart the desired program.</li> </ul> <p>If the fault message appears again, there is a technical fault.</p> <ul style="list-style-type: none"> <li>■ Turn off the dishwasher.</li> <li>■ Close the faucet.</li> <li>■ Contact Miele Customer Service.</li> </ul>
<p> Waterproof</p>	<p>The Waterproof system has reacted.</p> <ul style="list-style-type: none"> <li>■ Turn off the dishwasher.</li> <li>■ Close the faucet.</li> <li>■ Contact Miele Customer Service.</li> </ul>
<p> Fault F78</p>	<p>Circulation-pump fault.</p> <ul style="list-style-type: none"> <li>■ Turn off the dishwasher.</li> <li>■ Turn the dishwasher back on.</li> <li>■ Restart the desired program.</li> </ul> <p>If the fault message appears again, there is a technical fault.</p> <ul style="list-style-type: none"> <li>■ Turn off the dishwasher.</li> <li>■ Close the faucet.</li> <li>■ Contact Miele Customer Service.</li> </ul>

# Troubleshooting



---

## Door release

Problem	Possible cause and solution
<b>The alarm tone is sounding. The following fault is indicated via the display:</b>	Before remedying the fault: <ul style="list-style-type: none"><li>■ Turn off the dishwasher.</li></ul>
 Fault F33	The door does not open automatically. There may be a technical fault. <ul style="list-style-type: none"><li>■ Open the door manually (see “Opening the door” under “Before using for the first time”) and turn the dishwasher back on again.</li><li>■ If the same fault message appears again, contact Miele Customer Service.</li></ul>
	The door locking pins do not retract after the door is opened. There may be a technical fault. <ul style="list-style-type: none"><li>■ Turn the dishwasher back on.</li><li>■ If the same fault message appears again, contact Miele Customer Service.</li></ul>



## Water intake fault

Problem	Possible cause and solution
<p><b>The alarm tone is sounding.</b>  <b>One of the following messages appears in the display:</b></p>	
<p> Open water supply</p>	<p>The water supply faucet is turned off.</p> <ul style="list-style-type: none"> <li>■ Open the water-supply faucet all the way.</li> </ul>
<p> Intake</p>	<p>Before remedying the fault:</p> <ul style="list-style-type: none"> <li>■ Turn off the dishwasher.</li> </ul> <p>Water-inlet fault.</p> <ul style="list-style-type: none"> <li>■ Open the water-supply faucet all the way and start the program again.</li> <li>■ Clean the water-inlet filter (see “Cleaning the water-inlet filter” under “Cleaning and care”).</li> <li>■ The water-connection pressure is lower than 7.25 psi (50 kPa). Consult a plumber.</li> <li>■ The on-site connection for the water drain may be too low and you will need to raise the water drain (see “Hose installation” under “Installation”).</li> </ul>
<p> Fault F18</p>	<p>A technical fault has occurred.</p> <ul style="list-style-type: none"> <li>■ Turn off the dishwasher.</li> <li>■ Close the faucet.</li> <li>■ Contact Miele Customer Service.</li> </ul>

# Troubleshooting

---

## Water drainage fault

Problem	Possible cause and solution
<p><b>The alarm tone is sounding.</b> <b>The following message appears on the display:</b>  Drain</p>	<p>Before remedying the fault:</p> <ul style="list-style-type: none"><li>■ Turn off the dishwasher.</li></ul> <hr/> <p>Water-drainage fault. There might be water in the wash cabinet.</p> <ul style="list-style-type: none"><li>■ Clean the filter combination (see “Cleaning the filters” under “Cleaning and care”).</li><li>■ Clean the drain pump (see “Cleaning the drain pump” under “Cleaning and care”).</li><li>■ Remove any kinks or loops in the drain hose.</li></ul>

## General dishwasher problems

Problem	Possible cause and solution
<b>The indicator lights and the display are dark.</b>	<p>The dishwasher has turned off automatically to save energy.</p> <ul style="list-style-type: none"> <li>■ Turn the dishwasher back on using the  sensor button.</li> </ul>
<b>The wash cabinet lighting does not come on when the door is opened.</b>	<p>The wash cabinet lighting has been turned off permanently.</p> <ul style="list-style-type: none"> <li>■ Turn the lighting back on again (see “BrilliantLight” under “Settings”).</li> </ul>
	<p>Faulty wash cabinet lighting.</p> <ul style="list-style-type: none"> <li>■ Contact Miele Technical Service.</li> </ul>
<b>Detergent residue is left in the detergent compartment at the end of a program.</b>	<p>The detergent compartment was still damp when detergent was added.</p> <ul style="list-style-type: none"> <li>■ Only add the detergent when the detergent compartment is dry.</li> </ul>
<b>The detergent compartment lid cannot be closed.</b>	<p>Residual detergent is blocking the catch.</p> <ul style="list-style-type: none"> <li>■ Remove the residual detergent.</li> </ul>
<b>At the end of a program there is a film of moisture on the inside of the door and possibly on the interior cabinet walls.</b>	<p>This is part of the normal function of the drying system. The moisture will dissipate after a short time.</p>
<b>Water remains in the wash cabinet at the end of a program.</b>	<p>Before remedying the fault:</p> <ul style="list-style-type: none"> <li>■ Turn off the dishwasher.</li> </ul>
	<p>The filter combination in the wash cabinet is clogged.</p> <ul style="list-style-type: none"> <li>■ Clean the filter combination (see “Cleaning the filters” under “Cleaning and care”).</li> </ul>
	<p>The drain pump is blocked.</p> <ul style="list-style-type: none"> <li>■ Clean the drain pump (see “Cleaning the drain pump” under “Cleaning and care”).</li> </ul>
	<p>The drain hose is kinked.</p> <ul style="list-style-type: none"> <li>■ Remove any kinks from the drain hose.</li> </ul>

# Troubleshooting

---

## Noises

Problem	Possible cause and solution
<b>There is a knocking noise in the wash cabinet.</b>	A spray arm is knocking against a wash item. ■ Carefully open the door and rearrange the wash items that are obstructing the spray arm.
<b>There is a rattling noise in the wash cabinet.</b>	Wash items are not secure in the wash cabinet. ■ Carefully open the door and rearrange the wash items so that they sit securely.
	There is a foreign object (e.g., glass shard) in the drain pump. ■ Remove the foreign object from the drain pump (see “Cleaning the drain pump” under “Cleaning and care”).
<b>Knocking noise in the water pipes</b>	This may be caused by the on-site installation or the cross-section of the piping. ■ However, this will not affect the functioning of the dishwasher in any way. If in doubt, contact a suitably qualified plumber.

## Poor cleaning results

Problem	Possible cause and solution
<p><b>The dishes are not clean.</b></p>	<p>The dishes were not loaded correctly.</p> <ul style="list-style-type: none"> <li>■ See notes under “Loading the dishwasher”.</li> </ul>
	<p>The program was not powerful enough.</p> <ul style="list-style-type: none"> <li>■ Select a more powerful program (see “Program overview”).</li> </ul>
	<p>Not enough detergent was dispensed during manual detergent dispensing.</p> <ul style="list-style-type: none"> <li>■ Use more detergent, or change the brand you are using.</li> </ul>
	<p>Items are blocking the path of the spray arms.</p> <ul style="list-style-type: none"> <li>■ Carry out a rotation check and if needed rearrange the items so that the spray arms can rotate freely.</li> </ul>
	<p>The filter combination in the wash cabinet is not clean or was incorrectly fitted. This may have caused the spray arm jets to become blocked.</p> <ul style="list-style-type: none"> <li>■ Clean and/or fit the filter combination correctly.</li> <li>■ Clean the spray arm jets if necessary (see “Cleaning the spray arms” under “Cleaning and care”).</li> </ul>
<p><b>There are smears on glassware and cutlery. There is a bluish sheen on the surface of glassware. The film can be wiped off.</b></p>	<p>The rinse aid dosage is set too high.</p> <ul style="list-style-type: none"> <li>■ Reduce the dosage (see “Rinse aid” under “Settings”).</li> </ul>

# Troubleshooting

Problem	Possible cause and solution
<p><b>The dishware is not dry or utensils and glasses are flecked.</b></p>	<p>The rinse-aid dosage is set too low or the rinse-aid reservoir is empty.</p> <ul style="list-style-type: none"> <li>■ Replenish the reservoir, increase the dosage, or change the brand of rinse aid (see “Rinse aid” under “Before using for the first time”).</li> </ul>
	<p>The dishware was taken out of the wash cabinet too soon.</p> <ul style="list-style-type: none"> <li>■ Leave the dishware in longer (see “Unloading the dishwasher” under “Operation”).</li> </ul>
	<p>You have used combination products that have insufficient drying performance.</p> <ul style="list-style-type: none"> <li>■ Switch to another detergent or replenish the rinse aid (see “Rinse aid” under “Before using for the first time”).</li> </ul>
<p><b>Glassware has a brown or blue tinge. The film cannot be wiped off.</b></p>	<p>Ingredients from the detergent have formed a deposit.</p> <ul style="list-style-type: none"> <li>■ Switch to another detergent straight away.</li> </ul>
<p><b>Glassware is dull and discolored. The film cannot be wiped off.</b></p>	<p>The glassware is not dishwasher-safe. The surface has altered.</p> <ul style="list-style-type: none"> <li>■ No remedy. Purchase glassware which is dishwasher-safe.</li> </ul>
<p><b>Tea or lipstick stains have not been completely removed.</b></p>	<p>The wash temperature of the selected program was too low.</p> <ul style="list-style-type: none"> <li>■ Select a program with a higher wash temperature.</li> </ul>
	<p>The bleaching effect of the detergent is too low.</p> <ul style="list-style-type: none"> <li>■ Switch to another detergent.</li> </ul>
<p><b>Plastic parts are discolored.</b></p>	<p>Natural dyes, e.g., from carrots, tomatoes, or ketchup may be the cause. The amount of detergent used or its bleaching effect was not sufficient to deal with natural dyes.</p> <ul style="list-style-type: none"> <li>■ Use more detergent (see “Detergent”). Parts that are already discolored will not revert to their original color.</li> </ul>

# Troubleshooting

Problem	Possible cause and solution
<p><b>White residue is visible on the dishes. Clouding has occurred on glassware and cutlery. The film can be wiped off.</b></p>	<p>The rinse aid dosage is set too low.</p> <ul style="list-style-type: none"> <li>■ Increase the dosage (see “Rinse aid” under “Settings”).</li> </ul>
	<p>The salt reservoir is empty.</p> <ul style="list-style-type: none"> <li>■ Fill the salt reservoir (see “Reactivation salt” under “Before using for the first time”).</li> </ul>
	<p>The salt reservoir cap has not been screwed on correctly.</p> <ul style="list-style-type: none"> <li>■ Replace it, making sure that it screws back on correctly.</li> </ul>
	<p>Unsuitable combination detergents were used.</p> <ul style="list-style-type: none"> <li>■ Switch to another detergent. If using tabs or powder detergent, do not choose combination products and ensure you refill the reactivation salt and rinse aid.</li> </ul>
	<p>The water softener is programmed to too low a water hardness level.</p> <ul style="list-style-type: none"> <li>■ Program the water softener to a higher water hardness level (see “Water hardness” under “Settings”).</li> </ul>
<p><b>There are rust stains on the utensils.</b></p>	<p>The affected items are not corrosion resistant.</p> <ul style="list-style-type: none"> <li>■ No remedy. Purchase utensils which are dishwasher-safe.</li> </ul>
	<p>A program was not run after reactivation salt was added. Traces of salt have got into the normal wash cycle.</p> <ul style="list-style-type: none"> <li>■ Always run the  <i>Rinse &amp; Hold</i> program without any wash items in the dishwasher immediately after refilling salt.</li> </ul>
	<p>The salt-reservoir cap has not been screwed on correctly.</p> <ul style="list-style-type: none"> <li>■ Replace it, making sure that it screws back on correctly.</li> </ul>

# Miele Service

---

## Contact in the event of a fault

In the event of a fault which you cannot remedy yourself, please contact your Miele dealer or Miele Customer Service.

You can book a Miele Customer Service call-out online at [www.miele.com/service](http://www.miele.com/service) or [www.miele.ca/service](http://www.miele.ca/service). Contact information for Miele Customer Service can be found at the end of this document.

Please quote the model and serial number of your dishwasher when contacting Miele. These can be found on the data plate along the right edge of the open door.

## Program updates

The program update function is designed to enable a service technician to update your dishwasher's electronics in keeping with advances in technology.

Program updates can only be performed by a Miele service technician.



## INSTALLATION INSTRUCTIONS

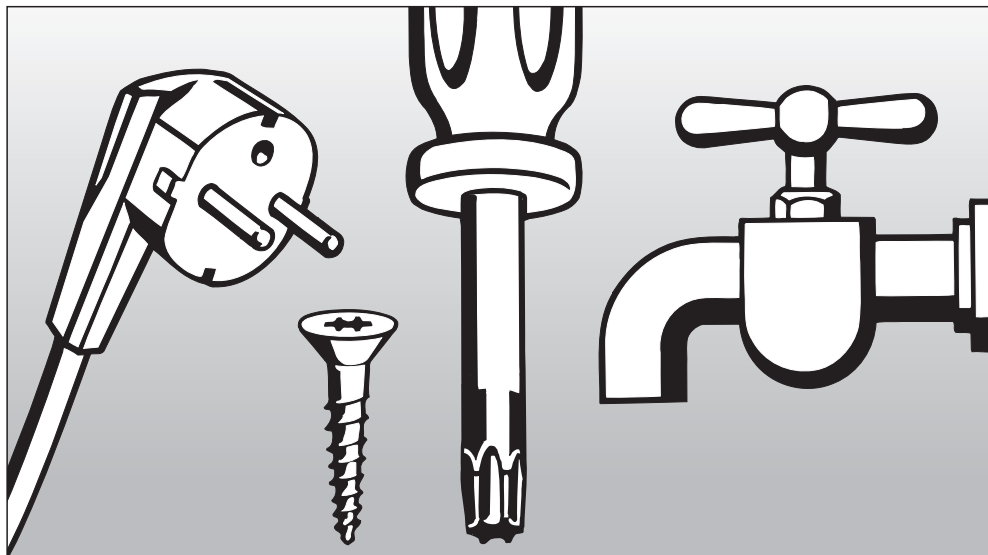

Please refer to the Installation Diagram supplied with these instructions.  
To comply with IEC sound testing protocols, please contact Miele for additional instructions.

Information is subject to change. Please refer to our website to obtain the most current product specification, technical & warranty information.

# Electrical connection

---

## Electrical connection

 All work on the electrical connection must be carried out by Miele Customer Service, an authorized Miele dealer, or a qualified electrician.

**WARNING**  
**THIS APPLIANCE MUST BE**  
**GROUNDED**

- The electrical installation must be in compliance with current local and national safety regulations!
- The connection to the power supply must comply with national regulations (plug and outlet must be accessible after the machine has been installed). This therefore facilitates an electrical safety test performed during maintenance or service work, for example.
- If the dishwasher is hard-wired to the power supply, a circuit breaker capable of disconnecting the dishwasher at all poles must be installed. This power switch must have a contact gap of at least 1/8" (3 mm) and also be lockable in the off-position.
- If necessary, equipotential bonding must be carried out.
- If replacing the power cord, use only original Miele replacement parts.
- For technical data, see the data plate or the attached wiring diagram.

The dishwasher must only be operated with the voltage, frequency, and fuse rating shown on the **data plate**.

The **data plates** (with test certificate, etc.) are located at the back of the dishwasher and along the right edge of the open door.

The **wiring diagram** is supplied with the machine.

The **conversion diagram** is attached to the electrical connection toe-kick panel.

## The Miele Waterproof system

Provided your dishwasher has been installed correctly, the Miele Waterproof system will provide extensive protection against water damage throughout its lifetime.

### Water inlet

 Water in the dishwasher must not be used as drinking water.

- The dishwasher must be connected to the water supply in strict accordance with current local and national water authority regulations.
- The water used must at least comply with national regulations for drinking water quality.  
If the water supply has a high iron content, there is a danger of corrosion occurring on wash items in the dishwasher, as well as the machine itself. If the chloride content of the water exceeds 100 mg/l, the risk of corrosion to items being cleaned in the dishwasher will be further increased.
- In certain regions (e.g., mountainous regions), the water composition may cause precipitates to form, requiring the use of softened water for the dishwasher.
- The water pressure (flow pressure at the connection point) must be between 7.3 and 145 psi (50 and 1000 kPa).  
If the water pressure is lower than this, the fault message *Intake* will appear in the display (see “Frequently asked questions”).  
If the water pressure is too high, a pressure-reducing valve must be fitted.
- The dishwasher is supplied as standard for connection to cold water and hot water up to max. 140°F (60°C). Connect the inlet hoses to the faucets for cold and hot water.
- A faucet with a 3/4" male thread must be provided on site. This should be easily accessible, since the water supply should be shut off whenever the machine is not in use.
- The DN 10 inlet hose is approx. 4' 11" (1.5 m) long terminating in a 3/4" female thread. A 1.5 m long flexible metal extension hose tested to 2,030 psi (14,000 kPa) is available as an optional accessory if required. Do not remove the dirt filter and the flow regulator in the screw connection.

# Plumbing

---

⚠ To avoid any damage to the machine, the dishwasher must only be connected to fully vented pipework.

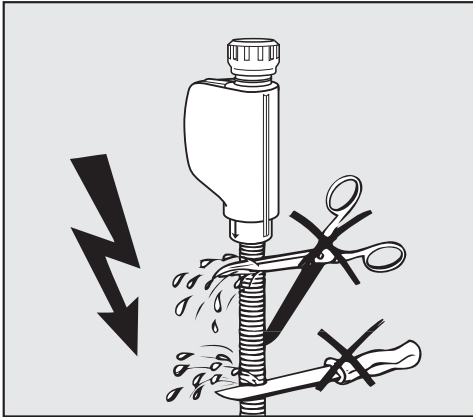

⚠ The intake hose must **not** be shortened or damaged in any way as it contains electrical components (see illustration).

## Connecting the water drainage system

- The machine drainage system has a non-return valve, which prevents dirty water from flowing back into the dishwasher via the drain hose.
- The dishwasher drainage hose should be connected to a separate on-site drain for the dishwasher only. If no separate drain is available, we recommend connecting it to a dual-chamber siphon.
- The dishwasher is supplied with an approx. 4' 11" (1.5 m) flexible drain hose with an internal diameter of 7/8" (22 mm).  
Hose clips are supplied with the dishwasher.
- A method of avoiding using a counter mounted airgap is to advise the following: A "high loop" can be used to provide a drainage air gap by routing a drain line above a sink's flood level.
- The drain hose must not be shortened. The hose can be extended using a connection piece to attach a further length of hose. The drainage length must not be longer than 13' 1" (4 m) and the delivery head no higher than 3' 3" (1 m).
- The drainage system must be able to handle a discharge rate of at least 16 l/min.

 Make sure that there are no kinks in the hose, and that it is not crushed or stretched.

## Hose installation when water drainage is low

If the on-site water drainage connection is situated lower than the guide path for the lower basket rollers in the door, the water drain hose must be installed at that level with a bend in it. Otherwise, water may flow out of the wash cabinet during a program.

## Tall-unit installation

APFD 101 and APFD 102 are available as optional accessories for use when installing the dishwasher in a tall unit.



## Technical details

	<b>Imperial</b>	<b>Metric</b>
Height of freestanding model	33 1/4" (adjustable + 1 3/8")	845 mm (adjustable + 35 mm)
Height of built-in model	31 11/16" (adjustable + 2 9/16" )	805 mm (adjustable + 65 mm)
Installation height	From 31 11/16" (adjustable + 2 9/16")	From 805 mm (adjustable + 65 mm)
Width	23 9/16"	598 mm
Installation width	23 5/8"	600 mm
Depth of freestanding model	23 5/8"	600 mm
Depth of built-in model	22 7/16"	570 mm
Weight	Max. 132 lb	Max. 60 kg
Voltage		
Connected load	See data plate	See data plate
Fuse rating		
Power consumption when turned off	0.4 W	0.4 W
Power consumption when not turned off	5.0 W	5.0 W
Network Standby	0.9 W	0.9 W
Frequency range	2.4000–2.4835 GHz	2.4000–2.4835 GHz
Maximum transmission power	< 100 mW	
Water connection pressure	7.25 psi	50–1.000 kPa
Cold or hot water connection	Up to max. 140°F	Up to max. 60°C
Domestic water hardness	Max. 38 gpg	Max. 36°dH
Delivery head	Max. 3' 3 3/8"	Max. 1.0 m
Drainage length	Max. 13' 1 1/2"	Max. 4.0 m
Ambient temperature	41°F to 104°F	5°C to 40°C
Relative humidity		
Maximum	80% for temperatures up to 88°F	80% for temperatures up to 31°C
Linear decreasing to	50% for temperatures up to 104°F	50% for temperatures up to 40°C
Power cord	Approx. 5' 6 15/16"	Approx. 1.7 m
Capacity	13 place settings	
Noise emission values		
Sound power in LwA	48 dB (A)	
Sound pressure in LpA	35.1 dB (A)	
Test certificates awarded	CSA, UL 921, UL 749	
Manufacturer's address	Miele & Cie. KG, Carl-Miele-Straße 29, 33332 Gütersloh, Germany	

You can alter the dishwasher's controls to suit changing requirements by adjusting the settings.

The settings can be altered at any time.

## Opening the Settings menu

- Turn the dishwasher on with the  sensor button if it is turned off.
- Touch the  Settings sensor button.

The first option in the Settings menu will appear in the display.

For more information about the display functionality, see "Display functions" under "Machine description".

## Changing settings

- Use the  $\vee/\wedge$  sensor buttons to select the menu option you want to change and confirm your selection with *OK*.

Submenu options that have already been selected will have a check  beside them.

- Select the setting you want using the  $\vee/\wedge$  sensor buttons and confirm with *OK*.
- To exit a submenu again, use the  Back sensor button.

The display will revert to the menu above.



# Settings

---

## Language

The display can be set to appear in one of several different languages.

You can change the language used in the display and also the country via the Language  submenu.

The flag after the word Language  serves as a guide if a language that you do not understand has been set. In this case, keep selecting the menu option that has a flag after it until you reach the Language  submenu.

## Time of day

The current time of day must be set before you can use the timer option.

### Setting the clock format

You can select either a 24-hour or 12-hour clock.

- Select the Clock format menu option.
- Select the setting you want and confirm with *OK*.

### Setting the time

You can set the time of day.

- Select the Set menu option.
- Use the  $\vee/\wedge$  sensor buttons to enter the hour and confirm your entry by touching *OK*.  
Then set the minutes and confirm with *OK*.

The time of day has now been saved.



## Water hardness

Your dishwasher is fitted with a water softener.

- The dishwasher must be programmed to the correct water hardness for your area.
- Your local water authority will be able to advise you of the water hardness level in your area.
- Where the water hardness fluctuates, e.g., between 10 and 16 gr/gal (10–15°dH – German scale), always program the dishwasher to the higher value (16 gr/gal or 15°dH in this example).

If the water hardness in your area is available in a unit other than °dH, you can convert the values as follows:  
 $1^{\circ}\text{dH} = 0.18 \text{ mmol/l} = 1.04 \text{ gpg}$

°d	mmol/l	gpg	Display
1	0.2	1	1
2	0.4	2	2
3	0.5	3	3
4	0.7	4	4
5	0.9	5	5
6	1.1	6	6
7	1.3	7	7
8	1.4	8	8
9	1.6	9	9
10	1.8	10	10
11	2.0	11	11
12	2.2	13	12
13	2.3	14	13
<b>14</b>	<b>2.5</b>	<b>15</b>	<b>14</b>
15	2.7	16	15
16	2.9	17	16
17	3.1	18	17
18	3.2	19	18
19	3.4	20	19
20	3.6	21	20
21	3.8	22	21
22	4.0	23	22
23	4.1	24	23
24	4.3	25	24
25	4.5	26	25
26	4.7	27	26
27	4.9	28	27
28	5.0	29	28
29	5.2	30	29
30	5.4	32	30
31	5.6	33	31
32	5.8	34	32
33	5.9	35	33
34	6.1	36	34
35	6.3	38	35
36	6.5		36

## Rinse Aid

You can adjust the rinse-aid dosage for best results.

The rinse-aid dosage can be set from 0 to 6 ml.

3 ml is the factory default setting.

The rinse-aid dosage can turn out to be higher than the set value due to the automatic adjustment of the program.

If stains appear on dishware and glassware:

- Increase the rinse-aid dosage.

If clouding or smearing appears on dishware and glassware:

- Decrease the rinse-aid dosage.

## Temperature unit

The temperature can be displayed in degrees Celsius or degrees Fahrenheit.

- Select the setting you want and confirm with *OK*.

## High-temperature final rinse

For better drying, the final rinse temperature can be increased for individual programs. This function is not available for all programs (see “Program guide”).

- Select the setting you want and confirm with *OK*.

## Miele@home

Your dishwasher is equipped with an integrated WiFi module.

You can connect your dishwasher to your WiFi network.

This will increase the energy consumption, even when the dishwasher is turned off.

The Settings and Miele@home settings menus will be added as additional menu options.

Make sure that your WiFi network signal strength is strong enough at the installation site of your dishwasher.

There are a number of ways of connecting your dishwasher to your WiFi network:

## Setting up Miele@home

You can connect your dishwasher to your network using WPS or via the app.

### Connect using WPS

You can connect your dishwasher to your WiFi network using WPS (WiFi Protected Setup).

Your WiFi router must support WPS.

- Confirm the message Press WPS button with *OK*.
- Activate the WPS function on your router within 2 minutes.
- Once the connection has been established, confirm the message with *OK*.

If the connection fails, you have probably not activated WPS on your router quickly enough. Repeat the steps above.

## Connect using App

You can connect the dishwasher to the Miele app.

The apps are available to download free of charge from the Apple App Store® or from the Google Play Store™.

### Miele app



- Select the Connect using App menu option and confirm with *OK*.
- Follow the instructions in the app.

Once your dishwasher is connected to your WiFi network, you can use the app to carry out the following tasks:

- Call up information on the operating status of your dishwasher
- Call up information on the program sequence of your dishwasher
- Set up a Miele@home network with other WiFi-enabled Miele appliances

### **Deactivate**

If you do not wish to use the WiFi module of your dishwasher, you can turn it off.

- Select the *Deactivate* menu option and confirm with *OK*.

In the *Miele@home* menu, the *Activate* menu option will now be displayed instead of *Deactivate*.

### **Activate**

If you wish to connect your dishwasher to your WiFi network, you can turn on the WiFi module.

- Select the *Activate* menu option and confirm with *OK*.

In the *Miele@home* menu, the *Deactivate* menu option will now be displayed instead of *Activate*.

## Displaying Connection status

You can call up the current connection status of your dishwasher.

- Select the **Connection status** menu option and confirm with *OK*.
- Use the  $\vee/\wedge$  sensor buttons to consecutively call up the WiFi signal strength, the name of your router, and the associated IP address.
- Select *OK* to confirm the messages.

## Set up again

This menu option only appears if you have already connected your dishwasher to your WiFi network.

## Connect using App

- Select the **Connect using App** menu option and confirm with *OK*.
- Follow the instructions in the app.

## Connect using WPS

- Select the **Connect using WPS** menu option and confirm with *OK*.
- Follow the instructions in the display.

## Network configuration

You can use this menu option to reset all WiFi module settings (if available) to the factory default settings.

The network configuration should be reset whenever a dishwasher is being disposed of or sold, or if a used dishwasher is being put into operation. This is the only way to ensure that all personal data has been removed and the previous owner will no longer be able to access the dishwasher.

## Remote control

This menu option will only be displayed if you have connected your dishwasher to your WiFi network (see “Miele@home” under “Settings”).

If you wish to permanently turn off the Remote control option, you can do this under this menu option. The  sensor button will then no longer be available to select until you change this setting again.

Even if the Remote control option is turned off, you can use Miele@mobile to call up information about your machine. However, you cannot start any programs or change any settings from it.

## RemoteUpdate

The RemoteUpdate menu option is only displayed and can only be selected if the requirements for using Miele@home have been met (see “Miele@home” under “Before using for the first time”).

The RemoteUpdate function is used for updating the software in your dishwasher. If an update is available for your dishwasher, it will automatically download it. Updates will not be installed automatically. They must be initiated manually.

If you do not install an update, you can continue to use your dishwasher as usual. However, Miele recommends installing updates.

### Activating/deactivating

The RemoteUpdate function is activated as standard. Available updates will be downloaded automatically but will only be installed if you initiate installation manually.

Deactivate RemoteUpdate if you do not want any updates to be downloaded automatically.

## Running a RemoteUpdate

Information about the content and scope of a RemoteUpdate will be provided in the Miele app.

A message will appear in your dishwasher display if a software update is available.

You can install the update immediately or postpone this until later. When the machine is turned on again, you will be reminded about the update.

Deactivate RemoteUpdate if you do not want to install the update.

The update may take several minutes.

Please note the following information about the RemoteUpdate function:

- You will only receive a message when an update is available.
- Once an update has been installed, it cannot be undone.
- Do not turn the dishwasher off during the update. Otherwise, the update will be aborted and will not be installed.
- Some software updates can only be carried out by Miele Customer Service.

## SmartStart

This menu option will only be displayed if you have connected your dishwasher to your WiFi network (see “Miele@home” under “Settings”).

The SmartStart function is used for starting your dishwasher automatically at a time when your energy costs are most economical.

To use this function you may need further technical accessories.

If you have activated SmartStart Permitted, the Timer ⌚ menu of the selected program will no longer show EcoStart but will instead show SmartStart. The dishwasher will then start within the timeframe specified when it receives a signal from the energy provider. If it has not received a signal from the energy provider by the latest possible start time, the dishwasher will start automatically.

## EcoStart

In order to run your dishwasher in the most economical way, you can use the EcoStart option to take advantage of your electricity supplier's cheaper energy tariffs (see "Timer" under "Options").

With this option selected, your dishwasher will start automatically at your electricity supplier's cheapest rate times.

To use this option, you must first set up to 3 electricity-rate time zones in which the dishwasher can start. You can allocate different priorities to these time zones. The time with the cheapest electricity rate will be given Priority 1.

Contact your energy provider to find out the times of the cheapest electricity rates.

Once the electricity-rate times have been set, you can use the EcoStart option to set the latest finish time required for each program.

The dishwasher will then start automatically during the cheapest electricity-rate time period. The program will end at the set finish time at the latest.

## Setting the electricity-rate times

Before you can use the EcoStart option, you must set at least one electricity-rate time.

- Use the  $\vee/\wedge$  sensor buttons to select an electricity-rate time T1–T3 and confirm with *OK*.

The start of the electricity-rate time selected will appear in the display and the hour number block will be highlighted.

- Use the  $\vee/\wedge$  sensor buttons to set the hours and minutes for the start time and confirm both with *OK*.

The end of the electricity-rate time selected will appear in the display and the hour number block will be highlighted.

- Use the  $\vee/\wedge$  sensor buttons to set the hours and minutes for the end time and confirm both with *OK*.

The electricity-rate time will be saved and its priority will appear in the display.

- Use the  $\vee/\wedge$  sensor buttons to set the priority you want and confirm with *OK*.
- Confirm the message with *OK*.

The electricity-rate time will be activated.



## Changing the electricity rate times

You can change the start, finish, or priority of an electricity rate time.

- Use the  $\vee/\wedge$  sensor buttons to select an electricity tariff time T1–T3 that you wish to change and confirm with *OK*.
- Select the setting you want to change and confirm with *OK*.
- Use the  $\vee/\wedge$  sensor buttons to change the setting and confirm with *OK*.
- Confirm the message with *OK*.

The change will be saved.

## Deleting the electricity-rate times

You can delete the settings for an electricity-rate time and in doing so deactivate the *EcoStart* option for this time zone.

- Use the  $\vee/\wedge$  sensor buttons to select an electricity-rate time T1–T3 that you wish to delete and confirm with *OK*.
- For example, select *Delete R1* and confirm with *OK*.
- For example, select *Delete R1?* and confirm with *OK*.

The settings for the electricity-rate time selected will be reset.

- Confirm the message with *OK*.

The electricity-rate time will be deleted.

## Consumption (EcoFeedback)

You can set whether the water consumption is displayed for the selected program. This function shows the estimated consumption before a program sequence and the actual consumption after the end of the program.

In this menu you can also call up the total consumption of water for all the wash programs you have previously run on your dishwasher (see “EcoFeedback consumption display” under “Caring for the environment”).

### Displaying Consumption

- Select the *Display* menu option and confirm with *OK*.
- Select the setting you want and confirm with *OK*.

### Displaying Total consumption

- Select the *Total consumption* menu option and confirm with *OK*.
- You can display the total consumption via the *Water* menu option.

You can reset the value for the total consumption to 0.

- Select the *Reset* menu option and confirm with *OK*.
- Select the *Yes* menu option and confirm with *OK*.
- Confirm the message with *OK*.

The values are now reset to 0.

## Display brightness

You can set the display brightness to one of 7 different levels.

## Volume

A sequence of audible signals will sound at the end of the program or if there is a fault, provided that the audible signals have been activated.

### Audible signals in the event of a fault

In the event of a fault, the alarm tone will sound 4 times at intervals with a short pause between each set of tones.

The alarm tone that sounds when there is a fault cannot be deactivated.

### Audible signals

The audible signals at the end of a program will sound 4 times at intervals with a short pause between each signal.

The volume of the audible signals at the end of the program can be set to one of 7 different settings. If no volume is selected, the audible signals are turned off.

### Keypad tone

An audible tone sounds each time a sensor button is pressed.

The volume for the keypad tone can be set to one of 7 different settings. If no volume is selected, the keypad tone is turned off (except the  *On/Off* sensor button).

### Welcome melody

If you turn the dishwasher on or off, a brief melody will sound.

You can turn the melody off.

## Memory

When the *Memory* function is turned on, the most recently started program is saved.

When you turn the dishwasher off and back on again after the end of a program, the last program started will be selected. This may increase energy consumption.

## Refill reminders

If you only ever use combination detergent products or AutoDos using Miele PowerDisks (if available), you can turn off the refill reminders for reactivation salt and rinse aid if you wish.

Please make sure that if you stop using combination detergents, you refill the reactivation salt and rinse aid. Turn the refill reminders back on.

## AutoOpen

In some programs, the door automatically opens slightly to assist the drying process.

This function can be deactivated if you wish.



Risk of damage due to steam.

Steam from the dishwasher could damage the edges of delicate countertops when you open the door at the end of the program if the fan is no longer running.

If you have deactivated the automatic door-opening function but would like to open the door as soon as the program has finished, make sure that you open the door fully.

## BrilliantLight (depending on model)

This dishwasher is equipped with wash cabinet interior lighting.

When the door is open, the lighting turns off automatically after 15 minutes.

You can also turn off the wash cabinet interior lighting permanently.

## Software version

You can display the electronic software version of your dishwasher electronic for technical support purposes.

## Showroom program

For demonstration purposes only.

The dishwasher is equipped with a demo mode for showroom use.

## Factory default

You can reset all the machine settings to the factory default settings.

WiFi module settings (where applicable) have to be reset separately (see “Miele@home” under “Settings”).

## Machine settings

You can use this menu option to reset all dishwasher settings, except WiFi module settings, to the factory default settings.

## Prerequisites for sound emission tests

Load the dishwasher with **13 standard place settings** and use the *ECO* program.

## Setup for sound emission tests

The dishwasher must be set up according to the following specifications.

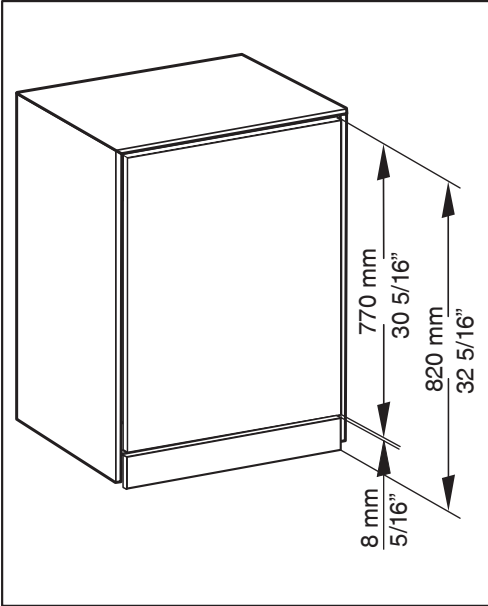

- Install the dishwasher into an analyzing unit.
- Secure the front panel.

## Sound emission tests

---

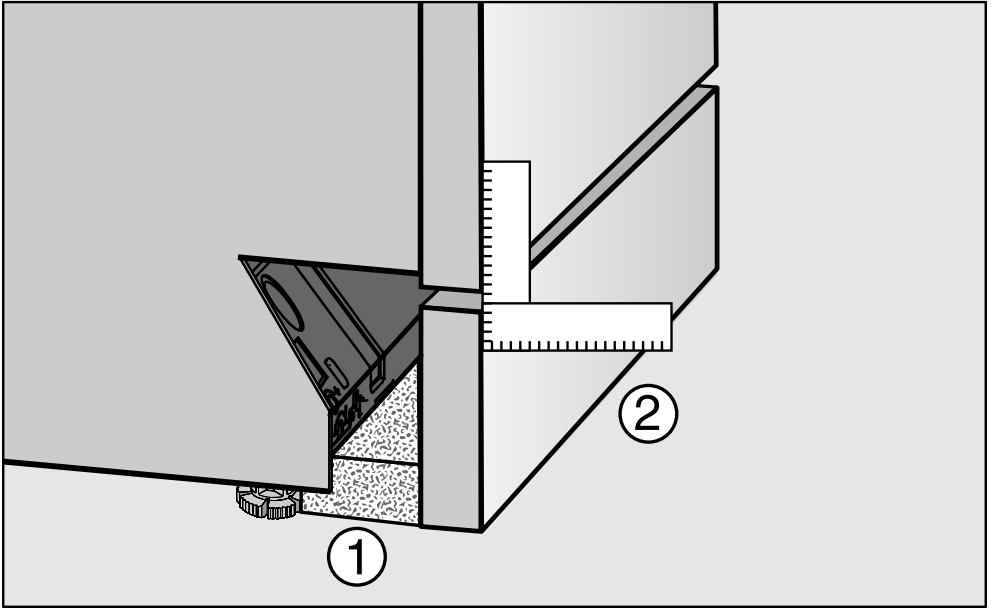

- Push the provided fleece strips (depending on model) under the toe-kick until it is flush with the appliance feet ①.
- Push the toe-kick into place in such a way that it is flush with the door front ②.

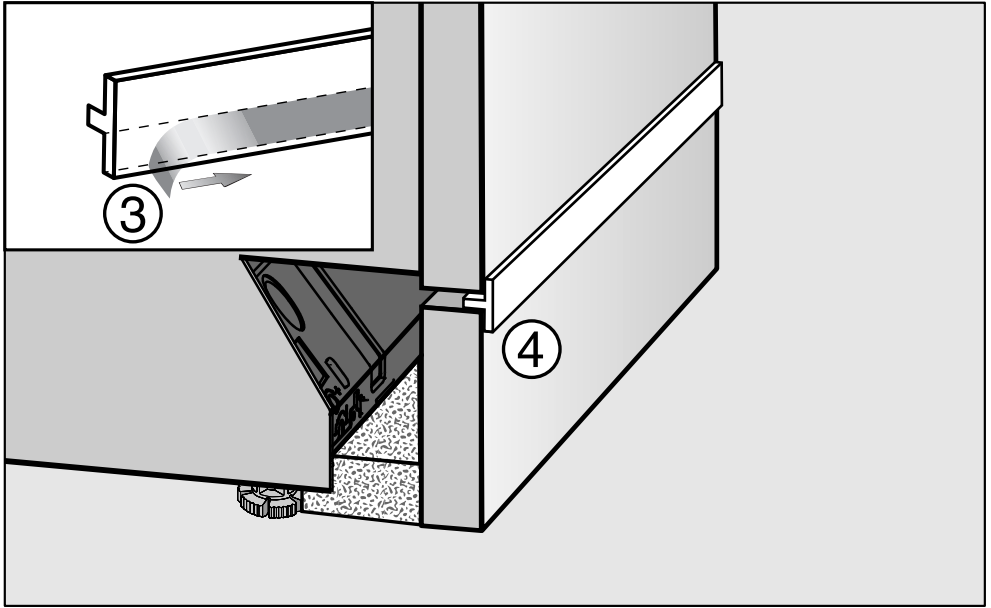

- Remove the protective film from the provided insulating strip (depending on model) ③.
- Push the insulating strip into the front top edge of the toe-kick ④.

# Miele

Please have the model and serial number  
of your machine available when  
contacting Technical Service.

---

## U.S.A.

**Miele, Inc.**

### National Headquarters

9 Independence Way  
Princeton, NJ 08540  
Phone: 800-991-9380  
[www.mieleusa.com/professional](http://www.mieleusa.com/professional)  
[prosales@mieleusa.com](mailto:prosales@mieleusa.com)

### Technical Service & Support

Phone: 800-991-9380  
[proservice@mieleusa.com](mailto:proservice@mieleusa.com)

## Canada

**Importer  
Miele Limited**

### Professional Division

161 Four Valley Drive  
Vaughan, ON L4K 4V8  
Phone: 1-888-325-3957  
[www.mieleprofessional.ca](http://www.mieleprofessional.ca)  
[professional@miele.ca](mailto:professional@miele.ca)

### Miele Professional Technical Service

Phone: 1-888-325-3957  
[serviceprofessional@miele.ca](mailto:serviceprofessional@miele.ca)



Manufacturer: Miele & Cie. KG  
Carl-Miele-Straße 29, 33332 Gütersloh, Germany