

Operating and installation instructions Downdraft extractor



To prevent the risk of accidents or damage to the appliance, it is **essential** to read these instructions before it is installed and used for the first time.

Contents

Caring for the environment	4
Warning and Safety instructions	5
Guide to the rangehood	12
Description of the functions	14
Recirculation mode Plug&Play	14
Before using for the first time	15
Selecting extraction mode or recirculation mode	15
Setting up Miele@home	16
Connecting via the App	16
Connecting via WPS	17
Signing out of Wi-Fi (reset to factory settings)	18
Setting up Con@ctivity	19
Con@ctivity via the home Wi-Fi network (Con@ctivity 3.0)	19
Con@ctivity via a direct Wi-Fi connection (Con@ctivity 3.0)	19
Reattempting the connection	20
Operation (automatic mode)	21
Cooking with Con@ctivity (automatic mode)	21
Cooking process	21
Leaving automatic mode temporarily	22
Returning to automatic mode	22
Operation (manual mode)	23
Cooking without Con@ctivity (manual mode)	23
Switching the fan on	23
Selecting the second Booster level	23
Selecting the run-on time	23
Switching the fan off	23
Run-on in Plug&Play operation	24
Switching on and dimming the cooktop lighting	24
Switching the cooktop lighting off	24
Retracting the deflector plate	25
Automatic retraction	25
Power management	25
Changing settings	26
Altering the grease filter operating hours counter	26
Altering or deactivating the charcoal filter operating hours counter	26
Deactivating Power management	27
Buzzer for the sensors	27
Energy saving tips	28

Cleaning and care	29
Housing.....	29
Important information for appliances with stainless steel surfaces	29
Grease filters and edge extraction panel	29
Removing the panel.....	31
Cleaning the drip tray.....	31
Inserting the panel.....	32
Resetting the grease filter operating hours counter	33
Change grease filters.....	33
NoSmell active charcoal filters.....	33
Resetting the charcoal filter operating hours counter	33
Disposing of the charcoal filters	33
Reactivatable charcoal filters	34
Problem solving guide	35
Service	36
Contact in case of fault.....	36
Position of the data plate	36
Warranty	36
Installation	37
Before installation	37
Installation materials.....	37
Appliance dimensions.....	38
Installation dimensions	39
Installation examples	44
Sealing the gaps	45
Connection for air extraction	46
Non-return flap.....	46
Electrical connection	47
Technical data	48
Optional accessory for recirculation mode.....	48

Caring for the environment

Disposal of the packing material

The transport and protective packaging has been selected from materials which are environmentally friendly for disposal, and can normally be recycled.

Recycling the packaging reduces the use of raw materials in the manufacturing process and also reduces the amount of waste in landfill sites.

Ensure that any plastic wrappings, bags etc. are disposed of safely and kept out of the reach of babies and young children. Danger of suffocation.

Only for Australia: Note for installer: Expanded polystyrene (EPS) packaging included. Please retain and dispose of EPS packaging responsibly. For further information, please contact Miele.

Disposing of your old appliance

Electrical and electronic appliances often contain valuable materials. They also contain specific materials, compounds and components, which were essential for their correct function and safety. These could be hazardous to human health and to the environment if disposed of with your domestic waste or if handled incorrectly. Please do not, therefore, dispose of your old appliance with your household waste.



Please dispose of it at your local community waste collection / recycling centre for electrical and electronic appliances. You are also responsible for deleting any personal data that may be stored on the appliance prior to disposal. Please ensure that your old appliance poses no risk to children while being stored prior to disposal.

Warning and Safety instructions

This rangehood complies with all relevant local and national safety requirements. However, inappropriate use can lead to personal injury and damage to property.

Read the operating and installation instructions carefully before using the rangehood. They contain important information on the safety, installation, use and maintenance of the appliance. This prevents both personal injury and damage to the rangehood.

In accordance with standard IEC 60335-1, Miele expressly and strongly advises that you read and follow the instructions in "Installation" and in the "Warning and Safety instructions".

Miele cannot be held liable for injury or damage caused by non-compliance with these instructions.

Keep these instructions in a safe place and pass them on to any future owner.

Correct application

- ▶ The appliance is not suitable for outdoor use.
- ▶ It must only be used to extract vapours and remove odours from cooking.

Any other usage is at the owner's risk. Miele cannot be held liable for damage resulting from incorrect or improper use or operation.

- ▶ This appliance is not intended for use by persons (including children) with reduced physical, sensory or mental capabilities, or lack of experience and knowledge, unless they have been given supervision or instruction concerning its use by a person responsible for their safety, and are able to recognise the dangers of misuse.

Safety with children

- ▶ Young children must not be allowed to use the rangehood.
- ▶ Older children may only use the rangehood if its operation has been clearly explained to them and they are able to use it safely. They must be able to understand and recognise the possible dangers caused by incorrect operation.
- ▶ Cleaning work may only be carried out by older children under the supervision of an adult.
- ▶ Children should be supervised near the appliance. Ensure that they do not play with the appliance.

Warning and Safety instructions

▶ Danger of suffocation! Whilst playing, children may become entangled in packaging material (such as plastic wrapping) or pull it over their head with the risk of suffocation. Keep packaging material away from children.

Technical safety

▶ Unauthorised installation, maintenance and repairs (including removal of any cover) can cause considerable danger for the user. Installation must be performed by a suitably qualified and competent person. Maintenance and repairs must only be carried out by a Miele authorised technician.

▶ A damaged appliance can be dangerous. Check it for visible signs of damage. Do not use a damaged appliance.

▶ The electrical safety of this appliance can only be guaranteed when continuity is complete between it and an effective earthing system. It is most important that this basic safety requirement is present and tested regularly and, where there is any doubt, the household wiring system should be inspected by a qualified electrician.

▶ Temporary or permanent operation with a self-sufficient or non-mains synchronous energy supply system (e.g. isolated networks, back-up systems) is possible. A requirement for the operation is that the energy supply system complies with all current local and national requirements that apply to stand-alone, solar and/or battery systems. The protective measures provided in the installation and in this Miele product must also be assured in their function and operation in isolated operation or in non-mains synchronous operation, or replaced with equivalent measures in the installation.

▶ The connection data (voltage and frequency) on the data plate of the rangehood must match the mains electricity supply in order to avoid the risk of damage to the rangehood.

Compare this before connecting the appliance to the mains electricity. If in doubt, consult a qualified electrician.

▶ Do not connect the appliance to the mains electricity supply by a multi-socket unit or an extension lead. Extension leads are a fire hazard and do not guarantee the required safety of the appliance.

▶ For safety reasons, this appliance may only be used after it has been built in.

▶ This rangehood must not be installed and operated in mobile installations (e.g. on a ship).

Warning and Safety instructions

▶ Tampering with electrical connections or components and mechanical parts is highly dangerous to the user and can cause operational faults.

Only open the housing as described in the instructions given in the installation sheet and in the “Cleaning and care” section of this booklet. Under no circumstances should any other parts of the housing be opened.

▶ The manufacturer's warranty will be invalidated if the appliance is not repaired by a Miele authorised service technician.

▶ If the mains connection cable is damaged, it must only be replaced by a Miele authorised service technician or suitably qualified and competent electrician in order to avoid a hazard.

▶ The lamps are a built-in component of the lighting. Replacement lamps may only be installed by a Miele authorised technician.

▶ During installation, maintenance and repair work, the appliance must be disconnected from the mains electricity supply. It is only completely isolated from the electricity supply when:

- the mains circuit breaker is switched off, or
- it is switched off at the wall socket and the plug is withdrawn from the socket. Do not pull the mains connection cable but the mains plug to disconnect your appliance from the mains electricity supply.

Warning and Safety instructions

Using at the same time as other heating appliances that depend on the air from the room

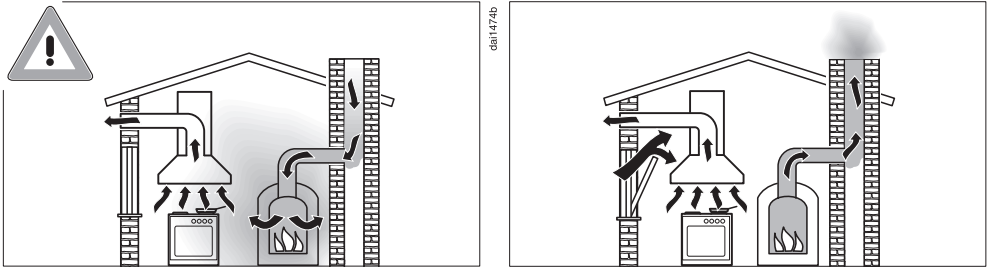

Danger of toxic fumes!

Great care should be taken when using the rangehood in the same room or the same area of the house as another heating appliance that depends on the air from the room.

Such heating appliances draw in air from the room and duct exhaust gases out through a chimney or extraction ducting. They include gas, oil, wood and coal-fired boilers and heaters, continuous flow or other water heaters, gas cooktops and ovens.

The rangehood draws in air from the kitchen and from neighbouring rooms. This applies to the following modes of operation:

- extraction mode
- recirculation mode with a recirculation box installed outside the room.

If there is insufficient air, an underpressure will occur. The heating appliance may be starved of oxygen. This impairs combustion. Harmful gases could be drawn from the chimney or extraction ducting back into the room.

This could have potentially fatal consequences. Risk of death!

Warning and Safety instructions

In order to ensure safe operation and to prevent gases given off by a heating appliance from being drawn back into the room, when the rangehood and the heater are both operated simultaneously, an underpressure in the room of 0.04 mbar (4 Pa) is the maximum permissible.

Sufficient ventilation can be maintained by air inlets which cannot be blocked, e.g. in windows, doors and outside wall vents. The diameter of the inlet openings must enable sufficient ventilation. A ventilation brick alone is not generally sufficient to ensure safe ventilation.

The overall ventilation condition of the dwelling must be taken into account. If in any doubt, the advice of a competent builder or, for gas, a qualified gas fitter (registered with an official gas safety body in accordance with national safety regulations) must be sought.

If the rangehood is being operated in recirculation mode, whereby the air is redirected into the room in which it is installed, the above restrictions do not apply.

Correct use

- ▶ Risk of crushing! Do not reach into the travel area of the deflector plate as it moves up or down.
- ▶ Open flames are a fire hazard!
Never use an open flame under the rangehood. To avoid the danger of fire, do not flambé or grill over an open flame. When switched on, the rangehood could draw flames into the filter. Kitchen grease deposits could ignite.
- ▶ Always switch the rangehood on when a cooking zone is in use, otherwise condensation may collect in the rangehood, which could cause corrosion.
- ▶ Overheated oil and fat can ignite, causing fire damage to the rangehood.
When cooking with oil or fat, chip pans and deep fat fryers etc., do not leave the pans unattended. Similarly, never leave an open grill unattended when grilling.
- ▶ Do not use the rangehood without the filters in place. This way you will avoid the risk of grease and dirt getting into the appliance and hindering its smooth operation.

Warning and Safety instructions

- ▶ There is a risk of fire if cleaning is not carried out as described in these operating instructions.
- ▶ The rangehood can get very hot during cooking due to heat rising from the cooktop.
Do not touch the housing or the grease filters until the rangehood has cooled down.

Correct installation

- ▶ To determine whether a rangehood may be operated above your cooking appliance, please refer to the information provided by the appliance's manufacturer.
- ▶ The downdraft extractor must not be installed next to solid fuel stoves.
- ▶ The rangehood must not be operated in combination with a gas cooktop.
- ▶ The distances given in "Installation" must be observed when fitting the downdraft extractor.
- ▶ All ducting, pipework and fittings must be of non-flammable material and comply with all relevant national and local building regulations.
- ▶ The appliance must not be connected to a chimney or vent flue which is in current use for exhausting fumes from appliances burning gas or other fuels. Neither should it be connected to ducting which ventilates rooms with fireplaces.
- ▶ If exhaust air is to be extracted into a chimney or ventilation duct no longer used for other purposes, seek professional advice.

Cleaning and care

- ▶ Do not use a steam cleaning appliance to clean this appliance. The steam could reach electrical components and cause a short circuit.
- ▶ In areas which may be subject to infestation by cockroaches or other vermin, pay particular attention to keeping the machine and its surroundings in a clean condition at all times. Any damage which may be caused by cockroaches or other vermin will not be covered by the machine warranty.

Accessories and spare parts

- ▶ Use only genuine original Miele spare parts. If spare parts or accessories from other manufacturers are used, the warranty will be invalidated, and Miele cannot accept liability.
- ▶ Faulty components must only be replaced by genuine Miele spare parts. The manufacturer can only guarantee the safety of the appliance when Miele replacement parts are used.
- ▶ Miele will guarantee to supply functional spare parts for a minimum of 10 years and up to 15 years following the discontinuation of your appliance.

Guide to the rangehood

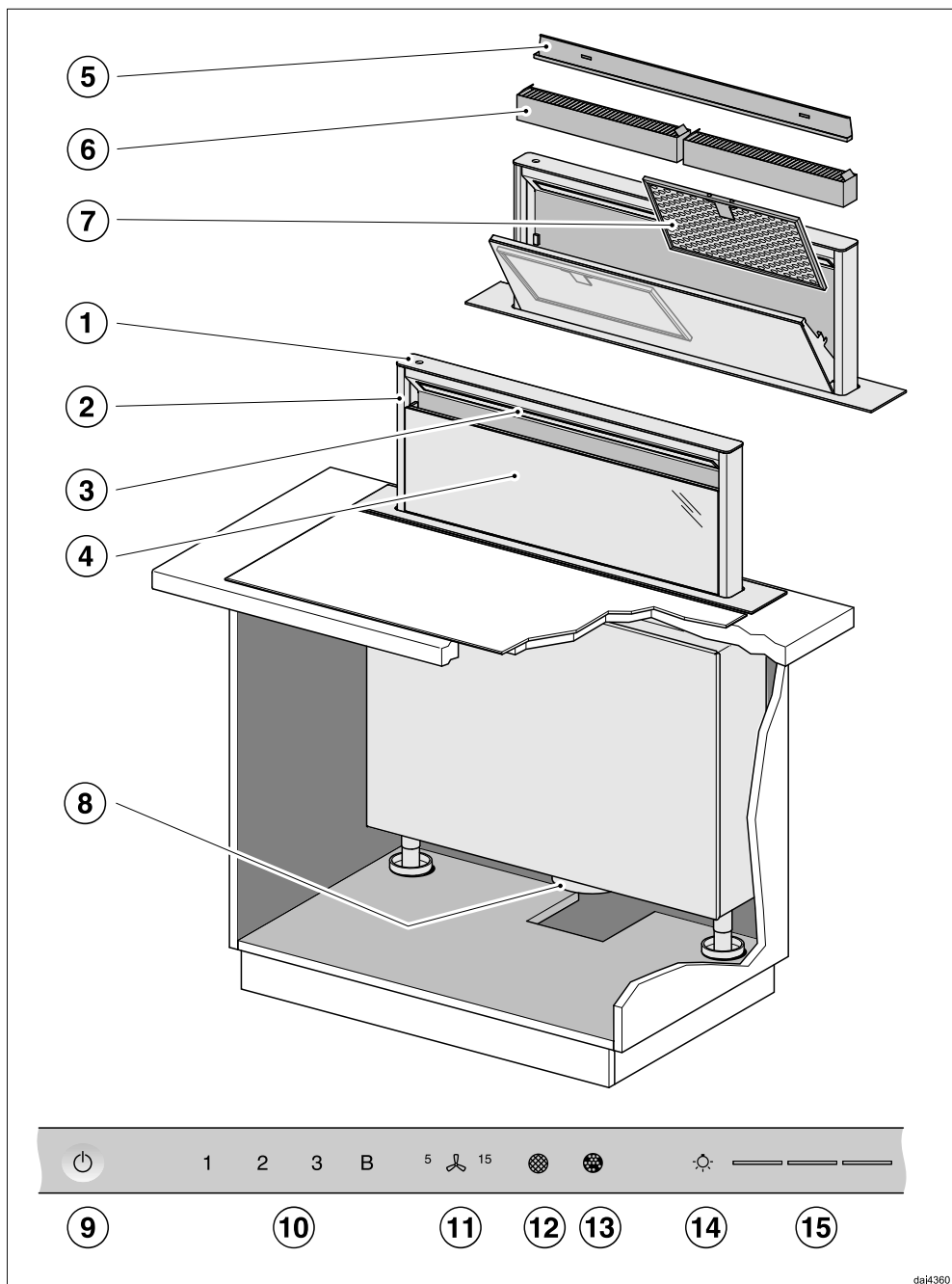

da14360

- ① Control panel
- ② Retractable deflector plate
- ③ Cooktop lighting
- ④ Edge extraction panel
- ⑤ Drip tray
- ⑥ Charcoal filter
Single-use or reactivatable charcoal filters
Optional accessory for recirculation mode
- ⑦ Grease filter
- ⑧ Exhaust connection
- ⑨ Sensor for switching the rangehood on and off
- ⑩ Sensors for switching the fan on and off and for setting the fan power level
- ⑪ Sensor for the run-on function
- ⑫ Sensor for the grease filter operating hours counter
- ⑬ Sensor for the charcoal filter operating hours counter
- ⑭ Sensor for switching the lighting on and off and for dimming the lighting
- ⑮ Sensors for selecting and displaying lighting levels

Description of the functions

Depending on the model of the rangehood, the following options are available:

Air extraction mode

The cooking vapours are drawn in by the rangehood. The air is then passed via the edge extraction panel through the grease filters, cleaned and then directed outside.

Recirculation mode

(with conversion kit and charcoal filter as optional accessories)

The air is drawn in via the edge extraction panel and cleaned first by the grease filters and then by charcoal filters. The air is then circulated back into the kitchen.

For recirculation operation, we recommend that the air is fed into the kitchen through a duct with an outlet, e.g. in the plinth panel.

Recirculation mode Plug&Play

If the installation space is not sufficient for an air duct, the air can also be guided into the plinth under the kitchen furniture in Plug&Play operation. Please follow the instructions in "Installation".



Selecting extraction mode or recirculation mode

The rangehood can be operated with either extraction mode or recirculation mode. The power of the fan is adapted to suit the selected mode of operation. The rangehood is set up at the factory for recirculation mode. It has to be reset for extraction mode.

To reset it for extraction mode, the operating hours counter for the charcoal filter(s) has to be deactivated.

- With the deflector plate retracted, touch the On/Off sensor .

All symbols light up with reduced brightness.

- Press and hold the run-on option control  until the grease filter  and charcoal filter  symbols light up.

- Touch the charcoal filter symbol .

The charcoal filter symbol  and one of the fan power levels will flash.

- Touch the **B** control.

- Confirm your choice by touching the charcoal filter sensor .

All the indicator lights will go out.

Extraction mode has now been set.



If you do not confirm your selection within 4 minutes, the rangehood will automatically revert to the previous setting.

Activating/Deactivating Plug&Play

- Touch the On/Off sensor .

All symbols light up with reduced brightness.

- Press and hold the run-on option control .

After a few seconds, the grease filter  and charcoal filter  symbols light up, and after a further 5 seconds the **1** fan power level indicator lights up.

The deflector plate extends.

- Then touch in turn

- the **1** control,

- the lighting control  and

- the lighting control .

When Plug&Play is deactivated, the indicators **1** and **3** will flash.

When Plug&Play is activated, the indicators **1** and **3** will light up constantly.

- To activate, touch **B**.

The **1** and **3** indicators light up constantly.

- Touch **1** to deactivate.

The **1** and **3** indicators will flash.

- Confirm the setting by pressing the run-on control .

All the indicator lights will go out.

If you do not confirm your selection of setting within 4 minutes, the rangehood will revert to the previous setting.

Before using for the first time

Setting up Miele@home

Prerequisites:

- a Wi-Fi network
- the Miele App
- a Miele user account. The user account can be created via the Miele App.

Your rangehood is equipped with an integrated Wi-Fi module. Connect the rangehood to your household Wi-Fi network. You will then be able to operate the rangehood via the Miele App.

If your Miele cooktop is connected to a home Wi-Fi network, you can control the rangehood automatically via the Con@ctivity function.

Before installing the rangehood in its final location, ensure that the signal of your Wi-Fi network is strong enough.

You can connect to the Wi-Fi network via the Miele@home App or via WPS.

Miele@home availability

The ability to use the Miele App depends on the availability of the Miele@home service in your country.

The Miele@home service is not available in every country.

For information about availability, please visit www.miele.com.

Miele App

You can download the Miele App from the Apple App Store® or the Google Play Store™ free of charge (only functional in selected countries).



Connecting via the App

The Miele App can be used to connect to your network.

- Install the Miele App on your mobile device.

To log in you will need:

1. Your Wi-Fi network password
2. Your rangehood password



The password for your rangehood consists of the last nine digits of the serial number, which can be found on the appliance's data plate.

The data plate can be found on the front of the housing.



- Start the appliance registration in the App. Follow the login steps.



If requested to activate Wi-Fi on the rangehood, proceed as follows:

Before using for the first time

- With the deflector plate retracted, touch the On/Off sensor .

All symbols light up with reduced brightness.



- Press and hold the run-on option control  until the grease filter  and charcoal filter  symbols light up.

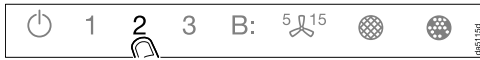

- Touch the **2** control.

The deflector plate extends.



2 will light up constantly, **3** will flash on and off.

The rangehood is ready for connection during the next two minutes.

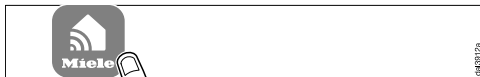

- Follow the instructions in the App.

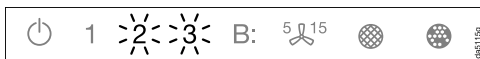

When successfully connected **2** and **3** will light up constantly.



- Quit connection mode on the rangehood by touching the run-on control .

The rangehood can now be operated via the App.



Connecting via WPS

Your Wi-Fi router must support WPS (Wi-Fi Protected Setup).

- With the deflector plate retracted, touch the On/Off sensor .

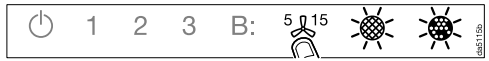
All symbols light up with reduced brightness.



- Press and hold the run-on option control  until the grease filter  and charcoal filter  symbols light up.



- Touch the **2** control.

The deflector plate extends.



2 will light up constantly, **3** will flash on and off.

The Wi-Fi connection must be started on the rangehood at the same time as on the Wi-Fi router.



- Press the **B** control on the rangehood after a few seconds.

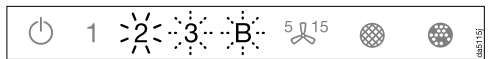

After a short while **2** will light up constantly, and **3** and **B** will flash on and off.

The rangehood is ready for connection during the next two minutes.

Before using for the first time

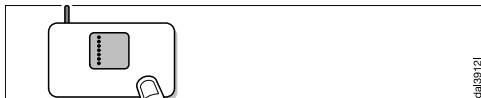

- Start the WPS connection on your Wi-Fi router.

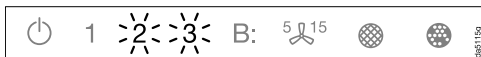

When successfully connected **2** and **3** will light up constantly.

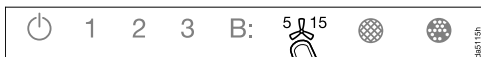

- Quit connection mode on the rangehood by touching the run-on control **5**.

The rangehood can now be operated via the App.

If the connection fails, you have probably not connected WPS on your router quickly enough. Repeat the steps above.

Useful tip: If your Wi-Fi router does not support WPS, please connect via the Miele App.

Signing out of Wi-Fi (reset to factory settings)

To set up a new Wi-Fi connection, the existing Wi-Fi connection must first be disconnected.

- With the deflector plate retracted, touch the On/Off sensor **1**.

All symbols light up with reduced brightness.



- Press and hold the run-on option control **5** until the grease filter **5** and charcoal filter **B** symbols light up.



- Touch the **1** control.

The deflector plate extends.

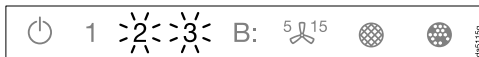

With an existing Wi-Fi connection **2** and **3** will light up constantly.

The rangehood is ready for disconnection during the next two minutes.



- Touch the **1** control.



2 will light up constantly, **3** will flash on and off.

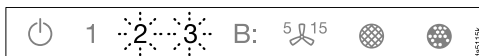

After a few seconds **2** and **3** will flash on and off. The connection has now been disconnected.



- Quit disconnection mode on the rangehood by touching the run-on control **5**.

The Wi-Fi connection has been disconnected. A new connection can now be set up.

Before using for the first time

Setting up Con@ctivity

Con@ctivity is the direct communication system between an electric Miele cooktop and a Miele rangehood. It enables the rangehood to operate automatically depending on the operational state of a Miele cooktop with onset controls.

- When the cooktop is switched on, the cooktop lighting on the rangehood comes on independently and, after a short time, the fan also switches on.
- The rangehood selects the power level automatically during cooking. The power level selected by the rangehood depends on the number of cooking zones being used and their power levels.
- After switching the cooktop off, the fan and the cooktop lighting will switch off automatically after a specified period of time.

See “Operation” for detailed information about this function.

Con@ctivity via the home Wi-Fi network (Con@ctivity 3.0)

Prerequisites:

- Home Wi-Fi network
- Wi-Fi enabled Miele cooktop

- Connect the rangehood and cooktop to your home Wi-Fi network (see "Setting up Miele@home").

The Con@ctivity function will be activated automatically.

Con@ctivity via a direct Wi-Fi connection (Con@ctivity 3.0)

Prerequisite:



- Wi-Fi enabled Miele cooktop

If you do not have a home network, you can establish a direct connection between the cooktop and the rangehood.

- With the deflector plate retracted, touch the On/Off sensor .

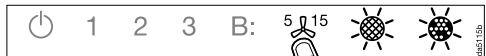
All symbols light up with reduced brightness.



- Press and hold the run-on option control  until the grease filter  and charcoal filter  symbols light up.

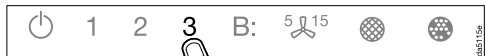

- Touch the **3** control.

The deflector plate extends.

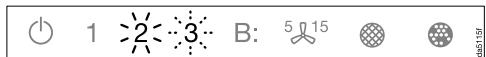

2 will light up constantly, **3** will flash on and off.

Before using for the first time

The rangehood is ready for connection during the next two minutes.

- Start the Wi-Fi connection on the cooktop. For further details, see the cooktop operating instructions.

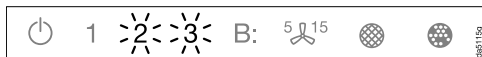

When successfully connected **2** and **3** will light up constantly.

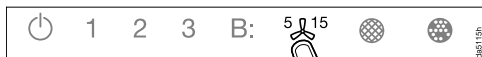

- Quit connection mode on the rangehood by touching the run-on control **5 15**.

Con@ctivity has now been activated.

With a direct Wi-Fi connection, it is not possible to connect the cooktop and the rangehood to a home network. Should this be required at a later date, the direct Wi-Fi connection between the cooktop and the rangehood must be disconnected first (see "Signing out of Wi-Fi").

Reattempting the connection

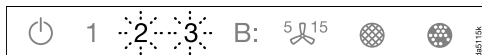

If it is not possible to connect, **2** and **3** flash or the rangehood cancels the process.

- Disconnect the connection to the rangehood (see "Signing out of Wi-Fi") and to the cooktop.
- Attempt to make the connection again.

Operation (automatic mode)

Risk of crushing!

Do not reach into the travel area of the deflector plate as it moves up or down.

When Con@ctivity is active, the rangehood always operates in automatic mode (see “Before using for the first time – Setting up Con@ctivity”).

If you wish to manually operate the rangehood, see “Operation (manual mode) – Cooking without Con@ctivity”.

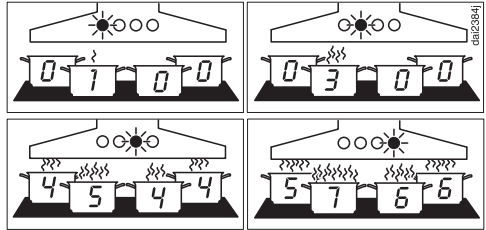

Examples for power levels 1 to 8

Cooking with Con@ctivity (automatic mode)

- Switch on a cooking zone at any power level.

The deflector plate extends.

The cooktop lighting will come on.

After a few seconds the fan will switch on, first at power level 2, then it will switch immediately to power level 1.

The rangehood selects the power level automatically during cooking.

This is determined by the total output of the cooktop, i.e. the number of cooking zones in operation and the power levels selected.

- If you select a higher power level on the cooktop or are using several cooking zones, the rangehood will switch to a higher power level.
- When you reduce the power level on the cooktop or the number of cooking zones being used, the rangehood power level will also be reduced.

Reaction time

The rangehood reacts with a slight delay because altering the power level on the cooktop does not immediately result in a reduction or increase in cooking vapours.

Because the cooktop transmits the information to the rangehood at intervals, this can also cause delays.

The reaction can vary from a few seconds to a few minutes.

Cooking process

- For example, you switch on a cooking zone at the highest power level to heat a pan for frying. After approx. 10 seconds to 4 minutes, you then reduce the power level (60 seconds to 5 minutes for a radiant cooktop).

The rangehood recognises a cooking process.

The rangehood switches itself on and when the cooktop power level has been reduced, the rangehood switches to power level 3 and remains at that level for approx. 5 minutes.

After that the rangehood power level is determined automatically by the Con@ctivity function.

You can select another power level manually before then.

Operation (automatic mode)

Switching off

- Switch off all cooking zones.

The power level is gradually reduced until the fan finally switches off.

This helps to neutralise any lingering vapours and odours in the air.

Depending on the last active fan level, the process takes 2 to 5 minutes.

30 seconds after the fan is switched off, the cooktop lighting switches off.

The deflector plate retracts 1 minute later.

The cooking process is finished.

Leaving automatic mode temporarily

To leave automatic mode temporarily during cooking:

- Manually select a different power level, or
- Manually switch the rangehood off, or
- Activate the run-on function  on the rangehood. The fan will switch itself off after the selected run-on time, and the lighting will remain on.

The rangehood functions are now operated manually (see “Operation (manual mode)”).

If you switch off the fan manually in Plug&Play mode, it continues to run at level 1 (see “Operation (Manual mode) – Switching off the fan”).

Returning to automatic mode

The rangehood returns to automatic mode:

- if the rangehood has not been used for approx. 5 minutes after selecting a power level manually, or

- if the manually selected power level corresponds to the automatic one again, or
- the rangehood fan and the cooktop have been switched off for at least 30 seconds.
Automatic mode will resume next time the cooktop is switched on.

You can also operate the rangehood manually for a complete cooking process.

- To do so switch the rangehood fan on **before** the cooktop.

If the rangehood fan and the cooktop have been switched off for at least 30 seconds after cooking, automatic mode will resume next time the cooktop is switched on.

Risk of crushing!

Do not reach into the travel area of the deflector plate as it moves up or down.

Cooking without Con@ctivity (manual mode)

The rangehood can be operated manually if:

- the Con@ctivity function is not activated.
- You have temporarily deactivated the Con@ctivity function (see “Operation (manual operation) – Leaving automatic mode temporarily”).

Switching the fan on

Select power levels **1** to **3** for light to heavy cooking vapours, odours or build-up of heat.

Increase the power level as the level of vapours, odours or heat increases.

For short periods of cooking food with intense vapours, odours or heat, e.g. when searing meat, select the Booster setting **B**.

- With the deflector plate retracted, touch the On/Off sensor .

All symbols light up with reduced brightness.

- Touch one of the controls **1** to **B**.

The deflector plate extends.

The fan switches to the desired level.

Selecting the second Booster level

- When you select the Booster level, the **B** symbol lights up. To increase the power level further, touch **B** again.

The **B** symbol lights up.

The second Booster level is activated. The air throughput is increased for a short time.

Switching back the Booster levels

If Power management is activated (default setting), the first Booster level **B** automatically switches back to level **3** after 5 minutes.





The second Booster level **B** switches back after 2 minutes (even if Power management is deactivated).

Selecting the run-on time

It is advisable to run the fan for a few minutes after cooking has finished. This helps to remove any lingering vapours and odours from the air.

It also reduces the risk of residues accumulating in the rangehood and any resultant odours.

The run-on function allows the fan to continue to run for a pre-determined time before switching itself off automatically.

- After you have finished cooking, touch the run-on control  with the fan still switched on:
 - Once: the fan will switch itself off after 5 minutes (**5**  lights up).
 - Twice: The fan will switch itself off after 15 minutes ( **15** lights up).
 - If you touch the run-on control  again, the fan will remain switched on ( will go out).

Switching the fan off

- Touching the control for the active power level again switches the fan off.

The deflector plate remains extended.

Operation (manual mode)

Run-on in Plug&Play operation

If you switch off the fan in Plug&Play mode, it will run on at level **1**.

Run-on ensures that the plinth is ventilated after cooking.

Depending on the last active fan level, run-on lasts between 2 and 30 minutes.

You can switch off the fan immediately during run-on by pressing **1** or the On/Off sensor .

This function is independent of the run-on function .

Switching on and dimming the cooktop lighting

The cooktop lighting can be switched on and off and dimmed independently of the fan.



- With the deflector plate retracted, touch the On/Off sensor .

All symbols light up with reduced brightness.

- Touch the lighting control  briefly.

The deflector plate extends.

The lighting will switch on at maximum brightness. All 3 bars next to the lighting control  light up.

- To change the brightness, press and hold the lighting control  with the lighting switched on. The brightness will gradually dim until you release the control.
- To increase the brightness, press and hold the lighting control  again until the desired level has been reached and then release it.
- Alternatively, you can select 3 brightness levels by touching the bars next to the lighting control .

Switching the cooktop lighting off

- Touching the lighting control  again switches the cooktop lighting off.

The deflector plate remains extended.

Retracting the deflector plate

- Touch the On/Off sensor .

The fan and the cooktop lighting are switched off.

All symbols go out.

The deflector plate retracts.

Automatic retraction

If you switch off the fan and the lighting when the deflector plate is extended, the deflector plate will automatically retract after 1 minute.

Power management

The rangehood is fitted with a Power management system. The Power management system is designed to help save energy. It ensures that the fan power level is reduced automatically and that the lighting is switched off.

- If the Booster setting has been selected, the fan will automatically switch to setting 3 after 5 minutes.
- From fan power levels 3, 2 and 1, the power will be reduced by one level after 2 hours and then in 30-minute stages until the fan finally switches off.
- The cooktop lighting will switch off automatically after 12 hours.

Changing settings

All settings are made with the rangehood switched off.

- Switch off the fan and the lighting and retract the deflector plate.

Altering the grease filter operating hours counter



You can set the operating hours counter to suit the type of cooking you do.

The factory setting is a cleaning interval of 30 hours.

- Select a shorter time of 20 hours if you fry a lot.
- If you only cook occasionally, we recommend that you still select a short time for the counter. This is to prevent grease from hardening on the filter and making cleaning more difficult.
- Select a longer time of 40 or 50 hours if you use very little fat for cooking.

- Touch the On/Off sensor .

All symbols light up with reduced brightness.

- Press and hold the run-on option control  until the grease filter  and charcoal filter  symbols light up.

- Touch the grease filter symbol .

The grease filter symbol  and one of the fan power level indicators will flash.

The fan power level indicators **1** to **B** show the time set:

- 1**..... 20 hours
- 2**..... 30 hours
- 3**..... 40 hours
- B**..... 50 hours

- Touch the relevant control to select the duration required.

- Confirm your choice by touching the grease filter control . If you do not confirm your selection within 4 minutes, the rangehood will automatically revert to the previous setting.

Altering or deactivating the charcoal filter operating hours counter

Charcoal filters are needed for recirculation mode.



You can set the operating hours counter to suit the type of cooking you do.

It has to be deactivated for extraction mode.

It is set at the factory for 180 hours of use before the filters need replacing.

- Touch the On/Off sensor .

All symbols light up with reduced brightness.

- Press and hold the run-on option control  until the grease filter  and charcoal filter  symbols light up.

- Touch the charcoal filter symbol .

The charcoal filter symbol  and one of the fan power levels will flash.

The fan power level indicators **1** to **B** show the time set:

- 1**..... 120 hours
- 2**..... 180 hours
- 3**..... 240 hours
- B**..... deactivated

- Touch the relevant control to select the duration required.

- Confirm your choice by touching the charcoal filter sensor . If you do not confirm your selection within

4 minutes, the rangehood will automatically revert to the previous setting.

Deactivating Power management



Keep in mind that deactivating this function may increase energy consumption.

Activating/deactivating Power management



- Touch the On/Off sensor .

All symbols light up with reduced brightness.

- Press and hold the run-on option control .

After a few seconds, the grease filter  and charcoal filter  symbols light up, and after a further 5 seconds the **1** fan power level indicator lights up.

The deflector plate extends.

- Then touch in turn
 - the lighting control ,
 - the **1** control and then again
 - the lighting control .

When Power management is activated, the **1** and **B** indicators light up constantly.

When it is deactivated, the **1** and **B** indicators flash.

- To deactivate Power management, touch **1**.

The **1** and **B** indicators will flash.

- To activate, touch **B**.

The **1** and **B** indicators will light up constantly.

- Confirm the setting by pressing the run-on control .

All the indicator lights will go out.

If you do not confirm your selection of setting within 4 minutes, the rangehood will revert to the previous setting.



Buzzer for the sensors

When a function is selected with the sensors, a short buzzer will sound for confirmation.

The buzzer can be switched off.

- Touch the On/Off sensor .

All symbols light up with reduced brightness.

- Press and hold the run-on option control  until the grease filter  and charcoal filter  symbols light up.

- Touch the **B** control.

The buzzer is switched off.

- If you want to switch the buzzer on again, proceed in the same way.

Regardless of the previous setting, the buzzer will be reactivated when power is restored to the rangehood after it has been disconnected from the mains electricity supply or after a power cut.

Energy saving tips

This rangehood operates very efficiently and economically. The following will help you to save even more energy when using it:

- Ensure that there is sufficient ventilation in the kitchen when cooking. In extraction mode, if there is insufficient air flow the rangehood cannot operate efficiently and this causes increased operating noise levels.
- Always cook with the lowest possible setting. This produces fewer cooking vapours, so you can use a lower rangehood power level and therefore benefit from reduced energy consumption.

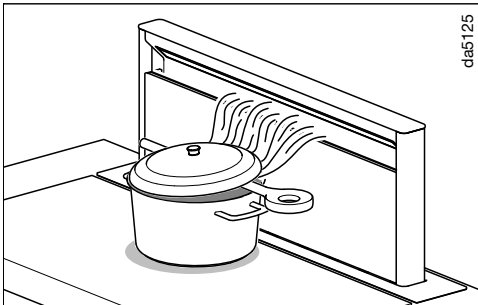

- If strong cooking vapours are produced during cooking, place the cookware as close as possible to the rangehood.

Whenever possible, keep pots and pans covered while cooking. This prevents heat escaping unnecessarily.

If you are cooking with open pots, put a lid on at an angle. For example, place a cooking spoon between the pot and the lid. The deflection of the cooking vapours in the direction of the extractor ensure optimal extraction.

- Clean or change the filters at regular intervals. Heavily soiled filters reduce performance, increase the risk of fire and are unhygienic.
- Use the Con@ctivity function. The rangehood will switch on and off automatically. The rangehood will select the optimum power level for the cooking you are doing, which ensures low energy consumption.
- If you are operating the rangehood manually, please note the following:
 - Check the power level selected on the rangehood. A low power level is usually sufficient. Only use the Booster setting when necessary.
 - When a large volume of cooking vapours are being produced, switch to a high power level in good time. This is more efficient than operating the rangehood for longer to try to capture cooking vapours which have already been distributed throughout the kitchen.
 - Make sure that you switch the rangehood off after use. If cooking vapours and odours still need to be removed from the kitchen air after cooking, use the run-on function. The fan will switch off automatically after the selected run-on time.

Housing

General information

Unsuitable cleaning agents can damage the surfaces and control elements.

Do not use any cleaning agents containing soda, acid, chloride, or solvent.

Do not use any abrasive cleaning agents, e.g. powder cleaners or cream cleaners and abrasive sponges, or pot scourers or sponges which have been used previously with abrasive cleaning agents.

 Moisture in the rangehood can cause damage.

Make sure that water does not get into the rangehood.

- Clean all surfaces and control elements using a small amount of warm water and dishwashing liquid. Apply with a soft sponge.
- After cleaning, wipe the surfaces dry using a soft cloth.

Important information for appliances with stainless steel surfaces

Stainless steel surfaces can be cleaned with a non-abrasive cleaning agent designed specifically for use on stainless steel.

To prevent the surfaces from quickly becoming dirty again, we recommend treating them with a stainless steel care product (available from Miele).

Important for appliances with glass surfaces

- Glass surfaces can be cleaned using a proprietary non-abrasive cleaning agent designed specifically for use on glass.

Grease filters and edge extraction panel

 Fire hazard!

Oversaturated grease filters are a fire hazard.

Clean the grease filters at regular intervals.

The edge extraction panel and the re-usable metal grease filters in the appliance remove solid particles (grease, dust, etc.) from the kitchen vapours, preventing soiling of the rangehood.

The grease filters and the panel must be cleaned at regular intervals.

Heavily soiled grease filters hinder air extraction and will lead to increased levels of soiling in the rangehood and in the kitchen.

Grease filter cleaning intervals



Grease which has collected in the rangehood hardens over time and makes cleaning more difficult. It is therefore recommended that the edge extraction panel and the grease filters should be cleaned regularly (at least every 3–4 weeks) to avoid a build-up of grease.

The operating hours counter reminds you to clean the edge extraction panel and the grease filters regularly via the grease filter symbol  which will light up.

Cleaning and care

Removing the panel and grease filters

Opening the panel

- With the deflector plate retracted, touch the On/Off sensor .
- Touch the lighting control  briefly.

The deflector plate extends.



Risk of crushing!

If you switch off the fan and the lighting when the deflector plate is extended, the deflector plate will automatically retract after 1 minute. Risk of injury. Risk of damage to the opened panel.

To prevent the deflector plate from retracting, leave the lighting switched on.

The panel is held in place by magnets.

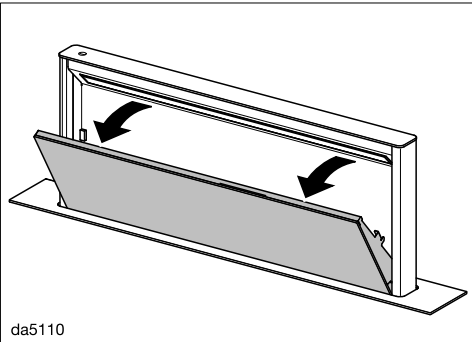

- Pull the top of the panel forwards and swing it open.

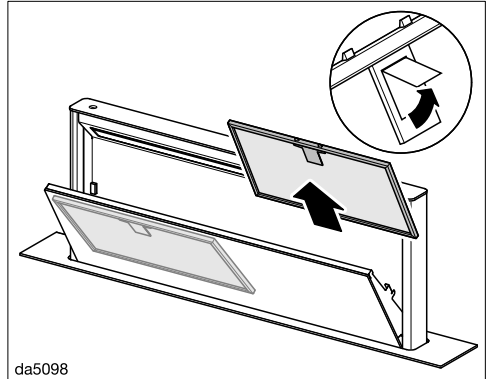

- Open the grease filter retainer catch and remove them.

Cleaning the grease filters by hand

- Clean the filters with a soft nylon brush in a mild solution of hot water and a small amount of washing-up liquid. Do not use undiluted washing up liquid.

Unsuitable cleaning agents

Unsuitable cleaning agents can cause damage to the surface of the filters if used regularly.

Do not use:

- cleaning agents containing descaling agents,
- powder cleaners or cream cleaners,
- aggressive all-purpose cleaning agents or spray cleaners for grease,
- oven sprays.

Cleaning the grease filters in the dishwasher

 Risk of damage due to excessively high temperatures in the dishwasher.

Excessively high temperatures may cause the grease filters to become unusable, if they become deformed, for example.

Select a programme that does not exceed the recommended temperature.

Also follow the information provided in the operating instructions for the dishwasher.

- Place the grease filters upright or slightly inclined in the lower basket. Ensure the spray arm is not obstructed.
- Use a standard household cleaning detergent.
- Select a programme with a maximum wash temperature of 65 °C.

Depending on the detergent used, the internal filter surfaces may become discoloured. This will not affect the functioning of the grease filters in any way.

- After cleaning, leave the filters to dry on an absorbent surface before refitting them.

Removing the panel

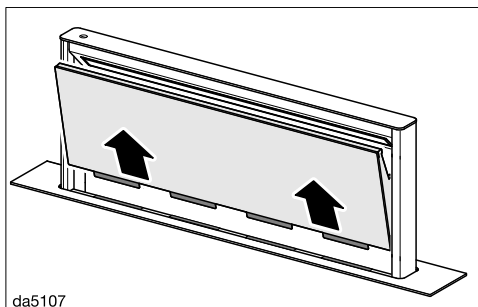

- Pull the opened panel up and out to remove it and place it on a soft surface.

Cleaning the panel

- Follow the instructions under “Housing”.

The panel is not suitable for cleaning in a dishwasher.

- When removing the filters and panel for cleaning, also clean off any residues of oil or fat from the now accessible housing to prevent the risk of these catching fire.

Cleaning the drip tray

Condensate collects in the drip tray underneath the grease filters. The drip tray can be removed for cleaning.

Cleaning and care

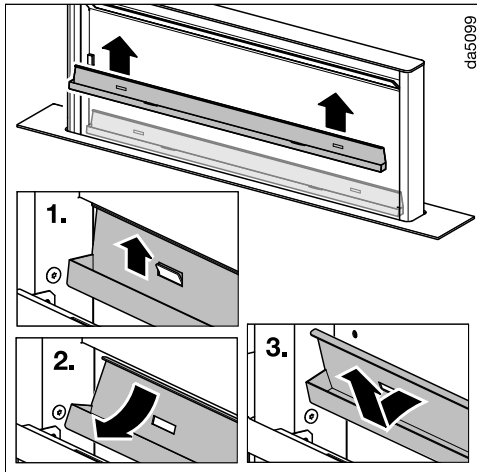

- Carefully pull the drip tray up and out of the holders. Pour away any condensate that has collected in it and then clean the tray with a damp cleaning cloth.

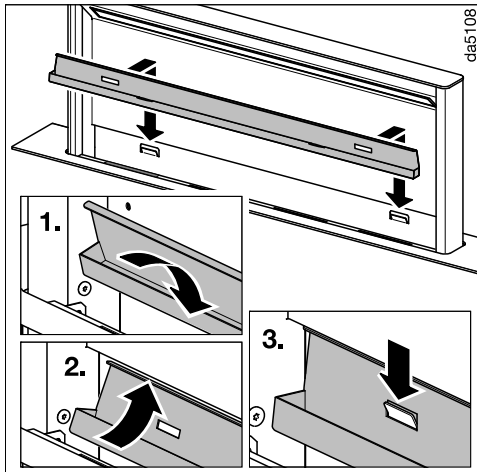

- Hook the drip tray back into the holders after cleaning.

Inserting the panel

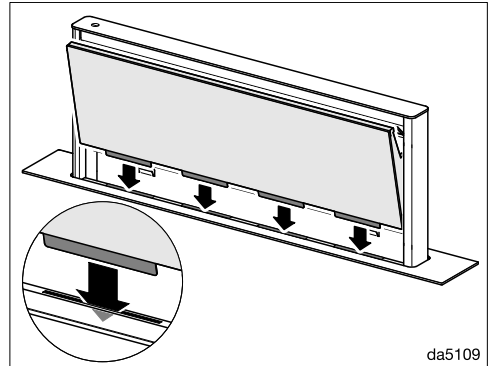

- Insert the panel into the slots on the deflector plate.
- Refit the grease filters. When inserting the grease filters, make sure that the latch faces outwards.

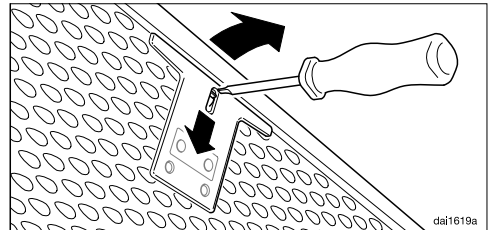

- If a grease filter is inadvertently fitted upside down, insert a small screwdriver blade into the slit to disengage the clip.
- Swing the panel closed until the magnets hold it in place.

Resetting the grease filter operating hours counter

After cleaning, the operating hours counter needs to be reset.

- While the fan is switched on, press the grease filter control  for approx. 3 seconds until only **1** is flashing.

The grease filter symbol  goes out.

Change grease filters

Regular use and cleaning can cause the filter surfaces to wear.

If you notice any damage, replace the grease filters.

You can obtain grease filters from Miele customer service (see end of these operating instructions) or from your Miele specialist dealer.

NoSmell active charcoal filters

With recirculation mode, two charcoal filters must be fitted in addition to the grease filters. These are designed to absorb cooking odours.

Charcoal filters are available to order via the Miele online shop (see the end of this booklet for contact details) or directly from Miele.

The part number of the charcoal filter required is listed under “Technical data”.

Fitting/Replacing the charcoal filters

- Remove the panel and remove the drip tray as previously described.
- Take the charcoal filters out of their packaging.

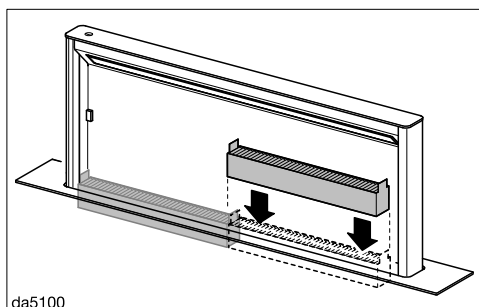

- Insert the charcoal filters into the deflector plate. Make sure the tabs are facing up.
- Refit the drip tray and the panel.

When to change the NoSmell active charcoal filters

Replace the charcoal filters when they no longer absorb kitchen odours effectively, or at least every 6 months.

The operating hours counter will remind you to replace the charcoal filters by lighting up the charcoal filter symbol .

Resetting the charcoal filter operating hours counter

After changing the charcoal filters, the operating hours counter needs to be reset.

- Touch the charcoal filter control  for approx. 3 seconds with the rangehood switched on until only the indicator light for level **1** is flashing.

The charcoal filter symbol  goes out.

Disposing of the charcoal filters

- Used charcoal filters can be disposed of with the normal household waste.

Cleaning and care

Reactivatable charcoal filters

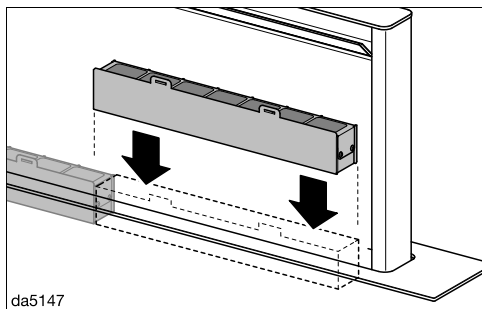

da5147

Reactivatable charcoal filters are available for this rangehood. They can be used several times after being reactivated in the oven.



Please follow the operating instructions supplied with the filter.

Problem solving guide

Many malfunctions and minor faults that can occur in daily operation can be corrected without contacting Miele. This will save you time and money because you will not need a service call.

You can find information on how to remedy faults yourself at www.miele.com.au/service or www.miele.co.nz/service and on the Miele website.

Please note, however, that a call-out charge will be applied to unnecessary service visits where the problem could have been rectified as described in these operating instructions.

Problem	Possible cause and remedy
The deflector plate stops while extending.	The deflector plate is blocked by a heavy object, for example. If the deflector plate is blocked when it is extended, it retracts a little and stops. ■ Touch the On/Off sensor  . The deflector plate extends and then retracts.
The deflector plate stops while retracting.	An object has become lodged in the deflector plate. If the deflector plate is blocked during retraction, it extends a little and stops. ■ Touch the On/Off sensor  . ■ Switch on the fan or the lighting. The deflector plate extends.

Service

You can find information on how to remedy faults yourself and about Miele spare parts at www.miele.com.au/service or www.miele.co.nz/service.

Contact in case of fault

In the event of any faults which you cannot remedy yourself, please contact Miele.

You can book a Miele customer service call-out online at www.miele.com.au/service or www.miele.co.nz/service.

Contact information for Miele can be found at the end of this booklet.

Please quote the model and serial number of your appliance when contacting Miele. This information can be found on the data plate.

Position of the data plate

The data plate can be found on the front of the housing.

Warranty

The manufacturer's warranty for this appliance is 2 years.

For further information, please refer to your warranty booklet.

Before installation

 Before installation, it is important to read the information given on the following pages as well as the “Warning and Safety instructions” at the beginning of this booklet.

Installation materials



08005672

6 screws, M4 x 8 mm



011056271

8 screws, 4 x 15 mm



11597030

2 screws, M4 x 100 mm

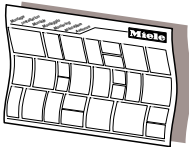

dha3mle

Installation plan

See the installation plan for details on the individual steps involved in the installation of this appliance.

Installation

Appliance dimensions

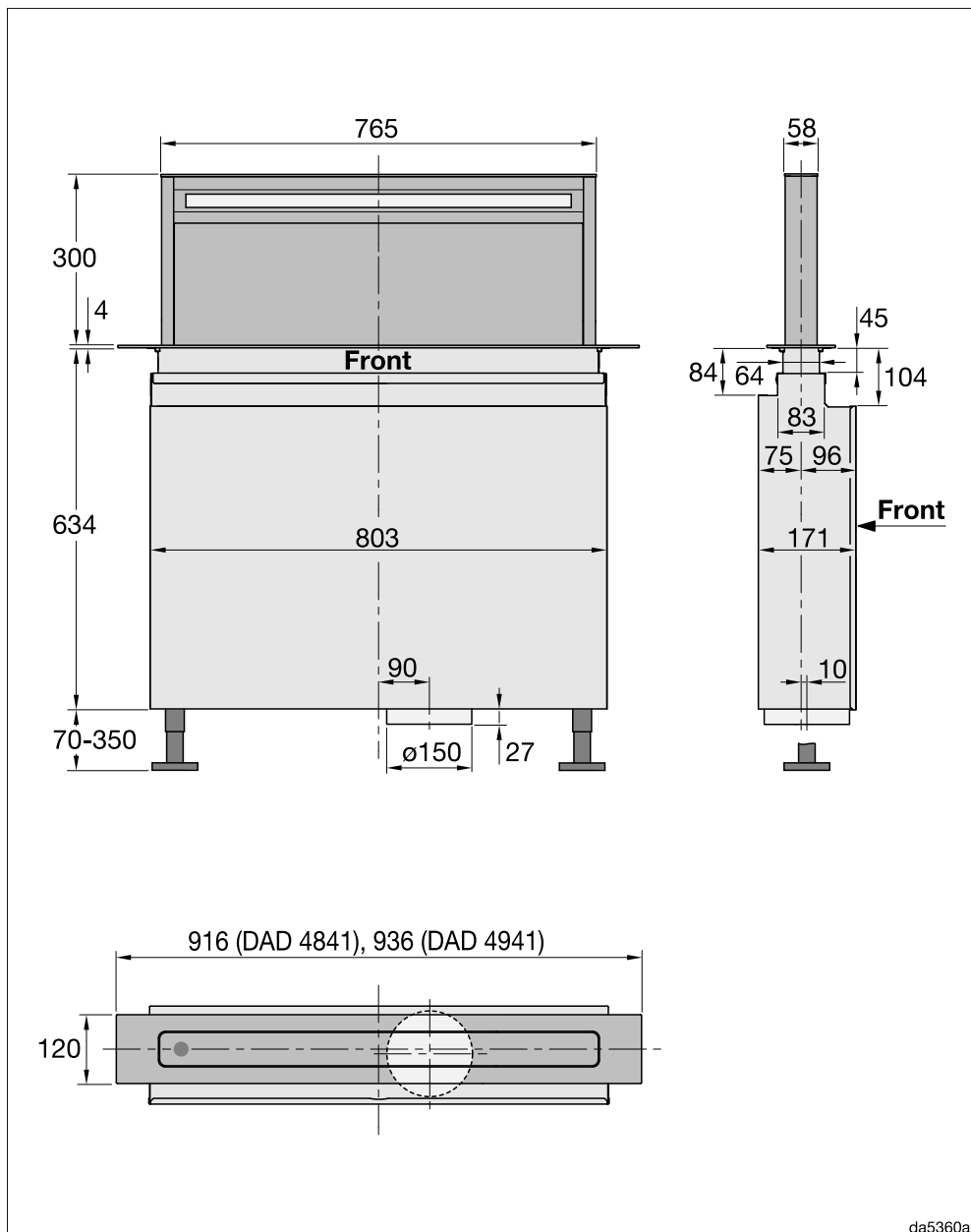

da5360a

Installation dimensions

 Risk of heat damage.

The rising heat generated by a gas cooktop may damage the rangehood. The rangehood must not be operated in combination with a gas cooktop.

If you are planning to install an oven/cooker in front of the appliance, the appropriate installation advice and dimensions regarding cool air circulation must be observed.

Make sure that the installation location is easily accessible. The rangehood must also be freely accessible and located such that it can be dismantled in the event of future service requirements.

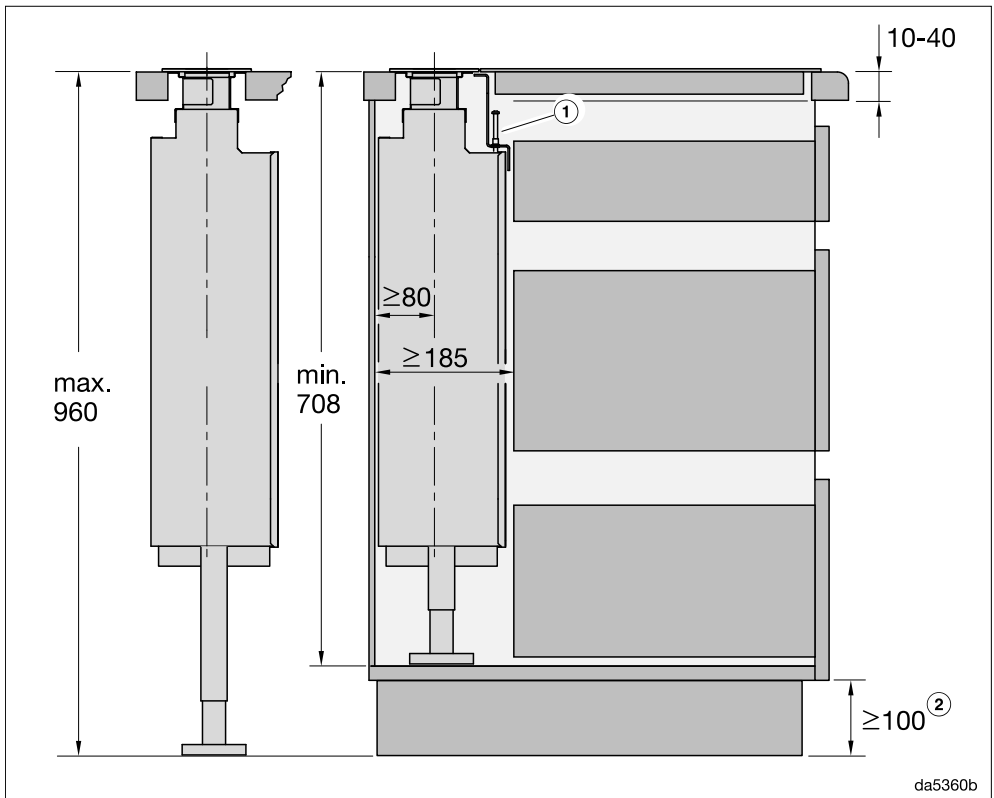

Installation

Installation of the downdraft extractor and cooktop in separate cut-outs

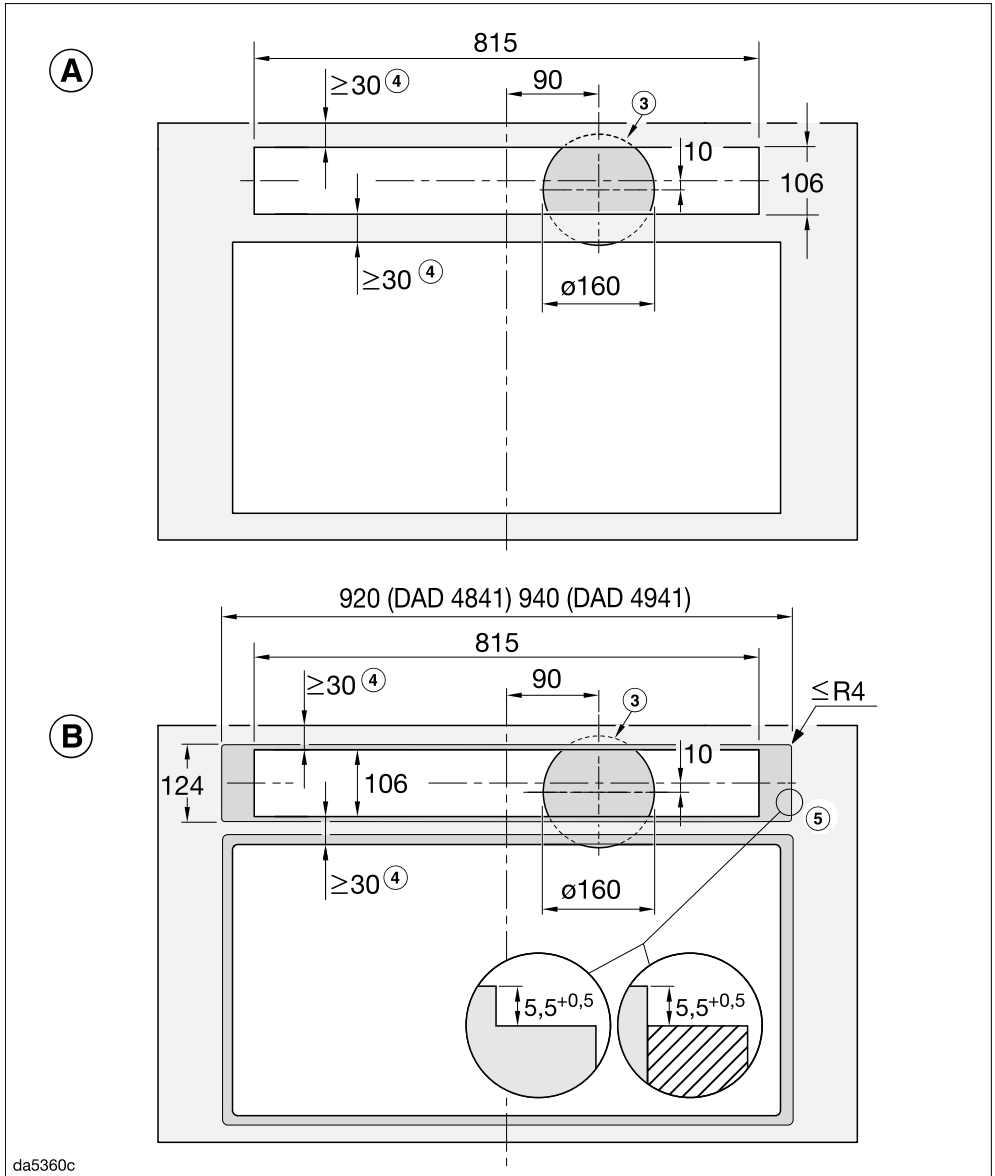

Ⓐ Surface-mounted installation

Ⓑ Flush-fit installation

Adjacent installation of the downdraft extractor and cooktop in a single cut-out
 Example: combination with KM 7697 FL or KM 7594 FL

da5360d

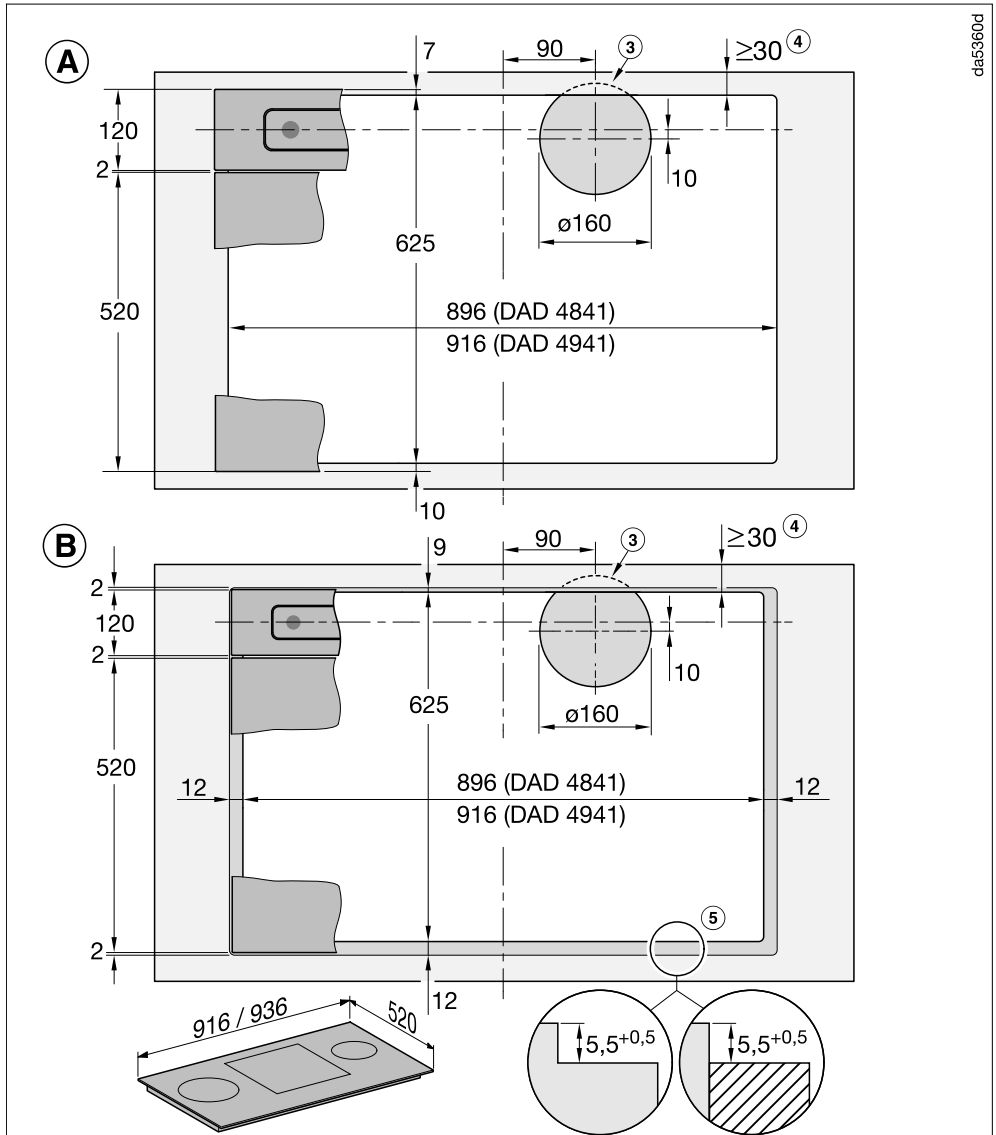

- (A) Surface-mounted installation
- (B) Flush-fit installation

Installation

Adjacent installation of the downdraft extractor and cooktop in a single cut-out
 Example: combination with KM 7684 FL or KM 7689 FL

da5360e

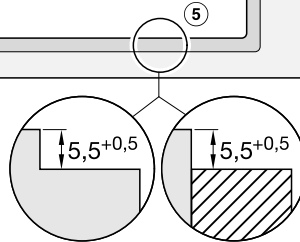
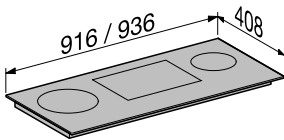
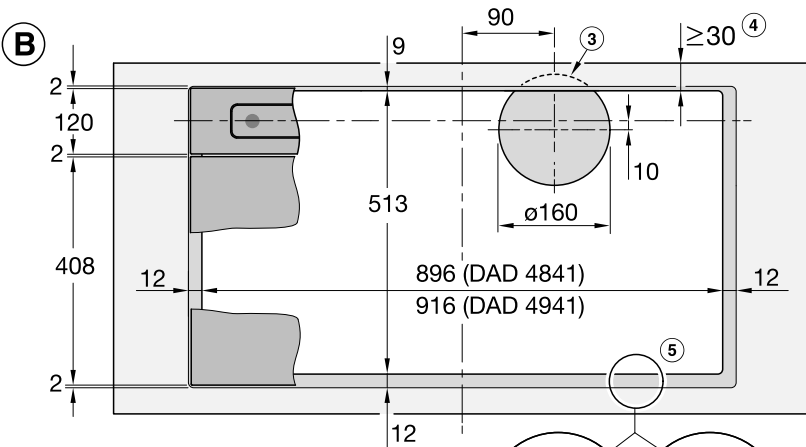
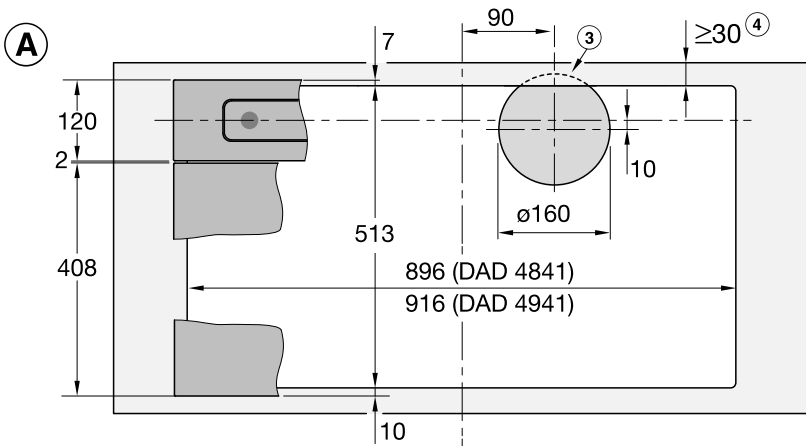

- Ⓐ Surface-mounted installation
- Ⓑ Flush-fit installation

- ① If you install the downdraft extractor and cooktop directly adjacent to one another in a single cut-out, you need to use the angle strip supplied.
- ② The minimum dimension is required if flat ducting is laid under the cabinets or the DUU 600 recirculation box is used.
- ③ Cut-out for exhaust ducting in cabinet floor.
- ④ Make sure that the worktop is stable enough to support the weight.
- ⑤ Stepped cut-out for flush-fit installation in a worktop. Take note of the different cut-out widths for the cooktop and the downdraft extractor. Instead of a stepped cut-out, a wooden frame (not supplied) can be installed 5.5 mm below the top edge of the worktop.

Exhaust connection \varnothing 150 mm.

Please also observe the notes on installation in the operating and installation instructions of the cooktop.

Installation

Installation examples

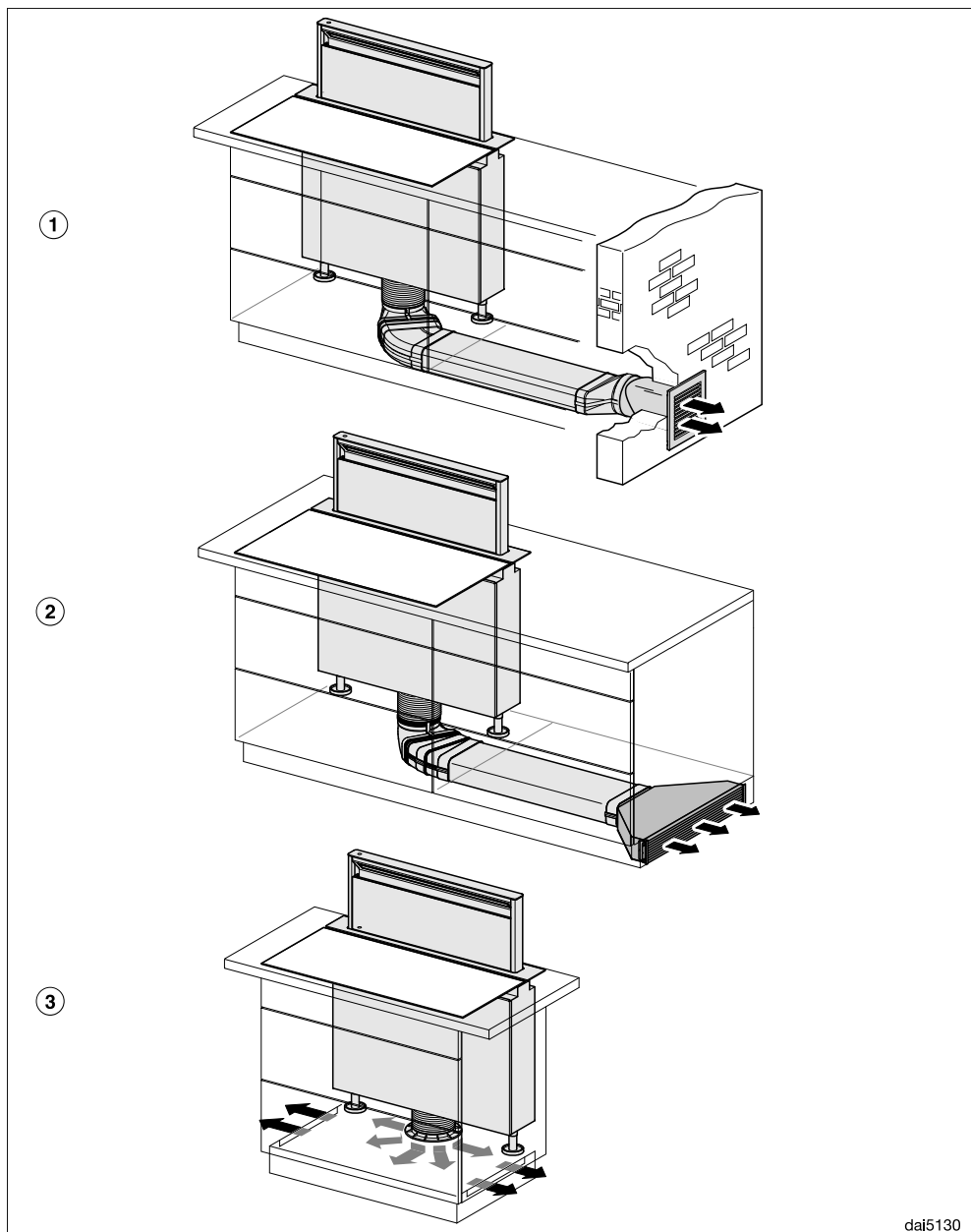

dai5130

- ① Exhaust air with flat ducting and DMK 150-1 wall box
- ② Recirculation with flat ducting and DUU 600 recirculation box
- ③ Plug&Play operation with DUP 150 conversion kit
During Plug&Play operation, ensure sufficient ventilation of the plinth area, e.g. through gaps in the plinth panel.
The cross-section of the openings must be at least 425 cm² in total. If the floor meets the ground or is exposed to outside air, the heat transfer coefficient of the floor must not exceed 0.5 W/(m² K).
The electronic unit of the extractor must be switched to Plug&Play operation, see “Before using for the first time – Setting up Plug&Play”.

Sealing the gaps

 Damage caused by unsuitable sealant.

Unsuitable sealant can damage natural stone.

For natural stone worktops and natural stone tiles, only use silicone sealant that is specially formulated for natural stone. Please follow the manufacturer's instructions.

- Use a heat-resistant silicone sealant (min. 160 °C) to seal the gap between the downdraft extractor and worktop with a flush-fit installation and between the downdraft extractor and cooktop when the two are installed adjacent to one another.

Installation

Connection for air extraction

Only use smooth pipes or flexible ducting made from approved non-flammable materials for exhaust ducting.

To achieve the most efficient air extraction with the lowest noise levels, please note the following:

- The diameter of the exhaust ducting must not be smaller than the cross-section of the exhaust connection (see "Appliance dimensions"). This is particularly applicable when using flat ducting.
- The exhaust ducting must be as short and straight as possible.
- Only use wide radius bends.
- The exhaust ducting must not be kinked or compressed.
- All connections must be strong and airtight.
- If the ducting has flaps, these must be opened when the rangehood is switched on.

Any constriction of the airflow will reduce extraction performance and increase operating noise.

Vent flue

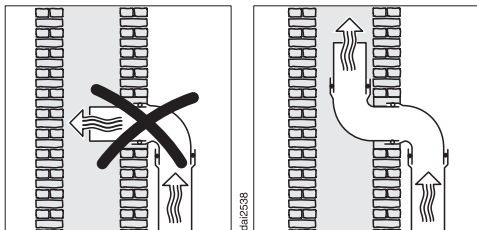

If the exhaust air is to be ducted into a vent flue, the ducting must be directed in the flow direction of the flue.

If the flue is used by several ventilation units, the cross-section of the flue must be large enough.

Non-return flap

- Make sure you use a non-return flap in the exhaust air system.

A non-return flap ensures that when the rangehood is not in operation, the duct is closed and no exchange of room and outside air can take place.

If the exhaust air is ducted through an outside wall, a Miele wall vent or a Miele roof vent (available as an optional accessory) is recommended. These are fitted with an integrated non-return flap.

Miele will not accept warranty claims for any functional defects or damage caused by inadequate ducting.

Electrical connection

The rangehood is supplied with a mains connection cable with moulded plug ready for connection to a suitable earthed socket.

If the socket is not easily accessible or if the appliance is to be hard-wired, ensure that a suitable means of disconnection is provided on the installation side for each pole.

 Risk of fire from overheating. Connecting the rangehood to multi-socket adapters or extension cables can overload the cables. For safety reasons, do not use an extension cable or multi-socket adapter.

All electrical work must be carried out by a suitably qualified and competent person in strict accordance with national and local safety regulations.

For safety reasons, we recommend using a suitable residual current device (RCD) in the relevant electrical installation for connecting the rangehood.

If the mains connection cable is damaged, it must only be replaced with a specific mains connection cable of the same type (available from Miele). For safety reasons, such replacement may only be carried out by a suitably qualified and competent electrician or a Miele authorised service technician, in order to avoid a hazard.

The data plate indicates the nominal power consumption and the connection data. Compare this information with the data of the on-site electrical connection. If in any doubt, consult a qualified electrician.

Temporary or permanent operation with a self-sufficient or non-mains synchronous energy supply system (e.g. isolated networks, back-up systems) is possible. A requirement for the operation is that the energy supply system complies with all current local and national requirements that apply to stand-alone, solar and/or battery systems. The protective measures provided in the domestic installation and in this Miele product must also be assured in their function and operation in isolated operation or in non-mains synchronous operation, or replaced with equivalent measures in the installation.

Technical data

Fan motor	180 W
Deflector plate motor	60 W
Cooktop lighting	11.2 W
Total rated load	251.2 W
Voltage, frequency	AC 230 V, 50 Hz
Fuse rating	10 A
Mains connection cable length	1.5 m
Weight	34 kg

Wi-Fi module

Frequency band	2.400–2.4835 GHz
Maximum transmission power	< 100 mW

Optional accessory for recirculation mode

Charcoal filter set DKF 30-P or DKF 30-R (reactivatable). The sets contain 2 charcoal filters.

You need the DUP 150 installation kit for Plug&Play operation. The kit contains a socket, a hose and the DKF 30-P charcoal filter set.

Miele Australia Pty. Ltd.

ACN 005 635 398

ABN 96 005 635 398

Level 4, 141 Camberwell Road
Hawthorn East, VIC 3123

1300 464 353 (1300 4 MIELE)

info@miele.com.au

www.miele.com.au

Miele New Zealand Limited

IRD 98 463 631

8 College Hill
Freemans Bay, Auckland 1011

0800 464 353 (0800 4 MIELE)

customercare@miele.co.nz

www.miele.co.nz

Miele Global Headquarters

Germany

Miele & Cie. KG

Carl-Miele-Straße 29

33332 Gütersloh

Federal Republic of Germany

DAD 4841, DAD 4941

en-AU, NZ

M.-Nr. 12 467 490 / 01