

## Operating and Installation Instructions Combi-Steam Ovens



It is **essential** to read the operating and installation instructions before setup, installation, and commissioning. This prevents both personal injury and damage to the appliance.

# Contents

---

|   |           |
|---|-----------|
| <b>IMPORTANT SAFETY INSTRUCTIONS</b> .....        | <b>8</b>  |
| <b>Overview</b> .....                             | <b>19</b> |
| Steam oven .....                                  | 19        |
| DGC 7865 .....                                    | 19        |
| DGC 7785, DGC 7885 .....                          | 20        |
| Data plate .....                                  | 22        |
| Included accessories .....                        | 22        |
| <b>Control panel</b> .....                        | <b>25</b> |
| On/Off button .....                               | 26        |
| Motion sensor.....                                | 26        |
| Sensor buttons .....                              | 27        |
| Touch display.....                                | 28        |
| Symbols .....                                     | 29        |
| <b>Using the appliance</b> .....                  | <b>30</b> |
| Selecting a menu option .....                     | 30        |
| Scrolling .....                                   | 30        |
| Exiting a menu.....                               | 30        |
| Changing a value or setting.....                  | 30        |
| Changing a setting in a list .....                | 30        |
| Entering numbers with the roller .....            | 30        |
| Entering numbers using the numerical keypad ..... | 30        |
| Changing the setting with a segment bar .....     | 31        |
| Entering letters .....                            | 31        |
| Displaying the context menu .....                 | 31        |
| Moving entries .....                              | 31        |
| Displaying the pull-down menu.....                | 32        |
| Displaying Help.....                              | 32        |
| Activating MobileStart.....                       | 32        |
| <b>Description of functions</b> .....             | <b>33</b> |
| Control panel.....                                | 33        |
| Water container .....                             | 33        |
| Food probe .....                                  | 33        |
| Temperature/core temperature .....                | 33        |
| Moisture .....                                    | 33        |
| Cooking duration .....                            | 34        |
| Noises .....                                      | 34        |
| Heating-up phase.....                             | 34        |
| Cooking phase .....                               | 34        |
| Steam reduction .....                             | 34        |
| Oven interior lighting.....                       | 34        |

|  |           |
|--|-----------|
| <b>Before first use</b> .....                    | <b>35</b> |
| Miele@home .....                                 | 35        |
| Basic settings.....                              | 36        |
| Cleaning for the first time.....                 | 37        |
| Setting the correct boiling point for water..... | 38        |
| Heating up the steam oven.....                   | 38        |
| <b>Settings</b> .....                            | <b>39</b> |
| Settings overview.....                           | 39        |
| Opening the Settings menu.....                   | 42        |
| Language ▾ .....                                 | 42        |
| Time.....  | 42        |
| Date.....  | 43        |
| Lighting.....                                    | 43        |
| Start screen.....                                | 43        |
| Display .....                                    | 44        |
| Volume .....                                     | 44        |
| Units of Measurement.....                        | 45        |
| Keeping warm .....                               | 45        |
| Steam reduction .....                            | 45        |
| Recommended temperatures.....                    | 45        |
| Booster .....                                    | 46        |
| Automatic rinsing .....                          | 46        |
| Water hardness.....                              | 47        |
| MotionReact .....                                | 49        |
| Safety .....                                     | 50        |
| Furniture front recognition .....                | 50        |
| Miele@home .....                                 | 51        |
| Performing Scan & Connect.....                   | 51        |
| Remote Control .....                             | 52        |
| Activating MobileStart.....                      | 52        |
| SuperVision .....                                | 52        |
| RemoteUpdate .....                               | 53        |
| Software version.....                            | 54        |
| Legal information .....                          | 54        |
| Showroom Program .....                           | 54        |
| Factory default .....                            | 54        |
| Operating hours (total) .....                    | 54        |
| <b>Alarm + Timer</b> .....                       | <b>55</b> |
| Using the Alarm function.....                    | 55        |
| Using the Timer function.....                    | 56        |
| <b>Main and submenus</b> .....                   | <b>57</b> |

# Contents

---

|  |           |
|--|-----------|
| <b>Energy-saving tips</b> .....                          | <b>59</b> |
| <b>Operation</b> .....                                   | <b>60</b> |
| Changing values and settings for a cooking program ..... | 61        |
| Changing the temperature and core temperature .....      | 61        |
| Changing Moisture .....                                  | 61        |
| Setting additional durations .....                       | 62        |
| Changing set durations .....                             | 62        |
| Deleting the set cooking durations .....                 | 62        |
| Canceling a cooking program .....                        | 63        |
| Interrupting a cooking program .....                     | 63        |
| Preheating the oven .....                                | 64        |
| Booster.....   | 64        |
| Preheat .....  | 65        |
| Crisp function.....                                      | 65        |
| Injecting bursts of steam .....                          | 66        |
| Changing the operating mode .....                        | 66        |
| <b>General notes</b> .....                               | <b>67</b> |
| The advantages of cooking with steam.....                | 67        |
| Suitable containers .....                                | 67        |
| Shelf level .....  | 67        |
| Frozen food.....   | 68        |
| Temperature .....  | 68        |
| Cooking duration .....                                   | 68        |
| Cooking with liquid.....                                 | 68        |
| Your own recipes - Steam cooking .....                   | 68        |
| Universal tray and wire rack.....                        | 68        |
| <b>Steam cooking</b> .....                               | <b>69</b> |
| Notes on the cooking charts .....                        | 69        |
| Vegetables.....  | 69        |
| Fish .....   | 72        |
| Meat .....   | 75        |
| Rice.....  | 77        |
| Grains.....  | 78        |
| Pasta/noodles.....                                       | 79        |
| Dumplings .....  | 80        |
| Legumes .....  | 81        |
| Eggs.....  | 83        |
| Fruit .....  | 84        |
| Sausage .....  | 84        |
| Shellfish .....  | 85        |
| Mussels.....   | 86        |
| Menu Cooking - Manual.....                               | 87        |

|   |            |
|---|------------|
| <b>Sous-vide (vacuum) cooking</b> .....     | <b>88</b>  |
| <b>Special modes</b> .....                  | <b>94</b>  |
| Reheat .....                                | 94         |
| Defrost .....                               | 96         |
| Miele Mix & Match .....                     | 99         |
| Menu Cooking – automatic .....              | 110        |
| Canning .....                               | 111        |
| Canning cakes .....                         | 113        |
| Dehydrate .....                             | 114        |
| Using the Sabbath program and Yom Tov ..... | 115        |
| Juicing .....                               | 117        |
| Blanching .....                             | 118        |
| Sanitizing Cookware .....                   | 118        |
| Warm-up Cookware .....                      | 119        |
| Keep warm .....                             | 119        |
| Proofing .....                              | 120        |
| Heating damp towels .....                   | 120        |
| Dissolving Gelatine .....                   | 120        |
| Decrystalize honey .....                    | 121        |
| Melting Chocolate .....                     | 121        |
| Rendering Fat .....                         | 122        |
| Sweating Onions .....                       | 122        |
| Preserving Apples .....                     | 122        |
| Preparing custard royale .....              | 122        |
| Fruit jam .....                             | 123        |
| Skinning Fruits and Vegetables .....        | 123        |
| Making Yogurt .....                         | 124        |
| <b>Automatic Programs</b> .....             | <b>125</b> |
| Categories .....                            | 125        |
| Using automatic programs .....              | 125        |
| Usage notes .....                           | 125        |
| Search .....                                | 126        |
| <b>MyMiele</b> .....                        | <b>127</b> |
| <b>Favorites</b> .....                      | <b>128</b> |
| <b>Baking</b> .....                         | <b>131</b> |
| Baking tips .....                           | 131        |
| Tips for baking .....                       | 132        |
| Notes on the operating modes .....          | 132        |
| <b>Roasting</b> .....                       | <b>134</b> |
| Roasting tips .....                         | 134        |
| Notes on the operating modes .....          | 134        |

# Contents

---

|  |            |
|--|------------|
| Food Probe .....                                   | 136        |
| <b>Broiling</b> .....                              | <b>139</b> |
| Broiling tips .....                                | 139        |
| Tips for broiling .....                            | 139        |
| Notes on the operating modes.....                  | 140        |
| <b>Cleaning and care for the steam oven</b> .....  | <b>141</b> |
| Important information on cleaning and care .....   | 141        |
| Unsuitable cleaning agents .....                   | 142        |
| Cleaning the front.....                            | 142        |
| PerfectClean .....                                 | 143        |
| Oven compartment.....                              | 144        |
| Cleaning the water container.....                  | 145        |
| Accessories .....                                  | 146        |
| Cleaning the side racks.....                       | 147        |
| Lowering the browning/broiling element.....        | 148        |
| Maintenance .....                                  | 149        |
| Soak .....   | 149        |
| Drying .....                                       | 149        |
| Rinsing.....                                       | 149        |
| Descaling the steam oven .....                     | 149        |
| Removing the door .....                            | 151        |
| Installing the door.....                           | 152        |
| <b>Frequently asked questions</b> .....            | <b>153</b> |
| <b>Optional accessories</b> .....                  | <b>159</b> |
| Containers .....                                   | 159        |
| Other .....  | 159        |
| Cleaning and care products .....                   | 159        |
| <b>Customer Service</b> .....                      | <b>160</b> |
| Contact in the event of a fault .....              | 160        |
| Appliance warranty and product registration .....  | 160        |
| <b>Caring for the environment</b> .....            | <b>161</b> |
| <b>Installation</b> .....                          | <b>162</b> |
| IMPORTANT SAFETY INSTRUCTIONS - INSTALLATION ..... | 162        |
| Installation dimensions DGC 7865 .....             | 163        |
| Installation in a tall cabinet.....                | 163        |
| Side view.....                                     | 164        |
| Swivel range for control panel.....                | 165        |
| Connections and ventilation .....                  | 166        |

# Contents

---

|   |            |
|---|------------|
| Installation dimensions DGC 7785, DGC 7885.....                   | 167        |
| Installation in a tall cabinet.....                               | 167        |
| Side view.....  | 168        |
| Swivel range for control panel.....                               | 169        |
| Connections and ventilation .....                                 | 170        |
| Installing and removing the steam oven .....                      | 171        |
| Plumbed water connection .....                                    | 174        |
| Drainage.....   | 176        |
| Electrical connection .....                                       | 177        |
| <b>Declaration of conformity .....</b>                            | <b>178</b> |
| <b>Copyrights and licenses .....</b>                              | <b>179</b> |
| <b>Copyrights and licenses for the communication module .....</b> | <b>180</b> |

# IMPORTANT SAFETY INSTRUCTIONS

---

**When using the appliance, please comply with the basic safety requirements, including the following instructions:**

**Read all instructions before installation and use of the steam oven to prevent accidents and damage to the appliance.**

The Combi-Steam Oven is referred to in the following instructions as a steam oven.

This appliance complies with all current local and national safety requirements. Inappropriate use can, however, lead to personal injury and material damage.

Please read these operating and installation instructions carefully before using the steam oven for the first time. They contain important information on safety, installation, use, and maintenance. This prevents both personal injury and damage to the steam oven. Miele cannot be held liable for injury or damage caused by non-compliance with these instructions.

Keep these operating and installation instructions in a safe place and pass them on to any future owner.



# IMPORTANT SAFETY INSTRUCTIONS

---

## Appropriate use

- ▶ This appliance is intended for residential use only.
- ▶ The steam oven is not suitable for outdoor use.
- ▶ The steam oven is intended only to steam, bake, roast, broil, defrost, and reheat food.  
All other types of use are not permitted.
- ▶ Risk of fire. Never use the steam oven to store or dry items which could ignite easily.
- ▶ Persons who lack physical, sensory or mental abilities, or experience with the appliance should not use it without supervision or instruction by a responsible person.
- ▶ This steam oven is supplied with a special bulb to cope with particular conditions (e.g. temperature, moisture, chemical resistance, abrasion resistance and vibration). This special bulb must only be used for the purpose for which it is intended. It is not suitable for room lighting. Replacement of bulbs may only be carried out by a Miele authorized technician.

# IMPORTANT SAFETY INSTRUCTIONS

---

## Safety with children

- ▶ Activate the system lock to ensure that children cannot switch on the steam oven inadvertently.
- ▶ Please supervise children in the vicinity of the steam oven and do not let them play with it.
- ▶ Risk of burns due to improper use. Do not allow children to operate the steam oven.
- ▶ Risk of suffocation from packaging material. While playing, children may become entangled in packaging material (such as plastic wrapping) or pull it over their head, presenting the risk of suffocation. Keep packaging material away from children.
- ▶ Danger of injury caused by hot surfaces. Children's skin is far more sensitive to high temperatures than that of adults. External parts of the steam oven such as the door glass, control panel, and the vent become quite hot. Do not let children touch the steam oven when it is in operation.  
Keep children well away from the steam oven until it has cooled down and there is no danger of injury.
- ▶ Risk of injury from the open door. The oven door can support a maximum weight of 22 lbs (10 kg). Children could injure themselves on an open door.  
Do not let children sit on the door, lean against it, or swing on it.

# IMPORTANT SAFETY INSTRUCTIONS

## Technical safety

- ▶ This steam oven must be installed and connected in compliance with the installation instructions.
- ▶ Unauthorized installation, maintenance, and repairs can cause considerable danger for the user. Installation, maintenance, and repairs must only be carried out by a Miele authorized technician.
- ▶ Changes or modifications not expressly approved by Miele may void the user's authority to operate the steam oven.
- ▶ Maintenance by the user: Never repair or replace any part of the appliance unless the instructions specifically recommend doing so. Service work should only be performed by a qualified technician.
- ▶ A damaged appliance is dangerous. Check the appliance for any visible damage. Never install or attempt to use a damaged appliance.
- ▶ Temporary or permanent operation on an autonomous power supply system or a power supply system that is not synchronized with the grid power supply (e.g., island networks, back-up systems) is possible. A prerequisite for operation is that the power supply system complies with national and local codes.

The function and operation of the protective measures provided in the domestic electrical installation and in this Miele product must also be maintained in isolated operation or in operation that is not synchronized with the grid power supply, or these measures must be replaced by equivalent measures in the installation.

- ▶ Be certain your appliance is properly installed and grounded by a qualified technician. To guarantee the electrical safety of this appliance, continuity must exist between the appliance and an effective grounding system. It is imperative that this basic safety requirement be met. If there is any doubt, have the electrical system of the house checked by a qualified electrician.
- ▶ Proper installation: Make sure that your appliance has been installed correctly and that it has been grounded by a qualified technician.
- ▶ Before connecting the appliance to the power supply, ensure that the connection data on the data plate (voltage and frequency) match the power supply.  
This data must correspond in order to avoid the risk of damage to the appliance. Consult a qualified electrician if in any doubt.
- ▶ Do not use an extension cord to connect this appliance to the power supply. Extension cords do not guarantee the required safety of the appliance.

## IMPORTANT SAFETY INSTRUCTIONS

---

- ▶ Maintain the required minimum installation height of 36" (914 mm).
- ▶ For safety reasons, this appliance may only be used after it has been built in.
- ▶ This steam oven must not be used in a non-stationary location (e.g. on a ship).
- ▶ Risk of injury due to electric shock. Any contact with live connections or tampering with the electrical or mechanical components of the oven will endanger your safety and may lead to the steam oven malfunctioning.  
Do not open the steam oven housing under any circumstances.
- ▶ While the appliance is under warranty, repairs should only be performed by a Miele-authorized service technicians. Work by unqualified persons could be dangerous and may void the warranty.
- ▶ Defective components should be replaced by Miele original parts only. Only with these parts can safety of the appliance be assured as intended by the manufacturer.
- ▶ If the electrical plug is removed from the power cord or if the power cord is supplied without an electrical plug, the steam oven must be connected to the electricity supply by a qualified service technician.
- ▶ If the power cord is damaged, it must be replaced with a special power cord (see "Electrical connection" under "Installation").
- ▶ During installation, maintenance and repair work, the appliance must be disconnected from the main electricity supply. It is only completely isolated from the electricity supply when:
  - The circuit breakers have been switched off, or
  - The fuses of the electrical installation have been completely removed, or
  - Unplug (if plug present) the machine from the outlet. Pull the plug not the cord.
- ▶ If the steam oven is installed behind a cabinet front (e.g., a door), do not close the cabinet front while the steam oven is in use. Heat and moisture can build up behind the cabinet front when closed. This can result in damage to the steam oven, the housing unit, and the floor. Leave the door panel open until the steam oven has cooled down completely.

## IMPORTANT SAFETY INSTRUCTIONS

---

- ▶ Connection to the water supply should only be carried out by a qualified specialist.  
Miele cannot be held liable for damage caused by incorrect installation or connection.
- ▶ The appliance must be connected to the cold water supply only.
- ▶ The water supply must be easily accessible after the appliance has been installed.
- ▶ Before connection, check the intake and drain hoses for visible signs of damage.
- ▶ The built-in waterproof system offers reliable protection against water damage if the following conditions are met:
  - The steam oven is properly installed (electrical and water connections).
  - The steam oven is repaired immediately if any damage is identified.
  - Turn off the water supply when the appliance is not in use for an extended period (e.g., vacation).
- ▶ The water quality must conform to the requirements for drinking water in the country in which the steam oven is being installed.

### **Correct use**

- ▶ Danger of burning. The heater elements may still be hot even if they are not glowing red. The surfaces of the oven compartment can cause burns if they are touched. External parts of the steam oven such as the door glass, control panel, and the vent become quite hot. During operation and after turning the steam oven off, make sure that you do not touch any hot parts and surfaces and do not let any items of clothing or flammable objects come into contact with these. Wait until the steam oven has cooled down.
- ▶ Do not let food sit in the oven for an extended period of time before or after cooking. Doing so can result in food poisoning or sickness.
- ▶ Loose fitting or hanging garments present a fire hazard. Wear proper apparel while operating the appliance.
- ▶ Use only dry, heat-resistant potholders. Moist or damp potholders used on hot surfaces may result in steam burns. Do not let potholders come in contact with oil or grease. Do not substitute dish towels or other bulky items for potholders. Do not let potholders touch hot heating elements.

## IMPORTANT SAFETY INSTRUCTIONS

---

- ▶ Open the door carefully to allow hot air or steam to escape before placing or removing food.
- ▶ Danger of burning. Push the baking trays and wire racks onto the corresponding level before heating up the steam oven. If you want to remove the baking tray or wire rack while the oven compartment is hot, do not touch the heater elements with the pot holders.
- ▶ To prevent burns, allow the heating elements to cool before cleaning by hand.
- ▶ Smother the fire or flames, or use a dry chemical extinguishing agent or foam fire extinguisher.
- ▶ Do not store any flammable liquids and objects near to the steam oven or cooktop.

### WARNING

Never use the steam oven to heat or warm up a room. This may result in carbon monoxide poisoning and overheating of the steam oven.

### WARNING

Never use the steam oven for storage purposes. This may result in carbon monoxide poisoning and overheating of the steam oven.

### WARNING

Never cover slots, holes, or openings in the base of the steam oven or cover the entire wire rack with materials such as aluminum foil. This blocks the air flow in the steam oven and can cause carbon monoxide poisoning. Covers made of aluminum foil can also cause heat to build up, which could lead to a fire.

- ▶ Do not obstruct the flow of combustion and ventilation air.
- ▶ Only use the steam oven to prepare food. Corrosive chemicals and vapors such as those caused by heated adhesives, plastic, or flammable liquids and objects can be harmful to the health. Do not use the steam oven for drying, toasting, or dehumidifying.
- ▶ Do not let metal objects (aluminum foil, pans) come in contact with the heating element.

## IMPORTANT SAFETY INSTRUCTIONS

---

- ▶ Make certain that the power cords of small appliances do not come in contact with or get caught in the oven door.
- ▶ Risk of injury caused by hot surfaces and steam. The steam oven gets hot during operation. You could burn yourself on the heater elements, oven compartment, side racks, accessories, food, or steam. Use pot holders when placing food in the appliance or removing it and when working in the hot oven compartment.
- ▶ Risk of injury caused by hot food. Food may spill or splash around when placing it into the oven or removing it. The food can cause burns. When placing cooking containers in the oven or removing them, make sure that the hot food does not spill.
- ▶ Do not heat up food in closed containers e.g. tins or sealed jars in the steam oven, as pressure will build up in the container, causing it to explode.
- ▶ Plastic containers which are not suitable for use in an oven can melt at high temperatures and can even damage the steam oven or catch fire. Only use plastic containers which are declared by the manufacturer as being suitable for use in a steam oven. Follow the manufacturer's instructions on use. If you want to use plastic containers for steaming food make sure that they are temperature resistant to 212°F (100°C) and steam resistant. Any other plastic containers could melt, become brittle or break when subjected to heat.
- ▶ Risk of injury caused by steam. Pouring a cold liquid onto a hot surface creates steam, which can cause severe scalding. The sudden temperature change can also cause damage to hot surfaces. Never pour cold liquids directly onto hot enameled surfaces.
- ▶ It is important that the temperature in the food being cooked is evenly distributed and sufficiently high. You can ensure this by stirring or turning the food.
- ▶ Food which is left in the oven compartment can dry out and the moisture released can lead to corrosion damage in the steam oven. Do not leave food in the oven compartment and do not use any cooking containers which are susceptible to corrosion.
- ▶ Risk of injury from the open door. You could bang into the open door or trip over it. Do not leave the door open unnecessarily.

## IMPORTANT SAFETY INSTRUCTIONS

---

- ▶ The door can support a maximum weight of 22 lbs (10 kg). Do not sit, lean or place heavy items on the open oven door. Also be sure nothing can get trapped between the door and the oven cavity. The steam oven could get damaged.
- ▶ Oil and fat can ignite if overheated. Never leave the steam oven unattended when cooking with oil and fat.  
If it does ignite do not put the flames out with water. Switch the steam oven off immediately and then suffocate the flames by keeping the oven door closed.
- ▶ Due to the high temperatures radiated, objects left near the steam oven when it is in use could catch fire.  
Do not use the steam oven to heat up the room.
- ▶ Broiling food for excessively long cooking durations can cause it to dry out with the risk of catching fire. Do not exceed the recommended cooking durations.
- ▶ Certain foods dry out quickly and may catch fire due to high broiling temperatures.  
Never use broiling modes to finish baking par-cooked rolls or bread, or to dry flowers or herbs. Instead, use the Convection Bake  or Surround  operating mode.
- ▶ To avoid fueling any flames, do not open the steam oven door if there is smoke inside the oven compartment. Interrupt operation by turning the steam oven off and disconnecting it from the electricity supply. Do not open the door until the smoke has dispersed.
- ▶ Use caution when using alcohol in your recipes. Alcohol evaporates at high temperatures but may, in rare circumstances, combust on the hot heating elements.
- ▶ Never line the floor of the oven with aluminum foil or oven liners. Do not place any dishware or any pans, pots, or baking trays directly on the floor of the oven compartment.  
If you want to use the floor of the oven compartment as an extra surface, place the wire rack on the floor of the oven compartment with the rack surface facing up and the dishware on top. In doing so, ensure that the filter in the floor of the oven is not moved.
- ▶ The oven compartment floor can become damaged by the wire rack being pushed around on it.  
Do not push the wire rack around on the oven compartment floor.
- ▶ Larger deposits of food can block the drain and pump. Always make sure that the filter in the floor of the oven is inserted.



## IMPORTANT SAFETY INSTRUCTIONS

---

- ▶ When using a small electrical appliance, e.g., a hand-held blender, near the steam oven, care should be taken that the power cord of the appliance cannot get trapped by the steam oven door. This could damage the insulation on the cord.
- ▶ Do not operate the appliance without the bulb cover. Steam could attack the electrical components and cause a short circuit. Steam could also damage the electrical components.

### **Cleaning and maintenance**

- ▶ Only clean parts listed in these operating and installation instructions.
- ▶ Risk of injury due to electric shock. The steam from a steam cleaning appliance could reach live electrical components and cause a short circuit. Never use a steam cleaner for cleaning.
- ▶ Scratches on the door glass can cause the glass to break. Do not use abrasive cleaners, hard sponges, brushes or sharp metal tools to clean the door glass.
- ▶ The side racks can be removed (see “Cleaning the side racks” under “Cleaning and care for the steam oven”). Reinstall the side racks correctly.
- ▶ To avoid corrosion on the stainless steel surfaces, remove any splashes on the interior walls of the oven from food or liquids containing salt.
- ▶ In warm, moist environments, there is a higher probability of pest infestations. Ensure the steam oven and the area surrounding it are always kept clean.  
Damage caused by pests is not covered by the warranty.

# IMPORTANT SAFETY INSTRUCTIONS

---

## Accessories

- ▶ Use only genuine original Miele parts. If parts or accessories from other manufacturers are used, the warranty may become void.
- ▶ Only use the Miele food probe supplied with this oven. If it is faulty, it must only be replaced with a Miele genuine probe.
- ▶ The plastic on the probe can melt at very high temperatures. Do not use the probe when using the broil functions (exception: Convection Broil ). Do not store the probe in the oven if it is not in use.
- ▶ The perforated and solid cooking pans will be damaged by high temperatures! Use them only in modes and programs that work exclusively with steam.

## Preparing for a long period of absence

- ▶ If you turn off your water supply when you're going to be away for a long period of time, please note that this may not be enough to prevent water damage. To eliminate the risk of water damage, close the shut off valve at each individual appliance.

**KEEP THE OPERATING AND INSTALLATION INSTRUCTIONS IN A SAFE PLACE AND REVIEW THEM PERIODICALLY.**

## Steam oven

### DGC 7865

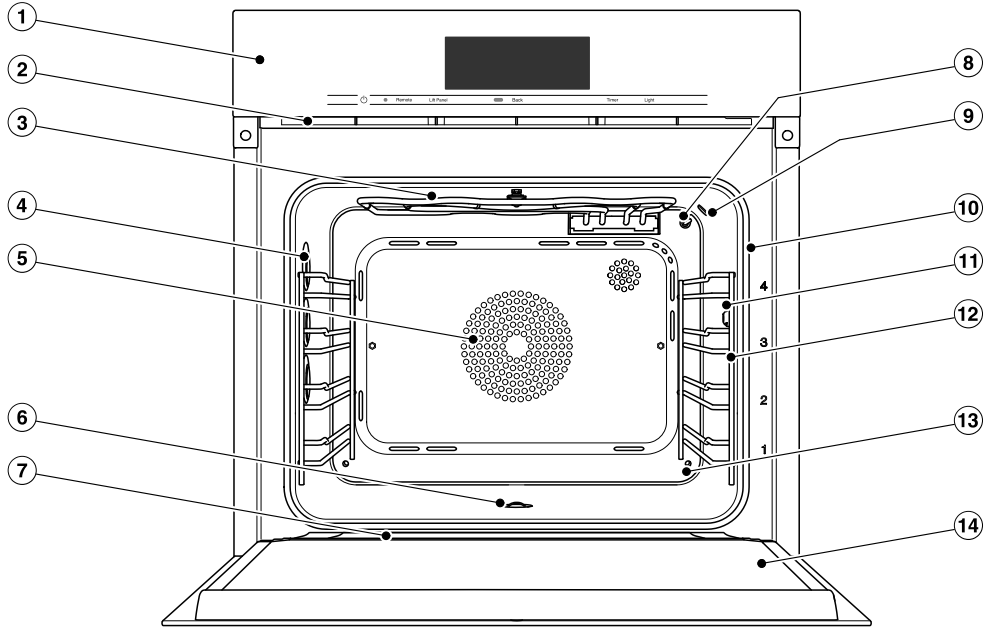

- ① Controls
- ② Vent
- ③ Browning/Broiling element
- ④ Oven interior lighting
- ⑤ Convection fan with heating element
- ⑥ Oven floor with bottom heater element and floor filter underneath it
- ⑦ Drip channel
- ⑧ Temperature sensor
- ⑨ Moisture sensor
- ⑩ Door seal
- ⑪ Connection socket for the probe
- ⑫ Side runners with 4 shelf levels
- ⑬ Steam inlet
- ⑭ Door

# Overview

## DGC 7785, DGC 7885

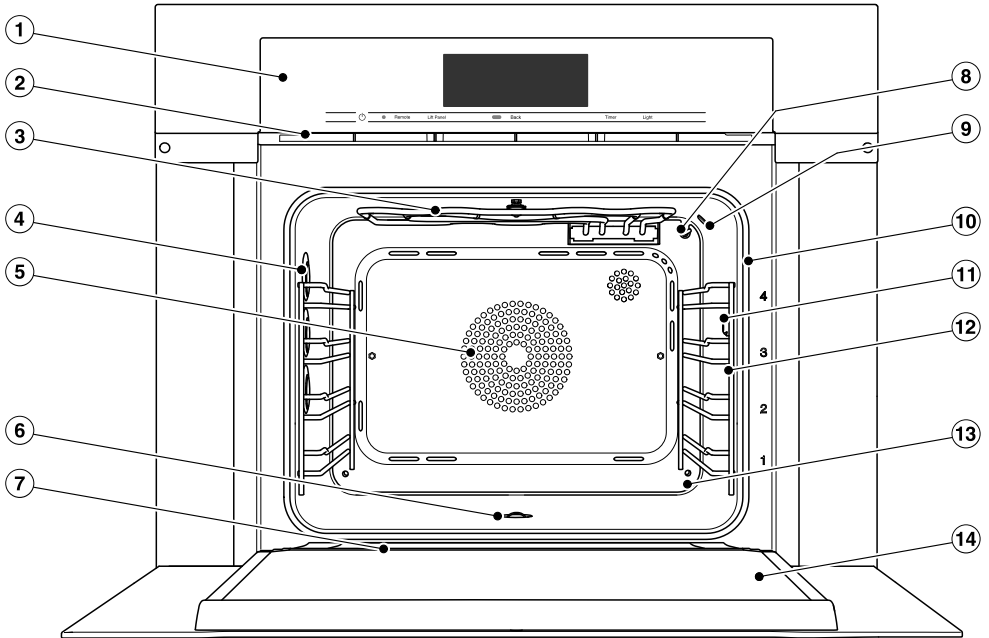

- ① Controls
- ② Vent
- ③ Browning/Broiling element
- ④ Oven interior lighting
- ⑤ Convection fan with heating element
- ⑥ Oven floor with bottom heater element and floor filter underneath it
- ⑦ Drip channel
- ⑧ Temperature sensor
- ⑨ Moisture sensor
- ⑩ Door seal
- ⑪ Connection socket for the probe
- ⑫ Side runners with 4 shelf levels
- ⑬ Steam inlet
- ⑭ Door

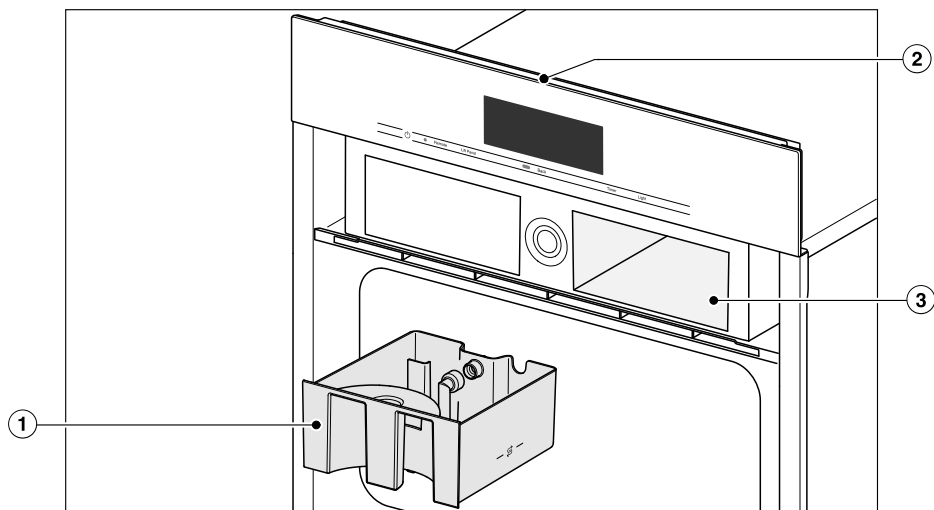

- ① Water container
- ② Data plate
- ③ Compartment for water container

## Overview

---

A list of the models described in these operating and installation instructions can be found on the back page.

### Data plate

The data plate can be found at the top on the opened control panel.

Here you can find the model and serial number.

Have this information available if you need to contact Miele so that any issues can be rectified as quickly as possible.

### Included accessories

The accessories supplied with your appliance, as well as a range of optional ones, are available to order from Miele (see "Optional accessories").

The perforated and solid cooking pans will be damaged by high temperatures!

Use them only in modes and programs that work exclusively with steam.

### DGG 20

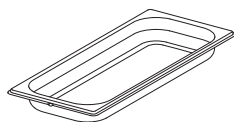

1 solid cooking pan  
Gross capacity 0.64 gal (2.4 l)  
Useable capacity 0.48 gal (1.8 l)  
17 11/16" x 7 1/2" x 1 9/16" (WxDxH)  
450 x 190 x 40 mm (WxDxH)

### DGGL 20

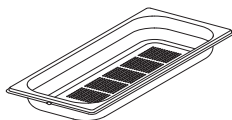

1 perforated cooking pan  
Gross capacity 0.64 gal (2.4 l)  
Useable capacity 0.48 gal (1.8 l)  
17 11/16" x 7 1/2" x 1 9/16" (WxDxH)  
450 x 190 x 40 mm (WxDxH)

### DGGL 12

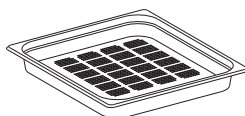

1 perforated cooking pan  
Gross capacity 1.43 gal (5.4 l)  
Useable capacity 0.87 gal (3.3 l)  
17 11/16" x 15 3/8" x 1 9/16" (WxDxH)  
450 x 390 x 40 mm (WxDxH)

### Universal tray

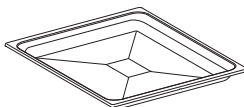

1 universal tray for baking, roasting and broiling

### Wire rack



1 wire rack for baking, roasting and broiling

## Food probe

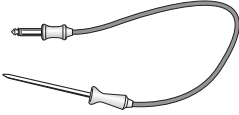

Food probe to allow you to monitor the exact temperature of cooking processes (see “Food probe” under “Roasting”).

- When using the food probe, do not insert the FlexiClip telescopic runners on shelf level 4, otherwise the socket will be blocked.

## Descaling tablets

For descaling the steam oven

## FlexiClip telescopic runners HFC 71

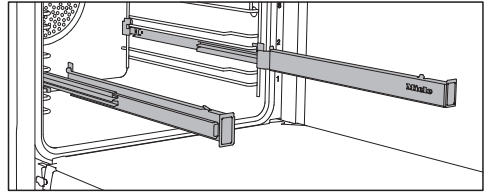

The FlexiClip telescopic runners can be attached to any shelf level.

Push the FlexiClip telescopic runners all the way into the oven before placing accessories on them.

The accessories will then automatically sit securely in between the stoppers at either end of each runner and be prevented from sliding off.

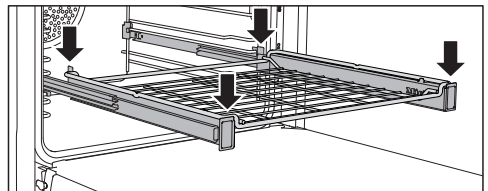
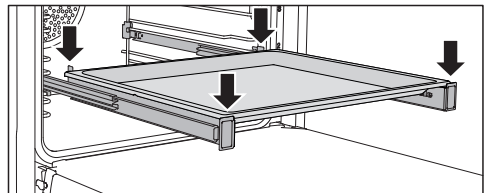

The FlexiClip telescopic runners can support a maximum load of 33 lb (15 kg).

# Overview

## Installing and removing the FlexiClip telescopic runners

 Danger of injury caused by hot surfaces.

The steam oven gets hot during operation. You could burn yourself on the heater elements, oven compartment, side racks, or accessories.

Allow the heater elements, oven compartment, the side racks, and the accessories to cool down before fitting or removing the FlexiClip telescopic runners.

The FlexiClip telescopic runners are installed in between the two rails that make up a shelf level.

The FlexiClip telescopic runner with the Miele logo is installed on the right.

When installing or removing the FlexiClip telescopic runners, do **not** extend them.

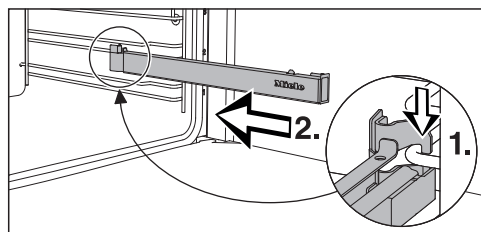

- Hook the FlexiClip telescopic runner onto the lower rail of a shelf level at the front (1.) and push it along the rail into the oven compartment (2.).

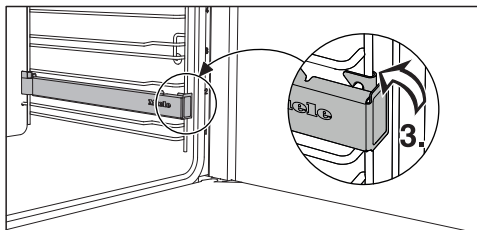

- Then secure the FlexiClip telescopic runner to the lower rail of the shelf level (3.).

If the FlexiClip telescopic runners are difficult to pull out after installing, you may need to pull firmly on them once to release them.

To remove a FlexiClip telescopic runner, proceed as follows:

- Push the FlexiClip telescopic runner in all the way.

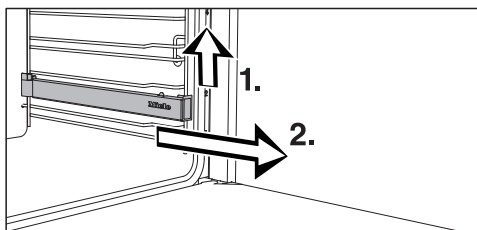

- Remove the FlexiClip telescopic runner by raising it at the front (1.) and then pulling it forward along the rail of the shelf level and out (2.).



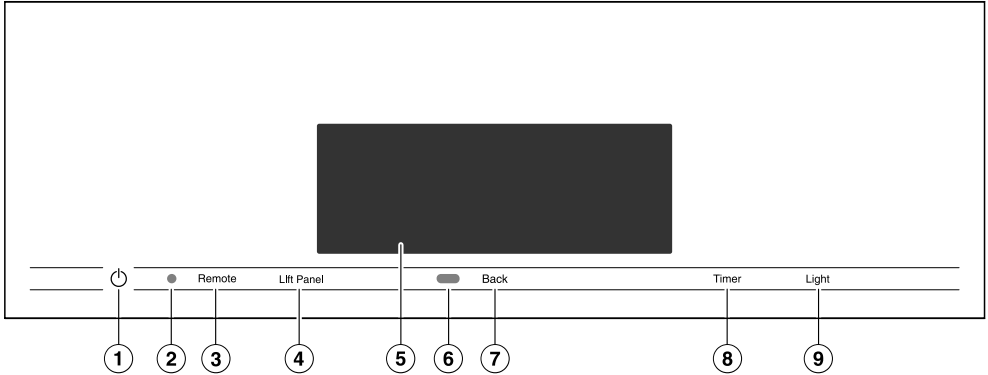

- ① Recessed  On/Off button  
For turning the steam oven on and off
- ② Optical interface  
(for Miele Service only)
- ③ *Remote* sensor button  
For controlling the steam oven via your mobile device
- ④ *Lift Panel* sensor control  
For opening and closing the control panel
- ⑤ Touch display  
For displaying information and for operation
- ⑥ Proximity sensor (MotionReact)  
For turning on the oven interior lighting and the display when approached, and to dismiss the audible signal when movement is detected
- ⑦ *Back* sensor button  
To go back a step
- ⑧ *Timer* sensor button  
To activate or deactivate timers or alarms
- ⑨ *Light* sensor button  
For switching the oven interior lighting on and off

# Control panel

---

## On/Off button

The  On/Off button is recessed and reacts to touch.

Use this button to turn the steam oven on and off.

## Motion sensor

The motion sensor is located under the touch display next to the *Back* sensor button. The motion sensor detects when you approach the touch display, e.g., with your hand or body.

If you have activated the corresponding settings, you can turn on the oven interior lighting, turn on the steam oven, or dismiss the audible signals (see “MotionReact” under “Settings”).

## Sensor buttons

The sensor buttons react to touch. Every tap of a sensor button is confirmed with an audible keypad tone. You can turn this keypad tone off by selecting the **Volume | Keypad Tone | Off** setting.

If you want the sensor buttons to respond even when the steam oven is turned off, select the **Display | QuickTouch | On** setting.

| Sensor button     | Function   |
|-------------------|--|
| <i>Remote</i>     | <p>If you want to control the steam oven from your mobile device, you must have the Miele@home system, turn on the <b>Remote Control</b> setting, and tap this sensor button. The sensor button then lights up and the <b>MobileStart</b> function is available.</p> <p>As long as this sensor button is illuminated, you can control the steam oven via your mobile device (see “Settings – Miele@home”).</p> |
| <i>Lift Panel</i> | Use this sensor button to open and close the control panel (see “Description of functions – Control panel”).   |
| <i>Back</i>       | Depending on which menu you are in, this will take you back a level or back to the main menu.  |
| <i>Timer</i>      | If a menu appears on the display or if a cooking process is in progress, you can use this sensor button to set a timer (e.g., when boiling eggs) or an alarm (a specific time) at any point (see “Alarm + timer”).   |
| <i>Light</i>      | <p>Select this sensor button to turn the oven interior lighting on and off.</p> <p>Depending on the setting selected, the oven interior lighting turns off after 15 seconds or remains constantly turned on or off.</p>  |

# Control panel

## Touch display

The sensitive surface of the touch display can be scratched by pointed or sharp objects, e.g., pens.

Only touch the display with your fingers.

Make sure that water cannot get behind the touch display.

The touch display is split into multiple areas.

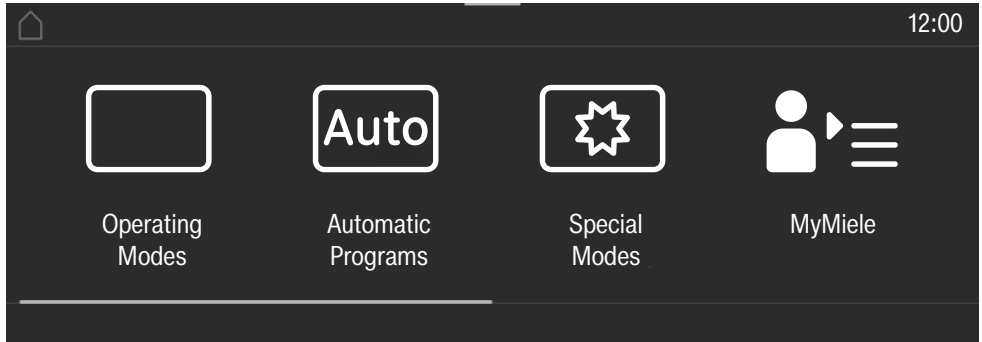

The menu path appears on the left of the **header**. The individual menu options are separated by a vertical line. ... I indicates that there are more menu options available if the menu path can no longer be displayed because there is not enough space on the display.

If you tap a menu name in the header, the display will switch to that menu. To switch to the start screen, tap .

The time of day is shown on the right of the header. You can set the time of day by tapping the display.

Additional symbols may also appear, e.g., SuperVision .

At the top of the header, there is an orange line where you can drag down the pull-down menu. This allows you to turn settings on or off during a cooking process.

The current menu and menu options are shown in the **center** of the display. You can scroll to the right or left by swiping your finger across the display to the right or left. Tap a menu option to select it (see “Using the appliance”).

The operation fields that appear in the **footer** vary according to the menu that is selected; e.g., Timer, Save or OK.

## Symbols

The following symbols may appear on the display:

| Symbol | Meaning   |
|--------|---|
|        | This symbol indicates that there is additional information and advice about using the appliance. Select <i>OK</i> to confirm the information. |
|        | This indicates that there are more menu options available, which are not visible because there is not enough space on the display.            |
|        | Alarm   |
|        | Timer   |
|        | Some settings, e.g., display brightness and signal tone volume, are selected using a segment bar.   |
|        | The system lock or sensor lock is on (see “Settings – Safety”). The controls are locked.  |
|        | Core temperature when using the probe   |
|        | Remote control (only appears if you are in the Miele@home system and have selected the Remote Control   On setting)                           |
|        | SuperVision (only appears if you are in the Miele@home system and have selected the SuperVision   SuperVision display   On setting)           |

# Using the appliance

---

You operate the steam oven via the touch display by touching the desired menu option.

Each time you tap a possible option, the relevant characters (word and/or symbol) will light up **orange**.

Fields for confirming an operating step are highlighted in **green** (e.g., *OK*).

## Selecting a menu option

- Tap the field or value you want on the display.

## Scrolling

You can scroll left or right.

- Swipe across the screen. To do this, place your finger on the touch display and swipe it in the desired direction.

The bar at the bottom shows you where you are in the current menu.

## Exiting a menu

- Tap the *Back* sensor button or tap the ... I symbol in the menu path.
- Tap the  symbol to switch to the start screen.

Entries made before this which have not been confirmed with *OK* will not be saved.

## Changing a value or setting

### Changing a setting in a list

The current setting is highlighted in orange.

- Tap the desired setting.

The setting is now saved. This will take you back to the previous menu.

### Entering numbers with the roller

- Swipe the roller up or down until the desired value is displayed in the center.
- Confirm with *OK*.

The changed number is now saved.

### Entering numbers using the numerical keypad

- Tap on the value that is in the middle of the numerical keypad.

The numerical keypad appears.

- Tap the required numbers.

As soon as you enter a valid value, *OK* will turn green.

Use the arrow to delete the last entered number.

- Confirm with *OK*.

The changed number is now saved.

## Changing the setting with a segment bar

Some settings are represented by a ■■■■■■■■■■ bar made up of segments. If all of the segments are illuminated, the maximum value is selected.

If none of the segments are illuminated or if only one is, the minimum value is selected or the setting is turned off altogether (e.g., audible signals).

- Tap the corresponding segment on the segment bar to change the setting.
- Select On or Off to turn the setting on or off.
- Confirm your selection with *OK*.

The setting is now saved. This will take you back to the previous menu.

## Entering letters

Letters are entered using a display keyboard. It is best to select short names.

- Tap the letters or characters you want.

**Tip:** You can add a line break for longer program names using the  $\int$  symbol.

- Tap *Save*.

The name is now saved.

## Displaying the context menu

In some menus you can display a context menu, e.g., to rename Favorites or to move entries under *MyMiele*.

- For example, tap a Favorite and keep your finger on it until the context menu opens.
- To close the context menu, tap an area of the display located outside of the menu window.

## Moving entries

You can change the order of Favorites or entries under *MyMiele*.

- For example, tap a Favorite and keep your finger on it until the context menu opens.
- Select *Move*.
- Keep your finger on the highlighted field and drag it to the location you want.

## Using the appliance

---

### Displaying the pull-down menu

During a cooking program, you can turn settings such as *Booster* or *Preheat* and the  WiFi function on or off.

- Use the orange line under the header to drag the pull-down menu down.
- Select the setting you want to change.  
Active settings are highlighted in orange. Depending on the selected color scheme, inactive settings are highlighted either in black or white (see “Settings – Display”).
- To close the pull-down menu, drag it back up to the top or tap an area of the display located outside of the menu window.

### Displaying Help

Context-sensitive help is available for certain functions. In this case, *Help* appears in the bottom line.

- Tap *Help* to display information in text and pictures.
- Tap *Close* to return to the previous menu.

### Activating MobileStart

- Select the *Remote* sensor button to activate MobileStart.

The *Remote* sensor button lights up. You can operate your steam oven remotely with the Miele app.

Directly operating on the steam oven takes priority over operating it via the remote control function on the app. You can use MobileStart as long as the *Remote* sensor button is lit up.



## Control panel

The water container is located behind the control panel. The control panel is opened and closed by pressing the *Lift Panel* sensor control. Before the control panel closes automatically, a note appears in the display, which you must confirm with *OK*.

The control panel is equipped with an obstruction sensor. If the control panel senses resistance when opening/closing, the process is canceled. Despite this, do not touch the upper edge of the door when the control panel is opening and closing.

## Water container

Water is pumped into the water container and then into the steam generator.

A fault can occur if the opening to the water container is blocked.

The opening on the front of the water container must not be blocked as otherwise water cannot be pumped into the steam generator.

## Food probe

The probe measures the core temperature in the food, enabling the temperature during the cooking process to be monitored simply and accurately.

## Temperature/core temperature

Some functions have a preset recommended temperature. The recommended temperature can be altered within the given range for an individual cooking program, a program stage, or for every time that program is used (see “Recommended temperatures” under “Settings”).

The core temperature can also be altered within the given range for an individual program or a specific program stage.

## Moisture

The Combi Steam  operating mode and Reheat Special Mode use a combination of oven heat and moisture. The moisture level can be selected within the given range for an individual cooking process or a specific cooking stage.

Depending on the moisture setting, moisture or fresh air is supplied to the oven compartment. With the moisture setting = 0%, the maximum fresh air supply is implemented and no moisture is supplied. With the moisture setting = 100%, there is no fresh air supply and the moisture content is at its maximum.

Some food gives off moisture during the cooking process. This moisture from the food affects the amount of additional moisture needed. If the required amount of moisture is low, the steam generator may not be activated at all.

# Description of functions

---

## Cooking duration

Depending on the operating mode, you can set a cooking duration of between 1 minute and 6, 10, or 12 hours.

The cooking durations of the Automatic, Maintenance, and Menu Cooking programs are set at the factory and cannot be altered.



When cooking with steam, as well as for programs and applications with pure steam operation, the cooking duration does not begin until the set temperature is reached. It starts immediately for all other operating modes, programs, and applications.

## Noises

A humming sound can be heard during operation and after turning off the steam oven. This noise does not indicate incorrect operation or an appliance fault. The noise is made by water being pumped through the system.

When the steam oven is in use, you will hear a blower noise.

## Heating-up phase

The display shows the temperature in the oven compartment as it rises during the heating-up phase in all operating modes (exceptions: Maxi Broil , Broil ).

The duration of the heating-up phase with steam cooking will depend on the quantity and temperature of the food. In general, the heating-up phase will last for approx. 7 minutes. It will be longer if you are cooking refrigerated or frozen food. The heating-up phase may also take longer when cooking at lower temperatures and when cooking with the Sous-vide  operating mode.

## Cooking phase

The elapsing time left is shown in the display during the cooking phase. When cooking with steam, the cooking phase begins once the set temperature is reached. It starts immediately for all other operating modes, programs, and applications.

## Steam reduction

With steam cooking and Combi-Steam, the steam-reduction function will turn on automatically at the end of a cooking program which uses a temperature within a certain temperature range. This is to prevent a large amount of steam escaping when the door is opened. Steam reduction will appear in the display.

Steam reduction can be turned off (see “Steam reduction” under “Settings”). When steam reduction is turned off, a large amount of steam will escape when the door is opened.

## Oven interior lighting

For energy-saving reasons, the oven interior lighting has been set at the factory to go out after the program has begun.

If you want it to stay on all the time the oven is on, you will need to alter the default setting (see “Lighting” under “Settings”).

If the door is left open at the end of a cooking program, the oven interior lighting will turn off automatically after 5 minutes.

If the *Light* sensor button on the control panel is touched, the oven compartment lighting will come on for 15 seconds.

### Miele@home

Your steam oven is equipped with an integrated WiFi module.

To use this feature, you will need:

- a WiFi network
- the Miele app
- a Miele user account You can create a user account via the Miele app.

The Miele@mobile app will guide you as you connect your steam oven to your home WiFi network.

Once your steam oven is connected to your WiFi network, you can use the app for a number of actions, including the following:

- Call up information on the operating status of your steam oven
- Retrieve information on cooking processes that are in progress
- Stop cooking programs that are in progress

Connecting your steam oven to your WiFi network will increase energy consumption, even when the steam oven is turned off.

Make sure that the signal of your WiFi network is sufficiently strong in the place where your steam oven is installed.

### Availability of the Wi-Fi connection

The Wi-Fi connection shares a frequency range with other appliances (including microwave ovens and remote control toys). This can cause sporadic or even complete connection failures. Therefore, the availability of featured functions cannot be guaranteed.

### Miele@home availability

The ability to use the Miele app depends on the availability of the Miele@home service in your country.

The Miele@home service is not available in every country.

For information about availability, please visit [www.miele.com](http://www.miele.com).

### Miele App

The Miele App is available to download free of charge from the Apple App Store® or from the Google Play Store™.



# Before first use

---

## Basic settings

You must make the following settings before starting up for the first time. You can change these settings again at a later time (see “Settings”).

 Danger of injury caused by hot surfaces.  
The steam oven gets hot during operation.  
For safety reasons, the steam oven may only be used when it has been fully installed.

The steam oven will turn on automatically when it is connected to the electricity supply.

## Setting the language

- Select the desired language.

If you have accidentally selected a language that you don't understand, proceed as described in “Settings – Language ▾”.

## Setting the location

- Select the required location.

## Setting up Miele@home

Set up Miele@home? will appear on the display.

- To set up Miele@home immediately, select Continue.
- To set it up at a later date, select Skip. See “Settings – Miele@home” for information on setting up at a later date.
- To set up Miele@home immediately, select the connection method you want to use.

You will then be guided by the display and the Miele app.

## Setting the date

- Set the day, then the month, and finally the year.
- Confirm with *OK*.

## Setting the time

- Set the time of day in hours and minutes.
- Confirm with *OK*.

## Setting the water hardness

Your local water authority will be able to tell you the hardness of the water in your area.

More information can be found under in “Water hardness” under “Settings”.

- Set the water hardness level for your area.
- Confirm with *OK*.

## Completing the commissioning process

- Follow any further instructions on the display.

The appliance is now ready for use.

## Switching on cabinet front detection

If the steam oven was built in behind a cabinet front (e.g., a door), cabinet front detection must be switched on.

- Select Settings  | Furniture front recognition | On.

## Cleaning for the first time

- Remove any protective wrapping and stickers from the steam oven and accessories.

The appliance has undergone a function test in the factory. Residual water from this testing may have dripped from the lines into the oven cavity during transportation.

## Cleaning the water container



Risk of injury caused by control panel.

You could get caught in the control panel as it opens or closes.

Do not touch the upper edge of the door when the control panel is opening and closing.

- Turn the steam oven on using the  On/Off sensor control.
- Select the *Lift Panel* sensor control to open the control panel.
- Remove the water container. To do this, push it upward slightly as you take it out of the appliance.
- Rinse the water container by hand or in the dishwasher.
- Push the water container back into the appliance.
- Select the *Lift Panel* sensor control to close the control panel.

The message **Press the OK button to close the lift-up control panel** will appear.

- Confirm with *OK*.

## Cleaning the accessories/oven compartment

- Take all accessories out of the oven compartment.
- Wash the cooking containers by hand or in the dishwasher.

The universal tray and wire rack surfaces are treated with PerfectClean and must **only** be washed by hand. See “PerfectClean” under “Cleaning and care for the steam oven”.

- Clean the universal tray and the wire rack with a clean sponge and a solution of hot water and liquid dish soap.

The interior of the steam oven has been treated at the factory with a conditioning agent.

- To remove this, clean the oven compartment with a clean sponge and a mild solution of liquid dish soap and hot water.

## Before first use

### Setting the correct boiling point for water

Before cooking food for the first time, you must adjust the steam oven to the boiling temperature of the water, which varies depending on the altitude of where the steam oven is located. This process also flushes out the components of the appliance that carry water.

This procedure **must** be carried out to ensure efficient functioning of your appliance.

- Then run the steam oven for 15 minutes using the Steam Cooking  operating mode (212°F (100°C)). Proceed as described in “Operation”.

### Setting the correct boiling point for water following a house move

If you move house, the boiling point for the water in the steam oven will need to be reset for the new altitude if this differs from the old one by 984 ft (300 m) or more. To do this, descale the appliance (see “Maintenance” under “Cleaning and care for the steam oven”).

### Heating up the steam oven

- Take all accessories out of the oven compartment if applicable.
- To remove the grease from the ring heater element, heat the steam oven up to 395°F (200°C) using the Convection Bake  operating mode for 30 minutes. Proceed as described in “Operation”.

 Danger of injury caused by hot surfaces.





The steam oven gets hot during operation. You could burn yourself on the heater elements, oven compartment, or side racks.

Use pot holders when working in the hot oven compartment.

The heater element will give off a slight smell when it is heated for the first time. The smell and any vapors given off will dissipate after a while and do not indicate a faulty connection or appliance.

It is important to ensure that the kitchen is well ventilated during this operation.

## Settings overview

| Menu option  | Available settings   |
|--|--|
| Language  | ...   deutsch   english   ...<br>Location  |
| Time   | Display<br>On*   Off   Night dimming<br>Clock type<br>Analog*   Digital<br>Clock format<br>24 h*   12 h (am/pm)<br>Set   |
| Date   |  |
| Lighting   | On<br>"On" for 15 seconds*<br>Off  |
| Start screen   | Main menu*<br>Operating modes<br>Automatic Programs<br>Special Modes<br>Favorites<br>MyMiele   |
| Display  | Brightness<br><br>Color scheme<br>Bright   Dark*<br>QuickTouch<br>On   Off*   |
| Volume   | Buzzer Tones<br><br>Keypad Tone<br><br>Welcome Melody<br>On*   Off |
| Units of Measurement   | Weight<br>g*   lb   lb/oz<br>Temperature<br>°C*   °F   |

\* Factory default

# Settings

| Menu option                 | Available settings  |
|-----------------------------|---|
| Keep warm                   | On<br>Off*  |
| Steam reduction             | On*<br>Off  |
| Recommended temperatures    |   |
| Booster                     | On*<br>Off  |
| Automatic Rinse             | On*<br>Off  |
| Water hardness              | 1°dH   ...   21°dH*   ...   70°dH   |
| MotionReact                 | Switch the light on<br>during cooking program*   always on   Off<br>Switch the appliance on<br>On   Off*<br>Acknowledge buzzer<br>On*   Off         |
| Safety                      | System Lock <br>On   Off*<br>Sensor Lock<br>On   Off*              |
| Furniture front recognition | On<br>Off*  |
| Miele@home                  | Activate<br>Deactivate<br>Connection status<br>Set up again<br>Reset<br>Set up  |
| Remote Control              | On*<br>Off  |
| SuperVision                 | SuperVision display<br>On   Off*<br>Display in standby<br>On*   Only if there is a fault<br>Appliance list<br>Display this Appliance   Buzzer Tones |

\* Factory default



| Menu option             | Available settings   |
|-------------------------|--|
| RemoteUpdate            | On*<br>Off   |
| Software version        |  |
| Legal information       | Open Source Licenses   |
| Showroom Program        | Demo Mode<br>On   Off*   |
| Factory default         | Appliance settings<br>Favorites<br>MyMiele<br>Recommended temperatures |
| Operating hours (total) |  |

\* Factory default

# Settings

---

## Opening the Settings menu

In the  Settings menu, you can personalize your steam oven by adjusting the factory default settings to suit your requirements.

From the main menu:

- Select  Settings.
- Select the setting you want.



You can check settings or change them.

You cannot change settings while a cooking process is in progress.

## Language

You can set your language and location.

After selecting and confirming your choice, the language you have selected will appear on the display.

**Tip:** If you have accidentally selected a language that you don't understand, select  in the main menu. Follow the  symbol to get back to the Language  submenu.

## Time

### Display

Select how you want the time of day to appear in the display when the steam oven is turned off:

- On  
The time is always visible in the display.  
If you also select the Display | Quick-Touch | On setting, all sensor buttons will react to touch straight away and the motion sensor will automatically detect when you approach the display. If you also select the Display | Quick-Touch | Off setting, the steam oven has to be turned on before it can be used.
- Off  
The display appears dark to save energy. The steam oven has to be turned on before you can use it.
- Night dimming  
To save energy, the time only shows on the display between 5:00 a.m. and 11:00 p.m. The display remains dark at all other times.

## Clock type

The time of day can be displayed as Analog (with a clock face) or Digital (h:min) format.

With the digital display, the date is also shown.

## Clock format

The time of day can be displayed in the 24 or 12-hour format (24 h or 12 h (am/pm)).

## Set

Set the hours and the minutes.

**Tip:** If no cooking program is in progress, tap the time in the header to change it.

If there is a power failure, the current time of day will reappear once the power has been restored. The time of day is saved for approx. 150 hours.

If the steam oven has been connected to a WiFi network and signed into the Miele@mobile app, the time will be synchronized based on the location setting in the Miele@mobile app.

## Date

Set the date.

When the steam oven is turned off, the date will only appear in the display if Time | Clock type | Digital is selected.

## Lighting

- On  
The oven interior lighting is turned on during the entire cooking process.
- "On" for 15 seconds  
The oven interior lighting turns off 15 seconds after a cooking process has begun. Press the *Light* sensor button to turn the oven interior lighting on again for 15 seconds.
- Off  
The oven interior lighting is turned off. Press the *Light* sensor button to turn the oven interior lighting on for 15 seconds.

## Start screen

The steam oven is set at the factory for the main menu to appear when the steam oven is turned on. You can change this default setting so that, for instance, the operating modes or MyMiele settings appear on the start screen (see "MyMiele").

This new start screen will then appear when the steam oven is next turned on.

Select the *Back* sensor button or follow the path in the header to get to the main menu.



# Settings

---

## Display

### Brightness

The display brightness is represented by a segment bar.

-  Maximum brightness
-  Minimum brightness

### Color scheme

Choose between a light or dark color scheme for the display.

- Bright  
The display has a light background with dark characters.
- Dark  
The display has a dark background with light characters.

### QuickTouch

Select how the sensor buttons and the motion sensor should respond when the steam oven is turned off:



- On  
If you have also selected the Time | Display | On or Night dimming setting, the sensor buttons and the motion sensor will also respond when the steam oven is turned off.
- Off  
Regardless of whether Time | Display is set, the sensor buttons and the motion sensor only respond when the steam oven is turned on, as well as for a certain amount of time after turning it off.

## Volume

### Buzzer Tones



If audible signals are turned on, an audible signal will sound when the set temperature is reached and at the end of a set time.

The volume of the audible signals is represented by a segment bar.

-  Maximum volume
-  Audible signals are switched off

### Keypad Tone

The volume of the tone that sounds each time you tap a sensor button is represented by a segment bar.

-  Maximum volume
-  Keypad tone is turned off

### Welcome Melody

The melody that sounds when you tap the  On/Off button can be turned on or off.

## Units of Measurement

### Weight

For automatic programs, you can set the weight of food in grams (g), pounds (lb), or pounds/ounces (lb/oz).

### Temperature

You can set the temperature in Celsius (°C) or Fahrenheit (°F).

### Keeping warm

Using the Keep warm function, you can keep food warm at the end of a steam cooking program. Food is kept warm at a preset temperature for a maximum of 15 minutes. You can cancel the keeping warm process by opening the door.

Please note that delicate food, especially fish, can continue cooking while being kept warm.

- On  
The Keep warm function is turned on. When cooking at a temperature of approx. 175°F (80°C) or above, this function becomes active after approx. 5 minutes. The food is kept warm at a temperature of 160°F (70°C).
- Off  
The Keep warm function is turned off.

## Steam reduction

The Steam reduction function stops excessive steam escaping when the door is opened.

- On  
The steam-reduction function will turn on automatically at the end of a cooking program which uses a temperature of over approx. 175°F (80°C) (steam cooking) or 175–212°F (80–100°C) and 100% moisture (Combi-Steam). Steam reduction will appear in the display.
- Off  
If steam reduction is turned off, the Keep warm function is also automatically turned off. When steam reduction is turned off, a large amount of steam will escape when the door is opened.

## Recommended temperatures

If you often cook with temperatures that differ from the default, the recommended temperatures can be changed.

After you select this menu option, a list of operating modes will appear on the display.

- Select the operating mode you want to use.  
The recommended temperature will appear together with the range within which it can be changed.
- Change the recommended temperature.
- Confirm with *OK*.

# Settings

---

## Booster

The **Booster** function is used to quickly preheat the oven.

- On

The **Booster** function is automatically turned on during the preheating phase of a cooking program. The browning/broiling element, ring heating element, and fan all preheat the oven compartment to the required temperature at the same time.

- Off

The **Booster** function is turned off during the preheating phase of a cooking program. Only the heating elements for the selected operating mode are used to preheat the oven compartment.

You can also use the pull-down menu to turn the **Booster** function on or off for a cooking program.

## Automatic rinsing

Following a cooking program with steam, **Appliance rinsing** will appear in the display after the steam oven has been turned off.

This process flushes any remaining food deposits out of the system.

You can activate or deactivate the automatic rinsing process.

## Water hardness

The steam oven must be adjusted to the local water hardness level to ensure that it works correctly and to ensure that descaling is carried out at the correct interval. The harder the water is, the more frequently the steam oven needs to be descaled. Your local water authority will be able to tell you the hardness of the drinking water in your area.

If you are using an on-site water softener, match the setting on the steam oven to the value set on the water softener.

If you are using an on-site system to fully demineralize the water (e.g., a reverse osmosis system), the system must be set so the conductivity of the treated water is at least 100  $\mu\text{S}/\text{cm}$ . In the case of most water qualities, this can be achieved by setting a water hardness of at least 3.1 gpg (3°dH) rather than fully demineralizing the water. The conductivity is required for the fill level detection in the steam generator. Match the setting on the steam oven to the value set on the full demineralization system.

If you are using bottled water, it must comply with the relevant national regulations for drinking water quality. Do not use mineral water or carbonated water. Adjust the setting on the steam oven depending on the calcium content. The calcium content is specified on the label of the bottle in mg/l  $\text{Ca}^{2+}$  or ppm (mg/l  $\text{CaCO}_3$ ).

| Water hardness |     |        | Calcium content<br>mg/l $\text{Ca}^{2+}$ | Calcium carbon-<br>ate content<br>ppm (mg/l $\text{CaCO}_3$ ) | Setting on steam<br>oven |
|----------------|-----|--------|--|---|--------------------------|
| °dH            | gpg | mmol/l |  |   |                          |
| 1              | 1   | 0.18   | 7  | 18  | 1                        |
| 2              | 2   | 0.36   | 14                                       | 36  | 2                        |
| 3              | 3   | 0.54   | 21                                       | 54  | 3                        |
| 4              | 4   | 0.72   | 29                                       | 71  | 4                        |
| 5              | 5   | 0.90   | 36                                       | 89  | 5                        |
| 6              | 6   | 1.07   | 43                                       | 107   | 6                        |
| 7              | 7   | 1.25   | 50                                       | 125   | 7                        |
| 8              | 8   | 1.43   | 57                                       | 143   | 8                        |
| 9              | 9   | 1.61   | 64                                       | 161   | 9                        |
| 10             | 10  | 1.79   | 71                                       | 179   | 10                       |
| 11             | 11  | 1.97   | 79                                       | 196   | 11                       |
| 12             | 12  | 2.15   | 86                                       | 214   | 12                       |
| 13             | 14  | 2.33   | 93                                       | 232   | 13                       |
| 14             | 15  | 2.51   | 100                                      | 250   | 14                       |
| 15             | 16  | 2.69   | 107                                      | 268   | 15                       |
| 16             | 17  | 2.86   | 114                                      | 286   | 16                       |

# Settings

| Water hardness |       |             | Calcium content<br>mg/l Ca <sup>2+</sup> | Calcium carbon-<br>ate content<br>ppm (mg/l CaCO <sub>3</sub> ) | Setting on steam<br>oven |
|----------------|-------|-------------|--|---|--------------------------|
| °dH            | gpg   | mmol/l      |  |   |                          |
| 17             | 18    | 3.04        | 121                                      | 304   | 17                       |
| 18             | 19    | 3.22        | 129                                      | 321   | 18                       |
| 19             | 20    | 3.40        | 136                                      | 339   | 19                       |
| 20             | 21    | 3.58        | 143                                      | 357   | 20                       |
| 21             | 22    | 3.76        | 150                                      | 375   | 21                       |
| 22             | 23    | 3.94        | 157                                      | 393   | 22                       |
| 23             | 24    | 4.12        | 164                                      | 411   | 23                       |
| 24             | 25    | 4.30        | 171                                      | 429   | 24                       |
| 25             | 26    | 4.47        | 179                                      | 446   | 25                       |
| 26             | 27    | 4.65        | 186                                      | 464   | 26                       |
| 27             | 28    | 4.83        | 193                                      | 482   | 27                       |
| 28             | 29    | 5.01        | 200                                      | 500   | 28                       |
| 29             | 30    | 5.19        | 207                                      | 518   | 29                       |
| 30             | 31    | 5.37        | 214                                      | 536   | 30                       |
| 31             | 32    | 5.55        | 221                                      | 554   | 31                       |
| 32             | 33    | 5.73        | 228                                      | 571   | 32                       |
| 33             | 34    | 5.91        | 236                                      | 589   | 33                       |
| 34             | 35    | 6.09        | 243                                      | 607   | 34                       |
| 35             | 36    | 6.27        | 250                                      | 625   | 35                       |
| 36             | 38    | 6.44        | 257                                      | 643   | 36                       |
| 37–45          | 39-47 | 6.62–8.06   | 264–321                                  | 661–804   | 37–45                    |
| 46–60          | 48-63 | 8.23–10.74  | 328–428                                  | 821–1,071   | 46–60                    |
| 61–70          | 64-73 | 10.92–12.53 | 436–500                                  | 1,089–1,250   | 61–70                    |



## MotionReact

The motion sensor detects when you approach the touch display, e.g., with your hand or body.

If you want the motion sensor to respond even when the steam oven is turned off, select the **Display | Quick-Touch | On** setting.

## Switch the light on

- during cooking program  
As soon as you approach the touch display during a cooking process, the oven interior lighting turns on. The oven interior lighting automatically turns off again after 15 seconds.
- always on  
As soon as you approach the touch display, the oven interior lighting turns on. The oven interior lighting automatically turns off again after 15 seconds.
- Off  
The proximity sensor does not respond when you approach the touch display. Press the *Light* sensor button to turn the oven interior lighting on for 15 seconds.

## Switch the appliance on

- On  
If the time is displayed, the steam oven turns on and the main menu appears as you approach the touch display.
- Off  
The motion sensor does not respond when you approach the touch display. Turn the steam oven on using the  On/Off sensor button.

## Acknowledge buzzer

- On  
As soon as you approach the touch display, the audible signals turn off.
- Off  
The proximity sensor does not respond when you approach the touch display. Turn the audible signals off manually.

# Settings

---

## Safety

### System Lock

The system lock prevents the steam oven being turned on by mistake.

You can still set an alarm and a timer, as well as use the MobileStart function when the system lock is active.

The system lock will remain activated even after a power outage.

- On  
The system lock is now active. Before you can use the steam oven, turn it on and touch the  symbol for at least 6 seconds.
- Off  
The system lock is now deactivated. You can use the steam oven as normal.

### Sensor Lock

The sensor lock prevents the cooking program from being turned off by mistake or settings from being changed. Once activated, the sensor lock prevents the sensor buttons and fields on the display from working for a few seconds after a program has been started, with the exception of the  On/Off button.

- On  
The sensor lock is active. Touch *OK* for at least 6 seconds to deactivate the sensor lock for a short period of time.
- Off  
The sensor lock is not active. All sensor buttons react to touch as normal.

## Furniture front recognition

- On  
Cabinet door front recognition is activated. Using the motion sensor, the steam oven automatically detects whether the door panel is closed.  
If the door panel is closed, the steam oven turns off automatically after a certain period.
- Off  
Cabinet door front recognition is deactivated. The steam oven does not detect whether the door panel is closed.

If the steam oven is installed behind a cabinet front (e.g., a door), the steam oven, housing unit, and the floor can be damaged by the build-up of heat and moisture behind the closed cabinet front.

Always leave the door panel open when you are using the steam oven. Leave the door panel open until the steam oven has cooled down completely.

## Miele@home

The steam oven is a Miele@home-compatible appliance with SuperVision functionality.

Your steam oven is fitted with a WiFi communication module and is suitable for wireless communication.

There are a number of ways of connecting your steam oven to your WiFi network. We recommend connecting your steam oven to your WiFi network using the Miele@mobile app or via WPS.

- Activate  
This setting is only visible if Miele@home is deactivated. The WiFi function is reactivated.
- Deactivate  
This setting is only visible if Miele@home is activated. Miele@home remains set up; the WiFi function is turned off.
- Connection status  
This setting is only visible if Miele@home is activated. The display shows information such as the WiFi reception quality, network name, and IP address.
- Set up again  
This setting is only visible if a WiFi network has already been set up. Reset the network settings and set up a new network connection straight away.
- Reset  
This setting is only visible if a WiFi network has already been set up. The WiFi function is deactivated and the WiFi connection will be reset to the factory default. You must set up a new WiFi connection to be able to use Miele@home.

The network settings should be reset whenever a steam oven is being disposed of or sold, or if a used steam oven is being put into operation. This is the only way to ensure that all personal data has been removed and the previous owner will no longer be able to access the steam oven.

- Set up  
This setting is only visible if no WiFi connection has been set up yet. You must set up a new WiFi connection to be able to use Miele@home.

## Performing Scan & Connect

Initial commissioning has been carried out without Miele@home having been set up.

- Scan the QR code.

If you have installed the Miele app and have a user account, you will be taken directly to the networking steps.

If you have not yet installed the Miele app, you will be taken to the Apple App Store® or the Google Play Store™.

- Install the Miele app and set up a user account.
- Scan the QR code again.

The Miele app will guide you through the setup process.



# Settings

## Remote Control

If you have installed the Miele app on your mobile device, have access to the Miele@home system, and have activated the remote control function (On), you can use the MobileStart function and, for example, retrieve information about steam oven cooking processes that are in progress or to end a process that is in progress.

### Activating MobileStart

- Select the *Remote* sensor button to activate MobileStart.

The *Remote* sensor button lights up. You can operate your steam oven remotely with the Miele app.

Directly operating on the steam oven takes priority over operating it via the remote control function on the app.

You can use MobileStart as long as the *Remote* sensor button is lit up.

## SuperVision

The steam oven is a Miele@home-compatible appliance with SuperVision functionality for monitoring other household appliances in the Miele@home system.

The SuperVision function cannot be activated until the Miele@home system has been set up.

### SuperVision display

- On  
The SuperVision function is turned on. The  symbol will appear in the top right-hand corner of the display.
- Off  
The SuperVision function is turned off.

## Display in standby

The SuperVision function is also available when the oven is in standby. However, the time-of-day display must be turned on (Settings | Time | Display | On).

- On  
Active domestic appliances that are signed on to the Miele@home system are always displayed.
- Only if there is a fault  
Only faults on active domestic appliances are displayed.

## Appliance list

All domestic appliances signed on to the Miele@home System are displayed. Once you have selected an appliance, you can access further settings:

- Display this Appliance
  - On  
The SuperVision function for this appliance is turned on.
  - Off  
The SuperVision function for this appliance is turned off. The appliance is still signed on to the Miele@home system. Faults are displayed, even if the SuperVision function for the appliance has been turned off.
- Buzzer Tones  
You can select whether the audible signals are turned on (On) or turned off (Off) for this appliance.

## RemoteUpdate

The RemoteUpdate menu option is only displayed and can only be selected if the requirements for using Miele@home have been met (see “Before first use – Miele@home”).

The RemoteUpdate function is used for updating the software in your steam oven. If an update is available for your steam oven, it will automatically download it. Updates will not be installed automatically. They must be initiated manually.

If you do not install an update, you can continue to use your steam oven as usual. However, Miele recommends installing updates.

### Activating/deactivating

The RemoteUpdate function is activated as standard. Available updates will be downloaded automatically but will only be installed if you initiate installation manually.

Deactivate RemoteUpdate if you do not want any updates to be downloaded automatically.

## Running a RemoteUpdate

Information about the content and scope of an update is provided in the Miele app.

A message will appear in your steam oven display if a software update is available.

You can install the update immediately or postpone this until later. When the steam oven is turned on again, you will be reminded about the update.

Deactivate RemoteUpdate if you do not want to install the update.

The update may take several minutes.

Please note the following information about the RemoteUpdate function:

- You will only receive a message when an update is available.
- Once an update has been installed, it cannot be undone.
- Do not turn the steam oven off during the update. Otherwise, the update will be aborted and will not be installed.
- Some software updates can only be carried out by Miele Customer Service.

# Settings

---

## Software version

The software version menu option is for use by Miele Technical Service. You do not need this information for domestic use.

- Confirm with *OK*.

## Legal information

You can find an overview of the integrated open-source components under Open Source Licenses.

- Confirm with *OK*.

## Showroom Program

This function enables the steam oven to be demonstrated in showrooms without heating up. Do not activate this setting for domestic use.

## Demo Mode

If you have demo mode activated, Demo mode is active. The appliance will not heat up will appear when you turn the steam oven on.

- On  
Touch *OK* for at least 4 seconds to activate demo mode.
- Off  
Touch *OK* for at least 4 seconds to deactivate demo mode. You can use the steam oven as normal.

## Factory default

- Appliance settings  
Any settings that have been altered will be reset to the factory default settings.
- Favorites  
All Favorites will be deleted.
- MyMiele  
All MyMiele entries will be deleted.
- Recommended temperatures  
Any recommended temperatures that have been changed will be reset to the factory default settings.

## Operating hours (total)

Select *Operating hours (total)* to query the total number of operating hours of your steam oven.

Using the *Timer* sensor button, you can set a timer (e.g., for boiling eggs) or an alarm for a specific time.



Two alarms, two timers, or an alarm and a timer can be set simultaneously.

## Using the Alarm function

The  alarm can be used to specify a particular time for an audible signal to sound.

### Setting the alarm

If the Display | QuickTouch | Off setting is selected, you will need to turn the steam oven on before setting the alarm. The alarm time will then appear on the display when the steam oven is turned off.

- Select the *Timer* sensor button.
- Select  Alarm.
- Set the time for the alarm.
- Tap  to confirm.

When the steam oven is turned off, the alarm time and  will appear instead of the time of day.

If you are cooking at the same time or if you are in a different menu, the alarm time and  will appear in the top right-hand corner of the display.

At the specified time for the alarm,  will flash on the display next to the time and an audible signal will sound.

- Select the *Timer* sensor button or the set alarm time on the display.

The audible signal will stop and the symbols on the display will go out.

### Changing an alarm

- Select the alarm on the display or select the *Timer* sensor button and the alarm you want.

The set alarm time will appear on the display.

- Set the new time for the alarm.
- Tap  to confirm.

The adjusted alarm time is now saved and will appear on the display.

### Deleting an alarm

- Select the alarm on the display or select the *Timer* sensor button and the alarm you want.

The set alarm time will appear on the display.

- Select .
- Tap  to confirm.

The alarm is deleted.

# Alarm + Timer

---

## Using the Timer function

The  timer can be used to time other activities in the kitchen, e.g., boiling eggs.

The timer can also be used at the same time as a cooking program for which the start and finish times have been set (e.g., as a reminder to stir the food or add seasoning, etc.).

- The maximum timer duration that can be set is 59 minutes and 59 seconds.

## Setting the timer

If you have selected the `Display | Quick-Touch | Off` setting, you will need to turn the steam oven on before setting the timer. The timer can then be seen counting down on the display when the steam oven is turned off.

Example: you want to boil some eggs and set a timer of 6 minutes and 20 seconds.

- Select the *Timer* sensor button.
- Select  *Timer*.
- Set the required timer duration.
- Tap `Close` to confirm.

When the steam oven is turned off, the timer time counts down in the display and  appears instead of the time of day.

If you are cooking at the same time or if you are in a different menu, the timer duration and  will appear in the top right-hand corner of the display.

At the end of the timer duration,  will flash, the time will start counting up, and an audible signal will sound.

- Select the *Timer* sensor button or the required timer on the display.

The audible signal will stop and the symbols on the display will go out.

## Changing the timer

- Select the timer on the display or select the *Timer* sensor button and then the timer duration you want.

The set timer duration will appear.

- Set a new timer duration.
- Tap `Close` to confirm.

The changed timer duration is now saved and will count down in minutes. Timer durations of less than 10 minutes will count down in seconds.

## Deleting the timer

- Select the timer on the display or select the *Timer* sensor button and then the timer duration you want.

The set timer duration will appear.



















- Select `Delete`.
- Tap `Close` to confirm.

The timer is deleted.









## Main and submenus





As different countries have different preferences when it comes to preparing food, the temperatures in °F and °C may not match. The temperatures are defined as they are specified in the table.

| Menu   | Recommended value | Range                 |
|--|-------------------|-----------------------|
| Operating Modes       |                   |                       |
| Convection Bake       | 320°F (160°C)     | 85–450°F (30–230°C)   |
| Convection Roast      | 375°F (190°C)     | 85–450°F (30–230°C)   |
| Surround              | 355°F (180°C)     | 85–450°F (30–230°C)   |
| Combi Steam           |                   |                       |
| Combi Conv Bake       | 340°F (170°C)     | 85–450°F (30–230°C)   |
| Combi Surround        | 355°F (180°C)     | 85–435°F (30–230°C)   |
| Combi Broil           | Level 3           | Level 1–3             |
| Steam Cooking         | 212°F (100°C)     | 105–212°F (40–100°C)  |
| Sous-vide             | 150°F (65°C)      | 115–195°F (45–90°C)   |
| Intensive             | 355°F (180°C)     | 120–450°F (50–230°C)  |
| Bake                  | 375°F (190°C)     | 210–395°F (100–200°C) |
| Browning              | 375°F (190°C)     | 210–450°F (100–230°C) |
| Maxi Broil           | Level 3           | Level 1–3             |
| Broil               | Level 3           | Level 1–3             |
| Convection Broil    | 395°F (200°C)     | 120–450°F (50–230°C)  |
| Humidity Plus       | 320°F (160°C)     | 85–450°F (30–230°C)   |
| Automatic Programs  |                   |                       |
| Special Modes       |                   |                       |
| Reheat   | 265°F (130°C)     | 250–285°F (120–140°C) |
| Defrost  | 140°F (60°C)      | 120–140°F (50–60°C)   |

## Main and submenus

| Menu  | Recommended value | Range                |
|---|-------------------|----------------------|
| Special Modes    |                   |                      |
| Miele Mix & Match   |                   |                      |
| Crisp Cooking   | —                 | —                    |
| Gentle Cooking  | —                 | —                    |
| Crisp Reheating   | —                 | —                    |
| Gentle Reheating  | —                 | —                    |
| Blanch  | —                 | —                    |
| Canning   | 195°F (90°C)      | 175–212°F (80–100°C) |
| Dehydrate   | 120°F (50°C)      | 85–160°F (30–70°C)   |
| Proof   | —                 | —                    |
| Menu Cooking  | —                 | —                    |
| Sanitize Cookware   | —                 | —                    |
| Sabbath Program   | 355°F (180°C)     | 120–450°F (50–230°C) |
| Warm-up Cookware  | 120°F (50°C)      | 120–175°F (50–60°C)  |
| Keep warm   | 150°F (65°C)      | 105–212°F (40–100°C) |
| MyMiele   |                   |                      |
| Favorites   |                   |                      |
| Settings   |                   |                      |
| Maintenance    |                   |                      |
| Descalc   |                   |                      |
| Soak  |                   |                      |
| Drying  |                   |                      |
| Rinse   |                   |                      |

## Cooking programs

- Remove all accessories from the oven that are not required for a cooking program.
- If a temperature range is given, it is best to select the lower temperature and check the food after the shortest cooking time given.
- Preheat the oven only if instructed to do so in the recipe or the cooking chart.
- Try not to open the door when cooking.
- Dark, matte tins are best for baking. They absorb the heat more effectively and transmit it to the mixture more quickly. Shiny materials such as stainless steel or aluminum reflect the heat and therefore can give a more uneven result. Do not cover the oven floor or the wire rack with heat-reflecting aluminum foil.
- Monitor cooking durations to avoid wasting energy when cooking. Set the cooking duration, or use a food probe if you have one.
- Most food can be cooked using Convection Bake  or Convection Roast . Because the fan distributes the heat in the oven compartment straight away, it allows you to use a lower temperature than you would with Surround . It also enables you to cook on multiple shelf levels at the same time.
- Convection Broil  is the best operating mode for broiled dishes. Lower temperatures can be used than with other broil modes that use the maximum temperature setting.

- Whenever possible you should cook several dishes at the same time. Place them next to each other in the oven or on different shelf levels.
- Dishes which you are unable to prepare at the same time should, if possible, be cooked one after the other in order to make use of existing heat in the oven.

## Settings

- Select the Display | QuickTouch | Off setting for the control elements in order to reduce energy consumption.
- Select the Lighting | Off or "On" for 15 seconds setting for the oven interior lighting. You can turn the oven interior lighting on again at any time by tapping the *Light* sensor button.

## Energy-saving mode

The steam oven will turn itself off automatically to save energy if a program is not being run and controls have not been operated. The time of day will appear on the display or the display will remain dark (see "Settings").

## Operation

Malfunction due to missing floor filter.

If the floor filter is missing, food deposits can get into the drain. The water cannot be pumped away.

Before each cooking program, check that the filter in the floor of the oven compartment is correctly fitted.

- Turn the steam oven on.

The main menu will appear.

- Place the food in the oven.
- Select Operating Modes .
- Select the operating mode you want to use.

The operating mode and recommended values for temperature and moisture (if applicable) appear.

- Change the recommended values if necessary.

The recommended values will be automatically accepted within a few seconds. You can change the temperature and moisture level later by selecting the temperature or moisture indicator.

- Confirm with *OK*.

The required and the actual temperature will appear and the preheating phase will begin.

You will see the temperature rising on the display. An audible signal will sound when the set temperature is reached for the first time.

- After the cooking program, select *Finish*.

The steam-reduction function will turn on automatically at the end of a cooking program which uses a temperature of over approx. 175°F (80°C) (steam cooking) or 175–212°F (80–100°C) and 100% moisture (Combi-Steam).

Wait until Steam reduction goes out in the display before opening the door.

- Take the food out of the oven.

### Cleaning the steam oven

- Remove the water container and empty it as required.
- Turn the steam oven off.

Appliance rinsing appears after a cooking program involving steam.

- Follow the instructions on the display.

The rinsing process should be carried out every time to flush any remaining food deposits out of the system.

- Clean and dry the whole steam oven as described in “Cleaning and care for the steam oven”.
- Leave the appliance door open until the oven compartment is completely dry.

## Changing values and settings for a cooking program

Depending on the operating mode, as soon as a cooking program is in progress, you can change the values or settings for this program.

Depending on the operating mode, you can change the following settings:

- Temperature
- Moisture
- Duration
- Booster
- Preheat
- Crisp function

## Changing the temperature and core temperature

Via Settings | Recommended temperatures, you can permanently adjust the recommended temperature to suit your cooking preferences.

The  core temperature only appears if you are using the probe (see “Roasting – Probe”).

- Tap the temperature display.
- Change the temperature and the  core temperature as required.
- Confirm with *OK*.

The cooking program will resume with the new target temperatures.

## Changing Moisture

- Touch the moisture indicator.
- Change the moisture level.
- Confirm with *OK*.

The program will continue to run at the new moisture level.

# Operation

## Setting additional durations

Cooking results can be adversely affected if there is a long delay between the food being placed in the oven and the start of cooking. Fresh food can change color and even spoil. When baking, the cake mixture or dough can dry out, and the raising agents can lose their effectiveness. Select as short a time as possible until the start of the cooking process.

You have placed the food in the oven compartment, selected an operating mode and the required settings such as the temperature.

By entering **Duration**, **Ready at** or **Start at**, you can automatically turn the cooking process off or on and off.

- **Duration**  
Enter the required cooking duration for the food. The oven heating will turn off automatically once the cooking duration has elapsed. The maximum cooking duration that can be set depends on the operating mode that you have selected.
- **Ready at**  
Specify when you want the cooking process to finish. The oven will turn off automatically at the time you have set.
- **Start at**  
This function will only appear in the menu if you have set a **Duration** or **Ready at** time. With **Start at**, you have to specify when you want the cooking process to start. The oven will turn on automatically at the time you have set.

- Select  or **Timer**.
- Set the required times.
- Confirm with **OK**.

When cooking with steam, the cooking duration does not begin until the set required temperature is reached.

The steam reduction function will switch on at the end of a cooking process which uses a temperature of over approx. 175°F/80°C (steam cooking) or 175–212°F/80–100°C and 100% moisture (Combi-Steam).

- Wait until **Steam reduction** goes out in the display before opening the door and removing the food from the oven.

## Changing set durations

- Select , the duration, or **Timer**.
- Select the time you want and change it.
- Confirm with **OK**.

These settings will be deleted in the event of a power failure.

## Deleting the set cooking durations

- Select , the duration, or **Timer**.
- Select the time you want.
- Select **Delete**.
- Confirm with **OK**.

If you delete **Duration**, the set durations for **Ready at** and **Start at** are also deleted.

If you delete **Ready at** or **Start at**, the cooking program will start using the cooking duration set.

## Canceling a cooking program

If you cancel a cooking program, the oven heating and lighting will turn off. Any cooking durations set will be deleted.

During a cooking program with steam, Steam reduction will appear if you have set a temperature above approx. 175°F (80°C) (steam cooking) or 175–212°F (80–100°C) and 100% moisture (Combi-Steam).

Select **Close** to return to the main menu.

## Canceling a cooking program without a set cooking duration

- Select **Finish**.

The main menu will appear.

## Canceling a cooking program with a set cooking duration

- Select **Cancel**.

Cancel program? will appear.

- Select **Yes**.

The main menu will appear.

## Interrupting a cooking program

A cooking program is interrupted as soon as the door is opened. The oven heating turns off.

The set cooking duration is saved when cooking with steam as well as for programs and applications with pure steam operation.

 Risk of injury due to hot steam.

When using a cooking program involving steam, a lot of hot steam can escape if the door is opened. The steam can cause burns.

Step back and wait until the hot steam has dissipated.

 Risk of injury caused by hot surfaces and food.

The steam oven gets hot during operation. You could burn yourself on the heater elements, oven compartment, side racks, accessories, or food.

Use pot holders when placing food in the appliance or removing it and when working in the hot oven compartment.

When placing cooking containers in the oven or removing them, make sure that the hot food does not spill.

The cooking program will resume when the door is closed.

The steam oven will heat up again and the display will show the temperature in the oven compartment as it rises.

When cooking with steam as well as for programs and applications with pure steam operation, the time left only continues to count down once the set temperature has been reached.

In programs using 100% moisture and temperatures up to 212°F (100°C): the cooking program will finish early if the door is opened in the last minute of cooking (55 seconds remaining).

# Operation

---

## Preheating the oven

The **Booster** function is used to quickly preheat the oven compartment in some operating modes.

The **Preheat** function can be used with any oven operating mode and has to be turned on separately for each cooking program.



The oven compartment only needs to be preheated in a few cases.

■ Preheat the oven compartment when cooking the following food:

- cakes, cookies, and pastries with a short cooking duration (approx. 30 minutes or less) as well as delicate items (e.g., sponge) with the Surround  operating mode (without the **Booster** function)

## Booster

The **Booster** function is activated as the factory default setting for the following operating modes (Settings | **Booster** | On):

- Convection Bake 
- Convection Roast 
- Surround 

If you set a temperature above 210°F (100°C) and the **Booster** function is turned on, a rapid preheating phase heats the oven compartment to the set temperature. The browning/broiling element and the ring heating element come on together with the fan.

Delicate items (e.g., sponge or cookies) will brown too quickly on the top if the **Booster** function is used. Turn off the **Booster** function for these items.

## Turning **Booster** on or off for a cooking program

If you have selected the **Booster** | On setting, you can turn the function off separately for a cooking program.

On the other hand, you can also turn on the function separately for a cooking program if you have selected the **Booster** | Off setting.

Example: You have selected an operating mode and the required settings such as the temperature.

You want to turn off the **Booster** function for this cooking program.

■ Drag down the pull-down menu.

**Booster** is highlighted in orange.

■ Select **Booster**.

Depending on the color scheme, **Booster** is highlighted in either black or white.

■ Close the pull-down menu.

The **Booster** function is turned off during the preheating phase. Only the heating elements for the selected operating mode are used to preheat the oven compartment.



## Preheat

You can place most dishes in the cold oven compartment to make use of the heat produced during the preheating phase.

If you have set a cooking duration, it will only start to count down when the target temperature is reached and you have placed the food in the oven.

Start the cooking program immediately without delaying the start time.

## Turning on Preheat

The Preheat function has to be turned on separately for each cooking program.

Example: You have selected an operating mode and the required settings such as the temperature.

You want to turn on the Preheat function for this cooking program.

- Drag down the pull-down menu.

Depending on the color scheme, Preheat is highlighted in either black or white.

- Select Preheat.

Preheat is highlighted in orange.

- Close the pull-down menu.

The following message will be displayed with a time: Place food in oven at . The oven compartment is heated to the set temperature.

- As soon as you are prompted to do so, place the food in the oven.
- Confirm with *OK*.









## Crisp function

The Crisp function (moisture reduction) allows moisture to be removed from the oven as required during the entire cooking process or at times during the process.

It is a good idea to use this function when cooking items which have a moist topping, e.g., quiche, pizza, tray bakes with fresh fruit toppings, or muffins.

Poultry in particular gets a nice crisp skin with this function.

The Crisp function can be used in the following operating modes:

- Convection Bake 
- Convection Roast 
- Surround 
- Intensive 
- Bake 
- Browning 
- Convection Broil 
- Humidity Plus 

# Operation

---

## Turning on Crisp function

The Crisp function function has to be turned on separately for each cooking program.

You have selected an operating mode and the required settings such as the temperature.

You want to turn on the Crisp function function for this cooking program.

- Drag down the pull-down menu.

Depending on the color scheme, Crisp function is highlighted in either black or white.

- Select Crisp function.

Crisp function is highlighted in orange.

- Close the pull-down menu.

The Crisp function function is turned on. The Crisp function function can be turned off again at any time via the pull-down menu.

## Injecting bursts of steam

You can release bursts of steam during the cooking process in all oven operating modes. The number of bursts of steam is unlimited.

You can release a burst of steam as soon as **Burst of steam** appears and **Start** is shown in green.

Please wait until the heating-up phase is completed to allow the steam to be distributed evenly in the warm air in the oven.

- Select **Start**.

The burst of steam will be released. This will take approximately 1 minute.

- Proceed as described to release further bursts of steam once **Start** is shown in green again.

## Changing the operating mode

You can change to another operating mode during a cooking program.

- Tap the symbol for the selected operating mode.
- If you have set a cooking duration, confirm the **Cancel program?** message with **Yes**.
- Select the new operating mode.

The new operating mode will appear on the display with its corresponding recommended values.

- Set the values for the cooking program and confirm with **OK**.

The “General Notes” section contains general information. You will find more detailed information about particular foods and how to cook them in the other sections.

### The advantages of cooking with steam

Almost all vitamins and minerals are retained as the food is not immersed in water.

Cooking with steam also retains the true taste of the food better than conventional cooking. We therefore recommend seasoning the food after it has been cooked. Food also retains its fresh, original color.

### Suitable containers

#### Cooking containers

Stainless-steel cooking containers are provided with the steam oven. Other containers, in a variety of sizes, both perforated and solid, are available as optional extras (see “Optional accessories”). This enables you to choose the most suitable container for the meal you are preparing.

Use perforated cooking containers for **steam cooking** if possible. The steam can reach the food from all sides and the food is cooked evenly.

#### Your own dishware

You can also use your own dishware. However, please note the following:

- Dishware must be suitable for use in an oven and able to withstand steam. With plastic dishware, please check with the manufacturer that it is suitable for use in a steam oven.

- Thick-sided dishware made from porcelain, ceramic, or stoneware is not very suitable for using with steam. Due to its thick sides, it does not conduct heat well, meaning cooking durations will be considerably longer than those given in the charts.
- Place the dishware on the wire rack or in a cooking container. Depending on the size of the dishware, you can also place the wire rack on the floor of the oven compartment with the rack surface facing up and the dishware on top. You can also take the side racks out to make more room (see “Cleaning the side racks” under “Cleaning and care for the steam oven”).
- Ensure that there is a gap between the upper rim of the dishware and the top of the oven compartment to allow sufficient steam into the dishware.

### Shelf level

You can select any shelf level. You can also cook on several levels at the same time. This will not alter the cooking duration.

When using more than one deep cooking container at the same time, it is best to offset them on their runners and to leave at least one level free in between them.

Always insert cooking containers and the rack between the rails of the shelf level supports so that they cannot tip.

## General notes

---

### Frozen food

The heating up phase for frozen food is longer than for fresh food. The greater the quantity of frozen food, the longer the preheating phase.

### Temperature

During steam cooking, the temperature does not exceed 212°F (100°C). Almost all foods can be cooked at this temperature. Some types of food, such as berries, need to be cooked at lower temperatures to prevent them from bursting. See the relevant sections in these operating instructions for more details.

### Cooking duration

During steam cooking, the cooking duration does not begin until the set temperature is reached.

In general, the cooking durations for cooking with steam are the same as for cooking food in a saucepan. More information about any factors which may affect the cooking duration is given in the relevant sections.

The quantity of food does not affect the cooking duration. 2 lb (1 kg) of potatoes will take the same time to cook as 1 lb (500 g) of potatoes.

### Cooking with liquid

When cooking with liquid only fill the cooking pan  $\frac{2}{3}$  full to prevent the liquid spilling when the cooking pan is removed from the oven.

### Your own recipes - Steam cooking

Food and recipes which are prepared in pot or a pan can also be cooked in the steam oven. The cooking times in the steam oven will be the same. Please note that food will not be brown or crisp when cooking with steam.

### Universal tray and wire rack

Use the universal tray with the wire rack placed on top of it, e.g., for roasting and broiling. During roasting, you can use the meat juices collected in the tray to make a gravy or sauce.

If you are using the universal tray with the wire rack on top, insert the universal tray between the rails of a shelf level and the wire rack will automatically slide in above them. When removing them from the oven, pull both out together.

### Non-tip safety notches

The wire rack and universal tray have non-tip safety notches in the middle which prevent them being pulled right out when they only need to be partially pulled out. The tray and rack can then only be taken out of the oven by raising them upwards and then pulling them out.

## Notes on the cooking charts

Follow the instructions on cooking durations, temperatures, and cooking notes.

## Selecting the cooking duration

The cooking durations given are guidelines only.

- We recommend selecting the shorter duration initially. You can cook for longer if necessary.

## Vegetables

### Fresh food

Prepare fresh vegetables in the usual way, i.e. wash, clean and cut them up.

### Frozen food

Frozen vegetables do not need to be defrosted beforehand unless they have been frozen together in a block.

Frozen and fresh vegetables which take the same length of time to cook can be cooked together.

If vegetables have frozen together in clumps, break these up before cooking with steam. Follow the manufacturer's instructions on the packaging regarding cooking duration.

### Steam oven pans

When each piece of the food being cooked only has a small diameter (e.g., peas, asparagus), there are no or very few gaps and the steam can hardly penetrate the food. To ensure even cooking, use a flat steam oven pan for these types of food and make sure that the food is piled no more than 1"–2" (3–5 cm) high. Divide larger amounts of food over several flat steam oven pans.

Different types of vegetables which take the same length of time to cook can be cooked together in one steam oven pan.

Vegetables that need to be cooked in liquid, such as red cabbage, must be placed in solid steam oven pans.

### Shelf level



When cooking vegetables with a distinctive color (e.g. beets) in a perforated container at the same time as cooking other foods in other containers, place the drip tray directly underneath the perforated container to catch any drips and therefore avoid any color transfer.

### Cooking duration

The cooking duration depends on the size of the food and how well cooked you want it, just as it does with conventional cooking methods. Example:  
White potatoes, cut into quarters:  
approx. 17 minutes  
White potatoes, cut in half:  
approx. 20 minutes

### Settings

Automatic Programs  | Vegetables | ... |  
or

Operating Modes  | Steam Cooking   
Temperature: 212°F (100°C)  
Duration: see chart

## Steam cooking

| Vegetables  | 🕒 [min]                 |
|---|-------------------------|
| Artichokes  | 32–38                   |
| Cauliflower, whole  | 27–28                   |
| Cauliflower, florets  | 3–8                     |
| Beans, green  | 3–10                    |
| Broccoli, florets   | 1–4                     |
| Chantenay carrots, whole                                      | 7–8                     |
| Chantenay carrots, halved                                     | 6–7                     |
| Chantenay carrots, chopped                                    | 4                       |
| Endive, halved  | 4–5                     |
| Chinese cabbage, chopped                                      | 3                       |
| Peas  | 3                       |
| Fennel, halved  | 10–12                   |
| Fennel, cut into strips                                       | 4–5                     |
| Kale, chopped   | 23–26                   |
| White potatoes, peeled<br>whole<br>halved<br>quartered        | 27–29<br>21–22<br>16–18 |
| Yukon Gold potatoes, peeled<br>whole<br>halved<br>quartered   | 25–27<br>19–21<br>17–18 |
| Idaho/Russet potatoes, peeled<br>whole<br>halved<br>quartered | 26–28<br>19–20<br>15–16 |
| Kohlrabi, cut into batons                                     | 6–7                     |
| Pumpkin, diced  | 4–10                    |
| Corn on the cob   | 11–14                   |
| Chard, chopped  | 2–3                     |
| Bell pepper, diced or cut into strips                         | 1                       |

## Steam cooking

| <b>Vegetables</b>            |  [min] |
|------------------------------|---|
| New potatoes, firm           | 30–32   |
| Mushrooms                    | 1   |
| Leeks, sliced                | 2–3   |
| Leeks, halved lengthways     | 6   |
| Romanesco, whole             | 22–25   |
| Romanesco, florets           | 5–7   |
| Brussels sprouts             | 10–12   |
| Beets, whole                 | 53–57   |
| Red cabbage, chopped         | 23–26   |
| Black salsify, whole         | 9–10  |
| Celery root, cut into batons | 6–7   |
| Green asparagus              | 3–7   |
| White asparagus, whole       | 4–9   |
| Carrots, chopped             | 3–6   |
| Fresh Spinach                | 1–2   |
| Napa cabbage, chopped        | 5–10  |
| Celery, chopped              | 3–5   |
| Rutabaga, chopped            | 6–7   |
| White cabbage, chopped       | 12  |
| Savoy cabbage, chopped       | 5–10  |
| Zucchini, sliced             | 1   |
| Snap peas                    | 3–5   |

 Cooking duration

# Steam cooking

---

## Fish

### Fresh food

Prepare fresh fish in the usual way, i.e. clean, gut and filet.

### Frozen food

Frozen fish should be slightly defrosted before cooking.

### Preparing for use

Add some lemon or lime juice to fish before cooking. The citric acid helps the flesh stay firm.

It is not necessary to season fish when cooking with steam as this method retains the minerals which give the fish its unique flavor.

### Cooking pans

If using a perforated pan, grease it first.

### Shelf level

When cooking fish in a perforated container at the same time as cooking other types of food in other containers, place the container with the fish directly above the universal tray to catch any liquid and so avoid any transfer of tastes to other food.

## Temperature

### 185–195°F (85–90°C)

For gently cooking delicate types of fish, such as sole.

### 212°F (100°C)

For cooking firmer types of fish, e.g. cod and salmon.

Also for cooking fish in sauce or stock.

## Cooking duration

The cooking duration depends on the thickness and the consistency of the food, and not on the weight. The thicker the piece of food is, the longer cooking will take. A piece of fish weighing 1 lb (500 g) that is 1" (3 cm) thick will take longer to cook than a piece weighing 1 lb (500 g) and only 1/2" (2 cm) thick.

The longer fish cooks, the firmer its flesh will become. Use the cooking durations given in the chart. If you find that the fish is not cooked sufficiently only cook it for a few minutes more.

When cooking fish in sauce or stock, we recommend that you increase the cooking duration quoted by a few minutes.



## Tips

- Adding herbs and spices, such as dill, will help bring out the full flavor of the fish.
- Cook large fish in the swimming position. To help maintain the structure of the fish, place a small cup or similar upside down in the cooking container. Arrange the fish belly-side down over the cup.
- You can use any fish scraps, e.g., fish heads, bones, tails, etc., to make a **fish stock**. Place the fish scraps together with some mixed vegetables in a solid cooking container and add cold water. Cook at 212°F (100°C) for 60 to 90 minutes. The longer the cooking duration, the stronger the stock.
- Preparing fish **au bleu** is a method involving cooking the fish in water with vinegar, at different proportions depending on the recipe. It is important not to damage the skin of the fish. This method is suitable for cooking carp, trout, tench, eel, and salmon.

## Settings

Automatic Programs  Auto | Fish | ... | Steam Cooking

or

Operating Modes  | Steam Cooking

Temperature: see chart

Duration: see chart

## Steam cooking

| Fish                  | 🌡️ [°F (°C)] | 🕒 [min] |
|-----------------------|--------------|---------|
| Eel                   | 212 (100)    | 5–7     |
| Perch filet           | 212 (100)    | 8–10    |
| Mahi mahi filet       | 185 (85)     | 3       |
| Trout, 1/2 lb (250 g) | 195 (90)     | 10–13   |
| Halibut filet         | 185 (85)     | 4–6     |
| Cod filet             | 212 (100)    | 6       |
| Carp, 3 lbs (1.5 kg)  | 212 (100)    | 18–25   |
| Salmon filet          | 212 (100)    | 6–8     |
| Salmon steak          | 212 (100)    | 8–10    |
| Rainbow trout         | 195 (90)     | 14–17   |
| Basa filet            | 185 (85)     | 3       |
| Tilapia filet         | 212 (100)    | 6–8     |
| Haddock filet         | 212 (100)    | 4–6     |
| Plaice filet          | 185 (85)     | 4–5     |
| Monkfish filet        | 185 (85)     | 8–10    |
| Sole filet            | 185 (85)     | 3       |
| Turbot filet          | 185 (85)     | 5–8     |
| Tuna filet            | 185 (85)     | 5–10    |
| Pike perch filet      | 185 (85)     | 4       |

🌡️ temperature, 🕒 duration

## Meat

### Fresh food

Prepare the meat as usual.

### Frozen food

Meat should be thoroughly defrosted before cooking in the steam oven (see “Defrost” under “Special Modes”).

### Preparation

For meat which needs to be seared before being cooked, e.g. for a stew, sear the meat in a pan on the cooktop first.

### Cooking duration

The cooking time depends on the thickness and consistency of the food. The thicker the meat, the longer the cooking time. The thicker the piece of food is, the longer cooking will take. A piece of fish weighing 1 lb (500 g) that is 4" (10 cm) thick will take longer to cook than a piece weighing 1 lb (500 g) and only 2" (5 cm) thick.

## Tips

- To retain the **flavor**, use a perforated cooking container. Place a solid cooking container or the universal tray underneath in order to collect the concentrate. You can use the concentrate to enhance your sauces or freeze it for later use.
- Boiling meat from chicken and beef as well as meat bones can be used to make a **strong stock**. Place the meat together with the bones and some mixed vegetables in a cooking container and add cold water. The longer the cooking duration, the stronger the stock.

## Settings

Automatic Programs  Auto | Meat | ... | Steam Cooking

or

Operating Modes  | Steam Cooking

Temperature: 212°F (100°C)

Duration: see chart

# Steam cooking

| <b>Meat</b>                       | <b>🕒 [min]</b> |
|-----------------------------------|----------------|
| Beef flank, covered with water    | 110–120        |
| Pork knuckle                      | 135–140        |
| Chicken breast filet              | 8–10           |
| Ham hock                          | 105–115        |
| Prime rib, covered with water     | 110–120        |
| Veal strips                       | 3–4            |
| Smoked pork slices                | 6–8            |
| Lamb casserole                    | 12–16          |
| Poularde                          | 60–70          |
| Roulade of turkey                 | 12–15          |
| Turkey cutlet                     | 4–6            |
| Short rib, covered with water     | 130–140        |
| Beef casserole                    | 105–115        |
| Whole chicken, covered with water | 80–90          |
| Top round                         | 110–120        |

🕒 duration

## Rice

Rice swells when cooked and needs to be cooked in liquid. The proportion of rice to liquid will vary depending on the type of rice.

The rice absorbs all the liquid during the cooking process so that none of the nutrients are lost.

### Steam oven pan

Use a solid steam oven pan. Alternatively, smaller quantities of rice (up to a cup, approx. 50–150 g) can also be cooked in a suitable stainless steel bowl on the rack.

### Preparation

Wash the rice before cooking. If you wash the rice in the steam oven pan, drain the water off carefully afterward.

**Tip:** The required volume of liquid can be determined using scales or the cup method.

For the cup method, fill a cup with the desired quantity of rice and then place the rice in the steam oven pan. Then measure the required volume of liquid (see chart) with the cup and add it to the rice.

Make sure that the rice is evenly distributed in the steam oven pan.

## Settings



Automatic Programs  Auto | Rice | ... |



or

Operating Modes  | Steam Cooking

Temperature: 212°F (100°C)

Duration: see chart

|                         |  :  |  [min] |
|-------------------------|---|--|
| <b>Long-grain rice</b>  |   |  |
| Basmati rice            | 1 : 1.5   | 15   |
| Parboiled rice          | 1 : 1.5   | 23–25  |
| Brown rice              | 1 : 1.5   | 26–29  |
| Wild rice               | 1 : 1.5   | 26–29  |
| <b>Short-grain rice</b> |   |  |
| Rice pudding            | 1 : 2.5   | 30   |
| Risotto                 | 1 : 2.5   | 18–19  |

 :  Ratio of rice to liquid,  Cooking duration

# Steam cooking

---

## Grains

Grains swell when cooked and need to be cooked in liquid. The proportion of grains to liquid depends on the type of grain.

Grains can be cooked whole or cracked.

## Settings

Automatic Programs  Auto | Grains | ... |

or

Operating Modes  | Steam Cooking

Temperature: 212°F (100°C)

Duration: see chart

|                      | Ratio<br>Grain to liquid | 🕒 [min] |
|----------------------|--------------------------|---------|
| Amaranth             | 1 : 1.5                  | 15–17   |
| Bulgur               | 1 : 1.5                  | 9       |
| Green spelt, whole   | 1 : 1                    | 18–20   |
| Green spelt, cracked | 1 : 1                    | 7       |
| Oats, whole          | 1 : 1                    | 18      |
| Oats, cracked        | 1 : 1                    | 7       |
| Millet               | 1 : 1.5                  | 10      |
| Polenta              | 1 : 3                    | 10      |
| Quinoa               | 1 : 1.5                  | 15      |
| Rye, whole           | 1 : 1                    | 35      |
| Rye, cracked         | 1 : 1                    | 10      |
| Wheat, whole         | 1 : 1                    | 30      |
| Wheat, cracked       | 1 : 1                    | 8       |

🕒 Cooking duration

## Pasta/noodles

### Dry pasta

Dry pasta swell when cooked and needs to be cooked in liquid. The liquid must cover the pasta by at least 1".

Cook pasta according to package directions.

### Fresh food

Fresh pasta and noodles, such as those you can buy from the supermarket chilled counter, do not need to absorb water. Cook in a greased, perforated container.

Separate any pieces of pasta or noodles which have stuck together and spread them out in the cooking container.

### Settings

Automatic Programs  Auto | Pasta | ... |

or

Operating Modes  | Steam Cooking

Temperature: 212°F (100°C)

Duration: see chart

| Fresh food     | 🕒 [min] |
|----------------|---------|
| Gnocchi        | 2       |
| Round Knoepfli | 1       |
| Ravioli        | 2       |
| Spaetzle       | 1       |
| Tortellini     | 2       |

🕒 Cooking duration

# Steam cooking

---

## Dumplings

Ready-made dumplings in wrappers need to be covered completely with water. Otherwise they will not absorb enough water and will fall apart, even if steeped in water prior to cooking.

Cook fresh dumplings in a greased, perforated container.

### Settings

Automatic Programs  Auto | Pasta | ... |

or

Operating Modes  | Steam Cooking

Temperature: 212°F (100°C)

Duration: see chart

|                                  | ⌚ [min] |
|----------------------------------|---------|
| Steamed dumplings                | 30      |
| Yeast dumplings                  | 20      |
| Boil-in-the-bag potato dumplings | 20      |
| Boil-in-the-bag bread dumplings  | 18–20   |

⌚ Cooking duration



## Legumes

Soak legumes for at least 10 hours in cold water before cooking. Soaking makes the legumes more digestible and shortens the cooking duration required. Soaked legumes must be covered with liquid during cooking.

**Lentils** do not need to be soaked before cooking.

With unsoaked legumes, a certain ratio of pulses to liquid is required depending on type.

## Settings

Automatic Programs  Auto | Legumes | ... |

or

Operating Modes  | Steam Cooking

Temperature: 212°F (100°C)

Duration: see chart

| Soaked              |         |
|---------------------|---------|
|                     | 🕒 [min] |
| <b>Beans</b>        |         |
| Kidney beans        | 55–65   |
| Azuki beans         | 20–25   |
| Black beans         | 55–60   |
| Pinto beans         | 55–65   |
| White beans         | 34–36   |
| <b>Peas</b>         |         |
| Yellow peas         | 40–50   |
| Green peas, shelled | 27      |

🕒 Cooking duration

# Steam cooking

| Unsoaked            |                            |         |
|---------------------|----------------------------|---------|
|                     | Ratio<br>Legumes to liquid | 🕒 [min] |
| <b>Beans</b>        |                            |         |
| Kidney beans        | 1 : 3                      | 130–140 |
| Azuki beans         | 1 : 3                      | 95–105  |
| Black beans         | 1 : 3                      | 100–120 |
| Pinto beans         | 1 : 3                      | 115–135 |
| White beans         | 1 : 3                      | 80–90   |
| <b>Lentils</b>      |                            |         |
| Brown lentils       | 1 : 2                      | 13–14   |
| Red lentils         | 1 : 2                      | 7       |
| <b>Peas</b>         |                            |         |
| Yellow peas         | 1 : 3                      | 110–130 |
| Green peas, shelled | 1 : 3                      | 60–70   |

🕒 Cooking duration

## Eggs

Use a perforated container to prepare boiled eggs in the steam oven.

The eggs do not need to be pierced before cooking as they are gradually warmed during the preheating phase and so do not burst when they are cooked with steam.

When using a solid container for making egg dishes such as scrambled eggs, remember to grease it first.

### Settings

Automatic Programs  Auto | Eggs | ... |

or

Operating Modes  | Steam Cooking

Temperature: 212°F (100°C)

Duration: see chart

|  | 🕒 [min]            |
|--|--------------------|
| <b>Small</b><br>soft<br>medium<br>hard       | <br>3<br>5<br>9    |
| <b>Medium</b><br>soft<br>medium<br>hard      | <br>4<br>6<br>10   |
| <b>Large</b><br>soft<br>medium<br>hard       | <br>5<br>6–7<br>12 |
| <b>Extra large</b><br>soft<br>medium<br>hard | <br>6<br>8<br>13   |

🕒 duration

# Steam cooking

## Fruit

Cook fruit in a solid container so that none of the juice is lost. If you wish to cook fruit in a perforated container, place a solid container directly underneath it to collect the juice.

**Tip:** You can use the collected juice to prepare a glaze.

## Settings

Automatic Programs  Auto | Fruit | ... |

or

Operating Modes  | Steam Cooking

Temperature: 212°F (100°C)

Duration: see chart

|                        | ⌚ [min] |
|------------------------|---------|
| Apple chunks           | 1–3     |
| Pear chunks            | 1–3     |
| Cherries               | 2–4     |
| Mirabelle plums        | 1–2     |
| Nectarine/peach chunks | 1–2     |
| Plums                  | 1–3     |
| Quince, diced          | 6–8     |
| Rhubarb pieces         | 1–2     |
| Gooseberries           | 2–3     |

⌚ duration

## Sausage

### Settings

Automatic Programs  Auto | Sausage | ... |

or

Operating Modes  | Steam Cooking

Temperature: 195°F (90°C)

Duration: see chart

| Sausage        | ⌚ [min] |
|----------------|---------|
| Boiled sausage | 6–8     |
| Pork sausage   | 6–8     |
| Veal sausage   | 6–8     |

⌚ Cooking duration

## Shellfish

### Preparation

Defrost frozen shellfish before cooking with steam.

Peel, clean and wash the shellfish.

### Cooking pan

If using a perforated pan, grease it first.

### Cooking duration

The longer shellfish are cooked, the tougher they become. Use the cooking durations given in the chart.

When cooking shellfish in sauce or stock, we recommend that you increase the cooking duration quoted by a few minutes.

### Settings

Automatic Programs  Auto | Shellfish | ... |

or

Operating Modes  | Steam Cooking

Temperature: see chart

Duration: see chart

|              | 🌡️ [°F (°C)] | 🕒 [min] |
|--------------|--------------|---------|
| Prawn        | 195 (90)     | 3       |
| Shrimp       | 195 (90)     | 3       |
| Jumbo shrimp | 195 (90)     | 4       |
| Small shrimp | 195 (90)     | 3       |
| Lobster      | 205 (95)     | 10–15   |
| Large shrimp | 195 (90)     | 3       |

🌡️ temperature, 🕒 duration

# Steam cooking

## Mussels

### Fresh food



Danger of food poisoning from spoiled mussels.

Spoiled mussels can cause food poisoning.

Only cook mussels which are closed.

Do not eat mussels which have not opened after being cooked.

Steep fresh mussels in water for a few hours before cooking to rinse out any sand. Then scrub the mussels thoroughly to clean them.

### Frozen food

Defrost frozen mussels before cooking.

### Cooking duration

The longer mussels are cooked, the tougher they become. Use the cooking durations given in the chart.

### Settings

Automatic Programs  Auto | Mussels | ... |

or

Operating Modes  | Steam Cooking

Temperature: see chart

Duration: see chart

|                 | 🌡️ [°F (°C)] | 🕒 [min] |
|-----------------|--------------|---------|
| Barnacles       | 212 (100)    | 2       |
| Cockles         | 212 (100)    | 2       |
| Bearded mussels | 195 (90)     | 12      |
| Scallops        | 195 (90)     | 5       |
| Razor clams     | 212 (100)    | 2–4     |
| Clams           | 195 (90)     | 4       |

🌡️ temperature, 🕒 duration

## Menu Cooking - Manual

Before cooking meals with the manual menu cooking function, turn off steam reduction (see “Steam reduction” under “Settings”).

When cooking a menu, you can combine different foods with different cooking durations, e.g., fish filet with rice and broccoli. The food is placed in the steam oven compartment at different times so that each item is ready at the same time.

### Shelf level

Place foods that produce a lot of liquid (e.g., fish) or have a distinctive color (e.g., beetroot) directly above the universal tray. This avoids any transfer of flavor or color to other food and prevents liquid dripping onto food below it.

### Temperature

Whole meals should be cooked at a temperature of 212°F (100°C) as this is the temperature required to cook the majority of foods. Do not cook a whole meal at the lowest temperature when different temperatures are required for different types of food, e.g. 185°F (85°C) for seabream and 212°F (100°C) for potatoes.

If the recommended cooking temperature for the food is 185°F (85°C), for example, try cooking it at 212°F (100°C) and testing the result. Some delicate types of fish with a soft structure, e.g. sole and plaice will become very firm when cooked at 212°F (100°C).

### Cooking duration

If you are increasing the recommended temperature, shorten the cooking duration by approx. 1/3.

## Example

### Food cooking durations

(see cooking charts in “Steam cooking”)

|                |            |
|----------------|------------|
| Parboiled rice | 24 minutes |
| Tilapia filet  | 6 minutes  |
| Broccoli       | 4 minutes  |

### Calculation of set cooking durations:

24 minutes minus 6 minutes = 18 minutes (1st cooking duration: rice)

6 minutes minus 4 minutes = 2 minutes (2nd cooking duration: tilapia filet)

Remaining time = 4 minutes (3rd cooking duration: broccoli)

|                  |                |                        |                   |
|------------------|----------------|------------------------|-------------------|
| Cooking duration | 24 min. – rice |                        |                   |
|                  |                | 6 min. – tilapia filet |                   |
|                  |                |                        | 4 min. – broccoli |
| Setting          | 18 min.        | 2 min.                 | 4 min.            |

### Cooking a whole menu

- Place the rice in the oven first.
- Set the first cooking duration: 18 minutes.
- After the 18 minutes, place the fish in the oven.
- Set the second cooking duration: 2 minutes.
- After the 2 minutes, place the broccoli in the oven.
- Set the third cooking duration: 4 minutes.

# Sous-vide (vacuum) cooking

---

Always observe USDA/CFIA food safety guidelines.

This gentle cooking method allows food to be cooked slowly at a low, constant temperature in vacuum packaging.

With vacuum cooking, no moisture evaporates during the cooking process and all nutrients and flavors are retained.

This results in intense flavor and evenly cooked food.

Only use food that is fresh and in good condition.

Ensure hygienic conditions and that food has not been out of the refrigerator too long.

Use only heat-stable, boiling-resistant vacuum sealing bags.

Do not cook food in its original packaging, e.g., vacuum-sealed frozen food, as the vacuum sealing bag used may not be suitable.

Do not use the vacuum sealing bag more than once.

Vacuum-seal the food in a chamber system vacuum sealer only.

- The food becomes firmer if acidic ingredients such as lemon or vinegar are added.
- Do not use alcohol or garlic as this can cause an unpleasant taste.
- Only use vacuum sealing bags that match the size of the food. If the vacuum sealing bag is too big, too much air can remain inside.
- If you want to cook several items of food in one vacuum sealing bag, put them side by side in the bag.
- If you want to cook food in several vacuum sealing bags at once, put the bags side by side on the rack.
- The cooking durations depend on the thickness of the food.
- Keep the door closed during the cooking process. Opening the door extends the cooking process and can change the cooking result.
- Temperatures and cooking durations from sous-vide recipes cannot always be emulated exactly. Alter the settings to achieve the degree of cooking you want.

## Important usage notes

For the best cooking results:

- Use herbs and spices more sparingly than with conventional cooking methods because the impact on the taste of the food will be stronger.  
You can also cook the food unseasoned and add seasoning after cooking.
- The cooking duration is reduced when salt, sugar, and liquids are added.



# Sous-vide (vacuum) cooking

## Tips

- In order to save time, you can vacuum-seal food items 1–2 days before the cooking process. Store the vacuum-sealed food in the refrigerator at no more than 40°F (5°C). In order to preserve quality and flavor, the food should be cooked no later than 2 days afterward.
- Freeze liquids such as marinades before vacuum-sealing to prevent them from escaping from the bag.
- Fold the edges of the vacuum sealing bag outward for filling. This will give you clean, perfect seams.
- If you do not want to eat the food straight after cooking, put it in iced water immediately and allow it to cool down completely. After this, store the food at temperatures no greater than 40°F (5°C).

This way, you can retain the food's quality and flavor while keeping it fresh for longer.

**Exception:** Poultry must be eaten straight after the cooking process.

- After cooking, cut the vacuum sealing bag on all sides for easier access to the food.
- Briefly fry meat and firm types of fish (such as salmon) before serving. This will help to develop a roasted flavor.
- Use the stock or marinade of vegetables, fish, or meat to make a sauce.
- Serve the food on preheated plates.

## Using the Sous-vide operating mode

- Rinse the food with cold water and dry it.
- Place the food in a vacuum bag and add spices or liquid if desired.
- Vacuum-seal the food in a chamber system vacuum sealer.
- For the best cooking results, place the wire rack on shelf level 2.
- Place the vacuum-sealed food on the wire rack (next to each other if there are several bags).
- Select Operating Modes .
- Select Sous-vide .
- Adjust the recommended temperature, if necessary.
- Confirm with *OK*.
- Set further settings as necessary (see “Operation”).

## Possible causes for poor results

### The vacuum bag has opened:

- The weld seam was not clean or stable enough and dissolved.
- The bag was damaged by a sharp bone.

### The food has an unpleasant or strange taste:

- Incorrect storage of the food; the food was kept out of the refrigerator for too long.
- The food was contaminated with bacteria before it was vacuum sealed.
- Too much spice was used.
- The bag or weld seam were damaged.
- The vacuum was insufficient.
- The food was not immediately eaten or cooled after cooking.

## Sous-vide (vacuum) cooking

The cooking durations given in the charts are guidelines only. We recommend selecting the shorter duration initially. You can cook for longer if necessary. The cooking duration only begins when the set temperature is reached.

| Food  | Added in advance |      | 🌡️ [°F (°C)]    | ⌚ [min] |
|---|------------------|------|-----------------|---------|
|   | Sugar            | Salt |                 |         |
| <b>Fish</b>   |                  |      |                 |         |
| Cod filet, 1" (2.5 cm) thick                          |                  | X    | 129 (54)        | 35      |
| Salmon filet, 3/4"-1 1/4" (2-3 cm) thick              |                  | X    | 126 (52)        | 30      |
| Monkfish filet  |                  | X    | 144 (62)        | 18      |
| Pike perch filet, 3/4" (2 cm) thick                   |                  | X    | 131 (55)        | 30      |
| <b>Vegetables</b>                                     |                  |      |                 |         |
| Cauliflower florets, medium to large                  |                  | X    | 185 (85)        | 40      |
| Hokkaido squash, sliced                               |                  | X    | 185 (85)        | 15      |
| Kohlrabi, sliced                                      |                  | X    | 185 (85)        | 30      |
| Asparagus, white, whole                               | X                | X    | 185 (85)        | 22-27   |
| Sweet potato, sliced                                  |                  | X    | 185 (85)        | 18      |
| <b>Fruit</b>  |                  |      |                 |         |
| Pineapple, sliced                                     | X                |      | 185 (85)        | 75      |
| Apples, sliced  | X                |      | 176 (80)        | 20      |
| Baby bananas, whole                                   |                  |      | 144 (62)        | 10      |
| Peaches, halved                                       | X                |      | 144 (62)        | 25-30   |
| Rhubarb pieces  |                  |      | 167 (75)        | 13      |
| Plums, halved   | X                |      | 158 (70)        | 10-12   |
| <b>Other</b>  |                  |      |                 |         |
| Beans, white, soaked at a 1:2 ratio (beans to liquid) |                  | X    | 195 (90)        | 240     |
| Shrimp, peeled and deveined                           |                  | X    | 133 (56)        | 19-21   |
| Egg, whole  |                  |      | 149-151 (65-66) | 60      |
| Scallops, removed from shell                          |                  |      | 126 (52)        | 25      |
| Shallot, whole  | X                | X    | 185 (85)        | 45-60   |

🌡️ temperature, ⌚ duration

## Sous-vide (vacuum) cooking

| Food                                 | Added in advance |      | 🌡️ [°F (°C)] |          | 🕒 [min] |
|--------------------------------------|------------------|------|--------------|----------|---------|
|                                      | Sugar            | Salt | Medium*      | Done*    |         |
| <b>Meat</b>                          |                  |      |              |          |         |
| Duck breast, whole                   |                  | X    | 151 (66)     | 162 (72) | 35      |
| Saddle of lamb (on the bone)         |                  |      | 136 (58)     | 144 (62) | 50      |
| Beef tenderloin, 1 1/2" (4 cm) thick |                  |      | 133 (56)     | 142 (61) | 120     |
| Beef sirloin, 1" (2.5 cm) thick      |                  |      | 133 (56)     | –        | 120     |
| Pork tenderloin, whole               |                  | X    | 145 (63)     | 153 (67) | 60      |

🌡️ temperature, 🕒 duration

\* Degree of doneness

The “Done” degree of doneness uses a higher core temperature than “Medium”. Results are not the same as “Well done” in traditional roasting methods.

# Sous-vide (vacuum) cooking

---

## Reheating

Only reheat brassicas, such as kohlrabi and cauliflower, together with a sauce. Without sauce, an unpleasant cabbage-like taste and gray-brown color may develop.

Food with a short cooking duration or which continues cooking during reheating, such as fish, is not suitable for reheating.

## Preparation

Place the cooked food into ice water for about an hour directly after cooking. The fast cooling prevents the food from continuing to cook. The optimum cooking condition is thus retained.

Then store the food in the refrigerator at a maximum of 40°F (5°C).

Please note that the quality of the food decreases the longer it is stored. We recommend that you do not store the food in the refrigerator for longer than 5 days before reheating.

## Settings

Operating Modes  | Sous-vide 

Temperature: see chart

Time: see chart

# Sous-vide (vacuum) cooking

## Reheating in the Sous-vide operating mode

The durations specified in the chart are guidelines only. You can make the duration longer if necessary. The cooking duration only begins when the set temperature is reached.

| Food  | 🌡️ [°F (°C)]        |                   | ⌚ <sup>2</sup> [min] |
|---|---------------------|-------------------|----------------------|
|   | Medium <sup>1</sup> | Done <sup>1</sup> |                      |
| <b>Meat</b>   |                     |                   |                      |
| Saddle of lamb (on the bone)                          | 136 (58)            | 144 (62)          | 30                   |
| Beef tenderloin, 1 1/2" (4 cm) thick                  | 133 (56)            | 142 (61)          | 30                   |
| Beef sirloin, 1" (2.5 cm) thick                       | 133 (56)            | –                 | 30                   |
| Pork tenderloin, whole                                | 145 (63)            | 153 (67)          | 30                   |
| <b>Vegetables</b>                                     |                     |                   |                      |
| Cauliflower florets, medium to large <sup>3</sup>     | 185 (85)            |                   | 15                   |
| Kohlrabi, sliced <sup>3</sup>                         | 185 (85)            |                   | 10                   |
| <b>Fruit</b>  |                     |                   |                      |
| Pineapple, sliced                                     | 185 (85)            |                   | 10                   |
| <b>Other</b>  |                     |                   |                      |
| Beans, white, soaked at a 1:2 ratio (beans to liquid) | 195 (90)            |                   | 10                   |
| Shallot, whole  | 185 (85)            |                   | 10                   |

🌡️ temperature, ⌚ duration

<sup>1</sup> Degree of cooking

The “Done” degree of cooking uses a higher core temperature than “Medium”. Results are not the same as “Well done” in traditional roasting methods.

<sup>2</sup> The durations apply to vacuum-sealed food with an initial temperature of approx. 40°F (5°C) (refrigerator temperature).

<sup>3</sup> Reheat only in sauce.

# Special modes

## Reheat

Always observe USDA/CFIA food safety guidelines.

To reheat food which was cooked using the sous-vide method, use the Sous-vide  operating mode (see “Reheating” under “Sous-vide (vacuum) cooking”).

The steam oven is very effective at reheating food gently, without drying it out or cooking it further. The food reheats evenly and does not need to be stirred during the reheating process.

You can reheat individual dishes or plated meals which have been prepared previously (e.g. meat, vegetables and potatoes).

### Suitable containers

Small quantities can be reheated on a plate, larger quantities should be placed in a cooking pan.

### Duration

10–12 minutes are usually sufficient for one plate of food. More than one plate will need a little longer.

If you are reheating several plated meals one after the other, the reheating time can be reduced by around 5 minutes for the second and subsequent plates as the oven compartment will still be hot.

## Moisture content

The more moist the food, the less moisture that needs to be added.

### Tips

- Do not reheat large items, such as a whole roast. Divide it into portions and reheat these as plated meals.
- Compact items, such as stuffed bell peppers or roulades, should be cut in half.
- Reheat sauces separately. Exceptions are dishes such as baked ziti, which is cooked in sauce.
- Please note that breaded items, such as fried chicken, will not retain their crispness when they are reheated.

Food does not need to be covered before it is reheated.

## Settings

Special Modes  | Reheat  
or

Operating Modes  | Combi Steam  |  
Combi Conv Bake 

Temperature: see chart

Moisture: see chart

Duration: see chart

## Special modes

The durations specified in the chart are guidelines only. We recommend selecting the shorter duration initially. You can make the duration longer if necessary.

| Food  | 🌡️ [°F (°C)] | ∆∆ [%] | ⌚* [min] |
|---|--------------|--------|----------|
| <b>Vegetables</b>   |              |        |          |
| Carrots<br>Cauliflower<br>Kohlrabi<br>Beans   | 250 (120)    | 70     | 8–10     |
| <b>Side dishes</b>  |              |        |          |
| Pasta<br>Rice<br>Potatoes, cut in half lengthways   | 250 (120)    | 70     | 8–10     |
| Dumplings<br>Mashed potato  | 285 (140)    | 70     | 18–20    |
| <b>Meat and poultry</b>   |              |        |          |
| Sliced meat, 1/2" (1.5 cm) thick<br>Roulades, sliced<br>Goulash<br>Lamb casserole<br>Meatballs<br>Chicken cutlets<br>Turkey cutlets, sliced   | 285 (140)    | 70     | 11–13    |
| <b>Fish</b>   |              |        |          |
| Fish filet<br>Fish roulade, halved  | 285 (140)    | 70     | 10–12    |
| <b>Plated meals</b>   |              |        |          |
| Spaghetti, in tomato sauce<br>Pork roast, potatoes, and vegetables<br>Stuffed bell peppers (cut in half), rice<br>Chicken fricassee, rice<br>Vegetable soup<br>Creamed soup<br>Clear broth<br>Casserole | 250 (120)    | 70     | 10–12    |

🌡️ temperature, ∆∆ moisture, ⌚ duration

\* These times apply to food heated on a plate.

# Special modes

## Defrost

Always observe USDA/CFIA food safety guidelines.

It is much quicker to defrost items in the steam oven than at room temperature.

 Risk of infection from bacteria. Bacteria such as salmonella can cause life-threatening food poisoning. It is particularly important to observe food hygiene rules when defrosting fish and meat, and in particular when defrosting poultry. Do not use the liquid produced during defrosting. Process the food as required as soon as it has been defrosted.

## Temperature

140°F (60°C) is the best temperature for defrosting.

**Exception:** 125°F (50°C) for minced meat and game

## Before and after defrosting

Remove any packaging before defrosting.

**Exceptions:** leave bread, biscuits, and cakes in their packaging as otherwise they will absorb moisture and become soft.

Allow food to stand at room temperature for a few minutes after defrosting. The standing time is necessary to allow the even distribution of heat from the outside to the inside.

## Cooking containers

Use a perforated container with the universal tray underneath when defrosting food which will drip, such as poultry. This way food will not be lying in defrosted liquid.

Foods which do not drip can be defrosted in a solid cooking container.

## Tips

- Fish does not need to be fully defrosted before cooking. Defrost so that the surface is sufficiently thawed to take herbs and seasoning. Depending on the thickness of the fish, 2–5 minutes is generally enough.
- When defrosting food which has frozen together, e.g., berries and meat portions, separate them half-way through the defrosting time.
- Do not refreeze food once it has thawed.
- Defrost frozen ready meals according to the instructions on the packaging.

## Settings

Special Modes  | Defrost or

Operating Modes  | Steam Cooking 

Temperature: see chart

Defrosting duration: see chart

Standing time: see chart



## Special modes

The durations specified in the chart are guidelines only. We recommend selecting the shorter defrosting duration initially. You can make the defrosting duration longer if necessary.

| Frozen food                                      | Quantity       | 🌡️ [°F (°C)] | 🕒 [min] | ⌚ [min] |
|--|----------------|--------------|---------|---------|
| <b>Dairy products</b>                            |                |              |         |         |
| Sliced cheese                                    | 1/4 lb (125 g) | 140 (60)     | 15      | 10      |
| Quark  | 1/2 lb (250 g) | 140 (60)     | 20–25   | 10–15   |
| Cream  | 1/2 lb (250 g) | 140 (60)     | 20–25   | 10–15   |
| Soft cheese                                      | 1/4 lb (100 g) | 140 (60)     | 15      | 10–15   |
| <b>Fruit</b>                                     |                |              |         |         |
| Apple sauce                                      | 1/2 lb (250 g) | 140 (60)     | 20–25   | 10–15   |
| Apple chunks                                     | 1/2 lb (250 g) | 140 (60)     | 20–25   | 10–15   |
| Apricots   | 1 lb (500 g)   | 140 (60)     | 25–28   | 15–20   |
| Strawberries                                     | 2/3 lb (300 g) | 140 (60)     | 8–10    | 10–12   |
| Raspberries/currants                             | 2/3 lb (300 g) | 140 (60)     | 8       | 10–12   |
| Cherries   | 1/3 lb (150 g) | 140 (60)     | 15      | 10–15   |
| Peaches  | 1 lb (500 g)   | 140 (60)     | 25–28   | 15–20   |
| Plums  | 1/2 lb (250 g) | 140 (60)     | 20–25   | 10–15   |
| Gooseberries                                     | 1/2 lb (250 g) | 140 (60)     | 20–22   | 10–15   |
| <b>Vegetables</b>                                |                |              |         |         |
| Frozen in a block                                | 2/3 lb (300 g) | 140 (60)     | 20–25   | 10–15   |
| <b>Fish</b>                                      |                |              |         |         |
| Fish filets                                      | 3/4 lb (400 g) | 140 (60)     | 15      | 10–15   |
| Trout  | 1 lb (500 g)   | 140 (60)     | 15–18   | 10–15   |
| Lobster  | 2/3 lb (300 g) | 140 (60)     | 25–30   | 10–15   |
| Small shrimp                                     | 2/3 lb (300 g) | 140 (60)     | 4–6     | 5       |
| <b>Ready meals</b>                               |                |              |         |         |
| Meat, vegetables, side dishes/<br>casserole/soup | 1 lb (480 g)   | 140 (60)     | 20–25   | 10–15   |

## Special modes

| Frozen food                  | Quantity                        | 🌡️ [°F (°C)] | ⌚ [min] | ⌛ [min] |
|------------------------------|---------------------------------|--------------|---------|---------|
| <b>Meat</b>                  |                                 |              |         |         |
| Roast meat, sliced           | 1/4 -1/2 lb<br>(125–150 g) each | 140 (60)     | 8–10    | 15–20   |
| Ground meat                  | 1/2 lb (250 g)                  | 125 (50)     | 15–20   | 10–15   |
|                              | 1 lb (500 g)                    | 125 (50)     | 20–30   | 10–15   |
| Goulash                      | 1 lb (500 g)                    | 140 (60)     | 30–40   | 10–15   |
|                              | 2 lb (1,000 g)                  | 140 (60)     | 50–60   | 10–15   |
| Liver                        | 1/2 lb (250 g)                  | 140 (60)     | 20–25   | 10–15   |
| Saddle of hare               | 1 lb (500 g)                    | 125 (50)     | 30–40   | 10–15   |
| Saddle of venison            | 2 lb (1,000 g)                  | 125 (50)     | 40–50   | 10–15   |
| Cutlets/chops/sausages       | 1 3/4 lb (800 g)                | 140 (60)     | 25–35   | 15–20   |
| <b>Poultry</b>               |                                 |              |         |         |
| Chicken                      | 2 lb (1,000 g)                  | 140 (60)     | 40      | 15–20   |
| Chicken thighs               | 1/3 lb (150 g)                  | 140 (60)     | 20–25   | 10–15   |
| Chicken cutlet               | 1 lb (500 g)                    | 140 (60)     | 25–30   | 10–15   |
| Turkey drumsticks            | 1 lb (500 g)                    | 140 (60)     | 40–45   | 10–15   |
| <b>Baked goods</b>           |                                 |              |         |         |
| Puff pastries/yeasted goods  | –                               | 140 (60)     | 10–12   | 10–15   |
| Cakes, cookies, and pastries | 3/4 lb (400 g)                  | 140 (60)     | 15      | 10–15   |
| <b>Bread/rolls</b>           |                                 |              |         |         |
| Rolls                        | –                               | 140 (60)     | 30      | 2       |
| Rye bread, sliced            | 1/2 lb (250 g)                  | 140 (60)     | 40      | 15      |
| Whole grain bread, sliced    | 1/2 lb (250 g)                  | 140 (60)     | 65      | 15      |
| White bread, sliced          | 1/3 lb (150 g)                  | 140 (60)     | 30      | 20      |

🌡️ temperature, ⌚ defrosting duration, ⌛ standing time

## Miele Mix & Match

The Miele Mix & Match Special Mode is available to help with simple and uncomplicated preparation of plated meals. With this application, you can re-heat food that has already been cooked (convenience food) or assemble a portioned-out meal using fresh food and cook it on a plate.

During cooking, you have the choice between a crispy, browned result or gently cooked food with a succulent surface without additional browning.

Only use food that is completely hygienic. If you have any concerns, dispose of the food.

**Tip:** It is recommended to use the Miele app with the Miele Mix & Match Special Mode. With the Miele app, you can interactively assemble your meal using a wide range of ingredients and then transfer the program settings to your combi-steam oven.

To use this function, you need to connect your combi-steam oven to the Wi-Fi network. Find out how to do this in “Before first use – Miele@home”.

If you choose not to use the Miele app, follow the instructions below and assemble your meal using the cooking charts.

## Containers

Use:

- a flat plate or a small ovenproof dish
- a deep bowl or a cup for food that requires liquid to be added

Baked goods, pizza, tarte flambée, etc., can be placed directly on the wire rack (with parchment paper if necessary).

The plastic containers for ready meals are not sufficiently heat-resistant.

Transfer ready meals into suitable cooking containers.

## Tips for reheating plated meals

- For fried or gratin dishes, use Crisp Reheating and for baked or boiled dishes, use Gentle Reheating.
- Using Crisp Reheating ensures that only food that was crispy before reheating stays crispy.
- The food should not exceed a height of 3/4"-1" (2–2.5 cm). Transfer taller food into flat containers (e.g., casserole) or slice it into smaller pieces (e.g., roulades, bakes).
- Only reheat pasta mixed into a sauce.
- Droplets of water may have accumulated underneath the dishware. Dry the droplets of water before serving.

## Special modes

---

### Tips for cooking plated meals

- You can easily make a sauce from the meat and fish stock: add 1 tsp of corn starch to the raw meat or fish before cooking. Stir the sauce with a fork until smooth before serving. You can also use 1 tsp of mashed potato powder (instant) or a pinch of guar gum instead of corn starch.
- If cooking durations for different foods are not the same, you can compensate for this by changing the size of the food: if the cooking duration is shorter, make the pieces larger (e.g., large cauliflower florets). If the cooking duration is longer, make the pieces smaller (e.g., diced potatoes).
- You can also compensate for differing cooking durations with layering: place food with a short cooking duration under a food with a long cooking duration or put them together as a small bake.
- To prevent the food from drying out, prepare your dish with a sauce or marinade. You can also use cheese or bacon.

### Assembling a plated meal using various components

For a good cooking result, you must put together the individual components of the dish – such as meat, side dishes, and vegetables – so that a common setting can be selected for browning. This setting must be suitable for all elements of the meal, or at least conditionally suitable.

We recommend using the following procedure:

- Select a main ingredient based on the cooking charts, e.g., steak.
- Select other ingredients which have the corresponding settings for browning, e.g., green beans and rice.

## Notes on the cooking charts

As well as information on portion sizes or the way the food needs to be processed prior to cooking, the cooking charts also provide tips on preparation.

The degree of browning is represented in the display by a bar with seven segments. Basically, the more segments that are filled, the longer the cooking duration.

You can use the icons to determine which setting is appropriate to brown the food:

| Symbol | Meaning                |
|--------|------------------------|
| —      | Unsuitable             |
| □      | Conditionally suitable |
| ■      | Suitable               |

## Using the Miele Mix & Match Special Mode

Food does not need to be covered while it is being cooked.

- Prepare the food as required.
- Select Special Modes  | Miele Mix & Match.
- If you are preparing food that is already **cooked**, select Gentle Reheating or Crisp Reheating.
- If you are preparing food that is **fresh** or just partially cooked, select Gentle Cooking or Crisp Cooking.
- Change the setting for browning if necessary.
- Confirm with *OK*.
- Place the food on the wire rack on shelf level 3.
- Confirm with *OK*.

You can start the cooking program immediately or delay the start.

- If by the end of a cooking program, the plated meal is not cooked enough for your taste, select *Continue cooking*.

# Special modes

## Reheating food with the “Crisp Reheating” Special Mode

| Food  | Browning segment bar setting |
|---|------------------------------|
| Apple strudel, 1 3/4" (4 cm) thick, baked                 | ___ _ _ _ □ ■ □ _ _          |
| Baked camembert, 0.8 oz (25 g), baked                     | ___ _ _ _ ■ □ _ _ _          |
| Baked camembert, 2.6 oz (75 g), baked                     | ___ _ _ _ □ ■ □ _ _          |
| Baguette  | _ _ □ ■ □ _ _ _ _            |
| Puff pastry canapés, baked                                | _ _ □ ■ □ □ _ _ _            |
| Puff pastry pockets (spinach), baked                      | _ _ □ ■ □ _ _ _ _            |
| Börek, 1 1/4" (3 cm) thick, prebaked or baked             | ___ _ _ _ □ □ ■ □            |
| Fried potatoes, 1/2" (1 cm) thick, precooked or cooked    | ___ _ □ ■ □ _ _ _            |
| Tofu patty <sup>1</sup> , cooked                          | _ _ □ □ ■ □ _ _ _            |
| Bread roll (wheat), prebaked                              | ___ _ □ ■ □ _ _ _            |
| Bread roll (rye), prebaked                                | ___ _ _ _ □ ■ _ _ _          |
| Bread roll, baked, stored                                 | ___ _ _ _ □ ■ _ _ _          |
| Cheeseburger, cooked                                      | ___ _ □ ■ _ _ _ _            |
| Chili con carne <sup>1</sup> , 3/4" (2 cm) thick, cooked  | ___ _ _ _ □ ■ □ _ _          |
| Ciabatta rolls, prebaked                                  | ___ _ _ _ ■ □ _ _ _          |
| Ciabatta rolls, baked, stored                             | ___ _ _ _ ■ □ _ _ _          |
| Crêpe <sup>1</sup> , cooked                               | ___ _ ■ □ _ _ _ _            |
| Tarte flambée, baked                                      | _ _ □ ■ □ _ _ _ _            |
| Tarte flambée   | _ _ □ □ ■ _ _ _ _            |
| Meat strips <sup>1</sup> , precooked or cooked            | □ □ ■ □ □ _ _ _              |
| Focaccia, 1 1/4"–1 1/2" (3–4 cm) thick, prebaked or baked | □ □ □ ■ □ _ _ _              |
| Meat patty <sup>1</sup> (pork), 0.8 oz (25 g), cooked     | □ □ ■ □ □ □ _ _              |
| Meat patty <sup>1</sup> (pork), 2.1 oz (60 g), cooked     | ___ _ _ _ □ ■ □ _ _          |
| Meat patty <sup>1</sup> (pork), 3.5 oz (100 g), cooked    | ___ _ _ _ □ □ ■ □            |
| Spring roll, 0.8 oz (25 g), cooked                        | ___ _ _ _ □ ■ □ _ _          |
| Spring roll, 3.5 oz (100 g), cooked                       | ___ _ _ _ □ ■ □              |
| Hot dog <sup>1</sup> , prebaked                           | □ □ ■ □ _ _ _ _              |
| Kaiserschmarrn pancake <sup>1</sup> , frozen, thawed      | _ _ □ □ ■ □ □ _ _            |
| Potatoes, Yukon Gold, sliced, cooked                      | ___ _ □ ■ □ _ _ _            |
| Potato pockets, baked                                     | ___ _ □ □ ■ □ _ _            |
| Lasagna <sup>1</sup> , 1 1/4" (3 cm) thick, cooked        | ___ _ _ _ ■ □ _ _ _          |

## Special modes

| Food  | Browning segment bar setting |
|---|------------------------------|
| Naan <sup>1</sup> , cooked  |                              |
| Cheesy fresh pasta bake, 1 3/4" (4.5 cm) thick, precooked                 |                              |
| Pasta bake <sup>1</sup> , 3/4" (2 cm) thick, cooked                       |                              |
| Pasta bake <sup>1</sup> , 1 3/4" (4.5 cm) thick, cooked                   |                              |
| Pasta bake <sup>1</sup> , 2 1/2" (6 cm) thick, cooked                     |                              |
| Pancakes <sup>1</sup> , cooked  |                              |
| Pancakes <sup>1</sup>   |                              |
| Pita <sup>1</sup> , prebaked  |                              |
| Pizza, baked  |                              |
| Poffertjes pancake  |                              |
| Quiche, 0.8 oz (25 g), baked  |                              |
| Quiche, 3/4" (2 cm) thick, baked  |                              |
| Quiche, 1 1/2" (3.5 cm) thick, baked                                      |                              |
| Potato pancakes <sup>1</sup> , cooked                                     |                              |
| Hash browns, baked  |                              |
| Schnitzel, cooked   |                              |
| Taco shell, baked   |                              |
| Toast Hawaii, cooked  |                              |
| Grilled cheese, cooked  |                              |
| Tortilla chips, baked, with cheese  |                              |
| Tortilla wraps <sup>1</sup> , prebaked or cooked, rolled in aluminum foil |                              |

<sup>1</sup> is not crispy, only needs to be sufficiently heated (> 150°F (65°C)).

# Special modes

## Cooking food with the “Crisp Cooking” Special Mode

| Food  | Cooking tips                                      | Browning segment bar setting  |
|---|---|---|
| <b>Meat<sup>1</sup></b>                           |   |   |
| Bratwurst, 0.8 oz (25 g), boiled                  | –   | ___ _ _ _ <input type="checkbox"/> <input type="checkbox"/> <input checked="" type="checkbox"/> <input type="checkbox"/>                      |
| Bratwurst, 3.5 oz (100 g), boiled                 | Scored  | ___ _ _ _ _ _ <input type="checkbox"/> <input checked="" type="checkbox"/> <input type="checkbox"/>   |
| Bratwurst, coarse, raw                            | Scored, drizzled with a little oil                | ___ _ _ _ _ _ <input type="checkbox"/> <input checked="" type="checkbox"/>  |
| Beef tenderloin skewer, 1.7 oz (50 g) chunks, raw | Marinated, with bacon                             | <input type="checkbox"/> <input checked="" type="checkbox"/> _ _ _ _ _ _  |
| Pork skewer, 1.7 oz (50 g) chunks, raw            | Marinated, with bell pepper and onion             | <input type="checkbox"/> <input type="checkbox"/> <input type="checkbox"/> <input checked="" type="checkbox"/> <input type="checkbox"/> _ _ _ |
| Meat patty, 2.1 oz (60 g), 1" (2.5 cm) thick      | Ground meat, seasoned                             | ___ _ _ _ _ _ <input type="checkbox"/> <input checked="" type="checkbox"/> <input type="checkbox"/>   |
| Chicken breast, 1 1/4" (3 cm) thick, raw          | Wrapped in bacon, with salt and pepper            | <input type="checkbox"/> <input type="checkbox"/> <input type="checkbox"/> <input checked="" type="checkbox"/> <input type="checkbox"/> _ _ _ |
| Chicken breast, 1 1/4" (3 cm) thick, raw          | On its own, seasoned                              | _ _ <input type="checkbox"/> <input type="checkbox"/> <input checked="" type="checkbox"/> _ _ _ _   |
| Chicken breast, stuffed, raw                      | Seasoned, filling: spinach, crème fraîche         | _ _ <input type="checkbox"/> <input type="checkbox"/> <input checked="" type="checkbox"/> <input type="checkbox"/> _ _ _                      |
| Chicken skewer, 1.7 oz (50 g) chunks, raw         | Marinated, with bell pepper and onion             | <input type="checkbox"/> <input type="checkbox"/> <input checked="" type="checkbox"/> <input type="checkbox"/> _ _ _ _                        |
| Chicken drumstick, raw                            | Marinated   | ___ _ _ _ <input type="checkbox"/> <input type="checkbox"/> <input type="checkbox"/> <input checked="" type="checkbox"/>                      |
| Veal tenderloin, 1" (2.5 cm) thick, raw           | Marinated, with sauce                             | <input checked="" type="checkbox"/> _ _ _ _ _ _   |
| Smoked pork cutlet, 1 1/2" (3.5 cm) thick, raw    | –   | ___ _ <input type="checkbox"/> <input checked="" type="checkbox"/> <input type="checkbox"/> <input type="checkbox"/> <input type="checkbox"/> |
| Smoked pork chop, 3/4" (2 cm) thick, raw          | –   | _ _ <input type="checkbox"/> <input type="checkbox"/> <input checked="" type="checkbox"/> <input type="checkbox"/> _ _ _                      |
| Lamb chop, 3/4" (2 cm) thick, raw                 | Marinated   | <input type="checkbox"/> <input checked="" type="checkbox"/> <input type="checkbox"/> <input type="checkbox"/> _ _ _ _                        |
| Steak, 1 1/4" (3 cm) thick, raw                   | Marinated   | _ _ <input type="checkbox"/> <input checked="" type="checkbox"/> <input type="checkbox"/> _ _ _ _   |
| Pork tenderloin, 1 1/2" (4 cm) thick, raw         | Wrapped in bacon, with salt and pepper            | <input type="checkbox"/> <input type="checkbox"/> <input checked="" type="checkbox"/> <input type="checkbox"/> _ _ _ _                        |
| Pork chop, 1/2" (1.5 cm) thick, raw               | Coated in breadcrumbs, drizzled with a little oil | ___ _ _ _ _ _ <input checked="" type="checkbox"/>   |



## Special modes

| Food   | Cooking tips                         | Browning segment bar setting |
|--|--------------------------------------|------------------------------|
| <b>Fish<sup>1</sup></b>                                |                                      |                              |
| Halibut cutlet, 1 1/4" (3 cm) thick, raw               | Marinated                            | ☐ ■ _____                    |
| Cod filet, 1 1/4" (3 cm) thick, raw                    | With butter and breadcrumb crust     | _____ ☐ ■ ☐ _                |
| Cod filet, 1 1/2" (3.5 cm) thick, raw                  | Marinated                            | ■ ☐ ☐ _____                  |
| Cod filet, stuffed, raw                                | Seasoned, filling: spinach, tomato   | ■ ☐ _____                    |
| Salmon filet, 1 1/4" (3 cm) thick, raw                 | Seasoned                             | ☐ ☐ ■ ☐ ☐ _                  |
| Salmon cutlet, 1 1/4" (3 cm) thick, raw                | Marinated                            | ☐ ☐ ■ ☐ ☐ _                  |
| Salmon skewer, 1.7 oz (50 g) chunks, raw               | Seasoned                             | ☐ ☐ ■ ☐ ☐ _                  |
| Pollock filet, 1 1/4" (3 cm) thick, raw                | Seasoned, topping: spinach, feta     | ■ ☐ _____                    |
| Tuna filet, 1 1/4" (3 cm) thick, raw                   | Marinated                            | _____ ☐ _____                |
| Tuna filet, 1 1/4" (3 cm) thick, raw                   | Seasoned, topping: tomato, cheese    | _____ ☐ ■ _____              |
| Catfish skewer, 1.7 oz (50 g) chunks, raw              | Marinated, with bacon                | _ ☐ ☐ ☐ ■ _                  |
| <b>Vegetables</b>                                      |                                      |                              |
| Eggplant, 3/4" (2 cm) thick, raw                       | Marinated                            | _____ ■ ☐ _____              |
| Cauliflower, large florets, raw                        | Salt, pepper, buttered bread-crumbs  | ☐ ☐ ■ ☐ _____                |
| Broccoli, large florets, raw                           | Cheese sauce                         | ☐ ■ ☐ _____                  |
| Bacon-wrapped string beans, raw                        | Wrapped in bacon slices, seasoned    | _____ ■ ☐ _____              |
| Cherry tomatoes, whole, raw                            | Marinated                            | ■ ☐ ☐ ☐ _____                |
| Potatoes <sup>2</sup> , 1/8" (3 mm) slices/chunks, raw | Butter, salt, or cheese              | _____ ☐ ☐ ☐ ■                |
| Kohlrabi, 3/4" (2 cm) slices, raw                      | Salt, pepper, nutmeg                 | ☐ ☐ ■ ☐ _____                |
| Pumpkin, 3/4" (2 cm) chunks, raw                       | Salt, pepper, pumpkin seed oil       | ■ ☐ ☐ _____                  |
| Corn on the cob, raw                                   | Salt, butter                         | _ ☐ ☐ ■ ☐ _                  |
| Carrots, quartered/3/4" (2 cm) slices, raw             | Salt, pepper, butter                 | ☐ ☐ ■ ☐ _____                |
| Bell pepper, large chunks, raw                         | Marinated                            | ☐ ☐ ☐ ■ ☐ _                  |
| Ratatouille, 3/4" (2 cm) chunks, raw                   | Tomato purée, seasoning, corn starch | ■ ☐ _____                    |
| Zucchini, 3/4" (2 cm) slices, raw                      | Marinated                            | _ ☐ ☐ ■ ☐ ☐ _                |

## Special modes

| Food   | Cooking tips                  | Browning segment bar setting |
|--|-------------------------------|------------------------------|
| <b>Pasta and rice</b>  |                               |                              |
| Fresh pasta bake with meat, 1 3/4" (4.5 cm) thick, uncooked    | Raw vegetables, sauce, cheese |                              |
| Fresh pasta, tortellini, precooked                             | –                             |                              |
| Lasagna, 1 1/4" (3 cm) thick, precooked                        | –                             |                              |
| Pasta bake, 3/4" (2 cm) thick, precooked                       | –                             |                              |
| Rice, brown rice, cooking duration 8 minutes, uncooked         | Salt, 1:2 (rice:liquid)       |                              |
| Rice, parboiled rice, cooking duration 8 minutes, uncooked     | Salt, 1:1.5 (rice:liquid)     |                              |
| Rice, parboiled rice, cooking duration 10–12 minutes, uncooked | Salt, 1:1.5 (rice:liquid)     |                              |
| Rice, precooked  | –                             |                              |
| <b>Pizza etc.</b>  |                               |                              |
| Baked camembert, 0.8 oz (25 g), frozen                         | Thawed                        |                              |
| Baguette, frozen   | Thawed                        |                              |
| Baguette, prebaked   | –                             |                              |
| Fried potatoes, precooked                                      | –                             |                              |
| Bread roll, baked, stored                                      | –                             |                              |
| Cheeseburger, prebaked   | –                             |                              |
| Dates in bacon, raw  | –                             |                              |
| Tarte flambée, uncooked  | Chiller product               |                              |
| Tarte flambée, uncooked  | Add topping to chilled pastry |                              |
| Spring roll, 0.8 oz or 3.5 oz (25 g or 100 g), frozen          | Thawed                        |                              |
| Grilled cheese, 3.2 oz (90 g), precooked                       | –                             |                              |
| Potato pockets, baked  | –                             |                              |
| Potato pockets, frozen   | Thawed                        |                              |
| Gnocchi, precooked   | Butter, salt, cheese          |                              |
| Potato pancakes, uncooked                                      | Drizzled with a little oil    |                              |
| Schupfnudeln (potato dumplings), precooked                     | –                             |                              |
| Tofu patty, 2.8 oz (80 g), cooked                              | –                             |                              |

## Special modes

| Food                                    | Cooking tips | Browning segment bar setting  |
|---|--------------|---|
| Pizza, baked                            | –            | <input type="checkbox"/> <input checked="" type="checkbox"/> <input type="checkbox"/> _ _ _ _ _   |
| Rye bread roll, frozen                  | Thawed       | <input type="checkbox"/> <input checked="" type="checkbox"/> <input type="checkbox"/> _ _ _ _ _   |
| Rye bread roll, prebaked                | –            | <input type="checkbox"/> <input type="checkbox"/> <input type="checkbox"/> _ _ _ _ _  |
| Hash browns, baked                      | Butter, salt | <input type="checkbox"/> <input type="checkbox"/> _ _ _ _ _   |
| Hash browns, frozen                     | Thawed       | <input checked="" type="checkbox"/> <input type="checkbox"/> _ _ _ _ _  |
| White roll, frozen                      | Thawed       | <input type="checkbox"/> <input checked="" type="checkbox"/> _ _ _ _ _  |
| White roll, prebaked                    | –            | <input type="checkbox"/> <input type="checkbox"/> _ _ _ _ _   |
| Onion tart, 1" (2.5 cm) thick, prebaked | –            | _ _ _ _ _ <input checked="" type="checkbox"/> <input type="checkbox"/>  |
| <b>Desserts</b>                         |              |   |
| Kaiserschmarrn pancake, cooked          | –            | _ <input type="checkbox"/> <input type="checkbox"/> <input checked="" type="checkbox"/> <input type="checkbox"/> <input type="checkbox"/> _ |
| Kaiserschmarrn pancake, frozen          | Thawed       | _ _ _ _ <input type="checkbox"/> <input type="checkbox"/> <input type="checkbox"/> _  |
| Kaiserschmarrn pancake, uncooked        | Mix mixture  | <input type="checkbox"/> <input type="checkbox"/> _ _ _ _ _   |

<sup>1</sup> Add 1 tsp corn starch to raw meat/fish.

<sup>2</sup> Fairly firm

# Special modes

## Food suitable for the “Gentle Cooking” Special Mode

| Food   | Cooking tip                               |
|--|---|
| <b>Meat<sup>1</sup></b>  |   |
| Large bockwurst/frankfurter sausage (pork), 3.5 oz (100 g), cooked | –   |
| Beef filet skewer, 1.7 oz (50 g) chunks, raw                       | Marinated, with bacon                     |
| Pork skewer, 1.7 oz (50 g) chunks, raw                             | Marinated, with bell pepper and onion     |
| Chicken breast, 1 1/4" (3 cm) thick, raw                           | On its own, seasoned                      |
| Chicken breast, stuffed, raw                                       | Seasoned, filling: spinach, crème fraîche |
| Chicken skewer, 1.7 oz (50 g) chunks, raw                          | Marinated, with bell pepper and onion     |
| Veal tenderloin, 1" (2.5 cm) thick, raw                            | Marinated, in sauce                       |
| Smoked pork, 1 1/2" (3.5 cm) thick, raw                            | –   |
| Smoked pork chop, 3/4" (2 cm) thick, raw                           | –   |
| Meatballs, 2.6 oz (75 g), raw                                      | Ground meat, seasoned, in sauce           |
| <b>Fish<sup>1</sup></b>  |   |
| Trout, whole, 3/4 lb (350 g), raw                                  | Seasoned, filling: butter, herbs          |
| Halibut cutlet, 1 1/4" (3 cm) thick, raw                           | Marinated                                 |
| Cod filet, 1 1/2" (3.5 cm) thick, raw                              | Marinated                                 |
| Cod filet, stuffed, raw  | Seasoned, filling: spinach, tomato        |
| Salmon filet, 1 1/4" (3 cm) thick, raw                             | Seasoned                                  |
| Salmon cutlet, 1 1/4" (3 cm) thick, raw                            | Marinated                                 |
| Salmon skewer, 1.7 oz (50 g) chunks, raw                           | Seasoned                                  |
| Pollock filet, 6.3 oz (180 g)                                      | Topping: spinach and crème fraîche        |
| Tuna filet, 1 1/4" (3 cm) thick, raw                               | Marinated                                 |
| Catfish skewer, 1.7 oz (50 g) chunks                               | Marinated, with bacon                     |
| <b>Vegetables</b>  |   |
| Cauliflower, large florets, raw                                    | Seasoned                                  |
| Broccoli, large florets, raw                                       | Seasoned, with/without cheese sauce       |
| Cherry tomatoes, whole, raw  | Marinated                                 |
| Fennel, 3/4" (2 cm) chunks/wedges, raw                             | Seasoned                                  |
| Potatoes <sup>2</sup> , quartered/in wedges, raw                   | Salt                                      |
| Potatoes, Idaho/Russet, halved, raw                                | Salt                                      |
| Kohlrabi, 3/4" (2 cm) slices, raw                                  | Salt, pepper, nutmeg                      |
| Pumpkin, 1/2" (1.5 cm) chunks, raw                                 | Salt, pepper, pumpkin seed oil            |

## Special modes

| Food   | Cooking tip                                  |
|--|--|
| Corn on the cob, raw   | Salt, butter                                 |
| Carrots, quartered/3/4" (2 cm) slices, raw                     | Salt, pepper, butter                         |
| Bell pepper, large chunks, raw                                 | Marinated                                    |
| Ratatouille, 3/4" (2 cm) chunks, raw                           | Tomato purée, seasoning, corn starch         |
| Brussels sprouts, whole, raw                                   | Salt, pepper, nutmeg                         |
| Bacon-wrapped string beans                                     | Wrapped in bacon slices, seasoned            |
| Asparagus, spears, whole, raw                                  | Salt, butter                                 |
| Sweet potato, 1/2" (1.5 cm) chunks/wedges, raw                 | Salt   |
| Zucchini, 3/4" (2 cm) slices, raw                              | Marinated                                    |
| <b>Pasta and rice</b>  |  |
| Fresh pasta, tortellini, precooked                             | Sauce  |
| Macaroni, short, uncooked                                      | Salt, 1:3 (pasta:water)                      |
| Rice, basmati rice, cooking duration 10 minutes, uncooked      | Salt, 1:2.5 (rice:liquid)                    |
| Rice, brown rice, cooking duration 8 minutes, uncooked         | Salt, 1:2 (rice:liquid)                      |
| Rice, parboiled rice, cooking duration 8 minutes, uncooked     | Salt, 1:2 (rice:liquid)                      |
| Rice, parboiled rice, cooking duration 10–12 minutes, uncooked | Salt, 1:2 (rice:liquid)                      |
| Rice, short-grain rice, cooked                                 | –  |
| Vermicelli, uncooked   | Covered with stock                           |
| <b>Pizza etc.</b>  |  |
| Gnocchi, precooked   | Salt, butter                                 |
| Potato dumplings, in cooking bag, precooked                    | Covered with water                           |
| Mashed potato, instant   | Mix powder according to packet instructions. |
| Mashed potato, cooked  | –  |
| Schupfnudeln (potato dumplings), precooked                     | Salt, butter                                 |

<sup>1</sup> Add 1 tsp corn starch to raw meat/fish.

<sup>2</sup> Yukon Gold

## Special modes

---

### Menu Cooking – automatic

When cooking a menu automatically, you can combine up to 3 different foods with different cooking durations, e.g., fish filet with rice and vegetables.

With menu cooking, the food is placed in the steam oven compartment at different times so that each item is ready at the same time.

You can select items of food in any order, because the steam oven sorts them according to cooking duration and indicates when each item has to be placed in the oven.

The Ready at and Start at functions are not available in menu cooking.

### Using the Menu Cooking Special Mode

■ Select Special Modes  | Menu Cooking.

■ Select the food you want.

Depending on the type of food selected, you will be asked about the size, weight, and how well you want it cooked.

■ Select the values required and then confirm with *OK*.

■ Select Add food.

■ Select the next food you want and proceed as described for the first type of food.

■ Repeat for the third type of food if necessary.

After confirming Start Menu Cooking, you will be prompted to place the food with the longest cooking duration into the oven compartment.

■ When using perforated steam oven pans to cook foods that produce a lot of liquid or have a distinctive color, be sure to place them over the universal tray. This avoids any transfer of flavor or color to other food and prevents liquid dripping onto food below it.

At the end of the heating-up phase, the steam oven will indicate when the next item of food has to be placed inside.

Once this time has been reached, a buzzer will sound.

This process is repeated once again if there is a third food item.

Food types that are not listed can still be cooked together. Please refer to “Menu cooking – manual” under “Steam cooking” for more information.

## Canning

Always observe USDA/CFIA food safety guidelines.

Only use unblemished, fresh produce which is in good condition.

### Glass jars

Use clean glass jars and accessories and check them for any defects. Glass jars with twist off lids or glass lids with a rubber seal are suitable.

Make sure that all the glass jars are the same size so that bottling is carried out evenly.

After you have filled the jars with the bottled produce, clean the glass rims with a clean cloth and hot water and then seal the jars.

### Fruit

Sort fruit carefully, rinse it briefly but thoroughly and allow it to drain. Take great care when cleaning soft fruit as it is very delicate.

Remove any peel, stalks, cores or pits. Cut up large fruit. For example, cut apples into slices.

If you are bottling fruit with pits (e.g. plums, apricots) without removing the pits, pierce the fruit several times with a fork or wooden skewer as otherwise it will burst.

### Vegetables

Rinse, clean, and chop vegetables.

Vegetables should be blanched before canning to help them retain their color (see “Blanching” under “Special Modes”).

## Fill volume

Fill the glass jars with produce up to a maximum of 1 1/4" (3 cm) below the rim. Do not pack down as this would damage the cell walls of the produce. Bang the jar gently on a cloth to help distribute the contents evenly.

Use a sugar solution for fruit and a salt or vinegar solution for vegetables.

## Meat and sausage

Briefly fry or cook the meat before canning. Use the juices with some added water, or the broth in which the meat was cooked, as the liquid content of the jars. Make sure there is no grease on the rim of the jars.

When canning sausages, only fill the jars halfway as the meat will rise during the canning process.

## Tips

- Make use of residual heat by leaving the jars in the oven for 30 minutes after it has switched off.
- Then cover the jars with a cloth and allow to cool for approx. 24 hours.

## Canning food

- Place a perforated container or the wire rack at level 1.
- Place the jars in the perforated container or on the wire rack. The jars must not touch each other.

## Settings

Special Modes  | Canning  
or

Operating Modes  | Steam Cooking 

Temperature: see chart

Canning duration: see chart

## Special modes

The durations specified in the chart are guidelines only.

| Food to be canned      | 🌡️ [°F (°C)] | ⌚* [min] |
|------------------------|--------------|----------|
| <b>Berries</b>         |              |          |
| Currants               | 175 (80)     | 50       |
| Gooseberries           | 175 (80)     | 55       |
| Cranberries            | 175 (80)     | 55       |
| <b>Fruit with pits</b> |              |          |
| Cherries               | 185 (85)     | 55       |
| Mirabelle plums        | 185 (85)     | 55       |
| Plums                  | 185 (85)     | 55       |
| Peaches                | 185 (85)     | 55       |
| Greengage plums        | 185 (85)     | 55       |
| <b>Fruit with pips</b> |              |          |
| Apples                 | 195 (90)     | 50       |
| Apple sauce            | 195 (90)     | 65       |
| Quinces                | 195 (90)     | 65       |
| <b>Vegetables</b>      |              |          |
| Beans                  | 212 (100)    | 120      |
| Broad beans            | 212 (100)    | 120      |
| Pickling cucumbers     | 195 (90)     | 55       |
| Beets                  | 212 (100)    | 60       |

🌡️ temperature, ⌚\* canning duration

\* The canning times apply to 4 1/4 cups (1.0 l) jars. If using 2 cups (0.5 l) jars, reduce the duration by 15 minutes. If using 1 cup (0.25 l) jars, reduce the duration by 20 minutes.



## Canning cakes

Batter, sponge, and yeast dough are suitable for canning. The cake has a shelf-life of 6 months.

Cooked cakes **containing fruit** are **not suitable for storage**. They must be consumed within two days.





Only use sterilized jars and accessories. The jars must be narrower at the bottom than at the top (mason jars). 1 cup (0.25 l) jars are the best for this purpose.



The jars need to have a canning ring, glass lid, and a spring lock clip to be sealed.

Make sure that all the glass jars are the same size so that canning is carried out evenly.

- Grease the inside of the jars with butter up to 1/2" (1 cm) below the rim.
- Sprinkle fine breadcrumbs inside the jars.
- Fill the jars 1/2 to 2/3 full with mixture (depending on recipe). Make sure the rim stays clean.
- Place the wire rack on shelf level 2.
- Place the **open** jars (all the same size) on the wire rack. The jars must not touch each other.
- Close the jars **immediately** after canning by clamping the glass lid down securely. Do not let the cakes cool down. If the mixture has risen above the rim, it can be pushed back down into the jar with the glass lid.

The durations specified in the chart are guidelines only. We recommend selecting the shorter duration initially. You can extend the duration if necessary.

| Type of mixture | Operating mode  | Step | 🌡️ °F [°C] | ΔΔ [%] | 🕒 [min] |
|-----------------|---|------|------------|--------|---------|
| Batter          |  | –    | 325 (160)  | –      | 35–45   |
| Sponge          |  | –    | 325 (160)  | –      | 50–55   |
| Yeast dough     |  | 1    | 85 (30)    | 100    | 10      |
|                 |  | 2    | 325 (160)  | 30     | 30–35   |

🌡️ temperature, ΔΔ moisture, 🕒 duration  
 Surround,  Combi-Steam + Surround

## Special modes

### Dehydrate

Only use the Dehydrate Special Mode or the Combi Conv Bake  operating mode to dry food so that moisture can be dissipated.

Bananas, pineapple, and chanterelles are not suitable for drying.

- Cut the food for drying into equally sized pieces.
- Line the rack with parchment paper and distribute the food for drying evenly in a single layer if possible.
- Allow the fruit or vegetables to cool down after drying.
- Store the dried food in sealed glass jars or cans.  
To prevent mold from forming and the food from decomposing, make sure that no moisture gets into the storage container.

### Settings

Special Modes  | Dehydrate

Temperature: see chart

Drying time: see chart

or

Operating Modes  | Combi Steam  |

Combi Conv Bake 

Temperature: see chart

Moisture: 0%

Drying time: see chart

The drying times specified in the chart are guidelines only. It is recommended to select the shorter drying time initially. You can make the duration longer if necessary.

| Food for drying          | 🌡️ °F [°C]      | ⌚ [h]   |
|--------------------------|-----------------|---------|
| Apple, rings             | 160 (70)        | 6–8     |
| Apricots, halved, pitted | 140–160 (60–70) | 10–12   |
| Pears, sliced            | 160 (70)        | 7–9     |
| Herbs                    | 105 (40)        | 1.5–2.5 |
| Mushrooms*               | 120 (50)        | 5–7     |
| Tomatoes, sliced         | 160 (70)        | 7–9     |
| Citrus fruit, sliced     | 160 (70)        | 8–9     |
| Plums, pitted            | 140–160 (60–70) | 10–12   |

🌡️ Temperature, ⌚ Drying time (hours)

\* Porcini mushrooms, shiitake, morels, wood ear, and bay bolete are suitable for drying. The mushrooms are sufficiently dried when they are “cracker dry”.

## Using the Sabbath program and Yom Tov

The Sabbath Program and Yom-Tov Special Modes help to support religious observance.

To comply with the Sabbath regulations, follow the instructions on the display.

The steam oven heats up to the temperature you have set and maintains this temperature for a maximum of 24 hours (Sabbath Program) or 76 hours (Yom-Tov). In both Special Modes, the steam oven turns off automatically after 76 hours.

- Turn off cabinet front detection.
- Place the food in the oven compartment.
- Select Special Modes .
- Select Sabbath Program.
- Select the Special Mode you want (Sabbath Program or Yom-Tov).

You will not be able to start the Special Mode if you have set a timer or alarm.

Once a Special Mode has started, it cannot be changed or saved under Favorites.

The Special Mode will be canceled in the event of a power failure. The steam oven will only remain in compliance with Sabbath regulations for as long as it continues to be disconnected from the power supply. As soon as the connection is restored, Power failure - Program cancelled is displayed.

## Using Sabbath Program

This Special Mode is suitable for the weekly Sabbath (Shabbat). You can use it to keep food warm for up to 24 hours, until you open the door of the oven for the first time.

- Set the temperature.
- Select Start.

Sabbath Program and the set temperature will appear in the display.

The oven heating will turn on around 30 seconds after you have closed the door. The oven interior lighting will remain on during the entire cooking process.

The time of day will not appear. The proximity sensor will not respond, and neither will any of the sensor controls (except for the  On/Off sensor control).

The following message is displayed: Sabbath - Do not open the door. This message disappears after approx. 45 minutes and is displayed again from time to time after that.

If the message is **not** displayed, the steam oven is not heating up and you can open the door and close it again. As soon as you have opened the door for the first time, the oven heating **remains turned off** until the end of the Special Mode.

If you leave the door closed until the end of the Special Mode, the oven heating will only turn off after 24 hours. The steam oven remains switched on.

- If you want to end the Special Mode prematurely, turn off the steam oven using the  On/Off sensor control.

## Special modes

---

After the end of the Special Mode, the notification Sabbath - Do not open the door disappears and the oven heating turns off. The other messages will continue to be shown on the display until the steam oven switches off automatically after 76 hours.

The oven heating remains turned on until the end of the Special Mode. The steam oven will switch off automatically after 76 hours.

### Using Yom-Tov

This Special Mode is suitable for days of observance spanning several days across the week. You can use it to keep food warm for up to 76 hours. You can open and close the door multiple times during this time.

- Set the temperature.
- Select Start.

Yom-Tov and the set temperature will appear in the display.

The oven heating will turn on around 30 seconds after you have closed the door. The oven interior lighting will remain on during the entire cooking process.

The time of day will not appear. The proximity sensor will not respond, and neither will any of the sensor controls (except for the  On/Off sensor control).

The following message is displayed: Sabbath - Do not open the door. This message disappears after approx. 45 minutes and is displayed again from time to time after that.

If the message is **not** displayed, you can open and close the door multiple times. The oven heating **remains on**.

- If you want to end the Special Mode prematurely, turn off the steam oven using the  On/Off sensor control.

### Juicing

This appliance is ideal for extracting juice from soft, firm, and hard fruit.

It is best to use overripe fruit, as the riper the fruit, the greater the quantity of juice produced. Very ripe fruit will also produce a more intense flavor.

### Preparation

Sort and rinse the fruit. Cut out any blemishes.

Remove the stalks from grapes and cherries as these are bitter. Berries do not need to have their stalks removed.

Dice larger fruit such as apples into approximately 3/4" (2 cm) cubes. The harder the fruit, the smaller the pieces should be.

### Tips

- Try experimenting with mild and tart flavors.
- The juice quantity and aroma are improved if sugar is added to the fruit and is allowed to soak in for several hours. We recommend 1/4–1/2 cup (50–100 g) sugar per 2 lbs (1 kg) of sweet fruit and 1/2–3/4 cup (100–150 g) sugar for 2 lbs (1 kg) tangy fruit.
- If you wish to bottle the juice rather than consume it straight away, while still hot pour it into clean bottles and seal immediately.

### Extracting juice from fruit

- Put the prepared fruit (cleaned, washed, chopped etc.) into a perforated cooking container.
- Place a solid cooking container or the universal tray underneath in order to collect the juice.

### Settings

Operating Modes  | Steam Cooking   
Temperature: 212°F (100°C)  
Duration: 40–70 minutes

# Special modes

---

## Blanching

Blanch fruit and vegetables before freezing them. Blanching helps maintain the quality of the produce when it is frozen.

Blanching vegetables also helps them retain their original color.

- Put the prepared vegetables (cleaned, washed, chopped, etc.) into a perforated cooking container.
- Once blanched, plunge the vegetables into ice cold water to cool them down quickly. Drain them well.

### Settings

Special Modes  | Blanch

or

Operating Modes  | Steam Cooking 

Temperature: 212°F (100°C)

Blanching time: 1 minute

## Sanitizing Cookware

The steam oven will sanitize baby bottles and other cookware. Check beforehand that the manufacturer guarantees all components are to be heat resistant to 212°F (100°C) and also steam resistant follow manufacturers instructions.

Dismantle, clean and thoroughly rinse baby bottles. Reassemble the bottles only after they have completely dried. This prevents recontamination.

- Place the individual items on the wire rack or in a perforated container (on their sides or with the opening facing downward) ensuring that they do not touch one another. This will allow hot steam to reach them from all sides.

### Settings

Special Modes  | Sanitize Cookware

Duration: 1 minute to 10 hours

or

Operating Modes  | Steam Cooking 

Temperature: 212°F (100°C)

Duration: 15 minutes

## Warm-up Cookware

Preheating the dishware means that food does not cool down as quickly.

Use heat-resistant dishware.

- Place the wire rack on shelf level 2 and place the dishware to be warmed on it. Depending on the size of the dishware, you can also place the wire rack on the floor of the oven compartment with the rack surface facing up and the dishware on top. If necessary, you can also remove the side racks.
- Select Special Modes .
- Select Warm-up Cookware.
- Alter the recommended temperature if necessary and then set the time.

 Danger of injury caused by hot surfaces.

The steam oven gets hot during operation. You could burn yourself on the heater elements, oven compartment, side racks, or accessories. Condensation may accumulate on the bottom of the dishware.

Use pot holders when removing dishware.

## Keep warm

You can keep food warm in the oven compartment for up to 2 hours.

In order to maintain the quality of food, select the shortest possible time.

- Select Special Modes .
- Select Keep warm.
- Place the food to be kept warm in the oven and confirm with *OK*.
- Alter the recommended temperature if necessary and then set the time.

## Special modes

---

### Proofing

- Prepare the dough according to the recipe.
- Place the dough in an uncovered bowl in a perforated container or on the inserted wire rack.  
Depending on the size of the bowl, you can also place the wire rack on the floor of the oven compartment with the rack surface facing up and place the bowl on top. If necessary, you can also remove the side racks.

### Settings

Special Modes  | Proof

or

Operating Modes  | Combi Steam  |  
Combi Conv Bake 

Temperature: 85°F (30°C)

Moisture: 100%

Duration: as per recipe instructions

### Heating damp towels

- Moisten the towels and then roll them up.
- Place them beside one another in a perforated cooking container.

### Settings

Automatic Programs  | Special | Heat  
Damp Towels

or

Operating Modes  | Steam Cooking 

Temperature: 160°F (70°C)

Duration: 2 minutes

### Dissolving Gelatine

- Soften **gelatine leaves** by leaving them in a bowl of cold water for 5 minutes. The gelatine leaves have to be fully covered with water. Remove the gelatine leaves from the bowl and squeeze them out. Empty the bowl. Place the squeezed gelatine leaves back in the bowl.
- Place **gelatine powder** in a bowl and add water according to the instructions on the packaging.
- Cover the bowl and place it in a perforated cooking container.

### Settings

Automatic Programs  | Special | Dissolve  
Gelatine

or

Operating Modes  | Steam Cooking 

Temperature: 195°F (90°C)

Duration: 1 minute



## Decrystallize honey

- Loosen the lid and place the jar of honey in a perforated steam oven pan.
- Stir the honey once during the process.

When liquefying (decrystallizing) honey at a temperature of 140°F (60°C), the main aim is to achieve a spreadable consistency again.

### Settings

Automatic Programs  Auto | Special | Decrystallize Honey

or

Operating Modes  | Steam Cooking

Temperature: 140°F (60°C)

Duration: 90 minutes (irrespective of the size of jar or the amount of honey in the jar)

Select the following settings to ensure that the honey retains its nutrients and aroma:

Operating Modes  | Combi Steam  | Combi Surround

Temperature: 99°F (37°C)

Moisture: 100%

Time: until the honey has a homogeneous appearance

## Melting Chocolate

You can use the steam oven for melting any type of chocolate.

When using a cake glaze, place it in a perforated cooking container, leaving it in its packaging.

- Break the chocolate into small pieces.
- Place larger quantities in a solid cooking container and smaller quantities in a cup or a bowl.
- Cover the container or the dish with a lid or with foil that is resistant to temperatures up to 212°F (100°C) and to hot steam.
- Stir large quantities once during cooking.

### Settings

Automatic Programs  Auto | Special | Melt Chocolate

or

Operating Modes  | Steam Cooking

Temperature: 150°F (65°C)

Duration: 20 minutes

## Special modes

---

### Rendering Fat

The bacon will not become brown.

- Place the bacon (diced or rashers) in a solid cooking container.
- Cover the container with foil that is temperature-resistant up to 212°F (100°C) and resistant to steam.

#### Settings

Automatic Programs  Auto | Special | Render Fat

or

Operating Modes  | Steam Cooking

Temperature: 212°F (100°C)

Duration: 4 minutes

### Sweating Onions

Sweating means cooking the onions in their own juices, with the addition of a little fat if necessary.

- Cut the onions up into small pieces and place them in a solid cooking container with a little butter.
- Cover the container with foil that is temperature-resistant up to 212°F (100°C) and resistant to steam.

#### Settings

Automatic Programs  Auto | Special | Steam Onions

or

Operating Modes  | Steam Cooking

Temperature: 212°F (100°C)

Duration: 4 minutes

### Preserving Apples

You can treat homegrown apples in the steam oven to increase the length of time for which you can store them.

Once treated, the apples will keep for 5 to 6 months when stored in a dry, cool and well-ventilated place. This method is only suitable for apples and not for other types of fruit.

#### Settings

Automatic Programs  Auto | Fruit | Apples | Whole

or

Operating Modes  | Steam Cooking

Temperature: 125°F (50°C)

Preserving time: 5 minutes

### Preparing custard royale

- Stir 6 eggs into 1 1/2 cup (375 ml) milk (do not beat into a foam).
- Season the egg/milk mixture and pour into a solid cooking container greased with butter.

#### Settings

Operating Modes  | Steam Cooking

Temperature: 212°F (100°C)

Duration: 4 minutes

## Fruit jam

Only use unblemished, fresh produce which is in good condition.

### Glass jars

Only use sterilised jars with twist-off lids up to a maximum capacity of 1 cup (250 ml).

After pouring in the jam, clean the outside of the rim of the jar with a cloth and hot water.

### Preparation

Sort fruit carefully, rinse it briefly but thoroughly and allow it to drain. Take great care when cleaning soft fruit as it is very delicate and squashes easily. Remove any stalks, cores or pits.

Purée the fruit as otherwise the preserve will not set. Add jam sugar to the fruit (according to packet instructions) and stir well.

For sweet fruit and berries you should also add some citric acid.

### Making jam

- Fill jars maximum two-thirds full.
- Place the open jars in a perforated steam oven pan or on the wire rack.
- Leave the jars to stand for 1–2 minutes after the end of the process.
- Then seal the jars with a lid and leave them to cool.

### Settings

Operating Modes  | Combi Steam  | Combi Conv Bake

Temperature: 300°F (150°C)

Moisture: 0%

Duration: 35–45 minutes

## Skinning Fruits and Vegetables

- Cut a cross in the top of tomatoes, nectarines etc. This will allow the skin to be removed more easily.
- Place the food in a perforated cooking container if cooking with steam, or a universal tray if using the broiler.
- To blanch almonds, it is important to plunge them into cold water as soon as they are taken out of the oven as otherwise the skin cannot be removed.

### Settings

Operating Modes  | Maxi Broil

Level: 3

Duration: see chart

| Food         | ⌚ [min] |
|--------------|---------|
| Bell Peppers | 10      |
| Tomatoes     | 7       |

⌚ duration

### Settings

Operating Modes  | Steam Cooking

Temperature: 212°F (100°C)

Duration: see chart

| Food         | ⌚ [min] |
|--------------|---------|
| Apricots     | 1       |
| Almonds      | 1       |
| Nectarines   | 1       |
| Bell Peppers | 4       |
| Peaches      | 1       |
| Tomatoes     | 1       |

⌚ Duration

## Special modes

---

### Making Yogurt

Always observe USDA/CFIA food safety guidelines.

To prepare yogurt, you will need milk and live culture or yogurt starter powder, e.g., from a health food store.

Use natural yogurt with live culture and without additives. Heat-treated yogurt is not suitable.

The yogurt must be fresh (short storage time).

You can use either unchilled long-life milk or fresh milk.

Long-life milk can be used as it is – no further preparation is required. Fresh milk must first be heated to 195°F (90°C) (do not boil it) and then cooled down to 95° (35°C). Fresh milk will give a better set than long-life milk.

The yogurt and milk should have the same percentage fat.

Do not move or shake the jars while the yogurt is fermenting.

Immediately after preparation, leave the yogurt to cool in the fridge.

The firmness, fat content, and cultures used in the yogurt starter all affect the consistency of homemade yogurt. Not all yogurts are equally suitable as yogurt starters.

**Tip:** When using yogurt enzyme, yogurt can be made from a milk/cream mixture. Mix 3 cups (¾ liter) milk with 1 cup (¼ liter) cream.

- Mix 3.5 oz (100 g) of yogurt with 4 ¼ cups (1 l) of milk or make up the mixture with yogurt starter, following the instructions on the packaging.
- Pour the mixture into glass jars and seal the jars.
- Place the sealed jars in a perforated cooking container and place in the oven. The jars must not touch each other.
- Straight after the cooking duration has finished, place the jars in the refrigerator. Take care not to shake the jars unnecessarily.

### Settings

Automatic Programs  Auto | Special | Make Yogurt

or

Operating Modes  | Steam Cooking

Temperature: 105°F (40°C)

Duration: 5:00 hours

### Possible causes for poor results

#### Yogurt is not set:

Incorrect storage of the yogurt starter, too much time out of the refrigerator, packaging was damaged, milk was insufficiently heated.

#### Liquid has not been removed:

Jars were moved, yogurt was not cooled down quickly enough.

#### Yogurt is grainy:

Milk was overheated or in poor condition, milk and starter yogurt not evenly stirred.

With the wide range of automatic programs, you can achieve excellent results with ease.

## Categories

The automatic programs  are sorted into categories to provide a better overview. Simply select the appropriate automatic program for the type of food you are cooking and follow the instructions on the display.

## Using automatic programs

- Select Automatic Programs .

A list will appear.

- Select the food category you want.

The automatic programs available for the category selected will then appear.

- Select the automatic program that you want to use.
- Follow the instructions on the display.

Some automatic programs will prompt you to use the probe. Read the information under “Roasting – Probe”.

Core temperatures cannot be changed for automatic programs.

**Tip:** Use  Info to display information such as how to place or turn the food depending on the cooking program.

## Usage notes

- After cooking, allow the oven compartment to cool down to room temperature again before starting an automatic program.
- The weights specified in the automatic programs refer to the weight per piece. For example, you can cook just one piece of salmon weighing 1/2 lb (250 g) or 10 pieces of salmon, each weighing 1/2 lb (250 g), at the same time.
- The degree of cooking and browning are represented by a bar with seven segments. You can set how well you want the food cooked or how brown you want it to be by touching the relevant segment.
- Some roasting programs also offer the *Roast with moisture* option. Meat cooked at a low temperature over a long cooking duration will be tender and succulent. The additional moisture helps to achieve the best cooking and browning result: The meat is very succulent and tender. The cut is cooked evenly and has a thin brown outer layer that forms during the roasting program. There is therefore no need to sear the meat beforehand. In contrast to the *Roast* option, there is no need to use the food probe in this case and you can set a start or finish time depending on your menu planning.
- Please refer to recipes for information on suitable bakeware.
- In the *Rice* category, you can select *General* in addition to the long-grain and short-grain rice programs. Use this automatic program if you want to cook long-grain or short-grain rice varieties that are not available as a specific automatic program.

# Automatic Programs

---

- For some automatic programs, the start or finish time can be delayed using Start at or Ready at.
- The individual cooking stages of the automatic program are listed under the Display cooking stages menu option. The Display actions menu option is also available for some automatic programs. You can call up required actions, e.g., placing food in the oven or adding ingredients, via this menu option. During the cooking process, you can view the actions via **i** Info.
- When you place food in the hot oven compartment, be careful when opening the door. Hot steam may escape. Step back and wait until the steam has dissipated. Avoid contact with hot steam, and do not touch the hot oven compartment walls. Danger of burning and scalding.
- If by the end of an automatic program the food is not cooked enough for your taste, select Continue cooking or Continue baking.
- Automatic programs can also be saved as Favorites.

## Search

(Depending on language)

Under Automatic Programs, you can search by the name of the categories and the automatic programs.

This search is a full-text search and can also be used to search for parts of words.

From the main menu:

- Select Automatic Programs **Auto**.

The category list will appear on the display.

- Select Search.

- Use the keyboard to type in the search text, e.g., "Bread".

The number of hits will be shown in the footer.

If no match is found or if there are more than 40 matches, the hits field will be deactivated and you will need to change the search text.

- Select XX hits.

The categories and automatic programs found will then appear.

- Select the automatic program you want, or the category and then the automatic program you want.

The automatic program will start.

- Follow the instructions on the display.

Under MyMiele , you can save frequently used applications.

It is particularly useful with the automatic programs as you do not need to work through every menu level in order to start a program.



**Tip:** You can also set menu options that you have entered in MyMiele to appear on the start screen (see “Settings – Start screen”).

## Adding entries

You can add up to 20 entries.

- Select MyMiele .
- Select Add entry.

You can select options from the following categories:

- Operating modes
- Automatic Programs  **Auto**
- Special Modes  
- Favorites  
- Maintenance  

- Confirm with *OK*.

The selected subitem and its respective symbol will appear in the list.

- Proceed as described for further entries. Only options that have not yet been selected are available for selection.

## Deleting entries

- Select MyMiele .
- Touch the entry you want to delete and keep your finger on it until the context menu appears.
- Select Delete.

The entry will then be removed from the list.

## Moving entries

- Select MyMiele .
- Touch the entry you want to move and keep your finger on it until the context menu appears.
- Select Move.

An orange border will appear around the entry.

- Move the entry.

The entry will now appear in the position you want it in.

## Favorites

---

You can create and save up to 20 of your own programs.

- You can combine up to 9 cooking stages to accurately program your favorite or most frequently used recipes. In each cooking stage, you can select settings such as the function, temperature, and cooking duration.
- You can enter a program name for your recipe.

When you next select the program, it will start automatically.

There are different ways of creating a Favorite:

- At the end of an automatic program or Special Mode, save it as a Favorite.
- After running a program with a set duration, save it.

Then name the program.

### Creating a Favorite

- Select Favorites .
- Select Create program.

You can now specify the settings for the first cooking stage.

Follow the instructions on the display:

- Select and confirm the settings.

If you select the Preheat function, use Add to add another cooking stage where you set a cooking duration. Only then can you save or start the program.

All settings for the first cooking stage have now been set.

More cooking stages can be added, for example, if you would like to add another operating mode to follow the first.

- If additional cooking stages are required, select Add and proceed as for the first cooking stage.

If you want to check the settings or to change them at a later stage, tap the cooking stage in question.

- When you have finished setting the cooking stages, select Save.
- Enter the program name using the keyboard.

You can add a line break for longer program names using the ↵ symbol.

- Once you have entered the program name, select Save.

A message will appear on the display confirming that the name has been saved.

- Confirm with OK.

You can start the saved program immediately, delay the start, or change the cooking stages.



## Starting Favorites

- Place the food in the oven.
- Select Favorites .
- Select the program you want to use.

Depending on the program settings, the following menu options will appear on the display:

- Start now  
The program will start immediately. The oven heating will turn on immediately.
  - Ready at  
You can set the time at which the cooking program should end. The oven will turn off automatically at the time you have set.
  - Start at  
You can set the time at which the cooking program should start. The oven will turn on automatically at the time you have set.
  - Display cooking stages  
A summary of your settings will appear on the display.
  - Display actions  
The required actions, e.g., placing the food in the oven, will appear on the display.
- Select the menu option you want.

The selected program will begin automatically right away or at the time set.

Use  Info to display information such as how to place or turn the food depending on the cooking process.

- At the end of the program, select Close.

## Changing cooking stages

Cooking stages in an automatic program that have been saved under a different name cannot be changed.

- Select Favorites .
- Touch the program you want to change and keep your finger on it until the context menu appears.
- Select Change.
- Select the cooking stage that you want to change or *Add* to add another cooking stage.
- Select and confirm the settings.
- If you want to start the modified program without changing it, select *Start*.
- Select *Save* when you have changed all the settings.

A message will appear on the display confirming that the name has been saved.

- Confirm with *OK*.

The saved program has been changed and you can start it immediately or delay the start.

# Favorites

---

## Renaming Favorites

- Select Favorites .
- Touch the program you want to change and keep your finger on it until the context menu appears.
- Select Rename.
- Change the program name using the keyboard.

You can add a line break for longer program names using the `↵` symbol.

- Once you have changed the program name, select Save.

A message will appear on the display confirming that the name has been saved.

- Confirm with *OK*.

The program has now been renamed.

## Deleting a Favorite

- Select Favorites .
- Touch the program you want to delete and keep your finger on it until the context menu appears.
- Select Delete.
- Confirm the query with Yes.

The program is deleted.

Go to Settings | Factory default | Favorites to delete all Favorites at the same time.

## Moving Favorites

- Select Favorites .
- Touch the program you want to move and keep your finger on it until the context menu appears.
- Select Move.

An orange border will appear around the entry.

- Move the program.

The program will now appear in the position you want it in.

Handling and cooking food correctly is essential for maintaining good health.

Cakes, pizzas, and French fries should be cooked until golden, not dark brown.

Always observe USDA/CFIA food safety guidelines.

## Baking tips

- Set a cooking duration. If used for baking, do not delay the start for too long. Otherwise the cake mixture or dough will dry out, and the raising agents will lose their effectiveness.
- Generally, you can use the wire rack, universal tray, and any type of bakeware made of heat-resistant material.
- Always place bakeware on the wire rack.
- Always cook frozen goods such as cakes, pizza, or baguettes on the wire rack.

Very high temperatures can cause the universal tray to distort to such an extent that the tray cannot be taken out of the oven compartment.

- Small items of frozen food such as oven chips or potato croquettes can be cooked on the universal tray. Turn these frozen food items several times during cooking.
- Bake on a maximum of two levels at the same time.

## Using parchment paper

Miele accessories, e.g., the universal tray, are treated with PerfectClean (see “Cleaning and care for the steam oven”). Surfaces treated with PerfectClean generally do not need to be greased or covered with parchment paper.

- Use parchment paper when cooking:
  - lye mixtures because anything prepared using a lye containing sodium hydroxide can damage the PerfectClean surface
  - mixtures with a high egg-white content, such as sponge, meringue, and macaroons, as these can easily stick
  - puff pastry or strudel dough
  - frozen food on the wire rack
  - small items of frozen food such as oven chips or potato croquettes on the universal tray

# Baking

---

## Tips for baking

- Dark bakeware is best for baking. Avoid using bright, thin-walled pans made from a shiny material as they give an uneven or poor browning result. In certain unfavorable conditions, the food will not cook properly.
- Place cakes in rectangular bakeware on the wire rack with the longer side across the width of the oven for optimum heat distribution and even results.
- When cooking frozen food such as chips, croquettes, cakes, pizza, and baguettes, select the medium temperature quoted on the manufacturer's packaging.
- If a range is specified for the cooking duration, check whether the food is cooked after the shortest duration. Stick a wooden skewer into the food. If it comes out clean without any batter/dough on it, the food is done.



## Notes on the operating modes

You can find an overview of all the operating modes with their recommended values in "Main and submenus".

### Combi Steam

This operating mode uses a combination of oven heat and moisture. The addition of steam prevents the surface of the food from drying out. Bread, bread rolls, and puff pastry have a shiny and crispy crust.

You can choose between different types of heating:

- Combi Conv Bake 
- Combi Surround 
- Combi Broil 

It is recommended to bake bread and bread rolls in several cooking stages: the shine is created during the first cooking stage thanks to the bursts of steam (maximum moisture, low temperature). Browning takes place in the next cooking stage with high moisture and a high temperature. This is followed by a drying stage with reduced moisture and a medium to high temperature.

**Tip:** Recipes and additional information can be found in the Miele app.

## Automatic Programs

Follow the instructions on the display.

## Convection Bake

Use this operating mode if you are baking on multiple shelf levels at the same time.

You can use any type of bakeware made of heat-resistant material.

Because the blower distributes the heat around the oven compartment straight away, you can use a lower temperature than you would with the Surround  operating mode.

## Surround

Use this operating mode for cooking traditional recipes. If using an older recipe or cookbook, set the oven temperature 50°F (10°C) lower than that recommended. This will not change the cooking duration.

Only bake on one level. If you are making a tray bake, use level 3. If you are making a cake in a cake pan, select level 2.

## Intensive

This operating mode is suitable for baking cakes with moist toppings, pizza, quiche, etc.

Place the food on shelf level 1.

## Bake

Use this operating mode toward the end of cooking to brown the base of the food.

## Browning

Use this operating mode toward the end of cooking to brown the top of food.

This operating mode is suitable for gratins and for browning bakes.

## Humidity Plus

Use this operating mode for baking batter and frozen lye mixtures.

# Roasting

Always observe USDA/CFIA food safety guidelines.

## Roasting tips

- Never roast frozen meat as it will dry out. Always defrost meat before roasting.
- Remove skin and sinew before roasting.
- Marinate and season the meat to taste.
- If you are cooking several pieces of meat together, select pieces that are similar in size.
- Use the universal tray with the wire rack placed on top of it. The oven compartment stays cleaner and you can then use the meat juices collected to make a gravy or sauce.

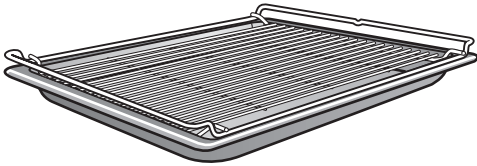

- Allow a resting time of approx. 10 minutes before carving meat. This resting time ensures the meat juices are distributed evenly.



## Notes on the operating modes

You can find an overview of all the operating modes with their recommended values in “Main and submenus”.

### Combi Steam

This operating mode uses a combination of oven heat and moisture. The addition of steam prevents the surface of the food from drying out. The results are particularly tender and succulent meat with a well-browned outside. Use the Combi Steam  operating mode for cooking meat, fish, and poultry dishes.

You can choose between different types of heating:

- Combi Conv Bake 
- Combi Surround 
- Combi Broil 

It is recommended to cook meat slowly and gently in several cooking stages: at a high temperature during the first cooking stage to brown the surface. The second cooking stage requires increased moisture and a reduced temperature. The meat cooks evenly and the muscle protein is broken down, making the meat particularly tender.

**Tip:** Recipes and additional information can be found in the Miele app.

## Automatic Programs

Follow the instructions on the display.

## Convection Roast

This operating mode is suitable for roasting meat and poultry that needs to be well browned.

Because the blower distributes the heat around the oven compartment straight away, you can use a lower temperature than you would with the Surround  operating mode.

## Surround

Use this operating mode for cooking traditional recipes. If using an older recipe or cookbook, set the oven temperature 50°F (10°C) lower than that recommended. This will not change the cooking duration.

Use the Bake  operating mode towards the end of the cooking duration to brown the base of the food.

Do not use the Intensive  operating mode for roasting as the juices will become too dark.

# Roasting

## Food Probe

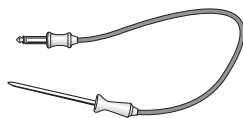

The probe allows you to monitor the roasting process simply and reliably.

### How it works

The metal tip of the food probe must be fully inserted into the center of the food all the way to the handle. There is a temperature sensor in the metal tip which measures the core temperature of the food during the cooking process.

The core temperature set will depend on how well cooked you want your meat to be and on the type of meat. The temperature can be set between 86 and 210°F (30 and 99°C).

The cooking duration will depend on a number of different factors. The higher the temperature in the oven compartment and the moisture (where applicable) and the thinner the meat, the quicker the set core temperature will be reached.

 Damage due to high temperatures.









Temperatures higher than 212°F (100°C) will damage the temperature sensor in the food probe beyond repair.

If you are not using the food probe, remove it from the oven compartment when cooking.

## When to use the probe

Some automatic programs and Special Modes will prompt you to use the probe.

You can also use the probe with Favorites and with the following operating modes:

- Convection Bake 
- Convection Roast 
- Surround 
- Combi Conv Bake 
- Combi Surround 
- Steam Cooking 
- Intensive 
- Convection Broil 
- Humidity Plus 



## Important usage notes

- You can place the meat in a pot or on the wire rack.
- The metal tip of the probe must be fully inserted into the center of the food so that the temperature sensor reaches more or less to the core.
- When cooking poultry, insert the metal part into the thickest part of the breast. You can find the thickest part of the breast by pressing the area with your thumb and index finger.
- The metal tip must not touch any bone or be inserted in areas with a lot of fat. Fatty tissue and bones can cause the probe to turn off early.
- If the meat is very heavily marbled with fat, select the highest core temperature given in the cooking charts.
- When using aluminum foil or roasting bags, insert the probe through the foil/bag into the center of the food. You can also place meat inside the bag or foil with the probe already inserted. Be sure to follow the instructions provided by the manufacturer of the roasting bag or aluminum foil.

## Using the probe

- Fully insert the metal tip of the probe into the center of the meat all the way to the handle.

If you are cooking several pieces of meat at the same time, insert the probe into the largest piece of meat.

- Place the food in the oven.

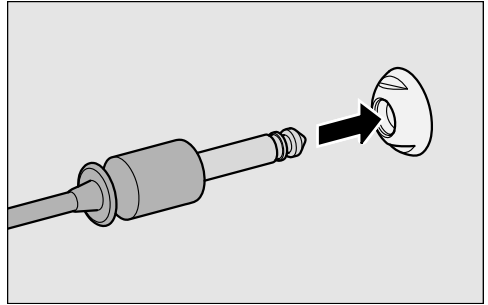

- Insert the plug of the probe into the socket until you feel it engage.
- Close the door.
- Select an operating mode or automatic program.
- Set the temperature and the core temperature if necessary.

Core temperatures cannot be changed for automatic programs.  
Follow the instructions on the display.

The cooking program finishes as soon as the core temperature is reached.

 Risk of injury caused by hot surfaces.

The probe can get hot. You could burn yourself on it.

Use pot holders when removing the probe from its socket.

# Roasting

## Delaying the start of a cooking program with probe

You can also delay the start of the cooking program to a later time.

- Select Start at.

You can estimate approximately when the food will be ready as the duration of the cooking program is about the same as if you were cooking food without using the probe.

You cannot set Duration and Ready at because the total cooking duration is determined by when the set core temperature is reached.

## Chart with core temperatures

| Meat   |  [°F (°C)] |
|--|---|
| Veal   | 145–170 (63–77)   |
| Smoked pork  | 145 (63)  |
| Leg of lamb<br>pink<br>medium<br>well-done                   | 147 (64)<br>169 (76)<br>180 (82)  |
| Saddle of lamb<br>pink<br>medium<br>well-done                | 127 (53)<br>149 (65)<br>176 (80)  |
| Saddle of venison<br>rare<br>medium<br>well-done             | 140 (60)<br>162 (72)<br>178 (81)  |
| Top or bottom<br>round roast                                 | 135 (57)  |
| Beef tenderloin/<br>prime rib<br>rare<br>medium<br>well-done | 105 (41)<br>115 (46)<br>165 (74)  |
| Roast ham/pork   | 145 (63)  |
| Pork tenderloin  | 145 (63)  |
| Game/leg cut   | 185 (85)  |

 core temperature

 Danger of injury caused by hot surfaces.

If you open the appliance door when broiling, the controls will get very hot. Keep the door closed during the broiling program.

Always observe USDA/CFIA food safety guidelines.

## Broiling tips

- Preheating is not necessary when broiling. Place the food in the cold oven compartment.
- Use the universal tray with the wire rack placed on top of it.

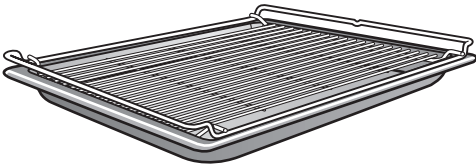

- When broiling fish, place the fish on a piece of parchment paper cut to size.
- Broil thick food, e.g., half a chicken, on shelf level 2 or 3 and thin food, e.g., steaks, on shelf level 4.
- Turn the food  $\frac{2}{3}$  of the way through the cooking duration. Exception: fish does not need to be turned.

## Tips for broiling

- Marinate lean meat or brush it with oil. Do not use other types of fat as they can burn and cause smoke.
- Make diagonal cuts in sausages before broiling.
- It is best to broil food of a similar thickness at the same time so that the broiling time for each item does not vary too greatly.
- To **test the food**, press down on the meat with a spoon. This lets you determine how well the meat has been cooked.
  - **Rare/pink**  
If the meat gives easily to the pressure of the spoon, it will still be red on the inside.
  - **Medium**  
If there is some resistance, the inside will be pink.
  - **Well-done**  
If there is significant resistance, it is cooked through.
- To broil thicker pieces of food more gradually after an initial high temperature, continue broiling at a lower temperature setting or use a lower shelf level to allow the food to cook through to the center.

# Broiling

---

## Notes on the operating modes

You can find an overview of all the operating modes with their recommended values in “Main and submenus”.

The plastic on the probe can melt at very high temperatures.

Do not use the food probe when using the broiling operating modes (exception: Convection Broil ).

Do not store the probe in the oven compartment when it is not being used.

### Combi Broil

This operating mode is suitable for broiling food that should be brown on the outside, but not dry, e.g., corn on the cob.

### Maxi Broil

Use this operating mode to broil flat thin cuts in large quantities and for browning large baked dishes.

### Broil

Use this operating mode to broil flat thin cuts in smaller quantities and for browning small baked dishes.

### Convection Broil

This operating mode is suitable for broiling thicker food, such as poultry or rolled meat.

# Cleaning and care for the steam oven

## Important information on cleaning and care

 Danger of injury caused by hot surfaces.

The steam oven gets hot during operation. You could burn yourself on the heater elements, oven compartment, side racks, or accessories.

Allow the heater elements, oven compartment, side racks, and the accessories to cool before manual cleaning.

 Risk of injury due to electric shock.

The steam from a steam cleaner could reach live electrical components and cause a short circuit.

Do not use a steam cleaner to clean the steam oven.

All surfaces could be discolored or damaged if unsuitable cleaning agents are used. The front of the steam oven is particularly susceptible to damage from oven cleaners and descaling agents.

All surfaces are susceptible to scratching. Scratches on glass can lead to breakage in some circumstances.

Remove any residual cleaning agent immediately.

Stubborn soiling could damage the steam oven in certain circumstances.

Once the oven has cooled, clean the oven cavity, the inside of the door, and the door seal. Waiting too long to clean the oven will make it much more difficult to clean.

Do not use commercial cleaning agents. Only use agents designed for domestic use.

Do not use cleaning agents or liquid dish soap containing aliphatic hydrocarbons as these could cause the seals to swell.

- The appliance and accessories should be cleaned and dried thoroughly after each use.
- Leave the appliance door open until the oven compartment is completely dry.

If the steam oven is not going to be used for a longer period of time, it should be thoroughly cleaned and dried beforehand to prevent the build-up of odors, etc. Leave the door open afterward.

# Cleaning and care for the steam oven

---

## Unsuitable cleaning agents

To avoid damaging the surfaces of your appliance, do not use:

- cleaning agents containing soda, ammonia, acids, or chlorides
- cleaning agents containing descaling agents
- abrasive cleaning agents (e.g., powder cleaners and cream cleaners)
- solvent-based cleaning agents
- stainless-steel cleaners
- dishwasher cleaning agents
- cleaning agents for ceramic-glass cooktops
- hard, abrasive brushes or sponges (e.g., pot scourers, brushes, or sponges which have been previously used with abrasive cleaning agents)
- eraser sponges
- sharp metal scrapers
- steel wool
- stainless-steel scouring pads
- spot cleaning with mechanical cleaning agents
- oven cleaners and sprays

Glass cleaners **may be used** to clean the exterior. However **do not** allow them to sit or "puddle", this can cause damage to the surface. **Remove the cleaner promptly.**

## Cleaning the front

- Clean the front of the oven with a soft sponge and a solution of warm water and liquid dish soap.
- After cleaning, wipe the front dry using a soft cloth.

**Tip:** A clean, damp microfiber cloth without cleaning agent can also be used for cleaning.

# Cleaning and care for the steam oven

## PerfectClean

The oven compartment, side racks, universal tray, and wire rack surfaces are **treated with PerfectClean**. This finish has an iridescent appearance. PerfectClean surfaces have very good non-stick properties and are easy to clean.

However, it is important to clean the surfaces each time the oven is used. The non-stick properties will deteriorate if soiling is not removed from PerfectClean surfaces after each use. If used frequently without being cleaned, cleaning may become very difficult.

Soiling such as spilt juices and cake mixtures are best removed while the oven compartment is still warm.

Spilt fruit juices may cause discoloration to the surfaces that cannot be removed. However, this does not affect the properties of the PerfectClean finish.

Always remove all cleaning agent residues to protect the non-stick properties.

## To protect the non-stick effect of PerfectClean surfaces, please avoid:

- abrasive cleaning agents (e.g., powder cleaners and cream cleaners)
- cleaning agents for ceramic-glass cooktops
- ceramic-glass and stainless-steel cleaners
- steel wool
- abrasive sponges, e.g., pot scourers or sponges which have been previously used with abrasive cleaning agents
- oven sprays
- spot cleaning with mechanical cleaning agents

Do **not** clean PerfectClean accessories in the dishwasher.

# Cleaning and care for the steam oven

---

## Oven compartment

The surface of the oven compartment has been treated with Perfect-Clean.

See “PerfectClean” under “Cleaning and care for the steam oven” for instructions on cleaning.

Ensure that no cleaning agent gets into the openings on the oven compartment rear panel.

To make cleaning the oven compartment easier, you can remove the oven door, dismantle the side racks, and lower the browning/broiling element.

### Cleaning after a program using steam

#### ■ Remove:

- condensate using a sponge or absorbent cloth
- light, greasy soiling with a sponge and a solution of liquid dish soap and hot water

■ After cleaning, wipe the surface with clean water to remove any cleaning agent residues.

■ Then dry the oven compartment and the inside of the door with a cloth.

**Tip:** You can then leave the steam oven to dry automatically (see “Maintenance” under “Cleaning and care for the steam oven”).

## Cleaning after a roasting, broiling, or baking program

Clean the oven compartment thoroughly after roasting, broiling, and baking as otherwise soiling can burn on and become impossible to remove.

- Clean the oven compartment and inside of the door with a clean dish sponge, hot water, and a little liquid dish soap. You can use the hard surface of a dish sponge to clean the oven compartment if necessary.
- After cleaning, wipe the surface with clean water to remove any cleaning agent residues.
- Then dry the oven compartment and the inside of the door with a cloth.

**Tip:** Soaking the soiling for a few minutes with a solution of liquid dish soap and hot water can make cleaning easier. Alternatively, run the Maintenance  | Soak program (see “Maintenance” under “Cleaning and care for the steam oven”).



# Cleaning and care for the steam oven

## Cleaning the floor filter

- The filter in the floor of the oven should be cleaned and dried after every use.
- Vinegar can be used to remove discoloration and limescale deposits from the filter in the floor of the oven. Rinse thoroughly with clean water to remove any residual cleaning agent.

## Cleaning the door seal

Grease deposits on the door seal can cause it to become brittle and cracked.

Clean the door seal between the inside of the oven door and the oven compartment after every baking or roasting program.

- Clean the door seal using a clean, damp microfiber cloth without any cleaning agent. You can also use a clean sponge and warm water with a little liquid dish soap.
- After cleaning, dry the seal with a soft cloth.
- Replace the seal with a new one if it becomes porous or brittle.

Door seals can be ordered from the Miele webshop (see the end of these operating instructions for contact details).

## Cleaning the water container

The water container is suitable for cleaning in a dishwasher.

- Remove the water container after each use. To do this, push it upward slightly as you take it out of the appliance.
- Empty the water container.

Water can drip into the container compartment when the water container is removed.

- Dry the compartment if necessary.
- Rinse the water container by hand or in the dishwasher.
- Dry the water container with a cloth to prevent limescale.

# Cleaning and care for the steam oven

---

## Accessories

### Cleaning the universal tray and wire rack

The surfaces of the universal tray and the wire rack have been treated with PerfectClean.

See “PerfectClean” under “Cleaning and care for the steam oven” for instructions on cleaning.

- Remove:
  - light soiling with a soft clean sponge and a mild solution of warm water and liquid dish soap
  - stubborn soiling with a clean dish sponge, hot water, and a little liquid dish soap. If necessary, you can also use the rough side of the sponge.
- After cleaning, wipe the surface with clean water to remove any cleaning agent residues.
- Then dry the surfaces using a cloth.

## Cleaning cooking containers

The cooking containers are suitable for cleaning in the dishwasher.

- Wash and dry the cooking containers after each use.
- Vinegar can be used to remove bluish discoloration. Rinse thoroughly with clean water to remove any residual cleaning agent.

## Cleaning the probe

Do not put the probe into water or clean it in the dishwasher as this will damage it.

Clean the probe with a damp cloth only.

# Cleaning and care for the steam oven

## Cleaning the side racks

The surfaces of the side racks have been treated with PerfectClean. See "PerfectClean" under "Cleaning and care for the steam oven" for instructions on cleaning.

You can remove the side racks together with the FlexiClip telescopic runners (if present).

If you want to remove the FlexiClip telescopic runners separately beforehand, please follow the instructions in "Installing and removing the FlexiClip telescopic runners" under "Overview".

**⚠** Danger of injury caused by hot surfaces.

The steam oven gets hot during operation. You could burn yourself on the heater elements, oven compartment, or accessories.

Allow the heating elements, oven compartment, and accessories to cool before removing the side racks.

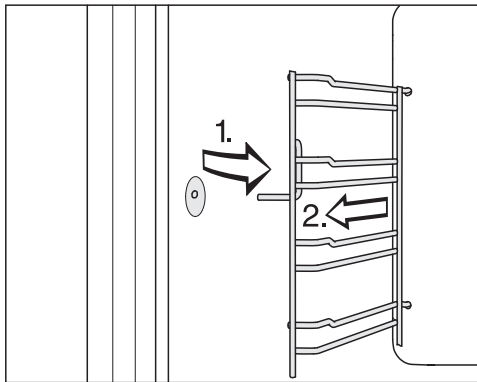

- Pull the side racks out of the holder (1.) and remove them (2.).

- Remove:

- light soiling with a soft clean sponge and a mild solution of warm water and liquid dish soap
- stubborn soiling with a clean dish sponge, hot water, and a little liquid dish soap. If necessary, you can also use the rough side of the sponge.

- After cleaning, wipe the surface with clean water to remove any cleaning agent residues.

- Then dry the side racks with a cloth.

**Reinstall** by following these instructions in reverse order.

- Refit the side racks carefully.

If the side racks are not correctly inserted, there is no anti-tip protection. The temperature sensor could also be damaged when cooking containers are placed in the steam oven.

## Cleaning and care for the steam oven

### Lowering the browning/broiling element

If the ceiling of the oven is badly soiled, the browning/broiling element can be lowered by approx. 2" (5 cm) to make cleaning easier.

**⚠** Danger of injury caused by hot surfaces.

The steam oven gets hot during operation. You could burn yourself on the heater elements, oven compartment, side racks, or accessories.

Allow the heater element, oven compartment, side racks, and the accessories to cool before cleaning.

Take care not to damage the browning/broiling element.

Do not use force when lowering the browning/broiling element.

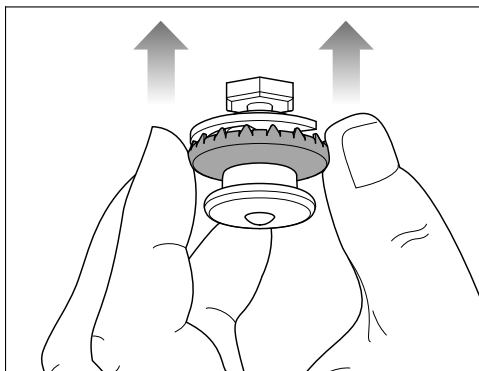

- After cleaning the browning/broiling element, push the pressure cap back up using the outer ring of the pressure cap. Make sure the pressure cap engages correctly.

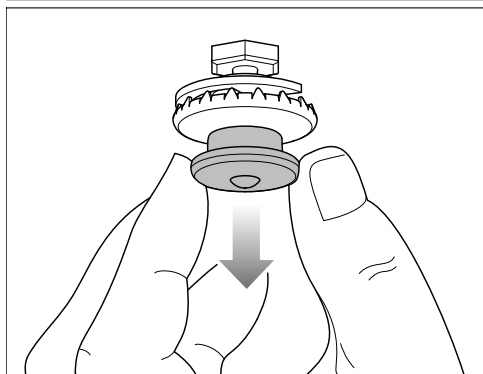

- Carefully pull down the pressure cap. The browning/broiling element then lowers automatically.
- Clean the ceiling of the oven with a damp cloth or a soft sponge (see "Oven compartment" under "Cleaning and care for the steam oven").

## Maintenance

The Ready at and Start at functions are not available in maintenance programs.

### Soak

Stubborn soiling can be soaked using this maintenance program.

- Let the oven compartment cool down.
- Take all accessories out of the oven compartment.
- Remove coarse soiling with a cloth.
- Select Maintenance ⏻ | Soak.

The soaking process takes approx. 10 minutes.

### Drying

This maintenance program can be used to dry any residual moisture in the oven compartment, including in inaccessible areas.

- Dry the oven compartment with a cloth.
- Select Maintenance ⏻ | Drying.

The drying process takes approx. 20 minutes.

### Rinsing

The water-carrying system is rinsed out during this maintenance program. Any remaining food deposits are rinsed away.

- Select Maintenance ⏻ | Rinse.
- Follow the instructions on the display.

The rinsing process takes approx. 10 minutes.

## Descaling the steam oven

We recommend using Miele Descaling Tablets (see “Optional accessories”) to descale the appliance. These have been specially developed for use with Miele appliances to optimize the descaling process. Other descaling agents, which contain other acids besides citric acid and/or other undesirable substances, such as chlorides, could cause damage to the product. Moreover, the descaling result required could not be guaranteed if the descaling solution was not of the appropriate concentration.

Do not spill descaling agent onto metal surfaces. This can cause stains to appear.

However, should any descaling agent get onto these surfaces, wipe it away immediately.

The steam oven has to be descaled after a certain number of operating hours. When the time comes to descale it, the number of uses remaining lights up in the display. Only cooking processes that use steam are counted. The steam oven will be disabled after the last remaining cooking process.

We recommend that you descale the appliance before it locks out.

The water container must be emptied and rinsed during the descaling process.

## Cleaning and care for the steam oven

---

- Turn the steam oven on and select Maintenance  | Descale.

The message *Please wait* will appear in the display. The descaling process is being prepared. This may take a few minutes. As soon as the appliance is ready, you will be prompted to add descaling agent to the water container.

- Fill the water container with lukewarm water up to the level marker  and drop 2 Miele Descaling Tablets in it.
- Wait until the descaling tablets have dissolved.
- Push the water container into the appliance.
- Confirm with *OK*.

The time left appears in the display. The descaling process will now begin.

Do not turn the steam oven off during the descaling process, otherwise the whole process will have to be started from the beginning again.

The water container must be rinsed out once and reinserted empty during the process.

- Follow the instructions in the display.
- Confirm with *OK*.

Once the time left has elapsed, *Ready* and *Steam reduction* will appear in the display. A signal sounds.

- Wait until *Steam reduction* goes out in the display.

The descaling process is complete.

- Select *Close* to return to the main menu.
- Remove the water container and empty it.
- Clean and dry the water container.

- Turn the steam oven off.
- Open the door and let the oven cool down.
- Then dry the oven compartment.
- Leave the appliance door open until the oven compartment is completely dry.

# Cleaning and care for the steam oven

## Removing the door

- Prepare a suitable underlay for the door, such as a soft cloth.
- Open the door slightly.

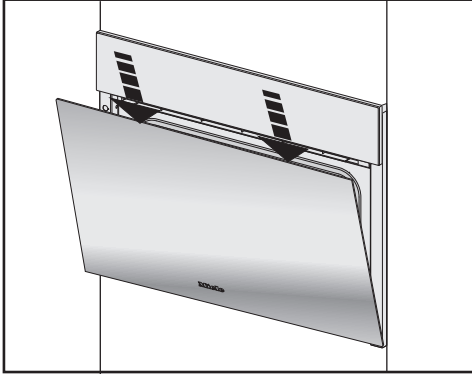

- Using two hands placed on the upper edge of the door, push the door downward briefly.

The oven door is connected to the hinges by retainers. Before removing the door from the retainers, the locking clamps on both hinges have to be released.



- Open the door fully.

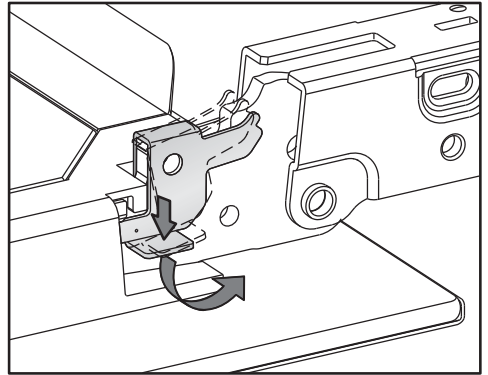

- Release the locking clamps on the hinges by pushing them down as far as they will go until they are at an angle.

The steam oven could become damaged if you remove the door incorrectly.

Never pull the door horizontally off its retainers, as they will spring back against the steam oven.

Do not pull the door off the retainers by the handle, as the handle could break off.

- Raise the door up until it rests partially open.

## Cleaning and care for the steam oven

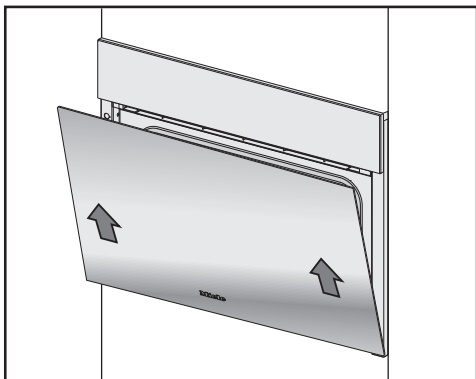

- Hold the door on either side and evenly pull diagonally upward from the hinge retainers. Make sure that the door is straight.
- Lay the door on the previously prepared underlay.

### Installing the door

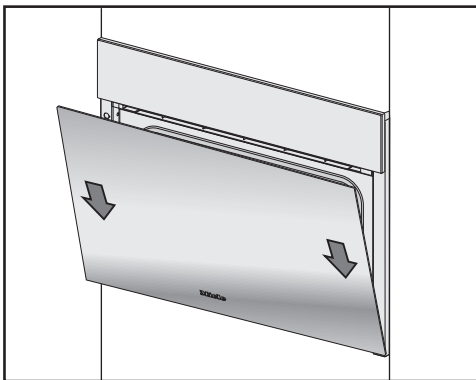

- Hold the door securely on both sides and carefully install it back into the hinge retainers. Make sure that you do not tilt the door.
- Open the door fully.

If the locking clamps are not locked, the door could become loose, resulting in damage.

Ensure that the locking clamps are locked after reinstalling the door.

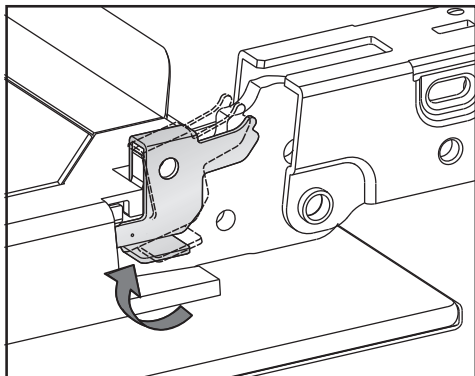

- To relock the locking clamps, turn them back up to the horizontal position as far as they will go on both door hinges.



## Frequently asked questions

Many malfunctions and faults that can occur in daily operation can be easily remedied. You can save time and money in many cases, as you do not need to contact Miele Customer Service.

Information to help you rectify faults yourself can be found at [www.miele.com/service](http://www.miele.com/service).

The following tables are designed to help you to find the cause of a malfunction or a fault and to resolve it.

| Problem  | Possible cause and solution   |
|--|---|
| <b>You cannot turn the appliance on.</b>                                   | The circuit breaker has tripped.<br>■ Reset the circuit breaker (see data plate for the correct fuse rating).   |
|  | There may be a technical fault.<br>■ Disconnect the steam oven from the power supply for approx. 1 minute by: <ul style="list-style-type: none"> <li>– tripping the relevant circuit breaker or screwing the fuse out completely, or</li> <li>– tripping the ground fault circuit interrupter (GFCI) outlet.</li> </ul> ■ If, after turning the circuit breaker or GFCI back on, the steam oven will still not turn on, contact a qualified service technician or Miele Customer Service. |
| <b>The oven does not heat up.</b>  | Demo mode is activated.<br>The steam oven can be operated; however, the heater elements will not work.<br>■ Deactivate demo mode (see “Showroom program” under “Settings”).   |
|  | The oven compartment has been heated by a warming drawer operating beneath it.<br>■ Open the door and let the oven cool down.   |
| <b>The fan can still be heard after the appliance has been turned off.</b> | The fan is still running.<br>The appliance is fitted with a fan which removes steam from the oven. The fan will continue to run for a while after the appliance has been switched off. It will turn itself off automatically after a while.   |

## Frequently asked questions

| Problem   | Possible cause and solution  |
|---|--|
| <p><b>The sensor buttons or the motion sensor do not respond.</b></p>   | <p>You have selected the <b>Display   QuickTouch   Off</b> setting. When this is activated, the sensor buttons and motion sensor do not respond when the steam oven is turned off.</p> <ul style="list-style-type: none"> <li>■ As soon as the steam oven is turned on, the sensor buttons and the motion sensor will respond. If you want the sensor buttons and the motion sensor to respond even when the steam oven is turned off, select the <b>Display   QuickTouch   On</b> setting.</li> </ul> |
|   | <p>The settings for the motion sensor are turned off.</p> <ul style="list-style-type: none"> <li>■ Change the settings for the motion sensor by selecting <b>Settings   MotionReact</b>.</li> </ul>  |
|   | <p>The motion sensor is defective.</p> <ul style="list-style-type: none"> <li>■ Contact Miele Customer Service.</li> </ul>   |
|   | <p>The steam oven is not connected to the power supply.</p> <ul style="list-style-type: none"> <li>■ Check that the steam oven electrical plug is correctly inserted into the socket.</li> <li>■ Check if the breaker has tripped. If it has, contact a qualified service technician or Miele Customer Service.</li> </ul>   |
|   | <p>If the display does not respond, there is a fault with the controls.</p> <ul style="list-style-type: none"> <li>■ Touch and hold the  On/Off sensor button until the display turns off and the steam oven restarts.</li> </ul>   |
| <p><b>A humming sound can be heard during operation and after turning off the steam oven.</b></p>                   | <p>This noise does not indicate incorrect operation or an appliance fault. The noise is made by water being pumped through the system.</p>   |
| <p><b>After moving house, the steam oven no longer switches from the heating-up phase to the cooking phase.</b></p> | <p>The boiling temperature of the water has changed as the altitude of the new location for the appliance differs from the old one by at least 984 ft (300 m).</p> <ul style="list-style-type: none"> <li>■ To adjust the boiling temperature, you need to descale the appliance (see “Maintenance” under “Cleaning and care for the steam oven”).</li> </ul>  |



## Frequently asked questions

| Problem   | Possible cause and solution   |
|---|---|
| <p><b>During operation, an unusually large amount of steam escapes or steam escapes from parts of the steam oven where it does not usually.</b></p> | <p>The door is not properly closed.</p> <ul style="list-style-type: none"> <li>■ Close the door.</li> </ul>   |
|   | <p>The door seal is not correctly fitted.</p> <ul style="list-style-type: none"> <li>■ If necessary, press it in all the way round the door to make sure it is fitted evenly.</li> </ul>  |
|   | <p>The door seal is damaged, e.g. cracked.</p> <ul style="list-style-type: none"> <li>■ Replace the door seal.</li> </ul> <p>This can be ordered from Miele Service (see the end of this booklet for contact details).</p>  |
| <p><b>The oven lighting does not come on.</b></p>   | <p>The bulb needs to be replaced.</p> <ul style="list-style-type: none"> <li>■ Contact Miele Service to have the bulb replaced.</li> </ul>  |
| <p><b>The control panel will not open or close automatically despite tapping the <i>Lift Panel</i> sensor button several times.</b></p>             | <p>Something is obstructing the control panel.</p> <ul style="list-style-type: none"> <li>■ Remove the obstruction.</li> </ul>  |
|   | <p>The obstruction sensor is very sensitive, which means the control panel sometimes does not open or close.</p> <ul style="list-style-type: none"> <li>■ Open/close the control panel manually (see end of this section).</li> <li>■ If the problem occurs again, contact Miele Customer Service.</li> </ul> |
| <p><b>The <i>Start at</i> and <i>Ready at</i> functions are not available.</b></p>  | <p>The temperature in the oven compartment is too high, e.g., after a program has finished.</p> <ul style="list-style-type: none"> <li>■ Open the door and let the oven cool down.</li> </ul>   |
|   | <p>These functions are not generally available in maintenance programs.</p>   |
| <p><b>Cakes, cookies, and pastries are not cooked properly after following the durations given in the recipe.</b></p>                               | <p>The set temperature is not consistent with the one given in the recipe.</p> <ul style="list-style-type: none"> <li>■ Change the temperature.</li> </ul>  |
|   | <p>The recipe has been altered. For example, adding more liquid or eggs can increase the cooking duration required.</p> <ul style="list-style-type: none"> <li>■ Adapt the temperature and/or cooking duration to the altered recipe.</li> </ul>  |
| <p><b>Cakes, cookies, or pastries are unevenly browned.</b></p>   | <p>The temperature was set too high.</p>  |
|   | <p>More than two shelf levels were used for baking.</p> <ul style="list-style-type: none"> <li>■ Bake on a maximum of two levels.</li> </ul>  |

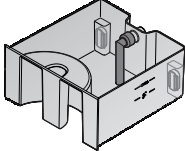
## Frequently asked questions

| Problem    | Possible cause and solution  |
|------------|--|
| F10        | <p>The suction hose in the water container is not inserted correctly or is not vertical.</p> <ul style="list-style-type: none"> <li>■ Correct the position of the suction hose:</li> </ul>    |
| F11<br>F20 | <p>The drain hoses are blocked.</p> <ul style="list-style-type: none"> <li>■ Descale the steam oven (see “Maintenance” under “Cleaning and care for the steam oven”).</li> <li>■ If the fault message appears again, contact Miele Customer Service.</li> </ul>  |
| F44        | <p>There is a technical fault.</p> <ul style="list-style-type: none"> <li>■ Switch the steam oven off and then back on again after a few minutes.</li> <li>■ If the same fault message appears again, contact Miele Service.</li> </ul>  |
| F55        | <p>The maximum length of time for which the combi steam oven can be operated on a function has been exceeded, so the appliance has switched itself off automatically for safety reasons.</p> <ul style="list-style-type: none"> <li>■ Switch the steam oven off and then back on again.</li> </ul> <p>The steam oven is immediately ready for use again.</p> |

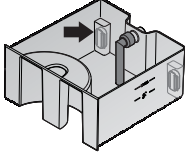
## Frequently asked questions

| Problem                        | Possible cause and solution   |
|--------------------------------|---|
| F94                            | <p>The water inlet hose is trapped or kinked.</p> <ul style="list-style-type: none"> <li>■ Rectify the cause of the problem and start the appliance again.</li> </ul>   |
|                                | <p>The water supply valve has not been opened.</p> <ul style="list-style-type: none"> <li>■ Open the water supply valve and start the appliance again.</li> </ul>   |
|                                | <p>One or both float switches in the water container are stuck.</p> <div style="text-align: center;">  </div> <ul style="list-style-type: none"> <li>■ Release the float switch (or switches) so that it moves freely.</li> <li>■ If the fault message appears again after rectifying the problem(s), contact Miele Service.</li> </ul>  |
| F190                           | <p>There is a fault with the water intake valve. This fault can occur if the control panel is opened or closed during the water inlet.</p> <ul style="list-style-type: none"> <li>■ Confirm with OK and continue operation.</li> <li>■ If the fault message appears again, contact Miele Service.</li> </ul>  |
| F196                           | <p>There is a fault.</p> <ul style="list-style-type: none"> <li>■ Turn the steam oven off and then back on again.</li> </ul>  |
|                                | <p>The drain filter is not inserted correctly.</p> <ul style="list-style-type: none"> <li>■ Turn the steam oven off.</li> </ul> <div style="text-align: center;">  </div> <ul style="list-style-type: none"> <li>■ Insert the filter correctly:</li> <li>■ Turn the steam oven back on again.</li> <li>■ If the same message appears again, contact Miele Customer Service.</li> </ul> |
| <b>F and other fault codes</b> | <p>Technical fault</p> <ul style="list-style-type: none"> <li>■ Turn the appliance off and contact Miele.</li> </ul>  |

## Frequently asked questions

---

### Opening the control panel manually

- Carefully open the door.

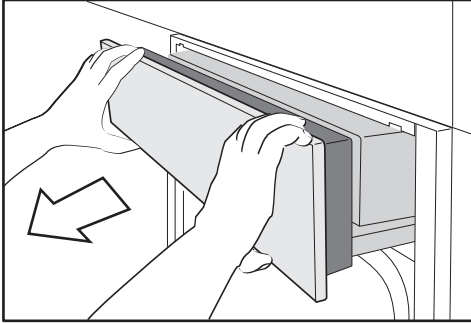

- Take hold of the control panel at the top and bottom.
- Pull the control panel forward and out first.
- Carefully push the control panel upward.

### Closing the control panel manually

- Take hold of the control panel at the top and bottom.
- Carefully push the control panel downward.

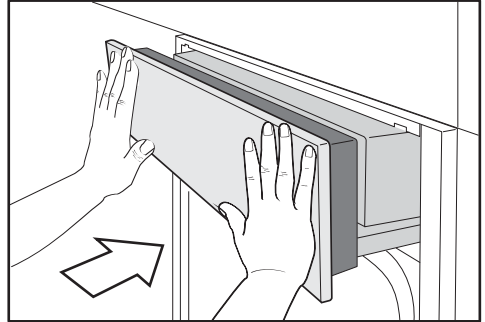

- Push the control panel in.

Miele offers a range of useful accessories, as well as cleaning and conditioning products for your appliance.

These products can be easily ordered from the Miele webshop.

### Containers

Miele offers a wide range of cooking containers. These have all been optimized for Miele appliances in terms of functionality and dimensions. Detailed information on each of our products can be found on the Miele website.

- Perforated cooking containers in various sizes
- Solid cooking containers in various sizes
- Gourmet Casserole Dishes in various sizes
- Lid for Gourmet Casserole Dish

### Other

- Baking trays
- Round baking pan
- FlexiClip telescopic runners HFC 71
- Holding rack for steam oven pans with a width of 12 3/4" (325 mm)

### Cleaning and care products

- DGClean  
Special cleaning agent for removing stubborn soiling from the oven compartment, particularly after roasting
- Descaling tablets (6)

## Customer Service

---

Information to help you rectify faults yourself and about Miele spare parts can be found at [www.miele.com/service](http://www.miele.com/service).

### Contact in the event of a fault

In the event of a fault which you cannot remedy yourself, please contact your Miele dealer or Miele Customer Service.

You can book a Miele Service Call on-line at [www.miele.com/service](http://www.miele.com/service).

Contact information for Miele Customer Service can be found at the end of this document.

Please quote the model identifier and serial number of your appliance (SN) when contacting Miele Customer Service. Both pieces of information can be found on the data plate.

The data plate can be found at the top on the opened control panel.

### Appliance warranty and product registration

You can register your product and/or view the manufacturer's warranty terms and conditions for Miele appliances and vacuum cleaners at [www.mieleusa.com](http://www.mieleusa.com).



### Disposal of the packing material

The cardboard box and packing materials protect the appliance during shipping. They have been designed to be biodegradable and recyclable.

Ensure that any plastic wrappings, bags, etc. are disposed of safely and kept out of the reach of children. Danger of suffocation!

### Disposal of your old appliance

Electrical and electronic appliances contain valuable materials. They also contain certain substances, compounds and components which were essential for the proper functioning and safe use of the equipment. Handling these materials improperly by disposing of them in your household waste can be harmful to your health and the environment. Therefore, please do not dispose of your old appliance with regular household waste and follow local regulations on proper disposal.



Consult with local authorities, dealers or Miele in order to dispose of and recycle electrical and electronic appliances. Miele assumes no responsibility for deleting any personal data left on the appliance being disposed. Please ensure that your old appliance is kept away from children until removal. Observe safety requirements for appliances that may tip over or pose an entrapment hazard.

## Installation

---

### IMPORTANT SAFETY INSTRUCTIONS - INSTALLATION

 Risk of damage caused by incorrect installation.

Incorrect installation can cause damage to the steam oven.

The steam oven must only be installed by a qualified specialist.

- ▶ The connection data (frequency and voltage) on the steam oven's data plate must correspond with those of the electricity supply in order to ensure that no damage can occur to the steam oven. Compare this data before connecting the appliance. If in any doubt, consult a qualified service technician.
- ▶ Power bars and extension cords do not guarantee the required safety of the appliance (risk of fire). Do not use them to connect the steam oven to the power supply.
- ▶ The socket should be easily accessible after the steam oven has been installed.
- ▶ The steam oven must be positioned so that you can see the contents of a cooking container placed on the top shelf level. Otherwise there is a risk of injuries or spillages of hot food.

#### **Note to the installer:**

Please leave these instructions with the consumer of the appliance for the local building inspectors use.

## Installation dimensions DGC 7865

### Installation in a tall cabinet

Observe the required minimum installation height of 36" (914 mm).

Miele Steam Ovens can be installed flush or proud. Discuss your requirements with your architect, kitchen designer, and installer.

More installation drawings are available on the Miele website.

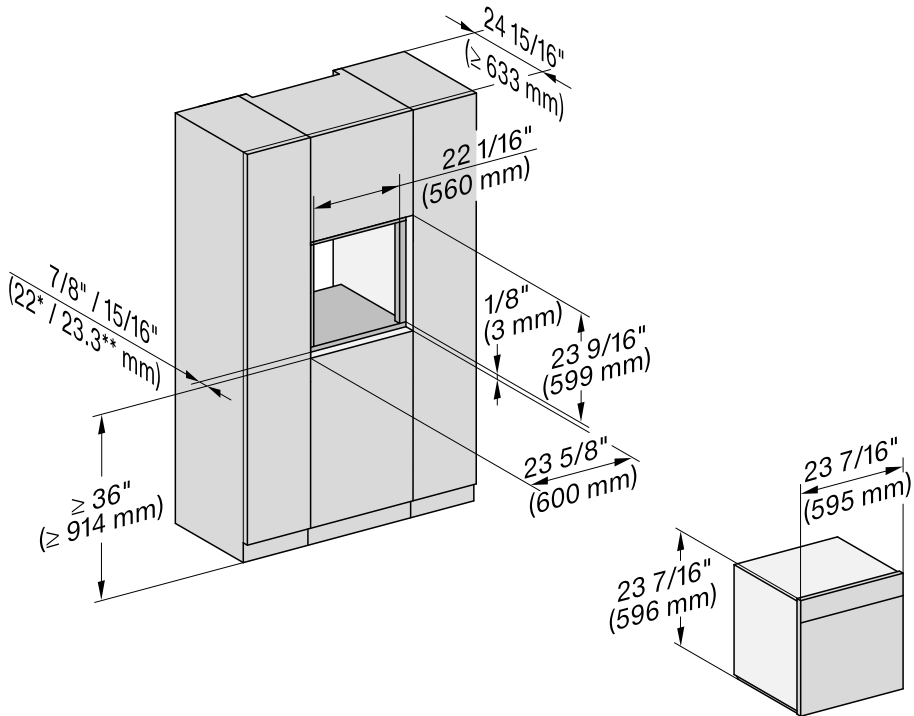

\* Steam ovens with glass front

\*\* Steam ovens with metal front

# Installation

## Side view

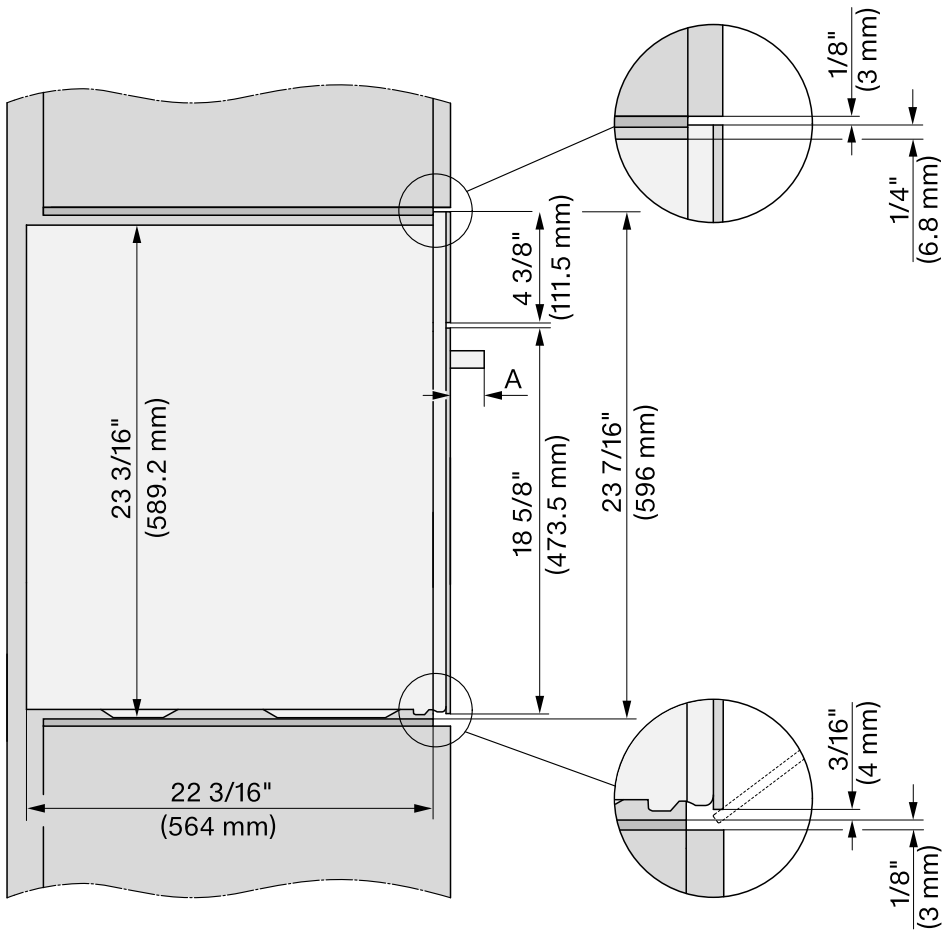

A DGC 78xx:  $1 \frac{7}{8}''$  (47 mm)

**Swivel range for control panel**

The area in front of the control panel must not be blocked by anything (such as a door handle) that would hinder it from opening and closing.

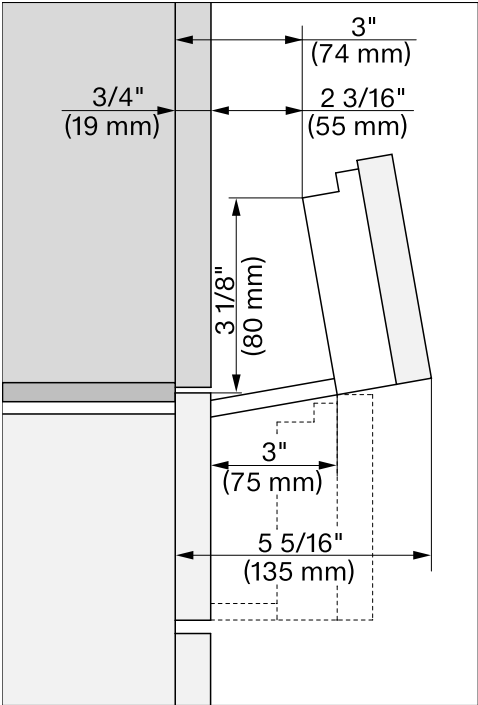

# Installation

## Connections and ventilation

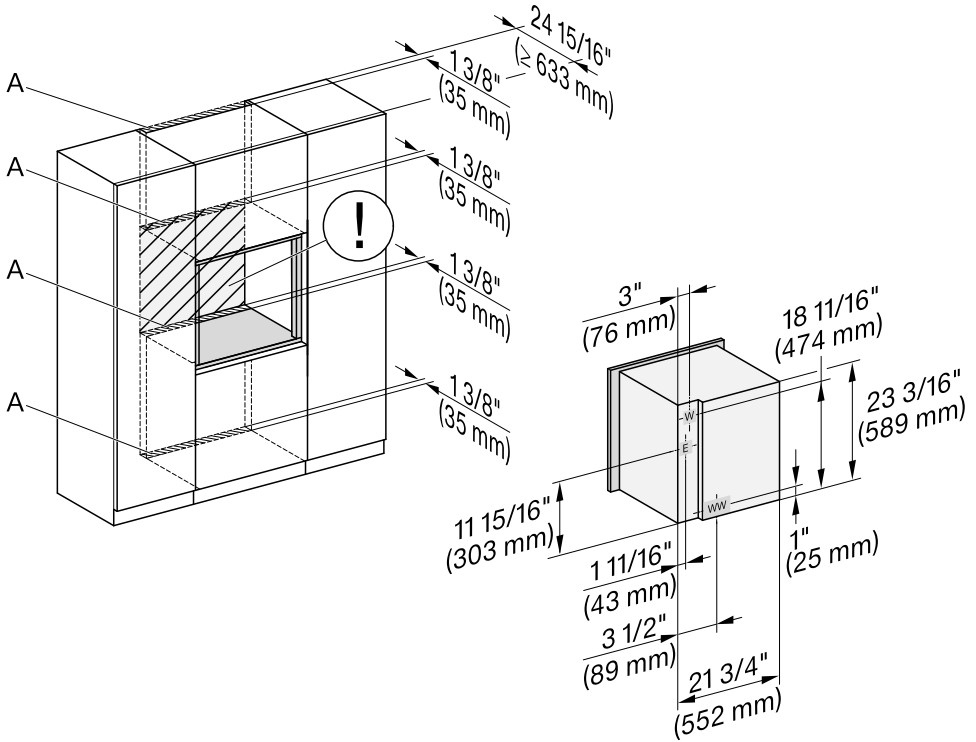

**A** Cutout (min. 28 sq in/18,000 mm<sup>2</sup>) for power cord, water hoses, and ventilation

Ⓢ No electrical or water connections in this area. The socket for the electrical connection and the shut off valve for the water inlet must be accessible, e.g., in an adjacent kitchen cabinet.

**E** Electrical connection

**W** Plumbed water connection  
Stainless-steel hose, L = 9' 10 1/8" (3,000 mm)

**WW** Waste water connection  
Plastic hose, L = 9' 10 1/8" (3,000 mm)

The top end of the drain hose to the inlet of the odor trap must not be higher than 19 11/16" (500 mm).

## Installation dimensions DGC 7785, DGC 7885

### Installation in a tall cabinet

Observe the required minimum installation height of 36" (914 mm).

Miele Steam Ovens can be installed flush or proud. Discuss your requirements with your architect, kitchen designer, and installer.

More installation drawings are available on the Miele website.

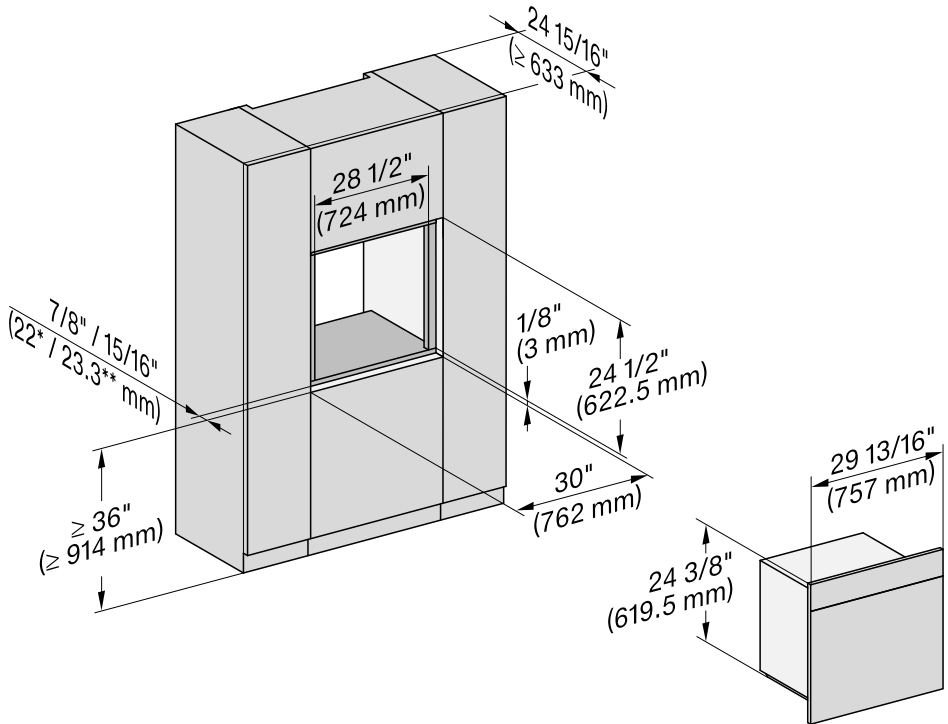

\* Steam ovens with glass front

\*\* Steam ovens with metal front

# Installation

## Side view

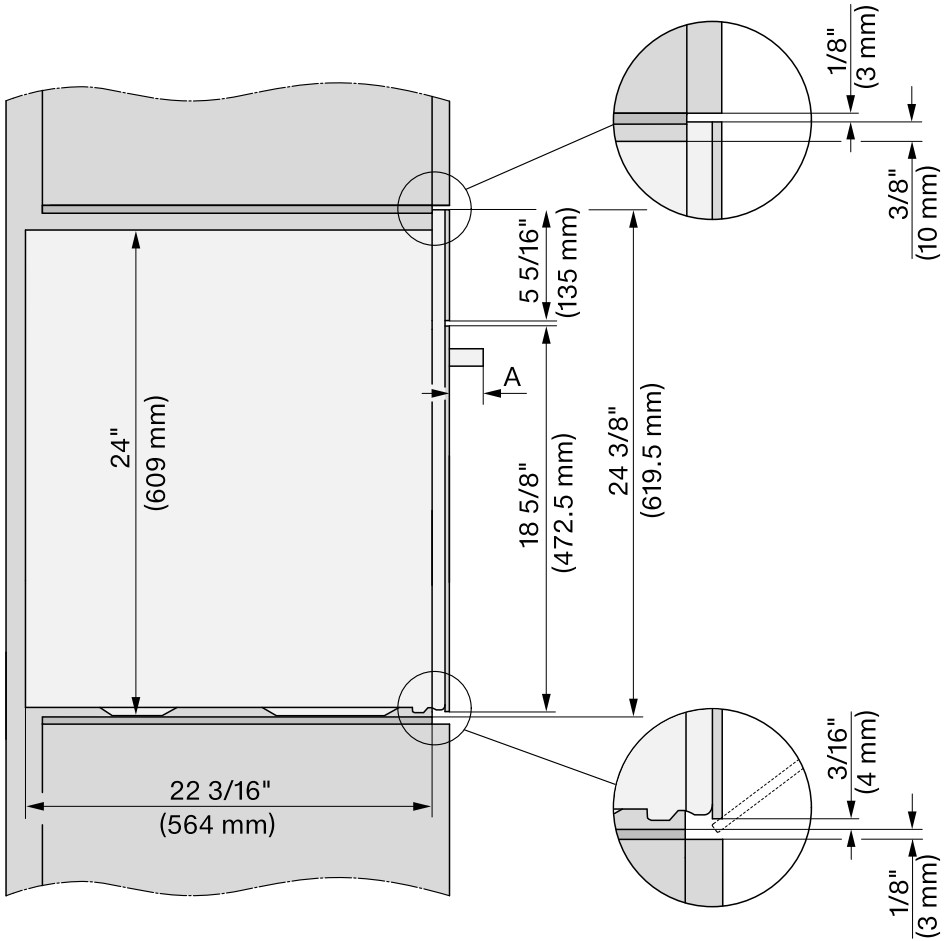

- A** DGC 77xx: 2 1/2" (64 mm)  
DGC 78xx: 1 7/8" (47 mm)



**Swivel range for control panel**

The area in front of the control panel must not be blocked by anything (such as a door handle) that would hinder it from opening and closing.

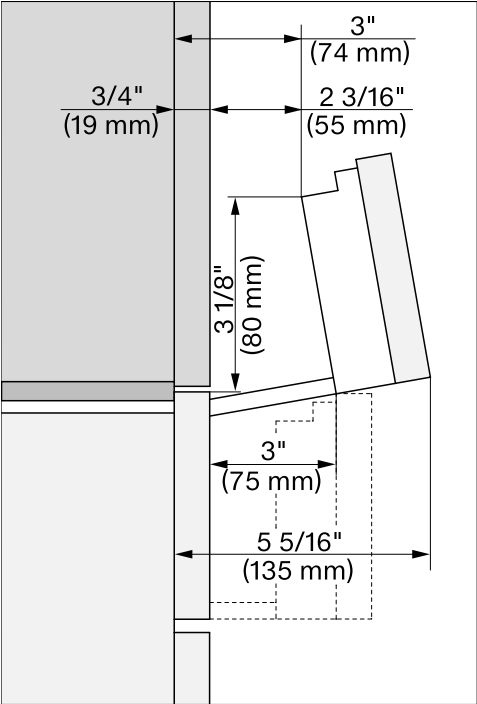

# Installation

## Connections and ventilation

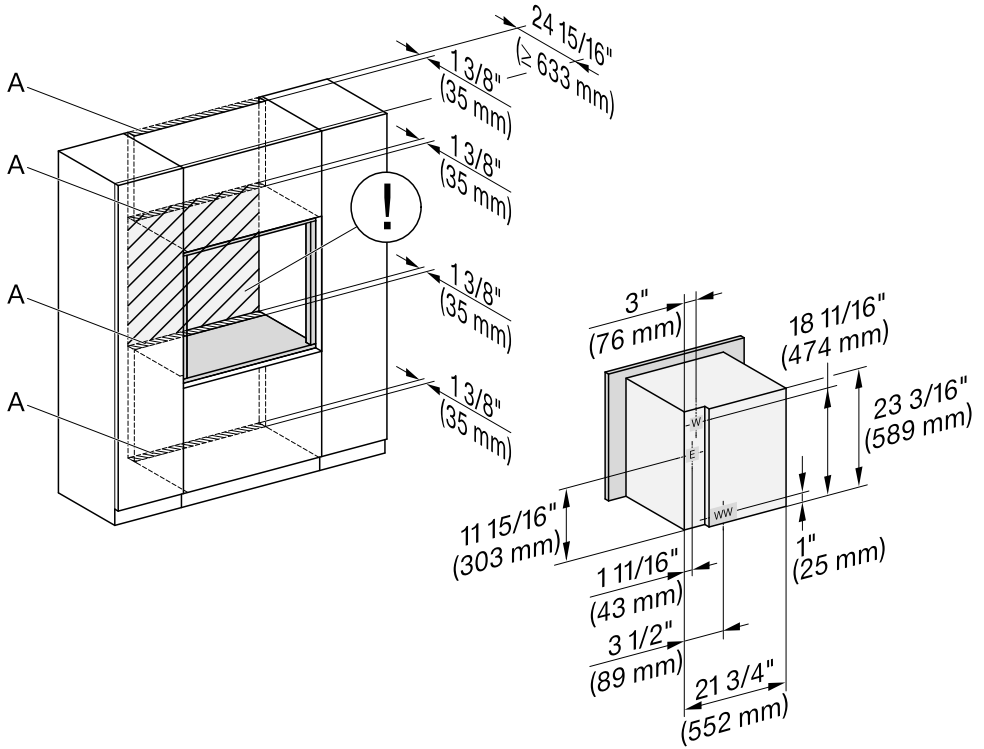

- A** Cutout (min. 28 sq in/18,000 mm<sup>2</sup>) for power cord, water hoses, and ventilation
- Ⓛ No electrical or water connections in this area. The socket for the electrical connection and the shut off valve for the water inlet must be accessible, e.g., in an adjacent kitchen cabinet.
- E** Electrical connection
- W** Plumbed water connection  
Stainless-steel hose, L = 9' 10 1/8" (3,000 mm)
- WW** Waste water connection  
Plastic hose, L = 9' 10 1/8" (3,000 mm)

The top end of the drain hose to the inlet of the odor trap must not be higher than 19 11/16" (500 mm).

## Installing and removing the steam oven

For safety reasons, the steam oven may only be used when it has been fully installed.

Do not open the door when the steam oven is on the floor. This could damage the door.

Do not open the door until the steam oven has been installed inside the housing unit.

Maintain the required minimum installation height of 36" (914 mm).

It is vital to observe the connection data in "Plumbed water connection", "Drainage", and "Electrical connection" under "Installation".

## Securing the steam oven in the housing unit

- Attach the water hoses to the steam oven (see "Attaching the stainless-steel hose to the steam oven" and "Attaching the plastic hose to the steam oven" under "Installation").
- Draw the water hoses through the cutout in the base of the housing unit.

Risk of damage from incorrect transportation.

Lifting the steam oven by the door handle could cause damage to the door.

Use the recessed grips on each side of the housing to carry the appliance.

The steam generator may malfunction if the steam oven is not on a level surface.

The maximum deviation from the horizontal that can be tolerated is 2°.

- Push the steam oven into the housing unit and align it in the center of the housing unit. When doing so, make sure that the power cord and water hoses do not get trapped or damaged.
- Open the door.

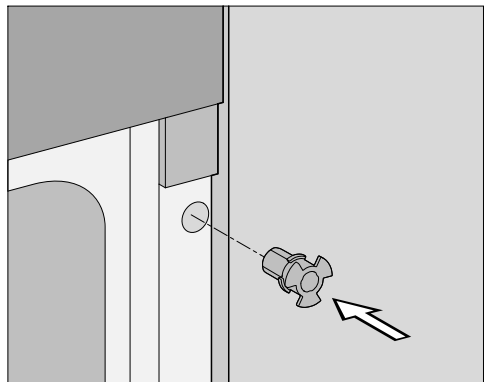
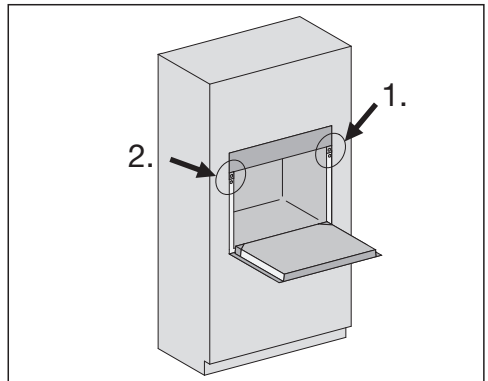

- Insert the mounting aid into the hole in the front frame.

## Installation

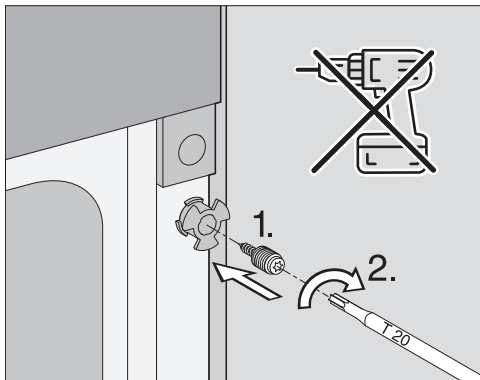

- Insert the bolt into the mounting aid and tighten it in the housing unit. **Do not** use a cordless screwdriver.

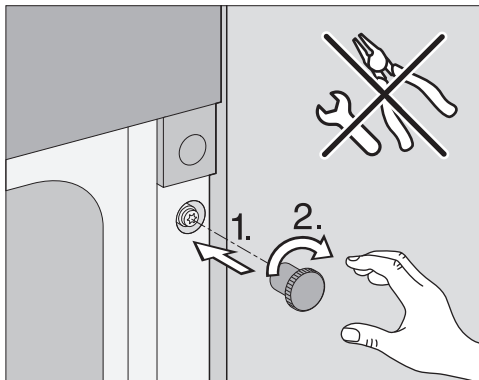

- Screw the knurled nut onto the bolt by hand to fix the steam oven in the housing unit.

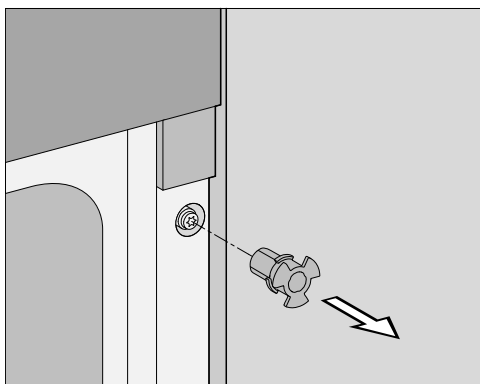

- Remove the mounting aid.

The door may be damaged if the knurled nuts protrude from the front frame. Make sure that the knurled nuts are flush with the front frame after installation.

- Repeat this process for the other side.
- Connect the steam oven to the water supply (see “Plumbed water connection” and “Drainage” under “Installation”).
- Connect the appliance to the power supply.
- Check all functions of the steam oven are working correctly in accordance with the operating instructions.

## Taking the steam oven out of the housing unit

- Turn off the water supply.
- Open the door.
- Unscrew the knurled nuts and bolts from the front frame (see “Securing the steam oven in the housing unit”). Keep these parts in case the oven needs to be installed again in the future.
- Pull the steam oven out of the housing unit.

Risk of damage from incorrect transportation.

Lifting the steam oven by the door handle could cause damage to the door.

Use the recessed grips on each side of the housing to carry the appliance.

- Take the steam oven out of the housing unit.
- Disconnect the steam oven from the power supply and the water supply.

# Installation

## Plumbed water connection

 Risk of injury and appliance damage if appliance is not connected properly.

Failing to connect the appliance properly can result in personal injury and/or material damage.

The appliance may only be connected to the plumbed water connection by qualified specialists.

 Risk to health and risk of damage due to contaminated water.

The quality of the incoming water must conform to the requirements for drinking water in the country where the steam oven is being used.

Connect the steam oven to the water supply.

Connection to the water supply must comply with the applicable regulations in the country where the appliance is being installed. All units and systems used to supply water to the steam oven must also comply with the applicable regulations in the respective country.

Connect the steam oven directly to the plumbed water supply.

Do not connect the steam oven to a water supply in which the water might stagnate. Otherwise, the flavor of the food could be impaired.

The steam oven meets the requirements of IEC 61770 and EN 61770.

The steam oven may only be connected to a cold water supply.

If a domestic water softener is connected, please make sure that the conductivity level of the water is maintained.

 Water damage due to contamination.

Impurities in the water supply may accumulate in the valve of the steam oven. The valve can no longer close and water is streaming out.

Flush the water lines before connecting the steam oven or when working on the water supply line.

A non-return valve is not required because the steam oven complies with applicable DIN standards.

The water connection pressure needs to be between 14.5 psi (1 bar) and 87 psi (6 bar). If the pressure is higher than 87 psi, a pressure-reducing valve must be installed.

The stainless-steel hose supplied is 9' 10 1/8" (3.0 m) long.

An intake valve must be provided between the stainless-steel hose and the domestic water supply to ensure that the water supply can be cut off if necessary. Make sure the intake valve remains easily accessible once the steam oven has been installed.

Only use the stainless-steel hose supplied.

The stainless-steel hose must not be shortened, extended, or replaced by a different hose.

The stainless-steel hose must only be replaced by an original Miele part. The food-grade, stainless-steel hose is available to order from the Miele webshop, from Miele Customer Service, or from your local Miele dealer.

## Attaching the stainless-steel hose to the steam oven

Make sure that the stainless-steel hose is not kinked or damaged.

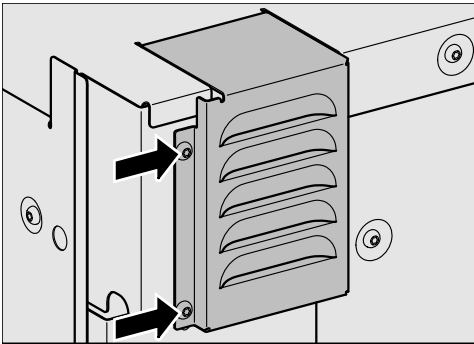

- Remove the cover plate over the plumbed water connection at the back of the steam oven.
- Remove the cover cap from the plumbed water connection.
- Take the **angled** end of the stainless-steel hose and check whether there is a sealing ring. If there is no sealing ring, attach one.
- Screw the stainless-steel hose coupling nut onto the thread of the plumbed water connection.
- Ensure that it is screwed into position correctly and watertight.
- Replace the cover plate over the plumbed water connection.

## Connecting the water supply

⚠ Disconnect the appliance from the power supply before connecting it to the water line.

Turn off the water supply before connecting the appliance to the water line.

Make sure that the faucet remains accessible after the appliance has been installed.

A faucet with 3/8" thread must be incorporated when connecting the appliance to the water supply.

- Connect the stainless steel hose to the faucet.

Old or previously used hoses should never be connected to the appliance. Only use the stainless steel hose supplied.

- Ensure that it is screwed into position correctly.
- Turn on the water supply faucet slowly and check for leaks at the plumbed water connection. Correct the position of the seal and screw thread if appropriate.

# Installation

---

## Drainage

The drainage trap must not be located higher than the drain-hose connection point on the steam oven. This is to ensure that water can drain out completely.

The top end of the plastic hose must not be higher than 19 11/16" (500 mm) where it connects to the trap.

The plastic hose supplied is 9' 10 1/8" (3.0 m) long.

We recommend only using the original hose from Miele.  
The plastic hose supplied must not be shortened.

The drain hose can be connected to:

- a surface-mounted or flush-mounted trap with a fixed hose connection, or
- the connection point on a sink drainage trap

The temperature of the drainage water is 150°F (70°C).

## Attaching the plastic hose to the steam oven

Make sure that the plastic hose is not kinked or damaged.

- Plug the plastic hose onto the waste water connection on the steam oven.
- Then secure the plastic hose with the hose clip.

## Connecting the water drainage system

- Connect the plastic hose to the trap using the hose sleeve.
- Then secure the plastic hose with the hose clip.



## Electrical connection

 Risk of injury due to electric shock.

During installation, maintenance, and repair work, the steam oven must be disconnected from the electricity supply:

To disconnect the steam oven, fully unscrew the breakers, trip the ground fault circuit interrupter, or unplug the power cord from the socket. To do this, pull the plug, not the power cord.

 Risk of injury.

Installation, repairs, and other work by unqualified persons could be dangerous. Miele cannot be held liable for unauthorized work.

Installation, maintenance, and repairs must only be carried out by a technician authorized by Miele.

The connection data (frequency and voltage) on the steam oven's data plate must correspond with those of the electricity supply in order to ensure that no damage can occur to the steam oven.

Compare this data before connecting the appliance. If in any doubt, consult a qualified service technician.

For safety reasons, the steam oven may only be used after it has been built in.

- Important – Save these instructions for the local electrical inspector's use.

## Connection

- Make sure that the connection data on the data plate (voltage, frequency, and fuse rating) matches that of your electricity supply.

The data plate is located on the top of the housing.

## Connection data

The steam oven is equipped with a 78 3/4" (2.0 m) power cord with plug for connection to an electricity supply with: 208/240 V/20 A/60 Hz

Ensure that the socket is easily accessible after the steam oven has been installed.

Temporary or permanent operation on an autonomous power supply system or a power supply system that is not synchronized with the grid power supply (e.g., island networks, back-up systems) is possible. A prerequisite for operation is that the power supply system complies with national and local codes.

The function and operation of the protective measures provided in the domestic electrical installation and in this Miele product must also be maintained in isolated operation or in operation that is not synchronized with the grid power supply, or these measures must be replaced by equivalent measures in the installation.

## Replacing the power supply cord

 Risk of electric shock from voltage.

Incorrect connection to the power supply may result in an electric shock.

The power supply cord must only be replaced by a qualified electrician.

When replacing the power supply cord, only use a type H 05 VV-F (PVC insulated) cord with a suitable cross section, available from Miele.

# Declaration of conformity

---

## Radio Module

This device contains the following WiFi module:

|                            |                          |
|----------------------------|--------------------------|
| FCC ID                     | 2AC7Z-EK057              |
| IC ID                      | 21098-EK057              |
| Frequency band             | 2.412 GHz –<br>2.462 GHz |
| Maximum transmitting power | < 0.2 W                  |

## Compliance Statement

This device complies with Part 15 of the FCC Rules and contains licence-exempt transmitter(s)/receiver(s) that comply with Innovation, Science and Economic Development Canada's licence-exempt RSS Standard(s).

Operation is subject to the following two conditions:

- (1) this device may not cause harmful interference, and
- (2) this device must accept any interference received, including interference that may cause undesired operation.

The construction of the device assures that the FCC/IC exposure limits are verifiably met using the integrated radio module.

### Warning!

Any changes or modifications to this unit not expressly approved by the party responsible for compliance could void the user's authority to operate the equipment.

Miele uses their own and third party software which is not subject to any so-called open source license for the operation and control of the device/appliance. This software/these software components are protected by copyright. The copyright powers of Miele and third parties have to be respected.

Furthermore, this device/appliance contains software components which are distributed under open source license conditions. Please refer to [Settings | Legal information | Open source licenses](#) in the device/appliance for the open source components contained therein, together with the corresponding copyright notices, copies of the licensing conditions valid at the time, and any further information. The liability and warranty provisions of the open source licensing conditions as stated therein apply only in relation to the respective rights holders.

In particular, the device/appliance contains software components licensed by the copyright holders under the GNU General Public License, Version 2, or the GNU Lesser General Public License, Version 2.1. For a period of at least 3 years from the date of purchase or delivery of the device/appliance respectively, Miele offers to provide you or third parties with a machine-readable copy of the source code of the Open Source components contained in the device/appliance and licensed under the terms of the GNU General Public License, Version 2, or the GNU Lesser General Public License, Version 2.1, on a data carrier (CD-ROM, DVD or USB stick). Please contact us via e-mail ([info@miele.com](mailto:info@miele.com)) or the below postal address and state the product name, the serial number and the date of purchase to obtain this source code.

Miele & Cie. KG  
Open Source  
GTZ/TIM  
Carl-Miele-Straße 29  
33332 Gütersloh

Please note the limited warranty in favor of the rights holders under the terms of the GNU General Public License, Version 2, and the GNU Lesser General Public License, Version 2.1:

*This program is distributed in the hope that it will be useful, but WITHOUT ANY WARRANTY, without even the implied warranty of MERCHANTABILITY of FITNESS FOR A PARTICULAR PURPOSE. See the GNU General Public License and GNU Lesser General Public License for more details.*

## Copyrights and licenses for the communication module

---

For the purpose of operating and controlling the communication module, Miele uses proprietary or third-party software that is not covered by open source licensing terms. This software/ these software components are protected by copyright. The copyrights held by Miele and third parties must be respected.

This communication module contains software components which are distributed under open source license conditions. The open source components contained in the appliance along with the corresponding copyright notices, copies of the licensing terms valid at the time, and any additional information can be accessed locally via *http://<IP address>/Licenses*. The liability and warranty arrangements for the open source licenses displayed in this location only apply in relation to the respective rights holders.





Please have the model and serial number of your appliance available when contacting Customer Service.

---

## **U.S.A.**

**Miele, Inc.**

### **National Headquarters**

9 Independence Way  
Princeton, NJ 08540  
[www.mieleusa.com](http://www.mieleusa.com)

### **Customer Support**

Phone: 888-99-MIELE (64353)  
[info@mieleusa.com](mailto:info@mieleusa.com)

### **International Headquarters**

Miele & Cie. KG  
Carl-Miele-Straße 29  
33332 Gütersloh  
Germany

## **Canada**

**Importer  
Miele Limited**

### **Headquarters and Miele Centre**

161 Four Valley Drive  
Vaughan, ON L4K 4V8  
[www.miele.ca](http://www.miele.ca)

### **Customer Care Centre**

Phone: 1-800-565-6435  
905-532-2272  
[customercare@miele.ca](mailto:customercare@miele.ca)

DGC 7865, DGC 7785, DGC 7885

en-US, CA

M.-Nr. 11 924 030 / 03