

Operating Instructions Microwave oven



To avoid the risk of accidents or damage to the appliance, it is **essential** to read these instructions before it is installed and used for the first time.

Contents

Warning and Safety instructions	4
Before using for the first time	12
Installation and connection	13
Electrical connection	13
Caring for the environment	15
Guide to the appliance	16
Accessories supplied	17
Control panel	18
Description of the functions	19
Modes of operation	20
Functions	20
Microwave Solo mode	20
Grilling	20
Combination mode (Microwave + Grill).....	20
Automatic programmes	20
Suitable containers for microwave use	21
Material and shape.....	21
Testing containers	23
A microwave lid or cover	24
Before using for the first time	25
Setting the time of day	25
Altering the time of day	25
Switching off the time of day display	25
Night time switch-off.....	25
Operation	26
Opening the door	26
Placing a dish in the oven.....	26
Turntable	26
Closing the door	26
Starting a programme.....	26
“door” message	27
Interrupting or restarting a programme.....	27
Altering the settings	27
Cancelling a programme.....	28
At the end of a programme	28
Automatic keeping warm function	28
Quick start (programmable)	28
System lock.....	29
Using the minute minder.....	29
Altering a minute minder entry	29
Minute minder + cooking process.....	29
Operation - Grilling	30

Gourmet plate	32
Instructions for use	32
Searing/browning food	32
Examples of use.....	33
Recipes	33
Operation - Automatic programmes	36
Automatic defrosting	36
Automatic cooking	36
Recipes - Automatic programmes	38
Saving your favourite programme (Memory)	43
Changing settings	44
Reheating	46
Cooking	48
Defrosting	50
Bottling	51
Examples of use	52
Cleaning and care	53
Accessories supplied.....	55
Problem solving guide	56
Service	58
Contact in case of fault.....	58
Warranty	58

Warning and Safety instructions

This appliance complies with current safety regulations. However, inappropriate use can lead to personal injury and damage to property.

Read the Operating instructions carefully before using the appliance. They contain important information on the installation, safety, use and maintenance of the appliance. This prevents both personal injury and damage to the appliance.

In accordance with standard IEC 60335-1, Miele expressly and strongly advises that you read and follow the instructions in “Installation”, as well as in the “Warning and Safety instructions”.

Miele cannot be held liable for injury or damage caused by non-compliance with these instructions.

Keep these instructions in a safe place and pass them on to any future owner.

Correct application

- ▶ The microwave oven is intended for use in private households. This appliance is not intended for outdoor use.
- ▶ Do not use the appliance at altitudes above 2000 m.
- ▶ The microwave oven is intended for domestic use only to cook, defrost, and reheat food. Any other use is not permitted.
- ▶ If flammable items were dried in the microwave oven, the moisture in the items would evaporate. This could cause them to dry out and possibly self-ignite. Never use the microwave oven to store or dry items which could ignite easily.
- ▶ This microwave oven is not intended for use by people (including children) with reduced physical, sensory or mental capabilities or lack of experience and knowledge, unless they have been given supervision and instruction concerning its use by a person responsible for their safety. They may only use the appliance unsupervised if they have been shown how to use it in a safe way. They must be able to recognise the dangers of misuse.
- ▶ This appliance is equipped with a special lamp to cope with particular conditions (e.g. temperature, moisture, chemical resistance, abrasion resistance and vibration). This special lamp must only be used for the purpose for which it is intended. It is not suitable for room lighting. Replacement lamps may only be fitted by a Miele authorised technician or by Miele.
- ▶ This microwave oven contains 1 light source of energy efficiency class E.

Safety with children

- ▶ Activate the system lock to ensure that children cannot switch on the microwave oven inadvertently.
- ▶ Young children must not be allowed to use the appliance.
- ▶ Older children may use the appliance without supervision if its operation has been clearly explained to them and they are able to use it safely. Children must be able to recognise and understand the potential risks of improper use.
- ▶ Children must not be allowed to clean or maintain the appliance unsupervised.
- ▶ Please supervise children in the vicinity of the microwave oven and do not let them play with it.
- ▶ Danger of suffocation! Whilst playing, children may become entangled in packaging material (such as plastic wrapping) or pull it over their head with the risk of suffocation. Keep packaging material away from children.
- ▶ Danger of burning! Children's skin is far more sensitive to high temperatures than that of adults. When grilling with or without the microwave function, the oven interior, the grill element and the door will get hot. Do not let children touch the microwave oven when it is in operation.

Technical safety

- ▶ A damaged appliance could be dangerous. Check the appliance for visible signs of damage. Do not use the appliance if it is damaged.
- ▶ If the electrical connection cable is damaged it must only be replaced by a Miele authorised service technician in order to prevent a hazard.
- ▶ Temporary or permanent operation with a self-sufficient or non-mains synchronous energy supply system (e.g. isolated networks, back-up systems) is possible. A requirement for the operation is that the energy supply system complies with all current local and national requirements that apply to stand-alone, solar and/or battery systems. The protective measures provided in the installation and in this Miele product must also be assured in their function and operation in isolated operation or in non-mains synchronous operation, or replaced with equivalent measures in the installation.

Warning and Safety instructions

- ▶ Operating a damaged appliance can result in microwave leakage and present a hazard to the user. Do not use the appliance if
 - the appliance door is warped.
 - the door hinges are loose.
 - holes or cracks are visible in the casing, the door or the oven interior walls.
- ▶ Any contact with live connections or tampering with the electrical or mechanical components of the microwave oven will endanger your safety and may lead to appliance malfunctions. Do not open the appliance housing under any circumstances.
- ▶ Before connecting the appliance to the power supply, ensure that the connection data on the data plate (voltage and frequency) match the mains electricity supply. This data must correspond in order to avoid the risk of damage to the appliance. If in doubt, consult a qualified electrician.
- ▶ Do not use multi-socket adapters and extension leads to connect the microwave oven to the electricity supply. They are a fire hazard and do not guarantee the required safety of the appliance.
- ▶ The electrical safety of this microwave oven can only be guaranteed when continuity is complete between it and an effective earthing system. It is essential that this standard safety requirement is met to avoid the risk of damage or electric shock due to a missing or disconnected protective conductor. If in any doubt, please have the electrical installation tested by a qualified electrician.
- ▶ Do not situate the appliance too close to an adjacent furniture unit. To ensure adequate ventilation, a minimum gap of 5 cm is required between the appliance and any neighbouring furniture or walls. There must be a minimum gap of 19.5 cm between the top of the appliance and anything above it.
- ▶ Unauthorised installation, maintenance and repairs (including removal of any cover) can cause considerable danger for the user. Installation must be performed by a suitably qualified and competent person. Maintenance and repairs must only be carried out by a Miele authorised technician.
- ▶ Any repairs not performed by a Miele authorised technician will void the warranty.
- ▶ During repairs or cleaning and maintenance, the microwave oven must be disconnected from the mains power supply. It is only completely isolated from the electricity supply when:
 - the plug has been disconnected from the back of the appliance or the appliance has been switched off at the wall socket and the plug withdrawn. Do not pull the mains connection cable but the mains plug to disconnect your appliance from the mains electricity supply.
 - the mains circuit breaker is switched off.
 - the screw-out fuse is removed (in countries where this is applicable).

Warning and Safety instructions

- ▶ The manufacturer can only guarantee the safety of the appliance when Miele replacement parts are used. Faulty components must only be replaced by genuine Miele spare parts.
- ▶ If the appliance is installed behind a kitchen furniture door, it may only be used with the furniture door open. Do not close the furniture door while the appliance is in use. Heat and moisture can build up behind the closed furniture door. This can result in damage to the appliance and furniture unit. Leave the furniture door open until the appliance has cooled down completely.
- ▶ If your microwave oven is built in with a lift-up door: do not bring the door down into the closed position when the oven is in operation.
- ▶ The appliance must not be used in a non-stationary location (e.g. on a ship).

Correct use

 Danger of burning on the grill.

When grilling with or without the microwave function, the microwave oven will get hot. You could burn yourself on the oven interior walls, the grill element, food, accessories or the oven door.

Wear oven gloves when placing food in the oven or removing it, and when adjusting oven shelves etc. in a hot oven.

- ▶ Always ensure that food is sufficiently cooked or reheated. The time required for this depends on a number of factors, such as the nature of the food, its initial temperature, the amount to be cooked and recipe variations. Some foods may contain micro-organisms which are only destroyed by thorough cooking at sufficiently high temperatures (over 70 °C) for long enough (a minimum of 10 minutes). Therefore when cooking or reheating foods, e.g. poultry, it is particularly important that food is fully cooked through. If in any doubt that a sufficiently high temperature has been reached, continue reheating for a little longer.
- ▶ It is important that the temperature in the food being cooked is evenly distributed and sufficiently high. This can be achieved by stirring or turning the food, and observing a sufficiently long standing time (see charts) which should be added to the time needed for reheating, defrosting or cooking. During the standing time the temperature is distributed evenly in the food.

Warning and Safety instructions

- ▶ Always remember that times for cooking, reheating and defrosting in a microwave oven are usually considerably shorter than with traditional methods of cooking food. Excessively long cooking durations can lead to food drying out and burning, or could even cause it to catch fire. Fire hazard! There is also a danger of fire if breadcrumbs, flowers, herbs etc. are dried in the microwave oven. Do not dry these items in the microwave oven.
- ▶ Cushions or pads filled with cherry kernels, wheat grain, lavender, or gel, such as those used in aromatherapy can ignite when heated, even after they have been removed from the microwave oven. Do not heat these up in the microwave oven. Fire hazard!
- ▶ The microwave oven is not suitable for cleaning or disinfecting items. Items can get extremely hot and there is a danger of burning when the item is removed from the appliance. Fire hazard!
- ▶ The appliance can be damaged if it is used without food being placed in it or if it is incorrectly loaded. Therefore do not use the appliance to preheat crockery or to dry herbs or similar items.
- ▶ Always ensure that food, a gourmet plate or a browning dish has been placed in the microwave, and that the turntable is in place, before switching on.
- ▶ Pressure can build up when reheating food or drinks in sealed containers, jars or bottles, which can cause them to explode. Never cook or reheat food or liquids in sealed containers, jars or bottles. With baby bottles, the screw top **and** teat must be taken off.
- ▶ Be careful when removing dishes from the appliance. Although heat is not normally produced in the container itself by the microwaves (apart from stoneware), heat transfer from the food to the container may be considerable, making the container itself hot. The dish is only warmed by the heat of the food. Before serving, always check the temperature of the food itself after taking it out of the microwave. The temperature of the container is not an indication of the temperature of the food or liquid in it. **This is particularly important when heating food for babies, children, and the elderly or infirm.** After reheating food, especially food for babies and small children, stir the food or shake the container and check that the temperature does not pose any danger of burning. Double check after it has been left to stand.

Warning and Safety instructions

- ▶ When heating liquids, milk, sauces etc. using microwave power, the boiling point of the liquid may be reached without the production of the typical bubbles. Liquids do not boil evenly throughout. This so-called 'boiling delay' can cause a sudden build-up of bubbles when the container is removed from the oven or shaken, which can lead to the liquid boiling over suddenly and explosively. Danger of burning and scalding! The formation of bubbles can be so strong that the pressure forces the oven door open. Danger of injury and damage to the appliance! Stir liquids well before heating. After heating, wait at least 20 seconds before removing the container from the oven. In addition, during heating a glass rod or similar item, if available, can be placed in the container.
- ▶ To avoid fuelling any flames, do not open the oven door if smoke occurs in the oven interior. Interrupt the process by switching the appliance off and disconnect it from the electricity supply. Do not open the door until the smoke has dispersed.
- ▶ Oils and fats can ignite if allowed to overheat. Never leave the microwave oven unattended when cooking with oil or fats. Do not use the appliance for deep frying. Never attempt to put out oil or fat fires with water. Switch the microwave oven off and extinguish the flames by leaving the door closed.
- ▶ Due to the high temperatures radiated, objects left near the microwave oven when it is in use could catch fire. Do not use the appliance to heat up the room.
- ▶ If using alcohol in your recipes, please be aware that high temperatures can cause the alcohol to vaporise. The vapour can catch fire on hot surfaces. Never heat undiluted alcohol in the microwave, as it can easily ignite. Fire hazard!
- ▶ Food which is stored in the oven or left in it to be kept warm can dry out and the moisture released can lead to corrosion damage in the microwave oven. This can also cause damage to the control panel, benchtop and surrounding kitchen furniture. Always cover food that is left in the oven to keep warm.
- ▶ Try to avoid the interior walls being splashed with food or liquids containing salt. If it does happen, wipe these away thoroughly to avoid corrosion on the stainless steel surface.

Warning and Safety instructions

▶ The oven interior can get hot during use. Danger of burning! Clean the oven interior and accessories as soon as it has cooled down. Waiting too long can make cleaning unnecessarily difficult and in some cases impossible. Stubborn soiling could damage the microwave oven in certain circumstances and could even be dangerous. Fire hazard! Please refer to the relevant instructions in “Cleaning and care”.

▶ Fire hazard! Plastic containers which are not suitable for use in microwave ovens can be badly damaged and cause damage to the appliance if used. Do not use any containers or cutlery made from or containing metal, aluminium foil, lead crystal glassware, temperature-sensitive plastics, wooden utensils or cutlery, metal clips or plastic or paper covered wire ties. Do not use bowls with milled rims, or plastic pots with the foil lid only partially removed (see “Suitable containers for microwave use”).

Using these items could result in damage to the container and/or present a fire risk.

▶ Disposable plastic containers must be specified by the manufacturer as suitable for use in a microwave oven.

Do not leave the oven unattended when heating or cooking food in disposable containers made of plastic, paper or other inflammable materials.

▶ Heat-retaining packaging consists of, among other things, a thin layer of aluminium foil. Microwaves are reflected by metal. This reflected energy can, in turn, cause the outer paper covering to become so hot that it ignites.

Do not use heat-retaining packaging for warming food in the microwave oven, such as bags for grilled chicken.

▶ If you cook eggs without their shells using microwave power, the yolks could explode due to the resulting pressure. Prick the yolk several times before cooking to avoid this.

▶ Eggs heated in their shells using microwave power can burst, even after they have been taken out of the oven. Eggs can only be cooked in their shells in a specially designed egg-boiling device.

Do not reheat hard-boiled eggs in the microwave oven.

▶ Food with a thick skin or peel, such as tomatoes, sausages, potatoes and aubergines can burst when heated. Pierce or score the skin of these types of food several times to allow steam to escape.

▶ Dishes with hollow knobs or handles are not suitable for use in a microwave oven. Moisture which has gathered in the hollow recesses can cause pressure to build up and the items can explode (this risk is reduced if the hollow recess is sufficiently ventilated). We recommend that you do not use such dishes in the microwave oven.

Warning and Safety instructions

- ▶ Do not use a thermometer containing mercury or liquid as these are not suitable for use with very high temperatures and break very easily. To check food temperature, first interrupt the cooking process. Only use a thermometer specifically approved for food use to measure the temperature of the food.
- ▶ The steam from a steam cleaner could reach electrical components and cause a short circuit. Do not use a steam cleaner to clean the appliance.

The following applies for stainless steel surfaces:

- ▶ The surface is susceptible to scratching. Even magnets can cause scratches.

Accessories

- ▶ Only use original Miele accessories. If other parts are used, warranty, performance and product liability claims will be invalidated.
- ▶ Miele will guarantee to supply functional spare parts for a minimum of 10 years and up to 15 years following the discontinuation of your microwave oven.
- ▶ The rack and gourmet plate supplied are designed for use with microwave power and can be used for grilling with or without the microwave function.
They must not, however, be used at the same time, as this would damage the gourmet plate. Always place the gourmet plate directly on the turntable.
- ▶ The gourmet plate gets extremely hot when in use. Always use oven gloves when handling it to avoid burns. Place it on a suitable heat-resistant mat or pot rest.
The rack and the gourmet plate get hot during grilling (with or without the microwave function).
Danger of burning!
Do not place the hot gourmet plate (or any other hot cooking container) on a cold surface, such as a tiled or granite benchtop. The glass tray or container could crack or shatter. Use a suitable heat-resistant mat or pot rest.
- ▶ Do not use the gourmet plate together with a commercially available microwave cover because the cover would become too hot.

Before using for the first time

After unpacking, let the appliance stand for approx. 2 hours at room temperature after transporting it to its final location before connecting it to the electricity supply.

This is to allow time for the temperature to equalise between the temperature in the room and the appliance. This is important for the correct electronic functioning of the appliance.

 Risk of suffocation from packaging material.

Whilst playing, children may become entangled in packaging material (such as plastic wrapping) or pull it over their head with the risk of suffocation.

Keep packaging material away from children.

- Remove all the packaging and any protective foil from the appliance.

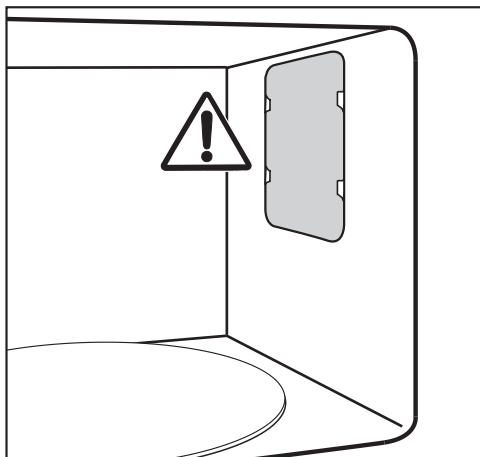

Do not remove the cover of the microwave outlet inside the oven, nor the film covering the inside of the door.

- Check the appliance for any damage.

 Danger to health due to a defective device.

Operating a damaged appliance can result in microwave leakage and present a hazard to the user.

Do not use the appliance if

- the appliance door is warped.
- the door hinges are loose.
- holes or cracks are visible in the casing, the door or the oven interior walls.

- Clean the inside of the microwave oven and all the accessories with a soft sponge and warm water.

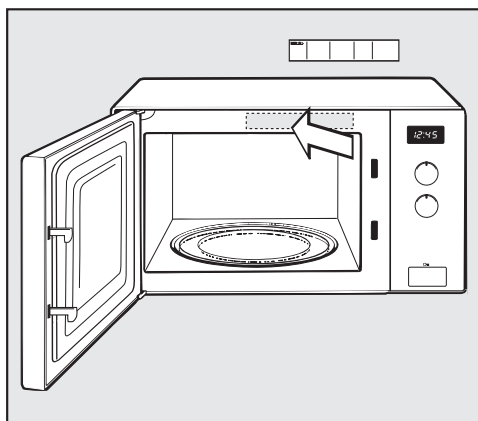

- Stick the enclosed quick start guide to the frame behind the door as illustrated, making sure it does not block any of the vents.

When installing the microwave oven, ensure that there is unhindered ventilation to and from the appliance both underneath and to the rear. Do not block the ventilation gaps or the gap between the base of the appliance and the worktop surface. A minimum installation height of 85 cm must be maintained.

The microwave oven can be placed on a benchtop.

To ensure adequate ventilation, a minimum gap of 5 cm is required between the appliance and any neighbouring furniture or walls. There must be a minimum gap of 19.5 cm between the top of the appliance and anything above it. Do not situate the appliance too close to an adjacent furniture unit.

Heat and moisture can build up if the microwave oven is installed behind a closed furniture door. This can result in damage to the appliance and furniture unit.

The microwave oven may only be used with the furniture door open. Do not close the furniture door while the appliance is in use. Leave the furniture door open until the appliance has cooled down completely.

If your microwave oven is built in with a lift-up door: do not bring the door down into the closed position when the oven is in operation.

Electrical connection

 Danger of injury due to a defective appliance. Before connecting the appliance, ensure that it has not been damaged in any way. Do not use a damaged appliance.

The appliance is supplied with a power cord and plug for connection.

 Risk of fire from overheating. Connecting the appliance to a multi-socket plug adapter or to an extension lead can overload the cable. The appliance must not be used with so-called energy saving devices either. These reduce the amount of energy supplied to the appliance, causing it to overheat. Do not use an extension lead or multi-socket plug adapter. Connect the appliance directly with the original cable without any intermediate elements.

Installation and connection

The electrical system must comply with the applicable standards and with local and national regulations.

If the connection cable is damaged, it must only be replaced with a specific connection cable of the same type (available from Miele) in order to avoid a hazard. For safety reasons, such replacement may only be carried out by a qualified and competent technician or Miele.

The connection data can be found on the data plate located on the front of the oven interior or on the back of the appliance.

Compare the specifications on the data plate with those of the mains electricity supply. The data must match.

If in any doubt, consult a qualified electrician.

Temporary or permanent operation with a self-sufficient or non-mains synchronous energy supply system (e.g. isolated networks, back-up systems) is possible. A requirement for the operation is that the energy supply system complies with all current local and national requirements that apply to stand-alone, solar and/or battery systems.

The protective measures provided in the domestic installation and in this Miele product must also be assured in their function and operation in isolated operation or in non-mains synchronous operation, or replaced with equivalent measures in the installation.

Disposal of the packing material

The transport and protective packaging has been selected from materials which are environmentally friendly for disposal, and can normally be recycled.

Recycling the packaging reduces the use of raw materials in the manufacturing process and also reduces the amount of waste in landfill sites.

Ensure that any plastic wrappings, bags etc. are disposed of safely and kept out of the reach of babies and young children. Danger of suffocation.

Only for Australia: Note for installer: Expanded polystyrene (EPS) packaging included. Please retain and dispose of EPS packaging responsibly. For further information, please contact Miele.

Disposing of your old appliance



Please dispose of it at your local community waste collection / recycling centre for electrical and electronic appliances. You are also responsible for deleting any personal data that may be stored on the appliance prior to disposal. Please ensure that your old appliance poses no risk to children while being stored prior to disposal.

Guide to the appliance

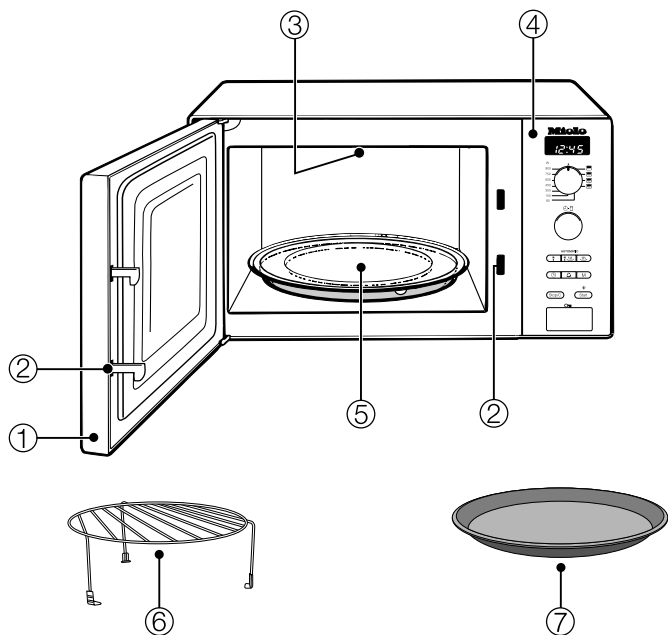

- ① Door
- ② Door lock
- ③ Grill
- ④ Control panel
- ⑤ Turntable
- ⑥ Grilling rack
- ⑦ Gourmet plate

Grilling rack

The grilling rack can be used for all functions with and without microwave power, **except** for Microwave Solo mode.

To avoid the grilling rack being used inadvertently with Microwave Solo mode, it should not be stored inside the microwave oven.

Gourmet plate

The gourmet plate is a round, non-stick grilling plate. It can be used to heat snacks or small meals quickly whilst maintaining crispness.

Useful tip: These products and others can be ordered from the Miele online shop.

They can also be ordered directly from Miele (see the end of this booklet for contact details).

Control panel

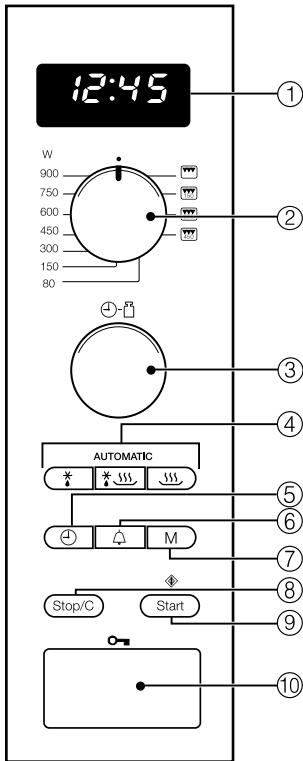

- ① For displaying the time of day and information on operation
- ② Rotary selector for microwave power, grill and combination programmes
- ③ Rotary selector to enter time and weight
- ④ Automatic programmes
- ⑤ Time of day
- ⑥ Minute minder
- ⑦ Memory button (to save a 1 - 3 stage programme sequence)
- ⑧ Stop/Cancel sensor
- ⑨ Start / Add a minute / Quick start (programmable)
- ⑩ Door release

Description of the functions

In a microwave oven there is a high-frequency tube called a magnetron. This converts electrical energy into electromagnetic waves (microwaves). These microwaves are distributed evenly throughout the oven interior, and are reflected off the metal appliance walls. This enables the microwaves to reach the food from all sides and heat it up. Microwave distribution is improved with the turntable engaged.

In order for microwaves to reach the food, they must be able to penetrate the cooking container being used.

Microwaves can pass through porcelain, glass, cardboard and plastics, but not metal. Therefore do not use utensils that are made of metal or contain metal, for example in the form of gold or silver trim. The metal reflects the microwaves and this could lead to the creation of sparks. The microwaves cannot be absorbed.

Microwaves pass through a suitable container and into the food. All food contains water molecules which, when subjected to microwave energy, start to oscillate 2.5 billion times a second. This vibration creates heat. It first starts developing around the outside of the food and then slowly penetrates towards the centre. The more water a food contains, the faster it is heated or cooked.

The heat is produced directly in the food. This has the following advantages:

- Food can generally be cooked without adding liquid or cooking oil, or with just a little water or oil.
- Cooking, reheating and defrosting in a microwave oven is quicker than using conventional methods.
- Nutrients, such as vitamins and minerals, are generally retained.

– The colour, texture and taste of food are not impaired.

Microwaves stop being produced as soon as the cooking process is interrupted or the appliance door is opened. When the appliance is in operation, the closed, sealed door prevents microwaves escaping from the appliance.

Modes of operation

In the microwave oven, food is cooked, reheated or defrosted quickly.

You can use the microwave oven in the following ways:

– Food can be defrosted, reheated or cooked by entering a power level and a duration.

– Deep-frozen, ready-made meals can be defrosted and then heated or cooked.

– The microwave oven can also be used for other tasks, e.g. for proving yeast dough, melting chocolate and butter, dissolving gelatine, preparing cake icing, and preserving small amounts of fruit, vegetables and meat.

Functions

Microwave Solo mode

Suitable for defrosting, reheating and cooking.

Grilling

Ideal for grilling thin cuts of meat, e.g. steak or sausages.



Combination mode (Microwave + Grill)

Ideal for browning dishes with toppings. The microwave cooks the food, and the grill browns it.

Automatic programmes

You can choose from the following Automatic programmes:

- five defrosting programmes
(: Ad 1 to Ad 5)

- four cooking programmes for frozen food
( : Ac 1 to Ac 4)

- and eight cooking programmes for fresh food
(: Ac 1 to Ac 8).

These programmes are weight dependent, i.e. you enter the weight of the food and then the cooking duration is calculated automatically.

The weight of the food can be displayed as metric (g) or imperial (lb) (see “Changing settings”).

Suitable containers for microwave use

Microwaves

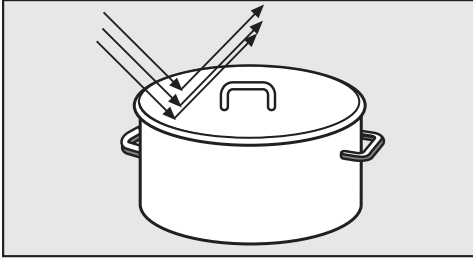

- are reflected by metal,

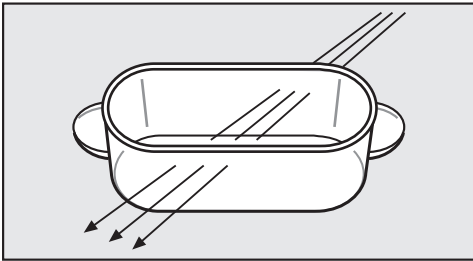

- pass through glass, porcelain, plastic and cardboard,

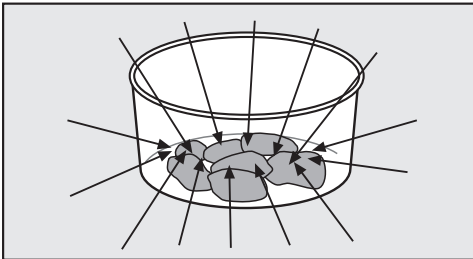

- and are absorbed by food.

⚠ Risk of fire due to unsuitable crockery.

Containers which are not suitable for use in microwave ovens can be badly damaged and cause damage to the appliance if used.

Please observe the information on suitable containers for microwave use.

Material and shape

The material and shape of containers used affect cooking results and times. Heat distribution is more even in round and oval shaped flat containers than in rectangular containers, providing better results.

⚠ Risk of injury due to hollow handle parts and lid knobs.

Moisture can penetrate hollow handles and lid knobs of crockery. This can lead to a build-up of pressure, which can cause the hollow parts to crack or shatter with the danger of injury.

Do not use crockery with hollow handles or lid knobs, unless the hollow parts are sufficiently vented.

Metal

Metal containers, aluminium foil, metal cutlery, and china with metallic decoration such as gold rims or cobalt blue must not be used with microwave mode. Metal reflects microwaves and obstructs the cooking process.

Do not use containers where the foil lid has not been completely removed as small pieces of foil can cause sparking.

- Ready-meals in aluminium foil dishes
These can be defrosted and reheated in the microwave oven, if recommended by the manufacturer. Important: Remove the lid and make sure the foil dish is at least 2 cm from the oven walls at all times. However, food is only heated from the top. Transferring the food from the aluminium foil container to a dish suitable for microwave use will result in a more even heat distribution.

Suitable containers for microwave use

Do not place aluminium foil dishes on the rack, in case the dish sparks or arcs.

- Pieces of aluminium foil

Make sure that the aluminium foil is at least 2 cm from the oven walls at all times. It must not touch the walls.

- Metal meat skewers or clamps
These should only be used if they are very small in comparison to the size of the cut of meat.

Glazes and colours

Some dishes have glazes and colours containing metallic substances. These dishes are unsuitable for microwave use.

Glassware

Heat-resistant glass or ceramic glass is ideal for use in the microwave oven.

Crystal glass is unsuitable as it usually contains lead which could cause the glass to crack in the microwave.

Porcelain

Porcelain is a suitable material.

However do not use porcelain with gold or silver edging, or items with hollow knobs or handles.

Earthenware

Decorated earthenware is only suitable if the decoration is beneath an all-over glaze.

Earthenware can get very hot and may crack.

Wear oven gloves when removing the dishes from the oven.

Wood

Water contained in wood evaporates during the cooking programme. This causes the wood to dry and crack.

Wooden dishes are therefore not suitable.

Plastics

 Damage caused by heat-sensitive plastics.

Plastics must be heat-resistant to a minimum of 110 °C. Otherwise the plastic may melt and fuse with the food.

Use plastic containers only with Microwave Solo mode.

Plastic boiling bags can be used for cooking and reheating. They should be pierced beforehand to allow the steam to escape. This prevents a build-up of pressure from forming and the bag from bursting.

There are also special bags available for steam cooking which do not need to be pierced. Please follow the instructions given on the packet.

 Risk of fire due to unsuitable material.

Do not use metal clips, plastic clips containing metal parts, or paper ties containing wire.

There is a danger that they will ignite when heated.

Suitable containers for microwave use

Disposable containers

 Risk of fire due to unsuitable crockery.

Disposable containers made out of plastic, paper or other inflammable materials can ignite.

Do not leave the appliance unattended when reheating or cooking food in disposable containers made of plastic, paper or other inflammable materials.

To protect the environment we do not recommend the use of single-use containers.

Testing containers

If in doubt as to whether glass, earthenware or porcelain plates or dishes are suitable for use in a microwave oven, a simple test can be performed:

- Place the item you wish to test in the centre of the oven.
- Close the door.
- Turn the power selector to 900 W.
- Enter a duration of 30 seconds with the time selector.
- Press the Start button.

If a crackling noise is heard during the test accompanied by sparks, switch the appliance off immediately (press Stop/C twice)! Any crockery which causes this reaction is unsuitable for use with microwave power. If any doubt exists about the suitability of containers, please contact the supplier.

This test cannot be used to check whether items with hollow knobs or handles are suitable for use with microwave power.

Suitable containers for microwave use

A microwave lid or cover

- prevents too much steam escaping, especially when cooking foods which need longer to cook, such as potatoes.
- speeds up the cooking process.
- prevents food from drying out.
- helps keep the oven interior clean.

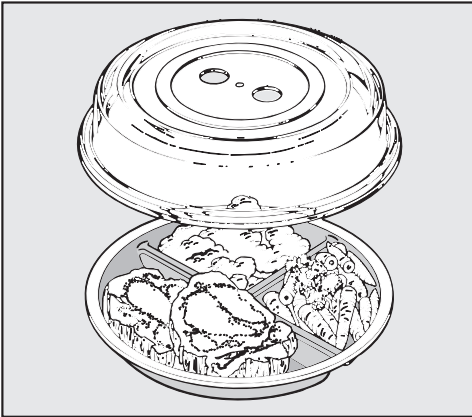

- When using Microwave Solo, always cover food with a microwave-safe lid.

Suitable covers are available from retail outlets.

⚠ Damage caused by heat-sensitive plastics.

The material of the microwave cover must be able to withstand temperatures of up to 110 °C (see manufacturer information). At higher temperatures the plastic may distort and fuse with the food.

Therefore the cover must only be used in microwave ovens and only with Microwave Solo mode without the gourmet plate.

⚠ Damage due to covered openings.

If a lid is used with a container which only has a narrow diameter, the cover could form a seal around the container and there might not be enough room for condensation to escape through any holes in the top. The cover could get too hot and start to melt.

Make sure that the cover does not form a seal.

Do not use a lid or cover when

- cooking food coated with breadcrumbs.
- cooking meals which are to be given a crisp finish, such as toast.
- the gourmet plate is being used.

⚠ Risk of explosion due to pressure build-up.

Pressure can build up when reheating food or drinks in sealed containers, jars or bottles, which can cause them to explode.

Sealed glass containers, such as jars of baby food, must be opened before they are placed in the microwave. Do not attempt to heat them up unopened. With baby bottles, the screw top and teat must be taken off.

Before using for the first time

Setting the time of day

- Connect the appliance to the electricity supply.

12:00 and the ⌚ symbol will flash in the display until the current time of day is set. In the meantime, the time of day will start to run from 12:00, as the clock starts as soon as the appliance is connected to the electricity supply.

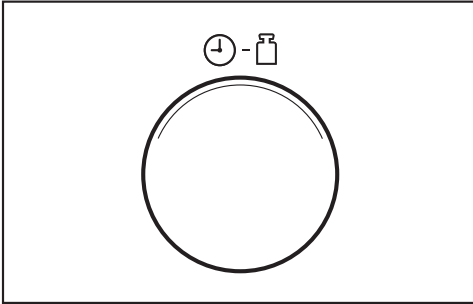

- Turn the time selector to set the hour.
- Touch the ⌚ sensor.
- Then turn the time selector to set the minutes.
- Press the ⌚ button to confirm, or wait a few seconds.

The set time is now adopted. The colon between hours and minutes flashes.

Altering the time of day

- Press the ⌚ button.

The ⌚ symbol will flash in the display, and the current hour will light up for a few seconds.

- Use the time selector to alter the hour.
- Press the ⌚ button to confirm, or wait for a few seconds.

The ⌚ symbol will flash and the current minutes will light up for a few seconds.

- Use the time selector to alter the minutes.
- Press the ⌚ button to confirm, or wait for a few seconds.

Switching off the time of day display

- Press and hold the ⌚ button until the display goes dark.

Pressing and holding the ⌚ button again will bring the time of day back in the display.

Night time switch-off

The time of day display can be set to switch itself off from 11:00 pm until 4:00 am.

Setting the time of day display to **switch off at night**

- Press and hold the Stop/C button and at the same time press the ⌚ button.

ON will appear in the display. The appliance remains ready for operation.

To **deactivate** the night time display switch-off

- Press and hold the Stop/C button and at the same time press the ⌚ button.

OFF will appear in the display.

Operation

Opening the door

- Press the  button to open the door.

If the microwave oven is being used, opening the door will interrupt the cooking programme.

Placing a dish in the oven

Ideally the dish should be placed in the middle of the oven compartment.

Turntable

Do not operate the microwave without the turntable in place.

The turntable starts turning automatically when the appliance is operated.

Do not cook, reheat or defrost food directly on the turntable. Check that the dish is not larger in size than the turntable.

Turn or stir food during cooking, or turn the dish so that it heats up evenly.

Closing the door

- Push the door firmly shut.

Touch the Start sensor to resume an interrupted cooking programme.

The appliance will not start again if the door has not been closed properly.

Starting a programme

Use the appropriate selector to choose the microwave power level and the cooking duration.

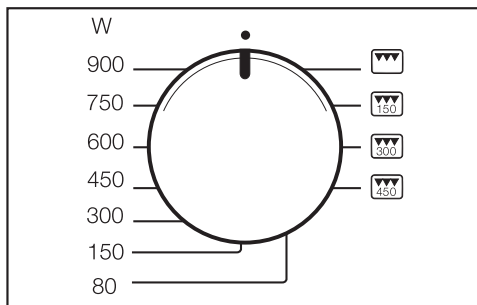

- Use the power selector to select a microwave power level.

 and the microwave power level light up in the display. 0:00 flashes.

You can choose between 7 power levels. The higher the power level, the more microwaves reach the food.

When heating up food which cannot be stirred or turned during cooking, as with a plated meal, it is best to use a lower microwave power level.

This ensures the heat is distributed evenly. Heat for long enough to cook the food properly.

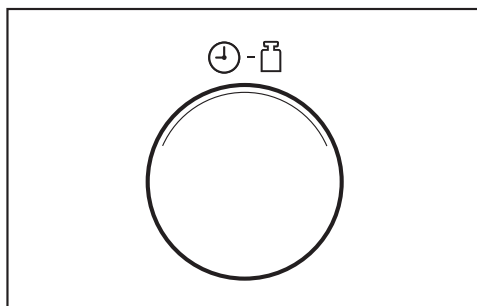

- Set the required time using the time selector.

The duration selected is visible in the display.

You can set a duration between 10 seconds and 90 minutes. Exception: If the maximum microwave power level has been selected, a maximum cooking duration of 15 minutes can be set. If you then continue to select full power, the power level may reduce to 600 W, and this is shown in the display (protection against overheating).

The time required depends on:

- the initial temperature of the food.
Food taken straight from the refrigerator takes longer to cook than food which has been kept at room temperature.
- the type and texture of the food. Fresh vegetables contain more water and cook more quickly than stored vegetables.
- the frequency of stirring or turning the food.
Frequent stirring or turning heats the food more evenly, and it is therefore ready in a shorter time.
- the amount of food.
As a general rule, allow approx. time and a half for double the quantity. For a smaller quantity, shorten the duration accordingly.
- the shape and material of the container.

- Press the Start button to start the programme.

The interior lighting comes on.

A programme can only be started if the door is closed.

“door” message

Operating the appliance without food can damage the appliance.

If the Start button is pressed without the door having first been opened, the word **door** appears in the display. If the door has been closed for 20 minutes or longer, it could mean that there is no food in the oven. This is to remind you to open the door and make sure there is food in the microwave oven before starting a process. You cannot start a process until you do this.

Interrupting or restarting a programme

At any time you can . . .

. . . **interrupt a programme:**

- Touch the Stop/C sensor or open the appliance door.

The time stops counting down.

. . . **continue a programme:**

- Close the door and touch Start.

The programme will continue.

Altering the settings

If you discover after starting a programme that . .

. . the **microwave power level** is too high or too low, you can

- select a new level.

. . the **duration** set is too short or too long, you can

- interrupt the programme (press the Stop/C button once), use the time selector to set a new time and continue the programme (press the Start button).

Or alternatively:

- The cooking duration can be increased by pressing Start during operation. Each time Start is pressed, the cooking duration is increased by

Operation

another minute (exception: the cooking time increases in increments of 30 seconds when the microwave is being used at the maximum power level).

Cancelling a programme

- Touch the Stop/C sensor twice.

At the end of a programme

A signal tone will sound when the cooking programme is complete. The interior lighting goes out.

The signal tone will sound briefly as a reminder every 5 minutes for 20 minutes after the end of the programme.

- If you want to stop the signal tone, touch the Stop/C sensor.

Automatic keeping warm function

The keeping warm function will switch on automatically after the end of a cooking programme which has used at least 450 W, providing the door remains closed and no sensors are touched.

After approx. 2 minutes the keeping warm function will switch on at 80 W for a maximum period of 15 minutes.

 , 80 W and **H:H** will light up in the display.



Opening the door or operating one of the sensors while the keeping warm function is in progress cancels the function.

The keeping warm function cannot be set separately.

You can deactivate this function (see “Changing settings”).

Quick start (programmable)

Pressing Start/ is sufficient to set the appliance operating at maximum power. You can choose between three set times that are stored in the memory:



- 30 s: press Start / 1 x
- 1 min: press Start / 2 x
- 2 min: press Start / 3 x

Pressing Start / four times in succession will bring back the first stored duration and so on.

The cooking duration can be increased by pressing Start during operation. Each time it is pressed, the cooking duration is increased by another 30 seconds.

Programming durations

Set durations can be altered.

- Press Start/ to select the saved duration you want to re-programme (press once, twice or three times) and hold Start/.
- At the same time, alter the duration with the time selector (to max. 15 minutes).

The altered programme starts running when Start/ is released.

An interruption to the power supply will cancel any altered programmed durations, and they will need to be re-entered.

System lock

The system lock prevents the appliance being used unintentionally, for example by children.

Activating the system lock

- Press and hold the Stop/C button until a signal tone sounds and the key symbol appears in the display:



The key symbol will go out after a short time.

The key symbol reappears whenever any button or one of the rotary selectors is operated.

After an interruption to the power supply, the system lock must be activated again.

Cancelling the system lock

- To deactivate the system lock Press the Stop/C button again and hold it until the signal tone sounds.

Using the minute minder

The minute minder can be used to time any activity in the kitchen, e.g. boiling eggs. The set time counts down in seconds.

- Press the Δ button.

0:00 flashes and the Δ symbol lights up in the display.

- Use the time selector to set the minute minder time you require.
- Press the Start button to start the timer.

The minute minder time will start by itself after a few seconds if Start is not pressed.

- At the end of the minute minder time, a signal tone sounds. The time of day reappears and the Δ symbol flashes.
- Press the Stop/C button once and the Δ symbol disappears.

Altering a minute minder entry

- Press the Stop/C button.

The current minute minder time is stopped.

- Set a new minute minder time, as described above.

Minute minder + cooking process

The minute minder can be used at the same time as a cooking process and counts down in the background.

- Press the Δ button during the cooking programme.

0:00 flashes and the Δ symbol lights up in the display.

- Use the time selector to set the minute minder time you require.
- Wait a few seconds and the minute minder will begin to count down.

A few seconds later, the display will change again to show the cooking duration counting down. The minute minder time counting down in the background is represented by the illuminated Δ symbol.

Do not press Start in this instance to start the minute minder, as pressing Start would also increase the cooking duration by one minute.

Requesting the minute minder time remaining

- Press the Δ button.

The minute minder time still remaining will appear in the display.

Operation - Grilling

The grill has 4 settings: Grill solo and 3 combination settings where the grill is used together with a specific microwave power level.

If the total grilling duration required is less than 15 minutes, the grill should be preheated for approx. 5 minutes.

Thin, flat cuts of fish and meat should usually be turned half way through grilling for even results. Larger, chunkier pieces should be turned several times.

Grilling times depend on the type and thickness of the food and on the user's preference for a rare, medium or well done result.

When grilling directly on the rack, a heat-resistant, microwave-safe container should be placed underneath the rack to catch any fat or juices.

 Risk of damage due to overheating.

The gourmet plate supplied is not suitable for catching fat. It could overheat when empty. This would damage the coating.

Use a heat-resistant, microwave-safe dish instead.

- Place the food in a suitable dish.
- Place the rack and a heat-resistant, microwave-safe dish or the container with the food to be cooked on the turntable.

 Danger of burning due to hot dishes.

The rack and container will become hot during cooking.

Wear oven gloves when removing the dishes from the oven.

The container and grill rack will be easier to clean if washed in soapy water immediately after grilling.

The area on the ceiling around the grill becomes discoloured over time. This is an unavoidable consequence of use, and does not impair the function of the appliance in any way.

Grilling without the Microwave function

Ideal for grilling thin cuts of meat, e.g. steak or sausages.

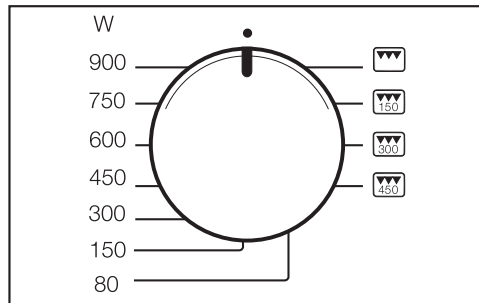

- Turn the power selector to .

0:00 flashes and the  symbol lights up in the display.

- Select a cooking duration using the time selector.
- Press the Start button.

A signal tone will sound when the cooking programme is complete.

To change a cooking duration



The cooking duration entered can be changed during operation if required. Interrupt the process by pressing the Stop/C button, and change the duration. To continue, press the Start button. The cooking duration can also be extended during operation by pressing Start once for each minute you wish to extend the cooking duration by.

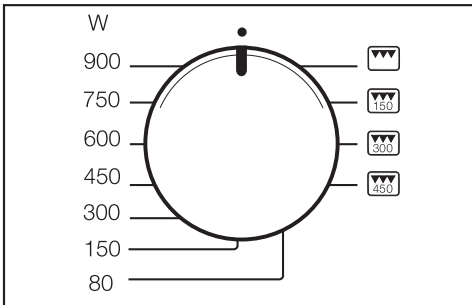

Combination mode - Microwave + Grill

This function works well for baking and browning. The microwave cooks the food, and the grill browns it.

The grill can be combined with one of three different microwave power levels: 150, 300 and 450 W. It is possible to switch between the different power levels during the cooking process without interrupting the programme.



- Use the power selector to select   or  as required.

The  symbol, the microwave power level and the  grill symbol will light up in the display. 0:00 flashes.

- Select a cooking duration using the time selector.
- Press the Start button.

A signal tone will sound when the cooking programme is complete.

To change a cooking duration

The cooking duration entered can be changed during operation if required. Interrupt the process by pressing the Stop/C button, and change the duration. To continue, press the Start button. The cooking duration can also be extended during operation by pressing Start once for each minute you wish to extend the cooking duration by.

Gourmet plate

Instructions for use

 Danger of burning due to hot dishes.

The gourmet plate gets extremely hot when in use.

Always use oven gloves when handling it to avoid burns. Place it on a suitable heat-resistant mat or pot rest.

Before using for the first time

Before using the gourmet plate for the first time, fill it with 400 ml water and add 2 to 3 tbsp. vinegar or lemon juice. Heat for 5 minutes at 450 W + Grill .

The gourmet plate has an easy-to-clean anti-stick coating so that food can be removed easily.

The coating is susceptible to cuts and scratches.

Metallic or sharp objects can damage the non-stick coating.

Therefore do not cut food up directly on the plate.

Use wooden or plastic utensils to mix or turn food.

Searing/browning food

 Risk of fire from overheating.

Oils and fats can ignite if allowed to overheat.

Never leave the appliance unattended when cooking with oil or fats.

- Only use very little oil when grilling with this dish. The anti-stick coating will prevent food from sticking to it, and this way you can reduce the amount of heated oil used.

- When using the gourmet plate, make sure that the food is ready to transfer to the gourmet plate as soon as the gourmet plate has heated up.

- Place the gourmet plate directly on the turntable.

Sparking can damage the gourmet plate and the oven interior.

Do not place the gourmet plate on the rack. Make sure there is a gap of approx. 2 cm between the gourmet plate and the interior walls of the microwave oven so that sparking cannot occur.

- Heat the plate up at 450 W + Grill  for up to max. 5 minutes.

 Risk of damage due to overheating.

Do not overheat the empty gourmet plate. This would damage the coating.

For this reason do not place the gourmet plate under the rack to catch the fat when grilling.

If using oil for grilling, you can either heat up the oil on the gourmet plate, or you can heat the oil separately and then add it to the plate.

Butter, however, should always be added after heating up the gourmet plate. It has a lower burning point than oil and would get too dark or burn if added too soon.







Always dry meat, poultry, fish and vegetables thoroughly before placing them on the gourmet plate.

Eggs can explode.

Do not use the gourmet plate to cook eggs or reheat cooked eggs.

Examples of use

Pre-heat the gourmet plate directly on the turntable for up to max. 5 minutes at 450 W + Grill .

- Fish fingers (frozen), 150 g + 1½ tbsp. oil , 3 – 4 minutes each side
- Hamburgers, 2 burgers + 1½ tbsp. oil , 3 – 4 minutes each side
- Croquette potatoes (frozen), 10 – 12 pieces + 1½ tbsp. oil , 6 – 8 minutes, turning halfway through
- Fillet steak, approx. 200 g , 5 minutes each side (according to taste)
- Pizza (frozen), 300 g , 7 – 9 minutes
- Pizza (fresh), without pre-heating , 15 minutes approx. (depending on topping)

Recipes

Preparation times given are the total time required for preparation and cooking. Standing time or time for marinating food is quoted in addition to preparation time.

Croque monsieur (serves 3)

Preparation time: 10 – 15 minutes

Ingredients

- 6 slices of white bread
- 30 g soft butter
- 75 g Emmental cheese, grated
- 3 slices of ham

Method

Butter the bread. Add the cheese to three of the bread slices in equal amounts and arrange a slice of ham on top of each. Place the remaining three slices of bread on top of the ham with the buttered side facing down. Pre-heat the gourmet plate using 450 W + Grill for approx. 5 minutes, then place the bread on it. Place on the turntable and cook using 450 W + Grill for approx. 3 minutes each side until golden. Other fillings could include drained tuna with finely sliced onion rings, or pineapple, cheese and ham.

Gourmet plate

Vegetable stir fry (serves 3)

Preparation time: 25 – 35 minutes

Ingredients

2 onions
1½ tbsp. oil
100 g oyster mushrooms or button mushrooms, cleaned
150 g sliced carrots
100 g broccoli florets
1 red capsicum or 100 g frozen sliced capsicums
1 tomato
Salt and pepper
30 g grated Parmesan cheese

Method

Slice the onions into fine rings. Halve, quarter and deseed the capsicum, and then cut into strips. Dice the tomato. Place the gourmet plate on the turntable and pre-heat it using 450 W + Grill for approx. 5 minutes. Add oil and onion rings. Place gourmet plate back on the turntable and cook using 450 W + Grill for approx. 2 minutes. Add the mushrooms, carrots, broccoli, sliced capsicum, diced tomato and seasoning. Mix well. Cook using 450 Watt + Grill for approx. 6 minutes. Turn and sprinkle with Parmesan cheese before serving.

Pork fillets (serves 2)

Preparation time: 15 – 20 minutes

Ingredients

1 pork tenderloin (approx. 400 g)
4 rashers of streaky bacon
Salt and pepper
10 g butter
200 g sliced button mushrooms
200 ml double cream
1½ tbsp. brandy

Method

Cut the pork tenderloin into four pieces. Season each piece with salt and pepper, and wrap in a rasher of streaky bacon. Secure with a cocktail stick if necessary. Place the gourmet plate on the turntable and pre-heat it using 450 W + Grill for approx. 5 minutes. Add the butter to the plate, and place the meat on top. Place on the turntable and cook using 450 W + Grill for approx. 3 minutes each side. Transfer the meat to a serving dish, cover and keep warm. Add the mushrooms, cream and brandy to the meat juices and heat at maximum power for approx. 4 minutes. Serve with the meat.

Pork fillet in a Roquefort sauce

Preparation time: 10 – 12 minutes

Method

Cut 1 pork tenderloin into four thick slices. Place on the pre-heated gourmet plate and cook using 450 W + Grill for approx. 4 minutes. Add 50 ml white wine, 125 ml double cream, 2 tbsp. roux (made from 1 tbsp. each flour and melted butter) and 150 g Roquefort cheese. Stir the sauce until smooth, and cook for a further 3 minutes.

Curried chicken (serves 3)

Preparation time: 25 – 35 minutes

Ingredients

600 g chicken or turkey breast fillets
1¹/₂ tbsp. oil
1¹/₂ tbsp. white wine
1¹/₂ tbsp. apple juice
3³/₄ tbsp. lemon juice
Salt and freshly ground black pepper
1 tsp. curry powder
1 pinch rosemary, ground
1 pinch ginger, ground
1 pinch cayenne pepper
1¹/₂ tsp. Tabasco
20 g butter

Method

Dice the meat into 2 x 2 cm pieces. Combine the rest of the ingredients apart from the butter, and pour over the meat. Mix well, and leave to stand for approx. 30 minutes. Place the gourmet plate on the turntable. Pre-heat it using 450 Watt + Grill for approx. 5 minutes. Add the butter to the pre-heated plate, then add the slightly drained meat. Place the gourmet plate on the turntable and cook using 450 W + Grill for approx. 4 minutes, turn and cook for a further 4 minutes on the same setting. Drain surplus liquid from the meat if necessary so that it browns well.

Fisherman's salmon (serves 2)

Preparation time: 5 – 10 minutes

Ingredients

2 salmon fillets (approx. 150 g each)
3³/₄ tbsp. lemon juice
Salt, white pepper

Method

Drizzle the salmon with the lemon juice, and leave to stand for approx. 10 minutes. Place the gourmet plate on the turntable and pre-heat using 450 W + Grill for approx. 5 minutes. Pat the fish dry with kitchen paper, and place on the gourmet plate, pressing it down slightly. Place on the turntable and cook using 450 W + Grill for approx. 1¹/₂ – 2 minutes each side. Serve with rice, hollandaise sauce or melted butter and a fresh green salad.

Operation - Automatic programmes

All of the Automatic programmes are weight dependent.

The weight of the food can be displayed as metric (g) or imperial (lb) (see “Changing settings”).

After selecting a programme, enter the weight of the food. The appliance automatically calculates the duration according to the weight entered.

After cooking, allow the food to stand at room temperature for the suggested number of minutes (“standing time”) to allow the heat to be distributed evenly through the food.

Automatic defrosting

There are five programmes for defrosting different types of food (⚡ button). The standing time for programme Ad 3 is up to 30 minutes, depending on weight, and approx. 10 minutes for the remaining programmes.

Ad 1  Steak, chops
200–1.000 g

Ad 2  Minced meat
200–1.000 g

Ad 3  Chicken
900–1.800 g

Ad 4  Cakes
100–1.400 g

Ad 5  Bread
100–1.000 g

This programme is particularly suitable for defrosting frozen sliced bread. If possible, place single slices in the microwave, or separate the slices when the signal tone sounds at half-time.

Automatic cooking

There are four programmes for frozen food and eight programmes for fresh food.

The standing time for each of these programmes is approx. 2 minutes.

 Damage caused by heat-sensitive plastics.

The material of a microwave cover must be able to withstand temperatures of up to 110 °C (see manufacturer information). At higher temperatures the plastic may distort and fuse with the food.

Only use microwave covers with Microwave Solo mode. On no account must the cover be used if the grill is switched on, i.e. with programmes AC 4 to AC 8.

Cooking food from frozen

AC 1  Vegetables
100–600 g

AC 2  Ready meals which can be stirred
300–1.000 g

AC 3  Bakes, gratin
200–600 g

AC 4  French fries
200–400 g

Operation - Automatic programmes

Cooking fresh food

AC 1  Vegetables
100–600 g

AC 2  Potatoes
100–800 g

AC 3  Fish
500–1.500 g

AC 4  Kebabs
200–800 g



AC 5  Whole chicken
900–1.800 g

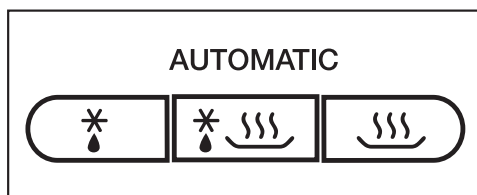

AC 6  Chicken drumsticks
250–1.000 g

AC 7  Fish pie
500–1.500 g



AC 8  Gratins/bakes,
e.g. potato gratin
500–1.500 g



- Press the relevant button repeatedly until the automatic programme required shows in the display. For example, to call up programme AC 5  (Grilled chicken) press the  button five times.

g or lb will flash in the display to prompt you to enter the weight, and the programme (e.g. AC 5) will light up together with the symbols for the functions being used ( for Microwave and  for Grill).

- Turn the weight selector to enter the weight.
- Press the Start button.

The duration (which depends on the weight) will begin to count down, and the symbols for the functions that are currently in use will light up ( and/or ).

A signal tone will sound halfway through the cooking duration.

- Interrupt the programme to turn or stir the food, and then continue the programme.

If necessary, the programmed time can be extended by a few minutes during operation by touching Start repeatedly until the time required appears in the display. In all programmes it is only possible to extend the time by a few minutes.

A signal tone will sound when the cooking programme is complete. The interior lighting goes out.

Recipes - Automatic programmes

Below are some recipe suggestions for the Automatic programmes using the Cooking fresh food  function. These can be adapted to suit your requirements.

If the weight guidelines are exceeded, the food will not cook sufficiently.
It is important to follow the weight guidelines given for each programme.

AC 1 Vegetables

Preparation

Place the prepared vegetables in a container. Add 1 ½-2 tbsp. water, depending on freshness and moisture content, and a little salt or other seasoning. Enter the weight including that of the water, place the covered cooking container on the turntable and cook. About halfway through the cooking duration, a signal tone will sound to prompt you to turn or stir the food.

When cooking vegetables in a sauce, the weight entered must include the sauce. Do not exceed the maximum weight guidelines.

Carrots in a chervil cream sauce (serves 2)

Preparation time: 25 – 35 minutes

Ingredients

350 g carrots, cleaned
5 g butter
50 ml vegetable stock (instant)
75 ml crème fraîche
1 tbsp. white wine
Salt and pepper
1 pinch of sugar
½ tsp. mustard
1-2 tbsp. chervil, fresh, chopped or
1 tbsp. chervil, dried and ground
Approx. 1 tbsp. cornflour

Method

Peel carrots, then cut into batons or slices (approx. 3 – 4 mm thick). Combine the rest of the ingredients, and pour over the carrots. Cover and cook. Stir when the signal tone sounds.

Setting: Cooking fresh food AC 1 
Weight: 525 g
Shelf level: Turntable

AC 2 Potatoes

This programme can be used to cook boiled, jacket and bouillon potatoes.

Method

Enter the weight for the potatoes and the cooking liquid.

For boiled potatoes, peel, wash and drain the potatoes and place them in a cooking container. Season with a little salt, cover and cook.

When boiling potatoes, add approx. 1 tbsp. water per potato. If cooking the potatoes in their skins, pierce the skins several times with a fork or skewer before cooking, then cover the container and cook.

Golden curried potatoes (serves 3)

Preparation time: 25 – 35 minutes

Ingredients

500 g peeled potatoes
1 onion, finely diced
10 g butter
1 – 2 tbsp. curry powder
250 ml vegetable stock (instant)
50 ml double cream
125 g peas (frozen)
Salt and pepper

Method

Coarsely dice the potatoes (approx. 3 x 3 cm) or use small potatoes. Mix together all the ingredients in a suitably large dish. Cover and cook. Stir when the signal tone sounds, then continue cooking.

Setting: Cooking fresh food AC 2 

Weight: 800 g

Shelf level: Turntable

AC 8 Gratin/Bakes: Vegetable gratin (serves 4)

Preparation time: approx. 40 minutes

Ingredients

400 g cauliflower or broccoli

400 g carrots

For the cheese sauce

20 g margarine

20 g flour

300 ml vegetable stock (instant)

200 ml milk

100 g diced Emmental cheese

50 g grated Gouda cheese

Pepper, salt, ground nutmeg

1 tbsp. chopped parsley

Method

Cut the cauliflower or broccoli into small florets, and thinly slice the carrots (approx. 3 mm thick). Place the vegetables in a baking dish (approx. 24 cm in diameter) and mix well. Melt the margarine in a pan on the stove, stir in the flour and then add the stock and milk whilst continuing to stir. Stir in the Emmental cheese, and simmer until the cheese has melted. Season well with nutmeg, salt and pepper and add the parsley. Pour the sauce over the vegetables, and sprinkle over the grated Gouda cheese. Bake in the oven uncovered.

Setting: Cooking fresh food AC 8 

Weight: 1500 g

Shelf level: Turntable

Potato cheese gratin (serves 4)

Preparation time: 45 minutes

Ingredients

For the gratin

600 g potatoes, floury

75 g Gouda, grated

For the topping

250 g cream

1 tsp. salt

Pepper

Nutmeg

For sprinkling

75 g Gouda, grated

For the dish

1 clove of garlic

Accessories

Microwave-safe ovenproof dish,

Ø 26 cm

Preparation

Rub the dish with the garlic clove.

To make the cream mixture, mix together the cream, salt, pepper and nutmeg.

Peel the potatoes and cut them into slices 3–4 mm thick. Mix the potatoes with the cheese and the cream mixture, and transfer to the ovenproof dish.

Sprinkle with Gouda, then bake uncovered.

Setting: Cooking fresh food AC 8 

Weight: 1000 g

Shelf level: Turntable

Recipes - Automatic programmes

AC 4 Pork kebabs (makes 8 kebabs)

Preparation time: approx. 25 – 35 minutes + 1 hour standing time

Ingredients

1 fillet of pork (approx. 300 g)
1 red capsicum
2 onions

For the marinade

6 tbsp. oil
Salt, pepper, paprika and chilli powder
8 wooden skewers

Method

Cut the pork fillet into 16 cubes. Wash the capsicum and cut into bite-sized pieces. Cut the onions into eight pieces. Place the meat, capsicum and onion pieces alternately on the skewers. Mix together the ingredients for the marinade and brush the kebabs with the mixture. Allow to marinate for approx. one hour. Lay the kebabs on the lightly oiled grill rack, brush with butter and place in the oven together with a heat-resistant, microwave-safe dish. Turn halfway through grilling when the signal tone sounds.

Setting: Cooking fresh food AC 4 

Weight: approx. 100 g per kebab

Shelf level: Rack and dish on turntable

Chicken kebabs (makes 8 kebabs)

Preparation time: approx. 25 – 35 minutes + 1 hour standing time

Ingredients

4 chicken breasts each approx. 120 g
4 tinned pineapple rings
16 tinned apricot halves

For the marinade

3 tbsp. oil
3 tbsp. sesame oil
Salt and pepper
 $\frac{1}{2}$ tsp. paprika
 $\frac{1}{2}$ tsp. curry powder
A little chilli powder
Ground ginger or coriander, if desired

8 wooden skewers

Method

Cut each chicken breast into 4 pieces. Cut the pineapple slices into quarters. Drain the tinned apricot halves well. Mix all ingredients for the marinade thoroughly.

Arrange the chicken pieces, pineapple and apricots alternately on the wooden skewers, brush with the marinade and set aside for one hour. Put the kebabs on the grilling rack and place in the oven together with a heat-resistant, microwave-safe dish. Turn halfway through grilling when the signal tone sounds.

Setting: Cooking fresh food AC 4 

Weight: approx. 100 g per kebab

Shelf level: Rack and dish on turntable

AC 6 Chicken thighs

Preparation

Brush the chicken thighs with butter or oil and season. Place on the grill rack in the oven together with a heat-resistant, microwave-safe dish. Halfway through cooking when a signal tone sounds, turn the chicken thighs over and continue to cook.

AC 5 Whole chicken

Method

Cut the chicken in half. Brush with melted butter or oil, and season. Then place the chicken halves on the grill rack in the oven with the cut side facing upwards together with a heat-resistant, microwave-safe dish. Halfway through cooking when the signal tone sounds, turn the chicken halves over and continue to cook.

Re AC 6 and AC 5

Method

For a good colour and flavour when grilling chicken, sprinkle with a mixture of paprika and curry powder. The spices will give the skin an appetising golden colour as well as enhance the flavour.

AC 3 Fish: Fish curry (serves 4)

Preparation time: 35 – 45 minutes

Ingredients

300 g pineapple chunks
1 red capsicum
1 small banana
500 g firm white fish
2 tbsp. lemon juice
30 g butter
100 ml white wine
100 ml pineapple juice
Salt, sugar and chilli powder
2 tbsp. cornflour

Method

Dice the fish and place in a suitable container. Drizzle with lemon juice. Quarter the capsicum, remove the seeds and pith, and cut into narrow strips. Peel and slice the banana. Add to the fish along with the capsicum and pineapple pieces, and mix well. Add the butter. Mix together the wine, juice, seasoning and cornflour to make a smooth sauce and pour over the fish. Mix everything thoroughly, then cover and cook.

Setting: Cooking fresh food AC 3 
Weight: approx. 1200 g
Shelf level: Turntable

Recipes - Automatic programmes

AC 7 Fish bake: Crispy fish pie (serves 2)

Preparation time: 25 – 35 minutes

Ingredients

400 g filleted rosefish or other white fish, e.g. cod
2 tbsp. lemon juice
Salt, white pepper
50 g butter
2 tsp. mustard
1 onion, finely diced
40 g grated Gouda cheese
20 g breadcrumbs
2 tbsp. fresh dill, chopped

Method

Drizzle the fish fillet with the lemon juice, and leave to stand for approx. 10 minutes. Grease a flat oven dish with a little butter. Pat the fish dry, season with salt and pepper and place in the dish. Mix the melted butter (450 W, 40 – 50 sec.) with the mustard, onions, Gouda cheese, breadcrumbs and dill, and brush onto the fish. Bake until golden.

Setting: Cooking fresh food AC 7 
Weight: approx. 600 g
Shelf level: Turntable

Perch and tomato gratin (serves 4)

Preparation time: 35 – 45 minutes

Ingredients

500 g filleted perch or other white fish, e.g. cod
1½ tbsp. lemon juice
500 g tomatoes
Herbs, seasoning salt
2 tsp. ground oregano
150 g grated Gouda cheese

Method

Cut the fish into pieces, drizzle with lemon juice and leave to stand for approx. 10 minutes. Dice the tomatoes, and place in a baking dish with the fish and half of the cheese. Season generously with herb salt and oregano, and mix well. Sprinkle with the rest of the cheese and bake uncovered.

Setting: Cooking fresh food AC 7 
Weight: approx. 1150 g
Shelf level: Turntable

Saving your favourite programme (Memory)

You have the option of saving one favourite programme to memory. This programme can be used for your most frequently cooked recipe. The programme can have up to 3 stages (e.g. 1 minute at 600 W, followed by 2 minutes grill and finally 3 minutes at 150 W with grill).

Programming

(The example given is for a 3-step programme sequence)

- First select the function for the first stage.
- Then select the duration.

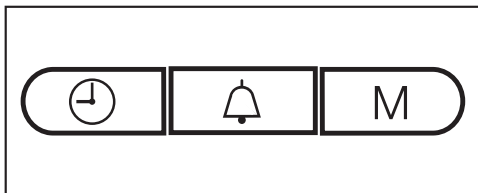

- Press the M button. 1 will light up in the display, and 2 will flash.
- Select the second function and duration.
- Press the M button again. 2 will light up and 3 will flash.
- Now select the third function and duration. Press the M button.

After this third step, you can use the M button to scroll through your entry and check it.

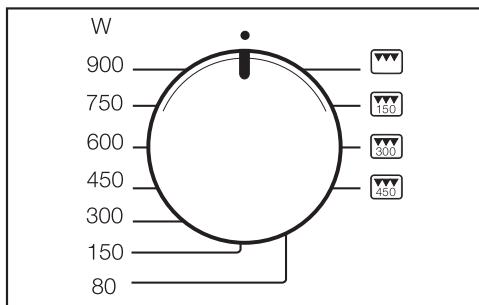

- When you have finished programming, turn the power selector to the 12 o'clock position.

- Start the programme to save the entry, however, only ever run the entire programme with food in the appliance.

 Damage due to operation without food.

The microwave oven can be damaged if it is used without food being placed in it.

If there is no food in the appliance, press the Stop/C button twice as soon as you have started the programme.

1 and 2-step programme sequences can be saved in the same way. The programming process is finished when the power selector is turned to the 12 o'clock position and the Start button is pressed. Pressing the M button shows the next stage.

Changing an entry

- Entering a new programme overrides the previously saved programme.

To call up your favourite programme

- Turn the power selector to the 12 o'clock position.
- Press the M button.
- Press the Start button.

In the event of a power cut, the favourite programme is no longer saved and must be re-entered.

Changing settings

You can select an alternative for some settings of your appliance.

Please consult the chart for the individual settings that can be changed. The factory settings are marked with an asterisk * in the chart.

To change a setting, proceed as follows:

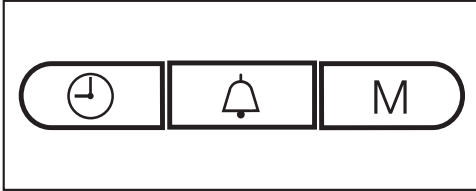

- Press and hold the ⌚ and M buttons at the same time until *P I* and *☰* light up in the display. Then release them. If you press them for too long, the time of day will appear again in the display.
- Use the time selector to select the setting you wish to change (*P I* to *P 5* and *P 0*). Turn it until the setting required shows in the display.

- Then press the M button to call up the setting.

5 will appear in the display to show that the setting can be changed.

- Turn the time selector if you wish to change the setting (see chart) and confirm your entry by pressing the M button (for *P 5* and *P 0*, press and hold the M button for approx. 4 seconds).

The change to the setting is then stored in memory. *P* will appear in the display again together with the number for the setting.

The other settings can be changed in the same way.

- When you have finished making the changes you require, press the Stop/C button.

The altered settings are retained after a power cut.

Changing settings

Setting		Settings available (* factory default)	
<i>P1</i>	Night time switch-off	<i>5 0*</i>	Night time switch-off is deactivated.
		<i>5 1</i>	Night time switch-off is activated. The time of day display is switched off between the hours of 11:00 pm and 4:00 am.
<i>P2</i>	Automatic keeping warm function	<i>5 1*</i>	The automatic keeping warm function is activated.
		<i>5 0</i>	The automatic keeping warm function is deactivated.
<i>P3</i>	“door” message	<i>5 1*</i>	The “door” message appears if the door has not been opened for about 20 minutes. Start is blocked.
		<i>5 0</i>	The “door” message does not appear.
<i>P4</i>	Reminder tone	<i>5 1*</i>	The reminder tone sounds briefly every 5 minutes in the first 20 minutes after the end of the programme.
		<i>5 0</i>	Reminder tone is deactivated.
<i>P5</i>	Demo mode (for showroom use only)	<i>5 0*</i>	Demo mode is deactivated. When demo mode is deactivated, <code>____</code> appears briefly in the display.
		<i>5 1</i>	Demo mode is activated. When a button or selector is operated, <code>DES_</code> appears briefly in the display. The appliance cannot be operated.
<i>P6</i>	Unit of weight	<i>5 0*</i>	Food weight is displayed in grams (g).
		<i>5 1</i>	Food weight is displayed in pounds (lb).
<i>P0</i>	Factory default settings	<i>5 1*</i>	Factory default settings have been restored, or have not been changed.
		<i>5 0</i>	Factory default settings have been changed.

Reheating

Select the following microwave power levels to reheat food:

Drinks	900 W
Food	600 W
Food for babies and children	450 W

 Risk of burning due to hot food. Food for babies and children must not be too hot. Reheat it for only 1/2 to 1 minute at 450 W.

Tips on reheating

 Risk of explosion due to pressure build-up. Pressure can build up when reheating food or drinks in sealed containers, jars or bottles, which can cause them to explode. Sealed glass containers, such as jars of baby food, must be opened before they are placed in the microwave. Do not attempt to heat them up unopened. With baby bottles, the screw top and teat must be taken off.

 Risk of injury from boiling liquids. When heating liquids, milk, sauces etc. using microwave power, the boiling point of the liquid may be reached without the production of the typical bubbles. Liquids do not boil evenly throughout. This so-called 'boiling delay' can cause a sudden build-up of bubbles when the container is removed from the oven or shaken, which can lead to the liquid boiling over suddenly and explosively. The formation of bubbles can be so strong that the pressure forces the oven door open. Flash boiling can be avoided by stirring liquids before heating them. After heating, wait at least 20 seconds before removing the container from the oven. In addition, a glass rod or similar item, if available, can be placed in the container during heating.

Eggs can explode. Never reheat hard boiled eggs in the microwave, even without the shell.

Always ensure that food is sufficiently cooked or reheated.

If in any doubt that a sufficiently high temperature has been reached, continue reheating for a little longer. Stir or turn larger amounts of food from time to time during reheating. Stir the food from the outside towards the middle, as food heats more quickly around the outside.

After reheating

Be careful when removing the dish from the oven. It may be hot.

Although heat is not normally produced in the container itself by the microwaves (apart from stoneware), heat transfer from the food to the container may be considerable, making the container itself hot.

Allow food to stand for a few minutes at room temperature at the end of cooking. This enables the heat to spread evenly through the food.

 Risk of burning due to hot food.

The food can be very hot after reheating.

After reheating food, especially food for babies and small children, stir the food or shake the container and check that the temperature does not pose any danger.

Cooking

Place the food in a microwave-proof dish and cover it.

When cooking, it is a good idea to select a power level of 900 W to start with, and when the food is hot reduce the power level to 450 W for more gentle continued cooking.

For dishes such as **rice pudding** or **semolina pudding**, first select a power level of 900 W, and then reduce it to 150 W for simmering.

Tips on cooking

Vegetable cooking durations depend on the texture of the vegetables. Fresh vegetables contain more water than vegetables which have been stored, and usually cook more quickly. Add a little water to vegetables which have been kept stored.

Food taken straight from the refrigerator takes longer to cook than food which has been kept at room temperature.

 Health risk due to cooking time being too short.

It is very important to make sure that food which goes off easily, such as fish, is cooked for a sufficient time. When cooking these types of food, ensure that the stated cooking durations are observed.

Food with a thick skin or peel, such as tomatoes, sausages, jacket potatoes and aubergines, should be pierced or the skin scored in several places before cooking to allow steam to escape and to prevent the food from bursting.

 Risk of injury from eggs with shells.

Eggs heated in their shells can burst, even after they have been taken out of the oven.

Eggs can only be cooked in their shells in the microwave oven in a specially designed egg-boiling device available from specialist shops.

 Risk of burning from eggs without shells.

If you cook eggs without their shells using microwave power, the yolks could explode due to the resulting pressure.

Eggs can be cooked without their shells in the microwave oven only if the yolk membrane has been punctured several times first.

After cooking

Be careful when removing the dish from the oven. It may be hot.

Although heat is not normally produced in the container itself by the microwaves (apart from stoneware), heat transfer from the food to the container may be considerable, making the container itself hot.

Allow food to stand for a few minutes at room temperature at the end of cooking. This enables the heat to spread evenly through the food.

Defrosting

 Health risk due to refreezing.

Thawed or defrosted food loses nutritional value through refreezing and can go off.

Do not refreeze food once it has thawed. Use it as quickly as possible. Defrosted food may only be refrozen after it has been cooked.

- 80 W
for defrosting very delicate food, e.g. cream, butter, gateau and cheese.
- 150 W
for defrosting other types of food.

Remove the food from its packaging and place in a microwave-proof container. Defrost uncovered. Turn, stir or separate the food about halfway through the defrosting time.

 Health risk due to risk of salmonella.

It is particularly important to observe food hygiene rules when defrosting poultry.

Do not use the liquid produced during defrosting.

Meat and poultry need to be fully defrosted before cooking.

Fish, on the other hand, can be partially defrosted before cooking. Defrost so that the surface is sufficiently soft to take herbs and seasoning.

Defrosting and cooking

Deep-frozen food can be defrosted and immediately heated or cooked.

First select 900 W followed by 450 W.

Remove the food from its packaging and place in a covered microwave-proof dish for defrosting and reheating or cooking. Exception: Minced meat should be left uncovered while cooking.

Food with a high water content such as soup, stew and vegetables should be stirred several times during the process. Carefully separate and turn slices of meat halfway through the programme. Turn pieces of fish at the halfway stage.

After defrosting and reheating or cooking allow the food to stand at room temperature for a few minutes to enable the heat to spread evenly through the food.

You can preserve small portions of fruit, vegetables and meat in microwave-safe jars that are available from specialist retailers. Prepare the jars in the usual way.

Fill the jars no more than up to 2 cm below the rim.

Seal the microwave-safe preserving jars with clear adhesive tape or clips suitable for microwave use.

Never use metal clips, jars with screw-on lids or cans in order to prevent sparking.

For best results do not use more than four $\frac{1}{2}$ - litre jars at a time when bottling.

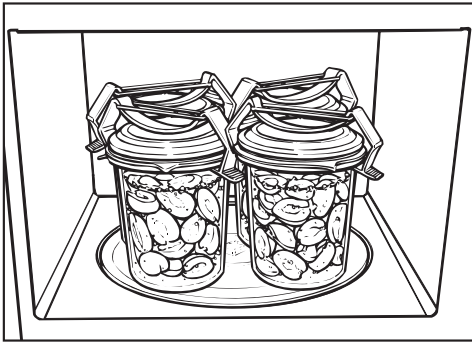

- Place the jars on the turntable.
- Set to 900 W and bring the jar contents to the boil.
 - the initial temperature of the contents.
 - the number of jars.

The amount of time required for the contents in all jars to start bubbling evenly is as follows:

1 jar	approx. 3 minutes
2 jars	approx. 6 minutes
3 jars	approx. 9 minutes
4 jars	approx. 12 minutes

This is sufficient time for bottling fruit and cucumbers.

- carrots for approx. 15 minutes
- peas for approx. 25 minutes.

After bottling

Remove jars from the oven, cover with a towel and leave to stand in a draught-free location for approx. 24 hours.

Remove the clips or the adhesive tape and make sure that all jars are sealed properly.

Examples of use

Food	Quantity	MW power level (W)	Duration (in minutes)	Notes
Melting butter/margarine	100 g	450	1:00 – 1:10	Do not cover
Melting chocolate	100 g	450	3:00 – 3:30	Do not cover, stir halfway through melting
Dissolving gelatine	1 packet + 4 tbsp. water	450	00:10 – 00:30	Do not cover, stir halfway through dissolving
Preparing flan topping/jelly glaze	1 packet + 250 ml liquid	450	4 – 5	Do not cover, stir halfway through heating
Yeast dough	Starter dough made with 100 g flour	80	3 – 5	Cover and leave to prove
Making popcorn	1 tbsp. (20 g) popcorn	900	3 – 4	Place popcorn in a 1 litre container, cover and cook, sprinkle with sugar or salt after cooking
Chocolate marshmallows	20 g	600	00:10 – 00:20	Place on a plate, do not cover
Steeping oil for salad dressing	125ml	150	1 – 2	Heat uncovered on gentle heat
Tempering citrus fruits	150 g	150	1 – 2	Place on a plate, do not cover
Cooking bacon	100 g	900	2 – 3	Place on kitchen paper, do not cover
Softening ice cream	500 g	150	2	Place open container in the appliance
Skinning tomatoes	3 tomatoes	450	6 – 7	Cut a cross into the top of each tomato, cover, and heat in a little water. The skins will slip off easily. Take care, as the tomatoes can get very hot.
Making strawberry jam	300 g strawberries, 300 g jam sugar	900	7 – 9	Mix the fruit and sugar in a deep container, cover and cook.
Defrosting and baking part-baked bread rolls	2 rolls	150+Grill Grill	1 – 2 4 – 6	Place uncovered on the rack, turning halfway through.

The information given in this chart is intended only as a guide.

To help prevent re-soiling, a conditioning agent for stainless steel can be used (available from Miele or the Miele online shop at shop.miele.com). Use a soft cloth to apply sparingly with an even pressure.

Disconnect the microwave oven from the power supply before cleaning.

Under no circumstances should a steam cleaner be used to clean the microwave oven. The steam could reach live electrical components and cause a short circuit.

Housing, oven interior and inside of the door

 Risk of burning due to hot oven compartment. The oven compartment may be too hot to clean immediately after use. Clean the oven interior once it has cooled down.

 Fire hazard due to excessive soiling. Excessive soiling could damage the appliance in certain circumstances and could even be dangerous due to the fire risk. Do not wait too long to clean the appliance as this will make cleaning unnecessarily difficult and in extreme cases, impossible.

The microwave oven interior and door interior can be cleaned using a damp cloth with a little washing-up liquid or a mild detergent and water. Wipe dry with a soft cloth.

For more heavy soiling, heat a glass of water for 2 to 3 minutes until the water begins to boil. The steam will collect on the walls and soften the soiling. The oven interior can now be wiped clean using a little washing-up liquid if necessary.

Stainless steel surfaces can be cleaned with a stainless steel cleaner (available from Miele).

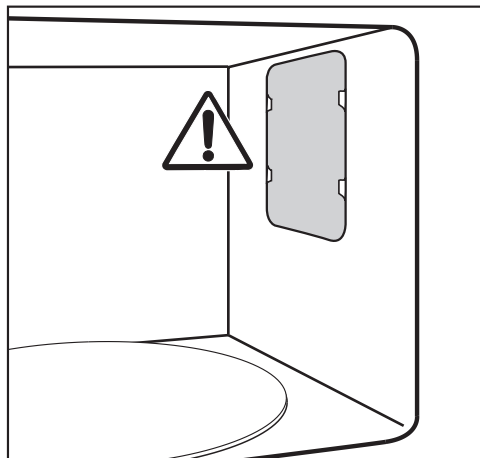

Do not remove the cover of the microwave outlet inside the oven, nor the film covering the inside of the door.

Do not let water or any object find its way into or block the air vents of the appliance. Do not use too much water on the cloth or sponge, otherwise water may get into openings. Do not use scouring agents. These will scratch.

To neutralise odours in the microwave oven, put a cup of water with some lemon juice in the appliance and simmer for a few minutes.

Cleaning and care

⚠ Danger to health due to a defective device.

If any damage to the door or the door seals is noticed, the appliance must not be used until the fault has been repaired by a Miele authorised service technician. Operating a damaged appliance can result in microwave leakage and present a hazard to the user.

The door should be kept clean at all times and checked at regular intervals for any signs of damage. Do not use the appliance if

- the appliance door is warped.
- the door hinges are loose.
- holes or cracks are visible in the casing, the door or the oven interior walls.

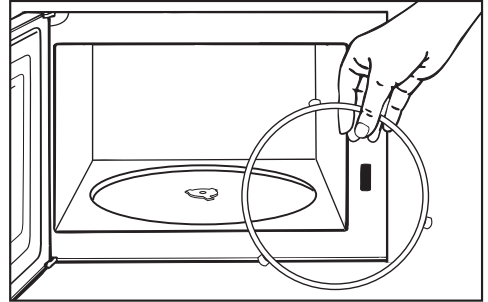

- Always keep the roller ring underneath it and the oven floor clean. Otherwise the turntable will not turn smoothly.
- Clean the area between the turntable and the roller ring.

Do not turn the turntable and/or carrier manually, as this could damage the drive motor.

To clean the interior:

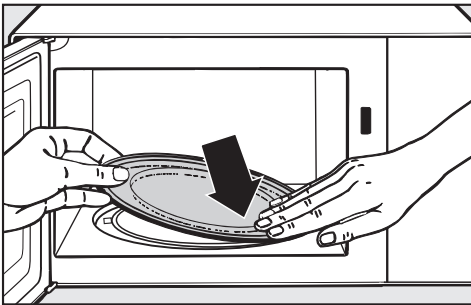

- Remove the turntable, and wash in the dishwasher or by hand.

Appliance front

Soiling that is left too long might become impossible to remove and could cause external surfaces to alter or discolour.

Remove any soiling on the front of the appliance straight away.

All surfaces of this appliance are susceptible to scratching. Scratches on glass surfaces could cause a breakage in certain circumstances. Contact with unsuitable cleaning agents can alter or discolour all surfaces.

Please observe the following cleaning instructions.

To avoid damaging the surfaces of the appliance, do not use:

- cleaning agents containing soda, ammonia, acids or chlorides
- cleaning agents containing descaling agents
- abrasive cleaning agents, e.g. powder cleaners and cream cleaners
- solvent-based cleaning agents
- stainless steel cleaning agents
- dishwasher cleaner
- oven sprays
- glass cleaning agents
- hard, abrasive sponges and brushes, e.g. pot scourers
- dirt erasers
- sharp metal scrapers.

Accessories supplied

Rack

Wash and dry the rack after each use. It is dishwasher-proof. Remove stubborn soiling with a stainless steel cleaner.

Gourmet plate

Do not use steel wool, abrasive sponges, or aggressive cleaning agents.

Do not clean the gourmet plate in the dishwasher.

If the gourmet plate has been used to cook food with a strong aroma, you can neutralise any odours by adding some water and lemon juice to the gourmet plate and heating it in the microwave oven at maximum power for 2-3 minutes. Rinse the gourmet plate afterwards with clean water.

Problem solving guide

Many malfunctions and minor faults that can occur in daily operation can be corrected without contacting Miele. This will save you time and money because you will not need a service call.

You can find information on how to remedy faults yourself at www.miele.com.au/service or www.miele.co.nz/service and on the Miele website. Please note, however, that a call-out charge will be applied to unnecessary service visits where the problem could have been rectified as described in these operating instructions.

Problem	Possible cause and remedy
A programme will not start.	Check whether <ul style="list-style-type: none"> ■ the appliance door is closed properly. ■ the system lock has been activated (see “System lock”). ■ “door” has appeared in the display. The door has remained closed for 20 minutes or longer after the last cooking process (see “Operation - door message”). ■ the appliance is plugged into the mains supply and switched on at the socket. ■ the mains circuit breaker has tripped. If it has, there could be a fault with the appliance, the household electricity supply or another appliance (disconnect the appliance from the electricity supply and contact a qualified electrician or Miele, see “After sales service”).
A noise can be heard after a cooking process.	This is not a fault. The cooling fan will continue to run for a while after a cooking programme to prevent any humidity building up in the oven, on the control panel or the oven housing unit. It will switch off automatically.
The display is dark.	The time of day display has been switched off. <ul style="list-style-type: none"> ■ Press and hold the  button for several seconds.
	Night time switch-off is activated. <ul style="list-style-type: none"> ■ Deactivate it.
The turntable does not turn smoothly.	The area underneath the turntable could be dirty. <ul style="list-style-type: none"> ■ Check whether the oven floor underneath the turntable is clean. ■ Check whether the surfaces between the turntable and the roller ring are clean. ■ Clean the area underneath the turntable.
Food is not adequately defrosted, heated or cooked at the end of the selected cooking duration.	The duration or power level were insufficient to cook the food. <ul style="list-style-type: none"> ■ Check whether the correct power level was selected for the duration set. The lower the power level, the longer the duration required. ■ Check whether the programme has been interrupted and not restarted.

Problem solving guide

Problem	Possible cause and remedy
The microwave operation works but not the lighting.	<p>The lamp needs to be replaced. You can operate the appliance as normal, but without the lighting.</p> <ul style="list-style-type: none"> ■ Contact Miele if you need to replace the lamp.
Strange noises are heard when the microwave oven is being used.	<p>The food is covered with aluminium foil.</p> <ul style="list-style-type: none"> ■ Remove the aluminium foil.
	<p>Sparks are being created by the use of crockery with a metallic finish.</p> <ul style="list-style-type: none"> ■ Please observe the information on suitable containers for microwave use.
The time of day in the display is not accurate.	<p>If there has been a power cut, the time automatically switches back to 12:00. The time of day needs to be reset.</p> <ul style="list-style-type: none"> ■ Set the correct time of day.
Food cools down too quickly.	<p>In a microwave oven, food begins to cook from the outside first, the inside of the food relying on the slower conduction of heat. If food is cooked at a high power level, it is possible that the heat may not have reached the centre of the food, so it is hot on the outside but cold in the centre. During standing time heat is transferred to the centre of the food.</p> <ul style="list-style-type: none"> ■ This may leave the food warm in the middle but cool on the outside. When reheating food with different densities, such as plated meals, it is therefore recommended to select a lower power level and lengthen the duration.
The microwave oven switches itself off during a cooking, reheating or defrosting programme.	<p>There may be insufficient air circulation.</p> <ul style="list-style-type: none"> ■ Check whether the air inlet or outlet is blocked. Remove any obstruction.
	<p>The appliance switches off automatically in cases of overheating.</p> <ul style="list-style-type: none"> ■ Cooking can be continued after a cooling-down period.
	<p>If the appliance keeps switching itself off</p> <ul style="list-style-type: none"> ■ Contact Miele.

Service

You can find information on how to remedy faults yourself and about Miele spare parts at www.miele.com.au/service or www.miele.co.nz/service.

Contact in case of fault

You can book a Miele customer service call-out online at www.miele.com.au/service or www.miele.co.nz/service.

Contact information for Miele can be found at the end of this booklet.

Please quote the model and serial number of your appliance when contacting Miele. This information can be found on the data plate.

Warranty

The manufacturer's warranty for this appliance is 2 years.

For further information, please refer to your warranty booklet.

Miele Australia Pty. Ltd.

ACN 005 635 398

ABN 96 005 635 398

Level 4, 141 Camberwell Road
Hawthorn East, VIC 3123

1300 464 353 (1300 4 MIELE)

info@miele.com.au

www.miele.com.au

Miele New Zealand Limited

IRD 98 463 631

8 College Hill
Freemans Bay, Auckland 1011

0800 464 353 (0800 4 MIELE)

customercare@miele.co.nz

www.miele.co.nz

Miele Global Headquarters

Germany

Miele & Cie. KG

Carl-Miele-Straße 29

33332 Gütersloh

Federal Republic of Germany

M 6012 SC

en-AU, NZ

M.-Nr. 11 356 770 / 09