

## Operating and installation instructions Cooker hood



To prevent the risk of accidents or damage to the appliance, it is **essential** to read these instructions before it is installed and used for the first time.

# Contents

---

<b>Warning and Safety instructions</b> .....	<b>4</b>
<b>Caring for the environment</b> .....	<b>13</b>
<b>Guide to the cooker hood</b> .....	<b>14</b>
<b>Modes of operation</b> .....	<b>16</b>
<b>Before using for the first time</b> .....	<b>17</b>
Selecting extraction mode or recirculation mode .....	17
Setting up Miele@home .....	17
Connecting via the app .....	18
Connecting via WPS .....	19
Sign out of WiFi (reset to factory settings) .....	20
Setting up Con@ctivity .....	21
Con@ctivity via the home WiFi network (Con@ctivity 3.0) .....	22
Con@ctivity via a direct WiFi connection (Con@ctivity 3.0) .....	22
Reattempting the connection .....	22
<b>Operation (Automatic mode)</b> .....	<b>23</b>
Cooking with Con@ctivity (Automatic mode) .....	23
Cooking process .....	23
Leaving automatic mode temporarily .....	24
Returning to automatic mode .....	24
<b>Operation (Manual mode)</b> .....	<b>25</b>
Cooking without Con@ctivity (Manual mode) .....	25
Switching the fan on .....	25
Selecting the power level .....	25
Selecting the run-on time .....	25
Switching the fan off .....	25
Dimming/switching the hob lighting on/off .....	26
Power management .....	26
Safety switch-off .....	26
<b>Operation (Automatic and Manual modes)</b> .....	<b>27</b>
Operating hours counter .....	27
Altering the operating hours counter for the grease filter(s) .....	27
Altering or deactivating the charcoal filter operating hours counter .....	28
Reading the filter operating hours counter .....	28
<b>Energy saving tips</b> .....	<b>29</b>
<b>Cleaning and care</b> .....	<b>30</b>
Housing .....	30
Important information for appliances with lacquered casing .....	30
Grease filters .....	31
Replacing the grease filters .....	32

---

Charcoal filter.....	33
Resetting the charcoal filter operating hours counter.....	33
Disposing of charcoal filters.....	33
Reactivatable charcoal filter.....	33
<b>Installation.....</b>	<b>34</b>
Before installation.....	34
Protective foil.....	34
Installation materials.....	34
Appliance dimensions.....	36
Safety distance between hob and cooker hood (S).....	37
Installation recommendations.....	38
Drilling diagram for wall mounting.....	38
Connection for air extraction.....	39
Non-return flap.....	40
Condensation.....	40
Silencer.....	41
Electrical connection.....	42
<b>Service.....</b>	<b>43</b>
Contact in the event of a fault.....	43
Position of the data plate.....	43
Warranty.....	43
<b>Technical data.....</b>	<b>44</b>
Special accessories for recirculation mode.....	44
EU Conformity declaration.....	45
UK Conformity declaration.....	45

## Warning and Safety instructions

---

This cooker hood complies with all relevant local and national safety requirements. Inappropriate use can, however, lead to personal injury and material damage.

Read the operating and installation instructions carefully before using the cooker hood. They contain important information on its safety, installation, use and maintenance. This prevents both personal injury and damage to the cooker hood.

In accordance with standard IEC 60335-1, Miele expressly and strongly advises that you read and follow the instructions in the chapter on installing the appliance as well as the safety instructions and warnings.

Miele cannot be held liable for injury or damage caused by non-compliance with these instructions.

Keep these instructions in a safe place and pass them on to any future owner.

### Correct application

- ▶ This cooker hood is intended for use in domestic households and similar working and residential environments.
- ▶ The cooker hood is not intended for outdoor use.
- ▶ It must only be used as a domestic appliance to extract vapours and remove odours from cooking. Any other usage is not supported by the manufacturer and could be dangerous.
- ▶ Where a recirculation cooker hood is fitted above a gas hob, please ensure that there is an adequate supply of fresh air into the room in which it is installed. Please seek the advice of a qualified gas fitter (e.g. GasSafe in the UK) for more information if necessary.

## Warning and Safety instructions

---

▶ The cooker hood can only be used by people with reduced physical, sensory or mental capabilities, or lack of experience and knowledge, if they are supervised whilst using it, or have been shown how to use it in a safe way and recognise and understand the consequences of incorrect operation.

### Safety with children

▶ Children under 8 years of age must be kept away from the cooker hood unless they are constantly supervised.

▶ Children aged 8 and older may only use the cooker hood without supervision if they have been shown how to use it and are able to do so in a safe manner. Children must be able to understand and recognise the possible dangers caused by incorrect operation.

▶ Children must not be allowed to clean or maintain the cooker hood unsupervised.

▶ Please supervise children in the vicinity of the cooker hood and do not let them play with it.

▶ The hob lighting is very intensive.

Ensure, in particular, that babies/small children do not look at the light.

▶ Danger of suffocation! Whilst playing, children may become entangled in packaging material (such as plastic wrapping) or pull it over their head with the risk of suffocation. Keep packaging material away from children.

# Warning and Safety instructions

---

## Technical safety

- ▶ Unauthorised installation, maintenance and repairs can cause considerable danger for the user. Installation, maintenance and repairs must only be carried out by a Miele authorised technician.
- ▶ A damaged appliance can be dangerous. Check it for visible signs of damage. Do not use a damaged appliance.
- ▶ The electrical safety of this appliance can only be guaranteed when correctly earthed. It is essential that this standard safety requirement is met. If in any doubt please have the electrical installation tested by a qualified electrician.
- ▶ Temporary or permanent operation on an autonomous power supply system or a power supply system that is not synchronised with the mains power supply (e.g. island networks, back-up systems) is possible. A prerequisite for operation is that the power supply system complies with the specifications of EN 50160 or an equivalent standard.

The function and operation of the protective measures provided in the domestic electrical installation and in this Miele product must also be maintained in isolated operation or in operation that is not synchronised with the mains power supply, or these measures must be replaced by equivalent measures in the installation. As described, for example, in the current version of BS OHSAS 18001–2 ISO 45001.
- ▶ The connection data (voltage and frequency) on the data plate of the cooker hood must match the mains electricity supply in order to avoid the risk of damage to the cooker hood  
Compare this before connecting the appliance to the mains. Consult a qualified electrician if in any doubt.
- ▶ Do not connect the appliance to the mains electricity supply by a multi-socket unit or an extension lead. These are a fire hazard and do not guarantee the required safety of the appliance.
- ▶ For safety reasons, this appliance may only be used after it has been built in.
- ▶ The cooker hood must not be used in a non-stationary location (e.g. on a ship).

## Warning and Safety instructions

---

- ▶ Touching electrical components and tampering with electrical and mechanical parts is highly dangerous to the user and can cause operational faults.  
Only open the housing as described in the instructions given in the installation sheet and in the Cleaning and care section of this booklet. Under no circumstances should any other parts of the housing be opened.
- ▶ The manufacturer's warranty will be invalidated if the appliance is not repaired by a Miele authorised technician.
- ▶ If the electrical connection cable is faulty it must only be replaced by a Miele authorised technician to protect the user from danger.
- ▶ The lamps are a built-in component of the lighting. Replacement lamps may only be fitted by a Miele authorised technician or by the Miele Customer Service Department.
- ▶ During installation, maintenance and repair work, the appliance must be disconnected from the mains electricity supply.

# Warning and Safety instructions

Using at the same time as another heating appliance that depends on the air from the room

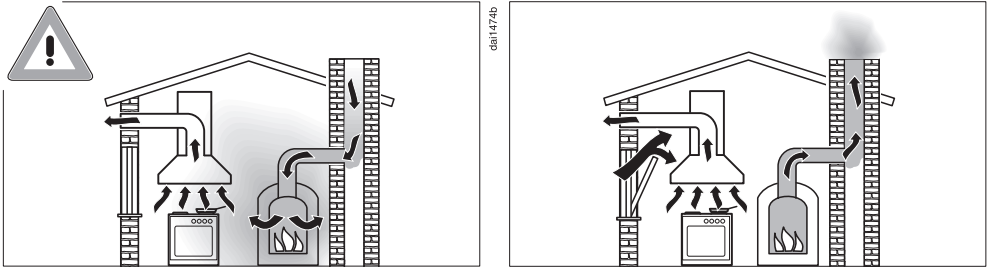

## Danger of toxic fumes!

Great care should be taken when using the cooker hood in the same room or the same area of the house at the same time as another heating appliance that depends on the air from the room. Such heating appliances draw in air from the room and duct exhaust gases out through a chimney or extraction ducting. They include gas, oil, wood and coal-fired boilers and heaters, continuous flow or other water heaters, gas hobs and ovens.

The cooker hood draws in air from the kitchen and from neighbouring rooms. This applies to the following modes of operation:

- Extraction mode
- Recirculation mode with a recirculation box installed outside the room.

If there is insufficient air, negative pressure will occur. The heating appliance may be starved of oxygen. This impairs combustion. Harmful gases could be drawn from the chimney or extraction ducting back into the room.

Risk of death!



## Warning and Safety instructions

---

In order to ensure safe operation and to prevent gases given off by the heating appliance from being drawn back into the room when the cooker hood and the heater are both operated simultaneously, an underpressure in the room of 0.04 mbar (4 Pa) is the maximum permissible.

Sufficient ventilation can be maintained by air inlets which cannot be blocked, e.g. in windows, doors and outside wall vents. The cross-section of the inlet openings must enable sufficient ventilation. A ventilation brick alone is not generally sufficient to ensure safe ventilation.

The overall ventilation condition of the dwelling must be taken into account. If in any doubt, ask a competent building regulations inspector or qualified gas fitter (if appropriate).

If the cooker hood is being operated in recirculation mode, whereby the air is redirected into the room in which it is installed, the above restrictions do not apply.

# Warning and Safety instructions

---

## Correct use

▶ Open flames are a fire hazard.

The use of an open flame under the cooker hood is not permitted. To avoid the danger of fire, do not flambé or grill over an open flame.

When switched on, the cooker hood could draw flames into the filter. Fat deposits could ignite, presenting a fire hazard.

▶ The cooker hood can become damaged when exposed to excessive heat.

- When using the cooker hood over a gas hob, ensure that any burners in use are always covered by a pan. Switch the cooking zone off when a pan is removed, even for a short time.
- Select a pan which is suitable for the size of the burner.
- Regulate the flame so that it does not burn up the sides of the pan.
- Avoid overheating the pan (e.g. when cooking with a wok).

▶ Always switch the cooker hood on when a cooking zone is in use, otherwise condensation may collect in the hood, which could cause corrosion.

▶ Overheated oil and fat can ignite, causing fire damage to the cooker hood.

When cooking with oil or fat, chip pans and deep fat fryers, etc, do not leave the pans unattended. Similarly, never leave an open grill unattended when grilling.

## Warning and Safety instructions

---

- ▶ Do not use the cooker hood without the filters in place. This way you will avoid the risk of grease and dirt getting into the appliance and hindering its smooth operation.
- ▶ The cooker hood can get very hot during cooking due to heat rising from the hob.  
Do not touch the housing or the grease filters until the cooker hood has cooled down.
- ▶ This cooker hood is not suitable for placing objects on.

### Proper installation

- ▶ To determine whether a cooker hood may be operated above your cooking appliance, please refer to the information provided by the appliance's manufacturer.
- ▶ Safety regulations prohibit the fitting of a cooker hood over solid fuel stoves.
- ▶ An insufficient safety distance between the hob and the cooker hood can result in damage to the cooker hood.  
The minimum safety distances between the top of the hob and the bottom of the cooker hood given in the "Installation" section of this manual must be observed, unless the hob manufacturer states that a greater safety distance is required.  
If more than one cooking appliance is fitted beneath the cooker hood, and they have different minimum safety distances to the cooker hood, select the greater distance.
- ▶ The information provided in "Installation" must be observed when fixing the ventilation hood.
- ▶ Components can have sharp edges which may cause injury.  
Wear gloves to protect your hands from being cut.
- ▶ Exhaust ducting must be of non-inflammable material. Suitable material is available from Miele specialist dealers or the Miele Spares Dept.
- ▶ The appliance must not be connected to a chimney or flue which is in use. Neither should it be connected to ducting which ventilates rooms with fireplaces.
- ▶ If exhaust air is to be extracted into a chimney or ventilation duct no longer used for other purposes, seek professional advice.

# Warning and Safety instructions

---

## Cleaning and care

- ▶ There is a risk of fire if the cooker hood is not cleaned as described in these operating instructions.
- ▶ Do not use a steam cleaning appliance to clean this appliance. The steam could reach electrical components and cause a short circuit.

## Accessories and spare parts

- ▶ Only use genuine original Miele accessories and spare parts with this appliance. Using accessories or spare parts from other manufacturers will invalidate the warranty and Miele cannot accept liability.
- ▶ Miele can only guarantee the safety of the appliance when genuine original Miele replacement parts are used. Faulty components must only be replaced by Miele spare parts.
- ▶ Miele will guarantee to supply functional spare parts for a minimum of 10 years and up to 15 years following the discontinuation of your vapour extraction unit.

### Disposing of the packaging material

The packaging material is used for handling and protects the appliance from transport damage. The packaging material used is selected from materials which are environmentally friendly for disposal and can generally be recycled.

Recycling the packaging material reduces the use of raw materials. Use material-specific collection points for valuable materials and take advantage of return options. Your Miele dealer will take the packaging material away.

### Disposing of your old appliance

Electrical and electronic appliances contain many valuable materials. They also contain certain materials, compounds and components which were essential for their correct functioning and safety. These could be hazardous to human health and to the environment if disposed of with household waste or if handled incorrectly. Please do not, therefore, dispose of your old appliance with household waste.



Instead, please make use of officially designated collection and disposal points to dispose of and recycle electrical and electronic appliances in your local community, with your dealer or with Miele, free of charge. By law, you are solely responsible for deleting any personal data from the old appliance prior to disposal. You are legally obliged to remove any old batteries which are not securely enclosed by the appliance and to remove any lamps without destroying them, where this is possible. These must be taken to a suitable collection point where they can be handed in free of charge. Please ensure that your old appliance poses no risk to children while being stored for disposal.

# Guide to the cooker hood

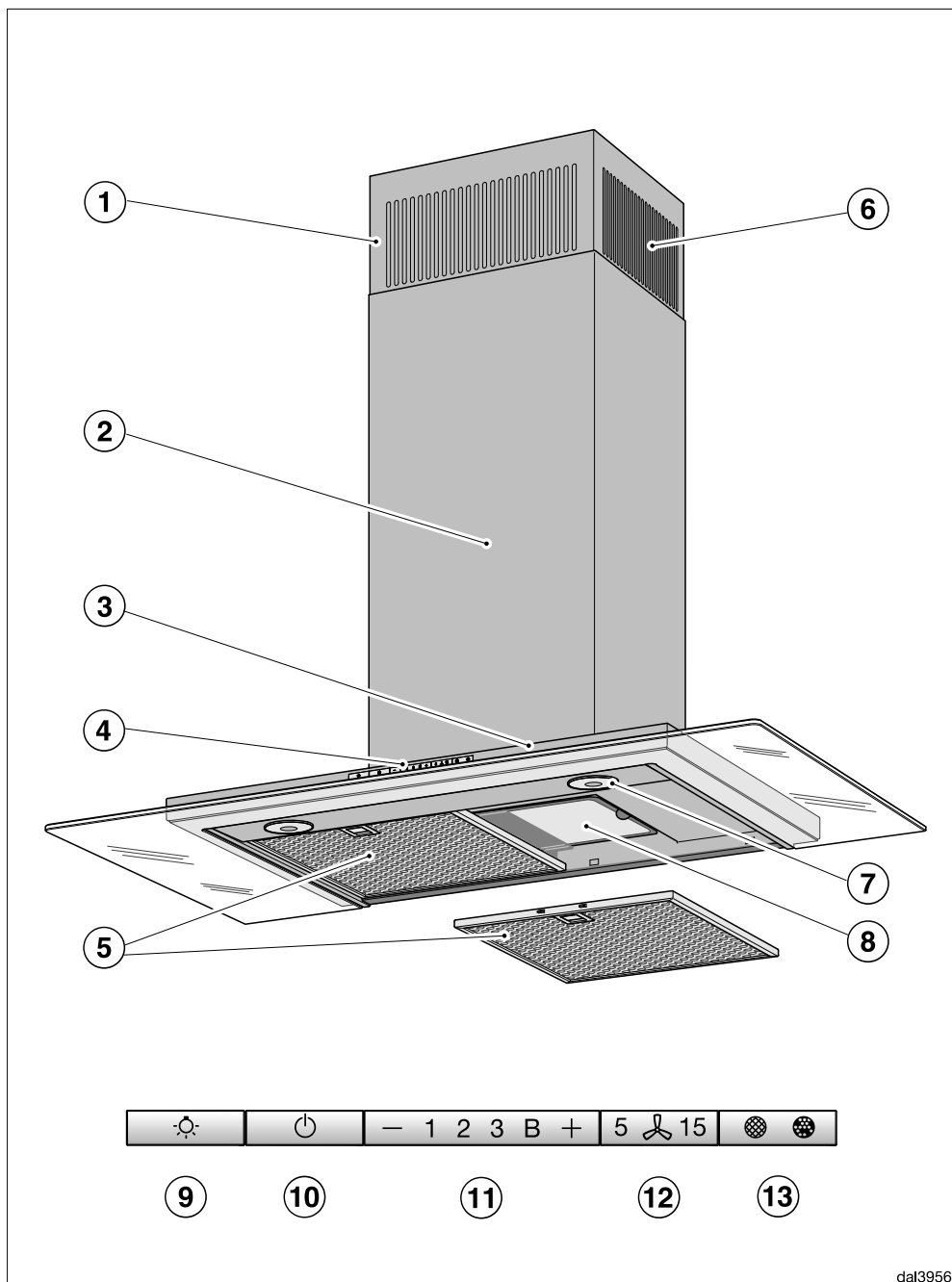

- ① Telescopic extension piece
- ② Tower
- ③ Canopy
- ④ Control elements
- ⑤ Grease filters
- ⑥ Recirculation grille  
Only for recirculation mode
- ⑦ Hob lighting
- ⑧ Charcoal filter  
Disposable or reactivatable charcoal filter  
Optional accessory for recirculation mode
- ⑨ Control for switching the lighting on and off and for dimming the lighting
- ⑩ Control for switching the fan on and off
- ⑪ Controls for setting the fan power level
- ⑫ Control for the run-on function
- ⑬ Control for the operating hours counter

# Modes of operation

---

Depending on the model of the cooker hood, the following options are available:

## Extraction mode



The air is drawn in and cleaned by the grease filters and directed outside.

## Recirculation mode

(recirculation mode cooker hoods require a conversion kit and charcoal filter, see “Technical Data”)



The air is drawn in and cleaned first by the grease filters and then by a charcoal filter. The cleaned air is then recirculated back into the kitchen.

clh001941a



clh001941b





## Selecting extraction mode or recirculation mode

The cooker hood is suitable for both extraction mode and recirculation mode. The power of the fan is adapted to suit the selected operating mode. The cooker hood is delivered set up for recirculation mode. It has to be reset for extraction mode.

To reset it for extraction mode, the operating hours counter for the charcoal filter(s) has to be deactivated.

- Switch off the fan and the lighting.
- Press the + control and the operating hours control   at the same time.

The charcoal filter symbol  and one of the fan power levels will flash.

- Press and hold the + control until the **B** indicator starts to flash.
- Confirm your choice with the operating hours control  .

All the indicator lights will go out.

Extraction mode has now been set.

If you do not confirm your selection within 4 minutes, the cooker hood will automatically revert to the original setting.

## Setting up Miele@home

Requirements:

- A WiFi network
- The Miele app
- A Miele user account. The user account can be created via the Miele app.

Your cooker hood is equipped with an integrated WiFi module. Connect the cooker hood to your household WiFi network. You will then be able to operate the cooker hood via the Miele app.

If your Miele hob is connected to a home WiFi network, you can control the cooker hood automatically via the Con@ctivity function.

Before installing the cooker hood in its final location, ensure that the signal of your WiFi network is strong enough.

You can connect to the household WiFi network via the Miele app or via WPS.

# Before using for the first time

## Miele@home availability

The ability to use the Miele app depends on the availability of the Miele@home service in your country.

The Miele@home service is not available in every country.

For information about availability, please visit [www.miele.com](http://www.miele.com).

## Miele App

The Miele App is available to download free of charge from the Apple App Store® or from the Google Play Store™.



## Connecting via the app

The Miele app can be used to connect to your network.

- Install the Miele app on your mobile device.

For the registration, you will need:

1. Your WiFi network password
2. Your cooker hood password



The password for your cooker hood consists of the last 9 digits of the serial number. This can be found on the appliance's data plate.

The data plate is visible after removing the grease filter(s).



- Start signing the appliance on in the app. Follow the signing-on instructions.

If requested to activate WiFi on the cooker hood, proceed as follows:

# Before using for the first time

- Switch the cooker hood off.



- Press and hold the + control.



- Press the lighting control at the same time .

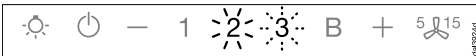

**2** will light up constantly, **3** will flash on and off.

The cooker hood will be ready for connection in the next 10 minutes.



- Follow the instructions in the app.

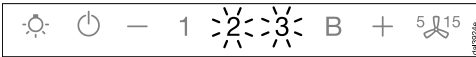

When successfully connected, **2** and **3** will light up constantly.



- Quit connection mode on the cooker hood by pressing the run-on control .

The cooker hood can now be operated via the app.

## Connecting via WPS

Your WiFi router must support WPS (WiFi Protected Setup).

- Switch the cooker hood off.



- Press and hold the + control.



- Press the lighting control at the same time .

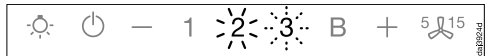

**2** will light up constantly, **3** will flash on and off.

The WiFi connection must be started on the cooker hood at the same time as on the WiFi router.

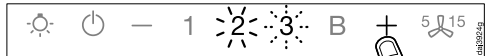

- Press the + control on the cooker hood after a few seconds.

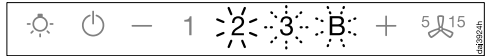

After a short while the **2** will light up constantly, and the **3** and the **B** will flash on and off.

The cooker hood is ready for connection in the next two minutes.

## Before using for the first time



- Start the WiFi connection on your WiFi router.

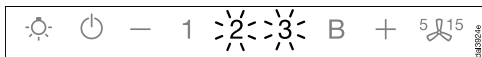

When successfully connected the **2** and **3** will light up constantly.



- Quit connection mode on the cooker hood by pressing the Run-on control .

The cooker hood can now be operated via the app.

If the connection fails, you have probably not connected WPS on your router quickly enough. Repeat the steps above.

**Tip:** If your WiFi router does not support WPS, please connect via the Miele app.

## Sign out of WiFi (reset to factory settings)

To set up a new WiFi connection, the existing WiFi connection must be disconnected.

- Switch the cooker hood off.



- Press and hold the — control.



- Touch the lighting control at the same time .

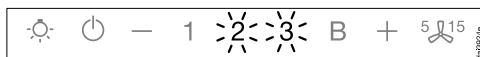

With an existing WiFi connection, **2** and **3** will light up constantly.

The cooker hood will be ready for disconnection in the next 2 minutes.

# Before using for the first time



■ Touch the — control.

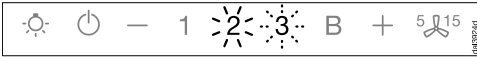

**2** will light up constantly, **3** will flash on and off.

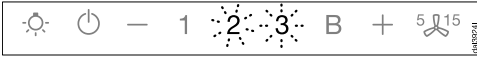

After a few seconds, **2** and **3** will flash on and off. The connection has now been disconnected.



■ Quit signing-off mode on the cooker hood by pressing the run-on control  <sup>5</sup>/<sub>15</sub>.

The WiFi connection has now been disconnected. A new connection can now be set up.

## Setting up Con@ctivity

Con@ctivity is the direct communication system between an electric Miele hob and a Miele cooker hood. It enables the cooker hood to operate automatically depending on the operational state of a Miele hob with onset controls.

- When the hob is switched on, the cooker hood lighting comes on automatically and then after a short time the fan also comes on.
- The cooker hood selects the power level automatically during cooking. The power level selected by the cooker hood depends on the number of cooking zones being used and their power levels.
- After switching the hob off the fan and the hob lighting will switch off automatically after a specified period of time.

See “Operation” for detailed information about this function.

# Before using for the first time

## Con@ctivity via the home WiFi network (Con@ctivity 3.0)

Prerequisite:

- Home WiFi network
- WiFi-enabled Miele hob

- Connect the cooker hood and hob to your home WiFi network (see “Setting up Miele@home”).

The Con@ctivity function will be activated automatically.

## Con@ctivity via a direct WiFi connection (Con@ctivity 3.0)

Prerequisite:

- WiFi enabled Miele hob

If you do not have a home network, you can establish a direct connection between the hob and the cooker hood.

- Switch the cooker hood off.



- Press and hold the + control.



- Press the – control at the same time.

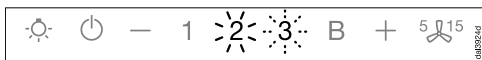

**2** will light up constantly, **3** will flash on and off.

The cooker hood will be ready for connection in the next 2 minutes.

- Start WiFi connection on the hob. For further details, see the hob operating instructions.

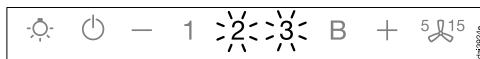

When successfully connected, **2** and **3** will light up constantly.



- Quit connection mode on the cooker hood by pressing the run-on control **5**/**15**.

Con@ctivity has now been activated.

With a direct WiFi connection, it is not possible to connect the hob and the cooker hood to a home network. Should this be required at a later date, the WiFi connection between the hob and the cooker hood must be disconnected (see “Sign out of WiFi”).

## Reattempting the connection

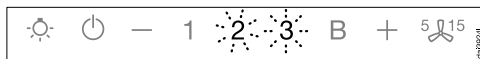

If it is not possible to connect, **2** and **3** flash or the cooker hood cancels the process.

- Disconnect the connection to the cooker hood (see “Signing out of WiFi”) and to the hob.
- Attempt to make the connection again.

When Con@ctivity is active, the cooker hood always operates in automatic mode (see “Before using for the first time” – “Setting up Con@ctivity”).

If you wish to manually operate the cooker hood, see “Operation (Manual mode)” – “Cooking without Con@ctivity”.

## Cooking with Con@ctivity (Automatic mode)

- Switch a cooking zone on at the desired power level.

The hob lighting will come on.

After a few seconds the fan will come on, first at power level **2**, then it will switch immediately to power level **1**.

The cooker hood selects the fan power level automatically during cooking.

This is determined by the total output of the hob, i.e. the number of cooking zones in operation and the power levels selected.

If you select a higher power level or are using several cooking zones, the cooker hood will switch to a higher fan power level.

When you reduce the power level or the number of cooking zones on the hob, the fan power level is also reduced.

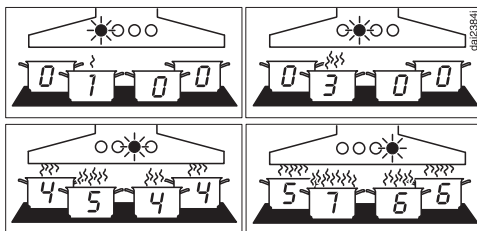

Examples for power levels **1** to **B**

## Reaction time

The cooker hood reacts with a slight delay because altering the power level on the hob does not immediately result in a reduction or increase in cooking vapours.

Because the hob transmits the information to the cooker hood at intervals, this can also cause delays.

The reaction can vary from a few seconds to a couple of minutes.

## Cooking process

- For example, you switch on a cooking zone at the highest power level to heat a pan for frying. You reduce the power level after approx. 10 seconds to 4 minutes (60 seconds to 5 minutes for a HiLight hob).

The cooker hood recognises a cooking process.

The cooker hood switches itself on and when the hob power level has been reduced, the hood switches to fan power level 3 and remains at that level for approx. 5 minutes.

After that, the cooker hood power level is determined automatically by the Con@ctivity function.

You can select another power level manually before then.

# Operation (Automatic mode)

---

## Switching off

- Switch off all cooking zones.

The cooker hood fan will reduce its power level in stages over the next few minutes and will then switch itself off.

This helps to neutralise any lingering vapours and odours in the air.

- From the Booster setting, the fan switches immediately to Level 3.
- From Level 3, it will switch to Level 2 after approx. 1 minute.
- From Level 2, it will switch to Level 1 after 2 minutes.
- After 2 minutes at Level 1 the fan switches itself off.
- After another 30 seconds, the hob lighting switches off.

The cooking process is then finished.

## Leaving automatic mode temporarily

To leave automatic mode temporarily during cooking:

- Manually select a different fan power level, or
- Manually switch the cooker hood off, or
- Activate the run-on function  on the cooker hood. The fan will switch itself off after the selected run-on time, and the lighting will remain on.

The cooker hood functions are now operated manually (see “Operation (Manual mode)”).

## Returning to automatic mode

The cooker hood will resume automatic mode:

- If the cooker hood has not been used for approx. 5 minutes after selecting a fan power level manually, or
- If the manually selected fan power level corresponds to the automatic one again, or
- The cooker hood fan and the hob have been switched off for at least 30 seconds.  
Automatic mode will resume next time the hob is switched on.

You can also operate the cooker hood manually for a complete cooking process.

- Switch the cooker hood fan on **before** the hob.

If the cooker hood fan and the hob have been switched off for at least 30 seconds after cooking, automatic mode will resume next time the hob is switched on.



### Cooking without Con@ctivity (Manual mode)

The cooker hood can be operated manually if:

- The Con@ctivity function is not activated.
- You have temporarily deactivated the Con@ctivity function (see “Operation (Manual operation)” – “Leaving automatic mode temporarily”).

### Switching the fan on

Switch the fan on as soon as you start cooking. This is to ensure that vapours are captured right from the start.

- Press the On/Off control .

The fan will switch on at setting **2** and the  symbol and **2** will light up in the power setting display.

### Selecting the power level

Select power levels **1** to **3** for light to heavy cooking vapours, odours or heating.

Increase the power level as the level of vapours, odours or heat increases.

For short periods of cooking food with intensive vapours, odours or heat, e.g. when searing meat, select Booster level **B**.

- Select the power level you want by pressing the “-” or “+” control.

### Reducing power down from the Booster setting



If power management is activated (default setting), the fan automatically switches back to level **3** after 5 minutes.

### Selecting the run-on time

It is advisable to run the fan for a few minutes after cooking has finished. This helps to remove any lingering vapours and odours from the air.

It also reduces the risk of residues accumulating in the cooker hood and any resultant odours.

The run-on function enables the fan to continue running for a pre-determined time before switching itself off automatically.

- After you have finished cooking, press the run-on control  while the fan is still running:
  - Once: the fan will switch itself off after 5 minutes (**5** lights up).
  - Twice: The fan will switch itself off after 15 minutes (**15** lights up).
  - If you touch the run-on option control  again, the fan will remain on ( will go out).

### Switching the fan off

- Press the On/Off control  to switch the fan off.

The  symbol will go out.

# Operation (Manual mode)



---

## Dimming/switching the hob lighting on/off

The hob lighting can be switched on and off and dimmed independently of the fan.

- Press the lighting sensor  briefly to switch it on or off.

The lighting will switch on at maximum brightness.

- With the lighting switched on, press and hold the hob lighting control . The brightness will gradually dim until you release the control.
- Press and hold the lighting  control again to increase the brightness to the level required and then release it.



## Power management

The cooker hood is fitted with a power management system. Power management helps to save energy. It ensures that the fan power level is reduced automatically and that the lighting is switched off.

- If the Booster setting has been selected, the fan will automatically switch to level 3 after 5 minutes.
- From fan power levels 3, 2 or 1, the power will be reduced by one level after 2 hours and then in 30-minute stages until the fan finally switches off.
- The hob lighting will switch off automatically after 12 hours.

You can deactivate power management. Keep in mind that deactivating this function may increase energy consumption.

## Activating/deactivating Power Management

- Switch off the fan and the lighting.
- Press the fan run-on control  for approx. 10 seconds until the indicator for fan power level **1** lights up.
- Then press in turn:
  - the lighting control ,
  - the **—** control, and then
  - the lighting control .

If Power Management is activated, the **1** and **B** indicators light up constantly. When it is deactivated, the **1** and **B** indicators flash.

- Press the **—** control to deactivate Power Management.

The **1** and **B** indicators will flash.

- Press the **+** control to activate Power Management.

The **1** and **B** indicators will light up constantly.



- Confirm the setting with the run-on option control .

All the indicator lights will go out.

If you do not confirm your choice of setting within 4 minutes, the cooker hood will revert to the old setting.

## Safety switch-off



If Power management has been deactivated, the cooker hood will switch itself off automatically after 12 hours if it has been left on (fan and hob lighting).

- To switch it on again press the On/Off  control or the lighting control .

# Operation (Automatic and Manual modes)

## Operating hours counter

The cooker hood registers the length of time it has been operated.



When the grease filter symbol  or the charcoal filter symbol  lights up, the operating hours counters are signalling that the filters need to be cleaned or changed. Further information about cleaning and replacing the filters and resetting the operating hours counter can be found under “Cleaning and care”.

## Altering the operating hours counter for the grease filter(s)

You can set the operating hours counter to suit the type of cooking you do.

The factory default setting is a cleaning interval of 30 hours.

- Select a shorter time of 20 hours if you fry a lot.
- If you only cook occasionally, we recommend that you still select a short time. This is to prevent grease hardening on the filter(s) and making cleaning more difficult.
- Select a longer time of 40 or 50 hours if you use very little fat for cooking.

- Switch off the fan and the lighting.
- Press the run-on  control and the operating hours control  at the same time.

The Grease filter symbol  and one of the fan power level indicators will flash.

Fan power level indicators **1** to **B** show the time set:

<b>1</b> .....	20 hours
<b>2</b> .....	30 hours
<b>3</b> .....	40 hours
<b>B</b> .....	50 hours

- Press the **—** control for a shorter duration, or **+** for a longer duration.
- Confirm your choice with the operating hours control .

All the indicator lights will go out.

If you don't confirm your selection within 4 minutes, the cooker hood will automatically revert to the original setting.

## Operation (Automatic and Manual modes)



### Altering or deactivating the charcoal filter operating hours counter

The charcoal filter is needed for recirculation mode.

You can set the operating hours counter to suit the type of cooking you do.

It has to be deactivated for extraction mode.



It is set at the factory for 180 hours of use before the filters need replacing.

- Switch off the fan and the lighting.
- Press the + control and the operating hours control   at the same time.

The charcoal filter symbol  and one of the fan power levels will flash.

Fan power level indicators **1** to **B** show the time set:

Indicator <b>1</b> .....	120 hours
Indicator <b>2</b> .....	180 hours
Indicator <b>3</b> .....	240 hours
Indicator <b>B</b> .....	deactivated





- Select the duration you want with the + or - control.
- Confirm your choice with the operating hours control  .

All the indicator lights will go out.

If you do not confirm your selection within 4 minutes, the cooker hood will automatically revert to the original setting.

### Reading the filter operating hours counter

You can check the percentage of time set already used before the filter needs replacing.

- Switch the fan on with the On/Off control .
- Press and hold the operating hours control  :
  - Once, to read the grease filter operating hours. The grease filter symbol  lights up.
  - Twice, to read the charcoal filter operating hours. The charcoal filter symbol  lights up.

One or more of the fan power level indicators will flash.

The number of fan power level indicators flashing shows the percentage of the operating time which has already been used up.

Indicator <b>1</b> .....	25 %
Indicators <b>1</b> and <b>2</b> .....	50 %
Indicators <b>1</b> to <b>3</b> .....	75 %
Indicators <b>1</b> to <b>B</b> .....	100 %

The number of operating hours used remains in the memory, even when the cooker hood is switched off or there is a power cut.

This cooker hood operates very efficiently and economically. The following will help you to save even more energy when using it:

- Ensure that there is sufficient ventilation in the kitchen when cooking. In extraction mode, if there is insufficient air flow the cooker hood cannot operate efficiently and this causes increased operating noise levels.
- Always cook with the lowest possible setting. This produces fewer cooking vapours, so you can use a lower cooker hood power level and therefore benefit from reduced energy consumption.
- Clean or change the filters at regular intervals. Heavily soiled filters reduce performance, increase the risk of fire and are unhygienic.
- Use the Con@ctivity function. The cooker hood will switch on and off automatically at the optimum power level for the cooking you are doing, which ensures low energy consumption.
- If you are operating the cooker hood manually, please note the following:
  - Check the power level selected on the cooker hood. A low power level is usually sufficient. Only use the Booster setting when necessary.
  - When a large volume of cooking vapours are being produced, switch to a high power level in good time. This is more efficient than operating the cooker hood for longer to try to capture cooking vapours which have already been distributed throughout the kitchen.
  - Make sure that you switch the cooker hood off after use. If cooking vapours and odours still need to be removed from the kitchen air after cooking, use the run-on function. The fan will switch off automatically after the selected run-on time.

# Cleaning and care

 Before proceeding with any maintenance or cleaning task, the cooker hood must be disconnected from the power supply (see “Warning and Safety instructions”).

## Housing

### General information

Unsuitable cleaning agents can damage the surfaces and control elements.

Do not use any cleaning agents containing soda, acid, chloride or solvent.

Do not use any abrasive cleaning agents, e.g. powder cleaners or cream cleaners and abrasive sponges, as well as pot scourers or sponges which have been used previously with abrasive cleaning agents.

 Moisture in the cooker hood can cause damage.  
Make sure that water does not get into the cooker hood.

- All external surfaces and control elements can be cleaned using hot water with a small amount of washing-up liquid applied with a well wrung-out soft sponge or cloth.
- After cleaning, wipe the surfaces dry using a soft cloth.

### Important information for appliances with stainless steel surfaces

This information does not apply to the control buttons.

Stainless steel surfaces can be cleaned with a non-abrasive cleaning agent designed specifically for use on stainless steel.

To prevent the surfaces from quickly becoming dirty again, we recommend treating them with a stainless steel care product (available from Miele).

### Important information for appliances with lacquered casing

(Customisation on request)

Minor scratches on the surface are inevitable when cleaning the casing; they may be visible depending on the lighting in the kitchen.

### Important information for the control elements

If soiling is not removed promptly, it could cause the control elements to alter or discolour.

Remove any soiling immediately.

The surface of the control elements can become damaged if they are cleaned using stainless steel cleaning agents.

Do not use stainless steel cleaning agents on the control elements.

### Important for appliances with glass surfaces

- Glass surfaces can be cleaned using a proprietary non-abrasive cleaning agent designed specifically for use on glass.

## Grease filters

 Fire hazard

Oversaturated grease filters are a fire hazard.

Clean the grease filters at regular intervals.

The re-usable metal grease filters in the appliance remove solid particles (grease, dust, etc.) from the kitchen vapours, preventing soiling of the cooker hood.

The grease filters must be cleaned at regular intervals.

Heavily soiled grease filters hinder air extraction and will lead to increased levels of soiling in the cooker hood and in the kitchen.

## Cleaning interval

Accumulated grease solidifies over a longer period of time and makes cleaning more difficult. The grease filters should therefore be cleaned every 3 to 4 weeks.

The filter operating hours control reminds you to regularly clean the grease filters by illuminating the grease filter symbol .

You can set the operating hours counter interval to suit the type of cooking you do (see "Operation (Automatic and Manual modes)").

## Removing a grease filter

 When handling a grease filter, be careful not to drop it.

This can result in damage to the filter and the hob below.

Make sure you hold the filter securely at all times when handling it.

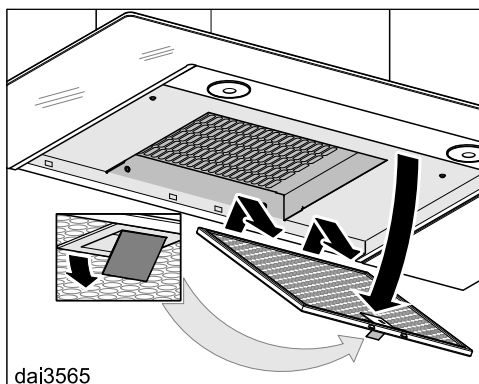

- To take out a grease filter, release the locking clip on the filter, lower the filter approx. 45°, unhook it at the back and remove it.

## Cleaning the grease filters by hand

- Clean the filters with a soft nylon brush in a mild solution of hot water and a small amount of washing-up liquid. Do not use "neat" washing up liquid.

## Unsuitable cleaning agents

Unsuitable cleaning agents can cause damage to the surface of the filters if used regularly.

Do not use:

- cleaning agents containing descaling agents
- powder cleaners, cream cleaners
- aggressive multi-purpose cleaning agents or spray cleaners for grease
- oven sprays

# Cleaning and care

## Cleaning the grease filters in the dishwasher

⚠ Risk of damage due to excessively high temperatures in the dishwasher.

Excessively high temperatures may cause the grease filters to become unusable, if they become deformed, for example.

Select a programme that does not exceed the recommended temperature.

Also follow the information provided in the operating instructions for the dishwasher.

- Place the grease filters upright or at a slight angle in the lower basket. Ensure the spray arm is not obstructed.
- Use a standard household cleaning detergent.
- Select a programme with a maximum wash temperature of 65 °C.

Depending on the detergent used, the internal filter surfaces may become discoloured. This will not affect the functioning of the grease filters in any way.

### After cleaning

- After cleaning, leave the filters to dry on an absorbent surface before replacing them.
- When removing the filters for cleaning, also clean off any residues of oil or fat from the now accessible housing to prevent the risk of these catching fire.
- Refit the grease filters, making sure that the latch faces outwards.

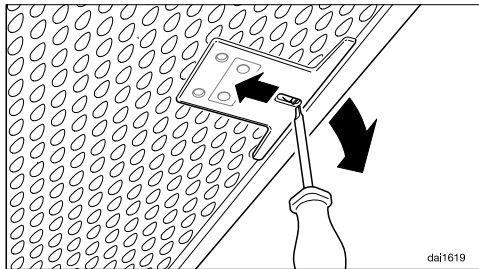

- If a grease filter is inadvertently fitted upside down, insert a small screwdriver blade into the slit to disengage the clip.

### Resetting the grease filter operating hours counter

After cleaning, the operating hours counter needs to be reset.

- Whilst the fan is switched on, press the operating hours control  for approx. 3 seconds, until only **1** is flashing.

The grease filter symbol  goes out.

If you want to clean the grease filters before the operating hours counter has reached its maximum:

- Press the operating hours control  for approx. 6 seconds, until only **1** is flashing.

### Replacing the grease filters

Regular usage and cleaning can cause the filter surfaces to become worn.

If you identify any damage, replace the grease filters.

Grease filters are available to order via the Miele Customer Service Department (see end of these operating instructions for contact details) or from your Miele dealer.



## Charcoal filter

With recirculation mode, a charcoal filter must be fitted in addition to the grease filters. The charcoal filter is designed to absorb cooking odours.

The charcoal filter is fitted in the canopy above the grease filters.

### Fitting/replacing charcoal filters

- Remove the grease filter before fitting or replacing a charcoal filter.
- Take the charcoal filter out of its packaging.

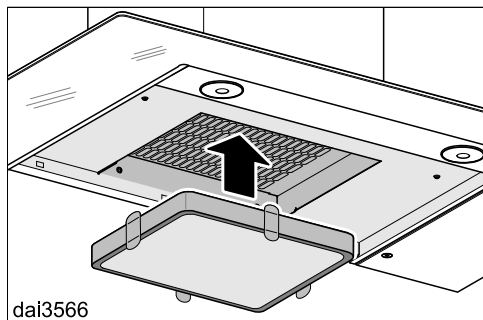

- Press the charcoal filter into the frame.
- Refit the grease filters.

### When to change the charcoal filter

- Replace the charcoal filter when it no longer absorbs kitchen odours effectively.  
It should, however, be replaced at least every 6 months.

The operating hours counter will remind you to replace the charcoal filter by lighting up the charcoal filter symbol .

### Resetting the charcoal filter operating hours counter

After changing the charcoal filter, the operating hours counter needs to be reset.

- To do this, with the fan switched on, press the operating hours control  twice, then hold it for approx. 3 seconds until only the 1 is flashing.

The Charcoal filter symbol  will go out.

If you want to replace the charcoal filter **before** the operating hours counter has reached its maximum:

- Press the operating hours control  twice and hold it for approx. 6 seconds until only the 1 is flashing.

### Disposing of charcoal filters

- Used charcoal filters can be disposed of with normal household waste.

### Reactivatable charcoal filter

A reactivatable charcoal filter is available for this cooker hood. It can be used several times after being reactivated in the oven.

- Please follow the operating instructions supplied with the filter.

Charcoal filters are available to order via the Miele Webshop, the Miele Spare Parts Department (see end of this booklet for contact details) or from your Miele dealer.

The charcoal filters are listed under “Technical data” at the back of this booklet.

# Installation

## Before installation

 Before installation, it is important to read the information given on the following pages as well as the “Warning and Safety instructions” at the beginning of this booklet.

## Protective foil

The housing components have protective foil around them to protect them from transport damage.

- Please remove this foil before fitting the housing components. It can be peeled off easily.

## Installation materials

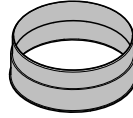

**1 vent connection**  
for exhaust ducting  $\varnothing$  150 mm.

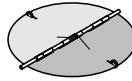

**1 non-return flap**  
for fitting into the exhaust socket on the motor unit (not needed for recirculation mode).

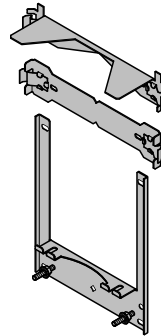

**3 wall brackets**  
for securing the cooker hood to the wall.

08565780

08272520

Wandhalter-Set



5x60mm-D3x6x8x50

**8 screws, 5 x 60 mm** and

**8 plugs, 8 x 50 mm**

for securing to the wall.

 The screws and plugs are designed for use in solid walls only. For other types of wall construction, alternative fixings will be required. Make sure the wall is able to take the weight of the cooker hood.



00031662

**2 M6 nuts with locking teeth**

for securing the appliance.



08256130

**2 screws, 3.9 x 7.5 mm**

for securing the chimney.

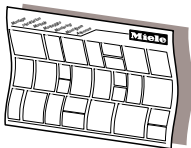

dina3mie

## Installation plan

See the installation plan for details on the individual steps involved in the installation of this appliance.

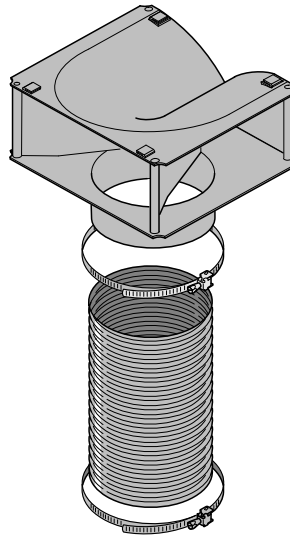

DUM20

## Conversion kit for recirculation mode

The conversion kit contains an exhaust grille, hose and hose clips (not supplied, but available as an optional accessory. See “Technical data”).

# Installation

## Appliance dimensions

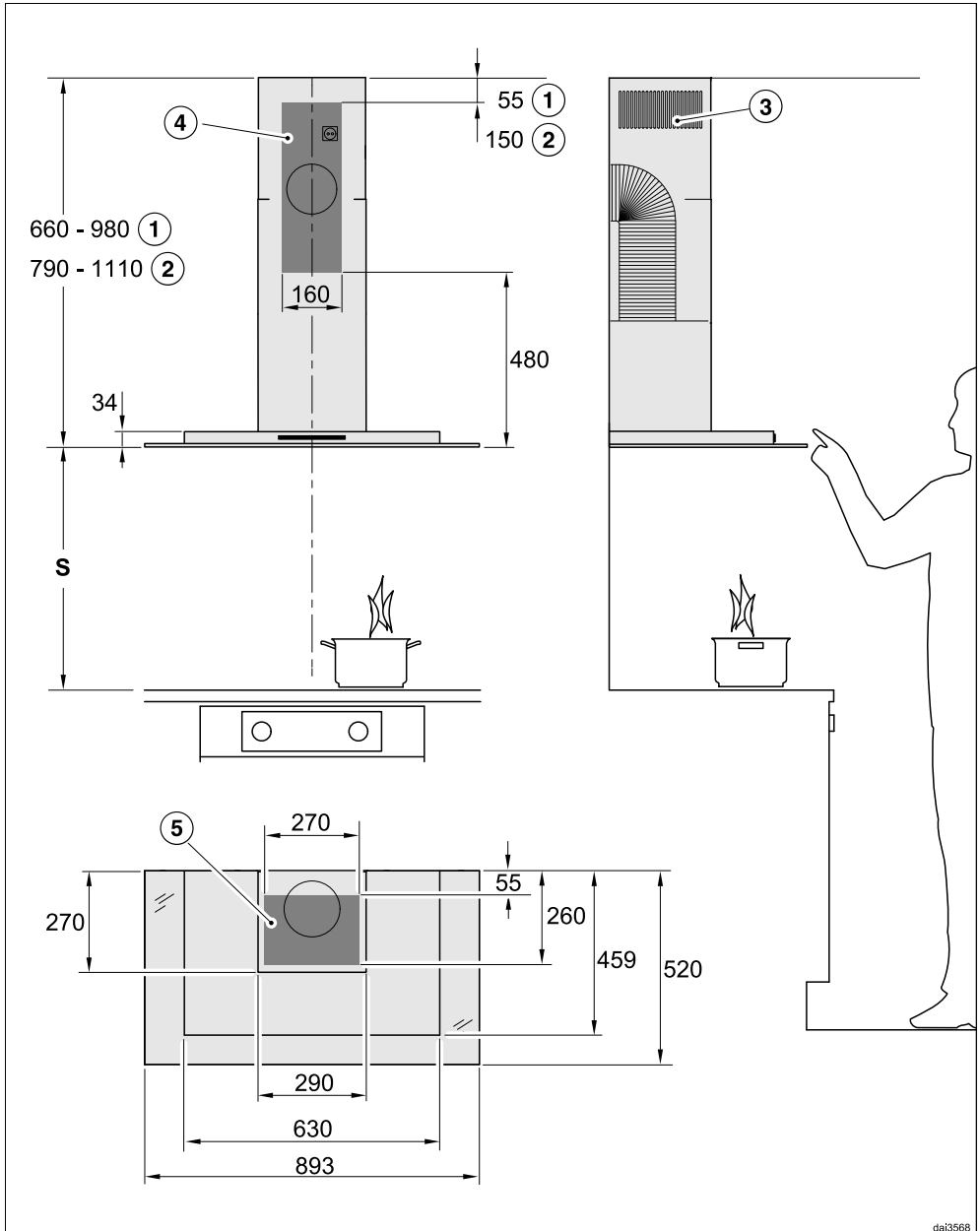

da13568

The diagram is not drawn to scale.

- ① Extraction
- ② Recirculation
- ③ Ventilation grille positioned at the top for recirculation
- ④⑤ (Only ④ is required for recirculation mode cooker hoods). The shaded area represents the wall or ceiling area for the ducting cut-out and for the connection socket. Recirculation cooker hoods only need a connection socket to be fitted.

Connection for air extraction  $\varnothing$  150 mm

## Safety distance between hob and cooker hood (S)

When planning the installation height of your cooker hood, the minimum safety distance between the top of a cooker or hob and the bottom of the cooker hood is as follows, unless a greater distance is specified by the manufacturer of your cooking appliance.

See “Warning and Safety” instructions for further information.

Cooking appliance	Minimum distance S
Electric hob	450 mm
Electric grill, deep fat fryer (electric)	650 mm
Multi-burner gas hob, total output $\leq$ 12.6 kW, no burner $>$ 4.5 kW	650 mm
Multi-burner gas hob, total output $>$ 12.6 kW and $\leq$ 21.6 kW, no burner $>$ 4.8 kW.	760 mm
Multi-burner gas hob, total output $>$ 21.6 kW, or multi-burner gas hob where one burner $>$ 4.8 kW.	Not possible
Single burner gas hob, output $\leq$ 6 kW.	650 mm
Single burner gas hob, output $>$ 6 kW and $\leq$ 8.1 kW.	760 mm
Single burner gas hob, output $>$ 8.1 kW	Not possible

# Installation

## Installation recommendations

- When deciding on the safety distance between the hob and cooker hood, please note that a distance of 650 mm above electric cookers/hobs may be preferable to give more working space under the hood.
- Account should also be taken of the height of the person who will be using the hood most often. They should have sufficient space to work comfortably at the hob, and be able to reach the cooker hood controls with ease.
- Please be aware that if positioned too high, extraction will be inefficient.
- To achieve optimum vapour extraction, the cooker hood must be positioned centrally over the hob, not to the side.
- The hob should be no wider than the cooker hood, and if possible, it should be narrower.
- The installation area must be easily accessible. The cooker hood should be easily accessible and easy to dismantle in the event that service is required. This should be taken into consideration when planning the position of cupboards, shelves, ceilings or features in the vicinity of the cooker hood.

## Drilling diagram for wall mounting

- Please follow the directions given in the installation instructions supplied for drilling.

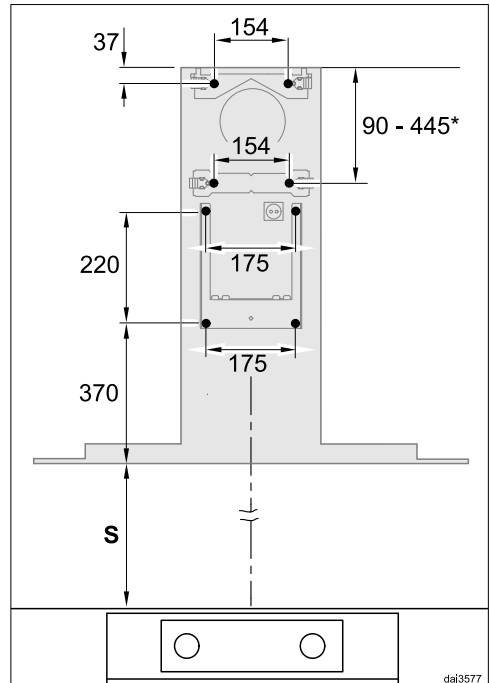

- For pre-installation of a back wall where the holes have to be pre-drilled, please refer to the drilling distances in the drawing above (screws  $\varnothing$  5 mm).

\*The dimension for the middle wall bracket is variable. It will depend on the position of the wall vent and the socket. It should be set as low as possible.

## Connection for air extraction

 If the cooker hood is used at the same time as a heating appliance that relies on oxygen from the same room, there is a risk in certain circumstances of toxic fumes building up.

It is essential that the “Warning and Safety” instructions are observed. The cooker hood should be installed according to local and national building regulations. Seek approval from the building inspector where necessary.

Only use smooth pipes or flexible exhaust ducting made from approved non-flammable materials for exhaust ducting.

To achieve the most efficient air throughput with the lowest noise levels, please note the following:

- The diameter of the exhaust ducting must not be smaller than the cross-section of the exhaust duct (see “Appliance dimensions”). This applies in particular when using flat ducting.
- The exhaust ducting should be as short and straight as possible.
- Only use wide radius bends.
- The exhaust ducting must not be kinked or compressed.
- All connections must be strong and airtight.
- If the exhaust ducting has flaps, these must be opened whenever the cooker hood is switched on.

Any constriction of the air throughput will reduce extraction performance and increase operating noise.

## Flue

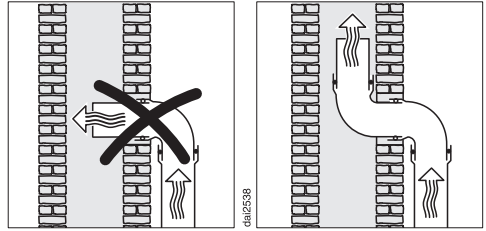

If the exhaust air is to be ducted into a flue, the ducting must be directed in the flow direction of the flue.

If the flue is used by several ventilation units, the cross-section of the flue must be large enough.

# Installation

## Non-return flap

- Use a non-return flap in the exhaust system.

A non-return flap ensures that when the cooker hood is not in operation, the duct is closed to prevent unwanted exchange of room air and outside air.

If the exhaust is ducted through an outside wall, a Miele wall vent or roof vent (available as an optional accessory) is recommended. Both of these have a built-in non-return flap.

If the on-site ventilation system does not have a non-return flap, one is supplied with the cooker hood.

The non-return flap is fitted in the exhaust socket of the fan.

## Condensation

If the exhaust ducting is to run through cool rooms or ceiling space, for example, the significant variations in temperature between the different areas can cause condensation to form. Insulate the exhaust ducting to reduce temperature variations.

If the exhaust ducting is to be laid horizontally, it must be laid with a downwards sloping gradient of at least 1 cm per meter. This is to ensure that condensation cannot drain back into the cooker hood.

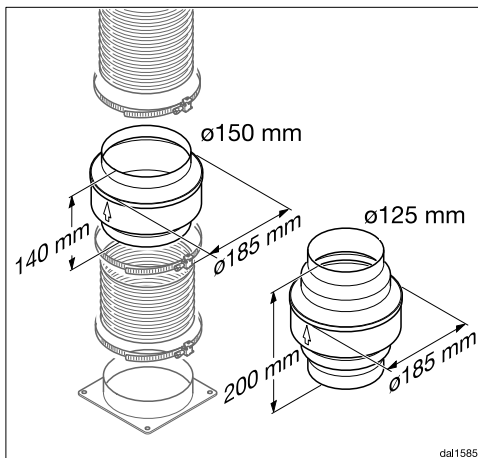

In addition to insulating the exhaust ducting, it is advisable to also install a condensate trap for collecting and evaporating any potential condensation.

Condensate traps for 125 mm or 150 mm diameter exhaust ducting are available as optional accessories.

When installing a condensate trap, ensure that it is positioned vertically and as closely as possible to the cooker hood above the exhaust connection. The arrow on the casing indicates the direction of airflow.

Miele shall not accept warranty claims for any functional defects or damage caused by inadequate exhaust ducting.



## Silencer

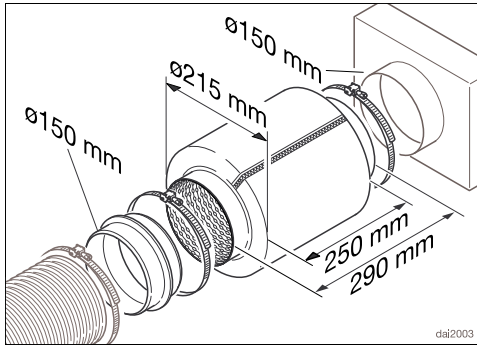

To reduce noise levels even further, a silencer (optional accessory) can be installed in the exhaust ducting.

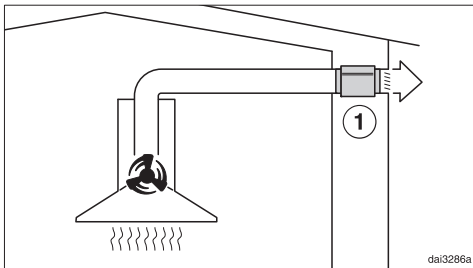

In extraction mode, the silencer not only reduces noise from the fan outside the house, but also sounds originating outside reaching the kitchen through the exhaust ducting (e.g. traffic noise). For this reason, the silencer must be positioned as close as possible to the ducting exit ①.

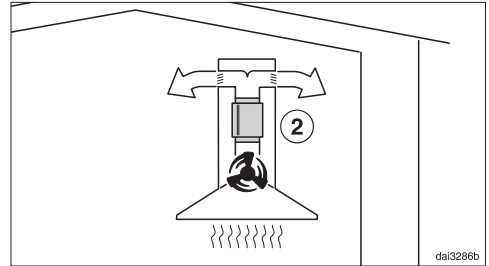

In recirculation mode, the silencer needs to be positioned between the exhaust socket and the directional unit ②. Check that there is sufficient space.

# Installation

---

## Electrical connection

The cooker hood is supplied with a mains cable with moulded plug ready for connection to a suitable earthed socket.

If the socket is not easily accessible or a fixed connection is envisaged, ensure that a suitable means of disconnection is provided on the installation side for each pole.

 Risk of fire from overheating. Connecting the cooker hood to multi-socket adapters or extension cables can overload the cables. For safety reasons, do not use an extension cable or multi-socket adapter.

The electrical system must comply with local and national safety regulations (BS 7671 in the UK).

For safety reasons, we recommend using a type  residual current device (RCD) in the relevant electrical installation for connecting the cooker hood.

If the mains connection cable is damaged, it must only be replaced with a specific mains connection cable of the same type (available from the Miele Customer Service Department). For safety reasons, such replacement may only be carried out by a qualified specialist or the Miele Customer Service Department.

These operating instructions and the data plate indicate the nominal power consumption and the appropriate fuse rating. Compare this information with the data of the on-site electrical connection.

If in any doubt, consult a qualified electrician.

Temporary or permanent operation on an autonomous power supply system or a power supply system that is not synchronised with the mains power supply (e.g. island networks, back-up systems) is possible. A prerequisite for operation is that the power supply system complies with the specifications of EN 50160 or an equivalent standard. The function and operation of the protective measures provided in the domestic electrical installation and in this Miele product must also be maintained in isolated operation or in operation that is not synchronised with the mains power supply, or these measures must be replaced by equivalent measures in the installation. As described, for example, in the current version of VDE-AR-E 2510-2.

Information to help you rectify faults yourself and about Miele spare parts can be found at [www.miele.com/service](http://www.miele.com/service).

In the UK, your appliance warranty is valid for 2 years from the date of purchase. However, you must activate your cover by calling 0330 160 6640 or registering online at [www.miele.co.uk](http://www.miele.co.uk).

## Contact in the event of a fault

In the event of any faults which you cannot remedy yourself, please contact your Miele dealer or the Miele Customer Service Department.

You can book a Miele Customer Service Department call-out online at [www.miele.com/service](http://www.miele.com/service).

Contact information for the Miele Customer Service Department can be found at the end of this document.

Please quote the model identifier and serial number of your appliance (Fabr./SN/Nr.) when contacting the Miele Customer Service Department. This information can be found on the data plate.

Please note that telephone calls may be monitored and recorded for training purposes and that a call-out charge will be applied to service visits where the problem could have been resolved as described in this booklet.

## Position of the data plate

The data plate is visible after removing the grease filter(s).

## Warranty

For information on the appliance warranty specific to your country please contact Miele. See back cover for address.

## Technical data

---

Fan motor	80 W
Hob lighting	2 x 3 W
Total rated load	86 W
Mains voltage	AC 230 V
Fuse rating	3 A
Power cable length	1.5 m
Weight	
DA 5798 W	22 kg

### WiFi module

Frequency band	2.400–2.4835 GHz
Maximum transmission power	< 100 mW

### Special accessories for recirculation mode

Conversion kit DUW 20 and one charcoal filter DKF 12-P or DKF 12-R (reactivatable)

## EU Conformity declaration

Miele hereby declares that this cooker hood complies with Directive 2014/53/EU. The complete text of the EU declaration of conformity is available from one of the following internet addresses:

- Products, Download from [www.miele.ie](http://www.miele.ie)
- For service, information, operating instructions etc: go to <https://miele.co.uk/> manuals and enter the name of the product or the serial number

## UK Conformity declaration

Miele hereby declares that this cooker hood complies with UK Radio Equipment Regulations 2017, as amended.

The complete text of the UK declaration of conformity is available from one of the following internet addresses:

- Products, Download from [www.miele.co.uk](http://www.miele.co.uk)
- For service, information, operating instructions etc: go to <https://miele.co.uk/> manuals and enter the name of the product or the serial number

This **Statement of Compliance** confirms this Miele product fully complies with the **Product Security and Telecommunications Infrastructure (Security Requirements for Relevant Connectable Products) Regulations 2023**.

- 1) Household Appliance – *Cooker Hood DA 6498 W, DA 6698 W, DA 5798 W*
- 2) Manufactured by: Miele & Cie KG,  
Carl Miele Street 29, 33332 Gutersloh Germany  
Imported by and contact point: Miele Company Ltd, Fairacres, Marcham Road,  
Abingdon, Oxon, OX14 ITW Great Britain
- 3) The defined support period at the time of first supply is 10 years
- 4) To report vulnerabilities and cybersecurity issues please contact: [psirt@miele.com](mailto:psirt@miele.com)

5) Signature 

Name: **Paul Wright**

Company Position: **Head of Technical Management**

Date of signature: **19th March 2024**

Place of signature: **Abingdon, Oxfordshire**

## Note for test institutes

Energy efficiency must be calculated using extraction mode. The cooker hood is set up ex-works for recirculation mode. To re-set it for extraction mode the operating hours counter for the charcoal filter(s) has to be deactivated (see “Before using for the first time”).

# Technical data

## Data sheet for household cooker hoods

In acc. with delegated regulation (EU) No. 65/2014 and regulation (EU) No. 66/2014

MIELE	
<b>Model name / identifier</b>	DA 5798 W
Annual Energy Consumption ( $AEC_{hood}$ )	24,1 kWh/year
Energy efficiency class	A++
Energy efficiency index ( $EEL_{hood}$ )	36,9
Fluid Dynamic Efficiency ( $FDE_{hood}$ )	37,9
Fluid Dynamic Efficiency class	
A (most efficient) to G (least efficient)	A
Lighting Efficiency ( $LE_{hood}$ )	91,7 lx/W
Lighting Efficiency class	
A (most efficient) to G (least efficient)	A
Grease Filtering Efficiency	95,1%
Grease Filtering Efficiency class	
A (most efficient) to G (least efficient)	A
Airflow at best efficiency point	306,6 m <sup>3</sup> /h
Air flow (min. speed)	180 m <sup>3</sup> /h
Air flow (max. speed)	380 m <sup>3</sup> /h
Air flow (intensive or boost setting)	600 m <sup>3</sup> /h
Max. air flow ( $Q_{max}$ )	600 m <sup>3</sup> /h
Air pressure at best efficiency point	378 Pa
Airborne acoustical A-weighted sound power emissions (min. speed)	35 dB
Airborne acoustical A-weighted sound power emissions (max. speed)	52 dB
Airborne acoustical A-weighted sound power emissions (intensive or boost setting)	63 dB
Electrical power input at best efficiency point	85,0 W
Power consumption in off mode ( $P_o$ )	W
Power consumption in standby mode ( $P_s$ )	0,35 W
Nominal power of lighting system	6,0 W
Average illumination of the lighting system on the cooking surface	550 lx
Time increase factor	0,6

## United Kingdom

Miele Co. Ltd., Fairacres, Marcham Road, Abingdon, Oxon, OX14 1TW  
Tel: 0330 160 6600, Internet: [www.miele.co.uk](http://www.miele.co.uk), E-mail: [info@miele.co.uk](mailto:info@miele.co.uk)

### Australia

Miele Australia Pty. Ltd.  
ACN 005 635 398  
ABN 96 005 635 398  
Level 4, 141 Camberwell Road  
Hawthorn East, VIC 3123  
Tel: 1300 464 353  
E-mail: [info@miele.com.au](mailto:info@miele.com.au)  
Internet: [www.miele.com.au](http://www.miele.com.au)

### China Mainland

Miele Electrical Appliances Co., Ltd.  
1-3 Floor, No. 82 Shi Men Yi Road  
Jing' an District  
200040 Shanghai, PRC  
Tel: +86 21 6157 3500  
Fax: +86 21 6157 3511  
E-mail: [info@miele.cn](mailto:info@miele.cn)  
Internet: [www.miele.cn](http://www.miele.cn)

### Hong Kong, China

Miele (Hong Kong) Ltd.  
41/F - 4101, Manhattan Place  
23 Wang Tai Road  
Kowloon Bay, Hong Kong  
Tel: (852) 2610 1025  
Fax: (852) 3579 1404  
E-mail:  
[customerservices@miele.com.hk](mailto:customerservices@miele.com.hk)  
Website: [www.miele.hk](http://www.miele.hk)

### India

Miele India Pvt. Ltd.  
1st Floor, Copia Corporate Suites,  
Commercial Plot 9, Mathura Road,  
Jasola, New Delhi - 110025  
E-mail: [customercare@miele.in](mailto:customercare@miele.in)  
Website: [www.miele.in](http://www.miele.in)

### Ireland

Miele Ireland Ltd.  
2024 Bianconi Avenue  
Citywest Business Campus  
Dublin 24  
Tel: (01) 461 07 10  
Fax: (01) 461 07 97  
E-mail: [info@miele.ie](mailto:info@miele.ie)  
Internet: [www.miele.ie](http://www.miele.ie)

### Malaysia

Miele Sdn Bhd  
Suite 12-2, Level 12  
Menara Sapura Kencana  
Petroleum  
Solaris Dutamas No. 1  
Jalan Dutamas 1  
50480 Kuala Lumpur, Malaysia  
Phone: +603-6209-0288  
Fax: +603-6205-3768

### New Zealand

Miele New Zealand Limited  
IRD 98 463 631  
8 College Hill  
Freemans Bay, Auckland 1011  
Tel: 0800 464 353  
E-mail: [customercare@miele.co.nz](mailto:customercare@miele.co.nz)  
Internet: [www.miele.co.nz](http://www.miele.co.nz)

### Singapore

Miele Pte. Ltd.  
29 Media Circle  
#11-04 ALICE@Mediapolis  
Singapore 138565  
Tel: +65 6735 1191  
Fax: +65 6735 1161  
E-mail: [info@miele.com.sg](mailto:info@miele.com.sg)  
Internet: [www.miele.sg](http://www.miele.sg)

### South Africa

Miele (Pty) Ltd.  
63 Peter Place, Bryanston 2194  
P.O. Box 69434, Bryanston 2021  
Tel: (011) 875 9000  
Fax: (011) 875 9035  
E-mail: [info@miele.co.za](mailto:info@miele.co.za)  
Internet: [www.miele.co.za](http://www.miele.co.za)

### Thailand

Miele Appliances Ltd.  
BHIRAJ TOWER at EmQuartier  
43rd Floor Unit 4301-4303  
689 Sukhumvit Road  
North Klongton Sub-District  
Vadhana District  
Bangkok 10110, Thailand

### United Arab Emirates

Miele Appliances Ltd.  
Showroom 1, Eiffel 1 Building  
Sheikh Zayed Road, Umm Al Sheif  
P.O. Box 114782 - Dubai  
Tel. +971 4 3044 999  
Fax. +971 4 3418 852  
800-MIELE (64353)  
E-mail: [info@miele.ae](mailto:info@miele.ae)  
Website: [www.miele.ae](http://www.miele.ae)

**Manufacturer:** Miele & Cie. KG, Carl-Miele-Straße 29, 33332 Gütersloh, Germany

DA 5798 W

en-GB

M.-Nr. 12 255 440 / 01