

Operating and installation instructions Fridge-freezer



It is **essential** to read the operating and installation instructions before setup, installation, and commissioning. This prevents both personal injury and damage to the appliance.

Contents

Warnings and safety notes	5
Sustainability and environmental protection	14
How to save energy	15
Installation	16
Fastening the refrigeration appliance in the building-in niche	16
Installation site	17
Climate range	18
Side-by-side combinations	18
Ventilation	19
Changing the door hinging	19
Furniture door (valid for KFN 7934 D)	19
Horizontal and vertical gaps	19
Weight of the furniture door	20
Building-in dimensions	21
Installation in a tall unit/side view	21
Connections and ventilation	23
Electrical connection	25
Familiarisation	26
Your refrigeration appliance: KFN 7913 E	26
Your refrigeration appliance: KFN 7934 D	28
Safety	31
Temperature alarm in the freezer zone	31
Door alarm	31
Appliance functions	32
SuperCool ❄️	32
SuperFreeze ❄️	32
Automatic SuperFreeze ❄️	32
Sabbath mode	33
Adjusting the interior fittings	33
Removing or moving the door shelves/bottle shelf	33
Removing or moving the shelves	33
Removing the DailyFresh ExtraCool drawer	33
Removing the DailyFresh drawer	33
Removing the freezer drawer	33
Moving the variable bottle rack	34
Accessories supplied	34
Optional accessories	34
Commissioning	35
Before using for the first time	35
Connecting the refrigeration appliance	35
Switching the refrigeration appliance on	35

Switching the refrigeration appliance off	35
Switching off for longer periods of time	36
Operation	37
Setting the temperature in the fridge zone	37
Temperature range in the fridge zone	37
Temperature display	37
Setting the temperature in the freezer zone	38
Temperature range in the freezer zone	38
Temperature display	38
Storing food in the fridge zone	39
Different storage zones	40
Should food be stored loose or in packaging?	41
DailyFresh ExtraCool drawer	42
Freezing and storing fresh food	43
Maximum freezing capacity	43
Making ice cubes	44
Cooling drinks quickly	44
Adjusting settings	45
Switching Sabbath mode on	45
Switching Sabbath mode off	45
Miele@home	46
Performing Scan & Connect	47
Setting up the WiFi connection for the first time	47
Activating the WiFi connection	47
Deactivating the WiFi connection	47
Cleaning and care	48
Cleaning agents	48
Preparing the refrigeration appliance for cleaning	48
Cleaning the interior of the appliance	49
Cleaning the condensate channel and condensate drain hole	49
Removing the compartment lid on the DailyFresh drawer	50
Dismantling drawer fronts	50
Cleaning the door seal	51
Cleaning the ventilation openings	51
After cleaning	51
Defrosting	51
Troubleshooting	52
Customer Service Department	55
Contact in the event of a fault	55
EPREL database	55
Warranty	55

Contents

Information	56
EU Conformity declaration.....	56
UK Conformity declaration	56
Copyrights and licences	56

Warnings and safety notes

This refrigeration appliance complies with current safety requirements. Inappropriate use can, however, lead to personal injury and material damage.

Please read the operating and installation instructions carefully before using the refrigeration appliance for the first time. They contain important information on installation, safety, use and maintenance. This is to protect yourself from injury, and from damaging your refrigeration appliance.

In accordance with standard IEC 60335-1, Miele expressly and strongly advises that you read and follow all information provided on installing the refrigeration appliance, as well as the warning and safety notes.

Miele cannot be held liable for injury or damage caused by non-compliance with these instructions.

Keep these operating and installation instructions in a safe place and pass them on to any future owner.

Correct application

- ▶ This refrigeration appliance is intended for use in the home and in similar environments, for example
 - in shops, offices and similar work settings
 - by the guests in hotels, motels, bed & breakfasts and other typical home settings.

This refrigeration appliance is not intended for outdoor use.

- ▶ This appliance is intended for domestic use only for cooling and storing food and drink as well as for storing deep frozen food, freezing fresh food and for making ice.

Any other usage is not supported by the manufacturer and could be dangerous.

- ▶ This refrigeration appliance is not suitable for storing and keeping cool medicines, blood plasma, laboratory preparations or similar substances or products that are subject to the Medical Device Directive. Incorrect use of the refrigeration appliance for such purposes may cause deterioration of the items stored. The refrigeration appliance is also not suitable for use in areas where there is a risk of explosion. Miele cannot be held liable for damage caused by improper or incorrect use or operation of the appliance.

Warnings and safety notes

▶ The appliance can only be used by people with reduced physical, sensory or mental capabilities, or lack of experience and knowledge, if they are supervised whilst using it, or have been shown how to use it in a safe way and recognise and understand the consequences of incorrect operation.

Safety with children

▶ Children under 8 years of age must be kept away from the refrigeration appliance unless they are constantly supervised.

▶ Children 8 years and older may only use the appliance unsupervised if they have been shown how to use it in a safe way and recognise and understand the consequences of incorrect operation.

▶ Children must not be allowed to clean or maintain the appliance unsupervised.

▶ Please supervise children in the vicinity of the appliance and do not let them play with it.

▶ Danger of suffocation! Whilst playing, children could become entangled in packaging (such as plastic wrapping) or pull it over their head and suffocate. Keep packaging material away from children.

Technical safety

▶ The coolant circuit has been checked for leaks. The refrigeration appliance complies with statutory safety requirements and the appropriate EU directives.



If the cooling circuit is damaged, refrigerant and oil can escape and ignite.

▶ **Warning: fire hazard/flammable materials.** This symbol is on the compressor and indicates flammable materials. Do not remove this sticker.

Warnings and safety notes

The refrigerant inside the appliance (details on the data plate) is environmentally friendly but flammable.

The use of this refrigerant does, however, sometimes lead to a slight increase in the noise level of the appliance. In addition to the noise of the compressor, you might be able to hear the refrigerant flowing around the cooling circuit. Unfortunately, this cannot be avoided, but it does not affect the performance of the refrigeration appliance.

When transporting and installing the refrigeration appliance, ensure that no parts of the cooling circuit are damaged. Splashes of refrigerant can damage the eyes and leaking refrigerant can ignite.

In the event of damage:

- Avoid naked flames or anything which creates a spark.
- Disconnect the refrigeration appliance from the mains electricity supply.
- Ventilate the room where the refrigeration appliance is located for several minutes.
- Contact the Miele Customer Service Department.

▶ The more refrigerant there is in a refrigeration appliance, the larger the room it should be installed in. In the event of a leakage, if the appliance is in a small room, there is the danger of a combustible gas/air mixture building up. For every 8 g of refrigerant at least 1 m³ of room space is required. The amount of refrigerant in the refrigeration appliance is stated on the data plate inside the appliance.

▶ If the ventilation cross-sections are covered or blocked, a combustible gas/air mixture can form if the cooling circuit is damaged. It is essential to observe the required ventilation cross-sections. The ventilation cross-sections must not be covered or blocked in any way.

▶ To avoid the risk of damage to the appliance, make sure that the connection data (fuse rating, frequency and voltage) on the data plate corresponds to the household supply.

Check that this is the case before connecting the appliance. Consult a qualified electrician if in any doubt.

▶ The electrical safety of this appliance can only be guaranteed when correctly earthed. It is essential that this standard safety requirement is met. If in any doubt please have the electrical installation tested by a qualified electrician.

Warnings and safety notes

▶ Temporary or permanent operation on an autonomous power supply system or a power supply system that is not synchronised with the mains power supply (e.g. island networks, back-up systems) is possible. A prerequisite for operation is that the power supply system complies with the specifications of EN 50160 or an equivalent standard.

The function and operation of the protective measures provided in the domestic electrical installation and in this Miele product must also be maintained in isolated operation or in operation that is not synchronised with the mains power supply, or these measures must be replaced by equivalent measures in the installation. As described, for example, in the current version of BS OHSAS 18001–2 ISO 45001.

▶ The socket must not be concealed behind the refrigeration appliance and must be easily accessible so that the appliance can be quickly disconnected from the electrical supply in case of an emergency.

▶ If the mains connection cable is damaged, disconnect the refrigeration appliance from the power supply immediately. Contact the Miele Customer Service Department.

▶ If the electrical connection cable supplied is damaged, it must only be replaced by an original spare part to prevent a hazard for the user. Miele can only guarantee the safety of the appliance when original Miele spare parts are used. For safety reasons, such replacement may only be carried out by a qualified specialist or the Miele Customer Service Department.

▶ Do not connect the appliance to the mains electrical supply by a multi-socket adapter or extension lead. These are a fire hazard and do not guarantee the required safety of the appliance.

▶ If moisture gets into electrical components or into the mains connection cable, it could cause a short circuit. Therefore, do not operate this refrigeration appliance in areas which are exposed to moisture (e.g. in a garage or utility room).

▶ This appliance must not be used in a non-stationary location (e.g. on a ship).

▶ Do not use a damaged appliance. It could be dangerous. Check the appliance for visible signs of damage.

▶ For safety reasons, this appliance may only be used after it has been built in.

Warnings and safety notes

- ▶ The appliance must be isolated from the electricity supply during installation, maintenance and repair work.
- ▶ Unauthorised installation, maintenance and repairs can cause considerable danger for the user. Installation, maintenance and repairs must only be carried out by a Miele authorised technician.
- ▶ While the appliance is under warranty, repairs should only be undertaken by a Miele authorised service technician. Otherwise the warranty is invalidated.
- ▶ Faulty components must only be replaced with genuine Miele original spare parts. Miele can only guarantee the safety standards of the appliance when Miele replacement parts are used.
- ▶ This refrigeration appliance is supplied with a special lamp to cope with particular conditions (e.g. temperature, moisture, chemical resistance, abrasion resistance and vibration). This lamp must only be used for the purpose for which it is intended. The lamp is not suitable for room lighting. Replacement lamps may only be fitted by a Miele authorised technician or by the Miele Customer Service Department. This refrigeration appliance contains several light sources with at least energy efficiency class E.

Proper installation

- ▶ Install the refrigeration appliance in accordance with the installation instructions.
- ▶ Always wear protective gloves when transporting and installing the refrigeration appliance and when changing the door hinging.
- ▶ Only install the refrigeration appliance in a solid, rectangular and level housing unit, positioned on an even and level floor.
- ▶ The refrigeration appliance is heavy and can tip forwards when the appliance door(s) is/are open:
 - At least 2 people are required to transport or move the refrigeration appliance.
 - At least 2 people are required to change the door hinging of the refrigeration appliance.
 - At least 2 people are required to install the refrigeration appliance.

Warnings and safety notes

- Never leave the refrigeration appliance unattended while it is being installed.
- It is essential that you secure the refrigeration appliance in the niche using the enclosed retaining and fastening parts (installation instructions).

Correct use

- ▶ This refrigeration appliance is designed for use within specific ambient temperatures (climate range). Do not use in ambient temperatures for which it is not designed. The climate range is stated on the data plate in the interior cabinet of the refrigeration appliance. A lower ambient temperature will cause the compressor to switch off for longer periods, meaning that the refrigeration appliance is unable to maintain the required temperature.
- ▶ Do not cover or block the air vents as this could impair the efficiency of the appliance, increase the electricity consumption and could cause damage to the components.
- ▶ If storing food which contains a lot of fat or oil in the appliance or the door, make sure that it does not come into contact with plastic components as this could cause stress cracks or break the plastic.
- ▶ Refrigeration appliance components which are made of metal or look like metal can contain aluminium. If acidic food comes into contact with aluminium, aluminium ions can be released into the food. Do not store food loose in the refrigeration appliance.
- ▶ Risk of fire and explosion. Do not store explosive materials in the refrigeration appliance or any products containing propellants (e.g. spray cans). Electrical components can cause flammable mixes of gases to ignite.
- ▶ Danger of explosion. Do not operate any electrical equipment (e.g. an electric ice-cream maker) inside the refrigeration appliance. Danger of sparking and explosion.
- ▶ Danger of injury and damage to the appliance. Do not store cans or bottles containing carbonated drinks or liquids which could freeze in the freezer zone. Otherwise they could burst.
- ▶ Danger of injury and damage to the appliance. When cooling drinks quickly in the freezer zone, make sure bottles are not left in for more than one hour. Otherwise they could burst.

Warnings and safety notes

- ▶ Danger of injury. Never handle frozen food or the metal parts of the appliance with wet hands. Your hands may freeze to the frozen food or to the metal.
- ▶ Danger of injury. Do not take ice cubes out with your bare hands and never place ice cubes or ice lollies in your mouth straight from the freezer zone. The very low temperature of the frozen food can cause frost burn to the lips and tongue.
- ▶ Do not refreeze partially or fully defrosted food. Consume defrosted food as soon as possible, as it will lose its nutritional value and spoil if left for too long. Defrosted food may only be re-frozen after it has been cooked.
- ▶ Observe the manufacturer's "use-by" dates and storage instructions given on food to avoid the risk of food poisoning. Storage times will depend on several factors, including the freshness and quality of the food, as well as the temperature at which it is stored.
- ▶ Do not sit, stand or lean on the shelves or drawers when they are pulled out. This could damage the refrigeration appliance.

Accessories and spare parts

- ▶ Only use original Miele accessories. If other parts are used, warranty, performance and product liability claims will be invalidated.
- ▶ Miele will guarantee to supply functional spare parts for a minimum of 10 years and up to 15 years following the discontinuation of your refrigeration appliance.

Cleaning and care

- ▶ Do not use any oils or grease on the door seals, as these will cause the seals to deteriorate and become porous with time.
- ▶ Do not use a steam cleaning appliance to clean or defrost this appliance. Steam could reach electrical components and cause a short circuit.
- ▶ **WARNING! DANGER of injury and damage!** Do not use any mechanical or other types of aids which are not recommended by the manufacturer to accelerate the defrosting process.
- ▶ Sharp edged or pointed objects will damage the evaporator, causing irreversible damage to the appliance. Do not use sharp edged or pointed objects to

Warnings and safety notes

- remove frost and ice,
 - separate frozen food or remove ice trays.
- ▶ Do not place electric heaters or candles in the appliance to defrost it. These can damage the plastic parts.
- ▶ Do not use defrosting sprays or de-icers, as they could contain substances which could damage the plastic parts or which might cause the build-up of gases and pose a danger to health.

Transport

- ▶ To avoid damage to the refrigeration appliance, always transport it upright and in its packaging.
- ▶ Danger of injury and damage to the appliance. The refrigeration appliance is very heavy and must be transported by two people.

Disposal of your old appliance

- ▶ Children playing could become trapped in the appliance and could suffocate.
- Remove the appliance doors.
 - Remove the drawers.
 - Leave the adjustable shelves in the refrigeration appliance so children cannot climb inside.
 - If your old refrigeration appliance has a door lock, destroy it. This will prevent the risk of children playing accidentally locking themselves in and endangering their lives.
- ▶ Risk of electric shock!
- Cut the plug off the mains connection cable.
 - Cut the mains connection cable off the old appliance.

Dispose of the plug and mains connection cable separately from the old appliance.

- ▶ During and after disposal, make sure that the refrigeration appliance is not placed near petrol or other flammable gases and liquids.

Warnings and safety notes

▶ **Risk of fire due to escaping oil or refrigerant!**

The refrigerant and oil inside the appliance are flammable. In high enough concentrations, escaping refrigerant or oil may ignite if they come into contact with an external heat source.

During disposal, make sure that the cooling circuit is not damaged in order to prevent refrigerant and oil escaping in an uncontrolled manner (see the data plate for details of the refrigerant).

▶ **Splashes of coolant can damage the eyes. Be careful not to damage any part of the pipework whilst awaiting disposal, e.g. by**

- puncturing the coolant channels in the condenser,
- bending any pipework, or
- scratching the surface coating.

Symbol on the compressor (depending on model)

This information is only relevant for recycling. There is no risk during normal operation.



▶ **The oil in the compressor can be fatal if swallowed or if it penetrates the airways.**

Sustainability and environmental protection

Disposing of the packaging material

The packaging material is used for handling and protects the appliance from transport damage. The packaging material used is selected from materials which are environmentally friendly for disposal and can generally be recycled.

Recycling the packaging material reduces the use of raw materials. Use material-specific collection points for valuable materials and take advantage of return options. Your Miele dealer will take the packaging material away.

Disposing of your old appliance

Electrical and electronic appliances contain many valuable materials. They also contain certain materials, compounds and components which were essential for their correct functioning and safety. These could be hazardous to human health and to the environment if disposed of with household waste or if handled incorrectly. Please do not, therefore, dispose of your old appliance with household waste.



Take care not to damage your refrigeration appliance before or during disposal in an authorised, environmentally friendly manner.

This is to ensure that refrigerant in the cooling circuit and oil in the compressor is contained, and will not leak into the environment.

Instead, please make use of officially designated collection and disposal points to dispose of and recycle electrical and electronic appliances in your local community, with your dealer or

with Miele, free of charge. By law, you are solely responsible for deleting any personal data from the old appliance prior to disposal. You are legally obliged to remove any old batteries which are not securely enclosed by the appliance and to remove any lamps without destroying them, where this is possible. These must be taken to a suitable collection point where they can be handed in free of charge. Please ensure that your old appliance poses no risk to children while being stored for disposal.

Sustainability and environmental protection

How to save energy ...

Installation site The refrigeration appliance has to cool more often at higher ambient temperatures and consumes more energy in the process. Therefore:

- Install the refrigeration appliance in a well-ventilated room.
- Do not install the refrigeration appliance near to a heat source (heater element, cooker).
- Protect the refrigeration appliance from direct sunlight.
- Ensure an ideal ambient temperature of 20 °C.
- Clean the ventilation openings on a regular basis to remove any dust.

Temperature setting The colder the temperature, the higher the energy consumption. The following settings are recommended:

- 4 to 5 °C in the refrigerator section.
- -18 °C in the freezer section.
- To save energy, switch off the SuperFreeze ❄️ function yourself as soon as the food is sufficiently chilled.

Use Energy consumption is increased by heat input and impeded air circulation. Therefore, you should:

- Only open the appliance door(s) when necessary and for as short a time as possible. Arrange the food in such a way that makes it easy to find in the appliance.
- Always close the appliance door(s) properly after opening them.
- Allow hot food and drinks to cool down before placing them in the refrigeration appliance.
- Store food well packaged or covered.
- Do not overfill the compartments to allow air to circulate.
- Place frozen food in the fridge zone to defrost.

Installation

 Carry out the installation in accordance with the installation instructions (see QR code).



Material number 12 837 110 – KFN 7934 D
(fixed door)



Material number 12 837 080 – KFN 7913 E
(sliding door)

Fastening the refrigeration appliance in the building-in niche

 Risk of damage and danger of injury due to the refrigeration appliance tipping over.

This refrigeration appliance is very heavy and can tip forwards when the appliance door is open.

Keep the appliance door(s) closed until the refrigeration appliance has been built in.

It is essential that you secure the refrigeration appliance in the niche using the enclosed retaining and fastening parts in accordance with the installation instructions.

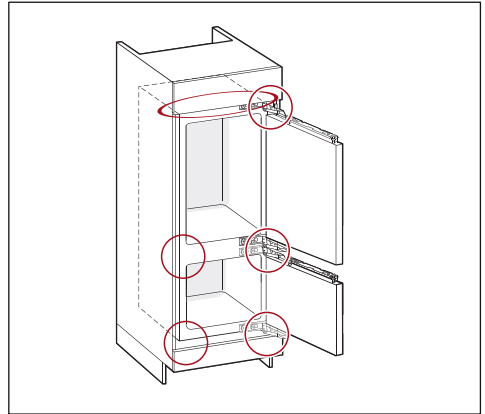

KFN 7934 D (fixed door)

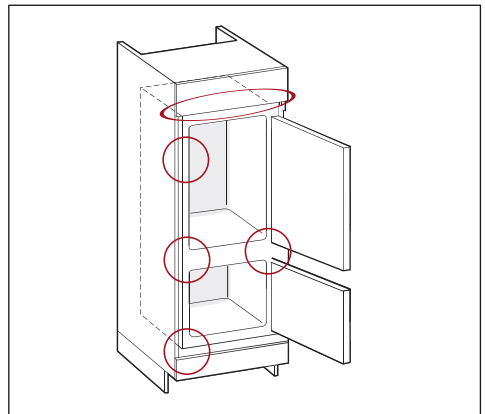

KFN 7913 E (sliding door)

Installation site

 Fire risk and risk of damage from appliances which give off heat.

Appliances which give off heat can catch fire and set fire to the refrigeration appliance.

The mains connection cable must not come into contact with heat sources.

This refrigeration appliance must not be installed underneath a hob.

 Fire risk and danger of damage from open flames.

Open flames can set fire to the refrigeration appliance.

Keep open flames (e.g. a candle) away from the refrigeration appliance.

 Risk of fire and damage due to improper installation.

If mains plugs and mains connection cables touch the back of the refrigeration appliance, they may be damaged by vibrations and cause a short circuit.

Mains plugs or mains connection cables must not touch the refrigeration appliance.

Mains connection cables must not be trapped or damaged.

Do not connect any other appliances to sockets located directly behind this refrigeration appliance.

Do not place or operate multi-socket adapters, distributor strips or other electronic devices (such as halogen transformers) behind the appliance.

This appliance should be installed in a dry, well-ventilated room.

Only install the refrigeration appliance in a solid, rectangular and level housing unit, positioned on an even and level floor.

 Risk of damage due to high humidity.

In environments with high humidity, condensation can build up on external refrigeration appliance panels. This condensation can cause corrosion on external appliance panels.

Install the refrigeration appliance in a dry and/or air-conditioned room with sufficient ventilation.

After installation please make sure that the appliance door(s) closes (close) properly and the refrigeration appliance is installed in accordance with these installation instructions. It is essential to comply with the specified ventilation cross-sections.

When deciding on the installation site, please bear in mind that your refrigeration appliance will consume more energy if installed near to a heater, a cooker or another appliance that gives off heat. Avoid direct sunlight. Higher ambient temperatures increase energy consumption as the compressor runs for longer.

Installation

If installation near a heat source is unavoidable, observe the following minimum safety distances between the appliance and the heat source:

- At least 3 cm to electric or gas stoves
- At least 30 cm to oil or coal-based stoves

If it is not possible to observe these minimum safety distances, an isolation plate must be installed between the refrigeration appliance and the heat source.

Climate range

This refrigeration appliance is designed for use within specific ambient temperatures (climate range). Do not use in ambient temperatures for which it is not designed.

A lower ambient temperature leads to the compressor switching off for longer periods. This can cause the internal temperature in the refrigeration appliance to rise with the risk of food deteriorating and going off.

The climate range is stated on the data plate in the interior cabinet of the refrigeration appliance.

Climate range	Ambient temperature
SN	10 to 32 °C
N	16 to 32 °C
ST	16 to 38 °C
T	16 to 43 °C
SN-ST	10 to 38 °C
SN-T	10 to 43 °C

A refrigeration appliance from the SN climate range can operate without any difficulties in rooms with a cooler ambient temperature (down to +5 °C).

Side-by-side combinations

 Risk of damage due to condensation on external appliance panels.

In environments with high humidity and a lack of ventilation, condensation can build up on external appliance panels, which can cause corrosion.

Do not place refrigeration appliances directly next to or on top of one another if the refrigeration appliance is not approved for this.

If you want to place refrigeration appliances without integrated heating units next to each other, a distance of at least 150 mm must be maintained between them.

Ventilation

 Fire risk and risk of damage due to inadequate ventilation.

If the refrigeration appliance is not ventilated sufficiently, the compressor will run more frequently and for longer periods. This causes increased energy consumption and an increased compressor operating temperature, which can result in damage to the refrigeration appliance.

Please ensure that there is adequate ventilation around the refrigeration appliance:

It is essential to observe the required ventilation cross-sections.

The ventilation cross-sections must not be covered or blocked in any way.

Clean the ventilation areas regularly to remove dust and dirt.

Air at the back of the refrigeration appliance gets warm. The appliance housing unit must therefore be constructed to allow sufficient space for ventilation (see “Installation dimensions” and the installation instructions).

Changing the door hinging

 Danger of injury and damage to the appliance due to heavy door.

There is an increased risk of injury and damage if the door hinging is installed by a single person.

Always change the door hinging with the help of a second person.

 Risk of crushing on the door hinge.

Fingers can get trapped in or around the hinge.

Leave the door hinge open and do not close it.

Do not reach into the door hinge during conversion.

Change the door hinge in accordance with the installation instructions.

Furniture door (valid for KFN 7934 D)

Horizontal and vertical gaps

Depending on the style of kitchen furniture, the thickness and edge radius of the furniture door and the gap that runs around the door, vertically and horizontally, are specified.

It is essential to pay attention to the following:

- Horizontal gap

The gap between the furniture door and the housing unit door above or below it must be at least 3 mm.

- Vertical gap

If the gap between the refrigeration appliance furniture door and the adjoining kitchen furniture front or wall on the hinged side is too small, the appliance door could collide with the adjoining kitchen furniture front or wall when opened.

It may be necessary to adjust the size of this gap to suit the thickness and edge radius of the furniture door.

Installation

This must be taken into consideration when planning your kitchen and when replacing an old refrigeration appliance with a new one to ensure the installation conditions required are met.

Furniture door thickness A [mm]	Gap X [mm] for different edge radii B			
	R0	R1	R2	R3
≥16–19	2.5			
20	3	3	2.5	2.5
21	3	3	2.5	2.5
22	4	3.5	3	3

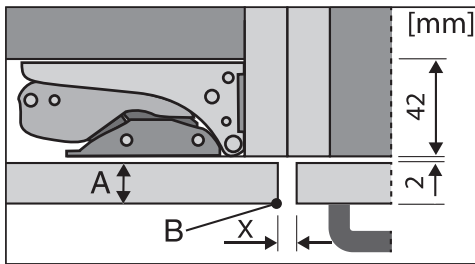

Adjoining kitchen furniture front

- A = Furniture front thickness
- B = Edge radius
- X = Gap

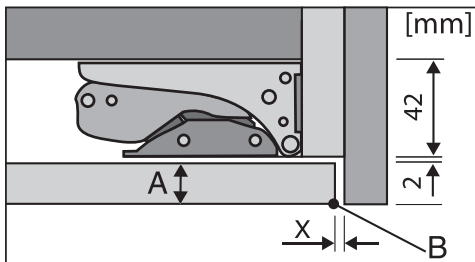

Adjoining side wall

- A = Furniture front thickness
- B = Edge radius
- X = Gap

Tip: Fit a spacer between the housing unit carcass and the side wall. This way you will get a sufficiently wide gap.

Weight of the furniture door

⚠ If the furniture door panel is too heavy, this can cause damage. Fitting a furniture door panel which is heavier than the maximum permitted weight could damage the hinges. This can cause subsequent functional problems.

The maximum permissible weights of the furniture doors in kg are:

Refrigeration appliance	Upper furniture door	Lower furniture door
KFN 7934 D	20	19

Building-in dimensions

Installation in a tall unit/side view

KFN 7934 D

All dimensions are given in mm.

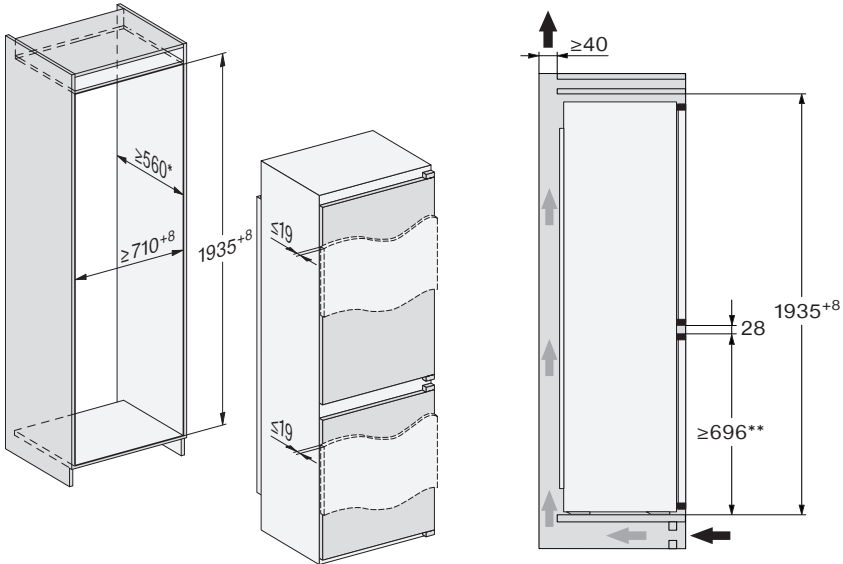

* The declared energy consumption was calculated in a 560 mm deep niche. The refrigeration appliance is fully functional in a 550 mm niche but the energy consumption will be slightly higher.

** Miele has different refrigeration appliances with different gap positions in its range. To increase flexibility when replacing the appliance at a later date, we recommend that the height of the lower furniture front should be between 696 and 706 mm. The position of the door gap may shift when the appliance is replaced.

Before installation, ensure the housing unit dimensions are the correct size. The specified ventilation cross-sections must be adhered to in order to ensure the correct functioning of the refrigeration appliance.

Installation

KFN 7913 E

All dimensions are given in mm.

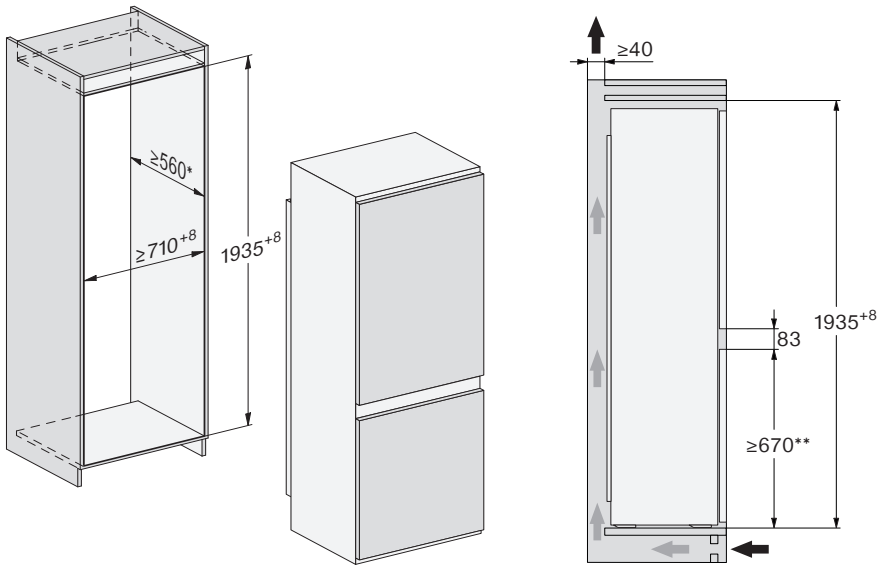

* The declared energy consumption was calculated in a 560 mm deep niche. The refrigeration appliance is fully functional in a 550 mm niche but the energy consumption will be slightly higher.

** Miele has different refrigeration appliances with different gap positions in its range. To increase flexibility when replacing the appliance at a later date, we recommend that the height of the lower furniture front should be between 696 and 706 mm. The position of the door gap may shift when the appliance is replaced.

Before installation, ensure the housing unit dimensions are the correct size. The specified ventilation cross-sections must be adhered to in order to ensure the correct functioning of the refrigeration appliance.

Connections and ventilation

KFN 7913 E

All dimensions are given in mm.

The specified ventilation cross-sections must be adhered to in order to ensure the correct functioning of the refrigeration appliance.

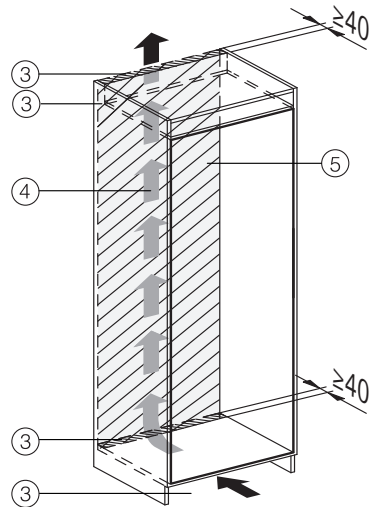
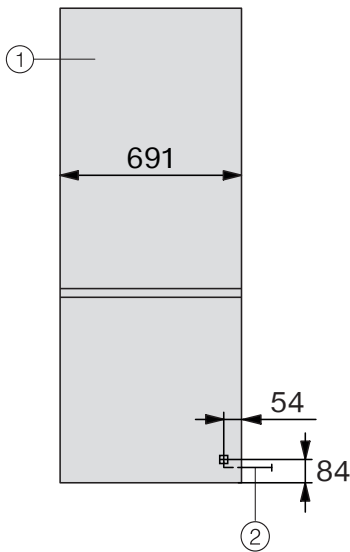

- ① View from the front
- ② Mains connection cable, length = 2300 mm
A longer mains connection cable is available to order from the Miele Customer Service Department.
- ③ Ventilation cross-section min. 200 cm²
- ④ Ventilation
- ⑤ No connection sockets in this area

Installation

KFN 7934 D

All dimensions are given in mm.

The specified ventilation cross-sections must be adhered to in order to ensure the correct functioning of the refrigeration appliance.

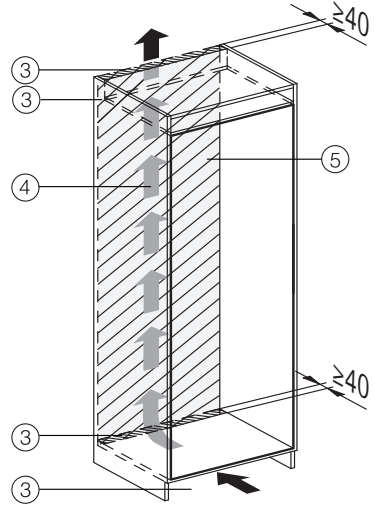
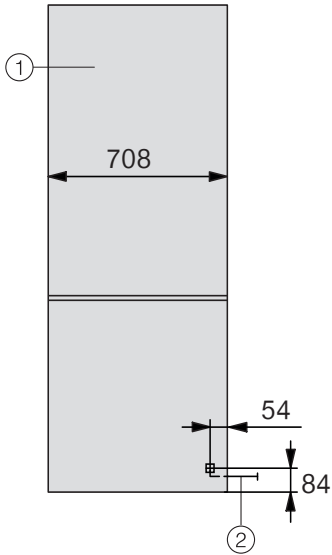

- ① View from the front
- ② Mains connection cable, length = 2300 mm
A longer mains connection cable is available to order from the Miele Customer Service Department.
- ③ Ventilation cross-section min. 200 cm²
- ④ Ventilation
- ⑤ No connection sockets in this area

Electrical connection

The refrigeration appliance must only be connected to an earthed socket using the mains connection cable supplied.

The socket must be easily accessible after the refrigeration appliance has been installed. If the socket is not easily accessible, ensure that a suitable means of disconnection is provided on the installation side for each pole.

 Risk of fire from overheating.

Connecting the refrigeration appliance to a multi-socket plug adapter or to an extension lead can overload the cable.

For safety reasons, do not use an extension lead or multi-socket adapter.

The electrical installation must comply with VDE 0100 requirements.

For safety reasons, we recommend using a type  residual current device (RCD) in the assigned electrical installation for connecting the refrigeration appliance.

If the mains connection cable is damaged, it must only be replaced with a specific mains connection cable of the same type (available from the Miele Customer Service Department). For safety reasons, such replacement may only be carried out by a qualified specialist or the Miele Customer Service Department.

These operating instructions and the data plate indicate the nominal power consumption and the appropriate fuse rating. Compare this information with the data of the on-site electrical connection. If in any doubt, consult a qualified electrician.

Temporary or permanent operation on an autonomous power supply system or a power supply system that is not synchronised with the mains power supply (e.g. island networks, back-up systems) is possible. A prerequisite for operation is that the power supply system complies with the specifications of EN 50160 or an equivalent standard. The function and operation of the protective measures provided in the domestic electrical installation and in this Miele product must also be maintained in isolated operation or in operation that is not synchronised with the mains power supply, or these measures must be replaced by equivalent measures in the installation. As described, for example, in the current version of VDE-AR-E 2510-2.

Connecting the refrigeration appliance

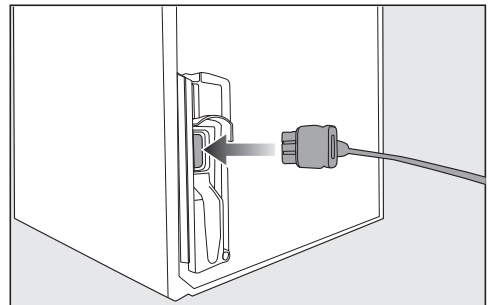

- Insert the plug connector into the socket at the back of the refrigeration appliance.

Make sure that the plug connector has clicked into position correctly.

- Insert the plug of the refrigeration appliance into the socket.

The refrigeration appliance is now connected to the electricity supply.

Familiarisation

Your refrigeration appliance: KFN 7913 E

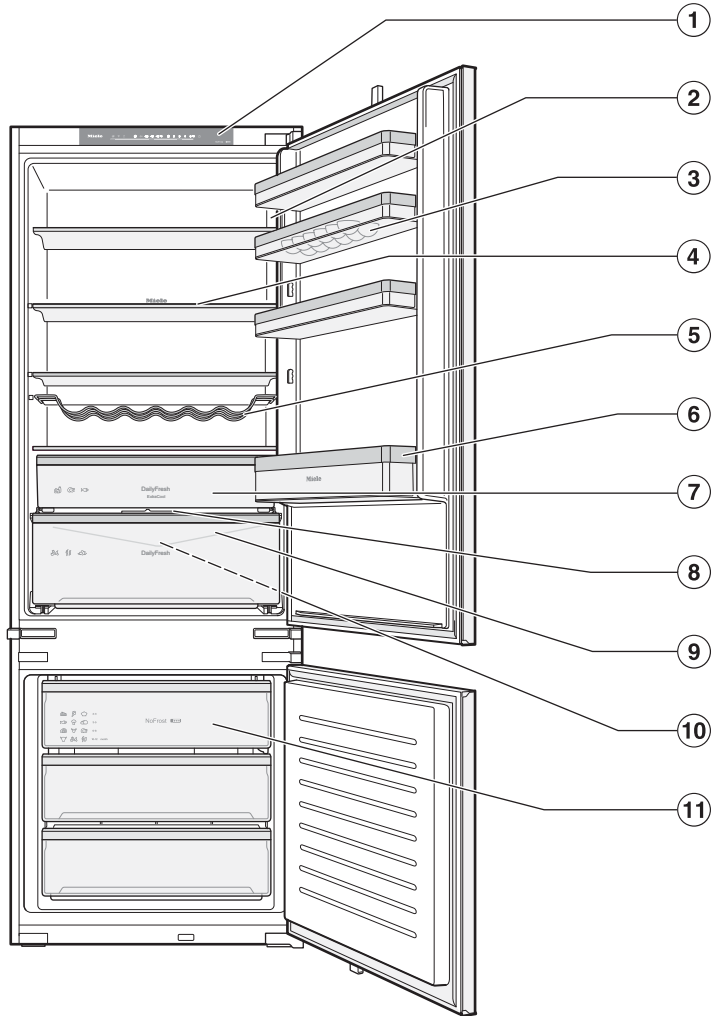

- ① Control panel
- ② Door shelf with egg tray
- ③ Interior lighting
- ④ Flexible bottle rack
- ⑤ Adjustable shelf
- ⑥ Bottle shelf
- ⑦ DailyFresh ExtraCool drawer with low temperature for food which goes off quickly
- ⑧ Compartment lid for setting the humidity level in the DailyFresh drawer
- ⑨ Condensate channel and condensate drain hole:
Precipitated condensate runs off and evaporates automatically.
- ⑩ DailyFresh drawer for fruit and vegetables (humidity-controlled)
- ⑪ Freezer drawers

Familiarisation

Your refrigeration appliance: KFN 7934 D

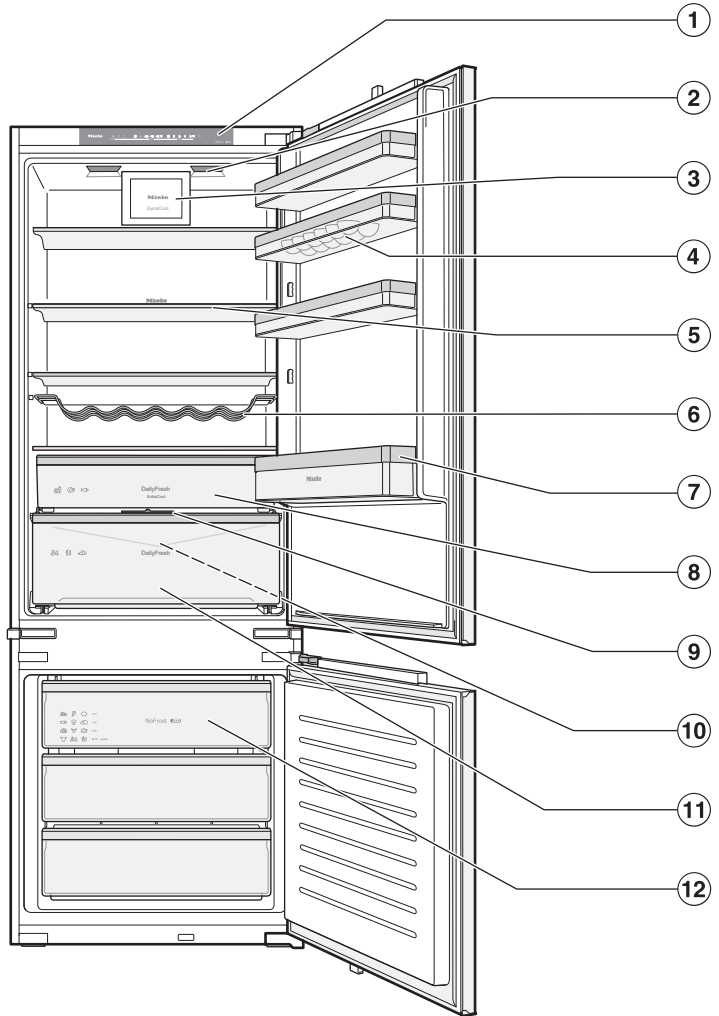

- ① Control panel
- ② Door shelf with egg tray
- ③ Fan (DynaCool)
- ④ Flexible bottle rack
- ⑤ Interior lighting
- ⑥ Adjustable shelf
- ⑦ Bottle shelf
- ⑧ DailyFresh ExtraCool drawer with low temperature for food which goes off quickly
- ⑨ Compartment lid for setting the humidity level in the DailyFresh drawer
- ⑩ Condensate channel and condensate drain hole:
Precipitated condensate runs off and evaporates automatically.
- ⑪ DailyFresh drawer for fruit and vegetables (humidity-controlled)
- ⑫ Freezer drawers

Familiarisation

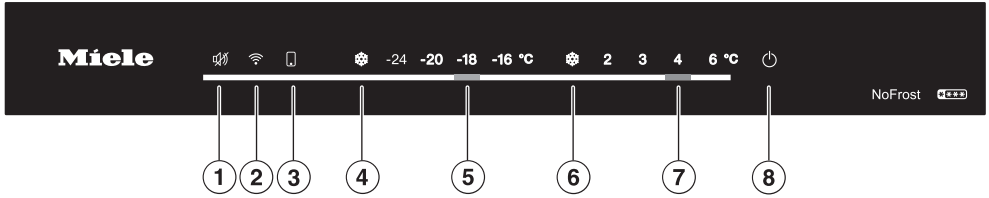

- ① For switching the temperature and door alarm off
- ② For switching the network connection to your home network (WiFi) on and off
- ③ Lights up if you have made settings via the Miele app
(Further information on possible settings can be found in the Miele app.)
- ④ Switching the SuperFreeze function on and off
- ⑤ For setting the temperature in the freezer zone
- ⑥ Switching the SuperCool function on and off
- ⑦ For setting the temperature in the fridge zone
- ⑧ For switching the refrigeration appliance on and off
(press and hold the button for 3 seconds)

Safety

Temperature alarm in the freezer zone

The refrigeration appliance has been fitted with a temperature alarm so that the temperature in the freezer zone cannot rise unnoticed.

If the temperature becomes too warm, the temperature display for the freezer zone flashes and the LED below the  button lights up.

An alarm will also sound until the cause of the alarm is rectified or the alarm is switched off.

The temperature the refrigeration appliance is set at determines the temperature the appliance recognises as being too warm.

The temperature alarm may be triggered in the following situations:

- You switch on the refrigeration appliance and the temperature differs greatly from the set temperature.
- Too much warm ambient air enters the freezer when you are rearranging or taking out frozen food.
- You are freezing large amounts of food at once.
- You are freezing warm food.

Switching the temperature alarm off early

Before you switch the temperature alarm off, you must determine the cause and rectify it.

If you are bothered by the sound of the alarm, you can switch the alarm off early.

- Press the  button.
- Check whether the food in the freezer has started to thaw or has defrosted. If it has, it should be used as soon as possible. Defrosted food may only be re-frozen after it has been cooked.

Door alarm

The refrigeration appliance is fitted with a door alarm to avoid increased energy consumption and food becoming warm if the door is left open.

Depending on which of the two appliance doors is open for longer than 2 minutes, the temperature display for the freezer zone or the fridge zone flashes. The LED below the  button flashes.

An alarm also sounds.

 You can change the time before the door alarm is triggered via the Miele app.

As soon as the appliance door is closed, the alarm will stop and the LED below the  button will go out.

Switching the door alarm off early

If you are bothered by the sound of the alarm, you can switch the alarm off early.

- Press the  button.

The alarm will stop. The LED below the  button goes out as soon as the appliance door is closed.

If the appliance door is not closed, the alarm will sound again after 2 minutes.

Familiarisation

Appliance functions

SuperCool ❄️

When switched on, the SuperCool ❄️ function can be used to rapidly reduce the temperature in the **fridge zone** to its lowest setting (depending on the ambient temperature). The refrigeration appliance will work at full power and lower the temperature.

Select the SuperCool ❄️ function for the rapid chilling of large amounts of fresh food or drink.

The SuperCool ❄️ function should be switched on **immediately before placing** food or drinks in the fridge zone.

The SuperCool ❄️ function will switch itself off automatically after approx. 6 hours. The refrigeration appliance will then run at normal power again.

SuperFreeze ❄️

When switched on, the SuperFreeze ❄️ function can be used to rapidly reduce the temperature in the **freezer zone** to its lowest setting (depending on the ambient temperature). The refrigeration appliance will work at full power and lower the temperature.

Select the SuperFreeze ❄️ function before freezing fresh food. This helps food to freeze quickly and retain its nutrients, vitamins, flavours and appearance.

The SuperFreeze ❄️ function should be switched on **4–6 hours before placing food in the freezer**. If you are freezing the **maximum amount of food**, the SuperFreeze ❄️ function should be switched on **24 hours beforehand**.

The SuperFreeze ❄️ function will switch itself off automatically after a maximum of 50 hours. The quantity of fresh food placed in the freezer will determine the duration before the SuperFreeze ❄️ function switches off.

Automatic SuperFreeze ❄️

The automatic SuperFreeze ❄️ function is activated by default and can be deactivated at any time.

If you place a large amount of (warm) food in the freezer zone and the temperature in the freezer zone rises, the SuperFreeze ❄️ function switches on **automatically** for a while.

The LED below the SuperFreeze ❄️ button lights up.

Ideally, place the food in the right-hand section of the freezer drawers.

Sabbath mode

The refrigeration appliance offers a Sabbath mode for the purposes of religious observance.

When Sabbath mode is switched on, the following are deactivated temporarily:

- Interior lighting when the appliance door is opened
- All visual and audible signals
- All messages in the control panel (Exception: the LED below the SuperFreeze ❄️ button lights up with reduced brightness.)
- An active WiFi connection
- The SuperCool, SuperFreeze and Automatic SuperFreeze functions

All other functions switched on previously remain activated.

When Sabbath mode is switched on, you cannot make any settings on your refrigeration appliance.

Adjusting the interior fittings

Removing or moving the door shelves/bottle shelf

Only move the door shelves/bottle shelves in the appliance door when they are empty.

- Push the door shelves/bottle shelves upwards, then remove them by pulling them forwards.
- Replace the door shelves/bottle shelves at the required height.

Removing or moving the shelves

The shelves can be adjusted according to the height of the food.

- Lift the front of the shelf and pull it out.
- Fit the shelf in its new position with the rear edge facing upwards. The raised edge at the back must face upwards to prevent food from touching the rear panel of the appliance and freezing to it.

Removing the DailyFresh ExtraCool drawer

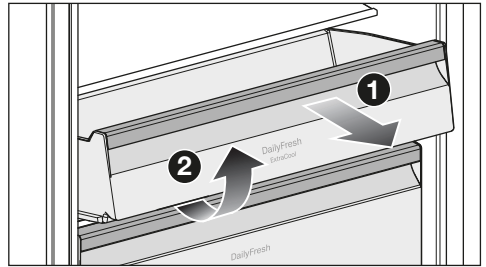

- Pull the DailyFresh ExtraCool drawer out as far as it will go ❶ and then lift it up and out ❷.

Removing the DailyFresh drawer

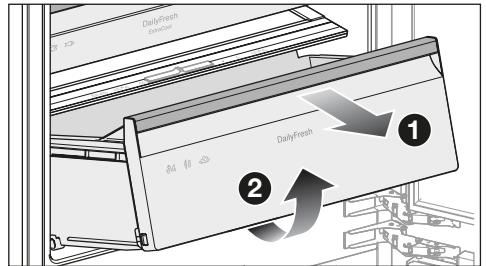

- Remove the bottle shelf from the appliance door.
- Pull the DailyFresh drawer out as far as it will go ❶ and then lift it up and out ❷.

Removing the freezer drawer

- Pull the freezer drawer out as far as it will go and then lift it up and out.

Familiarisation

Moving the variable bottle rack

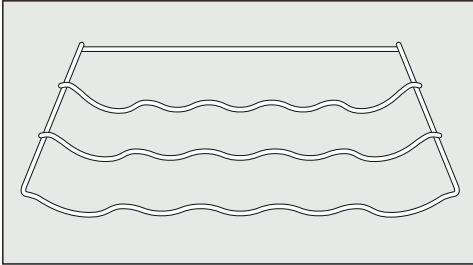

- Lift the bottle rack up slightly at the back and pull it out towards you.
- Reinsert the bottle rack in the desired position.

The rear rail must face upwards to prevent bottles from touching the rear panel of the appliance.

Accessories supplied

Appliance plug

Egg tray

Flexible bottle rack

Ice cube tray

Optional accessories

Products specially tailored to your refrigeration appliance – such as appliance care products and accessories – are available from the Miele online shop, from Miele Customer Service or from your Miele specialist dealer.

You can access the Miele online shop via the following QR code:



Before using for the first time

- Remove all packaging material and protective foil.
- Remove all advertising materials and labels from the inside of the refrigeration appliance.
- Clean the inside of the appliance and the accessories.

Connecting the refrigeration appliance

- Connect the refrigeration appliance to the mains power supply as described in “Installation – Electrical connection”.

The refrigeration appliance will power up slowly.



The preset temperatures will then appear in the temperature displays for the fridge zone and freezer zone.

The refrigeration appliance is now ready for operation.

The refrigeration appliance will start to cool and the interior lighting will come on when the appliance door is opened.

To enable the temperature to get sufficiently cold inside the refrigeration appliance, allow the appliance to run for a few hours before placing food in it.

Switching the refrigeration appliance on

- If the refrigeration appliance was previously switched off using the  button, press the  button for 3 seconds so that all LEDs on the control panel light up once.

A buzzer sounds and the preset temperatures light up in the temperature display.

The refrigeration appliance will start to cool and the interior lighting will come on when the appliance door is opened.

As soon as the set temperature in the freezer zone is reached, the LED below the  button goes out. The temperature display of the freezer zone lights up constantly and the alarm stops.

- If you want to switch off the alarm early, press the  button.

To enable the temperature to get sufficiently cold inside the refrigeration appliance, allow the appliance to run for a few hours before placing food in it. Do not place food in the refrigeration appliance until it has reached the preset temperature.

Do not place food in the freezer zone until it has reached the preset temperature (min. -18 °C).

After switching on the refrigeration appliance, wait approx. 3 minutes before networking the appliance. Only then is the initialisation of the refrigeration appliance complete.

Switching the refrigeration appliance off

- Press the  button for 3 seconds so that all LEDs in the control panel go out.

A buzzer sounds.

The cooling system and the interior lighting are switched off.

Please note: The refrigeration appliance is not disconnected from the power supply when it is switched off.

Commissioning

Switching off for longer periods of time

If, during a long absence, the refrigeration appliance is switched off but not cleaned and the door is left shut, there is a danger of mould building up inside the appliance.

It is essential to clean the refrigeration appliance before a long period of absence.

If the refrigeration appliance is not going to be used for a longer period of time, observe the following:

- Switch the refrigeration appliance off.
- Switch off at the wall and disconnect the plug from the socket, or disconnect the fuse.
- Clean the refrigeration appliance and leave the door ajar to air the appliance and avoid odours building up inside.

Setting the temperature in the fridge zone

Tip: We recommend a temperature of **4 °C** in the fridge zone.

A temperature setting of 4 °C combined with appropriate hygiene measures delays the propagation of bacteria, e.g. salmonella and listeria, which can lead to serious food poisoning.

As a general rule, the colder the set temperature, the longer the food you store in the fridge zone will keep.

- Touch the desired temperature for the fridge zone.

Temperature range in the fridge zone

The temperature in the fridge zone can be adjusted from **2 to 6 °C**.

 You can use the Miele app to make further settings for the temperature in the fridge zone.

Temperature display

The temperature display on the control panel always shows the **desired** temperature.

Depending on the ambient temperature and the temperature setting, it can take the appliance a few hours to reach the desired temperature.

The temperature in the fridge zone increases:

- The more often the appliance door is opened and the longer it is kept open
- The more food is stored in it

- The warmer the food is which is being put into it
- The higher the ambient temperature surrounding the refrigeration appliance This refrigeration appliance is designed for use within specific ambient temperatures (climate range). Do not use in ambient temperatures for which it is not designed.

Switching SuperCool ❄ on

The SuperCool ❄ function should be switched on immediately before placing food or drinks in the fridge zone.

- Press the SuperCool ❄ button.

The LED below the SuperCool ❄ button lights up.

Switching SuperCool ❄ off

The SuperCool ❄ function will switch itself off automatically after max. 6 hours.

To save energy, you can switch off the SuperCool ❄ function early yourself once food and drinks are sufficiently chilled.

- Press the SuperCool ❄ button.

The LED below the SuperCool ❄ button goes out.

Operation

Setting the temperature in the freezer zone

 Health risk caused by decomposing food.

To freeze fresh food, a temperature of **-18 °C** is required. Please note that, if the temperature is any warmer, the food will have a shorter shelf life.

When freezing food and storing it over the long term, set a minimum temperature of **0 °F (-18 °C)**.

Tip: By keeping the freezer zone at a constant temperature of -18 °C and taking appropriate hygiene measures you can maximise the storage life of your food and avoid food waste.

- Touch the desired temperature for the freezer zone

Temperature range in the freezer zone

The temperature in the freezer zone can be adjusted from **-16 °C** to **-24 °C**.

Temperature display

The temperature display on the control panel always shows the **desired** temperature.

Depending on the ambient temperature and the temperature setting, it can take the appliance a few hours to reach the desired temperature.

The temperature in the freezer zone increases:

- The more often the appliance door is opened and the longer it is kept open
- The more food is stored in it

- The warmer the food is which is being put into it
- The higher the ambient temperature surrounding the refrigeration appliance This refrigeration appliance is designed for use within specific ambient temperatures (climate range). Do not use in ambient temperatures for which it is not designed.

Switching SuperFreeze ❄ on

The SuperFreeze ❄ function should be switched on around **4–6 hours before placing** food in the freezer. If you are freezing the maximum amount of food, the SuperFreeze ❄ function should be switched on 24 hours beforehand.

You do **not** need to switch on the SuperFreeze ❄ function:

- If you are placing food that is already frozen in the freezer.
- If you only freeze up to 2 kg of fresh food daily.

- Press the SuperFreeze ❄ button.

The LED below the SuperFreeze ❄ button lights up.

Switching SuperFreeze ❄ off

The SuperFreeze ❄ function will switch itself off automatically after max. 50 hours.

To save energy, you can switch off the SuperFreeze ❄ function early yourself once food and drinks are sufficiently chilled.

- Press the SuperFreeze ❄ button.

The LED below the SuperFreeze ❄ button goes out.

Cancelling automatic SuperFreeze ❄️

- Press the SuperFreeze ❄️ button.

The LED below the SuperFreeze ❄️ button goes out.

Switching on automatic SuperFreeze ❄️

- Press the SuperFreeze ❄️ button for 5 seconds until a buzzer sounds.
- Release the SuperFreeze ❄️ button.

2 buzzers sound one after the other. The automatic SuperFreeze ❄️ function is switched on.

Switching off automatic SuperFreeze ❄️ completely

- Press the SuperFreeze ❄️ button for 5 seconds until a buzzer sounds.
- Release the SuperFreeze ❄️ button.

3 buzzers sound one after the other. The automatic SuperFreeze ❄️ function is switched off.

Storing food in the fridge zone

 Risk of explosion due to flammable mixes of gases.

Electrical components can cause flammable mixes of gases to ignite.

Do not store explosive materials in the refrigeration appliance or any products containing propellants (e.g. spray cans). The spray cans in question can be identified by the contents printed on the can or by a flame symbol. Electrical components can cause escaping gases to ignite.

 Risk of damage due to greasy or oily foods.

If storing food which contains a lot of fat or oil in the refrigeration appliance or the appliance door, make sure that it does not come into contact with plastic components as this could cause stress cracks or break the plastic.

Make sure that no fat or oil leaks onto the plastic parts of the refrigeration appliance.

If there is insufficient air circulation, the cooling performance will decrease and energy consumption will increase.

To allow air to circulate efficiently, do not store the food too close together or in direct contact with the rear panel.

Operation

Different storage zones

Due to natural air circulation, there are different temperature regions in the refrigerator section.

Cold, heavy air sinks to the lowest section of the refrigeration section. Make use of the different zones when placing food in the appliance.

Warmest area

The warmest area in the refrigerator section is at the top in the front area and in the door. Use this for storing butter and cheese.

Coldest area

The coldest area in the fridge zone is in the DailyFresh ExtraCool drawer and at the back of the appliance.

A temperature setting of 4 °C combined with appropriate hygiene measures delays the propagation of bacteria, e.g. salmonella and listeria, which can lead to serious food poisoning.

Therefore, you should use these areas to store all delicate and highly perishable food, including:

- Fish, meat, poultry
- Cold cuts, ready meals
- Dishes or baked goods containing eggs or cream
- Fresh dough, cake mixtures, pizza or quiche dough
- Raw milk cheese and other raw milk products
- Hummus, vegetable spreads, plant-based cream cheese substitutes

- Pre-packed vegetables
- Other fresh food (with a label stating it should be kept at a temperature of approx. 4 °C)

Tip: Store food in such a way that it does not touch the rear panel of the fridge zone. Otherwise it could freeze to the rear panel.

Temperature indicator for the coldest area

The temperature indicator for the coldest area is located on the left-hand or right-hand inside wall in the coldest area of the fridge zone. You can use the temperature indicator to check the temperature in this area for your delicate and highly perishable food. If the temperature settings are correct, the lowest average temperature will be in the coldest area (between the temperature indicator and the shelf below). This low temperature, combined with appropriate hygiene measures, delays the propagation of bacteria, e.g. salmonella and listeria, which can lead to serious food poisoning.

After initial commissioning of the refrigeration appliance, it may take up to 12 hours before the desired temperature is reached.

The temperature indicator will not display an accurate reading if the appliance door is opened frequently or for long periods. Do not keep the appliance door open for long periods. Check the temperature indicator again after a few hours.

Temperature indicator display



If the temperature indicator displays “OK”, the temperature is set correctly. Your delicate and highly perishable food will be refrigerated properly in this area.

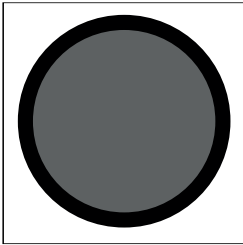

If the temperature indicator does not display “OK”, the temperature is too high. Lower the temperature.

If the ambient temperature fluctuates significantly, check the temperature indicator more frequently. If necessary, adjust the temperature again.

Tip: If the temperature indicator does not display “OK” even when the temperature is set as low as possible and this has been repeatedly checked, contact the Customer Service Department. The temperature indicator is damaged and correct storage of your delicate and highly perishable food cannot be ensured.

Should food be stored loose or in packaging?

Ensure that food stored in the fridge zone is in packaging or covered properly (some exceptions apply in the DailyFresh drawer).

This will prevent food odours from affecting other food, stop food from drying out and also prevent any cross-contamination of germs. This is particularly important when storing meat products. Make sure that food such as raw meat and fish in particular does not come into contact with other food.

By ensuring that the temperature settings are correct and by taking appropriate hygiene measures, you can prolong the storage life of your food considerably. This prevents food waste.

Protein-rich food

Please note that food rich in protein deteriorates faster than other types of food. Shellfish, for example, deteriorates faster than fish, and fish deteriorates faster than meat.

Operation

DailyFresh ExtraCool drawer

The DailyFresh ExtraCool drawer is ideal for storing food which goes off quickly, such as:

- Fresh fish and shellfish
- Meat, poultry and sausage
- Deli salads
- Dairy products, such as yogurt, cheese, cream, etc.
- You can also store any other type of food in the DailyFresh ExtraCool drawer, as long as it is **packaged**.

The DailyFresh ExtraCool drawer has a temperature of approx. **0 °C** when a temperature of **2 °C** has been set in the fridge zone.

The humidity in the DailyFresh ExtraCool drawer is not increased and cannot be regulated.

The temperature in the DailyFresh ExtraCool drawer is approx. 0 °C (depending on the temperature set in the fridge zone).

This means that sub-zero temperatures can be reached under certain circumstances. This can cause food to freeze.

Adjust the temperature setting if necessary.

Please note that food rich in protein deteriorates faster than other types of food.

Shellfish, for example, deteriorates faster than fish, and fish deteriorates faster than meat.

For hygiene reasons, always keep these foods **covered or wrapped**.

The DailyFresh drawer provides good storage conditions for fruit and vegetables.

The humidity level in the DailyFresh drawer can also be regulated to suit the food being stored. Food retains its own moisture if stored at a higher humidity and so does not dry out as quickly. The temperature is approximately equivalent to the temperature in the fridge zone.

Remember that the fresher the food when placed in the appliance, the longer it will stay fresh.

Changing the humidity level in the DailyFresh drawer

The humidity level in the DailyFresh drawer largely depends on the type and quantity of food being stored, if stored **unwrapped**.

Tip: If the quantity of food being stored in this compartment is **small**, the humidity level may be too low. If you are only storing a small amount of food, wrap it in airtight packaging.

Tip: Store **cut** fruit or vegetables covered or wrapped so they do not dry out.

Selecting low humidity δ

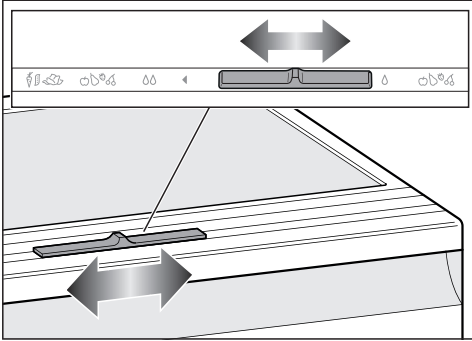

- Slide the controller to the right.

The compartment lid is open and the humidity drops δ .

- Always select this setting if:
 - A large amount of food is being stored in the drawer
 - Different types of food are being stored in the drawer
 - Most of the food being stored in the drawer is fruit
 - The humidity level in the DailyFresh drawer is too high.

Selecting increased humidity $\delta\delta$

- Slide the controller to the left.

The compartment lid is closed and the humidity remains in the compartment $\delta\delta$.

- Select this setting if:
 - A small amount of food is being stored in the drawer
 - Most of the food being stored in the drawer is vegetables
 - The humidity level in the DailyFresh drawer is too low.

Increased moisture in the DailyFresh drawer can, in some circumstances, cause a build-up of condensate.

If you find that too much condensate has formed and this is affecting the food, proceed as follows:

Wipe off any condensate with a cleaning cloth.

Open the compartment lid by moving it to the low humidity δ position.

Freezing and storing fresh food

Maximum freezing capacity

To ensure that fresh food placed in the freezer freezes through to the core as quickly as possible, the maximum freezing capacity must not be exceeded. The maximum freezing capacity for freezing within a 24-hour period is given on the data plate: "Freezing capacity ... kg/24 hrs".

Before placing food in the freezer

Only freeze fresh food which is in good condition.

- When freezing more than 2 kg of fresh food, switch on the SuperFreeze function ❄ for 6 hours before placing the food in the freezer.
- When freezing even larger amounts of food, switch on the SuperFreeze function ❄ for 24 hours before placing the food in the freezer.

This helps the frozen food which is already stored in the freezer to stay frozen.

Operation

Placing food in the freezer

Unfrozen food should not touch frozen food as this will cause the frozen food to begin to thaw.

- Always place the food in the bottom freezer drawer first.
- To prevent food sticking together when frozen, make sure that the packaging and containers are dry.

Always push in the freezer drawer as far as it will go to allow the air to circulate freely in the refrigeration appliance.

To ensure that food freezes through to the core quickly, do not exceed the following packaging and container sizes:

- Fruit and vegetables: max. 1 kg
- Meat: max. 2.5 kg

– Freezing large items of food

Tip: You can expand the space available in the freezer zone, e.g. to freeze large items such as a turkey or large piece of game.

- Remove the freezer drawers from the freezer zone.
- Place the food directly on the bottom of the freezer zone.

After freezing fresh food

- Switch the SuperFreeze function ❄ off.

Making ice cubes

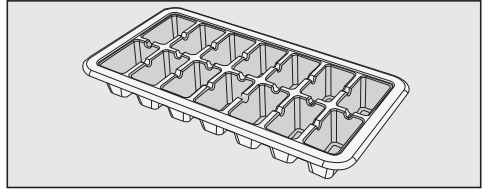

- Fill the ice cube tray 3/4 full with water and place it on the bottom of one of the freezer drawers.
- Once frozen, use a blunt instrument, for example a spoon handle, to remove the ice tray from the freezer if it is stuck.

Tip: Ice cubes can be removed easily from the tray by twisting the tray gently or by holding it under cold running water for a short time.

Cooling drinks quickly

- When cooling drinks quickly in the freezer zone, make sure bottles are not left in for **more than 1 hour**. Otherwise they could burst.

Tip:  You can use the Miele app to make additional settings on your refrigeration appliance. You can find more information on this in the Miele app.

To do this, your refrigeration appliance must be networked and registered in the Miele app.

Observe the “Warning and safety notes” in these operating and installation instructions and ensure that the safety notes are also observed when operating the refrigeration appliance with the Miele app.

Switching Sabbath mode on

When Sabbath mode is switched on, you cannot make any settings on your refrigeration appliance.

- Press the SuperFreeze  button for 15 seconds until a second buzzer sounds (the first buzzer sounds after 5 seconds).

The LED below the SuperFreeze  button lights up with reduced brightness.

All other LEDs in the control panel go out. Sabbath mode is switched on.

Ensure that the appliance doors are properly closed, as visual and audible alarms are switched off.

 Health risk caused by decomposing food.

As power cuts are not indicated while Sabbath mode is active, food may be exposed to increased temperatures for a certain period of time. This will reduce the storage life of the food.

If there is a power cut during Sabbath mode, check the quality of the food.

Switching Sabbath mode off

The Sabbath mode function will switch off automatically after approx. 80 hours.

However, you can switch the Sabbath mode function off early.

- Press the SuperFreeze  button for 15 seconds until a buzzer sounds.

The LEDs for the preset temperatures light up.

Sabbath mode is switched off.

The appliance connects to the WiFi if it was previously connected to the WiFi.

Adjusting settings

Miele@home

Your refrigeration appliance is equipped with an integrated WiFi module.

Networking is deactivated at the factory.

To use this feature, you will need:

- A WiFi network
- The Miele app
- A Miele user account. You can create a user account via the Miele app.

The Miele app will guide you as you connect your refrigeration appliance to your home WiFi network.

Once the refrigeration appliance is connected to your WiFi network, you can use the Miele app to carry out the following activities, for example:

- Call up information on the operating status of your refrigeration appliance
- Change the settings on your refrigeration appliance
- Make additional settings on your refrigeration appliance

Connecting your refrigeration appliance to your WiFi network will increase energy consumption, even when the appliance is switched off.

Make sure that the signal of your WiFi network is sufficiently strong in the place where you want to set up your refrigeration appliance.

Availability of the WiFi connection

The WiFi connection shares a frequency range with other appliances (including microwave ovens and remote control toys). This can give rise to sporadic or even complete connection failures. Therefore, the availability of featured functions cannot be guaranteed.

Miele@home availability

The ability to use the Miele app depends on the availability of the Miele@home service in your country.

The Miele@home service is not available in every country.

For information about availability, please visit www.miele.com.

Miele App

The Miele App is available to download free of charge from the Apple App Store® or from the Google Play Store™.



Performing Scan & Connect

- Scan the QR code.

If you have installed the Miele app and have a user account, you will be taken directly to the networking steps.

If you have not yet installed the Miele app, you will be taken to the Apple App Store® or the Google Play Store™.

- Install the Miele app and set up a user account.
- Scan the QR code again.

The Miele app will guide you through the setup process.



Setting up the WiFi connection for the first time

- Press the  button for 2 seconds until a buzzer sounds.

The  symbol will flash while the connection is being established. The symbol will light up once the connection has been established.

Activating the WiFi connection

- Press the  button.

The LED below the  button lights up.

Deactivating the WiFi connection

- Press the  button.

The LED below the  button goes out.

Resetting the network configuration

If there are connection problems between your refrigeration appliance and your WiFi network, you can reset the network configuration.

- Press and hold the  button for 6 seconds until you hear 2 buzzers.

The LED below the  button goes out.

All entered settings and values for Miele@home are reset to the default settings.

The WiFi connection has been deactivated.

Cleaning and care

The data plate located inside the interior cabinet of the refrigeration appliance must not be removed. It contains information which is required in the event of a fault.

Do not let water get into the electronic unit or the lighting.



! Risk of damage due to moisture ingress.

The steam from a steam cleaner can damage plastic and electrical components.

Do not use a steam cleaner to clean the refrigeration appliance.

Cleaning water must not get into the drain hole.

Cleaning agents

Cleaning and conditioning agents used in the interior cabinet of the refrigeration appliance must be food safe.

To avoid damaging the surfaces of the appliance, **do not use the following:**

- Cleaning agents containing soda, ammonia, acids or chlorides
- Cleaning agents containing descaling agents
- Abrasive cleaning agents (e.g. scouring powder, scouring liquid or pumice stones)
- Cleaning agents containing solvents
- Stainless steel cleaners
- Dishwasher cleaner
- Oven sprays
- Glass cleaning agents
- Hard, abrasive sponges and brushes (e.g. pot scourers)
- Eraser stain remover blocks
- Sharp metal scrapers

We recommend using a clean sponge and lukewarm water with a little washing-up liquid to clean the surfaces of the appliance.

Preparing the refrigeration appliance for cleaning

- Switch the refrigeration appliance off.
- Take any food out of the refrigeration appliance and store it in a cool place.
- Take out any removable parts for cleaning.

Cleaning the interior of the appliance

The refrigeration appliance should be cleaned regularly (at least once a month).

If soiling is left on for any length of time, it may become impossible to remove under certain circumstances. Surfaces may suffer discolouration or damage.

It is therefore best to remove any soiling immediately.

- Clean the interior with a clean sponge cloth, lukewarm water and a little washing-up liquid.
- Wash all parts by hand. Do **not** wash in a dishwasher.
- After cleaning, wipe with clean water and dry with a cloth.
- Clean the condensate channel and drain hole frequently using a cotton swab or similar item to ensure that condensate can drain away freely.

To be able to clean the condensate channel and the condensate drain hole, the DailyFresh ExtraCool drawer and the compartment lid underneath must first be removed.

- Leave the door open to air the refrigeration appliance sufficiently for a short while and to prevent odour build-up.

Cleaning the condensate channel and condensate drain hole

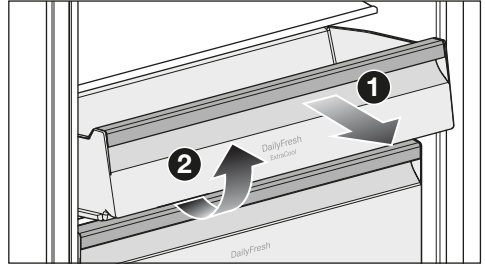

- Pull the DailyFresh ExtraCool drawer **1** out as far as it will go and then lift it up and out **2**.
- Remove the bottle shelf from the appliance door.
- Pull the DailyFresh drawer underneath out a little.
- Lift the compartment lid above the DailyFresh drawer at the front and pull the compartment lid all the way out to the front.

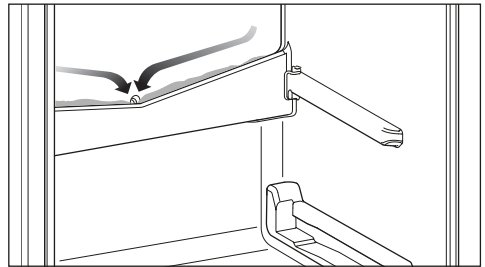

- Clean the condensate channel and drain hole using a cotton swab or similar item.
- Push the compartment lid back in above the DailyFresh drawer.

Cleaning and care

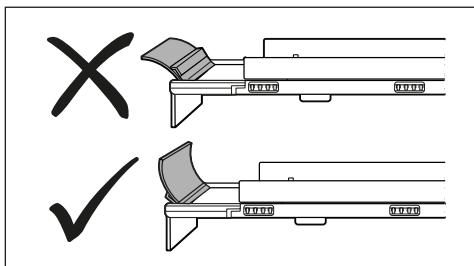

- Make sure that the spoiler on the compartment lid is positioned correctly.
- Slide the DailyFresh drawer and the DailyFresh ExtraCool drawer back in.

Removing the compartment lid on the DailyFresh drawer

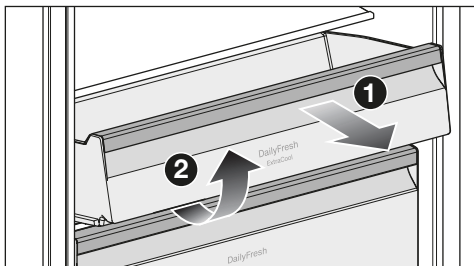

- Pull the DailyFresh ExtraCool drawer **1** out as far as it will go and then lift it up and out **2**.
- Remove the bottle shelf from the appliance door.
- Pull the DailyFresh drawer underneath out a little.
- Lift the compartment lid above the DailyFresh drawer at the front and pull the compartment lid all the way out to the front.
- After cleaning: push the compartment lid back in above the DailyFresh drawer.

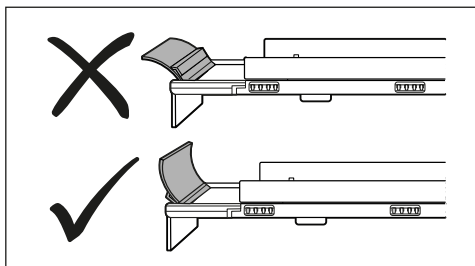

- Make sure that the spoiler on the compartment lid is positioned correctly.
- Slide the DailyFresh drawer and the DailyFresh ExtraCool drawer back in.

Dismantling drawer fronts

The drawer fronts of the DailyFresh drawer and the freezer drawers can be removed for cleaning purposes.

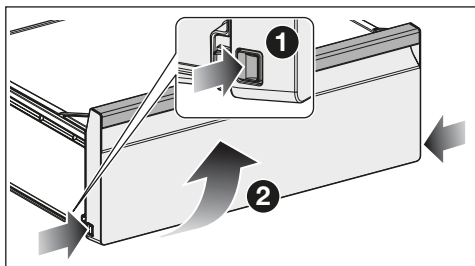

- Press in the unlocking mechanism at the bottom on both sides of the drawer front.
- Remove the drawer front by turning it forwards.

Dismantling an adjustable shelf

- Place the shelf on a worktop covered with a soft material (e.g. a tea towel).

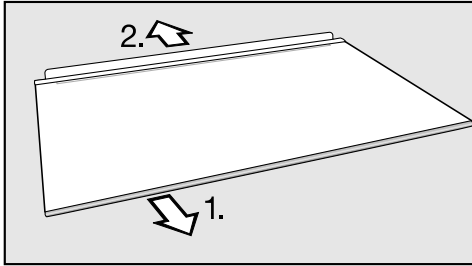

- Before cleaning the shelf, remove the trim and protective strip at the back of the shelf as follows:
 1. Pull the trim off the shelf, beginning at one side.
 2. Pull off the rear protective strip.
- After cleaning the shelf, reattach the trim and the protective strip at the back of the shelf.

Cleaning the door seal

 Risk of damage as a result of incorrect cleaning.

If you treat the door seal with oils or grease, it can become porous.

Do not use any oils or grease on the door seal.

- The door seal should be cleaned regularly with clean water, and then wiped dry with a soft cloth.

Cleaning the ventilation openings

- The ventilation openings should be cleaned on a regular basis with a feather duster or vacuum cleaner (you could use a Miele vacuum cleaner dusting brush, for example).

After cleaning

- Replace all shelves and accessories in the refrigeration appliance.
- Switch the refrigeration appliance on.
- Switch the SuperFreeze ❄️ function on for a while so that the freezer zone can cool down quickly.
- Switch the SuperCool ❄️ function on for a while so that the fridge zone can cool down quickly.
- Place food in the fridge zone and close the appliance door.
- Once the temperature in the freezer zone is cold enough, you can place the food in the freezer zone and return the drawers to the freezer.
- Switch the SuperFreeze ❄️ function off as soon as the temperature in the freezer zone is a constant $-18\text{ }^{\circ}\text{C}$ or colder.

Defrosting

Defrosting the fridge zone

The fridge zone defrosts automatically.

Keep the condensate channel and the condensate drain hole clean.

Condensate must be able to drain away unhindered at all times.

Before cleaning the condensate channel, the DailyFresh drawer and the compartment lid above it must be removed.

Defrosting the freezer zone

The refrigeration appliance is equipped with a NoFrost system that defrosts the freezer zone automatically.

Troubleshooting

Many malfunctions and faults can be easily remedied. You can save time and money in many cases, as you do not need to contact Customer Service.

More information to help you remedy faults yourself can be found at www.miele.co.uk/support/customer-assistance.



To prevent unnecessary loss of temperature it is advisable not to open the door while waiting for the appliance to be serviced.

Problem	Cause and remedy
The LEDs in the control panel light up but the refrigeration appliance is not cooling.	<p>Demo mode has been switched on. This allows the refrigeration appliance to be presented in the dealer showroom without the cooling system being switched on. This setting is not needed for domestic use.</p> <ul style="list-style-type: none"> ■ Disconnect the refrigeration appliance from the mains power supply. ■ Wait 2 minutes. ■ Reconnect the refrigeration appliance. ■ Press and hold the SuperCool ❄️ button until you hear 4 buzzers. ■ After a short time, check whether your refrigeration appliance is cooling.
The temperature in the refrigeration appliance is too low.	<p>The temperature setting in the refrigeration appliance is too low.</p> <ul style="list-style-type: none"> ■ Correct the temperature setting. <p>The SuperCool function is still switched on.</p> <ul style="list-style-type: none"> ■ Switch off the SuperCool function earlier to save energy. <p>The SuperFreeze function is still switched on.</p> <ul style="list-style-type: none"> ■ Switch off the SuperFreeze function earlier to save energy.
The temperature in the refrigeration appliance differs greatly from the set temperature.	<p>This can be caused by many factors.</p> <ul style="list-style-type: none"> ■ Switch the refrigeration appliance off. ■ Switch the refrigeration appliance back on after approx. 5 minutes. <p>If the temperature is too high, check it again after a few hours.</p> <p>If the temperature is too low, check it again the next day.</p>

Other problems

Problem	Cause and remedy
<p>The temperature display is flashing. The LED below the  button lights up in the control panel. An alarm also sounds.</p>	<p>An appliance door has been open for longer than approx. 2 minutes.</p> <ul style="list-style-type: none"> ■ Close the appliance door.
<p>The LEDs in the control panel do not light up.</p>	<p>This can be caused by many factors.</p> <ul style="list-style-type: none"> ■ Contact the Miele Customer Service Department.
<p>There was a power cut.</p>	<p>The temperature in the refrigeration appliance rises during a power cut. The storage time is reduced and the quality of your food is impaired.</p> <ul style="list-style-type: none"> ■ Keep the refrigeration appliance closed during a power cut if possible and do not store any more food inside it. ■ Check the quality of the food after the power cut. ■ Depending on the temperature displayed, you should check whether food in the freezer has started to thaw or has defrosted. If it has, it should be used as soon as possible. Defrosted food may only be re-frozen after it has been cooked. ■ If in doubt, dispose of food that has defrosted.

Troubleshooting

Interior lighting

Problem	Cause and remedy
The interior lighting is not working or is too dark.	The refrigeration appliance has not been switched on. ■ Switch the refrigeration appliance on.
	The Sabbath mode function is switched on. ■ Press the SuperFreeze ❄ button for 15 seconds until a buzzer sounds.
	The Sabbath mode function is switched off and the LEDs for the preset temperatures light up.
	The interior lighting has been dimmed via the Miele app. ■  Set the interior lighting back to maximum brightness via the Miele app. ■ Alternatively, call the Customer Service Department.



Risk of electric shock due to exposed, live electrical components.

When removing the lighting cover, there is a risk of coming into contact with live electrical components.

Do not remove the lighting cover. The LED lighting may only be repaired or replaced by the Miele Customer Service Department.



Risk of injury from LED lighting.

This lighting corresponds to risk group RG 2. If the cover is defective, there is a risk of eye injury.

If the lighting cover is defective, do not look from a close range directly into the lighting with optical instruments (e.g. magnifying glass or similar).

Information to help you rectify faults yourself and about Miele spare parts can be found at www.miele.com/service.

Contact in the event of a fault

In the event of a fault which you cannot remedy yourself, please contact your Miele dealer or Miele Customer Service.

You can book a Miele Customer Service call-out online at www.miele.com/service.

Contact information for Miele Customer Service can be found at the end of this document.

Please quote the model identifier and serial number of your appliance (SN) when contacting Miele Customer Service. Both numbers can be found on the data plate inside the refrigeration appliance or, depending on the model, in Settings mode under Information **i**.

The data plate can be found in the interior cabinet of the refrigeration appliance.

EPREL database

Since 1 March 2021, information on energy labelling and ecodesign requirements has been available in the European Product Database (EPREL). You can find the product database at the following link <https://eprel.ec.europa.eu/>. You will be asked to enter the model identifier.

The model identifier can be found on the data plate inside the refrigeration appliance or, depending on the model, in Settings mode under Information **i**.

Miele

E-Nr.: XXXXXX FD: XXXX Fab. Nr. XXXXXXXX

Type: XXXXXX XXXXXX

Kühl-/Gefriergerät/refrigerator-freezer/refrigerateur-congela-teur *** ** ***

Klasse/class/classe

Gesamtvolumen/total volume/volume total

Kühlfach/fridge comp./comp. refrigerator

Kaltlagerfach/chill comp./comp. conservateur

Kellerfach/cellar comp./comp. de rafraichissement

Tiefkühlfa./-bereich/frozen-food comp./comp. congela-teur

Gefrierfach/freezer comp./comp. congela-teur

Gefrierverm./freezing capacity/pouvoir de congelat. kg/24 h

R600a XXXXg

Warranty

For information on the appliance warranty specific to your country please contact Miele. See back cover for address.

In the UK, your appliance warranty is valid for 2 years from the date of purchase. However, you must activate your cover by calling 0330 160 6640 or registering online at www.miele.co.uk.

Information

EU Conformity declaration

Miele hereby declares that this fridge-freezer complies with Directive 2014/53/EU. The complete text of the EU declaration of conformity is available from one of the following internet addresses:

- Products, Download from www.miele.ie
- For service, information, operating instructions etc: go to <https://miele.co.uk/manuals> and enter the name of the product or the serial number

Frequency range of the WiFi module	2.4000–2.4835 GHz
------------------------------------	-------------------

Maximum transmission power of the WiFi module	< 100 mW
---	----------

UK Conformity declaration

Copyrights and licences

For the purpose of operating and controlling the communication module, Miele uses proprietary or third-party software that is not covered by open source licensing terms. This software/these software components are protected by copyright. The copyrights held by Miele and third parties must be respected.

Furthermore, the communication module integrated in the appliance contains software components which are distributed under open source licence conditions. The open source components contained in the appliance along with the corresponding copyright notices, copies of the licensing terms valid at the time and any further information can be accessed locally by IP via a web browser ([http\[s\]://<IP address>/Licenses](http[s]://<IP address>/Licenses)). The liability and warranty arrangements for the open source licences displayed in this location only apply in relation to the respective rights holders.

United Kingdom

Miele Co. Ltd., Fairacres, Marcham Road, Abingdon, Oxon, OX14 1TW
Tel: 0330 160 6600, Internet: www.miele.co.uk, E-mail: info@miele.co.uk

Australia

Miele Australia Pty. Ltd.
ACN 005 635 398
ABN 96 005 635 398
Level 4, 141 Camberwell Road
Hawthorn East, VIC 3123
Tel: 1300 464 353
E-mail: info@miele.com.au
Internet: www.miele.com.au

China Mainland

Miele Electrical Appliances Co. Ltd.
No. 82, Shimenyi Road, JingAn District
Shanghai, China, P.R.C
Post Code: 200040
Phone: +86 21 6157 3500
Fax: +86 21 6157 3511
E-mail: info@miele.cn
Internet: www.miele.cn

Hong Kong, China

Miele (Hong Kong) Ltd.
41/F - 4101, Manhattan Place
23 Wang Tai Road
Kowloon Bay, Hong Kong
Tel: (852) 2610 1025
Fax: (852) 3579 1404
E-mail:
customerservices@miele.com.hk
Website: www.miele.hk

India

Miele India Pvt. Ltd.
1st Floor, Copia Corporate Suites,
Commercial Plot 9, Mathura Road,
Jasola, New Delhi - 110025
E-mail: customercare@miele.in
Website: www.miele.in

Ireland

Miele Ireland Ltd.
2024 Bianconi Avenue
Citywest Business Campus
Dublin 24
Tel: (01) 461 07 10
Fax: (01) 461 07 97
E-mail: info@miele.ie
Internet: www.miele.ie

Malaysia

Miele Sdn Bhd
Suite 12-2, Level 12
Menara Sapura Kencana
Petroleum
Solaris Dutamas No. 1
Jalan Dutamas 1
50480 Kuala Lumpur, Malaysia
Phone: +603-6209-0288
Fax: +603-6205-3768

New Zealand

Miele New Zealand Limited
IRD 98 463 631
8 College Hill
Freemans Bay, Auckland 1011
Tel: 0800 464 353
E-mail: customercare@miele.co.nz
Internet: www.miele.co.nz

Singapore

Miele Pte. Ltd.
29 Media Circle
#11-04 ALICE@Mediapolis
Singapore 138565
Tel: +65 6735 1191
Fax: +65 6735 1161
E-mail: info@miele.com.sg
Internet: www.miele.sg

South Africa

Miele (Pty) Ltd.
63 Peter Place, Bryanston 2194
P.O. Box 69434, Bryanston 2021
Tel: (011) 875 9000
Fax: (011) 875 9035
E-mail: info@miele.co.za
Internet: www.miele.co.za

Thailand

Miele Appliances Ltd.
BHIRAJ TOWER at EmQuartier
43rd Floor Unit 4301-4303
689 Sukhumvit Road
North Klongton Sub-District
Vadhana District
Bangkok 10110, Thailand

United Arab Emirates

Miele Appliances Ltd.
Showroom 1, Eiffel 1 Building
Sheikh Zayed Road, Umm Al Sheif
P.O. Box 114782 - Dubai
Tel. +971 4 3044 999
Fax. +971 4 3418 852
800-MIELE (64353)
E-mail: info@miele.ae
Website: www.miele.ae

Manufacturer: Miele & Cie. KG, Carl-Miele-Straße 29, 33332 Gütersloh, Germany

KFN 7913 ..., KFN 7934 ...

en-GB

M.-Nr. 12 918 490 / 00 / 002