













Operating and installation instructions Freezer



It is **essential** to read the operating and installation instructions before setup, installation, and commissioning. This prevents both personal injury and damage to the appliance.

Contents

Warning and Safety instructions ..	4	Operation.....	38
Sustainability and environmental protection ..	13	The correct temperature	38
How to save energy	14	Temperature display.....	38
Installation.....	15	Setting the temperature	38
Installation site	15	Temperature and door alarm	38
Ventilation requirements	16	Using Super freeze.....	40
Installing several refrigeration appliances next to one another	16	Freezing and storing fresh food.....	40
Side-by-Side installation (depending on the model)	17	Cooling drinks quickly	41
Changing the door hinging	17	Making ice cubes.....	42
Ordering printed installation instructions	17	Selecting further settings	43
Installing the refrigeration appliance	17	Explanation of the different settings ..	43
Aligning the refrigeration appliance	18	Party mode 	43
Integrating the refrigeration appliance in a run of kitchen units	19	Switching on the lock function  / 	43
Appliance dimensions.....	21	Sabbath mode 	44
Electrical connection	30	Changing the time before the door alarm  is triggered	45
Guide to the appliance.....	31	Networking	45
Appliance overview	31	Adjusting the volume of alarms and buzzers  / 	47
Control panel with start display	33	Adjusting the display brightness 	47
Settings mode 	33	Switching off demo mode 	47
Adjusting the interior fittings	35	Resetting the settings to their default settings 	47
Tilting the top drawer	35	Information 	48
XXL box freezer drawer	35	Cleaning and care	49
Creating a flexible design for the freezer zone (VarioRoom)	35	Defrosting.....	49
Accessories supplied	35	Cleaning agents.....	49
Optional accessories	35	Preparing the refrigeration appliance for cleaning	49
Switching on and off.....	36	Cleaning the inside of the appliance ..	49
Before using for the first time.....	36	Cleaning accessories by hand or in the dishwasher	50
Connecting the refrigeration appliance	36	Removing and dismantling accessories for cleaning	50
Switching the refrigeration appliance on	36	Cleaning the front of the appliance and the side panels.....	50
Switching off the refrigeration appliance	36	Cleaning the door seal.....	51
To note when switching off for longer periods of time	36	Cleaning the ventilation openings ...	51
Requirements for networking	37	After cleaning.....	51
Setting up networking for the first time	37	Troubleshooting	52
Performing Scan & Connect.....	37	Noises.....	58

Service	60
Contact in the event of a fault	60
EPREL database	60
Warranty	60
Information	61
EU Conformity declaration.....	61
UK Conformity declaration	61
Copyrights and licences	62

Warning and Safety instructions

This refrigeration appliance complies with current safety requirements. Inappropriate use can, however, lead to personal injury and material damage.

Please read the operating and installation instructions carefully before using the refrigeration appliance for the first time. They contain important information on installation, safety, use and maintenance. This is to protect yourself from injury, and from damaging your refrigeration appliance.

In accordance with standard IEC 60335-1, Miele expressly and strongly advises that you read and follow all information provided on installing the refrigeration appliance, as well as the warning and safety notes.

Miele cannot be held liable for injury or damage caused by non-compliance with these instructions.

Keep these operating and installation instructions in a safe place and pass them on to any future owner.

Correct application

► This refrigeration appliance is intended for use in the home and in similar environments; for example:

- In shops, offices and similar work settings
- On agricultural estates
- By the guests in hotels, motels, bed and breakfasts, and other typical home settings.

This refrigeration appliance is not intended for outdoor use.

► It must only be used as a domestic appliance to store deep frozen food, freeze fresh food and to make ice.

Any other usage is not supported by the manufacturer and could be dangerous.

► This refrigeration appliance is not suitable for storing and keeping cool medicines, blood plasma, laboratory preparations or similar substances or products that are subject to the Medical Device Directive. Incorrect use of the refrigeration appliance for such purposes may cause deterioration of the items stored. The refrigeration appliance is also not suitable for use in areas where there is a risk of explosion. Miele cannot be held liable for damage caused by improper or incorrect use or operation of the appliance.

Warning and Safety instructions

▶ The appliance can only be used by people with reduced physical, sensory or mental capabilities, or lack of experience and knowledge, if they are supervised whilst using it, or have been shown how to use it in a safe way and recognise and understand the consequences of incorrect operation.

Safety with children

▶ Children under 8 years of age must be kept away from the refrigeration appliance unless they are constantly supervised.

▶ Children 8 years and older may only use the appliance unsupervised if they have been shown how to use it in a safe way and recognise and understand the consequences of incorrect operation.

▶ Children must not be allowed to clean or maintain the appliance unsupervised.

▶ Please supervise children in the vicinity of the appliance and do not let them play with it.

▶ Danger of suffocation. Whilst playing, children may become entangled in packaging material (such as plastic wrapping) or pull the packaging material over their head, presenting the risk of suffocation. Keep packaging material away from children.

Technical safety

▶ The coolant circuit has been checked for leaks. The refrigeration appliance complies with statutory safety requirements and the appropriate EU directives.



If the cooling circuit is damaged, refrigerant and oil can escape and ignite.

▶ **Warning: fire hazard/flammable materials.** This symbol is on the compressor and indicates flammable materials. Do not remove this sticker.

Warning and Safety instructions

The refrigerant inside the appliance (details on the data plate) is environmentally friendly but flammable.

The use of this refrigerant does, however, sometimes lead to a slight increase in the noise level of the appliance. In addition to the noise of the compressor, you might be able to hear the refrigerant flowing around the cooling circuit. Unfortunately, this cannot be avoided, but it does not affect the performance of the refrigeration appliance.

When transporting and installing the refrigeration appliance, ensure that no parts of the cooling circuit are damaged. Splashes of refrigerant can damage the eyes and leaking refrigerant can ignite.

In the event of damage:

- Avoid naked flames or anything which creates a spark.
- Disconnect the refrigeration appliance from the mains electricity supply.
- Ventilate the room where the refrigeration appliance is located for several minutes.
- Contact the Miele Customer Service Department.

▶ The more refrigerant there is in a refrigeration appliance, the larger the room it should be installed in. In the event of a leakage, if the appliance is in a small room, there is the danger of a combustible gas/air mixture building up. For every 8 g of refrigerant at least 1 m³ of room space is required. The amount of refrigerant in the refrigeration appliance is stated on the data plate inside the appliance.

▶ If the ventilation cross-sections are covered or blocked, a combustible gas/air mixture can form if the cooling circuit is damaged. It is essential to observe the required ventilation cross-sections. The ventilation cross-sections must not be covered or blocked in any way.

▶ To avoid the risk of damage to the appliance, make sure that the connection data (fuse rating, frequency and voltage) on the data plate corresponds to the household supply.

Check that this is the case before connecting the appliance. Consult a qualified electrician if in any doubt.

▶ The electrical safety of this appliance can only be guaranteed when correctly earthed. It is essential that this standard safety requirement is met. If in any doubt please have the electrical installation tested by a qualified electrician.

Warning and Safety instructions

▶ Temporary or permanent operation on an autonomous power supply system or a power supply system that is not synchronised with the mains power supply (e.g. island networks, back-up systems) is possible. A prerequisite for operation is that the power supply system complies with the specifications of EN 50160 or an equivalent standard.

The function and operation of the protective measures provided in the domestic electrical installation and in this Miele product must also be maintained in isolated operation or in operation that is not synchronised with the mains power supply, or these measures must be replaced by equivalent measures in the installation. As described, for example, in the current version of BS OHSAS 18001–2 ISO 45001.

▶ The socket must not be concealed behind the refrigeration appliance and must be easily accessible so that the appliance can be quickly disconnected from the electrical supply in case of an emergency.

▶ If the mains connection cable is damaged, disconnect the refrigeration appliance from the power supply immediately. Contact the Miele Customer Service Department.

▶ If the mains connection cable is damaged, it must only be replaced with a specific mains connection cable of the same type (available from the Miele online shop or Miele Customer Service). For safety reasons, such replacement may only be carried out by a qualified specialist or Miele Customer Service.

▶ Do not connect the appliance to the mains electrical supply by a multi-socket adapter or extension lead. These are a fire hazard and do not guarantee the required safety of the appliance.

▶ If moisture gets into electrical components or into the mains connection cable, it could cause a short circuit. Therefore, do not operate this refrigeration appliance in areas which are exposed to moisture (e.g. in a garage or utility room).

▶ This appliance must not be used in a non-stationary location (e.g. on a ship).

▶ Do not use a damaged appliance. It could be dangerous. Check the appliance for visible signs of damage.

▶ This refrigeration appliance is not intended for use as a built-in appliance.

Warning and Safety instructions

▶ The appliance must be isolated from the electricity supply during installation, maintenance and repair work. It is only completely isolated from the power supply when:

- the mains fuses are switched off, or
- the screw-out fuse is removed (where applicable), or
- the mains cable has been unplugged. Pull on the plug and not the cable when disconnecting it from the power supply.

▶ Unauthorised installation, maintenance or repairs could result in unforeseen dangers for the user, for which the manufacturer cannot accept liability.

Installation, maintenance or repairs must only be carried out by a qualified specialist or Miele Customer Service.

▶ The manufacturer's warranty will be invalidated if the refrigeration appliance is not repaired by a qualified specialist or Miele Customer Service.

▶ We recommend replacing defective components with original spare parts. If original Miele spare parts are installed correctly, Miele ensures full compliance with safety requirements and the warranty remains valid.

▶ This refrigeration appliance is fitted with a special lamp to cope with particular conditions (e.g. temperature, moisture, chemical resistance, abrasion resistance and vibration). This lamp must only be used for the purpose for which it is intended. The lamp is not suitable for room lighting. Replacement lamps may only be fitted by a qualified specialist or by Miele Customer Service. This refrigeration appliance contains several light sources with at least energy efficiency class G.

Proper installation

▶ When installing the refrigeration appliance, it is a mandatory requirement to follow the installation instructions supplied with it.

▶ Change the door hinging (if necessary) as described in the installation instructions.

▶ Refrigeration appliances with an "S" in the model identifier can be installed next to each other as a side-by-side combination:

- Carry out installation as described in the installation instructions.
- Do not change the door hinging as the arrangement of the refrigeration appliances is predefined.

Warning and Safety instructions

- ▶ Always wear protective gloves when transporting and setting up the refrigeration appliance and when changing the door hinging.
- ▶ The refrigeration appliance is heavy and can tip forwards when the appliance door(s) is/are open:
 - At least 2 people are required to transport or move the refrigeration appliance.
 - At least 2 people are required to change the door hinging of the refrigeration appliance.
 - At least 2 people are required to install the refrigeration appliance.
 - Never leave the refrigeration appliance unattended while it is being installed.

Correct use

- ▶ This refrigeration appliance is designed for use within specific ambient temperatures (climate range). Do not use in ambient temperatures for which it is not designed. The climate range is stated on the data plate in the interior cabinet of the refrigeration appliance. A lower ambient temperature will cause the compressor to switch off for longer periods, meaning that the refrigeration appliance is unable to maintain the required temperature.
- ▶ The ventilation cross-sections must not be covered or blocked in any way. This can impair the proper ventilation of the appliance, increase the energy consumption and cause damage to the components.
- ▶ Risk of damage due to greasy or oily foods. If the refrigeration appliance or the appliance door is used for storing food which contains fat or oil, make sure that it does not come into contact with plastic components. Any spillages of oil or fat could cause stress cracks to the plastic and cause it to break or split.
- ▶ Risk of fire and explosion due to flammable mixes of gases. Do not store explosive materials in the refrigeration appliance or any products containing propellants (e.g. spray cans). Electrical components can cause flammable mixes of gases to ignite. The spray cans in question can be identified by the contents printed on the can or by a flame symbol. Electrical components can cause escaping gases to ignite.
- ▶ Danger of explosion. Do not operate any electrical equipment (e.g. an electric ice-cream maker) inside the refrigeration appliance. This can cause sparking and explosion.

Warning and Safety instructions

- ▶ Danger of injury and damage to the appliance. Do not store cans or bottles containing carbonated drinks or liquids which could freeze in the freezer zone. Otherwise they could burst.
- ▶ Danger of injury and damage to the appliance. When cooling drinks quickly in the freezer zone, make sure bottles are not left in for more than one hour. Otherwise they could burst.
- ▶ Danger of injury. Never handle frozen food or the metal parts of the appliance with wet hands. Your hands may freeze to the frozen food or to the metal.
- ▶ Danger of injury. Do not take ice cubes out with your bare hands and never place ice cubes or ice lollies in your mouth straight from the freezer zone. The very low temperature of the frozen food can cause frost burn to the lips and tongue.
- ▶ Do not refreeze partially or fully defrosted food. Consume defrosted food as soon as possible, as it will lose its nutritional value and spoil if left for too long. Defrosted food may only be re-frozen after it has been cooked.
- ▶ Observe the manufacturer's "use-by" dates and storage instructions given on food to avoid the risk of food poisoning. Storage times will depend on several factors, including the freshness and quality of the food, as well as the temperature at which it is stored.
- ▶ To ensure that fresh food placed in the freezer freezes through to the core as quickly as possible, the maximum freezing capacity must not be exceeded. The maximum freezing capacity for freezing within a 24-hour period is given on the data plate: "Freezing capacity ... kg/24 hrs".

Accessories and spare parts

- ▶ We recommend using original Miele accessories. If other parts are used, warranty, performance and/or product liability claims will be invalidated.
- ▶ Miele original spare parts are kept in stock for at least 10 years and up to 15 years after discontinuation of your refrigeration appliance.

Cleaning and care

- ▶ Do not use any oils or grease on the door seals, as these will cause the seals to deteriorate and become porous with time.

Warning and Safety instructions

▶ Do not use a steam cleaning appliance to clean or defrost this appliance.

Steam could reach electrical components and cause a short circuit.

▶ **Warning.** Do not use any mechanical tools or other types of aid which are not recommended by the manufacturer to accelerate the defrosting process.

▶ Sharp edged or pointed objects will damage the evaporator, causing irreversible damage to the appliance. Do not use sharp edged or pointed objects to

- remove frost and ice,
- separate frozen food or remove ice trays.

▶ Do not place electric heaters or candles in the appliance to defrost it. These can damage the plastic parts.

▶ Do not use defrosting sprays or de-icers. Defrosting sprays and de-icers can contain substances which could damage the plastic parts or which might cause a build-up of explosive gases and pose a danger to health.

Transport

▶ To avoid damage to the refrigeration appliance, always transport it upright and in its packaging.

▶ Danger of injury and damage to the appliance. The refrigeration appliance is very heavy and must be transported by two people.

Disposal of your old appliance

▶ Children playing could become trapped in the refrigeration appliance and could suffocate.

- Remove the appliance door(s).
- Remove the drawers.
- Leave the shelves in the refrigeration appliance so that children cannot climb inside.
- If your old refrigeration appliance has a door lock, destroy it. This will prevent the risk of children playing accidentally locking themselves in the appliance and endangering their lives.

▶ Risk of electric shock!

- Cut the plug off the mains connection cable.
- Cut the mains connection cable off the old appliance.

Warning and Safety instructions

Dispose of the plug and mains connection cable separately from the old appliance.

▶ During and after disposal, make sure that the refrigeration appliance is not placed near petrol or other flammable gases and liquids.

▶ Risk of fire due to escaping oil or refrigerant.

The refrigerant and oil inside the appliance are flammable. In high enough concentrations, escaping refrigerant or oil can ignite if they come into contact with an external heat source.

During disposal, make sure that the cooling circuit is not damaged. This prevents refrigerant and oil escaping in an uncontrolled manner (see the data plate for details of the refrigerant).

▶ Splashes of coolant can damage the eyes. Be careful not to damage any part of the pipework whilst awaiting disposal, e.g. by

- puncturing the coolant channels in the condenser,
- bending any pipework, or
- scratching the surface coating.

Symbol on the compressor (depending on model)

This information is only relevant for recycling. There is no risk during normal operation.



▶ The oil in the compressor can be fatal if swallowed or if it penetrates the airways.

Disposing of the packaging material

The packaging material is used for handling and protects the appliance from transport damage. The packaging material used is selected from materials which are environmentally friendly for disposal and can generally be recycled.

Recycling the packaging material reduces the use of raw materials. Use material-specific collection points for valuable materials and take advantage of return options. Your Miele dealer will take the packaging material away.

Disposing of your old appliance

Electrical and electronic appliances contain many valuable materials. They also contain certain materials, compounds and components which were essential for their correct functioning and safety. These could be hazardous to human health and to the environment if disposed of with household waste or if handled incorrectly. Please do not, therefore, dispose of your old appliance with household waste.



Take care not to damage your refrigeration appliance before or during disposal in an authorised, environmentally friendly manner.

This is to ensure that refrigerant in the cooling circuit and oil in the compressor is contained, and will not leak into the environment.

Instead, please make use of officially designated collection and disposal points to dispose of and recycle electrical and electronic appliances in your local community, with your dealer or

with Miele, free of charge. By law, you are solely responsible for deleting any personal data from the old appliance prior to disposal. You are legally obliged to remove any old batteries which are not securely enclosed by the appliance and to remove any lamps without destroying them, where this is possible. These must be taken to a suitable collection point where they can be handed in free of charge. Please ensure that your old appliance poses no risk to children while being stored for disposal.

Sustainability and environmental protection

How to save energy ...

- Installation site** The refrigeration appliance has to cool more often at higher ambient temperatures and consumes more energy in the process. Therefore:
- Install the refrigeration appliance in a well-ventilated room.
 - Do not install the refrigeration appliance near to a heat source (heater element, cooker).
 - Protect the refrigeration appliance from direct sunlight.
 - Ensure an ideal ambient temperature of 20 °C.
 - Clean the ventilation openings on a regular basis to remove any dust.
- Temperature setting** The colder the temperature, the higher the energy consumption. The following settings are recommended:
- -18 °C in the freezer zone
- Use** Energy consumption is increased by heat input and impeded air circulation. Therefore:
- Only open the appliance door/appliance doors when necessary and for as short a time as possible. Arrange the food in such a way that makes it easy to find in the appliance.
 - Always close the appliance door/appliance doors properly after opening.
 - Allow hot food and drinks to cool down before placing them in the refrigeration appliance.
 - Store food well packaged or covered.
 - Do not overfill the compartments to allow air to circulate.
 - Keep drawers and shelves arranged as they were when the appliance was delivered.
 - When placing food in the appliance, make sure that the ventilation slots are not blocked.
 - Maintain a distance of 25 mm between the back of the appliance and the wall.

Installation site

 Risk of fire and damage from appliances which give off heat.

Appliances which give off heat can catch fire and set fire to the refrigeration appliance.

The mains connection cable must not come into contact with heat sources.

Do not place appliances which give off heat, such as mini-ovens, double burner hobs or toasters on the refrigeration appliance.

 Fire risk and danger of damage from open flames.

Open flames can set fire to the refrigeration appliance.

Keep open flames (e.g. a candle) away from the refrigeration appliance.

 Risk of fire and damage due to improper installation.

If the mains plug and mains connection cables touch the back of the refrigeration appliance, they may be damaged by vibrations and cause a short circuit.

Mains plugs or mains connection cables must not touch the refrigeration appliance.

Mains connection cables must not be trapped or damaged.

Do not connect any other appliances to sockets located directly behind this refrigeration appliance.

Do not place or operate multi-socket adapters, distributor strips or other electronic devices (such as halogen transformers) behind the appliance.

This appliance should be installed in a dry, well-ventilated room.

The floor at the installation site must be horizontal and level and must be as high as the surrounding floor.

 Risk of damage due to high humidity.

In environments with high humidity, condensation can build up on external refrigeration appliance panels.

This condensation can cause corrosion on external appliance panels.

Install the refrigeration appliance in a dry and/or air-conditioned room with sufficient ventilation.

After installation, please make sure that the appliance door/appliance doors closes/close properly and the refrigeration appliance is installed in accordance with these installation instructions. It is essential to comply with the specified ventilation cross-sections.

When deciding on the installation site, please bear in mind that your refrigeration appliance will consume more energy if installed near to a heater, a cooker or another appliance that gives off heat. Avoid direct sunlight. Higher ambient temperatures increase energy consumption as the compressor runs for longer.

Climate range

This refrigeration appliance is designed for use within specific ambient temperatures (climate range). Do not use it in ambient temperatures for which it is not designed.

A lower room temperature leads to the compressor switching off for longer periods. This can cause the internal temperature in the refrigeration appliance to rise with the risk of food deteriorating and going off.

Installation

The climate range is stated on the data plate in the interior cabinet of the refrigeration appliance.

Climate range	Ambient temperature
SN	10 to 32 °C
N	16 to 32 °C
ST	16 to 38 °C
T	16 to 43 °C
SN-ST	10 to 38 °C
SN-T	10 to 43 °C

A freezer from the SN climate range can operate without any difficulties in rooms with a cooler ambient temperature (down to -15 °C).

Ventilation requirements

 Fire risk and risk of damage due to inadequate ventilation.

If the refrigeration appliance is not ventilated sufficiently, the compressor will run more frequently and for longer periods. This causes increased energy consumption and an increased compressor operating temperature, which can result in damage to the refrigeration appliance.

Please ensure that there is adequate ventilation around the refrigeration appliance:

It is essential to observe the required ventilation cross-sections.

The ventilation cross-sections must not be covered or blocked in any way. Clean the ventilation areas regularly to remove dust and dirt.

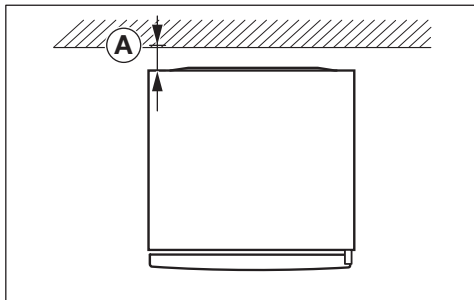

The energy consumption was calculated with a distance \textcircled{A} = 25 mm between the back of the appliance and the wall. If the distance to the wall is less than 25 mm, the functionality of the refrigeration appliance is maintained, but energy consumption increases slightly. Condensation can also form at high ambient temperatures.

Air at the back of the refrigeration appliance gets warm. Sufficient space for proper ventilation must therefore be ensured (see “Appliance dimensions”).

Installing several refrigeration appliances next to one another

 Risk of damage due to condensation on external appliance panels.

In environments with high humidity, condensation can build up between the external refrigeration appliance panels, which can cause corrosion.

Do **not** place different refrigeration appliances **directly** next to one another.

A distance of at least 70 mm must be maintained between the refrigeration appliances.

Side-by-Side installation (depending on the model)

Your freezer can be installed to the left of another refrigerator as it is equipped with an integrated heater in the right-hand side panel (see “Appliance dimensions”).

The refrigerator must also be equipped with an integrated heater in the left-hand side panel.

Tip: Please contact your dealer for specific information about which combinations will work with your refrigeration appliance.

Depending on the model, a Side-by-Side installation kit is included with the freezer. The installation instructions describe how to install the refrigeration appliances next to each other.

 Carry out the Side-by-Side installation in accordance with the installation instructions (see QR code).



M.-Nr. 12196150

Changing the door hinging

 Danger of injury and damage to the appliance due to heavy door.

There is an increased risk of injury and damage if the door hinging is installed by a single person.

Always change the door hinging with the help of a second person.

 Risk of damaging the electrical components.

There are live components on the door hinge (depending on the model). Switch off the appliance at the wall socket and withdraw the mains plug before changing the hinging.

 Change the door hinge in accordance with the installation instructions (see QR code).



M.-Nr. 12083770

Ordering printed installation instructions

You can order printed installation instructions free of charge from Miele.

All the contact information you need for Miele can be found at the end of this document. Quote the model identifier and the serial number from the data plate when placing your order.

Installing the refrigeration appliance

 Risk of injury and damage due to the refrigeration appliance tipping over.

There is an increased risk of injury and damage if the refrigeration appliance is installed by a single person.

Two people are required for installing the refrigeration appliance.

Installation

⚠ Risk of damage to the appliance door caused by impact.

The appliance door could hit the wall of the room resulting in damage to the door.

Protect the appliance door by fitting a felt stopper, for example, to the wall of the room.

⚠ Risk of damaging the floor.

Moving the refrigeration appliance can cause damage to the floor.

Move the refrigeration appliance carefully on floors that are sensitive to scratching.

For easier installation, there are transport handles on the back at the top and transport wheels underneath the refrigeration appliance (depending on the model).

The refrigeration appliance must be empty when it is installed.

- Connect the refrigeration appliance to the mains power supply as described in “Electrical connection”.
- Move the refrigeration appliance carefully to its intended installation site.
- Position the refrigeration appliance with its back facing the wall, taking the necessary distance into account.

Aligning the refrigeration appliance

⚠ Risk of damage and injury caused by the appliance door falling out or the refrigeration appliance tipping over.

If the additional adjustable foot on the hinge plate at the bottom is not resting firmly on the floor, the appliance door can fall out or the refrigeration appliance can tip over.

Use the open spanner supplied with the appliance to unscrew the adjustable foot until it is resting on the floor.

Then unscrew the adjustable foot by a further quarter turn.

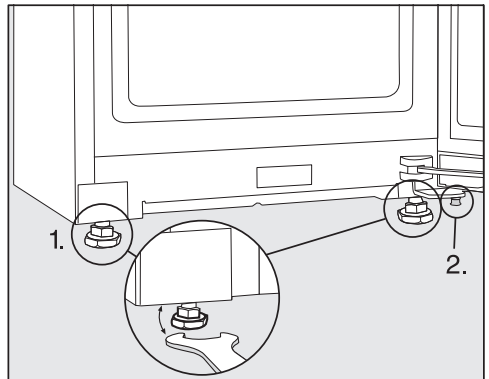

- Use the spirit level and the open spanner supplied to align the refrigeration appliance and support the appliance door.
 1. Adjust the front adjustable feet.
 2. Unscrew the additional adjustable foot out until it is touching the floor. Then unscrew the adjustable foot by a further quarter turn.

Integrating the refrigeration appliance in a run of kitchen units

The refrigeration appliance can be surrounded by kitchen units.

The energy consumption was calculated with a distance of 25 mm between the back of the appliance and the wall. If the distance to the wall is less than 25 mm, the functionality of the refrigeration appliance is maintained, but energy consumption increases slightly. Condensation can also form at high ambient temperatures.

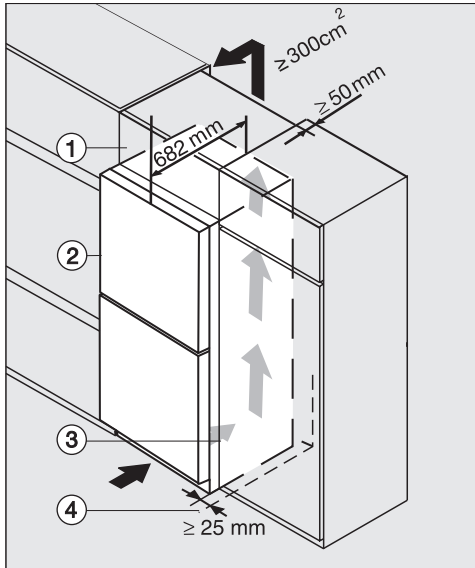

Refrigeration appliance with glass front
K(S)/FN(S)/KFN 4xxx X **obs**w/matt, **bb**,
brws, **bs**, **grgr**

- ① Top box
- ② Refrigeration appliance, door depth = 82 mm
- ③ Kitchen unit
- ④ Wall



K(S)/FN(S)/KFN 4xxx X **edst**/cs, **ws**, **bst**, **el**

- ① Top box
 - ② Refrigeration appliance, door depth = 75 mm
 - ③ Kitchen unit
 - ④ Wall
- A** = 25 mm (with recessed grip)/60 mm (with handle)

Installation

 Fire risk and risk of damage due to inadequate ventilation.

If the refrigeration appliance is not ventilated sufficiently, the compressor will run more frequently and for longer periods. This causes increased energy consumption and an increased compressor operating temperature, which can result in damage to the refrigeration appliance.

Please ensure that there is adequate ventilation around the refrigeration appliance:

It is essential to observe the required ventilation cross-sections.

The ventilation cross-sections must not be covered or blocked in any way.

Clean the ventilation areas regularly to remove dust and dirt.

The larger the ventilation cross-sections, the less energy the compressor will use.

- Install the refrigeration appliance next to the kitchen unit.

- The appliance front must protrude in front of the kitchen unit front by at least the door depth. This enables the appliance door to be opened and shut without being obstructed.
- When installed next to a wall ④, a distance (A) must be maintained on the hinge side between the wall ④ and the refrigeration appliance ②.
- To match the height of the rest of the kitchen units, the refrigeration appliance can be fitted with a suitable top box ①.

An air outlet of 50 mm depth must be provided across the whole width of the top box.

The ventilation cross-section under the ceiling must be at least 300 cm² to ensure that warm air can escape without obstruction.

Appliance dimensions

Installation dimensions/View from above

FNS 4382 ... ws, FNS 4382 ... el

All dimensions are given in mm.

The refrigeration appliance will function correctly if the specified ventilation cross-sections are kept clear.

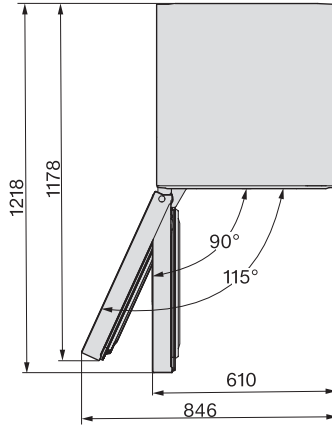
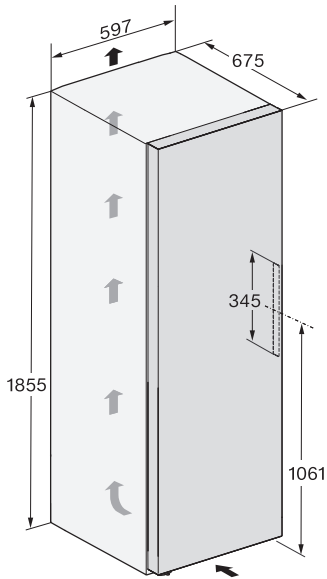

Installation

Connections

FNS 4382 ... ws, FNS 4382 ... el

All dimensions are given in mm.

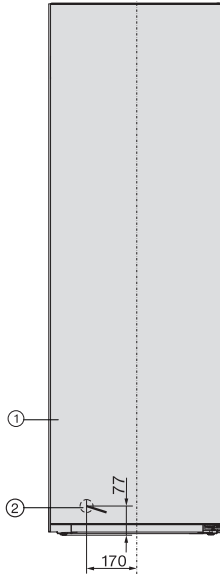

- ① Front view
- ② Mains connection cable, length = 2100 mm
A longer mains connection cable is available to order from the Miele Customer Service Department.

Installation dimensions/View from above

FNS 4382 ... ws + KS 4383 ... ws, FNS 4382 ... el + KS 4383 ... el

For more information, see the section “Installation – Side-by-side installation” and the installation instructions supplied with the side-by-side installation kit.

All dimensions are given in mm.

The refrigeration appliances will function correctly if the specified ventilation cross-sections are kept clear.

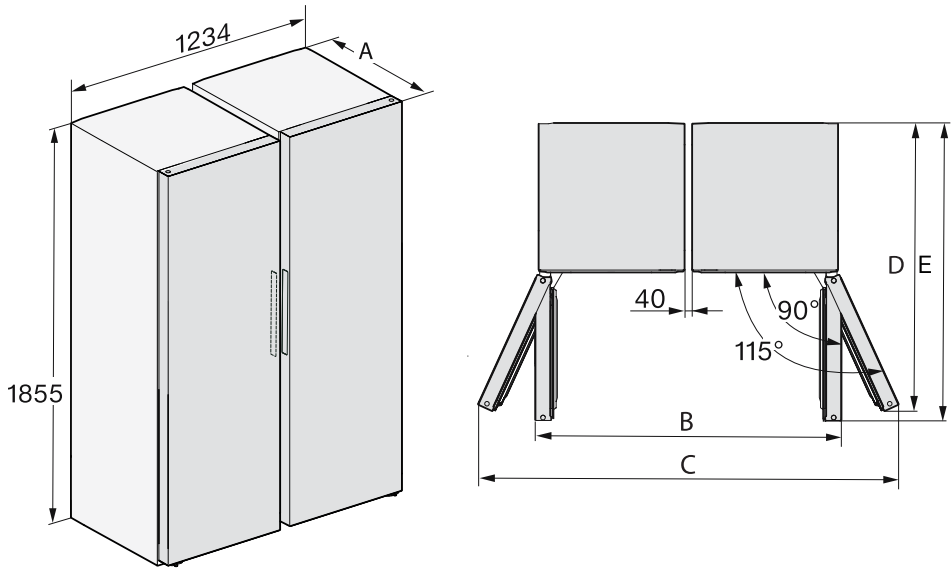

	A	B	C	D	E
FNS 4382 ... edt/cs + KS 4383 ... edt/cs	675	1260	1732	1178	1218

Installation

Installation dimensions/View from above

FNS 4382 ... ws N, FNS 4382 ... el N

All dimensions are given in mm.

The refrigeration appliance will function correctly if the specified ventilation cross-sections are kept clear.

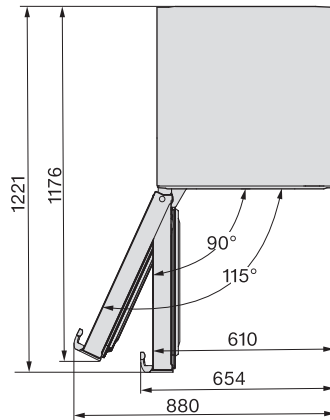
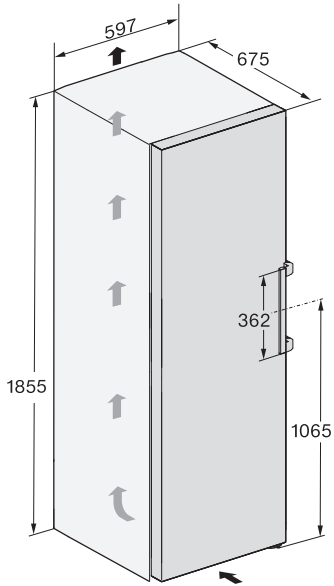

Connections

FNS 4382 ... ws N, FNS 4382 ... el N

All dimensions are given in mm.

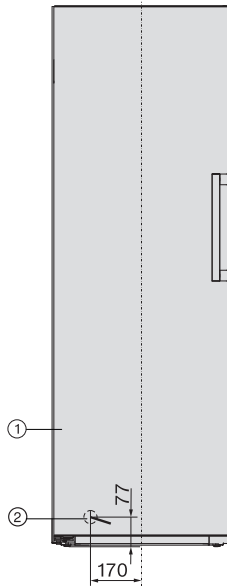

- ① Front view
- ② Mains connection cable, length = 2100 mm
A longer mains connection cable is available to order from the Miele Customer Service Department.

Installation

Installation dimensions/View from above

FNS 4382 ... ws N + KS 4383 ... ws N, FNS 4382 ... el N + KS 4383 ... el N

For more information, see the section “Installation – Side-by-side installation”.

All dimensions are given in mm.

The refrigeration appliances will function correctly if the specified ventilation cross-sections are kept clear.

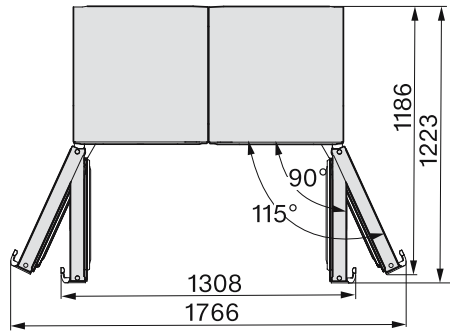
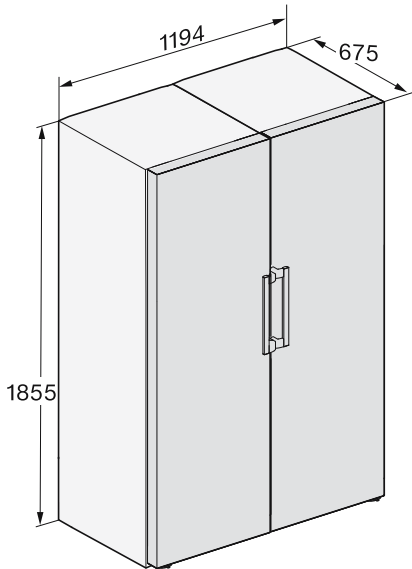

Installation dimensions/View from above

FNS 4383 ... ws N, FNS 4383 ... el N

All dimensions are given in mm.

The refrigeration appliance will function correctly if the specified ventilation cross-sections are kept clear.

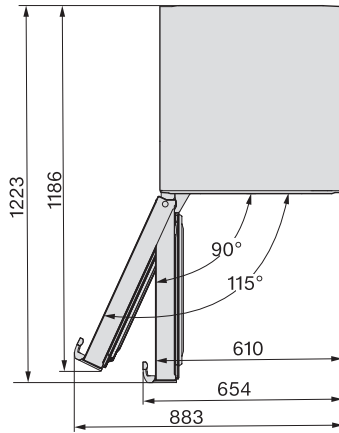
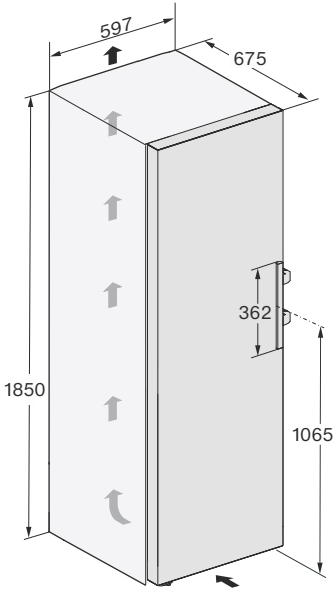

Installation

Connections

FNS 4382 ... ws N, FNS 4382 ... el N

All dimensions are given in mm.

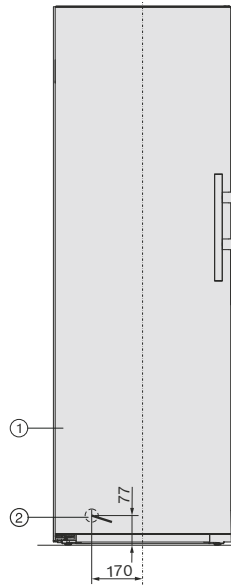

① Front view

② Mains connection cable, length = 2100 mm

A longer mains connection cable is available to order from the Miele Customer Service Department.

Installation dimensions/View from above

FNS 4383 ... ws N + KS 4384 ... ws N, FNS 4383 ... el N + KS 4384 ... el N

For more information, see the section “Installation – Side-by-side installation”.

All dimensions are given in mm.

The refrigeration appliances will function correctly if the specified ventilation cross-sections are kept clear.

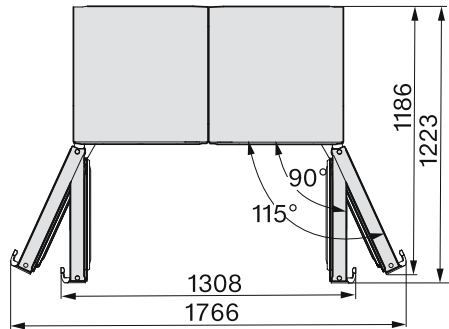
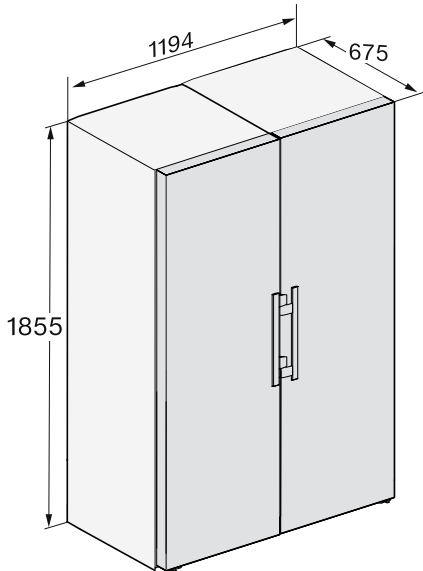

Installation

Electrical connection

The refrigeration appliance must only be connected to an earthed socket using the mains connection cable supplied.

The socket must be easily accessible after the refrigeration appliance has been installed. If the socket is not easily accessible, ensure that a suitable means of disconnection is provided on the installation side for each pole.

⚠ Risk of fire from overheating.

Connecting the refrigeration appliance to a multi-socket plug adapter or to an extension lead can overload the cable.

For safety reasons, do not use an extension lead or multi-socket adapter.

The electrical installation must comply with VDE 0100 requirements.

For safety reasons, we recommend using a type  residual current device (RCD) in the assigned electrical installation for connecting the refrigeration appliance.

If the mains connection cable is damaged, it must only be replaced with a specific mains connection cable of the same type (available from the Miele Customer Service Department). For safety reasons, such replacement may only be carried out by a qualified specialist or the Miele Customer Service Department.

These operating instructions and the data plate indicate the nominal power consumption and the appropriate fuse rating. Compare this information with the data of the on-site electrical connection. If in any doubt, consult a qualified electrician.

Temporary or permanent operation on an autonomous power supply system or a power supply system that is not synchronised with the mains power supply (e.g. island networks, back-up systems) is possible. A prerequisite for operation is that the power supply system complies with the specifications of EN 50160 or an equivalent standard. The function and operation of the protective measures provided in the domestic electrical installation and in this Miele product must also be maintained in isolated operation or in operation that is not synchronised with the mains power supply, or these measures must be replaced by equivalent measures in the installation. As described, for example, in the current version of VDE-AR-E 2510-2.

Connecting the refrigeration appliance

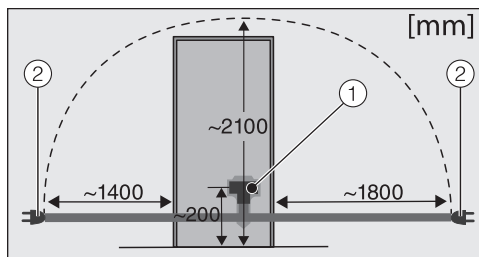

Back of the refrigeration appliance

① Appliance plug connector

② Mains plug

■ Plug the plug connector into the socket.

Make sure that the plug connector has clicked into position correctly.

■ Insert the plug of the refrigeration appliance into the socket.

The refrigeration appliance is now connected to the electricity supply.

Appliance overview

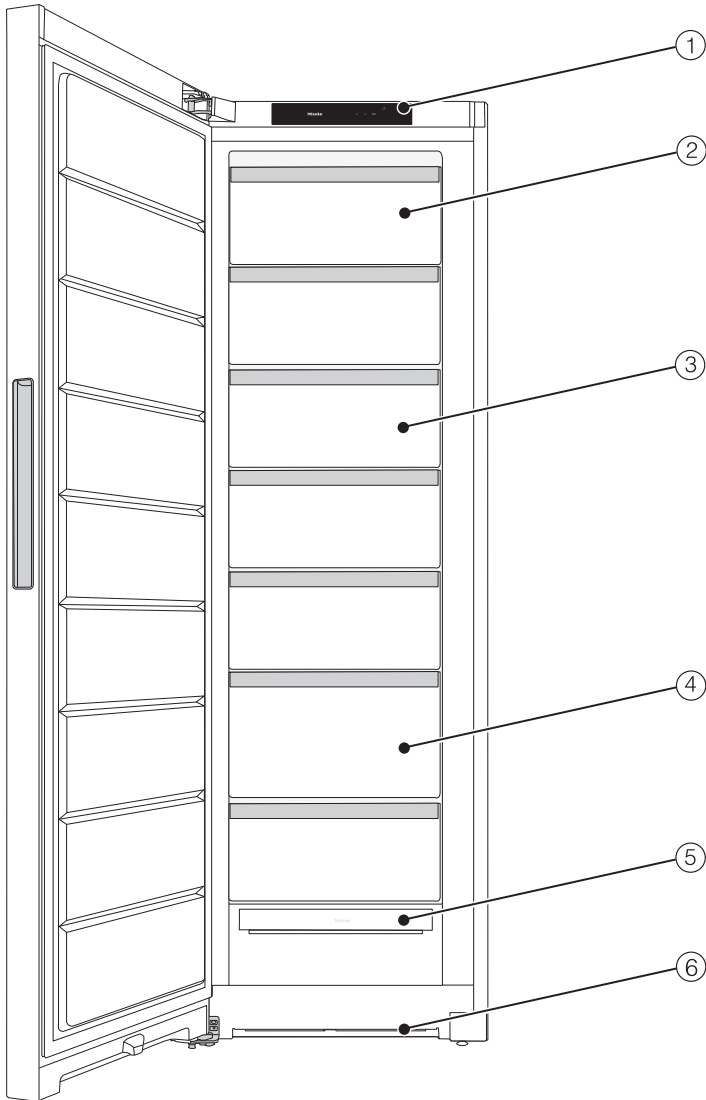

This drawing is for illustration purposes only.

Guide to the appliance

- ① Display
- ② Tiltable freezer drawer
- ③ Freezer drawer
- ④ Freezer drawer XXLBox
- ⑤ NoFrost module
- ⑥ Ventilation gap

Control panel with start display

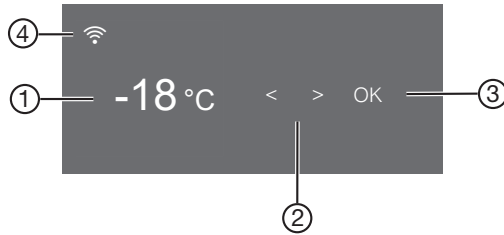









- ① Temperature display for freezer section
- ② Sensor controls for selecting a setting
- ③ *OK* sensor control for confirming a selection and entering Settings mode ⚙️
- ④ Display for connection status
(only visible if the network has been set up)

Settings mode ⚙️

In Settings mode, you can select the following appliance functions and alter their settings to some extent:

Symbol	Function	Factory default
	Switch the Party mode function on or off (see “Selecting further settings”)	Off
	Switching the lock function on or off (see “Selecting further settings”)	(off)
	Switch the Sabbath mode function on or off (see “Selecting further settings”)	Off
	Call up the Sabbath mode version	—
	Change the time before the door alarm is triggered (see “Selecting further settings”)	1:00

Guide to the appliance

	Set up the Miele@home function for the first time, activate and deactivate WiFi or reset the network configuration (see “Selecting further settings”)	App
	Switch the keypad tone on or off	On
	Change the volume of the alarms and buzzers or switch them off entirely (see “Selecting further settings”)	On /level 5
	Change the display brightness (see “Selecting further settings”)	Level 4
	Change the temperature unit (°Celsius or °Fahrenheit)	°C
	Switch the Demo mode function off (only visible when switched on) (see “Selecting further settings”)	Off
	Reset to default settings (see “Selecting further settings”)	—
	Call up information (model identifier and serial number) about your refrigeration appliance (see “Selecting further settings”)	—

Adjusting the interior fittings

Tilting the top drawer

The drawer can be tilted to make it easier to remove frozen food.

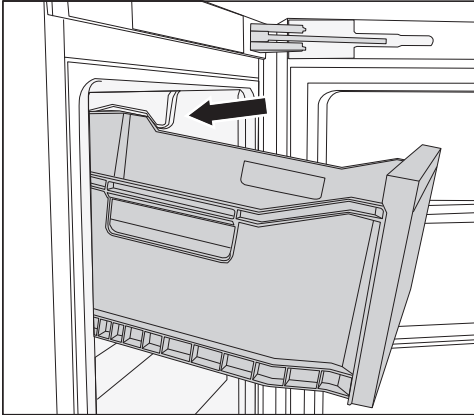

- Pull the drawer out.

The drawer is secured with pull-out stops and cannot fall out.

XXL box freezer drawer

The extra high freezer drawer offers more volume and space for storing bulky and tall items of frozen food.

Creating a flexible design for the freezer zone (VarioRoom)

If you wish to freeze large items such as a turkey or game, you can remove the upper freezer drawers and the glass plates between the freezer drawers. This creates more volume and space for storing bulky and tall items of frozen food.

Accessories supplied

Ice cube tray

Side-by-Side installation kit

depending on model

For installing two refrigeration appliances next to each other.

Optional accessories

A range of useful Miele accessories and care products are available for your appliance.

Products specially tailored to your refrigeration appliance – such as appliance care products and accessories – are available from the Miele online shop, from Miele Customer Service or from your Miele specialist dealer.

You can access the Miele online shop via the following QR code:



Switching on and off

Before using for the first time

- Remove all packaging material and protective foil.
- Clean the inside of the appliance and the accessories.

Connecting the refrigeration appliance



- Connect the refrigeration appliance to the electricity supply as described in “Electrical connection”.

Miele will then appear on the appliance display, followed by .

Switching the refrigeration appliance on

- Open the appliance door.
- Touch the *OK* sensor control on the control panel.

The refrigeration appliance will start cooling.

When the set freezer temperature is reached, the   symbol disappears, the temperature display of the freezer zone lights up constantly and the alarm tone stops.

- If the alarm annoys you, tap *OK*.

The alarm will stop.



The refrigeration appliance will gradually reach the pre-set temperatures.

Do not place food in the freezer zone until it has reached the preset temperature (min. -18 °C).

Switching off the refrigeration appliance

- Touch the *OK* sensor control on the control panel.

 will appear in the display.

- Touch *OK*.
- Use the  sensor control to scroll to the .

- Touch *OK*.

 will appear in the display.

The cooling system will be switched off.

Please note: The refrigeration appliance is not disconnected from the mains power supply when it is switched off.

To note when switching off for longer periods of time

If, during a long absence, the refrigeration appliance is switched off but not cleaned and the door is left shut, there is a danger of mould building up inside the appliance.

It is essential to clean the refrigeration appliance before a long period of absence.

If the refrigeration appliance is not going to be used for a longer period of time, observe the following:

- Switch the refrigeration appliance off.
- Switch off at the wall and disconnect the plug from the socket, or disconnect the fuse.
- Clean the refrigeration appliance and leave the door ajar to air the appliance and avoid odours building up inside.

Requirements for networking

Note the following requirements for networking:

1. A home network is available at the installation site.
Have the WiFi password ready.
2. The Miele app is available on a mobile device.
3. You have a user account in the Miele app.

Miele App

The Miele App is available to download free of charge from the Apple App Store® or from the Google Play Store™.



Setting up networking for the first time

- Tap *OK*.
- 📶 will appear in the display.
- Use the < or > sensor control to scroll to the ⚙️ symbol.
- Tap *OK*.
- Use the < or > sensor control to scroll to the @ symbol.
- Tap *OK*.
- Use the < and > sensor controls to select the connection method you wish to use (app or WPS).
- Tap *OK*.
- **To leave Settings mode** ⚙️, use the < or > sensor control to scroll to the ↩️ symbol.

- Tap *OK*.
- Use the < or > sensor control to scroll to the ↩️ symbol and tap *OK*.

After you have successfully logged in, 📶 will appear in the display.

If a connection could not be created, (⊗) will appear.

Start the process again.

Performing Scan & Connect

- Scan the QR code.
- If you have installed the Miele app and have a user account, you will be taken directly to the networking steps.
- If you have not yet installed the Miele app, you will be taken to the Apple App Store® or the Google Play Store™.
- Install the Miele app and set up a user account.
 - Scan the QR code again.

The Miele app will guide you through the setup process.

(depending on the model)



Operation

The correct temperature

It is very important to set the correct temperature to ensure the shelf life of food. Reducing the temperature reduces the growth rate of microorganisms. Food does not spoil as quickly.

To freeze fresh food, a temperature of **-18 °C** is required. This will prolong the shelf life of your food and retain its quality.

As soon as the temperature rises above **-10 °C**, the bacteria become active in the food again so it cannot be kept as long. For this reason, partially defrosted or defrosted food must not be re-frozen. Food may be re-frozen once it has been cooked, as the high temperatures achieved when cooking destroy most bacteria.

The temperature in the refrigeration appliance will rise:

- The more often the appliance door is opened and the longer it is kept open
- The more food is stored in it
- The warmer the food is which is being put into it
- The higher the ambient temperature surrounding the refrigeration appliance. This refrigeration appliance is designed for use within specific ambient temperatures (climate range). Do not use in ambient temperatures for which it is not designed.

By keeping the freezer zone at a constant temperature of **-18 °C** and taking appropriate hygiene measures you can maximise the storage life of your food and avoid food waste.

Temperature display

In normal operation, the temperature display shows the current **maximum freezer section temperature** in the refrigeration appliance.

Depending on the ambient temperature and the temperature setting, it can take the appliance a few hours to reach the temperature required and for this temperature to then be shown as a constant temperature in the display.

Setting the temperature

- Touch the *OK* sensor control on the control panel.
- 📺 will appear in the display.
- Touch *OK*.
- Use the **<** and **>** sensor controls to change the temperature.
- Touch *OK*.

The temperature display changes back to the actual temperature that is currently in the refrigeration appliance.

Possible temperature settings

- Freezer section: **-15 to -28 °C**

Temperature and door alarm

⚠ Health risk caused by decomposing food.

If the temperature in the freezer remains above **-18 °C** for a long time, the frozen food can start to defrost. This will reduce the storage life of the food.

Check whether the frozen food has started to defrost. If it has, check that the food is safe to use and if it is, then use it as soon as possible or cook it before freezing it again.

Temperature alarm

The refrigeration appliance has been fitted with a temperature alarm so that the temperature in the freezer zone cannot rise unnoticed.

If the temperature in the freezer section becomes too warm,  will light up red in the temperature display.

An alarm will also sound until the cause of the alarm is rectified or the alarm is switched off.

The temperature the refrigeration appliance is set at determines the temperature the appliance recognises as being too warm.

A temperature alarm is displayed before an existing door alarm.

The audible and visual signals may be activated in the following situations:

- You switch on the refrigeration appliance and the temperature in a temperature zone differs greatly from the set temperature.
- Too much warm ambient air enters the freezer when you are rearranging or taking out frozen food.
- You are freezing large amounts of food at once.
- You are freezing warm food.
- There was a power cut.
- The refrigeration appliance has a fault.

Before you switch the temperature alarm off, you must determine the cause and rectify it.

If the alarm annoys you, it can be turned off early.

- Touch *OK*.

The alarm message is confirmed:  goes out and the alarm stops.

The start screen appears in the display: the warmest temperature recorded in the refrigeration appliance will flash for about 1 minute in the display. Then the temperature display will change to the current temperature.

The alarm will stop. The  symbol will go out when the temperature reaches the correct level again.

Door alarm

The refrigeration appliance is fitted with a door alarm to avoid increased energy consumption and refrigerated items becoming warm if the door is left open.

If the appliance door is left open for a longer period of time,  will appear in the temperature display. An alarm will also sound.

The time before the door alarm is triggered can be changed. However, the door alarm can also be turned off (see "Selecting further settings").

The alarm will stop and  will go out on the display as soon as the appliance door is closed.

Switching the door alarm off early

If the alarm disturbs you, it can be turned off early.

- Touch *OK*.

The alarm will stop and the  symbol will go out.

If the appliance door is not closed, the alarm repeats after 3 minutes.

Operation

Using Super freeze

SuperFreeze ❄️

When switched on, the SuperFreeze function ❄️ can be used to rapidly reduce the temperature in the **freezer section** to its lowest setting (depending on the ambient temperature). The refrigeration appliance will work at full power and lower the temperature. Select this function before freezing fresh food. This helps food to freeze quickly and retain its nutrients, vitamins, flavours and appearance.

When the SuperFreeze function ❄️ is switched on, the appliance may make more noise than usual.

SuperFreeze should be switched on approx. **6 hours before** placing food in the freezer section.

When freezing the **maximum amount of food**, the SuperFreeze function ❄️ should be switched on **24 hours beforehand**.

The SuperFreeze function ❄️ will switch itself off automatically after a maximum of 72 hours. The refrigeration appliance will then run at normal power again. The quantity of fresh food placed in the freezer will determine the duration before it switches off.

Tip: To save energy, you can switch the SuperFreeze function off yourself once food and drinks are sufficiently chilled.

You do not need to switch on the SuperFreeze function:

- If you are placing food that is already frozen in the freezer
- If you only freeze up to 2 kg of fresh food daily

Switching SuperFreeze ❄️ on and off

- Touch the *OK* sensor control on the control panel.

❄️ will appear in the display.

- Touch *OK*.
- Use the < sensor control to scroll to the ❄️ symbol.
- Touch *OK*.

When the SuperFreeze function ❄️ is **switched on**, a dot appears in the upper corner of the display •.

- Use the > sensor control to scroll to the temperature you want and touch *OK*.

Freezing and storing fresh food

Before placing food in the freezer

- When freezing more than 2 kg of fresh food, switch on the SuperFreeze function ❄️ for 6 hours before placing the food in the freezer.
- When freezing even larger amounts of food, switch on the SuperFreeze function ❄️ for 24 hours before placing the food in the freezer.

This helps the frozen food which is already stored in the freezer to stay frozen.

- Only freeze fresh food which is in a good condition.

Please note that some food is not suitable for freezing. These include, for example, vegetables that are usually eaten raw, such as lettuce or radishes.

Tip: To retain colour, taste, aroma and vitamin C, vegetables should be blanched before they are frozen. To do so, place vegetables portion by portion into boiling water for 2–3 minutes. Then remove and plunge the vegetables into ice-cold water to cool quickly. Leave the vegetables to drain.

Packaging food for freezing

- Freeze food in portions.

Tip: Use suitable packaging to avoid freezer burn (such as freezer containers).

- Expel as much air as possible from the packaging and close it tightly.
- Make a note of the contents and the date of freezing on the packaging.

Placing food in the freezer

 Risk of damage caused by loading too much food.

Loading food which is too heavy can cause damage to the freezer drawers. Do not exceed the relevant maximum load size:

Bottom freezer drawer = 11 kg
All other freezer drawers = 19 kg

Unfrozen food should not touch frozen food as this will cause the frozen food to begin to thaw.

- To prevent food sticking together when frozen, make sure that the packaging and containers are dry.

To ensure that food freezes through to the core quickly, do not exceed the following packaging and container sizes:

- Fruit and vegetables: max. 1 kg
- Meat: max. 2.5 kg

– Freezing small amounts of food

Freeze food in the top freezer drawer.

- Place the food so that it is touching the back of the drawer to help it freeze through to the core as quickly as possible.

– VarioRoom: freezing the maximum amount of food (see data plate).

If there is insufficient air circulation in the freezer zone, the cooling performance will decrease and energy consumption will increase.

Do not remove the lowest freezer drawer from the refrigeration appliance.

When placing food in the freezer, make sure that the ventilation slots are not blocked.

Tip: If you wish to freeze large items of food such as a turkey or game, you can remove the individual freezer drawers to increase the space above a drawer.

Distribute the food in all freezer drawers **apart from** the lowest freezer drawer.

- Place the food so that it is touching the back of the drawer to help it freeze through to the core as quickly as possible.

Once frozen:

- Switch the SuperFreeze function  off.
- Place the frozen food in the freezer drawers and push them back in.

Cooling drinks quickly

When cooling drinks quickly in the freezer, make sure bottles are **not left in for more than one hour**; otherwise they could burst, causing injury and damage.

Operation

Making ice cubes

- Fill the ice cube tray $\frac{3}{4}$ full with water and place it on the bottom of one of the freezer drawers.
- Once frozen, use a blunt instrument, for example a spoon handle, to remove the ice cube tray from the freezer if it is stuck.

Tip: Ice cubes can be removed easily from the tray by twisting the tray gently or by holding it under cold running water for a short time.

Explanation of the different settings



Only the settings that require further explanation are described below.



The door alarm and other warnings are automatically suppressed when you are in Settings mode .

Party mode

The Party mode function  is recommended if you wish to chill or freeze large amounts of fresh food or drink quickly.

Tip: Switch on the Party mode function  approx. 4 hours before placing food and drinks in the appliance.



When Party mode  is switched on, the SuperFreeze  function is switched on automatically.

The Party mode function  will switch itself off automatically after approx. 24 hours. However, you can switch the Party mode function  off early at any time.

If there is a power cut, the Party mode function  is switched off.

Switching on the lock function /

When the lock function  is switched on, it protects the refrigeration appliance from being switched off inadvertently and against unintentional adjustments by unauthorised persons such as children.

■ In Settings mode , use the < or > sensor control to scroll to the  symbol.

■ Touch *OK*.

When the lock function  is switched on, a dot appears in the upper corner of the display •.

■ Close the appliance door. The lock function  is only activated now.

Briefly deactivating the lock function /

If, for example, you want to adjust the temperature, you can briefly deactivate the lock function:

■ Touch *OK*.

 will appear in the display.

■ Touch the *OK* sensor control for approx. 6 seconds.

 will appear in the display.

■ Touch *OK*.

■ Now select the required settings.

■ Touch *OK*.

Closing the appliance door will reactivate the lock function .

Switching off the lock function /

■ Touch *OK*.

 will appear in the display.

■ Touch the *OK* sensor control for approx. 6 seconds.

 will appear in the display.

■ Use the < or > sensor control to scroll to the  symbol.

■ Touch *OK*.

Selecting further settings

- Use the < or > sensor control to scroll to the  symbol.
- Touch *OK*.

When the lock function is switched off,  appears in the display.

Sabbath mode

The refrigeration appliance offers a Sabbath mode for the purposes of religious observance.

If Sabbath mode  is switched on, this will be indicated on the start display.

The display switches off after 3 seconds.

When Sabbath mode  is switched on, you cannot make any settings on your refrigeration appliance.

Ensure that the appliance door is properly closed, as visual and audible alarms are switched off.

The Sabbath mode function  will switch off automatically after approx. 80 hours.

When Sabbath mode  is switched on, the following are deactivated:

- All visual and audible signals
- The temperature display
- An active WiFi connection



All other functions switched on previously remain activated.



 Health risk caused by decomposing food.

As power failures are not indicated while Sabbath mode  is active, food may be exposed to increased temperatures for a certain period of time. This will reduce the storage life of the food.

If there is a power failure during Sabbath mode , check the quality of the food.

Switching Sabbath mode on

- In Settings mode , use the < or > sensor control to scroll to the  symbol.
- Tap *OK*.



When the Sabbath mode function  is switched on, a dot appears in the upper corner of the display .

The display switches off after 3 seconds.

- Close the appliance door.

Switching Sabbath mode off

- Touch the *OK* sensor control.  will appear in the display.
- Tap *OK*.

When the Sabbath mode function  is switched on, a dot appears in the upper corner of the display .



- Tap *OK*.

When the Sabbath mode function  is switched off, the dot in the upper corner of the display goes out.

Selecting further settings

Changing the time before the door alarm is triggered

You can set how quickly the door alarm sounds after the appliance door is opened.

- In Settings mode , use the < or > sensor control to scroll to the  symbol.
- Touch *OK*.
- Use the < and > sensor controls to set the time you want between 30 seconds and 3 minutes: 30 seconds.
- Touch *OK*.

Networking

Your refrigeration appliance is equipped with an integrated WiFi module. The WiFi module makes it possible to connect to your home network and to use the Miele app on a mobile device.

Once your refrigeration appliance has been connected via WiFi, the connection is automatically re-established every time it is switched on.

Make sure that your WiFi network signal is strong enough in the place where you intend to install your refrigeration appliance.

Connecting your refrigeration appliance to your WiFi network will increase energy consumption, even when the appliance is switched off.

Smart Extras via the Miele app*





Networking via the Miele app gives you access to numerous Smart Extras, including:

- Access status information.
- Use additional helpful functions.
- Keep your refrigeration appliance up to date with the latest Miele developments via software updates.

You can find more detailed information about Smart Extras on the Miele website, in the Apple App Store® or in the Google Play Store™.

*This is a separate digital offer from Miele & Cie. KG. The range of functions can vary depending on the model and the country. Acceptance of the Terms and Conditions and Privacy Policy for Miele digital products & services in the Miele app required. Miele reserves the right to change or discontinue the digital offer at any time.

Setting up networking for the first time

- Tap *OK*.
-  will appear in the display.
- Use the < or > sensor control to scroll to the  symbol.
- Tap *OK*.
- Use the < or > sensor control to scroll to the  symbol.
- Tap *OK*.
- Use the < and > sensor controls to select the connection method you wish to use (app or WPS).
- Tap *OK*.
- **To leave Settings mode** , use the < or > sensor control to scroll to the  symbol.

Selecting further settings



- Tap *OK*.
- Use the < or > sensor control to scroll to the ↩ symbol and tap *OK*.

After you have successfully logged in,  will appear in the display.

If a connection could not be created,  will appear.

Start the process again.



Deactivating the WiFi connection

- Tap *OK*.
-  will appear in the display.
- Use the < or > sensor control to scroll to the  symbol.
- Tap *OK*.
- Use the < or > sensor control to scroll to the  symbol.
- Tap *OK*.



If the WiFi is deactivated, the  symbol will appear in the display.

- **To leave Settings mode** , use the < or > sensor control to scroll to the ↩ symbol.
- Tap *OK*.
- Use the < or > sensor control to scroll to the ↩ symbol and tap *OK*.

Activating the WiFi connection

- Tap *OK*.
-  will appear in the display.
- Use the < or > sensor control to scroll to the  symbol.
- Tap *OK*.
- Use the < or > sensor control to scroll to the  symbol.
- Tap *OK*.







- Use the < or > sensor control to scroll to the ↩ symbol and tap *OK*.

If the WiFi is activated, the  symbol and a dot appear in the upper corner of the display .

- **To leave Settings mode** , use the < or > sensor control to scroll to the ↩ symbol.
- Tap *OK*.
- Use the < or > sensor control to scroll to the ↩ symbol and tap *OK*.

When the WiFi connection is active, the  symbol appears in the display.

Resetting the network configuration

- Tap *OK*.
-  will appear in the display.
- Use the < or > sensor control to scroll to the  symbol.
- Tap *OK*.
- Use the < or > sensor control to scroll to the  symbol.
- Tap *OK*.
- Use the > sensor control to scroll to the  symbol.
- Tap *OK*.
- Use the > sensor control to scroll to the  symbol.
- Tap *OK*.
- **To leave Settings mode** , use the < or > sensor control to scroll to the ↩ symbol.
- Tap *OK*.
- Use the < or > sensor control to scroll to the ↩ symbol and tap *OK*.

All entered settings and values are reset to the default settings.



Selecting further settings

The WiFi connection has been deactivated.  will go out on the display.

Reset the network configuration if you are disposing of or selling your refrigeration appliance, or if you are putting a used refrigeration appliance into operation. All personal data is removed from the refrigeration appliance. This will also ensure that a previous owner is no longer able to access the refrigeration appliance.

Adjusting the volume of alarms and buzzers /



You can adjust the volume of alarms and buzzers (e.g. in the event of a door alarm or fault message). You can also switch off the alarms and buzzers if they disturb you.

- In Settings mode , use the < or > sensor control to scroll to the  symbol.
- Touch *OK*.
- Use the < and > sensor controls to select the volume you want for alarms and buzzers.
- Touch *OK*.

 appears in the display when the alarms and buzzers are switched off.

Adjusting the display brightness

You can adjust the display brightness to suit the lighting conditions in the room.

- In Settings mode , use the < or > sensor control to scroll to the  symbol.
- Touch *OK*.
- Use the < and > sensor controls to select the display brightness you want.
- Touch *OK*.



Switching off demo mode

Demo mode  allows the refrigeration appliance to be presented by dealers without the cooling system being switched on. This setting is not needed for domestic use.

If demo mode has been switched on as a default setting,  will show on the display when the refrigeration appliance is switched on.

- Touch the *OK* sensor control on the control panel.



Miele will appear initially in the display, followed by the start screen.

- Touch *OK*.
- In Settings mode , use the < or > sensor control to scroll to the  symbol.
- Touch *OK*.

After demo mode  has been switched off, the refrigeration appliance switches off and must be switched on again.

Resetting the settings to their default settings

All settings made on the refrigeration appliance will be reset to default settings (for settings, see “Guide to the appliance”).

- In Settings mode , use the < or > sensor control to scroll to the  symbol.
- Touch *OK*.
- Use the > sensor control to scroll to the  symbol.
- Touch *OK*.

The refrigeration appliance switches off and must be switched on again.

Selecting further settings

Information **i**

Appliance data (model identifier and serial number) is shown on the display.

Keep this appliance data to hand:

- For integrating the refrigeration appliance into your WiFi network (see “Selecting further settings – Miele@home”) (depending on the model).
- When reporting an appliance fault to the Miele Customer Service Department (see “Service”).
- When retrieving information from the EPREL database (see “Service”).

The data plate located inside the interior cabinet of the refrigeration appliance must not be removed. It contains information which is required in the event of a fault.

Do not let water get into the electronic module.



Risk of damage due to moisture ingress.

The steam from a steam cleaner can damage plastic and electrical components.

Do not use a steam cleaner to clean the refrigeration appliance.

Defrosting

The appliance is equipped with a NoFrost system. The refrigeration appliance defrosts automatically.

Cleaning agents

Cleaning and conditioning agents used in the interior cabinet of the refrigeration appliance must be food safe.

To avoid damaging the surfaces of the appliance, **do not use the following:**

- Cleaning agents containing soda, ammonia, acids or chlorides
- Cleaning agents containing descaling agents
- Abrasive cleaning agents (e.g. scouring powder, scouring liquid or pumice stones)
- Cleaning agents containing solvents
- Stainless steel cleaners
- Dishwasher cleaner
- Oven sprays

- Glass cleaning agents
- Hard, abrasive sponges and brushes (e.g. pot scourers)
- Eraser stain remover blocks
- Sharp metal scrapers

We recommend using a clean sponge and lukewarm water with a little wash-up liquid to clean the surfaces of the appliance.

Preparing the refrigeration appliance for cleaning

- Switch the refrigeration appliance off.  appears in the display and the cooling system is switched off.
- Take any food out of the refrigeration appliance and store it in a cool place.
- Take out any removable accessories for cleaning (see “Removing and dismantling accessories for cleaning”).

Cleaning the inside of the appliance

Clean the refrigeration appliance regularly, or at least once a month.

If soiling is left on for any length of time, it may become impossible to remove under certain circumstances. Surfaces may suffer discolouration or damage.

It is therefore best to remove any soiling immediately.

Cleaning and care

- Clean the **interior** with a clean sponge, lukewarm water and a little washing-up liquid.
- After cleaning, wipe with clean water and dry with a cloth.
- Leave the door open to air the refrigeration appliance sufficiently for a short while and to prevent odour build-up.

Cleaning accessories by hand or in the dishwasher

The following components must be cleaned **by hand** only:

- All drawers

The following components are **dishwasher-safe**:

⚠ Risk of damage due to high dishwasher temperatures.

Parts of the refrigeration appliance may become unusable, e.g. deform, if they are washed in the dishwasher at more than 55 °C.

For dishwasher-safe components, always select dishwasher programmes with a maximum temperature of 55 °C.

Contact with natural dyes from carrots, tomatoes and ketchup, etc., may discolour the plastic parts in the dishwasher. This discolouration does not affect the stability of the parts.

- The ice cube tray

Removing and dismantling accessories for cleaning

Removing the drawers

- Pull the drawer out as far as it will go.

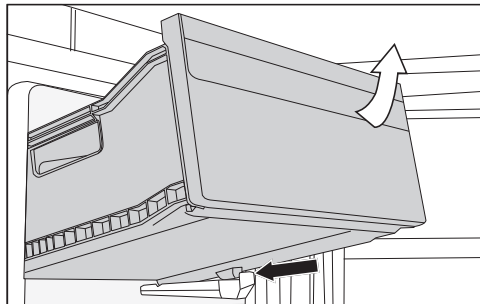

- Lift the drawer at the front and pull it out.

Replacing the drawers

- Insert the drawers into the refrigeration appliance from an angle.
- Push in and lower the drawer.

Cleaning the front of the appliance and the side panels

If soiling is left on for any length of time, it may become impossible to remove. Surfaces may suffer discolouration or damage.

Therefore, it is best to remove soiling from the appliance front and side panels immediately.

All surfaces are susceptible to scratching. Contact with unsuitable cleaning agents can alter or discolour the surfaces.

See the information on “Cleaning agents” at the beginning of this section.

- Clean the surfaces with a clean sponge and a solution of warm water and washing-up liquid. A clean, damp microfibre cloth without cleaning agent can also be used.
- After cleaning, wipe with clean water and dry with a soft cloth.

Cleaning the door seal

 Risk of damage as a result of incorrect cleaning.

If you treat the door seal with oils or grease, it can become porous.

Do not use any oils or grease on the door seal.

- The door seal should be cleaned regularly with clean water, and then wiped dry with a soft cloth.

Cleaning the ventilation openings

- The ventilation openings should be cleaned on a regular basis with a feather duster or vacuum cleaner (you could use a Miele vacuum cleaner dusting brush, for example).

After cleaning

- Replace all shelves and accessories in the refrigeration appliance.
- Switch the refrigeration appliance back on, if necessary.

The refrigeration appliance will start cooling again.

- Switch the SuperFreeze function ❄ on for a while so that the freezer section can cool down quickly.
- Once the freezer has reached the required temperature, place the frozen food back in the freezer drawers and put them back in the freezer.
- Switch the SuperFreeze function ❄ off as soon as the temperature in the freezer is a constant -18°C or colder.
- Close the appliance door.

Troubleshooting

Many malfunctions and faults can be easily remedied. You can save time and money in many cases, as you do not need to contact Customer Service.

More information to help you remedy faults yourself can be found at www.miele.co.uk/support/customer-assistance.







To prevent unnecessary loss of temperature it is advisable not to open the door while waiting for the appliance to be serviced.

Other problems









Problem	Cause and remedy
The refrigeration appliance is not cooling.	The refrigeration appliance has not been switched on. ■ Switch the refrigeration appliance on.
	The mains plug is not inserted in the socket correctly or the plug connector is not inserted into the socket at the back of the appliance correctly. ■ Insert the mains plug into the mains socket and the plug connector into the appliance socket correctly and switch on.
	The mains fuse has tripped. There could be a fault with the refrigeration appliance, the household electrical wiring or another electrical appliance. ■ Contact a qualified electrician or the Miele Customer Service Department.
The compressor runs continuously.	This is not a fault. To save energy, the compressor runs at a lower speed when less cooling is required. This increases the compressor running time.
The compressor is switching on more frequently and for longer periods of time. The temperature in the refrigeration appliance is too low.	The appliance doors have been opened too frequently. Or large amounts of fresh food have been placed in the appliance. ■ Only open the appliance doors when necessary and for as short a time as possible.
	The appliance doors are not closing fully. The temperature in the refrigeration appliance is dropping.

Problem	Cause and remedy
	<p>■ Check that the appliance doors are seated correctly and use the screws in the hinges to adjust them if necessary.</p> <p>The appliance doors are not closed properly. If a thick layer of ice has already formed, this will affect cooling and increase energy consumption.</p> <p>■ Always close the appliance doors fully.</p> <p>■ Defrost the refrigeration appliance if necessary and clean it.</p> <p>The ambient temperature is too high. The higher the ambient temperature, the longer the compressor runs.</p> <p>■ See the information in “Installation – Installation site”.</p> <p>The ventilation openings are covered or dusty.</p> <p>■ Do not block the ventilation openings.</p> <p>■ Dust the ventilation openings regularly.</p> <p>Built-in appliances: the refrigeration appliance was not properly installed in the niche.</p> <p>■ Install the refrigeration appliance in the niche as described in the installation instructions.</p>
<p>The temperature in the refrigeration appliance is too low.</p>	<p>The temperature setting in the refrigeration appliance is too low.</p> <p>■ Correct the temperature setting.</p> <p>A large amount of food has been frozen at once.</p> <p>■ Refer to the instructions in “Operation – Freezing and storing fresh food”.</p> <p>The SuperFreeze ❄ function is still switched on.</p> <p>■ Switch off the SuperFreeze ❄ function earlier to save energy.</p>



Troubleshooting







Problem	Cause and remedy
<p>The temperature in the refrigeration appliance is too high. The frozen food (depending on the model) could defrost.</p>	<p>This is not a fault. The temperature setting is too high.</p> <ul style="list-style-type: none"> ■ Correct the temperature setting. ■ Check the temperature again after 24 hours. <p>The ambient temperature is too low for this refrigeration appliance. If the ambient temperature is too low, the compressor will run less frequently. The temperature in the refrigeration appliance is rising.</p> <ul style="list-style-type: none"> ■ See the information in “Installation – Installation site”. ■ Increase the ambient temperature.
<p>Ice or condensation has built up inside the refrigeration appliance. The appliance door may not close correctly.</p>	<p>The door seal has come out of its groove.</p> <ul style="list-style-type: none"> ■ Check that the door seal is correctly positioned in the groove. <p>The door seal is damaged.</p> <ul style="list-style-type: none"> ■ Check whether the door seal is damaged.
<p>The door seal is damaged or needs to be replaced.</p>	<p>No tools are required to change the door seal.</p> <ul style="list-style-type: none"> ■ Change the door seal. A replacement is available from Miele or from specialist retailers.
<p>Food has frozen together.</p>	<p>The food packaging was not dry when placed in the freezer.</p> <ul style="list-style-type: none"> ■ Use a blunt instrument, e.g. a spoon handle or plastic scraper, to prise it apart carefully.
<p>There is no audible alarm even though the door has been open for a long time.</p>	<p>This is not a fault. The alarm has been switched off in Settings mode. If you want to switch the audible alarm back on again:</p> <ul style="list-style-type: none"> ■ Tap <i>OK</i>. ■  will appear in the display. ■ Use the < or > sensor control to scroll to the  symbol. ■ Tap <i>OK</i>. ■ Use the < or > sensor control to scroll to the  symbol. ■ Tap <i>OK</i>. ■ Use the < and > sensor controls to select the volume you want for alarms and buzzers. ■ Tap <i>OK</i>. <p>When the alarms and buzzers are switched on,  will appear.</p>

Display warnings

Message	Cause and remedy
<p>■ lights up in the display. The refrigeration appliance does not get cold, although the appliance controls are working.</p>	<p>Demo mode has been activated.</p> <ul style="list-style-type: none"> ■ Touch <i>OK</i>. <p>Miele will appear initially in the display, followed by the start screen.</p> <ul style="list-style-type: none"> ■ Touch <i>OK</i>. ■ In Settings mode , use the < or > sensor control to scroll to the ■ symbol. ■ Touch <i>OK</i>. <p>After demo mode ■ has been switched off, the refrigeration appliance shuts down and must be switched on again.</p>
<p>Nothing is visible in the display. The display is completely blank.</p>	<p>Sabbath mode  is switched on.</p> <ul style="list-style-type: none"> ■ Touch <i>OK</i>. <p> will appear in the display.</p> <ul style="list-style-type: none"> ■ Touch <i>OK</i>. <p>When the Sabbath mode function  is switched on, a dot appears in the upper corner of the display •.</p> <ul style="list-style-type: none"> ■ Touch <i>OK</i>. <p>When the Sabbath mode function  is switched off, the dot in the upper corner of the display goes out.</p>
<p>The  symbol is lit up on the display and the refrigeration appliance cannot be used.</p>	<p>The lock function has been activated.</p> <ul style="list-style-type: none"> ■ Unlock the refrigeration appliance temporarily or switch the lock function off completely.
<p> lights up in the display and an alarm also sounds.</p>	<p>The door alarm has been activated.</p> <ul style="list-style-type: none"> ■ Touch <i>OK</i>. <p>The alarm will stop and the  symbol will go out.</p> <ul style="list-style-type: none"> ■ Close the appliance door.

Troubleshooting

Message	Cause and remedy
<p> is lit up in the temperature display and an alarm is also sounding.</p>	<p>The temperature alarm has been activated; the temperature in the freezer section has risen higher or fallen lower than the temperature set.</p> <p>Possible reasons for this include:</p> <ul style="list-style-type: none"> – The appliance door has been opened too frequently. – A large quantity of fresh food has been placed in the freezer without switching on the Super-Freeze function. – A prolonged power cut (mains outage) has occurred. – The refrigeration appliance has a fault. <p>■ Touch <i>OK</i>.</p> <p>The alarm message is confirmed:  goes out and the alarm stops.</p> <p>The warmest temperature recorded in the refrigeration appliance will flash for about 1 minute in the display. Then the temperature display will change to the current temperature.</p> <p>You can exit from the flashing temperature display early:</p> <p>■ Touch <i>OK</i>.</p> <p>The warmest temperature displayed will disappear. The display will then revert to showing the current temperature in the freezer.</p> <p>■ Rectify the cause of the alarm.</p> <p>■ Depending on the temperature displayed, you should check whether food in the freezer has started to thaw or has defrosted. If it has, it should be used as soon as possible. Defrosted food may only be re-frozen after it has been cooked.</p>

Message	Cause and remedy
<p> lights up in the display and an alarm also sounds.</p>	<p>Indication of a power failure: the temperature in the wine unit over the last few days or hours has risen too high because of a power failure or interruption to the power supply.</p> <ul style="list-style-type: none"> ■ Tap <i>OK</i>. <p> goes out and the alarm will stop.</p> <p>The warmest temperature recorded in the wine unit will flash for about 1 minute in the display. Then the temperature display will change to the current temperature.</p> <p>You can exit from the flashing temperature display early:</p> <ul style="list-style-type: none"> ■ Tap <i>OK</i>. <p>The warmest temperature display will disappear. The display will then revert to showing the current temperature inside the wine unit.</p> <ul style="list-style-type: none"> ■ Remedy the cause of the alarm.
<p> lights up in the display and a fault code F with numbers may appear. An alarm also sounds.</p>	<p>There is a fault.</p> <ul style="list-style-type: none"> ■ Switch the alarm off by tapping <i>OK</i>. ■ Contact Customer Service. <p>To report the fault, you need the fault code and also the model identifier and serial number of your refrigeration appliance. You can access this information  in the display:</p> <ul style="list-style-type: none"> ■ Tap <i>OK</i>. <p>The appliance data required will be shown on the display.</p> <ul style="list-style-type: none"> ■ Tap <i>OK</i>. ■ To switch off the refrigeration appliance, use the < or > sensor control to scroll to the  symbol. ■ To exit the information display, use the < or > sensor control to scroll to the  symbol. ■ Tap <i>OK</i>. <p>There is an appliance fault: this display always has priority over any settings which have just been selected.</p> <p>An appliance fault has priority over any current door and/or temperature alarms displayed.</p>

Troubleshooting

Noises

The refrigeration appliance is producing various noises during operation. If the cooling performance is low, the refrigeration appliance will conserve energy but operate for longer. The volume will be lower. Food will be chilled faster if the cooling performance is high. The volume will be higher.

Normal noises	What is causing the noises?
Hissing	Refrigerant is being injected into the cooling circuit.
Bubbling, gurgling, splashing	Refrigerant is circulating through the pipes.
Humming	The refrigeration appliance is cooling.
Clicking	The thermostat is switching the compressor on or off.
Humming, whirring	The fan is running. The automatic door opener (depending on the model) is opening or closing the appliance door.
Cracking	Material in the refrigeration appliance is expanding.
Rattling	Valves or flaps are active.
Buzzing (refrigeration appliances with water container)	Water is being pumped out of the water container.
Slurping (refrigeration appliances with soft-close mechanism)	The appliance door with soft-close mechanism is being opened or closed.

Please bear in mind that a certain amount of noise is unavoidable (from the compressor and the refrigerant circulating through the cooling circuit).

Noises	Cause and remedy
Vibrating, rattling, clinking	The refrigeration appliance is uneven. Use a level to check and adjust the alignment of the refrigeration appliance. The refrigeration appliance is aligned by raising or lowering the adjustable feet (depending on the model) underneath it. For built-in appliances: For niches of 140 cm and more: place the stabilising rods supplied underneath the appliance base.
	The refrigeration appliance is touching another appliance or piece of furniture. Move it away.
	Drawers, baskets or shelves are jiggling or are stuck. Check all removable items and refit them correctly.
	Bottles or containers are touching. Separate bottles or containers slightly.
	The transport cable clips (depending on the model) are hanging loose at the back of the appliance. Remove the transport cable clips.

Service

Information to help you rectify faults yourself and about Miele spare parts can be found at www.miele.com/service.

Contact in the event of a fault

In the event of a fault which you cannot remedy yourself, please contact your Miele dealer or Miele Customer Service.

You can book a Miele Customer Service call-out online at www.miele.com/service.

Contact information for Miele Customer Service can be found at the end of this document.

Please quote the model identifier and serial number of your appliance (SN) when contacting Miele Customer Service. Both numbers can be found on the data plate inside the refrigeration appliance or, depending on the model, in Settings mode under Information **i**.

EPREL database

Since 1 March 2021, information on energy labelling and ecodesign requirements has been available in the European Product Database (EPREL). You can find the product database at the following link <https://eprel.ec.europa.eu/>. You will be asked to enter the model identifier.

The model identifier can be found on the data plate inside the refrigeration appliance or, depending on the model, in Settings mode under Information **i**.

Miele

XXXXXX ← Nr. XX/XXXXXXXXXX.

WEINTEMPERIER-SCHNANK-UNTERTISCH-MODELL
 MULTI-TEMPERATURE WINE STORAGE CABINET-UNDER-VORSTOPF
 ARMOIRE DE MISE EN TEMP. DES VINS/AVC. ENCASTRABLE SOUS PLAN
 АРМОИР. П.АССИДЕНСОВАНО. ВИНОВИДЕН ПОТРУБНОУ ИНДИМА
 ВИННИЙ ТЕМПЕРАТУРНИЙ ШКАФ

Klasse/Class Class/Classe SN-ST	Ap-Typ/AP-Type AP-Type/AP-Tipo	Bruttinhalt/Gross Capacity Volume Brut/Capacità Bruta XXXX l	Gefriervermögen/Freezing Capacity Pouvoir de Congel/Capac. Congeladora
---------------------------------------	-----------------------------------	--	---

Nutzinhalt Net Capacity Volume Utile Capac. Util	Ges. / K / G Tot. / R / F Tot. / R / C Tot. / F / C	/ WEIN / KALT / WINE / CHILL / WINE / CHILL / WINE / CHILL	R600a: XXg
---	--	---	-------------------

Warranty

For information on the appliance warranty specific to your country please contact Miele. See back cover for address.

In the UK, your appliance warranty is valid for 2 years from the date of purchase. However, you must activate your cover by calling 0330 160 6640 or registering online at www.miele.co.uk.

EU Conformity declaration

Miele hereby declares that this fridge-freezer complies with Directive 2014/53/EU. The complete text of the EU declaration of conformity is available from one of the following internet addresses:

- Products, Download from www.miele.ie
- For service, information, operating instructions etc: go to <https://miele.ie/manuals> and enter the name of the product or the serial number

Frequency range of the WiFi module	2.4000–2.4835 GHz
------------------------------------	-------------------

Maximum transmission power of the WiFi module	< 100 mW
---	----------

UK Conformity declaration

Miele hereby declares that this fridge-freezer complies with UK Radio Equipment Regulations 2017, as amended.

The complete text of the UK declaration of conformity is available from one of the following internet addresses:

- Products, Download from www.miele.co.uk
- For service, information, operating instructions etc: go to <https://miele.co.uk/manuals> and enter the name of the product or the serial number

Frequency band of the WiFi module	2.4000 GHz – 2.4835 GHz
-----------------------------------	-------------------------

Maximum transmitting power of the WiFi module	< 100 mW
---	----------

Information

This **Statement of Compliance** confirms this Miele product fully complies with the **Product Security and Telecommunications Infrastructure (Security Requirements for Relevant Connectable Products) Regulations 2023**.

- 1) Household Appliance – *Freezer - 120002, 120003, 220009, 320001, 320002*
Refrigerator - 110001, 110002, 210010, 310001, 310002, 310003
Fridge-freezer - 130001, 130002, 130003, 130004, 330001, 330002, 330005
Wine unit - 210007, 210011, 310004, 330004
- 2) Manufactured by: Miele & Cie KG,
Carl Miele Street 29, 33332 Gutersloh Germany
Imported by and contact point: Miele Company Ltd, Fairacres, Marcham Road,
Abingdon, Oxon, OX14 ITW Great Britain
- 3) The defined support period at the time of first supply is 10 years
- 4) To report vulnerabilities and cybersecurity issues please contact: psirt@miele.com
- 5) Signature 
Name: **Paul Wright**
Company Position: **Head of Technical Management**
Date of signature: **19th March 2024**
Place of signature: **Abingdon, Oxfordshire**

Copyrights and licences

For the purpose of operating and controlling the communication module, Miele uses proprietary or third-party software that is not covered by open source licensing terms. This software/these software components are protected by copyright. The copyrights held by Miele and third parties must be respected.

Furthermore, the communication module integrated in the appliance contains software components which are distributed under open source licence conditions. The open source components contained in the appliance along with the corresponding copyright notices, copies of the licensing terms valid at the time and any further information can be accessed locally by IP via a web browser ([http\[s\]://<IP address>/Licenses](http[s]://<IP address>/Licenses)). The liability and warranty arrangements for the open source licences displayed in this location only apply in relation to the respective rights holders.

United Kingdom

Miele Co. Ltd., Fairacres, Marcham Road, Abingdon, Oxon, OX14 1TW
Tel: 0330 160 6600, Internet: www.miele.co.uk, E-mail: info@miele.co.uk

Australia

Miele Australia Pty. Ltd.
ACN 005 635 398
ABN 96 005 635 398
Level 4, 141 Camberwell Road
Hawthorn East, VIC 3123
Tel: 1300 464 353
E-mail: info@miele.com.au
Internet: www.miele.com.au

China Mainland

Miele Electrical Appliances Co. Ltd.
No. 82, Shimenyi Road, JingAn District
Shanghai, China, P.R.C
Post Code: 200040
Phone: +86 21 6157 3500
Fax: +86 21 6157 3511
E-mail: info@miele.cn
Internet: www.miele.cn

Hong Kong, China

Miele (Hong Kong) Ltd.
41/F - 4101, Manhattan Place
23 Wang Tai Road
Kowloon Bay, Hong Kong
Tel: (852) 2610 1025
Fax: (852) 3579 1404
E-mail:
customerservices@miele.com.hk
Website: www.miele.hk

India

Miele India Pvt. Ltd.
1st Floor, Copia Corporate Suites,
Commercial Plot 9, Mathura Road,
Jasola, New Delhi - 110025
E-mail: customercare@miele.in
Website: www.miele.in

Ireland

Miele Ireland Ltd.
2024 Bianconi Avenue
Citywest Business Campus
Dublin 24
Tel: (01) 461 07 10
Fax: (01) 461 07 97
E-mail: info@miele.ie
Internet: www.miele.ie

Malaysia

Miele Sdn Bhd
Suite 12-2, Level 12
Menara Sapura Kencana
Petroleum
Solaris Dutamas No. 1
Jalan Dutamas 1
50480 Kuala Lumpur, Malaysia
Phone: +603-6209-0288
Fax: +603-6205-3768

New Zealand

Miele New Zealand Limited
IRD 98 463 631
8 College Hill
Freemans Bay, Auckland 1011
Tel: 0800 464 353
E-mail: customercare@miele.co.nz
Internet: www.miele.co.nz

Singapore

Miele Pte. Ltd.
29 Media Circle
#11-04 ALICE@Mediapolis
Singapore 138565
Tel: +65 6735 1191
Fax: +65 6735 1161
E-mail: info@miele.com.sg
Internet: www.miele.sg

South Africa

Miele (Pty) Ltd.
63 Peter Place, Bryanston 2194
P.O. Box 69434, Bryanston 2021
Tel: (011) 875 9000
Fax: (011) 875 9035
E-mail: info@miele.co.za
Internet: www.miele.co.za

Thailand

Miele Appliances Ltd.
BHIRAJ TOWER at EmQuartier
43rd Floor Unit 4301-4303
689 Sukhumvit Road
North Klongton Sub-District
Vadhana District
Bangkok 10110, Thailand

United Arab Emirates

Miele Appliances Ltd.
Showroom 1, Eiffel 1 Building
Sheikh Zayed Road, Umm Al Sheif
P.O. Box 114782 - Dubai
Tel. +971 4 3044 999
Fax. +971 4 3418 852
800-MIELE (64353)
E-mail: info@miele.ae
Website: www.miele.ae

Manufacturer: Miele & Cie. KG, Carl-Miele-Straße 29, 33332 Gütersloh, Germany

FNS 4382 ..., FNS 4383 ...

en-GB

M.-Nr. 12 543 580 / 03 / 002