





Operating and installation instructions Combination steam oven



To avoid the risk of accidents or damage to the appliance it is **essential** to read these instructions before it is installed and used for the first time.







Contents

Warning and Safety instructions	6
Caring for the environment	14
Guide to the appliance	15
Controls	16
On/Off sensor control	17
Display	17
Sensor controls	17
Symbols	19
Using the appliance	20
Selecting a menu option	20
Changing a setting in a list	20
Changing the setting with a segment bar	20
Selecting a function or operating mode	20
Entering numbers	21
Activating MobileStart	21
Drawing in water	22
Features	23
Data plate	23
Scope of delivery	23
Accessories supplied and available to order	23
Safety features	29
PerfectClean treated surfaces	29
Before using for the first time	30
Miele@home	30
Basic settings	31
Heating up the combination steam oven for the first time and rinsing the steam injection system	32
Settings	33
Settings overview	33
Opening the “Settings” menu	35
Language 	35
Time	35
Lighting	35
Display	36
Volume	36
Units	37
Booster	37
Rapid cooling	37
Keeping warm	38
Recommended temps.	38
Cooling fan run-on	38
Water hardness	39
Altitude	41

Safety	41
Miele@home	41
Remote control	42
Activating MobileStart	42
RemoteUpdate	42
Software version	43
Showroom programme	43
Factory default	43
Operating hours	43
Min. minder	44
Main and sub-menus	45
Energy saving tips	46
Operation	48
Changing values and settings for a cooking programme	49
Changing the temperature	49
Setting cooking durations	49
Changing the set cooking durations	50
Deleting the set cooking durations	50
Cancelling a cooking programme	50
Interrupting a cooking process in the Steam cooking  operating mode	50
Pre-heating the oven	51
Booster	51
Rapid cooling	52
Keeping warm	52
Steam cooking	53
Using Steam cooking 	53
Frozen food	53
Cooking with liquid	54
Notes on the cooking charts	54
Shelf level	54
Temperature	54
Cooking duration	54
Vegetables	54
Fish	55
Meat	56
Rice	57
Grains	57
Pasta	57
Fruit	57
Moisture plus	58
Using Moisture plus 	58
Automatic programmes	60
Categories	60

Contents

Using automatic programmes	60
Usage notes	60
Further applications	61
Defrost	61
Low temperature cooking.....	61
Drying.....	62
Frozen food/Ready meals.....	63
Heat crockery.....	63
Baking	64
Tips on baking.....	64
Notes on the cooking charts	64
Notes on the functions	65
Roasting	66
Tips for roasting.....	66
Notes on the cooking charts	66
Notes on the functions.....	67
Grilling	68
Tips for grilling.....	68
Notes on the cooking charts	68
Notes on the functions.....	69
Cleaning and care	70
Unsuitable cleaning agents.....	70
Removing normal soiling.....	70
Removing stubborn soiling (excluding the FlexiClip runners).....	71
Stubborn soiling on the FlexiClip runners.....	72
Cleaning the catalytic enamelled back panel.....	72
Removing soiling caused by spices, sugar and similar deposits	73
Removing oil and grease.....	73
Cleaning the ceiling of the oven	73
Evaporate res. moisture.....	74
Maintenance	75
Soak	75
Drying	76
Descale.....	76
Removing the door.....	79
Dismantling the door	80
Fitting the door	82
Removing the side runners with FlexiClip runners.....	82
Removing the back panel.....	83
Problem solving guide	84
Service	89
Contact in the event of a fault	89
Warranty	89

Installation	90
Installation dimensions	90
Installation in a tall or housing unit	90
Side view	91
Connections and ventilation	92
Installing the combination steam oven	93
Electrical connection	94
Combination steam oven	94
Electrical connection: Other countries	95
Cooking charts	96
Vegetables 	96
Fish 	97
Meat 	97
Dumplings 	97
Rice 	97
Batter	98
Shortcrust pastry	99
Yeast dough	100
Quark dough	101
Sponge mixture	101
Choux pastry, puff pastry, meringue	102
Savoury dishes	103
Beef	104
Veal	105
Pork	106
Lamb, game	107
Poultry, fish	108
Notes for test institutes	109
Test food in accordance with EN 60350-1 (Steam cooking  operating mode)	109
Menu cooking test food (Steam cooking  operating mode)	110
Test food in accordance with EN 60350-1 (oven operating modes)	111
Energy efficiency class according to EN 60350-1	112
Technical data	113
EU Conformity declaration	113
UK Conformity declaration	113
Copyrights and licences for the communication module	114

Warning and Safety instructions

This combination steam oven complies with all current local and national safety requirements. Inappropriate use can, however, lead to personal injury and material damage.

Read the operating and installation instructions carefully before using the combination steam oven. They contain important information on safety, installation, use and maintenance. This prevents both personal injury and damage to the combination steam oven.

In accordance with standard IEC/EN 60335-1, Miele expressly and strongly advises that you read and follow the instructions in the chapter on installing the combination steam oven as well as the safety instructions and warnings.

Miele cannot be held liable for injury or damage caused by non-compliance with these instructions.

Keep these instructions in a safe place and pass them on to any future owner.

Appropriate use

- ▶ This combination steam oven is intended for domestic use and use in other similar environments.
- ▶ This combination steam oven is not intended for outdoor use.
- ▶ The combination steam oven is intended for domestic use only to steam cook, bake, roast, grill, defrost, bottle and dry food. All other types of use are not permitted.
- ▶ This combination steam oven may only be used by people with reduced physical, sensory or mental capabilities or lack of experience and knowledge if they are supervised whilst using it. They may only use it unsupervised if they have been shown how to use it in a safe manner. They must be able to recognise and understand the dangers of misuse.
- ▶ The oven compartment is equipped with special lamps to cope with particular conditions (e.g. temperature, moisture, chemical resistance, abrasion resistance and vibration). These special lamps must only be used for the purpose for which they are intended. They are not suitable for room lighting.
- ▶ The combination steam oven contains 1 light source corresponding to energy efficiency class G.

Safety with children

- ▶ Activate the system lock to ensure that children cannot switch the combination steam oven on by mistake.
- ▶ Children under 8 years of age must be kept away from the combination steam oven unless they are constantly supervised.
- ▶ Children aged 8 and older may only use the combination steam oven without supervision if they have been shown how to use it in a safe manner. Children must be able to understand and recognise the possible dangers caused by incorrect operation.
- ▶ Children must not be allowed to clean or maintain the combination steam oven unsupervised.
- ▶ Children should be supervised in the vicinity of the combination steam oven. Never allow children to play with the combination steam oven.
- ▶ Risk of suffocation due to packaging material. Whilst playing, children may become entangled in packaging material (such as plastic wrapping) or pull it over their head, presenting the risk of suffocation.

Keep packaging material away from children.

- ▶ Risk of injury caused by hot surfaces and steam. Children's skin is far more sensitive to high temperatures than that of adults. External parts of the combination steam oven such as the door glass, control panel and the vent become quite hot. Do not let children touch the combination steam oven when it is in operation.
Keep children well away from the combination steam oven until it has cooled down and there is no risk of injury.

- ▶ Risk of injury from the open door.

The oven door can support a maximum weight of 15 kg. Children could injure themselves on an open door.

Do not let children sit on the open door, lean against it or swing on it.

Technical safety

- ▶ Unauthorised installation, maintenance and repairs can cause considerable danger for the user. Installation, maintenance and repairs must only be carried out by a Miele authorised technician.
- ▶ Damage to the combination steam oven can compromise your safety. Check the combination steam oven for visible signs of damage. Do not use a damaged combination steam oven.

Warning and Safety instructions

► Temporary or permanent operation on an autonomous power supply system or a power supply system that is not synchronised with the mains power supply (e.g. island networks, back-up systems) is possible. A prerequisite for operation is that the power supply system complies with the specifications of EN 50160 or an equivalent standard.

The function and operation of the protective measures provided in the domestic electrical installation and in this Miele product must also be maintained in isolated operation or in operation that is not synchronised with the mains power supply, or these measures must be replaced by equivalent measures in the installation. As described, for example, in the current version of BS OHSAS 18001–2 ISO 45001.

► The electrical safety of this combination steam oven can only be guaranteed when correctly earthed. It is essential that this basic safety requirement is fulfilled. If in doubt, the electrical installation should be checked by a qualified electrician.

► The connection data (voltage and frequency) on the data plate of the combination steam oven must match the mains electricity supply in order to avoid the risk of damage to the oven. Compare this before connecting the appliance to the mains. If in any doubt, consult a qualified electrician.

► Multi-socket adapters and extension leads do not guarantee the required safety of the appliance. Do not use these to connect the combination steam oven to the domestic electrical supply.

► For safety reasons, the combination steam oven may only be used when it has been built in and fully installed.

► This combination steam oven must not be used in a non-stationary location (e.g. on a ship).

► Risk of injury due to electric shock. Any contact with live connections or tampering with the electrical or mechanical components of the combination steam oven will endanger your safety and may lead to appliance malfunctions.

Do not open the housing of the combination steam oven under any circumstances.

► While the combination steam oven is under warranty, repairs should only be undertaken by a service technician authorised by the Miele Customer Service Department. Otherwise the warranty will be invalidated.

Warning and Safety instructions

- ▶ Miele can only guarantee the safety of the oven when original Miele spare parts are used. Faulty components must only be replaced by original spare parts.
- ▶ If the combination steam oven is delivered without a mains connection cable, a special cable must be installed by a Miele authorised technician (see “Installation – Electrical connection”).
- ▶ If the connection cable is damaged, it must be replaced with a special connection cable by a Miele authorised service technician (see “Installation”, “Electrical connection”).
- ▶ During installation, maintenance and repair work, e.g. if the oven interior lighting is faulty (see “Problem solving guide”), the combination steam oven must be completely disconnected from the household electricity supply. To ensure this, do one of the following:
 - Disconnect the mains fuse
 - Completely unscrew the screw-out fuse (in countries where this is applicable)
 - Pull out the plug (if one is present) at the wall socket. To do this, pull the plug and not the mains connection cable.
- ▶ The combination steam oven requires a sufficient supply of cool air for efficient operation. Make sure that the supply of cool air is not hindered in any way (e.g. by fitting heat insulation strips in the housing unit). Furthermore, the required supply of cool air must not be excessively heated by other heat sources (e.g. solid fuel stoves).
- ▶ If the combination steam oven is built in behind a furniture front (e.g. a door), do not close the furniture door while the oven is in use. Heat and moisture can build up behind the furniture front when closed. This can result in damage to the combination steam oven, the housing unit and the floor. Leave the furniture door open until the combination steam oven has cooled down completely.

Correct use

- ▶ Risk of injury caused by hot surfaces and steam. The combination steam oven gets hot during operation. You could burn yourself on the steam, heater elements, oven compartment, accessories or food. Use oven gloves when placing hot food in the appliance or removing it and when working in the hot oven compartment.

Warning and Safety instructions

▶ Risk of injury caused by hot food.

Food may spill or splash around when placing it into the oven or removing it. The food can cause burns.

When placing cooking containers into the oven or removing them, make sure that the hot food does not spill.



▶ To avoid fuelling any flames, do not open the combination steam oven door if there is smoke inside the oven compartment. Interrupt operation by switching the combination steam oven off and disconnecting it from the electricity supply. Do not open the door until the smoke has dispersed.

▶ Due to the high temperatures radiated, objects left near the combination steam oven could catch fire. Do not use the combination steam oven to heat up the room.

▶ Oils and fats can ignite if allowed to overheat. Never leave the combination steam oven unattended when cooking with oil or fats. Never attempt to put out oil or fat fires with water. Switch the combination steam oven off and extinguish the flames by leaving the door closed.

▶ Grilling food for excessively long cooking durations can cause it to dry out with the risk of catching fire. Do not exceed the recommended cooking durations.



▶ Certain foods dry out quickly and may catch fire due to high grill temperatures.

Never use grill modes to finish baking partially baked rolls or bread or to dry flowers or herbs. Instead, use the Fan plus  or Conventional heat  function.

▶ If using alcohol in your recipes, please be aware that high temperatures can cause the alcohol to vaporise. The vapour can catch fire on hot heating elements.

▶ When using residual heat to keep food warm, corrosion from high air humidity and condensation can occur in the combination steam oven. This can also cause damage to the control panel, worktop and surrounding kitchen furniture. Keep the combination steam oven on and select the lowest temperature available for the selected operating mode. The cooling fan will then continue to run automatically.

Warning and Safety instructions

- ▶ Food which is stored in the oven compartment or left in it to be kept warm can dry out and the moisture released can lead to corrosion damage in the combination steam oven. Always cover food that is left in the oven to keep warm.
- ▶ An accumulation of heat can cause the enamel on the oven compartment floor to crack or flake off.
Never line the floor of the oven compartment with aluminium foil or oven liners.
If you wish to place crockery on the floor of the oven compartment during cooking, or place crockery on the floor of the oven compartment to heat it up, you can do so, but only with the Fan plus  or Eco Fan heat  function, without the Booster function.
- ▶ The oven compartment floor can become damaged by items being pushed around on it. When placing pots, pans or crockery on the oven compartment floor, ensure that you avoid pushing them around.
- ▶ Risk of injury caused by steam. Pouring a cold liquid onto a hot surface creates steam, which can cause severe scalding. The sudden temperature change can also cause damage to hot enamelled surfaces. Never pour cold liquids directly onto hot enamelled surfaces.
- ▶ Risk of injury caused by steam. During steam cooking, during cooking processes using moisture and during the residual moisture evaporation process, steam is produced which can cause serious injury by scalding. Never open the door during a cooking process involving steam or during the evaporation of residual water.
- ▶ It is important that the temperature in the food being cooked is evenly distributed and sufficiently high. This can be achieved by stirring or turning the food.
- ▶ Plastic dishes that are not suitable for use in an oven will melt and may ignite at high temperatures, and can damage the combination steam oven.
Use only plastic containers that are suitable for use in an oven. Follow the instructions from the crockery manufacturer.
If you wish to use plastic containers for steam cooking, make sure that these are heat-resistant to 100 °C and able to withstand hot steam. Other plastic containers can melt or become fragile and brittle.
- ▶ Heating up food in closed containers, such as tins or sealed jars, will result in an increase in pressure, which can cause them to explode. Do not heat up unopened tins or jars of food in the oven.

Warning and Safety instructions

- ▶ Risk of injury from the open door. You could bang into the open door or trip over it. Avoid leaving the door open unnecessarily.
- ▶ The door can support a maximum load of 15 kg. Do not lean or sit on the door when open, or place heavy items on it. Make sure that nothing gets trapped between the door and the oven compartment. This could damage the combination steam oven.
- ▶ The steam could reach live electrical components and cause a short circuit. This could also destroy the electrical components. Do not use the combination steam oven if it does not have a lamp cover.

The following applies to stainless steel surfaces:

- ▶ Adhesives will damage the stainless steel surface and cause it to lose its dirt-repellent protective coating. Do not use sticky notes, adhesive tape or other types of adhesive on the stainless steel surface.
- ▶ Magnets can cause scratches. Do not use the stainless steel surface as a magnetic notice board.

Cleaning and care

- ▶ Risk of injury due to electric shock. The steam from a steam cleaning appliance could reach live electrical components and cause a short circuit. Do not use a steam cleaner to clean the appliance.
- ▶ Scratches on the door glass can cause the glass to break. Do not use abrasive cleaners, hard sponges, brushes or sharp metal tools to clean the door glass.
- ▶ The side runners can be removed (see “Cleaning and care” – “Removing the side runners with FlexiClip runners”). Refit the side runners correctly.
- ▶ The catalytic enamelled back panel can be removed for cleaning purposes (see “Cleaning and care – Removing the back panel”). Ensure that the back panel is replaced correctly and do not use the combination steam oven without it fitted.
- ▶ In warm, moist environments, there is a higher probability of pest infestations (such as cockroaches). Ensure the combination steam oven and the area surrounding it are always kept clean. Damage caused by pests is not covered by the warranty.

Accessories

- ▶ Only use original Miele accessories. If other parts are used, warranty, performance and product liability claims will be invalidated.
- ▶ Miele will guarantee to supply functional spare parts for a minimum of 10 years and up to 15 years following the discontinuation of your combination steam oven.
- ▶ The Miele gourmet oven dish HUB 5000/HUB 5001 (if available) must not be inserted into shelf level 1. This will damage the floor of the oven. The lack of clearance will create an accumulation of heat which can cause the enamel to crack or flake off. Never place a Miele oven dish on the upper support of shelf level 1 either as it will not be secured by the non-tip safety notches. As a general rule, use shelf level 2.

Caring for the environment

Disposing of the packaging material

The packaging material is used for handling and protects the appliance from transport damage. The packaging material used is selected from materials which are environmentally friendly for disposal and can generally be recycled.

Recycling the packaging material reduces the use of raw materials. Use material-specific collection points for valuable materials and take advantage of return options. Your Miele dealer will take the packaging material away.

Disposing of your old appliance

Electrical and electronic appliances contain many valuable materials. They also contain certain materials, compounds and components which were essential for their correct functioning and safety. These could be hazardous to human health and to the environment if disposed of with household waste or if handled incorrectly. Please do not, therefore, dispose of your old appliance with household waste.



Instead, please make use of officially designated collection and disposal points to dispose of and recycle electrical and electronic appliances in your local community, with your dealer or with Miele, free of charge. By law, you are solely responsible for deleting any personal data from the old appliance prior to disposal. You are legally obliged to remove any old batteries which are not securely enclosed by the appliance and to remove any lamps without destroying them, where this is possible. These must be taken to a suitable collection point where they can be handed in free of charge. Please ensure that your old appliance poses no risk to children while being stored for disposal.



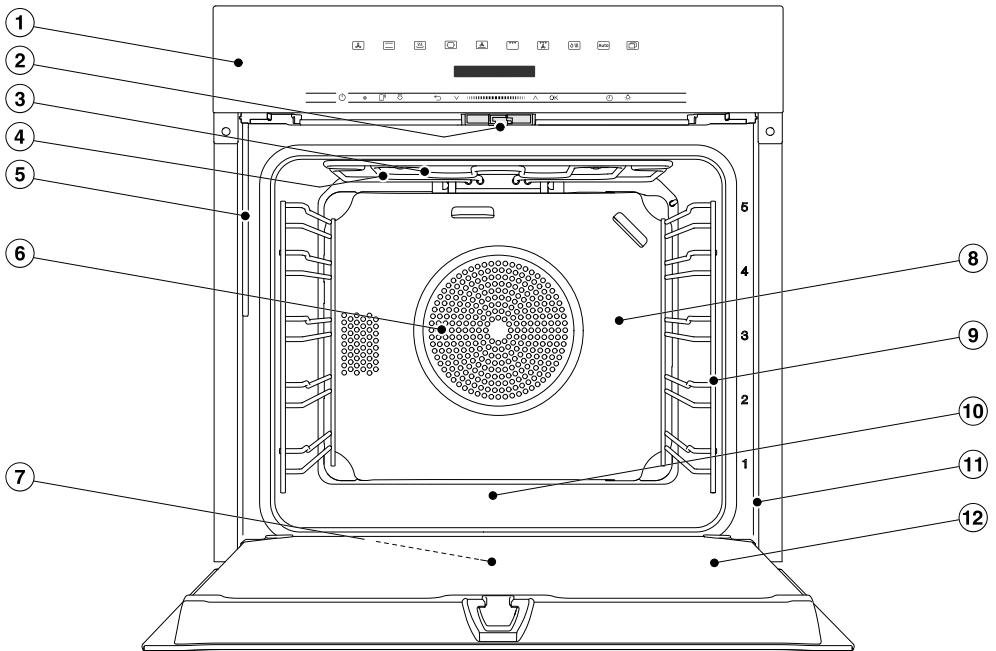



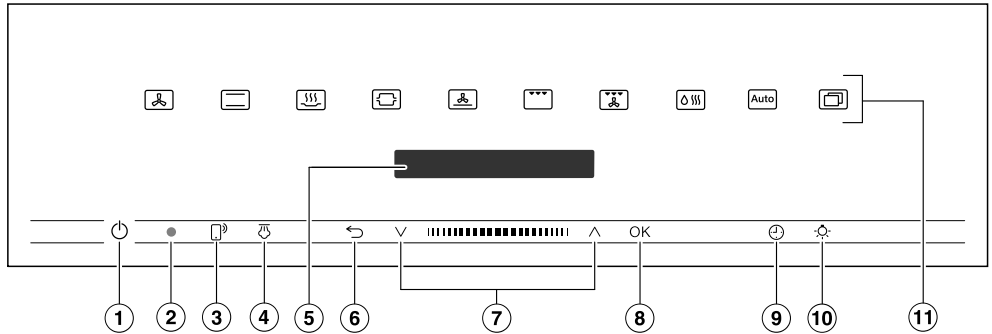

Combination steam oven



- ① Control elements
- ② Door lock
- ③ Top heat/grill element
- ④ Steam inlet opening
- ⑤ Water intake pipe for the steam injection system
- ⑥ Air inlet for the fan with ring heating element behind it
- ⑦ Drip channel
- ⑧ Catalytic enamelled back panel
- ⑨ Side runners with 5 shelf levels
- ⑩ Oven floor with bottom heat element underneath it
- ⑪ Front frame with data plate
- ⑫ Door

Controls



- ① Recessed  On/Off sensor control
For switching the combination steam oven on and off
- ② Optical interface
(For Miele Service only)
- ③  sensor control
For controlling the combination steam oven via your mobile device
- ④  sensor control
For injecting the bursts of steam in the Moisture plus  operating mode
- ⑤ Display
For displaying the time of day and information on operation
- ⑥  sensor control
For going back a step and for changing menu options during a cooking programme
- ⑦ Navigation area with  and  arrow buttons
For scrolling through lists and for changing values
- ⑧ *OK* sensor control
For selecting functions and saving settings
- ⑨  sensor control
For setting a minute minder, the cooking duration or the start or end time for the cooking programme
- ⑩  sensor control
For switching the oven interior lighting on and off
- ⑪ Sensor controls
For selecting functions, automatic programmes and settings

On/Off sensor control

The  On/Off sensor control is recessed and responds to touch.

Use this sensor control to switch the combination steam oven on and off.

Display

The display is used for showing the time of day or information about operating modes, temperatures, cooking durations, automatic programmes and settings.

After switching the combination steam oven on with the  On/Off sensor control, Select function will appear in the main menu.

Sensor controls

The sensor controls react to touch.

Every touch of a sensor is confirmed with an audible keypad tone. You can turn this keypad tone off using Further  | Settings | Volume | Keypad tone.







If you want the sensor controls to respond even when the combination steam oven is switched off, select the Display | QuickTouch | On setting.



Sensor controls above the display

For information on the functions and operating modes, see “Main and sub-menus”, “Settings”, “Automatic programmes” and “Further applications”.

Controls





Sensor controls under the display

Sensor control	Function
	<p>If you want to control the combination steam oven from your mobile device, you must have the Miele@home system, switch on the Remote control setting and touch this sensor control. The sensor control then lights up and the MobileStart function is available.</p> <p>As long as this sensor control is lit, you can control the combination steam oven via your mobile device (see “Settings – Miele@home”).</p>
	<p>After selecting manual steam injection for the Moisture plus  function, you can use this sensor control to inject steam.</p> <p>This sensor control lights up orange as soon as steam injection becomes possible.</p> <p> appears in the display while steam injection is in progress.</p>
	<p>Depending on which menu you are in, this sensor control will take you back a level or back to the main menu.</p> <p>If a cooking programme is in progress at the same time, use this sensor control to cancel the programme.</p>
	<p>In the navigation area, use the arrow buttons or the area between them to scroll up or down in the selection lists. The display shows the menu option that you want to select.</p> <p>You can change the values and settings using the arrow buttons or the area between them.</p>

Sensor control	Function
	As soon as you reach a confirmable value, message or setting, the <i>OK</i> sensor control will light up orange. By selecting this sensor control you can access functions such as the minute minder, save changes to values or settings or confirm instructions.
	If no cooking programme is in progress, you can use this sensor control to set a minute minder (e.g. when boiling eggs) at any point. If a cooking programme is in progress at the same time, you can set a minute minder, the cooking duration and a start or end time for the programme.
	Select this sensor control to switch the oven interior lighting on and off. Depending on the setting selected, the oven interior lighting switches off after 15 seconds or remains constantly switched on or off.

Symbols

The following symbols may appear in the display:

Symbol	Meaning
	This symbol indicates that there is additional information and advice about using the appliance. Press the <i>OK</i> sensor control to confirm the information.
	Minute minder
	A tick indicates the option which is currently selected.
	Some settings, e.g. display brightness and buzzer volume are selected using a bar chart.
	The system lock prevents the combination steam oven being switched on by mistake (see “Settings – Safety”).

Using the appliance

Use the \wedge and \vee arrow buttons or the **|||||** area between them in the navigation area to use the combination steam oven.

As soon as you reach a confirmable value, message or setting, the *OK* sensor control will light up orange.

Selecting a menu option

- Touch the \wedge or \vee arrow buttons or swipe to the right or left in the **|||||** area until you reach the desired menu option.

Tip: If you press and hold an arrow button, the list continues scrolling automatically until you release the arrow button.

- Confirm your selection with *OK*.

Changing a setting in a list

A \checkmark tick will appear beside the current setting.

- Touch the \wedge or \vee arrow buttons or swipe to the right or left in the **|||||** area until you reach the desired value or setting.
- Confirm with *OK*.

The setting is now saved. This will take you back to the previous menu.

Changing the setting with a segment bar

Some settings are represented by a bar **■■■■■□□□** with seven segments. If all of the segments are illuminated, the maximum value is selected.

If none of the segments are illuminated, or only one of them is, the minimum value is selected or the setting is switched off altogether (e.g. volume).

- Touch the \wedge or \vee arrow buttons or swipe to the right or left in the **|||||** area until you reach the desired setting.
- Confirm your selection with *OK*.

The setting is now saved. This will take you back to the previous menu.

Selecting a function or operating mode

The sensor controls for the functions and operating modes (e.g. Further ) are located above the display (see “Controls” and “Settings”).

- Touch the sensor control for the desired function.

The sensor control on the fascia panel lights up orange.

- For functions and operating modes: set values such as the temperature.
- Under Further : scroll through the lists until you reach the desired menu option.
- Confirm with *OK*.

Changing the function

You can change to another function during a cooking programme.

The sensor control for the previously selected function lights up orange.

- Touch the sensor control of the new function or operating mode.

The new function appears in the display with its corresponding recommended values.

The sensor control for the new function lights up orange.

Under Further , scroll through the lists until you reach the desired menu option.

Entering numbers

Numbers that can be changed are highlighted.

- Touch the \wedge or \vee arrow buttons or swipe to the right or left in the **||||** area until the desired number is highlighted.

Tip: If you press and hold an arrow button, the numbers continue scrolling automatically until you release the arrow button.

- Confirm with *OK*.

The changed number is now saved. This will take you back to the previous menu.

Activating MobileStart

- Select the  sensor control to activate MobileStart.



The  sensor control lights up. You can operate your combination steam oven remotely with the Miele app.

Directly operating the combination steam oven takes priority over operating it via the remote control function on the app.

You can use MobileStart as long as the  sensor control is lit up.

Using the appliance

Drawing in water

In the Steam cooking  and Moisture plus  operating modes, you will be prompted to add water for the cooking process.

- Fill a suitable container with the required amount of fresh water.

Distilled or carbonated water or other liquids could damage the combination steam oven.

Only use cold, fresh drinking water (below 20 °C).

- Open the door.
- Pull the water intake pipe forwards (located below the control panel on the left).

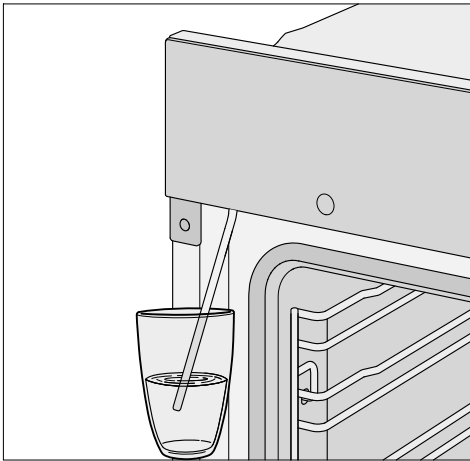

- Immerse the end of the water intake pipe in the container with fresh water.
- Confirm with *OK*.

The water intake process will begin.

The amount of water actually drawn up into the oven may be less than the amount specified as required, leaving a small amount in the container.

You can interrupt and resume the intake process at any time by selecting *OK*.

- Remove the water container after the water intake process and close the door.

The sound of the pump running can be heard again briefly. Residual water in the water intake pipe is being drawn into the oven.

The cooking process begins. The water is injected as bursts of steam into the oven compartment during the cooking process. The steam openings are located at the back left corner of the ceiling of the oven.

 Risk of injury caused by hot steam.

When using a cooking process involving steam, a lot of hot steam can escape if the door is opened. The steam can cause burns.

Step back and wait until the hot steam has dissipated.

A list of the models described in these operating and installation instructions can be found on the back page of this booklet.

Data plate

The data plate is located on the front frame, visible when the door is open.

The data plate states the model number, the serial number as well as connection data (voltage, frequency and maximum rated load).

Please have this information to hand, should you need to contact Miele regarding any questions or problems.

Scope of delivery

- Operating and installation instructions for using the combination steam oven
- A cookbook with recipes for the automatic programmes and other functions
- Screws for securing your combination steam oven in the housing unit
- Descaling tablets and a plastic tube with suction cup for descaling the steam injection system
- Various accessories

Accessories supplied and available to order

Features will vary depending on model. Side runners, cooking container, universal tray, and baking and roasting rack (or “rack” for short) are supplied as standard with the combination steam oven.

Depending on the model, your combination steam oven may also come supplied with some of the accessories listed here.

All the accessories listed as well as the cleaning and care products are designed for Miele combination steam ovens.

These are available to order via the Miele Webshop, the Miele Customer Service Department or from your Miele dealer.

When ordering, please quote the model identifier of your combination steam oven and the reference number of the accessories required.

Side runners

There are runners on the left and right of the oven compartment with shelves  for inserting accessories.

The numbers for the shelf levels are marked on the front frame.

Each level consists of 2 rails, one above the other.

The accessories (e.g. the rack) are pushed into the oven between the two rails.

You can remove the side runners (see “Cleaning and care” – “Removing the side runners with FlexiClip runners”).

Baking tray, universal tray and rack with non-tip notches

Baking tray HBB 71:

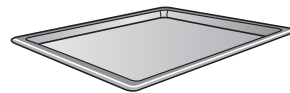

Universal tray HUBB 71:

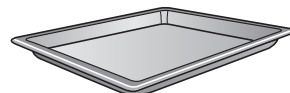

Rack HBBR 71:



These accessories are inserted into the oven between the two rails of a shelf in the side runner.

Features

Always place the rack with the loading surface in the lower position.

These accessories have non-tip safety notches fitted in the middle of their short sides. The non-tip safety notches prevent the trays from being pulled out completely from the side runners when you only wish to pull accessories out partially.



If you are using the universal tray with the rack on top, insert the tray between the rails of a shelf of the side runners and the rack will automatically slide in above them.

In the Steam cooking  operating mode, **always** place the universal tray on shelf level 1 to collect the liquid.

FlexiClip runners HFC 70-C

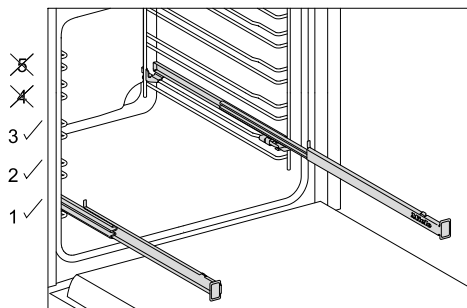

FlexiClip runners can only be fitted on levels 1, 2 and 3.

The FlexiClip runners can be drawn right out of the oven individually to give a good overview of cooking in progress.

Push the FlexiClip runners right into the oven compartment before placing accessories on them.

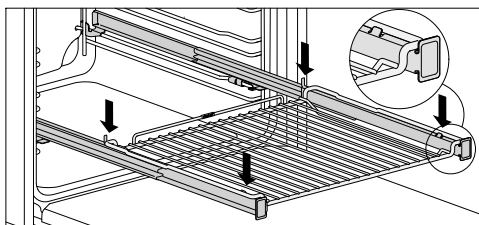
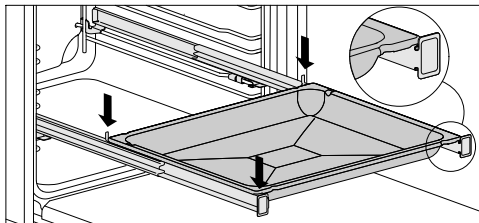

To prevent the risk of accessories sliding off the runners:

- Make sure that they are sitting securely on their runners in between the stoppers at either end of each runner.
- Always place the rack with the loading surface in the lower position on the FlexiClip runners.

The FlexiClip runners can support a maximum load of 15 kg.

Because the FlexiClip runners sit on the top rail of the side runners, the gap between the level the FlexiClip runners are on and the one above is smaller than if, for instance, racks were fitted on each level. Cooking results will be affected if the gap is too small.

You can use more than one baking tray, universal tray or rack at a time.

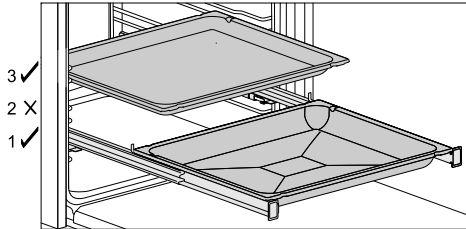

- Place the baking tray, universal tray or rack on the FlexiClip runners.
- Leave at least one shelf level free between the FlexiClip runner and any baking tray, universal tray or rack above it.

You can use the universal tray together with the rack on the FlexiClip runners.

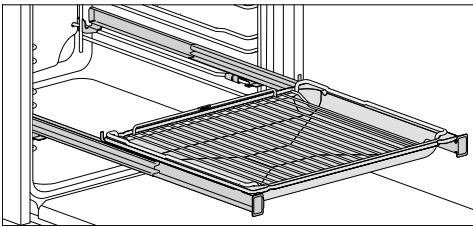

- Place the universal tray together with the rack on the FlexiClip runners. The rack will automatically slide between the rails of the shelf level above the FlexiClip runners.
- Leave at least one shelf level free between the FlexiClip runner and any baking tray, universal tray or rack above it.

Fitting the FlexiClip runners

 Risk of injury caused by hot surfaces.

The oven gets hot during operation. You could burn yourself on the heating elements, oven compartment or accessories.

Allow the heating elements, oven compartment and the accessories to cool before fitting or removing the FlexiClip runners.

Preferably fit the FlexiClip runners onto level 1. You can then use them for food which should be cooked on level 2.

One level of the side runners consists of two rails. The FlexiClip runners are fitted on the upper rail of the two rails that make up a shelf level.

The FlexiClip runner with the Miele logo is fitted on the right.

When fitting or removing the FlexiClip runners, **do not** extend them.

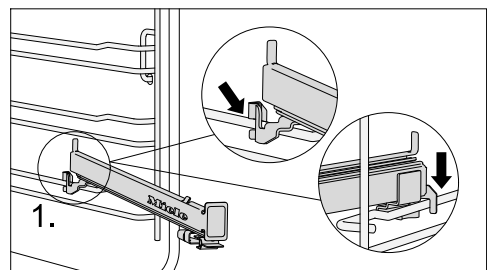

- Hook the FlexiClip runner onto the front of the top rail of a side runner (1.).

Features

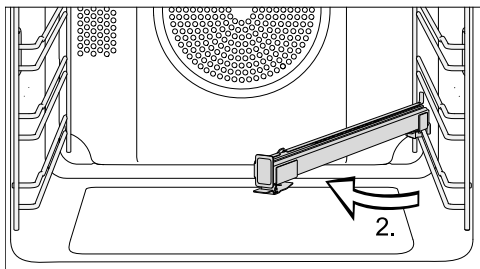

- Then hold the FlexiClip runner at an angle towards the middle of the oven compartment (2.).

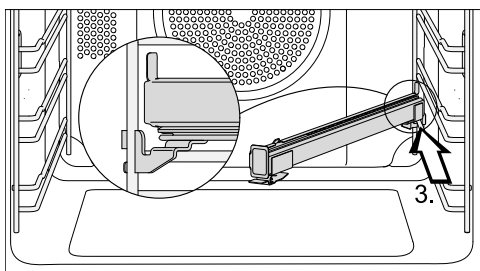

- Slide the FlexiClip runner along the top rail as far as it will go (3.).

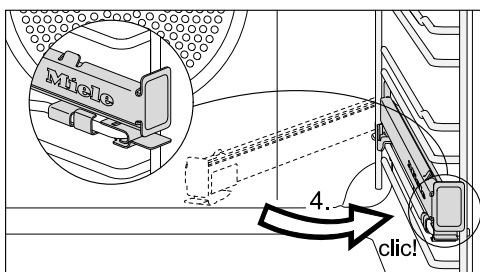

- Then swing the FlexiClip runner back to the side of the oven compartment and secure it to the top rail with an audible click (4.).

If the FlexiClip runners are difficult to pull out after fitting, you may need to pull firmly on them once to release them.

Removing the FlexiClip runners

⚠ Risk of injury caused by hot surfaces.

The oven gets hot during operation. You could burn yourself on the heating elements, oven compartment or accessories.

Allow the heating elements, oven compartment and the accessories to cool before fitting or removing the FlexiClip runners.

- Push the FlexiClip runner in all the way.

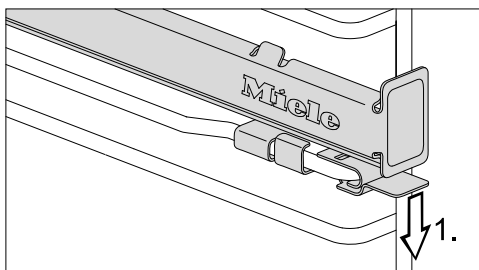

- Push down on the tab at the front of the FlexiClip runner (1.).

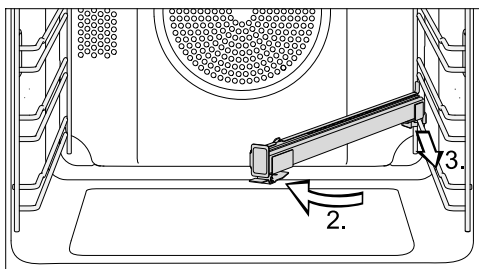

- Swing the FlexiClip runner towards the middle of the oven compartment (2.), then pull it forwards along the top rail (3.).
- Lift the FlexiClip runner off the rail and take it out of the oven.

Gourmet baking and AirFry tray, perforated HBBL 71

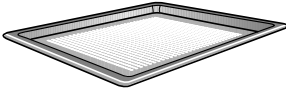

The fine perforations of the Gourmet baking and AirFry tray optimise cooking processes:

- Browning on the underside of baked goods made from fresh yeast and quark doughs as well as bread and rolls is improved.

Roll out the dough on a level surface first and then place it on the Gourmet baking and AirFry tray.

- French fries, croquettes or similar items can be fried in a hot air flow without fat (AirFrying).
- During dehydrating/drying, the air circulation around the food for drying is optimised.

The enamelled surface has been treated with PerfectClean.

The **round baking and AirFry tin, perforated HBFP 27-1** can be used for the same purposes.

The perforated Gourmet baking and AirFry tray and the perforated round baking and AirFry tin are not suitable for use with the Steam cooking  operating mode.

Only use the perforated trays and tins for baking.

Round baking trays



The **solid round baking tray HBF 27-1** is suitable for cooking pizzas, flat cakes made with yeast or creamed mixtures, sweet and savoury tarts, baked desserts, flat bread, and can also be used for frozen cakes and pizzas.

The **perforated round baking and AirFry tin HBFP 27-1** can be used for the same purposes as the **Gourmet baking and AirFry tray, perforated HBBL 71**.

The enamelled surface of both items of bakeware has been treated with PerfectClean.

- Insert the rack and place the round baking tray on the rack.

Baking stone HBS 70



The baking stone is ideal for items which need a well baked base such as pizza, quiche, bread, bread rolls and savoury snacks.

The baking stone is made from heat-retaining fireclay and is glazed. A paddle made of untreated wood is supplied with the baking stone for placing food on it and taking it off.

- Slide the rack in and place the baking stone on it.

Grilling and roasting insert HGBB 71

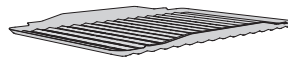

The grilling and roasting insert fits in the universal tray.

When grilling, roasting or AirFrying, the tray will collect meat juices and stop them from burning so that they can be used for making gravy and sauces.

The enamelled surface has been treated with PerfectClean.

Features

HUB gourmet oven dishes HBD gourmet oven dish lids

Unlike other oven dishes, Miele gourmet oven dishes can be placed in the oven directly on the shelf runners. They have non-tip safety notches like the rack to prevent them from being pulled out too far.

The surface of the oven dish has a non-stick coating.

Gourmet oven dishes are available in different depths. The width and the height are the same.

Suitable lids are available separately. Please quote the model number when ordering.

Depth: 22 cm

HUB 5000-M
HUB 5001-M*

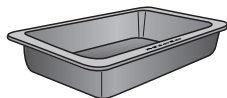

HBD 60-22

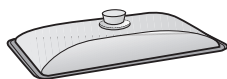

Depth: 35 cm

HUB 5001-XL*

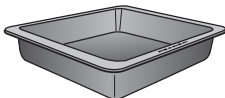

HBD 60-35

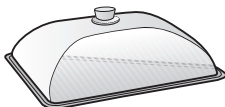

* Suitable for use on induction hobs

Steam cooking containers

Stainless steel cookware is provided with the combination steam oven. Other containers, in a variety of sizes, both perforated and solid, are available as optional extras.

Use perforated cooking containers for steam cooking if possible. The steam can reach the food from all sides and the food is cooked evenly.

Place the cooking container containing the food on shelf level 3.

Always place the universal tray on shelf level 1 to collect the liquid.

DGG 20

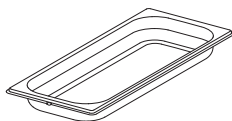

1 solid cooking container
Gross capacity 2.4 l / Usable capacity 1.8 l
450 x 190 x 40 mm (W x D x H)

DGGL 20

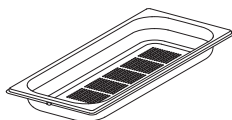

1 perforated cooking container
Gross capacity 2.4 litres / Usable capacity 1.8 litres
450 x 190 x 40 mm (W x D x H)

DGGL 12



1 perforated cooking container
Gross capacity 5.4 litres / Usable capacity 3.3 litres
450 x 390 x 40 mm (W x D x H)

Catalytic enamelled accessories

Back panel

This should be replaced if the catalytic enamel has become ineffective due to incorrect use or very heavy soiling.

When ordering, please quote the model identifier of your combination steam oven.

Handle HEG

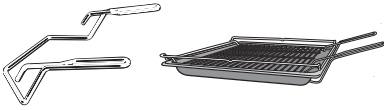

The handle makes it easier to take the universal tray, baking tray and rack out of the oven.

Accessories for cleaning and care

- Descaling tablets, plastic tube with suction cup for descaling the combination steam oven
- Miele all-purpose microfibre cloth
- Miele oven cleaner

Safety features

- **System lock** 
(see “Settings – Safety”)
- **Sensor lock**
(see “Settings – Safety”)
- **Cooling fan**
(see “Settings – Cooling fan run-on”)
- **Safety switch-off**
This safety switch-off is activated automatically if the combination steam oven has been operating for an unusually long period of time. The period of time will depend on the particular operating mode being used.
- **Ventilated door**
The oven door is made of glass panes that have a heat-reflective coating on part of their surface. When the oven is operating, air is passed through the door to keep the outer pane cool. The door can be removed and disassembled for cleaning purposes (see “Cleaning and care”).

PerfectClean treated surfaces

PerfectClean surfaces have very good non-stick properties and are exceptionally easy to clean.

Food can be easily removed from these surfaces. Soiling from baking and roasting can be easily removed from these surfaces.

Food can be sliced or cut up on PerfectClean surfaces.

However, do not use ceramic knives as these will scratch the PerfectClean surface.

Surfaces treated with PerfectClean enamel can be cleaned as you would clean glass.

Read the instructions in “Cleaning and care” so that the benefits of the non-stick properties and easy cleaning are retained.

PerfectClean treated surfaces:

- Oven compartment
- Rack
- Universal tray
- Baking tray
- Grilling and roasting insert
- Gourmet baking and AirFry tray, perforated
- Round baking and AirFry tin, perforated
- Round baking tray

Before using for the first time

Miele@home

Your combination steam oven is equipped with an integrated WiFi module.

To use this feature, you will need:

- A WiFi network
- The Miele app
- A Miele user account. You can create a user account via the Miele app

The Miele app will guide you as you connect your combination steam oven to your home WiFi network.

Once your combination steam oven is connected to your WiFi network, you can use the app for a number of actions, including the following:

- Call up information on the operating status of your combination steam oven
- Retrieve information on oven cooking processes that are in progress
- Stop cooking processes that are in progress

Connecting your combination steam oven to your WiFi network will increase energy consumption, even when the oven is switched off.

Make sure that the signal of your WiFi network is sufficiently strong in the place where your combination steam oven is installed.

Availability of the WiFi connection

The WiFi connection shares a frequency range with other appliances (including microwave ovens and remote control toys). This can give rise to sporadic or even complete connection failures. Therefore, the availability of featured functions cannot be guaranteed.

Miele@home availability

The ability to use the Miele app depends on the availability of the Miele@home service in your country.

The Miele@home service is not available in every country.

For information about availability, please visit www.miele.com.

Miele App

The Miele App is available to download free of charge from the Apple App Store® or from the Google Play Store™.



Before using for the first time

Basic settings

The following settings must be made before starting up for the first time. You can change these settings again at a later time (see “Settings”).

 Risk of injury caused by hot surfaces.

The combination steam oven gets hot during operation.

For safety reasons, the combination steam oven may only be used when it has been fully installed.

The combination steam oven will switch on automatically when it is connected to the electricity supply.

Setting the language

- Select the desired language.
- Confirm with *OK*.

If you have selected the wrong language by mistake, proceed as described in “Settings –  Language”.

Setting the location

- Select the required location.
- Confirm with *OK*.

Setting up Miele@home

Set up “Miele@home” will appear in the display.

- To set up Miele@home now, confirm by touching *OK*.
- To set it up at a later date, select *Skip* and confirm with *OK*.
See “Settings – Miele@home” for information on setting up at a later date.
- To set up Miele@home now, select the desired connection method.

You will then be guided by the display and the Miele app.

Setting the time

- Set the time of day in hours and minutes.
- Confirm with *OK*.

Setting the water hardness level

Contact your local water supplier to find out the hardness of the water in your area.

More information can be found under “Settings – Water hardness”.

- Select your local water hardness on the appliance.
- Confirm with *OK*.

Completing the commissioning process

- Follow any further instructions in the display.

The oven is now ready for use.

Before using for the first time

Heating up the combination steam oven for the first time and rinsing the steam injection system

When the combination steam oven is heated up for the first time it may give off an unpleasant odour. This can be eliminated by heating the empty combination steam oven for at least an hour. It is a good idea to rinse out the steam injection system at the same time.

It is important to ensure that the kitchen is well ventilated during the heating process. Prevent the odour from escaping into other rooms.

- Remove any protective wrapping and stickers from the combination steam oven and accessories.
- Before heating the oven compartment up, wipe the interior with a damp cloth to remove any dust or bits of packaging.
- Fit the FlexiClip runners in the side runners and insert all trays and the rack.
- Use the  On/Off sensor control to switch the combination steam oven on.

Select function will appear.

- Select Moisture plus .

The recommended temperature will appear (160 °C).

The oven heating, oven interior lighting and cooling fan will switch on.

- Set the maximum possible temperature (250 °C).
- Confirm with *OK*.

- Select Automatic burst of steam.

The prompt to draw in water then appears.

- Fill a suitable container with the required amount of fresh water and follow the instructions on the display (see “Operation – Drawing in water”).

Heat the combination steam oven for at least an hour.

- After at least an hour, switch the combination steam oven off with the  On/Off sensor control.

Cleaning the oven compartment after heating it up for the first time

 Risk of burns due to hot surfaces.





The combination steam oven gets hot during operation. You could burn yourself on the heater elements, oven compartment or accessories.

Allow the heater elements, oven compartment and accessories to cool before manual cleaning.

- Take all accessories out of the oven compartment and clean it by hand (see “Cleaning and care”).
- Clean the oven compartment with a clean sponge and a solution of hot water and washing-up liquid or a clean, damp microfibre cloth.
- Dry all surfaces with a soft cloth.

Leave the oven door open until the oven compartment is completely dry.

Settings overview

Menu option	Available settings
Language 	... deutsch english ... Location
Time	Display On* Off Night dimming Clock format 12 h 24 h* Set
Lighting	On "On" for 15 seconds* Off
Display	Brightness  QuickTouch On Off*
Volume	Buzzer tones Melodies*  Solo tone  Keypad tone  Welcome melody On* Off
Units	Temperature °C* °F
Booster	On* Off
Rapid cooling	On* Off
Keeping warm	On Off*

* Factory default setting



Settings

Menu option	Available settings
Recommended temps.	
Cooling fan run-on	Temperature controlled* Time controlled
Water hardness	1 °dH ... 15 °dH* ... 70 °dH
Altitude	0 - 250 m* ... 751 - 1000 m ... 1751 - 2000 m
Safety	Sensor lock On Off* System lock  On Off*
Miele@home	Activate Deactivate Connection status Set up again Reset Set up
Remote control	On* Off
RemoteUpdate	On* Off
Software version	
Showroom programme	Demo mode On Off*
Factory default	Appliance settings Recommended temps.

* Factory default setting

Opening the “Settings” menu

In the Further  | Settings menu, you can personalise your combination steam oven by adapting the factory default settings to suit your requirements.

- Select Further .
- Select Settings .
- Select the desired setting.



You can check settings or change them.

Settings cannot be changed while a cooking process is in progress.

Language

You can set your language and location.

After selecting and confirming your choice, the language you have selected will appear in the display.

Tip: If you have selected the wrong language by mistake, select the  sensor control. Follow the  symbol to get back to the Language  sub-menu.

Time

Display

Select how you want the time of day to show in the display when the combination steam oven is switched off:

- On
The time is always visible on the display.
If you also select the Display | QuickTouch | On setting, all sensor controls respond to touch straight away.
If you also select the Display | QuickTouch | Off setting, the combination steam oven has to be switched on before it can be used.

- Off
To save energy, the display does not light up. The combination steam oven has to be switched on before it can be used.
- Night dimming
To save energy, the time only shows in the display between 5:00 a.m. and 11:00 p.m. The display remains dark at all other times.

Clock format

The time of day can be displayed in the 24 or 12-hour format (24 h or 12 h).



Set

Set the hours and the minutes.

If there is a power cut, the current time of day will reappear once power has been restored. The time of day is saved for approx. 150 hours.

If the combination steam oven has been connected to a WiFi network and signed into the Miele app, the time will be synchronised based on the location setting in the Miele app.

Lighting

- On
The oven interior lighting is switched on during the entire cooking period.
- “On” for 15 seconds
The oven interior lighting switches off 15 seconds after a cooking programme has begun. Press the  sensor control to switch the oven interior lighting on again for 15 seconds.
- Off
The oven interior lighting is switched off. Press the  sensor control to switch on the oven interior lighting for 15 seconds.

Settings

Display

Brightness

The display brightness is represented by a bar with seven segments.

-  Maximum brightness

-  Minimum brightness

QuickTouch

Select how the sensor controls should respond when the combination steam oven is switched off:

- On
If you have also selected the Time | Display | On or Night dimming setting, the sensor controls will also respond when the combination steam oven is switched off.
- Off
Independently of the Time | Display setting, the sensor controls only respond when the combination steam oven is switched on, as well as for a certain amount of time after switching it off.

Volume

Buzzer tones

If buzzers are switched on, a buzzer will sound when the set temperature is reached and at the end of a set time.

Melodies

At the end of a process, a melody will sound several times in intervals.

The volume of the melody is represented by a bar with seven segments.

-  Maximum volume

-  Melody is switched off

Solo tone

At the end of a process, a continuous tone will sound for a period of time.

The pitch of this continuous tone is represented by a segment bar.

-  Maximum pitch

-  Minimum pitch

Keypad tone

The volume of the tone that sounds each time you touch a sensor control is represented by a bar with seven segments.

-  Maximum volume

-  Tone is switched off

Welcome melody

The melody that sounds when you touch the  On/Off sensor control can be switched on or off.

Units

Temperature

You can set the temperature in degrees Celsius (°C) or degrees Fahrenheit (°F).

Booster

The **Booster** function is used to quickly pre-heat the oven compartment.

- On

The **Booster** function is automatically switched on during the heating-up phase of a cooking programme. The top heat/grill element, ring heating element and hot air fan pre-heat the oven compartment to the set temperature at the same time.

- Off

The **Booster** function is switched off during the heating-up phase of a cooking programme. Only the heating elements for the selected oven function are used to pre-heat the oven compartment.

Rapid cooling

Using the **Rapid cooling** function you can quickly cool down food and the oven compartment once the cooking process is brought to an end.

This function is useful if, for example, you then immediately want to start an automatic programme for which the oven compartment needs to be cold.

Using the **Keeping warm** function you can keep food warm after cooking without inadvertently cooking it further.

- On

The **Rapid cooling** function is switched on. Once the cooking process is brought to an end, the door opens a little automatically. The cooling fan cools the food and the oven compartment quickly.

- Off

The **Rapid cooling** function is switched off. Once the cooking process is brought to an end, the door remains closed. The cooling fan cools the food and the oven compartment.

Settings

Keeping warm

Using the Keeping warm function you can keep food warm after cooking without inadvertently cooking it further. The food is kept warm at a pre-set temperature (Settings | Recommended temps. | Keeping warm).

It is only possible to use the Keeping warm function in combination with the Rapid cooling function.

- On
The Keeping warm function is switched on. Once the cooking process is brought to an end, the door opens a little automatically. The cooling fan cools the food and the oven compartment quickly to the pre-set temperature. Once this temperature is reached, the door is closed again automatically in order to keep the food warm.
- Off
The Keeping warm function is switched off. Once the cooking process is brought to an end, the door remains closed. The cooling fan cools the food and the oven compartment.

Recommended temps.

If you often cook with different temperatures, it makes sense to change the recommended temperatures.

After selecting this menu option, the list of operating modes will appear in the display together with their recommended temperatures.

- Select the relevant operating mode.
- Change the recommended temperatures.
- Confirm with *OK*.

You can also change the recommended temperature for the Keeping warm function.

Cooling fan run-on

The cooling fan will continue to run for a while after a cooking process has finished to prevent any humidity building up in the oven compartment, on the control panel or on the oven housing unit.

- Temperature controlled
The cooling fan switches off when the temperature in the oven drops below 70 °C.
- Time controlled
The cooling fan switches off after a period of about 25 minutes.

Condensate can damage the oven housing unit and the worktop and lead to corrosion in the combination steam oven.

If you have set the cooling fan to Time controlled and leave food in the oven compartment to keep warm, moisture levels in the oven will increase, leading to condensation forming on the control panel and furniture front, and drops of moisture collecting under the worktop.

Do not leave food in the oven compartment to keep it warm if you have selected Time controlled.

Water hardness

The combination steam oven must be adjusted to the local water hardness level to ensure that it works correctly and to ensure that descaling is carried out at the correct interval. The harder the water is, the more frequently the combination steam oven needs to be descaled. Contact your local water supplier to find out the water hardness in your area.

If you are using an on-site water softener, match the setting on the combination steam oven to the value set on the water softener.

If you are using an on-site system to fully demineralise the water (e.g. a reverse osmosis system), the system must be set so the conductivity of the treated water is at least 100 $\mu\text{S}/\text{cm}$. In the case of most water qualities, this can be achieved by setting a water hardness of at least 3 $^{\circ}\text{dH}$ rather than fully demineralising the water. The conductivity is required for the fill level detection in the steam generator. Match the setting on the combination steam oven to the value set on the full demineralisation system.

If you are using bottled water, it must comply with the relevant national regulations for drinking water quality. Do not use mineral water or carbonated water. Adjust the setting on the combination steam oven depending on the calcium content. The calcium content is specified on the label of the bottle in $\text{mg}/\text{l Ca}^{2+}$ or ppm ($\text{mg}/\text{l CaCO}_3$).

Water hardness			Calcium content $\text{mg}/\text{l Ca}^{2+}$	Calcium carbonate content ppm ($\text{mg}/\text{l CaCO}_3$)	Setting on combination steam oven
$^{\circ}\text{dH}$	$^{\circ}\text{fH}$	mmol/l			
1	1.8	0.18	7	18	1
2	3.6	0.36	14	36	2
3	5.4	0.54	21	54	3
4	7.1	0.72	29	71	4
5	8.9	0.90	36	89	5
6	10.7	1.07	43	107	6
7	12.5	1.25	50	125	7
8	14.3	1.43	57	143	8
9	16.0	1.61	64	161	9
10	17.9	1.79	71	179	10
11	19.6	1.97	79	196	11
12	21.4	2.15	86	214	12
13	23.2	2.33	93	232	13
14	25.0	2.51	100	250	14

Settings

Water hardness			Calcium content mg/l Ca ²⁺	Calcium carbonate content ppm (mg/l CaCO ₃)	Setting on combination steam oven
°dH	°fH	mmol/l			
15	26.8	2.69	107	268	15
16	28.6	2.86	114	286	16
17	30.4	3.04	121	304	17
18	32.1	3.22	129	321	18
19	33.9	3.40	136	339	19
20	35.7	3.58	143	357	20
21	37.5	3.76	150	375	21
22	39.3	3.94	157	393	22
23	41.1	4.12	164	411	23
24	42.9	4.30	171	429	24
25	44.6	4.47	179	446	25
26	46.4	4.65	186	464	26
27	48.2	4.83	193	482	27
28	50.0	5.01	200	500	28
29	51.8	5.19	207	518	29
30	53.6	5.37	214	536	30
31	55.4	5.55	221	554	31
32	57.1	5.73	228	571	32
33	58.9	5.91	236	589	33
34	60.7	6.09	243	607	34
35	62.5	6.27	250	625	35
36	64.3	6.44	257	643	36
37–45	66–80	6.62–8.06	264–321	661–804	37–45
46–60	82–107	8.23–10.74	328–428	821–1071	46–60
61–70	109–125	10.92–12.53	436–500	1089–1250	61–70

Altitude

The boiling temperature of water varies depending on the altitude of where the appliance is located. This setting enables you to adjust the boiling temperature for the water if you move house. You will need to do this if the new altitude differs from the old one by 300 m or more.

Safety

Sensor lock

The sensor lock prevents the cooking programme being switched off by mistake or settings being changed. Apart from the  On/Off sensor control, the activated sensor lock prevents the sensor controls and fields in the display from working a few seconds after a programme has been started.

- On
The sensor lock is activated. Touch the *OK* sensor control for at least 6 seconds to deactivate the sensor lock for a short period of time.
- Off
The sensor lock is deactivated. All sensor controls react to touch as normal.

System lock

The system lock prevents the combination steam oven from being switched on by mistake.

The minute minder and the MobileStart function can still be used when the system lock is active.

The system lock will remain activated even after a mains outage.

- On
The system lock has been activated. Before you can use the combination steam oven, touch the *OK* sensor control for at least 6 seconds.
- Off
The system lock is deactivated. You can use the combination steam oven as normal.

Miele@home

The combination steam oven is a Miele@home-compatible appliance. Your combination steam oven is fitted ex-works with a WiFi communication module and is suitable for wireless communication.

There are a number of ways of connecting your combination steam oven to your WiFi network. We recommend connecting your combination steam oven to your WiFi network with the help of the Miele app or via WPS.

- Activate
This setting is only visible if Miele@home is deactivated. The WiFi function is reactivated.
- Deactivate
This setting is only visible if Miele@home is activated. Miele@home remains set up, the WiFi function is switched off.
- Connection status
This setting is only visible if Miele@home is activated. The display shows information such as the WiFi reception quality, network name and IP address.
- Set up again
This setting is only visible if a WiFi network has already been set up.

Settings

Reset the network settings and immediately set up a new network connection.

- Reset

This setting is only visible if a WiFi network has already been set up. The WiFi function is deactivated and the WiFi network connection will be reset to the factory default. You must set up a new WiFi network connection to be able to use Miele@home.

The network settings should be reset whenever a combination steam oven is being disposed of or sold, or if a used combination steam oven is being put into operation. This is the only way to ensure that all personal data has been removed and the previous owner will no longer be able to access the combination steam oven.

- Set up

This setting is only visible if no WiFi network connection has been set up yet. You must set up a new WiFi network connection to be able to use Miele@home.

Remote control

If you have installed the Miele app on your mobile device, have access to the Miele@home system and have activated the remote control function (On), you can use the MobileStart function and, for example, retrieve information about oven cooking processes that are in progress or to end a process that is in progress.

The combination steam oven requires max. 2 W in networked standby.

Activating MobileStart

- Select the  sensor control to activate MobileStart.

The  sensor control lights up. You can operate your combination steam oven remotely with the Miele app.

Directly operating the combination steam oven takes priority over operating it via the remote control function on the app.

You can use MobileStart as long as the  sensor control is lit up.

RemoteUpdate

The RemoteUpdate menu option is only displayed and can only be selected if the requirements for using Miele@home have been met (see “Before using for the first time – Miele@home”).

The RemoteUpdate function is used for updating the software in your combination steam oven. If an update is available for your combination steam oven, it will automatically download it. Updates will not be installed automatically. They must be initiated manually.

If you do not install an update, you can continue to use your combination steam oven as usual. However, Miele recommends installing updates.

Activating/deactivating

The RemoteUpdate function is activated as standard. Available updates will be downloaded automatically but will only be installed if you initiate installation manually.

Deactivate RemoteUpdate if you do not want any updates to be downloaded automatically.

Running a RemoteUpdate

Information about the content and scope of an update is provided in the Miele app.

A message will appear in your combination steam oven display if a software update is available.

You can install the update immediately or postpone this until later. When the combination steam oven is switched on again, you will be reminded about the update.

Deactivate RemoteUpdate if you do not want to install the update.

The update may take several minutes.

Please note the following information about the RemoteUpdate function:

- You will only receive a message when an update is available.
- Once an update has been installed, it cannot be undone.
- Do not switch the combination steam oven off during the update. Otherwise, the update will be aborted and will not be installed.
- Some software updates can only be carried out by the Miele Customer Service Department.

Software version

The software version is intended for the Miele Customer Service Department. You do not need this information for domestic use.

Showroom programme

This function enables the combination steam oven to be demonstrated in showrooms without heating up. This setting is not needed for domestic use.

Demo mode

If you have demo mode activated, Demo mode active. The appliance will not heat up will appear when you switch the combination steam oven on.

- On
Touch the *OK* sensor control for at least 4 seconds to activate demo mode.
- Off
Touch the *OK* sensor control for at least 4 seconds to deactivate demo mode. You can use the combination steam oven as normal.

Factory default

- Appliance settings
Any settings that have been altered will be reset to the factory default settings.
- Recommended temps.
Any recommended temperatures that have been changed will be reset to the factory default settings.

Operating hours

Select Further  | Operating hours to query the total number of operating hours of your combination steam oven.

Min. minder

Using the Min. minder function

The Δ minute minder can be used to time other activities in the kitchen, e.g. boiling eggs.

The minute minder can also be used at the same time as a cooking programme for which the cooking duration start and finish times have been set (e.g. as a reminder to stir the food or add seasoning, etc.).

- The maximum minute minder time that can be set is 59 minutes and 59 seconds.

Tip: When using a function that uses moisture, use the timer to remind you to inject steam manually at the desired time.

Setting the minute minder

If you have selected the Display | QuickTouch | Off setting, you will need to switch the combination steam oven on before setting the minute minder. The minute minder can then be seen counting down in the display when the combination steam oven is switched off.

Example: you want to boil some eggs and set a minute minder duration of 6 minutes and 20 seconds.

- Select the \oplus sensor control.
- Select Min. minder if a cooking process is in progress at the same time.

The prompt Set 00:00 min appears.

- Using the navigation area, set 06:20.
- Confirm with *OK*.

The minute minder duration is now saved.

When the combination steam oven is switched off, the minute minder time counts down in the display and Δ appears instead of the time of day. If you are cooking at the same time **without** a set cooking duration, Δ and the minute minder time will appear as soon as the selected temperature is reached.

If you are cooking at the same time **with** a set cooking duration, the minute minder will count down in the background as the cooking duration appears first in the display.

If you are in a menu, the minute minder counts down in the background.

At the end of the minute minder duration, Δ will flash, the time will start counting up and a buzzer will sound.

- Select the \oplus sensor control.
 - If required, confirm with *OK*.
- The buzzer will stop and the symbols in the display will go out.

Changing the minute minder duration

- Select the \oplus sensor control.
- Select Min. minder if a cooking programme is in progress at the same time.
- Select Change.
- Confirm with *OK*.

The minute minder duration selected appears.

- Change the duration set for the minute minder.
- Confirm with *OK*.











The altered minute minder duration is now saved.

Deleting the minute minder duration

- Select the \oplus sensor control.
- Select Min. minder if a cooking programme is in progress at the same time.
- Select Delete.
- Confirm with *OK*.

The minute minder duration is now deleted.

Main and sub-menus

Menu	Recommended value	Range
Oven functions		
Fan plus 	160 °C	30–250 °C
Conventional heat 	180 °C	30–250 °C
Steam cooking 	100 °C	70–100 °C
Auto roast 	160 °C	100–230 °C
Intensive bake 	170 °C	50–250 °C
Full grill 	240 °C	200–250 °C
Fan grill 	200 °C	100–250 °C
Moisture plus 	160 °C	130–250 °C
Automatic programmes 		
Further 		
Bottom heat	190 °C	100–250 °C
Eco Fan heat	190 °C	100–250 °C
Defrost	25 °C	25–50 °C
Maintenance		
Descalc		
Soak		
Drying		
Settings 		
Operating hours		

Energy saving tips

Cooking programmes

- If possible, use the automatic programmes for cooking food.
- Remove all accessories from the oven compartment that are not required for cooking.
- In general, if a range of temperatures is given in a recipe or chart, it is best to select the lower temperature and to check the food after the shortest duration.
- Preheat the oven compartment only if instructed to do so in the recipe or the cooking chart.
- If possible, do not open the door during a programme.
- Use dark, matt bakeware and cooking containers made of non-reflective materials (enamelled steel, heat-resistant glass, coated aluminium). Shiny materials such as stainless steel or aluminium reflect the heat and therefore can give a more uneven food heating result. Do not cover the oven floor or the rack with heat-reflecting aluminium foil.
- Monitor cooking durations to avoid wasting energy when cooking. Set the cooking duration, or use a food probe if you have one.
- The Fan plus  function can be used for cooking many types of food. Because the fan distributes the heat in the oven compartment straight away, it allows you to use a lower temperature than you would with Conventional heat . It also enables you to cook on multiple shelf levels at the same time.
- Eco Fan heat  is an innovative function which is suitable for smaller foodstuffs, e.g. frozen pizzas, part-baked rolls, biscuits and for meat dishes and roasts. Energy-efficient cooking thanks to optimal utilisation of heat. When cooking on a single shelf, up to 30 % less energy is used with comparatively good cooking results. Do not open the door during the cooking programme.
- Fan grill  is the best function for grilled dishes. With this function you can use lower temperatures than in other grill functions which use the maximum temperature setting.
- Whenever possible you should cook multiple foods at the same time. Place them next to each other in the oven or on different shelf levels.
- Foods which you are unable to cook at the same time should, if possible, be cooked one after the other in order to make use of existing heat in the oven.

Residual heat utilisation

- In cooking processes using temperatures greater than 140 °C and with cooking durations longer than 30 minutes, the temperature can be turned down to the lowest possible level about 5 minutes before the end of the cooking process. The residual heat in the oven is sufficient for cooking the food until it is done. However, never switch the combination steam oven off (see “Warning and safety instructions”).
- If you wish to run the programme for cleaning oil and grease off the catalytic enamelled parts of the oven, it is best to do so immediately after a cooking programme. The residual heat in the oven will help reduce the amount of energy consumed.

Customising settings

- Select Display | QuickTouch | Off for the control elements to reduce energy consumption.
- For the oven interior lighting, select Lighting | Off or “On” for 15 seconds. The oven interior lighting can be switched on again at any time by touching the  sensor control.

Energy-saving mode

The combination steam oven will switch itself off automatically to save energy if a cooking process is not being run and controls have not been operated. The time of day will appear in the display or the display will remain dark (see “Settings”).

Operation

- Switch the combination steam oven on.

The main menu will appear.



- Select the relevant operating mode.

The operating mode will appear first, followed by the recommended temperature.

- Change the recommended temperature and adjust the cooking duration if necessary.

The recommended temperature will be accepted within a few seconds. You can change the temperature subsequently via the arrow buttons.

- Confirm with *OK*.
- Select how many bursts of steam you want in the Moisture plus  operating mode (see “Moisture plus”).

In the Steam cooking  and Moisture plus  operating modes, you will be prompted to add water for the cooking process.

- Fill a suitable container with the required amount of fresh water and follow the instructions on the display (see “Operation – Drawing in water”).
- Place the food in the oven compartment.

The actual temperature will appear and the heating-up phase will commence. You will see the temperature increasing. A buzzer will sound when the set temperature is reached for the first time.

- After cooking, select the sensor control for the selected operating mode to end the cooking process.

 Risk of injury caused by hot steam.

When using a cooking process involving steam, a lot of hot steam can escape if the door is opened. The steam can cause burns.

Step back and wait until the hot steam has dissipated.

- Take the food out of the oven compartment.

Drying the oven compartment after a steam cooking process

Once you have finished cooking using the Steam cooking  operating mode, we recommend that you use the Drying maintenance programme to dry the oven compartment.

The Drying maintenance programme comprises up to 3 phases: residual water evaporation in the empty oven compartment, drying by heating the compartment and rapid cool-down with the door slightly open.

Run the Drying maintenance programme to protect the oven compartment against corrosion and to ensure that all residual water fully evaporates.

- Follow the instructions on the display.
- Remove the water and condensate from the oven compartment and drip channel using a sponge or absorbent cloth.
- Close the door.
- Switch the combination steam oven off once the Drying maintenance programme has finished.

Refilling the water

If there is not enough water in the container while a cooking process involving moisture is in progress, a buzzer will sound and the display will prompt you to refill the container with fresh water.

 Risk of injury caused by hot steam. When using a cooking process involving steam, a lot of hot steam can escape if the door is opened. The steam can cause burns. Step back and wait until the hot steam has dissipated.

- Fill a suitable container with the required amount of fresh water and follow the instructions on the display (see “Operation – Drawing in water”).

The heating-up phase restarts and the cooking process is resumed.



Changing values and settings for a cooking programme

Depending on the function, as soon as a cooking programme is in progress, you can change the values or settings for this programme.

Depending on the function, you can change the following settings:

- Temperature
- Duration
- Finish at
- Start at

Changing the temperature

Select Further  | Settings  | Recommended temps., to permanently reset the recommended temperatures to suit your cooking preferences.

- Select the \wedge or \vee arrow buttons or swipe to the right or left in the  area.

The desired temperature appears in the display.

- Change the desired temperature via the navigation area.

The temperature changes in 5 °C steps.

- Confirm with *OK*.

The cooking programme will restart with the new desired temperature.

Setting cooking durations

Cooking results can be impaired if there is a long delay between the food being placed in the oven and the start of cooking. Fresh food can change colour and even deteriorate. When baking, the cake mixture or dough can dry out, and the raising agents can lose their effectiveness. Select as short as possible a time until the cooking programme starts.



You have placed the food in the oven compartment, selected an operating mode and the required settings such as the temperature.

By entering Duration, Finish at or Start at via the  sensor control, you can automatically switch the cooking process off or on and off.



- Duration
Enter the required cooking duration for the food. The heating will switch off automatically once this duration has elapsed. The maximum cooking duration that can be set depends on the operating mode that you have selected.
- Finish at
Specify when you want the cooking process to end. The oven heating will switch off automatically at the time you have set.

Operation

- Start at
This function will only appear in the menu if you have set a Duration or Finish at time. With Start at, you have to specify when you want the cooking process to start. The oven heating will switch on automatically at the time you have set.



- Select the  sensor control.
- Set the desired times.
- Confirm with *OK*.
- Touch the  sensor control to return to the menu for the selected operating mode.

Changing the set cooking durations

- Select the  sensor control.
- Select the desired time.
- Confirm with *OK*.
- Select *Change*.
- Change the set time.
- Confirm with *OK*.
- Touch the  sensor control to return to the menu of the selected function.

These settings will be deleted in the event of a power failure.

Deleting the set cooking durations

- Select the  sensor control.
- Select the desired time.
- Confirm with *OK*.
- Select *Delete*.
- Confirm with *OK*.
- Touch the  sensor control to return to the menu of the selected function.

If you delete Duration, the set times for Finish at and Start at are also deleted.

If you delete Finish at or Start at, the cooking programme will start using the cooking duration set.

Cancelling a cooking programme

- Touch the sensor control for the selected function or the  sensor control.
- When *Cancel process* appears in the display, confirm with *OK*.

The oven compartment heating and lighting will then switch off. Any cooking durations set will be deleted.

The main menu will appear.

If the Rapid cooling function is switched on, the door automatically opens a little at the end of the cooking process and the cooling fan rapidly cools down the food and oven compartment.

Touch the sensor control for the selected function to return to the main menu.

Interrupting a cooking process in the Steam cooking operating mode

We recommend that you keep the door closed while a cooking process with pure steam operation is in progress to prevent steam from escaping and the set oven temperature from dropping.

You can interrupt the cooking process and pause the cooking duration when using the Steam cooking  operating mode as well as for programmes and applications with pure steam operation.

 Risk of injury caused by hot steam.

When using a cooking process involving steam, a lot of hot steam can escape if the door is opened. The steam can cause burns.

Step back and wait until the hot steam has dissipated.

- If you want to interrupt the cooking process, open the door while cooking is in progress.

The cooking process is interrupted and the cooking duration is paused.

 Risk of injury caused by hot surfaces and food.

The combination steam oven gets hot during operation. You could burn yourself on the heater elements, oven compartment, side runners, accessories or food.

Use oven gloves when placing hot food in the appliance or removing it and when adjusting oven shelves etc. in a hot oven compartment.

When placing cooking containers into the oven or removing them, make sure that the hot food does not spill out.





- When you want to continue the cooking process, close the door.

The cooking process will continue at the current oven temperature. The time left will continue to count down.

Pre-heating the oven



The **Booster** is used in conjunction with certain functions to quickly pre-heat the oven.





It is only necessary to pre-heat the oven in a few instances.

- Most dishes can be placed in the cold oven to make use of the heat produced during the heating-up phase.
- Pre-heat the oven when cooking the following food with the following functions:
 - Dark bread dough as well as beef sirloin joints and fillet with the Fan plus , Moisture plus  and Conventional heat  functions
 - Cakes and pastries with a short cooking duration (approx. 30 minutes or less) as well as delicate items (e.g. sponge) with the Conventional heat  function (without the **Booster** function)

Booster

The **Booster** function is used to quickly pre-heat the oven compartment.

This function is switched on as the factory default setting for the following functions (Further  | Settings  | **Booster** | On):

- Fan plus 
- Conventional heat 
- Auto roast 
- Moisture plus 

If you set a temperature above 100 °C and the **Booster** function is switched on, a rapid heating-up phase heats the oven to the set temperature. The top heat/grill element and the ring heater element come on together with the fan.

Delicate items (e.g. sponge or biscuits) will brown too quickly on the top if the **Booster** function is used. Switch off the **Booster** function for these items.

Operation

Switching off Booster for a cooking process

- Select the **Booster | Off** setting before selecting the desired operating mode.

The **Booster** function is switched off during the heating-up phase. Only the heater elements for the selected operating mode are used to pre-heat the oven compartment.

If you then want to restart a cooking process with the **Booster** function, select the **Booster | On** setting to switch the function on again.

Rapid cooling

Using the **Rapid cooling** function you can quickly cool down food and the oven compartment once the cooking process is brought to an end.

This function is not available with the **Steam cooking**  operating mode.

Switching off Rapid cooling for a cooking process

- Select the **Rapid cooling | Off** setting before selecting the desired operating mode.

If the **Keeping warm** function is also switched on, When “**Rapid cooling**” is deactivated, “**Keeping warm**” is also switched off **will appear**.

The **Rapid cooling** and **Keeping warm** functions are switched off. Once the cooking process is brought to an end, the door remains closed. The cooling fan cools the food and the oven compartment.

If you then want to restart a cooking process with the **Rapid cooling** function, select the **Rapid cooling | On** setting to switch the function on again.

Keeping warm

Using the **Keeping warm** function you can keep food warm after cooking without inadvertently cooking it further.

The food is kept warm at a pre-set temperature (see “**Settings – Recommended temps.**”).

It is only possible to use the **Keeping warm** function in combination with the **Rapid cooling** function.

This function is not available with the **Steam cooking**  operating mode.

Switching on Keeping warm for a cooking process

- Select the **Keeping warm | On** setting before selecting the desired operating mode.

When the **Rapid cooling** function is also switched off, “**Keeping warm**” requires “**Rapid cooling**”. “**Rapid cooling**” will also be activated. **will appear**.

- If necessary, confirm with **OK**.

The **Keeping warm** and **Rapid cooling** functions are switched on. Once the cooking process is brought to an end, the door opens a little automatically. The cooling fan cools the food and the oven compartment quickly to the pre-set temperature. Once this temperature is reached, the door is closed again automatically in order to keep the food warm.

If you then want to restart a cooking process without the **Keeping warm** function, select the **Keeping warm | Off** setting to switch the function off again.

The setting for the **Rapid cooling** function does not change.

Using Steam cooking

In the Steam cooking  operating mode, you can cook food exclusively using steam (see “Operation – Drawing in water”).

In contrast to the Moisture plus  operating mode, a larger amount of water is drawn in which is continuously supplied to the oven compartment in the form of steam at a maximum temperature of 100 °C.

This means that the food will **not** be browned.

Tip: Keep the door closed during the cooking process to prevent any steam escaping.

Refer to the relevant instructions in “Cleaning and care – Evaporate res. moisture”.

Suitable food items

Steam cooking retains the actual flavour of the food better than conventional cooking. We therefore recommend not seasoning the food with salt, or at least waiting until after the food is cooked. The food also keeps its fresh, natural colour.

- **Vegetables** are ideal for steam cooking, and particularly for blanching. Almost all vitamins and minerals are retained as the food is not immersed in water.
- **Rice** is cooked in liquid and absorbs it all during the cooking process so none of the nutrients are lost. It is very easy to cook **pudding rice**, as it does not need to be stirred and will not burn.
- Steam cooking delivers very even and fluffy results when cooking **egg dishes** such as custard royale, crème brûlée and soufflé.

Cooking containers

Use suitable cooking containers for the food you are cooking (see “Features – Accessories supplied and available to order”).

Use perforated cooking containers for steam cooking if possible. The steam can reach the food from all sides and the food is cooked evenly.

Your own containers

You can also use your own containers. However, please note the following:

- **Always** place the universal tray on shelf level 1 to collect the liquid. Place the containers on the rack or in a cooking container on shelf level 3.
- Containers must be suitable for use in an oven and able to withstand steam. With plastic containers, please check with the manufacturer that they are suitable for use in a steam oven.
- Thick-sided containers such as porcelain, ceramic or stoneware are not very suitable for using with steam. Due to their thick sides, they do not conduct heat well, meaning cooking durations will be considerably longer than those given in the charts.
- Ensure that there is a gap between the upper rim of the container and the ceiling of the oven to allow sufficient steam into the container.

Frozen food

The heating up phase for frozen food is longer than for fresh food. The greater the quantity of frozen food, the longer the heating up phase.

Steam cooking

Cooking with liquid

When cooking with liquid only fill the cooking container $\frac{2}{3}$ full to prevent the liquid spilling when the cooking container is removed from the oven.

Notes on the cooking charts

You can find the cooking charts at the end of this book.

Shelf level

Always place the universal tray on shelf level 1 to collect the liquid.

Place the rack or cooking container on shelf level 3.

Always insert cooking containers and the rack between the rails of the side runners so that they cannot tip.

Temperature

During steam cooking, the temperature does not exceed 100 °C. Almost all foods can be cooked at this temperature. Some types of food, such as berries, need to be cooked at lower temperatures to prevent them from bursting.

Cooking duration

During steam cooking, the cooking duration does not begin until the set temperature is reached.

In general, the cooking durations for cooking with steam are the same as for cooking food in a saucepan. More information about any factors which may affect the cooking duration is given in the relevant sections.

The quantity of food does not affect the cooking duration. 1 kg of potatoes will take the same time to cook as 500 g.

Vegetables

Fresh

Prepare fresh vegetables in the usual way, i.e. wash, clean and cut them up.

Frozen food

Frozen vegetables do not need to be defrosted beforehand, unless they have been frozen together in a block.

Frozen and fresh vegetables which take the same length of time to cook can be cooked together.

If vegetables have frozen together in clumps, break these up before cooking with steam. Follow the manufacturer's instructions on the packaging regarding cooking duration.

Cooking containers

When each piece of the food being cooked only has a small diameter (e.g. peas, asparagus), there are no or very few gaps and the steam can hardly penetrate the food. To ensure even cooking, use a flat cooking container for these types of food and make sure that the food is piled no more than 3–5 cm high. Divide larger amounts of food over several flat cooking containers.

Different types of vegetables which take the same length of time to cook can be cooked together in one cooking container.

Vegetables that need to be cooked in liquid, such as red cabbage, must be placed in solid cooking containers.

Shelf level

If you cook vegetables that could stain other food, e.g. beetroot, in a perforated cooking container, do not put any other food underneath. This avoids any transfer of colour to other food and prevents liquid dripping onto food below it.

Cooking duration

The cooking duration depends on the size of the food and how well cooked you want it, just as it does with conventional cooking methods.

Example:

Waxy potatoes, cut into quarters:

approx. 25 minutes

Waxy potatoes, cut in half:

approx. 30 minutes

Fish

Fresh

Prepare fresh fish in the usual way, i.e. clean, gut and fillet.

Frozen food

Fish does not need to be fully defrosted before cooking. Defrost so that the surface is sufficiently thawed to take herbs and seasoning. Depending on the thickness of the fish, 2 - 5 minutes should be enough.

Preparation

Add some lemon or lime juice to fish before cooking. The citric acid helps the flesh stay firm.

It is not necessary to season fish with salt when cooking with steam as this method retains the minerals which give the fish its unique flavour.

Cooking containers

If using a perforated container, grease it first.

Shelf level

When cooking fish in a perforated container at the same time as cooking other types of food in other containers, place the container with the fish directly above the universal tray to catch any liquid and so avoid any transfer of tastes to other food.

Temperature

85 °C – 90 °C

For gently cooking delicate types of fish, such as sole.

100 °C

For cooking firmer types of fish, e.g. cod and salmon.

Also for cooking fish in sauce or stock.

Steam cooking

Duration

The cooking duration depends on the thickness and the texture of the fish, and not on the weight. The thicker the fish, the longer the cooking duration. A 3 cm thick piece of fish weighing 500 g will take longer to cook than a 2 cm thick piece of fish weighing 500 g. The longer fish cooks, the firmer its flesh will become. Use the cooking durations given in the chart. If you find that the fish is not cooked sufficiently only cook it for a few minutes more.

When cooking fish in sauce or stock, we recommend that you increase the cooking duration quoted by a few minutes.

Tips

- Adding herbs and spices, such as dill, will help bring out the full flavour of the fish.
- Cook large fish in swimming position. To help maintain the shape of the fish, place a small cup or similar upside down in the cooking container, and arrange the fish belly-side down over the cup.
- You can use any fish scraps, e.g. fish heads, bones, tails etc to make a **fish stock**. Place the fish scraps together with some mixed vegetables in a solid cooking container and add cold water. Cook at 100 °C for 60 minutes. The longer the cooking duration, the stronger the stock.
- Preparing fish **au bleu** is a method involving cooking the fish in water with vinegar, at different proportions depending on the recipe. It is important not to damage the skin of the fish. This method is suitable for cooking carp, trout, tench, eel and salmon.

Meat

Fresh

Prepare the meat in the usual way.

Frozen food

Meat should be thoroughly defrosted before cooking (see “Special applications” – “Defrost”).

Preparation

For meat which needs to be seared before being cooked, e.g. for a stew, sear the meat in a pan on the hob first.

Duration

The cooking duration depends on the thickness and the texture of the meat, and not on the weight. The thicker the piece of meat, the longer the cooking duration. A piece of meat weighing 500 g which is 10 cm thick will take longer to cook than a piece of meat weighing 500 g which is 5 cm thick.

Tips

- To retain the **flavour**, use a perforated cooking container. You can use the concentrate that collects in the universal tray to enhance your sauces or freeze it for later use.
- Boiling meat from chicken and beef as well as meat bones can be used to make a **strong stock**. Place the meat together with the bones and some mixed vegetables in a cooking container and add cold water. The longer the cooking duration, the stronger the stock.

Rice

Rice swells when cooked and needs to be cooked in liquid. The proportion of rice to liquid will vary depending on the type of rice.

The rice absorbs all the liquid during the cooking process and so none of the nutrients are lost.

Grains

Grains swell when cooked and need to be cooked in liquid. The proportion of grains to liquid depends on the type of grain.

Grains can be cooked whole or cracked.

Pasta

Dry pasta

Dry pasta swells when it is cooked and needs to be cooked in liquid. The liquid must cover the pasta. Using hot liquid gives better results.

Increase the cooking time stated by the manufacturer by approx. $\frac{1}{3}$.

Fresh food

Fresh pasta, such as the kind you can buy from the supermarket chilled counter, does not need to absorb water. Cook fresh pasta in a greased perforated container.

Separate any pieces of pasta which have stuck together and spread them out in the cooking container.

Fruit

To ensure that no juice is lost, cook fruit in a solid cooking container.

If you cook fruit in a perforated cooking container, collect the juice in the universal tray.

Tip: You can use the juice which has collected in the solid container to make a glaze for a fruit flan.

Moisture plus

Using Moisture plus

In the Moisture plus  operating mode, you can bake, roast or cook food by combining oven heating with moisture (see “Main and sub-menus” and “Operation – Drawing in water”).

The water drawn in is injected as 1 to 3 bursts of steam into the oven compartment during the cooking process. The food is cooked evenly and, in contrast to the Steam cooking  operating mode, also evenly browned due to the higher temperatures.

It is normal for condensation to form on the inside of the door while steam is being injected. This will evaporate during the course of the cooking process.

Refer to the relevant instructions in “Cleaning and care – Evaporate res. moisture”.

Suitable food items

One burst of steam takes about 5–8 minutes. The number of bursts of steam and when they are performed will depend on the type of food being cooked:

- **Yeast doughs** will rise better if steam is released at the beginning of the programme.
- **Bread and bread rolls** rise better if steam is released at the start. Another burst of steam at the end of the programme will give the bread and rolls a glistening crust.
- When **roasting meat with a high fat content**, releasing steam at the beginning of roasting will help render the fat.

Additional moisture is not suitable for mixtures which already contain a lot of moisture, such as meringues. These need to dry out during baking.

Tip: Use the supplied recipes or the Miele app for reference.

 Risk of injury caused by steam. Steam can cause severe scalding. In addition, steam condensing on the control panel will cause the sensor controls to respond more slowly. Do not open the door whilst bursts of steam are being released.

If you are cooking food such as bread or rolls in a pre-heated oven it is best to release the bursts of steam manually. The first burst of steam should be released as soon as you have placed the food in the oven.

If you select more than one burst of steam, the second burst of steam cannot be released before the temperature in the oven compartment has reached at least 130 °C.

Automatic burst of steam

Once the heating-up phase has been completed, the burst of steam is released automatically.

The water will evaporate in the oven compartment.  appears in the display.

After the steam has been released,  will disappear.

- Continue cooking the food until the end of the cooking duration.



1 burst of steam, 2 bursts of steam or 3 bursts of steam

The bursts of steam can be injected as soon as the  sensor control lights up in the display.



Wait until the heating-up phase is completed to allow the steam to be distributed evenly by the warm air in the oven.

Tip: For tips on when to inject the steam, please refer to the recipes in the cookbook supplied with the oven or to the Miele app. Use the Min. minder  function to remind you when to inject the steam.

- Select the  sensor control.

The burst of steam will be released.  appears in the display and the light in the  sensor control goes out.

- Proceed as described to inject further bursts of steam as soon as the  sensor control lights up.

After the last burst of steam is injected, the  sensor control and  disappear from the display.

- Continue cooking the food until the end of the cooking duration.

Automatic programmes

The wide range of automatic programmes enables you to achieve excellent results with ease.

Categories

The  automatic programmes are sorted into categories to provide a better overview. Simply select the appropriate programme for the type of food you are cooking and follow the instructions in the display.

Refer to the relevant instructions in “Cleaning and care – Evaporate res. moisture”.

Using automatic programmes

- Select Automatic programmes .

A list will appear in the display.

- Select the desired food category.

The automatic programmes available for the food category selected will then appear.

- Select the desired automatic programme.
- Follow the instructions in the display.

Usage notes

- The degree of cooking is represented by a bar with seven segments. Using the navigation area you can set the desired degree of cooking.
- When using automatic programmes, the recipes provided are designed as a guide only. Other similar recipes, including those using different quantities, can be used for the automatic programme in question.
- After cooking, allow the oven compartment to cool down to room temperature again before starting an automatic programme.
- When you place food into the hot oven compartment, be careful when opening the door. Hot steam may escape. Step back and wait until the steam has dissipated. Avoid contact with hot steam, and do not touch the hot oven compartment walls. Danger of burning and scalding.
- Some automatic programmes require a pre-heating phase before food can be placed in the oven. A prompt will appear in the display indicating when this needs to be done.
- Some automatic programmes require the addition of liquid after a certain cooking duration. You will be prompted by a message in the display when this needs to be done (e.g. for adding liquid).
- The duration quoted for automatic programmes is an estimate. It may increase or decrease depending on the programme. The duration, in particular with meat, will vary depending on the initial temperature of the food.

This section provides information on the following applications:

- Defrost
- Low temperature cooking
- Drying
- Frozen food/ready meals
- Heating crockery

Defrost

Gentle defrosting of frozen goods means that the vitamins and minerals are generally retained.

- Select Further .
- Select Defrost.
- Alter the recommended temperature if necessary.

Air is circulated throughout the oven compartment to gently defrost the frozen goods.



Risk of infection from bacteria.

Bacteria such as salmonella can cause life-threatening food poisoning. It is particularly important to observe food hygiene rules when defrosting fish and meat, and in particular when defrosting poultry.

Do not use the liquid produced during defrosting.

Process the food as required as soon as it has been defrosted.

Tips

- Remove the packaging and place the frozen goods on the universal tray or in a suitable bowl or dish.
- Use the universal tray with the rack placed on top of it for defrosting poultry. This way the frozen goods will not be lying in the defrosted liquid.
- Meat, poultry or fish does not need to be fully defrosted before cooking. Defrost until the food has started to thaw. The surface will then be sufficiently thawed to take herbs and seasoning.

Low temperature cooking

Low temperature cooking is ideal for cooking delicate cuts of beef, pork, veal or lamb when a tender result is desired.

First sear the meat all over at a high temperature on the hob in order to seal it.

Then place the meat in the pre-heated oven compartment where the low temperature and long cooking duration will cook it to perfection and ensure it is very tender.

The meat will relax. The juices inside will start to circulate evenly throughout the meat to reach the outer layers.

This gives very tender and succulent results.

- Only use lean meat which has been correctly hung and trimmed. Bones must be removed before cooking.
- For searing, use a suitable cooking oil or fat that can withstand high temperatures (e.g. clarified butter, vegetable oil).
- Do not cover meat during the cooking process.

The cooking duration takes approx. 2–4 hours depending on the weight and size of the meat and how well you want it cooked.

- As soon as the cooking process is done, you can carve the meat straight from the oven. It does not need to rest.
- The meat can be left in the oven compartment to keep warm until you serve it. This will not affect results in any way.
- Serve on pre-heated plates with very hot sauce or gravy to prevent it cooling down too quickly. The meat is at the ideal temperature for eating straight away.

Further applications

Using Conventional heat

Follow the information in the cooking charts at the end of this book.

Use the universal tray with the rack placed on top of it.

- Place the rack together with the universal tray on shelf level 2.
- Select the Conventional heat  operating mode and a temperature of 120 °C.
- Pre-heat the oven together with the universal tray and rack for approx. 15 minutes.
- Whilst the oven is pre-heating, sear the meat thoroughly on all sides on the hob.

 Risk of burns due to hot surfaces.

The combination steam oven gets hot during operation. You could burn yourself on the heater elements, oven compartment or accessories.

Use oven gloves when placing hot food in the appliance or removing it and when working in the hot oven compartment.

- Place the seared meat on the rack.
- Reduce the temperature to 100 °C (see “Cooking charts”).
- Continue cooking the meat until it is done.

Drying

Dehydrating or drying is a traditional method of preserving fruit, certain vegetables and herbs.





It is important that fruit and vegetables are ripe and not bruised before they are dried.



- Peel and core the food for drying, if necessary, and cut it up.
- Depending on how big it is, distribute the food for drying evenly in a single layer (if possible) over the baking and roasting rack or the universal tray.

Tip: You can also use the perforated Gourmet baking and AirFry tray, if you have one.

- Dry on a maximum of 2 levels at the same time.
Place the food for drying on shelf levels 1+3.
If using the baking and roasting rack and universal tray, place the universal tray below the rack.
- Select Fan plus .
- Change the recommended temperature and set the drying time.
- Turn the food for drying on the universal tray at regular intervals.

The drying times are longer for whole or halved food items.

Food for drying		🌡️ [°C]	⌚ [h]
Fruit		60–70	2–8
Vegetables		55–65	4–12
Mushrooms		45–50	5–10
Herbs*		30–35	4–8

 Operating mode, 🌡️ Temperature,
⌚ Drying time,  Fan plus,
 Conventional heat

*When drying herbs, always use the universal tray on shelf level 2 and use the Conventional heat  operating mode, as the fan is switched on in the Fan plus operating mode.

- Reduce the temperature if condensation begins to form in the oven compartment.

Removing the dried food

 Risk of injury caused by hot surfaces.

The combination steam oven gets hot during operation. You could burn yourself on the heater elements, oven compartment or accessories.

Use oven gloves when removing dried food from the oven.

- Allow the dried fruit or vegetables to cool down after drying.

Dried fruit needs to be completely dry, but also soft and elastic. Juice should not escape when cut.

- Store dried food in sealed glass jars or tins.

Frozen food/Ready meals

Tips for cakes, pizza and baguettes

- Bake cakes, pizza and baguettes on baking paper on the rack.
Do not use the baking tray or the universal tray for frozen foods with a large surface area. The tray could become warped and difficult, or even impossible, to remove from the oven compartment when hot. Additional use will make the warping worse.
- Use the lowest temperature recommended on the packaging.

Tips for French fries, croquettes and similar items

- These frozen items can be cooked on the baking tray or universal tray.
- Use the lowest temperature recommended on the packaging.
- Turn food several times during cooking.

Preparing frozen food/ready meals

Handling food carefully will help protect your health.

Cakes, pizzas and french fries should be cooked until golden, not dark brown.

- Select the function and temperature recommended on the packaging.
- Pre-heat the oven compartment.
- Place the food in the pre-heated oven compartment on the shelf level recommended on the packaging.
- Check the food at the end of the shortest cooking duration recommended on the packaging.

Heat crockery

Use the Fan plus  operating mode for pre-heating crockery.

Only pre-heat heat-resistant crockery.

- Place the rack on shelf level 1 and place the crockery to be pre-heated on it. Depending on the size of the crockery, you can also place the rack on the oven floor and take the side runners out to make more room.
- Select Fan plus .
- Set the temperature to 50–80 °C.

 Risk of injury caused by hot surfaces.

The combination steam oven gets hot during operation. You could burn yourself on the heater elements, oven compartment or accessories. Droplets of water may have accumulated underneath the crockery.

Use oven gloves when removing the crockery from the oven.

- Remove the heated crockery from the oven.

Baking

Handling food carefully will help protect your health.
Cakes, pizzas and french fries should be cooked until golden, not dark brown.

Tips on baking

- Set a cooking duration. If used for baking, do not delay the start for too long. Cake mixture or dough will dry out, and the raising agents will lose their effectiveness.
- Generally speaking, you can use racks, baking trays, universal trays and any type of baking tray made of heat-resistant material.
- Avoid using bright, thin-walled tins as they give an uneven or poor browning result. Under adverse circumstances, the food will not cook properly.
- Position rectangular tins with the longer side across the width of the oven compartment for optimum heat distribution and even baking results.
- Always place bakeware on the rack.
- Bake cakes with fruit toppings or deep cakes on the universal tray.

Using baking parchment

Miele accessories, e.g. the universal tray, are treated with PerfectClean enamel (see “Features”). Surfaces treated with PerfectClean enamel generally do not need to be greased or covered with baking parchment.

- Use baking parchment when baking lye mixtures because the sodium hydroxide used can damage the surface treated with PerfectClean.

- Use baking parchment when baking sponge, meringue, macaroons or similar items. Due to their high egg white content, these are more likely to stick.
- Use baking paper when cooking frozen food on the rack.

Notes on the cooking charts

You can find the cooking charts at the end of this book.

Selecting the temperature

- As a general rule, select the lower temperature given in the chart. Baking at temperatures higher than those recommended may reduce the cooking duration, but will lead to uneven browning of the food, and unsatisfactory cooking results.

Selecting the cooking duration

Unless otherwise stated, the cooking durations given in the cooking charts are for an oven compartment which has not been pre-heated. With a pre-heated oven compartment, shorten times by around 10 minutes.

- As a general rule, check the food after the shortest duration. Stick a wooden skewer into the food.

If it comes out clean without any batter/dough on it, the food is done.

Notes on the functions

You can find an overview of all the functions with their recommended values in “Main and sub-menus”.

Using Automatic programmes

- Follow the instructions in the display.

Using Fan plus

Because the fan distributes the heat around the oven compartment straight away, it allows you to use a lower temperature than you would with the Conventional heat  function.

Use this function if you are baking on multiple shelves at the same time.

- 1 shelf: place the food in shelf level 2.
- 2 shelves: place the food on shelf levels 1+3 or 2+4.
- 3 shelves: place the food on shelf levels 1+3+5.

Tips

- If you are cooking on multiple shelves at the same time, slide the universal tray in on the lowest level.
- For moist biscuits and cakes, bake on a maximum of 2 shelf levels at once.

Using Moisture plus

Use this function for cooking with moisture assistance.

- Place the food on shelf level 2.

Using Intensive bake

Use this function for baking cakes with moist toppings.

Do **not** use this function for baking thin biscuits.

- Place cakes on shelf level 1 or 2.

Using Conventional heat

Dark metal, enamel, or aluminium bakeware with a matt finish, as well as heat-resistant glass, ceramic, and coated bakeware can be used.

Use this function for baking traditional recipes. If using an older recipe or cookbook, set the oven temperature 10 °C lower than the recommended one. This will not change the cooking duration.

- Place the food in shelf level 1 or 2.

Using Eco Fan heat

Use this function for cooking small amounts of food, e.g. frozen pizzas, part-baked rolls or biscuits, while saving energy.

- Place the food in shelf level 2.

Roasting

Tips for roasting

- You can use all crockery made from temperature-resistant materials, e.g. roasting dishes, roasting pans with lid, ovenproof glass dishes, roasting bags, dishes made from earthenware or cast iron, the universal tray, rack and/or anti-splash insert (if available) on top of the universal tray.
- **Pre-heating** the oven compartment is only required when roasting beef sirloin joints and fillet. Pre-heating is generally not necessary.
- Use a **closed roasting dish** for roasting meat, such as an oven dish. The meat stays succulent. The oven compartment will also stay cleaner than when roasting on the rack. This ensures that sufficient stock remains for making gravy.
- If you are using a **roasting bag**, follow the instructions on the packaging.
- If you are using the **rack** or an **open roasting dish** for roasting, you can add a little fat or oil to very lean meat or place a few strips of streaky bacon on the top.
- **Season** the meat and place in the roasting dish. Dot with butter or margarine or brush with oil or cooking fat if necessary. For large lean cuts of meat (2–3 kg) and fatty poultry add about 1/8 litre of water to the dish.
- Do not add too much liquid during cooking as this will hinder the **browning** process. Browning only occurs towards the end of the cooking duration. Remove the lid about halfway through the cooking duration if a more intensive browning result is desired.





- At the end of the programme, take the food out of the oven compartment, cover it and leave to **stand** for about 10 minutes. This helps retain juices when the meat is carved.
- For a crisp finish, baste **poultry** 10 minutes before the end of the cooking duration with slightly salted water.

Notes on the cooking charts

You can find the cooking charts at the end of this book.

- Take note of the temperature range, the shelf levels and the timings. These also take the type of cooking container, the size of the meat and cooking practices into account.

Selecting the temperature

- As a general rule, select the lower temperature given in the chart. If higher temperatures are used than those specified, the meat will brown on the outside, but will not be properly cooked through.
- When cooking with Fan plus , Moisture plus  and Auto roast , select a temperature which is approx. 20 °C lower than with Conventional heat .
- For cuts which weigh more than 3 kg, select a temperature approx. 10 °C lower than that given in the roasting chart. The roasting process will take longer, but the meat will cook evenly through and the skin or crackling will not be too thick.
- When roasting on the rack, set a temperature approx. 10 °C lower than for roasting in a covered oven dish.

Selecting the cooking duration

Unless otherwise stated, the durations given in the cooking chart are for an oven compartment which has not been pre-heated.

- The traditional British method for calculating the roasting time is to allow 15 to 20 minutes per lb/ 450 grammes, according to type of meat, plus approx. 20 minutes, adjusting the length of time as roasting proceeds to obtain the required result. The roasting time can also be determined by multiplying the thickness of the roast [cm] with the time per cm [min/cm] stated below, depending on the type of meat:
 - Beef/venison: 15–18 min/cm
 - Pork/veal/lamb: 12–15 min/cm
 - Sirloin/fillet: 8–10 min/cm
- As a general rule, check the food after the shortest duration.

Tips

- For frozen meat, increase the cooking duration by approx. 20 minutes per kg.
- Frozen meat weighing less than approx. 1.5 kg does not need to be defrosted before roasting.

Notes on the functions

You can find an overview of all the functions with their recommended values in “Main and sub-menus”.

Use the Bottom heat  function towards the end of the cooking duration to brown the base of the food.



Do not use the Intensive bake  function for roasting as the juices will become too dark.

Using Automatic programmes

- Follow the instructions in the display.

Using Fan plus or Auto roast

These operating modes are suitable for roasting meat, fish and poultry that needs to be well browned as well as sirloin joints and fillet.

The Fan plus  operating mode allows you to use a lower temperature than you would with the Conventional heat  operating mode, because the heat is immediately distributed around the oven compartment.

In the Auto roast  operating mode, the oven compartment heats initially to a high searing temperature (approx. 230 °C). As soon as this temperature has been reached, the combination steam oven automatically drops the temperature back down to the pre-selected cooking temperature (continued roasting temperature).

- Place the food on shelf level 2.

Using Moisture plus

Use this function for cooking with moisture assistance.

- Place the food on shelf level 2.

Using Conventional heat

Use this function for baking traditional recipes. If using an older recipe or cookbook, set the oven temperature 10 °C lower than the recommended one. This will not change the cooking duration.

- Place the food in shelf level 2.

Using Eco Fan heat

Use this function for cooking smaller roasts or meat dishes while saving energy.

- Place the food in shelf level 2.

Grilling

 Risk of injury caused by hot surfaces.

If you grill with the door open, hot air will escape from the oven instead of being cooled by the cooling fan. The control elements will get hot. Grill with the oven door closed.

Tips for grilling

- Pre-heating is necessary when grilling. Pre-heat the top heat/grill element for approx. 5 minutes with the door closed.
- Trim the meat if necessary. Do not season the meat with salt before grilling as this draws the juices out.
- Add a little oil to lean meat if necessary. Do not use other types of fat as they can easily burn and cause smoke.
- Clean fish in the normal way. To enhance the flavour, season with a little salt. Fish can also be drizzled with lemon juice.
- Use the universal tray with the wire rack or the grilling and roasting insert (if present) in place. The juices collect under the insert. This prevents them from spitting and making the oven dirty and they can then be used for making gravy and sauces. Brush the wire rack or the grilling and roasting insert with oil and then place the food on top.

Do not use the baking tray.

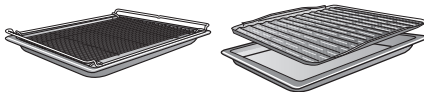

Notes on the cooking charts

You can find the cooking charts at the end of this book.

- Take note of the temperature range, the shelf levels and the durations. These take the size of the meat and cooking practices into account.
- Check the food after the shortest duration quoted.

Selecting the temperature

- As a general rule, select the lower temperature given in the chart. If higher temperatures are used than those specified, the meat will brown on the outside, but will not be properly cooked through.

Choosing a shelf level

- Select the shelf level depending on the thickness of the food to be cooked.
- Place flat food in shelf level 3 or 4.
- Place thicker food in shelf level 1 or 2.

Selecting the cooking duration

- Grill thinner cuts of meat/slices of fish for approx. 6–8 minutes per side. It is best to grill food of a similar thickness at the same time so that the cooking durations do not vary too much.
 - As a general rule, check whether the food is cooked after the shortest duration.
 - To **test the food**, press down on the meat with a spoon. This lets you determine how well the meat has been cooked.
- **Rare/pink**
If the meat gives easily to the pressure of the spoon, it will still be red on the inside.
 - **Medium**
If there is some resistance, the inside will be pink.
 - **Well done**
If there is very little resistance, it is cooked through.

Tip: If the surface of a thicker cut of meat is browned but the centre is still raw, move the food to a lower level or reduce the temperature and continue grilling. This will stop the surface from becoming excessively charred.

Notes on the functions

You can find an overview of all the functions with their recommended values in “Main and sub-menus”.

Using Full grill

Use this function to grill flat thin cuts in large quantities and for browning large baked dishes.

The whole of the top heating/grill element glows red to provide the required heat.

Using Fan grill

This function is suitable for grilling thicker food, such as chicken.

A temperature setting of 220 °C is generally recommended for thinner types of food, while 180–200 °C is recommended for thicker cuts.

Cleaning and care



Risk of injury caused by hot surfaces.

The combination steam oven gets hot during operation. You could burn yourself on the heater elements, oven compartment or accessories.

Allow the heater elements, oven compartment and accessories to cool before manual cleaning.



Risk of injury due to electric shock.

The steam from a steam cleaning appliance could reach live electrical components and cause a short circuit.

Never use a steam cleaner for cleaning.

All surfaces can discolour or alter if unsuitable cleaning agents are used. The front of the combination steam oven is particularly susceptible to damage from oven cleaners or descaling agents.

All surfaces are susceptible to scratching. Scratches on glass can in some circumstances lead to breakage.

Remove all cleaning agent residues immediately.

Unsuitable cleaning agents

To avoid damaging the surfaces, do not use:

- Cleaning agents containing soda, ammonia, acids or chlorides
- Cleaning agents containing descaling agents on the front
- Abrasive cleaning agents (e.g. powder cleaners, scouring milk, scouring pads)
- Solvent-based cleaning agents

- Stainless steel cleaners
- Dishwasher cleaning agents
- Glass cleaning agents
- Cleaning agents for ceramic glass hobs
- Hard, abrasive brushes or sponges (e.g. pot scourers, brushes or sponges which have been previously used with abrasive cleaning agents)
- Stain remover eraser blocks
- Sharp metal scrapers
- Steel wool
- Spot cleaning with mechanical cleaning agents
- Oven cleaners
- Stainless-steel spiral pads

If soiling is left on for any length of time, it may become impossible to remove. If items are used frequently without being cleaned, it may become very difficult to clean them. It is therefore best to remove any soiling immediately.

The accessories are not dishwasher-safe (with the exception of the cooking containers).

Tip: Soiling caused by spilt fruit juices and cake mixtures is best removed while the oven compartment is still warm.

To make it easier to clean the oven:

- Remove the door.
- Take out the side runners with FlexiClip runners (if fitted).
- Remove the catalytic enamelled back panel.

Removing normal soiling

Tip: It is easier to clean the appliance if you use the Further  Maintenance | Soak programme (see “Care”).

- Remove the condensate from the oven compartment and drip channel using a sponge or absorbent cloth.
- Remove normal soiling immediately with warm water, washing-up liquid and a clean sponge or a clean, damp microfibre cloth.
- Remove all cleaning agent residues thoroughly with clean water. This is particularly important for any parts with a PerfectClean finish, as cleaning agent residues will impair the non-stick function.
- After cleaning, wipe the surfaces dry using a soft cloth.

Cleaning the seal

There is a seal around the oven compartment to seal it off from the inside of the door.

Grease deposits on the seal can cause it to become brittle and cracked.

- It is advisable to wipe the seal clean after each use.

If the seal is not inserted correctly, steam may escape from the oven compartment during cooking.

Never remove the seal.

Cleaning cooking containers

The cooking containers are suitable for cleaning in a dishwasher.

- Wash and dry the cooking containers after each use.
- Any bluish discolouration on cooking containers can be removed with vinegar. Rinse with clean water.

Removing stubborn soiling (excluding the FlexiClip runners)

Spilt fruit and roasting juices may cause lasting discolouration or matt patches on surfaces. This discolouration will not affect the properties of the surface finish.

Do not attempt to remove these stains. Only use the equipment specified.

- Baked-on deposits can be removed with a glass scraper or with a stainless-steel spiral pad (e.g. Spontex Spirinett), hot water and washing-up liquid.

Tip: It is easier to clean the appliance if you use the Further  | Maintenance | Soak programme (see “Care”).

Exposure to scouring agents, abrasive brushes or sponges and oven cleaner can cause catalytic enamel to lose its self-cleaning properties.

Remove the catalytic enamelled panels before using an oven cleaner.

Using oven cleaners

- Very stubborn soiling on PerfectClean surfaces can be cleaned using the Miele oven cleaner, which must only be applied to cold surfaces.

If the oven spray gets into gaps and openings, a strong odour is generated during subsequent cooking programmes.

Do not spray the oven cleaner onto the roof of the oven compartment.

Do not spray the oven cleaner into the gaps and openings of the oven compartment walls and rear wall.

Cleaning and care

- Follow the instructions on the packaging.

Oven cleaners from other manufacturers must only be used in a cold oven and for no longer than a maximum of 10 minutes.

- You can then also use the scouring pad on the back of a washing-up sponge to remove the soiling.
- Remove all cleaning agent residues thoroughly with clean water.
- Dry all surfaces with a soft cloth.

Stubborn soiling on the FlexiClip runners

Cleaning FlexiClip telescopic runners in a dishwasher would remove the special grease which is essential for their smooth functioning.

Never attempt to clean FlexiClip telescopic runners in a dishwasher.

For stubborn surface soiling or if the bearings become sticky with spilled fruit juices proceed as follows:

- Soak the FlexiClip runners for approx. 10 minutes in a solution of hot water and washing-up liquid.
If necessary use the back of a washing-up sponge to remove the soiling. The bearings can be carefully cleaned with a soft brush.

Cleaning may cause some discolouration or fading in places, however this will not affect the functioning of the runners in any way.

Cleaning the catalytic enamelled back panel

Catalytic enamel is self-cleaning, which means that oil and fat are burnt off automatically when very high temperatures are reached inside the oven. You do not require any additional cleaning agents. The higher the temperature, the more effective the process.

Exposure to scouring agents, abrasive brushes or sponges and oven cleaner can cause catalytic enamel to lose its self-cleaning properties.

Remove the catalytic enamelled parts before using an oven cleaner in the oven compartment.

Removing soiling caused by spices, sugar and similar deposits

- Remove the back panel (see “Cleaning and care – Removing the back panel”).
- Clean the back panel by hand with a solution of hot water and washing-up liquid applied with a soft brush.
- Rinse the back panel thoroughly.
- Let the back panel dry before placing it back in the oven.

Removing oil and grease

- Remove any accessories from the oven compartment, including the side runners.
- Before starting the cleaning process, remove any large deposits of soiling from the inside of the door and the PerfectClean surfaces to prevent them burning on.
- Select the Fan plus  operating mode and 250 °C.
- Then heat the empty oven for at least 1 hour.

The length of time required will depend on the level of soiling.

If the catalytic enamel is very heavily soiled with oil and grease, a film can form on the oven compartment surface during the cleaning process.

 Risk of injury caused by hot surfaces.

The combination steam oven gets hot during operation. You could burn yourself on the heater elements and oven compartment.

Allow the heater element and oven compartment to cool before manual cleaning.

- Clean the inside of the door and the oven compartment with a solution of hot water and washing-up liquid, applied with a clean sponge or a clean, damp microfibre cloth.

Any remaining soiling will gradually disappear with each subsequent use of the oven at high temperatures.

Cleaning the ceiling of the oven

Clean the ceiling of the oven regularly to remove food residues.

 Risk of injury caused by hot surfaces.

The combination steam oven gets hot during operation. You could burn yourself on the heater elements, oven compartment or accessories.

Allow the heater elements, oven compartment and accessories to cool before manual cleaning.

The combination steam oven may be damaged if steam penetrates the lamp cover.

Never use the combination steam oven if the lamp cover is not secured in place.

Be careful not to damage the top heat/grill element.



Never lower the top heat/grill element.

- Clean the ceiling of the oven with hot water and washing-up liquid, applied with a clean sponge cloth or a clean, damp microfibre cloth.

Cleaning and care

Evaporate res. moisture

When cooking with steam or moisture, residual water may remain in the steam injection system, for example, if a cooking process with moisture is manually interrupted or if there is a power cut.

The next time Steam cooking , Moisture plus  or an automatic programme with moisture is used, Evaporate res. moisture will appear in the display.

- It is best to start the evaporation of residual water straight away so that only fresh water is used during the next cooking process and to prevent the steam injection system from taking in too much water and overflowing.

 Risk of injury caused by steam. Steam can cause severe scalding. Do not open the door while the residual water is being evaporated.

The time it takes for the residual water to evaporate varies depending on the amount of water.

The oven compartment is heated up and the remaining water is evaporated, causing condensation to form in the oven compartment and on the door.

- Be sure to wipe away the condensation from the door and oven compartment once the compartment has cooled down.

To start residual water evaporation immediately

 Risk of injury caused by steam. Steam can cause severe scalding. Do not open the door during a burst of steam.

- Select a function or an automatic programme that uses moisture.

The request Evaporate res. moisture appears.

- Confirm with *OK*.

A time appears.

The Evaporate residual water process will then start. You can follow the time counting down in the display.

The time indicated will depend on the amount of residual water left in the steam injection system. During the evaporation process, this time may be adjusted by the system according to the amount of water currently present.

At the end of the residual water evaporation process, a buzzer will sound and *Finished* will appear.

A cooking process using an operating mode or an automatic programme with moisture can now be run.

Whilst residual water is evaporating, moisture will condense on the door and in the oven compartment. This moisture needs to be removed after the oven compartment has cooled down.

Skipping residual water evaporation

 Risk of infection due to contaminated water in the water container.

Skipping residual water evaporation can cause germs to form in the water container. This contaminated water could be evaporated onto the food during the next cooking process.

It is best to start the evaporation of residual water straight away so that only fresh water is used during the next food cooking process.

Allowing further intake of water can, under extremely adverse circumstances, cause water to overflow from the steam injection system into the oven compartment. It is therefore best not to cancel the residual water evaporation process.

- Select an operating mode or an automatic programme that uses moisture.

Evaporate res. moisture will appear.

- Select Skip.

A cooking process using an operating mode or an automatic programme with moisture can now be run.

You will be prompted to carry out the evaporation of residual water again the next time you select an operating mode or an automatic programme with moisture and when you switch the combination steam oven off.

Maintenance

Soak

You can use this maintenance programme to soak stubborn soiling.

- Take the accessories out of the oven compartment.
- Remove coarse soiling with a cloth.
- Select Further  | Maintenance | Soak.
- Follow the instructions on the display.

 Risk of injury caused by hot steam.

At the end of the maintenance programme, a lot of hot steam can escape when the door is opened. The steam can cause burns.

Step back and wait until the hot steam has dissipated.

- Once soaking is complete, **immediately** remove the water and condensate from the oven compartment and drip channel using a sponge or absorbent cloth.
- Then dry the oven compartment and the inside of the door with a cloth.

Tip: Once you have run the Soak maintenance programme, we recommend that you run the Drying maintenance programme to also remove moisture from inaccessible areas of the oven compartment.

Cleaning and care

Drying

You can use this maintenance programme to dry any residual moisture in the oven compartment, including in inaccessible areas, and protect the oven against corrosion.

The Drying maintenance programme comprises up to 3 phases: residual water evaporation in the empty oven compartment, drying by heating the compartment and rapid cool-down with the door slightly open.

 Risk of infection due to contaminated water in the water container.

Germs can form in the water container if you do not run the Drying maintenance programme. This contaminated water could be evaporated onto the food during the next cooking process.

Run the Drying maintenance programme to ensure that all residual water fully evaporates.

- Select Further  | Maintenance | Drying.
- Select whether you want to start the drying cycle immediately or later and confirm with *OK*.
- Follow the instructions on the display.
- Remove the water and condensate from the oven compartment and drip channel using a sponge or absorbent sponge cloth.
- Switch the combination steam oven off once the Drying maintenance programme has finished.

Descale

The frequency of descaling will depend on the water hardness level in your area. The descaling process can be run at any time.

However, to ensure that the oven functions correctly, you will be automatically prompted to run the descaling process for the steam injection system after a certain number of cooking processes.

The oven will count down in the display the last 10 cooking processes that can be run before it needs to be descaled. You will then not be able to run any operating modes, automatic programmes and maintenance programmes using moisture assistance.

These operating modes can only be used again after you have carried out a descaling process. All other operating modes, automatic programmes and maintenance programmes without moisture assistance can still be used.

Descaling process sequence

Once the descaling process has been started, it must be completed through to the end. It cannot be cancelled.

Descaling takes approx. 140 minutes and consists of several steps:

1. Preparing the descaling process
2. Drawing in the descaling agent
3. Activation phase
4. Rinse 1
5. Rinse 2
6. Rinse 3
7. Evaporating the residual water and drying the oven compartment

Preparing the descaling process

You will need a container of approx. 1 litre capacity.

A plastic tube (with suction cup) is supplied with your oven so that you do not have to hold the container with the descaling agent underneath the water intake pipe.

We recommend using the descaling tablets supplied. They have been specially developed for Miele for optimum results.

Tip: Miele descaling tablets are available to order from the Miele online shop, from the Miele Customer Service Department or from your Miele dealer.

Other descaling agents, which contain other acids besides citric acid and/or other undesirable substances, such as chlorides, could cause damage. Moreover, the descaling result required could not be guaranteed if the descaling agent was not of the appropriate concentration.

- Fill the container with approx. 900 ml of cold fresh water and thoroughly dissolve two descaling tablets in it.

Carrying out the descaling process

- Select Further .
- Select Maintenance.
- Select Descale.

If the operating modes and automatic programmes with moisture are already disabled, the descaling process can be started immediately by touching **OK**.

- Push the universal tray into the top shelf level as far as it will go to collect the descaling agent after it has been used. Confirm the message shown with **OK**.

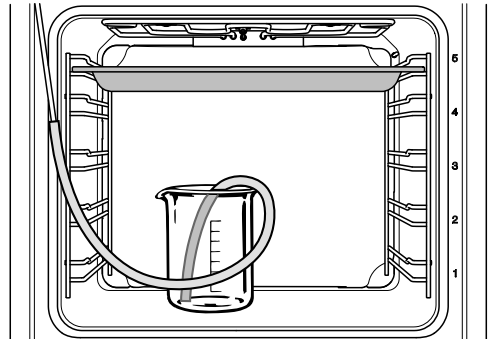

- Attach one end of the plastic tube to the water intake pipe.
- Place the container with the descaling agent on the floor of the oven.
- Place the other end of the plastic tube in the bottom of the descaling agent container and secure the plastic tube to the container with the suction cup.
- Confirm with **OK**.

The water intake process will begin. You will hear the noise of the pump.

You can interrupt and resume the intake process at any time by selecting **OK**.

A message will appear when the intake process is finished.

- Confirm with **OK**.
- Provide 1 l of fresh water and follow the instructions in the display.

The **activation phase** will begin. You can follow the time counting down in the display.

Cleaning and care

- Leave the container with the tube connected to the water intake pipe in the oven compartment.

The system will take in liquid several times during the activation phase. You will hear the noise of the pump.

The oven interior lighting and cooling fan remain switched on for the whole duration of the process.

At the end of the activation phase, a buzzer will sound.

Rinsing the steam injection system after the activation phase

After the activation phase, the steam injection system must be rinsed out with **cold** fresh water to remove residues of descaling agent.

To do this, approx. 1 litre of fresh water is pumped through the steam injection system three times and is collected in the universal tray.

Rinse the container thoroughly after the first rinse to remove any descaling agent residue.

- Follow the instructions in the display.

After the third rinse, the pump will run for approx. 1 minute to pump the remaining water out of the steam injection steam.

- Follow the instructions in the display.
- Remove the universal tray, container and plastic tube.
- Confirm with *OK*.

The rinsing process is complete.

Residual water evaporation

After the third rinse, residual moisture evaporation and the drying process will commence.

- Close the door.

 Risk of injury caused by steam. Steam can cause severe scalding. Do not open the door while the residual water is being evaporated.

The oven heating will switch on and the duration of residual moisture evaporation will appear. The duration is amended automatically depending on the actual amount of residual moisture.

Once the residual water has been evaporated, the drying process starts automatically to remove moisture from inaccessible areas of the oven compartment.

Finalising the descaling process

At the end of residual water evaporation, an information window appears with tips on cleaning after the descaling process.

- Confirm with *OK*.

A buzzer sounds and *Finished* appears.

- Use the  On/Off sensor control to switch the combination steam oven off.

 Risk of injury caused by hot surfaces.

The combination steam oven gets hot during operation. You could burn yourself on the heater elements, oven compartment or accessories.

Allow the heater elements, oven compartment and accessories to cool before manual cleaning.

- When the oven compartment has cooled down, clean away descaling agent residues.
- Leave the oven door open until the oven compartment is completely dry.

Removing the door

The door weighs approx. 9 kg.



The oven door is connected to the door hinges by retainers.

Before removing the door from the retainers, the locking clamps on both door hinges have to be released.

- Open the door fully.

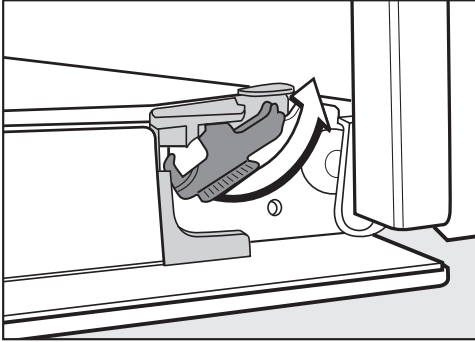

- Release the locking clamps by turning them as far as they will go.

The combination steam oven could become damaged if you incorrectly remove the door.

Never pull the door horizontally off its retainers, as they will spring back against the combination steam oven.

Never pull the door off the retainers by the handle, as the handle could break off.

- Raise the door up until it rests partially open.



- Hold the door on either side and pull it diagonally upwards off the retainers. Make sure that the door is straight.

Cleaning and care

Dismantling the door

The oven door is an open system with 3 glass panes which have a heat-reflective coating on some of their surfaces.

When the oven is operating, air is directed through the door to keep the outer pane cool.

If soiling has worked its way in between the glass panes, the door can be dismantled in order to clean in between the panes.

Scratches on the door glass can cause the glass to break.

Do not use abrasive cleaners, hard sponges, brushes or sharp metal tools to clean the door glass.

When cleaning the door glass, you must also follow the instructions that apply to the front of the combination steam oven.

Oven cleaners will damage the surface of the aluminium profiles.

Only clean these parts with warm water and washing-up liquid, applied with a clean sponge cloth or a clean, damp microfibre cloth.

The door glass could break if dropped.

Keep the disassembled door glass in a safe place.

 Risk of injury caused by the door slamming shut.

The door may slam shut if you attempt to disassemble it when it is fitted to the oven.

Always remove the door before disassembling it.

- Place the door with the outer glass pane on a soft surface (e.g. a tea towel) to prevent it getting scratched. The door handle should line up with the edge of the table so that the glass lies flat and does not get broken during cleaning.

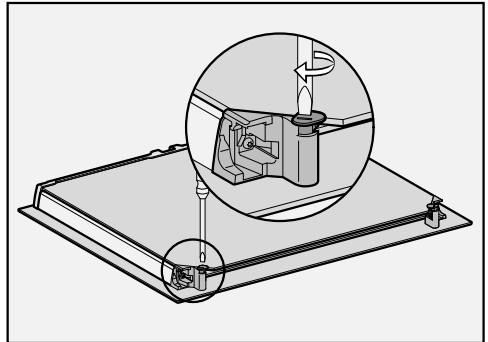

- Use a flat-head screwdriver to flip the two glass pane retainers outwards.

Remove the inner pane:

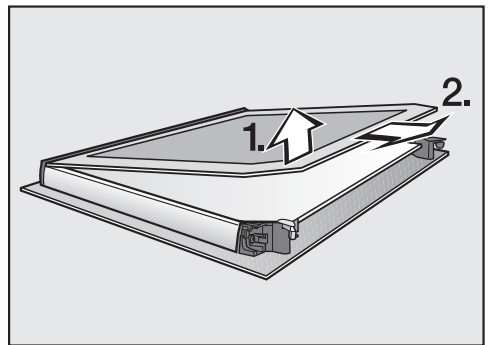

- **Gently** lift the inner pane up and out of the plastic strip.

Cleaning and care

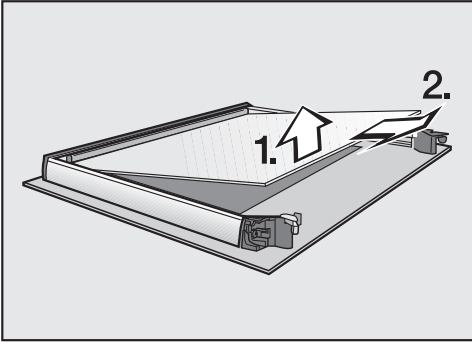

- Lift the middle pane up **gently** and pull it out.
- Clean the door panes and other parts with a clean sponge and a solution of hot water and washing-up liquid or a clean, damp microfibre cloth.
- Dry all parts with a soft cloth.

Then reassemble the door carefully:

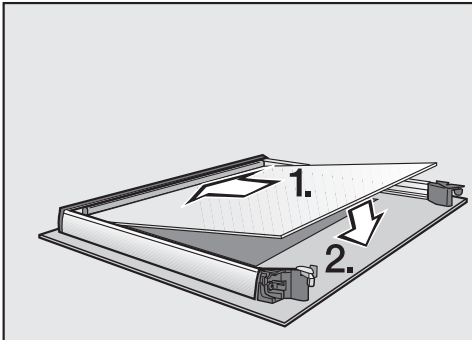

- Refit the middle pane in such a way that the material number is legible (not reversed).

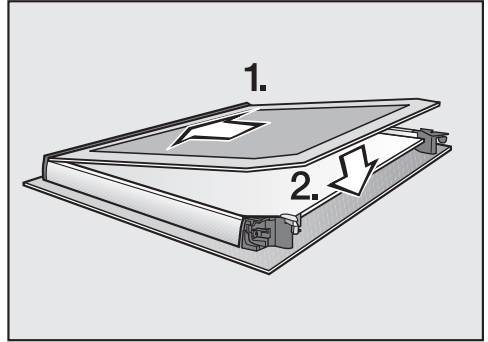

- Push the inner pane with the matt printed side facing downwards into the plastic strip and place it between the retainers.

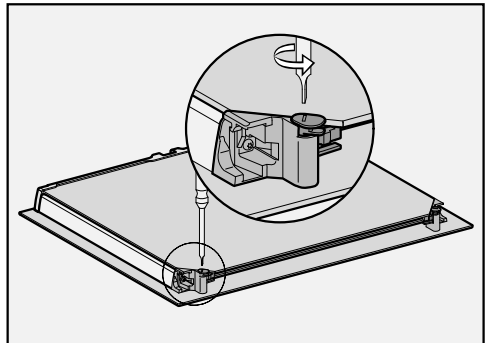

- Use a flat-head screwdriver to flip the two glass pane retainers inwards.
The door is now reassembled.

Cleaning and care

Fitting the door

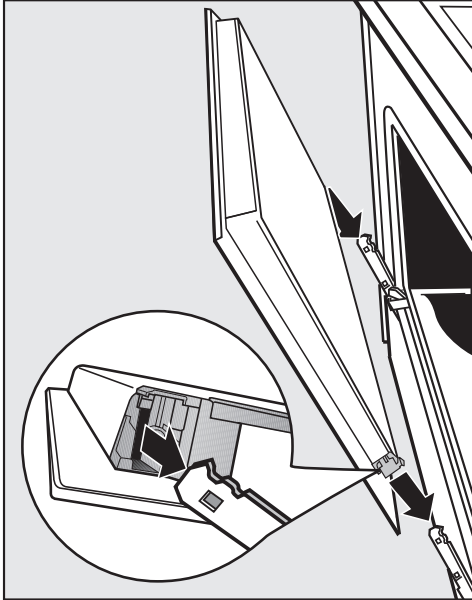

- Hold the door securely on both sides and carefully fit it back into the hinge retainers. Make sure that you fit the door straight.
- Open the door fully.

If the locking clamps are not locked, the door could become loose, resulting in damage. Always ensure that the locking clamps are locked after refitting the door.

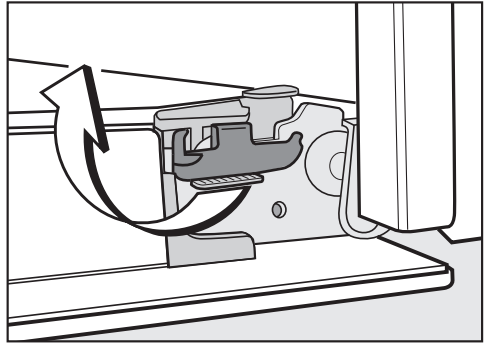

- To relock the locking clamps, turn them back up to the horizontal position as far as they will go.

Removing the side runners with FlexiClip runners

The side runners can be removed together with the FlexiClip runners (if inserted).

If you wish to remove the FlexiClip runners separately beforehand, please follow the instructions in “Features – Fitting and removing FlexiClip runners”.

 Risk of injury caused by hot surfaces.

The combination steam oven gets hot during operation. You could burn yourself on the heater elements, oven compartment or accessories. Allow the heater elements, oven compartment and accessories to cool before removing the side runners.

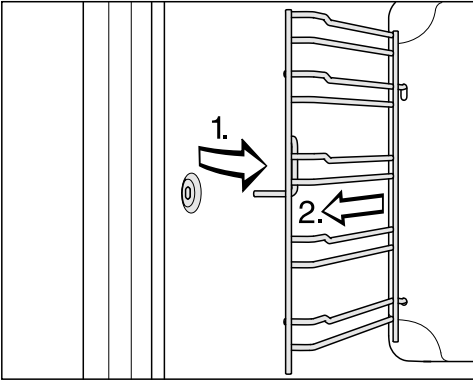

- Pull the side runners out of holder (1.) from the front and remove them (2.).

Reassemble by following these instructions in reverse order.

- Insert the components carefully.

Removing the back panel

The back panel can be removed for cleaning purposes.

⚠ Risk of injury caused by hot surfaces.

The combination steam oven gets hot during operation. You could burn yourself on the heater elements, oven compartment or accessories.

Allow the heater element, oven compartment and the accessories to cool before removing the back panel.

⚠ Risk of injury caused by the rotating fan impeller.

You could injure yourself on the impeller of the hot air fan.

Never put the combination steam oven into operation without the back panel in place.

- Disconnect the combination steam oven from the mains. Switch off at the wall and withdraw the plug from the socket or switch off the fuse of the electrical installation.
- Remove the side runners.
- Undo the four screws at the corners of the back panel and take it out.
- Clean the back panel (see “Cleaning and care – Cleaning the catalytic enamelled back panel”).

Reassemble by following these instructions in reverse order.

- Refit the back panel carefully.

Make sure the openings are located as illustrated in “Overview”.



- Fit the side runners.
- Reconnect the combination steam oven to the electricity supply.

Problem solving guide

Many malfunctions and faults that can occur in daily operation can be easily remedied. You can save time and money in many cases, as you do not need to call the Miele Customer Service Department.

Information to help you rectify faults yourself can be found at www.miele.com/service.

The following tables are designed to help you to find the cause of a malfunction or a fault and to resolve it.

Problem	Cause and remedy
The display is dark.	You have selected the Time Display Off setting. When the combination steam oven is switched off, the display is dark. <ul style="list-style-type: none"> ■ As soon as the combination steam oven is switched on, the main menu will appear. If you want the time of day to be displayed constantly, select the Time Display On setting.
	There is no power to the combination steam oven. <ul style="list-style-type: none"> ■ Check whether the combination steam oven is plugged into the electricity supply and switched on at the socket. ■ Check whether the circuit breaker has tripped. Contact a qualified electrician or the Miele Customer Service Department.
The buzzer does not sound.	The buzzers are deactivated or set at too low a volume. <ul style="list-style-type: none"> ■ Switch on the buzzers or increase the volume with the Volume Buzzer tones setting.
The oven compartment does not heat up.	Demo mode is active. You can select menu options in the display and the sensor controls, but the oven heating does not work. <ul style="list-style-type: none"> ■ Deactivate demo mode with the Showroom programme Demo mode Off setting.
System lock  appears in the display when the oven is switched on.	The  system lock has been activated. <ul style="list-style-type: none"> ■ Confirm with OK. Press "OK" for 6 secs will appear. <ul style="list-style-type: none"> ■ You can deactivate the system lock for a cooking process by touching the OK sensor control for at least 6 seconds. ■ If you want to permanently deactivate the system lock, select the Safety System lock  Off setting.

Problem solving guide

Problem	Cause and remedy
The sensor controls do not respond.	You have selected the Display QuickTouch Off setting. When the combination steam oven is switched off, the sensor controls do not respond. <ul style="list-style-type: none"> ■ As soon as the combination steam oven is switched on, the sensor controls will respond. If you want the sensor controls to always respond even when the combination steam oven is switched off, select the Display QuickTouch On setting.
	The combination steam oven is not connected to the power supply. <ul style="list-style-type: none"> ■ Check that the oven plug is correctly inserted into the socket and switched on. ■ Check whether the fuse has tripped. Contact a qualified electrician or the Miele Customer Service Department.
	There is a fault with the controls. <ul style="list-style-type: none"> ■ Touch and hold the  On/Off sensor control until the display switches off and the combination steam oven restarts.
Power cut appears in the display.	There has been a brief power cut. This has caused the current cooking process to stop. <ul style="list-style-type: none"> ■ Switch the combination steam oven off and back on again. ■ Restart the cooking process.
12:00 appears in the display.	The power supply was interrupted for longer than 150 hours. <ul style="list-style-type: none"> ■ Reset the time and date.
Max. op. hours reached appears in the display.	The combination steam oven has been operating for an unusually long time. This has triggered the safety switch-off function. <ul style="list-style-type: none"> ■ Confirm with <i>OK</i>. <p>The combination steam oven is now ready to use again.</p>
Fault and a fault code not listed here appears in the display.	A fault has occurred that you cannot resolve. <ul style="list-style-type: none"> ■ Call the Miele Customer Service Department.
The Start at and Finish at functions are not available.	The temperature in the oven compartment is too high, e.g. after a cooking process has finished. <ul style="list-style-type: none"> ■ Open the door and let the oven compartment cool down.
	These functions are not generally available in maintenance programmes.

Problem solving guide

Problem	Cause and remedy
<p>This function is not available at the moment appears in the display after selecting the Descale function.</p>	<p>The steam injection system is faulty.</p> <ul style="list-style-type: none"> ■ Call the Miele Customer Service Department.
<p>Programmes that use added moisture are not taking in water.</p>	<p>Demo mode is active. You can select menu options in the display and the sensor controls, but the pump for the steam injection system is not working.</p> <ul style="list-style-type: none"> ■ Deactivate Demo mode by selecting Settings Showroom programme Demo mode Off. <p>The pump for the steam injection system is faulty.</p> <ul style="list-style-type: none"> ■ Call the Miele Customer Service Department.
<p>A noise can be heard after a cooking programme.</p>	<p>The cooling fan remains switched on after a cooking programme (see “Settings – Cooling fan run-on”).</p>
<p>After moving house, the combination steam oven no longer switches from the heating-up phase to the cooking phase.</p>	<p>The boiling temperature of the water has changed as the altitude of the new location for the appliance differs from the old one by at least 300 m.</p> <ul style="list-style-type: none"> ■ Adapt the boiling temperature to the altitude of the new location (see “Settings – Altitude”).
<p>During operation, an unusually high amount of steam leaks out or steam leaks out from different places to usual.</p>	<p>The door is not closed properly.</p> <ul style="list-style-type: none"> ■ Close the door. <p>The door seal is damaged, e.g. cracked, or the door seal is not inserted correctly.</p> <ul style="list-style-type: none"> ■ Contact the Miele Customer Service Department. <p>The inner pane is so soiled that the seal is not seated correctly.</p> <ul style="list-style-type: none"> ■ Clean the inner pane (see “Cleaning and care – Dismantling the door”).
<p>The combination steam oven has switched itself off.</p>	<p>To save power, the combination steam oven switches off automatically if a button is not pressed after a certain amount of time or after a cooking process has ended.</p> <ul style="list-style-type: none"> ■ Switch the combination steam oven back on again.

Problem solving guide

Problem	Cause and remedy
Cakes/biscuits are not cooked properly after the duration given in the cooking chart.	A different temperature from the one given in the recipe was used. <ul style="list-style-type: none"> ■ Select the temperature required for the recipe.
	The ingredient quantities are different from those given in the recipe. <ul style="list-style-type: none"> ■ Check whether you amended the recipe. The addition of more liquid or more eggs makes a moister mix which requires a longer cooking duration.
The browning of the baked goods is uneven.	The wrong temperature or shelf level was selected. <ul style="list-style-type: none"> ■ There will always be a slight unevenness in browning. If browning is very uneven, check whether the correct temperature and shelf level were selected.
	The material or colour of the bakeware is not suitable for the oven function selected. <ul style="list-style-type: none"> ■ When using the Conventional heat  function, light coloured, shiny tins will not produce as desirable results. Dark, matt tins are best for baking.
Spots like rust appear on catalytic enamelled surfaces.	The catalytic cleaning process does not remove spices, sugar and similar deposits. <ul style="list-style-type: none"> ■ Take the catalytic enamelled panels out of the oven and remove this type of deposit with a mild solution of hot water and washing-up liquid applied with a soft brush (see “Cleaning and care – Cleaning the catalytic enamelled back panel”).
The FlexiClip runners do not push in or pull out smoothly.	The bearings in the FlexiClip runners are not sufficiently lubricated. <ul style="list-style-type: none"> ■ Lubricate the bearings with the special Miele lubricant. Only the special Miele lubricant is designed for the high temperatures in the oven compartment. Other lubricants may resinify when heated and will gum up the FlexiClip runners. You can obtain the special Miele lubricant from your Miele dealer or from the Miele Customer Service Department.
The oven interior lighting switches off after a short time.	You have selected the Lighting “On” for 15 seconds setting. <ul style="list-style-type: none"> ■ If you want the oven interior lighting to be switched on during the entire cooking programme, select the Lighting On setting.

Problem solving guide

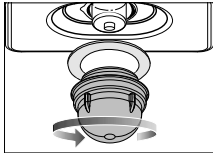
Problem	Cause and remedy
<p data-bbox="73 201 286 288">The oven interior lighting does not switch on.</p> 	<p data-bbox="297 201 613 229">The halogen lamp is faulty.</p> <div data-bbox="314 236 1039 453" style="border: 1px solid gray; padding: 5px;"><p data-bbox="320 244 807 280">⚠ Risk of injury caused by hot surfaces. The combination steam oven gets hot during operation. You could burn yourself on the heater elements, oven compartment or accessories. Allow the heater elements, oven compartment and accessories to cool before manual cleaning.</p></div> <div data-bbox="314 475 1039 612" style="border: 1px solid gray; padding: 5px;"><p data-bbox="320 483 975 536">The combination steam oven may be damaged if steam penetrates the lamp cover. Never use the combination steam oven if the lamp cover is not secured in place.</p></div> <ul data-bbox="297 635 1042 1007" style="list-style-type: none"><li data-bbox="297 635 1042 719">■ Disconnect the combination steam oven from the electrical supply. Switch off at the wall and withdraw the plug from the socket or switch off the fuse of the electrical installation.<li data-bbox="297 727 1042 783">■ Unscrew the lamp cover and then pull it together with its sealing ring downwards to take it out.<li data-bbox="297 791 1042 847">■ Replace the halogen lamp (Osram 66725 AM/A, 230 V, 25 W, G9).<li data-bbox="297 855 1042 911">■ Refit the lamp cover together with its sealing ring. The concave side of the sealing ring must point downwards.<li data-bbox="297 919 1042 948">■ Screw in the lamp cover by hand until it is tight.<li data-bbox="297 956 1042 1007">■ Reconnect the combination steam oven to the electricity supply.

Information to help you rectify faults yourself and about Miele spare parts can be found at www.miele.com/service.

Contact in the event of a fault

In the event of any faults which you cannot remedy yourself, please contact your Miele dealer or the Miele Customer Service Department.

You can book a Miele Customer Service Department call-out online at www.miele.com/service.

Contact information for the Miele Customer Service Department can be found at the end of this document.

Please quote the model identifier and serial number of your appliance (Fabr./SN/Nr.) when contacting the Miele Customer Service Department. This information can be found on the data plate.

Please note that telephone calls may be monitored and recorded for training purposes and that a call-out charge will be applied to service visits where the problem could have been resolved as described in this booklet.

This information is given on the data plate, which is visible on the front frame of the oven when the door is fully open.

Warranty

For information on the appliance warranty specific to your country please contact Miele. See back cover for address.

In the UK, your appliance warranty is valid for 2 years from the date of purchase. However, you must activate your cover by calling 0330 160 6640 or registering online at www.miele.co.uk.

Installation

Installation dimensions

Dimensions are given in mm.

Installation in a tall or housing unit

When building the combination steam oven into a base unit underneath a hob, please also observe the installation instructions for the hob as well as the casing depth required for the hob.

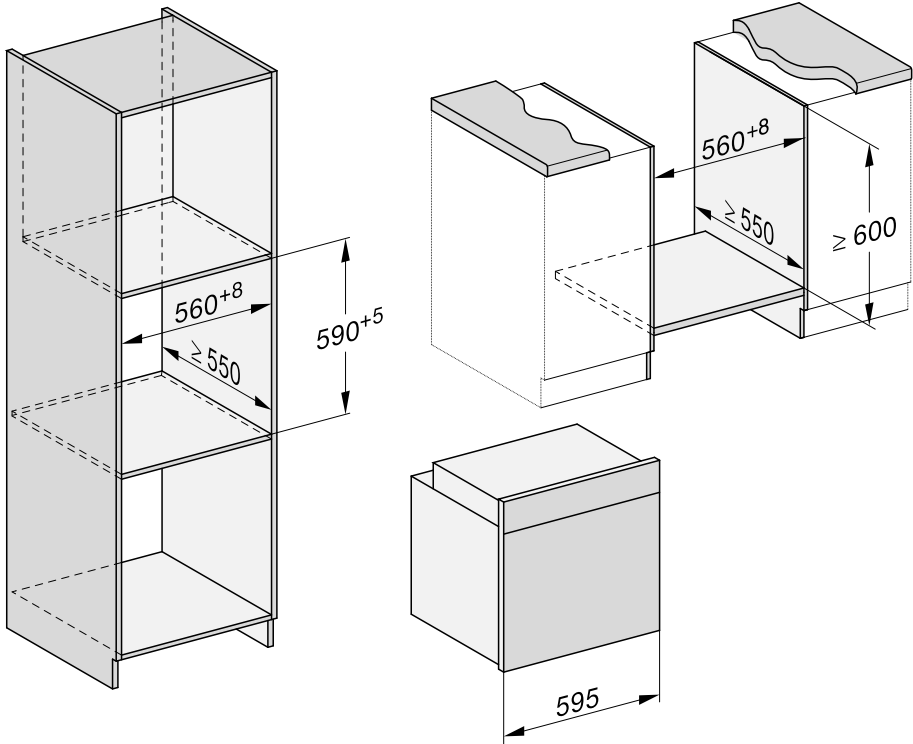

Side view

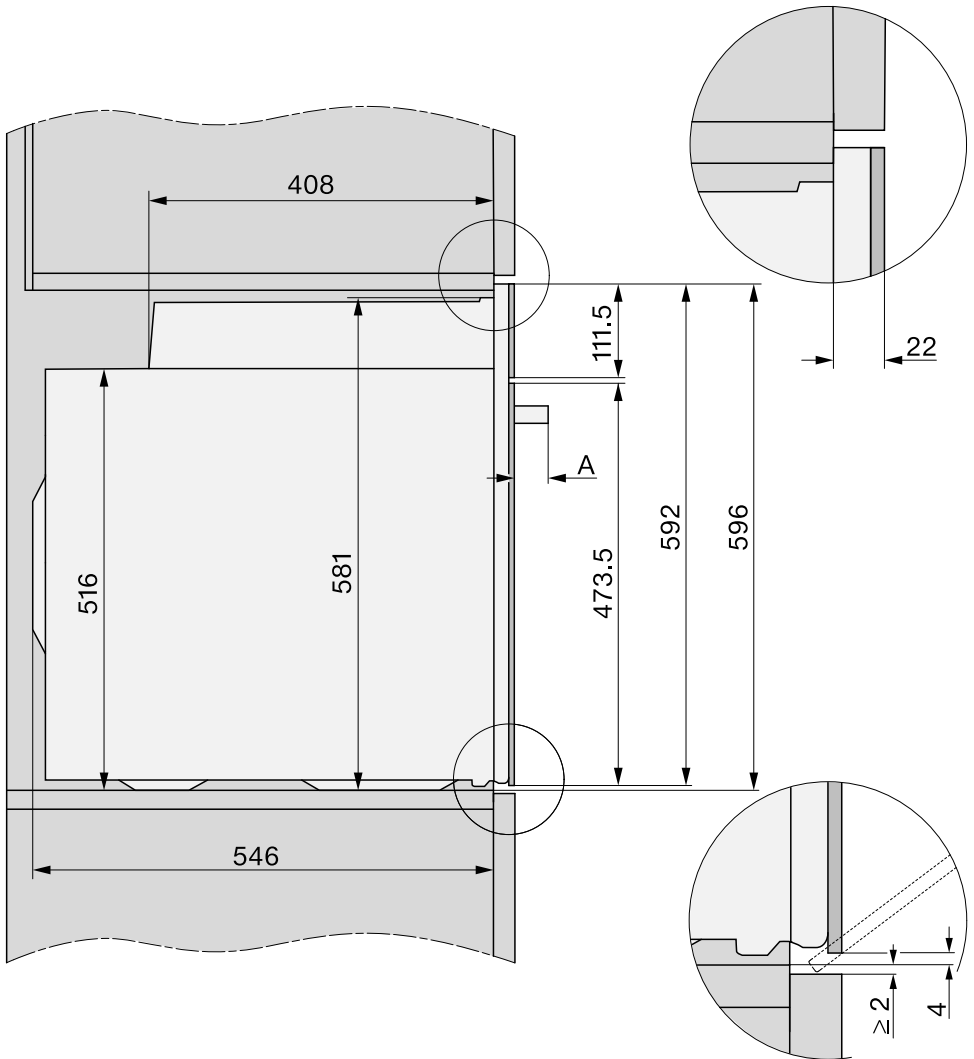

- A** DGC 715x: 43 mm
DGC 725x: 47 mm

Installation

Connections and ventilation

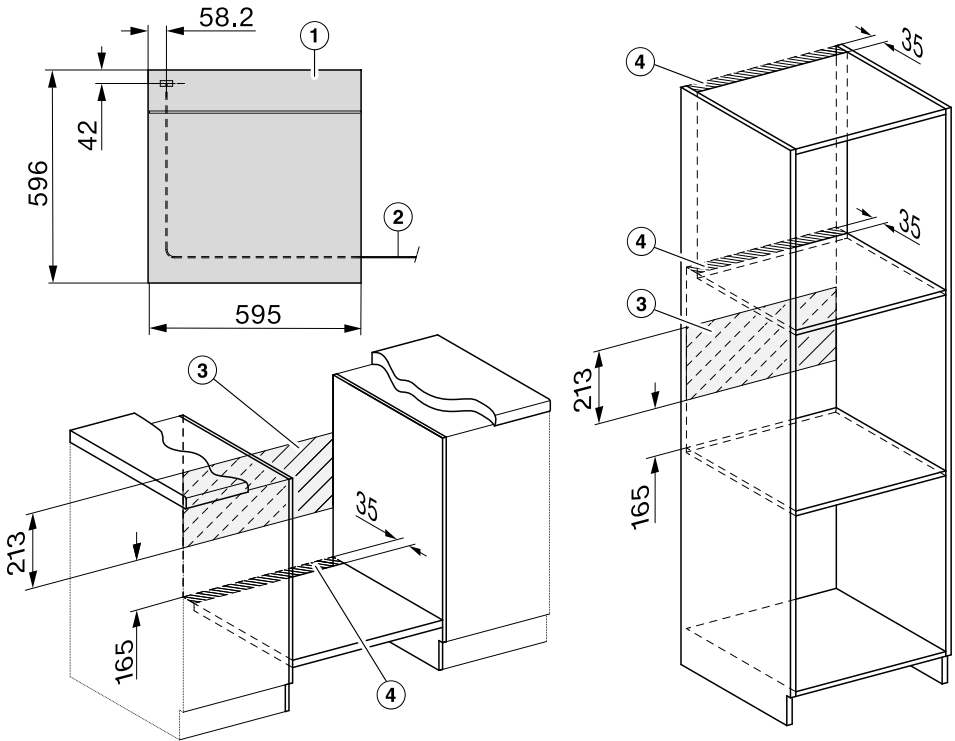

- ① Front view
- ② Mains connection cable, length = 1500 mm
- ③ No connections permitted in this area
- ④ Ventilation cut-out, min. 150 cm²

Installing the combination steam oven

For safety reasons, the combination steam oven may only be used when it has been fully installed.

The combination steam oven requires a sufficient supply of cool air for efficient operation. The required supply of cool air must not be excessively heated by other heat sources (e.g. solid fuel stoves).

The following must be observed when installing the appliance:

Make sure that the interim shelf that the combination steam oven sits on does not touch the wall.

Do not fit heat insulation strips to the side walls of the housing unit.

- Connect the combination steam oven to the electrical supply.

Carrying the combination steam oven by the door handle could damage the door.

Use the recessed grips on the side of the housing to carry the appliance.

It is a good idea to remove the door (see “Cleaning and care – Removing the door”) and the accessories before installing the appliance. The combination steam oven is then easier to push into the housing unit and you do not run the risk of lifting it by the door handle.

- Push the combination steam oven into the housing unit and align it.
- Open the door, if you have not removed it.

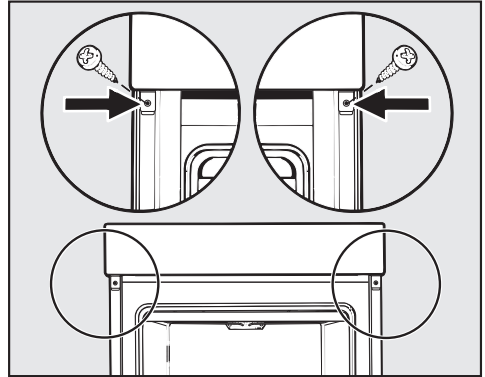

- Use the screws supplied to secure the combination steam oven to the side walls of the housing unit.
- Refit the door if necessary (see “Cleaning and care – Fitting the door”).

Installation

Electrical connection



Danger of injury!

Installation, repairs and other maintenance work by unqualified persons could be dangerous. Miele cannot be held liable for unauthorised work.

The appliance may only be connected to the mains electricity supply by a qualified electrician who is familiar with and complies with the national regulations and any additional regulations of the local electricity provider.

The appliance must be connected to an electrical system designed in accordance with VDE 0100.

Connection to a switched socket (in accordance with VDE 0701) is recommended as this provides easier access in the case of a service call.

If the appliance is **hardwired** or if the plug is not accessible, an additional means of disconnection must be provided for all poles.

Suitable means of disconnection include switches with an all-pole contact gap of at least 3 mm. These include circuit breakers, fuses and contactors (EN 60335).

Connection data is given on the data plate situated at the front of the oven compartment. Please ensure the connection data matches the household supply.

When contacting Miele, please quote the following:

- Model identifier
- Serial number

- Connection data (mains voltage/frequency/maximum rated load)

When replacing the cable supplied with another cable or changing the connection, only cable type H 05 VV-F with a suitable cross-sectional area (CSA) may be used.

Temporary or permanent operation on an autonomous power supply system or a power supply system that is not synchronised with the mains power supply (e.g. island networks, back-up systems) is possible. A prerequisite for operation is that the power supply system complies with the specifications of EN 50160 or an equivalent standard. The function and operation of the protective measures provided in the domestic electrical installation and in this Miele product must also be maintained in isolated operation or in operation that is not synchronised with the mains power supply, or these measures must be replaced by equivalent measures in the installation. As described, for example, in the current version of VDE-AR-E 2510-2.

Combination steam oven

The wires in the mains lead are coloured as follows:

Green/yellow = earth

Blue = neutral

Brown = live



WARNING - THIS APPLIANCE MUST BE EARTHED

For extra safety it is advisable to protect the appliance with a suitable residual current device (RCD).

Maximum connected load: see data plate.

Electrical connection: Other countries

All electrical work should be carried out by a suitably qualified and competent Miele approved service technician in strict accordance with local and national safety regulations.

Connection should be made via a fused connection unit or a suitable isolator, which complies with national and local safety regulations, and the on/off switch should be easily accessible after the appliance has been installed.

If the switch is not accessible after installation (depending on country) an additional means of disconnection must be provided for all poles.

Switches with a minimum all-pole contact gap of 3 mm are suitable for isolating the appliance. These include circuit breakers, fuses and protective devices.

The voltage and rated load are given on the data plate situated at the front of the combination steam oven interior. Please ensure that these match the household mains supply.

For extra safety it is advisable to install a suitable residual current device (RCD) / ground fault interrupter (GFI). Contact a qualified electrician for advice.

If the cord is damaged a new cord must be fitted by a Miele approved service technician.



**WARNING - THIS APPLIANCE
MUST BE EARTHED**

Hong Kong































This appliance is supplied with a power cord with plug for connection to a 230 V, 50 Hz socket outlet.





Taiwan

This appliance is supplied with a power cord with plug for connection to a 220 V, 60 Hz socket outlet.

Cooking charts

Vegetables











Vegetables		 [°C]	 5 1	 [min]
Cauliflower whole		100	3	20–40
Cauliflower florets		100	3	10
Beans, green		100	3	15
Broccoli florets		100	3	6
Peas		100	3	4–6
Fennel halved		100	3	20–28
Fennel cut into strips		100	3	6–8
Kohlrabi cut into batons		100	3	8–10
Pumpkin diced		100	3	4–6
Carrots whole		100	3	7–18
Carrots halved		100	3	7–9
Carrots chopped		100	3	6–10
New potatoes, waxy		100	3	28–44
Leeks sliced into rings		100	3	6–10
Romanesco whole		100	3	10–22
Romanesco florets		100	3	7–10
Brussels sprouts		100	3	12–18
Boiled potatoes peeled, whole		100	3	23–40
Boiled potatoes peeled, halved		100	3	20–30
Boiled potatoes peeled, quartered		100	3	16–25
Celeriac cut into batons		100	3	6–10
Asparagus, green		100	3	5–14
Asparagus, white, thick		100	3	13–19
Spinach		100	3	3–4
Savoy cabbage chopped		100	3	12–18
Courgettes sliced		100	3	3–4
Sugar snap peas		100	3	8–10

 Operating mode,  Temperature,  Shelf level,  Cooking duration,  Steam cooking









¹ Use a perforated cooking container and place the universal tray on shelf level 1 to collect the liquid.





Cooking charts

Fish

Fish (fresh or frozen)		 [°C]	 ⁵ ₁	 [min]
Perch fillet		100	3	8–10
Trout		100	3	10–13
Salmon fillet, 3 cm thick		100	3	6–10
Salmon trout		100	3	17–20
Plaice		100	3	8–14
Plaice fillet		100	3	3–5







Meat

Meat		 [°C]	 ⁵ ₁	 [min]
Chicken breast fillet		100	3	8–10
Turkey roulades		100	3	12–15
Turkey escalopes		100	3	4–6
Gammon slices		100	3	6–10









 Operating mode,  Temperature,  ⁵₁ Shelf level,  Cooking duration,  Steam cooking







¹ Use a perforated cooking container and place the universal tray on shelf level 1 to collect the liquid.

Dumplings

Dumplings		 [°C]	 ⁵ ₂	 [min]
Potato/bread dumplings, fresh		100	3	15
Potato/bread dumplings, boil in the bag		100	3	20

Rice

Rice			 [°C]	 ⁵ ₂	 [min]
Basmati rice	1 : 1.5		100	3	15
Parboiled rice	1 : 1.5		100	3	23–25
Pudding rice	1 : 2.5		100	3	30–35
Brown rice	1 : 1.5		100	3	25–30

 :  Ratio of rice to liquid,  Operating mode,  Temperature,  ⁵₁ Shelf level,  Cooking duration,  Steam cooking

² Use a solid cooking container.

Cooking charts

Batter

Cakes/biscuits (accessories)		Temperature [°C]	Booster 	Shelf level ⁵ 		Cooking duration [min]
				+HFC:	-HFC:	
Muffins (1 tray)		150–160	–	1	2	25–35
Muffins (2 trays)		150–160	–	1+3 ³	1+3	30–40 ⁴
Small cakes* (1 tray)		150	–	1	2	28–38
		160 ²	–	2	3	22–32
Small cakes* (2 trays)		150 ²	–	1+3 ³	1+3	25–35
Madeira cake (baking and roasting rack, loaf tin, 30 cm) ¹		150–160	–	1	2	60–70
		155–165 ²	–	1	2	60–70
Marble, nut cake (baking and roasting rack, loaf tin, 30 cm) ¹		150–160	–	1	2	55–65
		160–170	–	1	2	60–70
Marble, nut cake (baking and roasting rack, ring tin/Bundt cake tin, Ø 26 cm) ¹		150–160	–	1	2	50–60
		150–160	–	1	2	60–70
Fresh fruit cake (1 tray)		150–160	✓	1	2	35–45
		160–170	✓	1	2	45–55
Fresh fruit cake (baking and roasting rack, springform cake tin, Ø 26 cm) ¹		150–160	–	1	2	55–65
		165–175 ²	–	1	2	45–55
Flan base (baking and roasting rack, flan base tin, Ø 28 cm) ¹		150–160	–	1	2	25–35
		170–180 ²	–	1	2	15–25

Operating mode, Temperature, Booster, Shelf level (+HFC: with FlexiClip runners HFC 70-C / -HFC: without FlexiClip runners HFC 70-C), Cooking duration, Fan plus, Conventional heat, On, Off

* The settings also apply for testing in accordance with EN 60350-1.























¹ Use a dark coloured, matt baking tin and place it centrally on the baking and roasting rack.









² Pre-heat the oven before putting food inside.

³ Fit the FlexiClip runners HFC 70-C (if available) onto the bottom shelf level.

⁴ Take the trays out of the oven early if the food is sufficiently browned before the specified cooking duration has elapsed.

Shortcrust pastry

Cakes/biscuits (accessories)		Temperature [°C]		 5 1		Cooking duration [min]
				+HFC:	-HFC:	
Biscuits (1 tray)		140–150	–	1	2	25–35
		150–160	–	1	2	25–35
Biscuits (2 trays)		140–150	–	1+3 ³	1+3	25–35 ⁴
Drop cookies* (1 tray)		140	–	1	2	35–45
		160 ²	–	2	3	25–30
Drop cookies* (2 trays)		140	–	1+3 ³	1+3	40–50 ⁴
Flan base (baking and roasting rack, flan base tin, Ø 28 cm) ¹		150–160	–	1	2	35–45
		170–180 ²	–	1	2	20–30
Cheesecake (baking and roasting rack, springform cake tin, Ø 26 cm) ¹		170–180	–	1	2	75–85
		160–170	–	1	2	60–70
Apple pie* (baking and roasting rack, springform cake tin, Ø 20 cm) ¹		160	–	1	2	90–100
		180	–	1	1	85–95
Apple pie, double crust (baking and roasting rack, springform cake tin, Ø 26 cm) ¹		180–190 ²	–	1	2	60–70
		160–170	–	1	2	60–70
Fresh fruit cake, glazed (baking and roasting rack, springform cake tin, Ø 26 cm) ¹		170–180	–	1	2	60–70
		150–160	–	1	2	55–65
Fresh fruit cake, glazed (1 tray)		170–180	–	1	2	50–60
		160–170	–	1	2	45–55
Fruit flan (1 tray)		210–220 ²	✓	–	1	40–50
		190–200	–	–	1	30–40

 Operating mode,  Temperature,  Booster,  Shelf level (+HFC: with FlexiClip runners HFC 70-C / -HFC: without FlexiClip runners HFC 70-C),  Cooking duration,  Fan plus,  Eco Fan heat,  Conventional heat,  Intensive bake, ✓ On, – Off

* The settings also apply for testing in accordance with EN 60350-1.

¹ Use a dark coloured, matt baking tin and place it centrally on the baking and roasting rack.

² Pre-heat the oven before putting food inside.

³ Fit the FlexiClip runners HFC 70-C (if available) onto the bottom shelf level.

⁴ Take the trays out of the oven early if the food is sufficiently browned before the specified cooking duration has elapsed.

Cooking charts

Yeast dough

Cakes/biscuits (accessories)		Temperature [°C]	Booster 	Shelf level ⁵ 		Cooking duration [min]
				+HFC:	-HFC:	
Bundt cake (baking and roasting rack, Bundt cake tin, Ø 24 cm) ¹		150–160	–	1	2	50–60
		160–170	–	1	2	50–60
Stollen (1 tray)		150–160	–	1	2	55–65
		160–170	✓	1	2	55–65
Streusel cake with/without fruit (1 tray)		160–170	–	2	3	40–50
		170–180	–	2	3	50–60
Fresh fruit cake (1 tray)		160–170	✓	1	2	45–55
		170–180	✓	2	3	45–55
Apple turnovers/raisin whirls (1 tray)		160–170	✓	1	2	25–35
Apple turnovers/raisin whirls (2 trays)		160–170	✓	1+3 ³	1+3	30–40 ⁵
White bread, free-form (1 tray)		190–200	✓	1	2	30–40 ⁶
		190–200	–	1	2	30–40
White bread (baking and roasting rack, loaf tin, 30 cm) ¹		180–190	✓	1	2	30–40 ⁷
		190–200 ²	✓	1	2	30–40
Wholegrain bread (baking and roasting rack, loaf tin, 30 cm) ¹		190–200 ²	✓	1	2	55–65 ⁷
		200–210 ²	✓	1	2	45–55
Proving yeast dough (baking and roasting rack)		30–35	–	– ⁴	– ⁴	–

Operating mode, Temperature, Booster, Shelf level (+HFC: with FlexiClip runners HFC 70-C / -HFC: without FlexiClip runners HFC 70-C), Cooking duration, Fan plus, Conventional heat, Moisture plus, ✓ On, – Off

¹ Use a dark coloured, matt baking tin and place it centrally on the baking and roasting rack.

² Pre-heat the oven before putting food inside.

³ Fit the FlexiClip runners HFC 70-C (if available) onto the bottom shelf level.

⁴ Place the baking and roasting rack on the floor of the oven and stand the bowl containing the dough on the rack. Depending on the size of the bowl, you may need to remove the side runners.

⁵ Take the trays out of the oven early if the food is sufficiently browned before the specified cooking duration has elapsed.

⁶ Release 1 burst of steam at the beginning of the cooking process.

⁷ Release 2 bursts of steam at the beginning of the cooking process.

Quark dough

Cakes/biscuits (accessories)		Temperature [°C]	Booster	Shelf level		Cooking duration [min]
				+HFC:	-HFC:	
Fresh fruit cake (1 tray)		160–170	✓	1	2	40–50
		170–180	✓	2	3	50–60
Apple turnovers/raisin whirls (1 tray)		160–170	–	2	3	25–35
Apple turnovers/raisin whirls (2 trays)		150–160	✓	1+3 ¹	1+3	25–35 ²

Operating mode, Temperature, Booster, Shelf level (+HFC: with FlexiClip runners HFC 70-C / -HFC: without FlexiClip runners HFC 70-C), Cooking duration, Fan plus, Conventional heat, On, – Off

- ¹ Fit the FlexiClip runners HFC 70-C (if available) onto the bottom shelf level.
- ² Take the trays out of the oven early if the food is sufficiently browned before the specified cooking duration has elapsed.

Sponge mixture











Cakes/biscuits (accessories)		Temperature [°C]	Booster	Shelf level		Cooking duration [min]
				+HFC:	-HFC:	
Sponge cake base (2 eggs) (baking and roasting rack, springform cake tin, Ø 26 cm) ¹		160–170 ²	–	1	2	15–25
Sponge cake base (4–6 eggs) (baking and roasting rack, springform cake tin, Ø 26 cm) ¹		150–160 ²	–	1	2	30–40
Whisked sponge* (baking and roasting rack, springform cake tin, Ø 26 cm) ¹		180	–	1	2	25–35
		150–170 ²	–	1	2	25–45
Swiss roll sponge (1 tray)		180–190 ²	–	1	2	15–20









Operating mode, Temperature, Booster, Shelf level (+HFC: with FlexiClip runners HFC 70-C / -HFC: without FlexiClip runners HFC 70-C), Cooking duration, Fan plus, Conventional heat, On, – Off

- * The settings also apply for testing in accordance with EN 60350-1.
Fit the FlexiClip runners HFC 70-C (if available).
- ¹ Use a dark coloured, matt baking tin and place it centrally on the baking and roasting rack.
 - ² Pre-heat the oven before putting food inside.

Cooking charts

















Choux pastry, puff pastry, meringue











Cakes/biscuits (accessories)		Temperature [°C]	Booster 	Shelf level 		Cooking duration [min]
				+HFC:	-HFC:	
Choux buns (1 tray)		160–170	–	1	2	35–45 ²
Pastry puffs (1 tray)		180–190	–	1	2	20–30
Pastry puffs (2 trays)		180–190	–	1+3 ¹	1+3	20–30 ³
Macaroons (1 tray)		120–130	–	1	2	25–50
Macaroons (2 trays)		120–130	–	1+3 ¹	1+3	25–50 ³
Meringues/pavlovas (1 tray of 6, each Ø 6 cm)		80–100	–	1	2	120–150
Meringues/pavlovas (2 trays of 6, each Ø 6 cm)		80–100	–	1+3 ¹	1+3	150–180

 Operating mode,  Temperature,  Booster,  Shelf level (+HFC: with FlexiClip runners HFC 70-C / -HFC: without FlexiClip runners HFC 70-C),  Cooking duration,  Moisture plus,  Fan plus,  On, – Off

- ¹ Fit the FlexiClip runners HFC 70-C (if available) onto the bottom shelf level.
- ² Release 1 burst of steam 8 minutes into the cooking process.
- ³ Take the trays out of the oven early if the food is sufficiently browned before the specified cooking duration has elapsed.

Savoury dishes

Food (accessories)		Temperature [°C]	Booster 	Shelf level 		Cooking duration [min]
				+HFC:	-HFC:	
Savoury flan (1 tray)		220–230 ¹	✓	–	1	35–45
		180–190	–	–	1	30–40
Onion tart (1 tray)		180–190 ¹	✓	1	2	25–35
		170–180	–	1	2	30–40
Pizza, yeast dough (1 tray)		170–180	✓	1	2	25–35
		210–220 ¹	–	1	2	20–30
Pizza, quark dough (1 tray)		170–180	✓	1	2	25–35
		190–200 ¹	✓	2	2	25–35
Frozen pizza, pre-cooked (baking and roasting rack)		200–210	–	1	2	20–25
Toast* (baking and roasting rack)		250	–	–	3	5–8
Baked dishes/gratins (e.g. toast) (baking and roasting rack on universal tray)		250 ²	–	2	3	3–6
Grilled vegetables (baking and roasting rack on universal tray)		250 ²	–	3	4	5–10 ³
		250 ²	–	3	3	5–10 ³
Ratatouille (1 universal tray)		180–190	–	2	2	40–60

 Operating mode,  Temperature,  Booster,  Shelf level (+HFC: with FlexiClip runners HFC 70-C / -HFC: without FlexiClip runners HFC 70-C),  Cooking duration,  Conventional heat,  Intensive bake,  Fan plus,  Eco Fan heat,  Full grill,  Fan grill, ✓ On, – Off

* The settings also apply for testing in accordance with EN 60350-1.



















¹ Pre-heat the oven before putting food inside.











² Pre-heat the oven for 5 minutes before putting food inside.

³ If possible, turn the food halfway through the cooking duration.

Cooking charts

Beef

Food (accessories)		 [°C]		 5 1	 [min]	 10 [°C]
Braised beef, approx. 1 kg (oven dish with lid)	 2	150–160 ³	✓	2 ⁶	120–130 ⁷	–
	 2	170–180 ³	✓	2 ⁶	120–130 ⁷	–
	 2	180–190	–	2 ⁶	160–180 ⁸	–
Fillet of beef, approx. 1 kg (universal tray)	 2	180–190 ³	✓	2 ⁶	25–60	45–75
Fillet of beef (rare), approx. 1 kg ¹	 2	80–85 ⁴	–	2 ⁶	70–80	45–48
Fillet of beef (medium), approx. 1 kg ¹	 2	90–95 ⁴	–	2 ⁶	80–90	54–57
Fillet of beef (well done), approx. 1 kg ¹	 2	95–100 ⁴	–	2 ⁶	110–130	63–66
Roast beef, approx. 1 kg (universal tray)	 2	180–190 ³	✓	2 ⁶	35–65	45–75
Roast beef (rare), approx. 1 kg ¹	 2	80–85 ⁴	–	2 ⁶	80–90	45–48
Roast beef (medium), approx. 1 kg ¹	 2	90–95 ⁴	–	2 ⁶	110–120	54–57
Roast beef (well done), approx. 1 kg ¹	 2	95–100 ⁴	–	2 ⁶	130–140	63–66
Burger, meat patties* (baking and roasting rack on shelf level 4 and universal tray on shelf level 1)	 3	250 ⁵	–	4	1: 11–17 2: 7–10 ⁹	–

 Operating mode,  Temperature,  Booster,  Shelf level,  Cooking duration,  Core temperature,  Auto roast,  Conventional heat,  Eco Fan heat,  Full grill,
 ✓ On, – Off

* The settings also apply for testing in accordance with EN 60350-1.

¹ Use the baking and roasting rack and universal tray.

² Sear the meat on the hob first.

³ Pre-heat the oven before putting food inside.

⁴ Pre-heat the oven at 120 °C for 15 minutes. Reduce the temperature when you place the food in the oven.

⁵ Pre-heat the oven for 5 minutes before putting food inside.

⁶ Fit the FlexiClip runners HFC (if available).















⁷ Roast with the lid on to start with. Remove the lid 90 minutes into the cooking duration and add approx. 0.5 litres of liquid.









⁸ Roast with the lid on to start with. Remove the lid 100 minutes into the cooking duration and add approx. 0.5 litres of liquid.

⁹ Turn the food once it has browned sufficiently (1: grill duration side 1, 2: grill duration side 2).

¹⁰ If you are using a food probe, you can use the core temperature shown.

Veal



















Food (accessories)		 [°C]		 5 1	 [min]	 7 [°C]
Braised veal, approx. 1.5 kg (oven dish with lid)	 2	160–170 ³	✓	2 ⁵	120–130 ⁶	–
	 2	170–180 ³	✓	2 ⁵	120–130 ⁶	–
Fillet of veal, approx. 1 kg (universal tray)	 2	160–170 ³	✓	2 ⁵	30–60	45–75
Fillet of veal (pink), approx. 1 kg ¹	 2	80–85 ⁴	–	2 ⁵	50–60	45–48
Fillet of veal (medium), approx. 1 kg ¹	 2	90–95 ⁴	–	2 ⁵	80–90	54–57
Fillet of veal (well done), approx. 1 kg ¹	 2	95–100 ⁴	–	2 ⁵	90–100	63–66
Saddle of veal (pink), approx. 1 kg ¹	 2	80–85 ⁴	–	2 ⁵	80–90	45–48
Saddle of veal (medium), approx. 1 kg ¹	 2	90–95 ⁴	–	2 ⁵	100–130	54–57
Saddle of veal (well done), approx. 1 kg ¹	 2	95–100 ⁴	–	2 ⁵	130–140	63–66

 Operating mode,  Temperature,  Booster,  5
1 Shelf level,  Cooking duration,  Core temperature,  Auto roast,  Conventional heat, ✓ On, – Off

- ¹ Use the baking and roasting rack and universal tray.
- ² Sear the meat on the hob first.
- ³ Pre-heat the oven before putting food inside.
- ⁴ Pre-heat the oven at 120 °C for 15 minutes. Reduce the temperature when you place the food in the oven.
- ⁵ Fit the FlexiClip runners HFC (if available).
- ⁶ Roast with the lid on to start with. Remove the lid 90 minutes into the cooking duration and add approx. 0.5 litres of liquid.
- ⁷ If you are using a food probe, you can use the core temperature shown.

Cooking charts













Pork







Food (accessories)		 [°C]		 ⁵	 [min]	 ¹¹ [°C]
Pork joint/pork neck roast, approx. 1 kg (oven dish with lid)		160–170	✓	2 ⁵	140–150 ⁶	80–90
		170–180	✓	2 ⁵	130–140 ⁶	80–90
Pork joint with crackling, approx. 2 kg (oven dish)		180–190	✓	2 ⁵	140–160 ^{7,8}	80–90
		190–200	✓	2 ⁵	130–150 ⁸	80–90
Pork tenderloin, approx. 350 g ¹	 ²	90–100 ³	–	2 ⁵	70–90	60–69
Ham roast, approx. 1.5 kg (oven dish with lid)		160–170	–	2 ⁵	130–160 ⁹	80–90
Gammon joint, approx. 1 kg (universal tray)		160–170	✓	2 ⁵	55–65 ⁷	63–68
Gammon joint, approx. 1 kg ¹	 ²	95–105 ³	–	2 ⁵	140–160	63–66
Meat loaf, approx. 1 kg (universal tray)		170–180	✓	2 ⁵	60–70 ⁸	80–85
		190–200	✓	2 ⁵	70–80 ⁸	80–85
Bacon ¹		250 ⁴	–	4	3–5	–
Bratwurst ¹		220 ⁴	–	3 ⁵	8–15 ¹⁰	–

 Operating mode,  Temperature,  Booster,  ⁵ Shelf level,  Cooking duration,  ¹¹ Core temperature,  Auto roast,  Conventional heat,  Moisture plus,  Eco Fan heat,  Full grill, ✓ On, – Off

- ¹ Use the baking and roasting rack and universal tray.
- ² Sear the meat on the hob first.
- ³ Pre-heat the oven at 120 °C for 15 minutes. Reduce the temperature when you place the food in the oven.
- ⁴ Pre-heat the oven for 5 minutes before putting food inside.
- ⁵ Fit the FlexiClip runners HFC (if available).
- ⁶ Roast with the lid on to start with. Remove the lid 60 minutes into the cooking duration and add approx. 0.5 litres of liquid.
- ⁷ Over the cooking duration, release a burst of steam 3 times manually after the heating-up phase.
- ⁸ Add approx. 1 litre of liquid halfway through the cooking duration.
- ⁹ Roast with the lid on to start with. Remove the lid 100 minutes into the cooking duration and add approx. 0.5 litres of liquid.
- ¹⁰ Turn the food halfway through cooking.
- ¹¹ If you are using a food probe, you can use the core temperature shown.

Lamb, game















Food (accessories)		 [°C]		 5 1	 [min]	 6 [°C]
Leg of lamb on the bone, approx. 1.5 kg (oven dish with lid)		180–190	–	2 ⁴	100–120 ⁵	64–82
Saddle of lamb, off the bone (universal tray)	 ¹	180–190 ²	✓	2 ⁴	10–20	53–80
Saddle of lamb, off the bone (baking and roasting rack and universal tray)	 ¹	95–105 ³	–	2 ⁴	40–60	54–66
Saddle of venison, off the bone (universal tray)	 ¹	160–170 ²	–	2 ⁴	70–90	60–81
Roebuck saddle, off the bone (universal tray)	 ¹	140–150 ²	–	2 ⁴	25–35	60–81
Leg of wild boar, off the bone, approx. 1 kg (oven dish with lid)	 ¹	170–180	–	2 ⁴	100–120 ⁵	80–90











 Operating mode,  Temperature,  Booster,  Shelf level,  Cooking duration,  Core temperature,  Conventional heat, ✓ On, – Off

- ¹ Sear the meat on the hob first.
- ² Pre-heat the oven before putting food inside.
- ³ Pre-heat the oven at 120 °C for 15 minutes. Reduce the temperature when you place the food in the oven.
- ⁴ Fit the FlexiClip runners HFC (if available).
- ⁵ Roast with the lid on to start with. Remove the lid 50 minutes into the cooking duration and add approx. 0.5 litres of liquid.
- ⁶ If you are using a food probe, you can use the core temperature shown.

Cooking charts



Poultry, fish



Food (accessories)		 [°C]		 5 1	 [min]	 7 [°C]
Poultry, 0.8–1.5 kg (universal tray)		170–180	✓	2 ²	55–65	85–90
Chicken, approx. 1.2 kg (baking and roasting rack on universal tray)		180–190 ¹	–	2 ²	70–80 ³	85–90
Poultry, approx. 2 kg (oven dish)		180–190	✓	2 ²	100–115 ^{3,4}	85–90
Poultry, approx. 4 kg (oven dish)		160–170	✓	2 ²	180–200 ⁵	90–95
		180–190	✓	2 ²	180–200 ⁵	90–95
Fish, 200–300 g (e.g. trout) (universal tray)		170–180	✓	2 ²	25–35 ⁶	75–80
Fish, 1–1.5 kg (e.g. salmon trout) (universal tray)		170–180	✓	2 ²	35–45 ⁶	75–80
Fish fillet in foil, 200–300 g (universal tray)		200–210	–	2 ²	25–30	75–80

 Operating mode,  Temperature,  Booster,  Shelf level,  Cooking duration,  Core temperature,  Auto roast,  Fan grill,  Conventional heat,  Moisture plus,  Eco Fan heat, ✓ On, – Off

- ¹ Pre-heat the oven for 5 minutes before putting food inside.
- ² Fit the FlexiClip runners HFC (if available).
- ³ Turn the food half way through grilling.
- ⁴ Add approx. 0.25 litres of liquid at the start of the cooking process.
- ⁵ Add approx. 0.5 litres of liquid after 30 minutes.
- ⁶ Manually inject 1 burst of steam 5 minutes into the cooking process.
- ⁷ If you are using a food probe, you can use the core temperature shown.

Test food in accordance with EN 60350-1 (Steam cooking operating mode)



Test food	Cooking containers	Quantity [g]	 ⁵ ₁	 ² [°C]	 [min]
Steam replenishment					
Broccoli (8.1)	1 x DGGL 12	Max.	2	100	6
Steam distribution					
Broccoli (8.2)	1 x DGGL 20	300	2	100	6
Appliance capacity					
Peas (8.3)	1x DGGL 20	800	4	100	30 ³
	1x DGGL 12	1600	2		

 ⁵₁ Shelf level,  ² Temperature,  ³ Cooking duration

- ¹ Remove the FlexiClip runners if fitted.
- ² Place the test food in a cold oven compartment (before the heating-up phase begins) and place the universal tray on shelf level 1.
- ³ The test is finished when the temperature measures 85 °C in the coolest place.

Notes for test institutes

Menu cooking test food (Steam cooking operating mode)

Test food	Cooking containers	Quantity [g]	 5 1	 [°C]	Height [cm]	 [min] ²
Potatoes, waxy, quartered	1 x DGGL 20	400	4	100	–	37
Salmon fillet, frozen, not defrosted	1 x DGGL 20	2 x 150	2	100	≥ 2.5 ≤ 3.0	(22)
Broccoli florets	1 x DGGL 20	300	4	100	–	(16)

 5 Shelf level,  Temperature,  Cooking duration

- ¹ Remove the FlexiClip runners if fitted.
- ² The cooking duration for the first test food corresponds to the cooking duration for the whole menu. If you want to set a minute minder as a reminder, set the time left until the next test food is to be added in each case (see “Min. minder”).

- Place the universal tray on shelf level 1.
- Place the first test food (potatoes) in a cold oven compartment.
- Select the Steam cooking  operating mode and set the temperature.
- Set the cooking duration for the potatoes and the whole menu (37 minutes).

Once the set temperature is reached, an audible signal will sound and the cooking duration will appear on the display.















 Risk of injury caused by hot steam.











When using a cooking process involving steam, a lot of hot steam can escape if the door is opened. The steam can cause burns.

Step back and wait until the hot steam has dissipated.

- As soon as a time left of 22 minutes displayed, place the second test food (salmon fillet) in the oven compartment.
- As soon as a time left of 16 minutes displayed, place the third test food (broccoli florets) in the oven compartment.
- After cooking, select the  sensor control to end the cooking process.
- Take the food out of the oven compartment.

Test food in accordance with EN 60350-1 (oven operating modes)

Test food (accessories)		Temperature [°C]		Shelf level ^{5 6}		Cooking duration [min]
				+HFC	-HFC	
Small cakes (1 baking tray ¹)		150	–	1	2	28–38
		160 ⁴	–	2	3	22–32
Small cakes (2 baking trays ¹)		150 ⁴	–	1+3 ⁷	1+3	25–35
Drop cookies (1 baking tray ¹)		140	–	1	2	35–45
		160 ⁴	–	2	3	25–30
Drop cookies (2 baking trays ¹)		140	–	1+3 ⁷	1+3	40–50 ⁸
Apple pie (baking and roasting rack ¹ , springform cake tin ² , Ø 20 cm)		160	–	1	2	90–100
		180	–	1	1	85–95
Whisked sponge (baking and roasting rack ¹ , springform cake tin ² , Ø 26 cm)		180	–	1	2	25–35
		150–170 ⁴	–	1	2	25–45
Toast (baking and roasting rack ¹)		250	–	–	3	5–8
Burger (baking and roasting rack ¹ on shelf level 4 and universal tray ¹ on shelf level 1)		250 ⁵	–	–	4	18–27 ⁹

 Operating mode,  Temperature,  Booster,  Shelf level (+HFC: with FlexiClip runners HFC 70-C / -HFC: without FlexiClip runners HFC 70-C),  Cooking duration,  Fan plus,  Conventional heat,  Full grill,  On,  Off

- ¹ Only use original Miele accessories.
- ² Use a dark-coloured, matt springform cake tin.
Place the springform cake tin centrally on the baking and roasting rack.
- ³ In general, if a range of temperatures is given, it is best to select the lower temperature and to check the food after the shortest cooking duration.
- ⁴ Pre-heat the oven before putting food inside.
- ⁵ Pre-heat the oven for 5 minutes before putting food inside.
- ⁶ Fit the FlexiClip runners HFC 70-C (if available).
- ⁷ Fit the FlexiClip runners HFC 70-C (if available) onto the bottom shelf level. If you have several pairs of FlexiClip runners, fit only one pair.
- ⁸ Take the trays out of the oven early if the food is sufficiently browned before the specified cooking duration has elapsed.
- ⁹ Turn the food halfway through cooking.

Notes for test institutes

Energy efficiency class according to EN 60350-1

The energy efficiency class is determined in accordance with EN 60350-1.

Energy efficiency class: A+

Please observe the following when conducting testing:

- Testing is undertaken using the Eco Fan heat  function.
- Select the Lighting | "On" for 15 seconds setting (see "Settings – "Lighting").
- Only accessories that are required for testing should be in the oven compartment during tests.
Do not use other accessories that might be available such as FlexiClip runners or catalytic enamelled panels (e.g. side panels or roof liners).
- An important pre-condition for determining the energy efficiency class is that the door must be tightly shut during testing.
Depending on which measurement devices are used, the functioning of the door seal can be affected to a greater or lesser extent. This will have a negative impact on the test results.
Pushing against the door will compensate for this. In certain unfavourable circumstances, suitable technical aids may also be necessary for this. This issue does not occur in normal use.

Data sheet for household ovens

In acc. with delegated regulation (EU) No. 65/2014 and regulation (EU) No. 66/2014

MIELE	
Model name/identifier	DGC 7250
Energy efficiency index/cavity (EEI _{cavity})	81,7
Energy efficiency class/cavity	
A+++ (most efficient) to D (least efficient)	A+
Energy consumption per cycle for each cavity in conventional mode	1,05 kWh
Energy consumption per cycle for each cavity in fan-forced convection mode	0,71 kWh
Number of cavities	1
Heat source(s) per cavity	electric
Volume of cavity	76 l
Mass of the appliance	42,0 kg

Frequency range of the WiFi module	2.4000–2.4835 GHz
Maximum transmission power of the WiFi module	< 100 mW

EU Conformity declaration

Miele hereby declares that this oven complies with Directive 2014/53/EU.

The complete text of the EU declaration of conformity is available from one of the following internet addresses:

- Products, Download from www.miele.ie
- For service, information, operating instructions etc: go to <https://miele.co.uk/> manuals and enter the name of the product or the serial number

UK Conformity declaration

Miele hereby declares that this oven complies with UK Radio Equipment Regulations 2017, as amended.

The complete text of the UK declaration of conformity is available from one of the following internet addresses:

- Products, Download from www.miele.co.uk
- For service, information, operating instructions etc: go to <https://miele.co.uk/> manuals and enter the name of the product or the serial number

This **Statement of Compliance** confirms this Miele product fully complies with the **Product Security and Telecommunications Infrastructure (Security Requirements for Relevant Connectable Products) Regulations 2023**.

- 1) Household Appliance – *Oven for building-in; DB60R1-00W, DB60R2-00W*
- 2) Manufactured by: Miele & Cie KG,
Carl Miele Street 29, 33332 Gutersloh Germany
Imported by and contact point: Miele Company Ltd, Fairacres, Marcham Road,
Abingdon, Oxon, OX14 ITW Great Britain
- 3) The defined support period at the time of first supply is 10 years
- 4) To report vulnerabilities and cybersecurity issues please contact: psirt@miele.com
- 5) Signature 
Name: **Paul Wright**
Company Position: **Head of Technical Management**
Date of signature: **19th March 2024**
Place of signature: **Abingdon, Oxfordshire**

Copyrights and licences for the communication module

For the purpose of operating and controlling the communication module, Miele uses proprietary or third-party software that is not covered by open source licensing terms. These items of software/software components are protected by copyright. The copyrights held by Miele and third parties must be respected.

Furthermore, this communication module contains software components which are distributed under open source licence conditions. The open source components contained in the appliance along with the corresponding copyright notices, copies of the licensing terms valid at the time, and any further information can be accessed locally via IP using a web browser (*http://<IP address>/Licenses*). The liability and warranty arrangements for the open source licences displayed in this location only apply in relation to the respective rights holders.

United Kingdom

Miele Co. Ltd., Fairacres, Marcham Road, Abingdon, Oxon, OX14 1TW
Tel: 0330 160 6600, Internet: www.miele.co.uk, E-mail: info@miele.co.uk

Australia

Miele Australia Pty. Ltd.
ACN 005 635 398
ABN 96 005 635 398
Level 4, 141 Camberwell Road
Hawthorn East, VIC 3123
Tel: 1300 464 353
E-mail: info@miele.com.au
Internet: www.miele.com.au

China Mainland

Miele Electrical Appliances Co., Ltd.
1-3 Floor, No. 82 Shi Men Yi Road
Jing' an District
200040 Shanghai, PRC
Tel: +86 21 6157 3500
Fax: +86 21 6157 3511
E-mail: info@miele.cn
Internet: www.miele.cn

Hong Kong, China

Miele (Hong Kong) Ltd.
41/F - 4101, Manhattan Place
23 Wang Tai Road
Kowloon Bay, Hong Kong
Tel: (852) 2610 1025
Fax: (852) 3579 1404
E-mail:
customerservices@miele.com.hk
Website: www.miele.hk

India

Miele India Pvt. Ltd.
1st Floor, Copia Corporate Suites,
Commercial Plot 9, Mathura Road,
Jasola, New Delhi - 110025
E-mail: customercare@miele.in
Website: www.miele.in

Ireland

Miele Ireland Ltd.
2024 Bianconi Avenue
Citywest Business Campus
Dublin 24
Tel: (01) 461 07 10
Fax: (01) 461 07 97
E-mail: info@miele.ie
Internet: www.miele.ie

Malaysia

Miele Sdn Bhd
Suite 12-2, Level 12
Menara Sapura Kencana
Petroleum
Solaris Dutamas No. 1
Jalan Dutamas 1
50480 Kuala Lumpur, Malaysia
Phone: +603-6209-0288
Fax: +603-6205-3768

New Zealand

Miele New Zealand Limited
IRD 98 463 631
8 College Hill
Freemans Bay, Auckland 1011
Tel: 0800 464 353
E-mail: customercare@miele.co.nz
Internet: www.miele.co.nz

Singapore

Miele Pte. Ltd.
29 Media Circle
#11-04 ALICE@Mediapolis
Singapore 138565
Tel: +65 6735 1191
Fax: +65 6735 1161
E-mail: info@miele.com.sg
Internet: www.miele.sg

South Africa

Miele (Pty) Ltd.
63 Peter Place, Bryanston 2194
P.O. Box 69434, Bryanston 2021
Tel: (011) 875 9000
Fax: (011) 875 9035
E-mail: info@miele.co.za
Internet: www.miele.co.za

Thailand

Miele Appliances Ltd.
BHIRAJ TOWER at EmQuartier
43rd Floor Unit 4301-4303
689 Sukhumvit Road
North Klongton Sub-District
Vadhana District
Bangkok 10110, Thailand

United Arab Emirates

Miele Appliances Ltd.
Showroom 1, Eiffel 1 Building
Sheikh Zayed Road, Umm Al Sheif
P.O. Box 114782 - Dubai
Tel. +971 4 3044 999
Fax. +971 4 3418 852
800-MIELE (64353)
E-mail: info@miele.ae
Website: www.miele.ae

Manufacturer: Miele & Cie. KG, Carl-Miele-Straße 29, 33332 Gütersloh, Germany

DGC 7250

en-GB

M.-Nr. 12 821 970 / 00