

## Operating and installation instructions Rangehood



To prevent the risk of accidents or damage to the appliance, it is **essential** to read these instructions before it is installed and used for the first time.

# Contents

---

<b>Warning and Safety instructions</b> .....	<b>3</b>
<b>Caring for the environment</b> .....	<b>10</b>
<b>Description of the functions</b> .....	<b>11</b>
<b>Guide to the rangehood</b> .....	<b>12</b>
<b>Operation</b> .....	<b>14</b>
Switching the fan on .....	14
Selecting a power level .....	14
Run-on time .....	14
Switching the fan off .....	14
Switching the cooktop lighting on/off .....	14
Power management .....	15
Switching Power management on/off .....	15
Safety switch-off .....	15
<b>Energy saving tips</b> .....	<b>16</b>
<b>Cleaning and care</b> .....	<b>17</b>
Housing .....	17
Important for appliances with lacquered casing .....	17
Grease filter .....	18
Change grease filters .....	19
NoSmell active charcoal filters .....	20
Disposing of the charcoal filters .....	20
Reactivatable charcoal filters .....	20
<b>Service</b> .....	<b>21</b>
Contact in case of fault .....	21
Position of the data plate .....	21
Warranty .....	21
<b>Installation</b> .....	<b>22</b>
Before installation .....	22
Installation recommendations .....	22
Installation materials .....	22
Installation materials for recirculation mode .....	23
Appliance dimensions .....	24
Safety distance (S) .....	27
Installing the depth stops (optional) .....	28
Connection for air extraction .....	30
Non-return flap .....	31
Condensed water .....	31
Silencer .....	32
Electrical connection .....	33
<b>Technical data</b> .....	<b>34</b>
Optional accessory for recirculation mode .....	34

## Warning and Safety instructions

This rangehood complies with all relevant local and national safety requirements. However, inappropriate use can lead to personal injury and damage to property.

Read the operating and installation instructions carefully before using the rangehood. They contain important information on the safety, installation, use and maintenance of the appliance. This prevents both personal injury and damage to the rangehood.

In accordance with standard IEC 60335-1, Miele expressly and strongly advises that you read and follow the instructions in "Installation" and in the "Warning and Safety instructions".

Miele cannot be held liable for injury or damage caused by non-compliance with these instructions.

Keep these instructions in a safe place and pass them on to any future owner.

### Correct application

► This rangehood is designed for domestic use and for use in similar environments by guests in hotel or motel rooms, bed & breakfasts and other typical living quarters. This does not include common/shared facilities or commercial facilities within hotels, motels or bed & breakfasts.

► The appliance is not suitable for outdoor use.

► It must only be used to extract vapours and remove odours from cooking.

Any other usage is at the owner's risk. Miele cannot be held liable for damage resulting from incorrect or improper use or operation.

► The rangehood cannot be used to ventilate the room in which it is installed in recirculation mode above a gas cooktop. Please seek the advice of a qualified gas fitter for more information if necessary.

► This appliance is not intended for use by persons (including children) with reduced physical, sensory or mental capabilities, or lack of experience and knowledge, unless they have been given supervision or instruction concerning its use by a person responsible for their safety, and are able to recognise the dangers of misuse.

# Warning and Safety instructions

---

## Safety with children

- ▶ Young children must not be allowed to use the rangehood.
- ▶ Older children may only use the rangehood if its operation has been clearly explained to them and they are able to use it safely. They must be able to understand and recognise the possible dangers caused by incorrect operation.
- ▶ Cleaning work may only be carried out by older children under the supervision of an adult.
- ▶ Children should be supervised near the appliance. Ensure that they do not play with the appliance.
- ▶ The cooktop lighting is very intense. Ensure, in particular, that babies/small children do not look directly at the light.
- ▶ Danger of suffocation! Children may be able to wrap themselves in packing material or pull it over their heads with the risk of suffocation. Keep children away from any packing material.

## Technical safety

- ▶ Repairs and other work by unqualified persons could be dangerous. Installation, maintenance work and repairs to electrical appliances must only be carried out by a Miele approved service technician.
- ▶ A damaged appliance can be dangerous. Check it for visible signs of damage. Do not use a damaged appliance.
- ▶ The electrical safety of this appliance can only be guaranteed when continuity is complete between it and an effective earthing system. It is most important that this basic safety requirement is present and tested regularly and, where there is any doubt, the household wiring system should be inspected by a qualified electrician.
- ▶ The connection data (voltage and frequency) on the data plate of the rangehood must match the mains electricity supply in order to avoid the risk of damage to the rangehood. Compare this before connecting the appliance to the mains electricity. If in doubt, consult a qualified electrician.

## Warning and Safety instructions

---

▶ Temporary or permanent operation with a self-sufficient or non-mains synchronous energy supply system (e.g. isolated networks, back-up systems) is possible. A requirement for the operation is that the energy supply system complies with all current local and national requirements that apply to stand-alone, solar and/or battery systems. The protective measures provided in the installation and in this Miele product must also be assured in their function and operation in isolated operation or in non-mains synchronous operation, or replaced with equivalent measures in the installation.

▶ Do not connect the appliance to the mains electricity supply by a multi-socket unit or an extension lead. Extension leads are a fire hazard and do not guarantee the required safety of the appliance.

▶ For safety reasons, this appliance may only be used after it has been built in.

▶ This rangehood must not be installed and operated in mobile installations (e.g. on a ship).

▶ Tampering with electrical connections or components and mechanical parts is highly dangerous to the user and can cause operational faults.

Only open the housing as described in the instructions given in the installation sheet and in the “Cleaning and care” section of this booklet. Under no circumstances should any other parts of the housing be opened.

▶ During installation, maintenance and repair work, the appliance must be disconnected from the mains electricity supply. It is only completely isolated from the electricity supply when:

- the mains circuit breaker is switched off, or
- it is switched off at the wall socket and the plug is withdrawn from the socket. Do not pull the mains connection cable but the mains plug to disconnect your appliance from the mains electricity supply.

▶ The manufacturer's warranty will be invalidated if the appliance is not repaired by a Miele authorised service technician.

▶ If the mains connection cable is damaged, it must only be replaced by a Miele authorised service technician or suitably qualified and competent electrician in order to avoid a hazard.

▶ The lamps are a built-in component of the lighting. Replacement lamps may only be installed by a Miele authorised technician.

# Warning and Safety instructions

Using at the same time as other heating appliances that depend on the air from the room

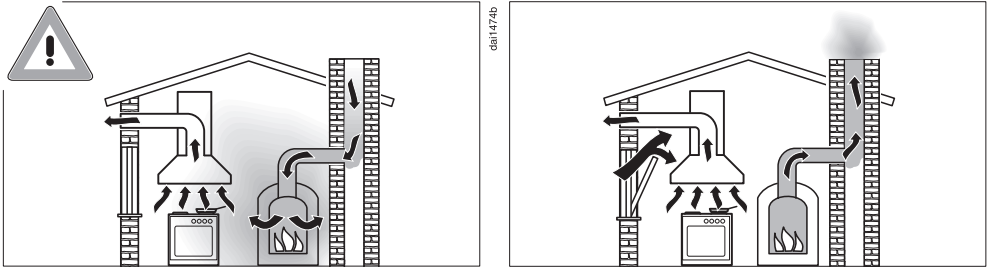

## ⚠ Danger of toxic fumes!

Great care should be taken when using the rangehood in the same room or the same area of the house as another heating appliance that depends on the air from the room.

Such heating appliances draw in air from the room and duct exhaust gases out through a chimney or extraction ducting. They include gas, oil, wood and coal-fired boilers and heaters, continuous flow or other water heaters, gas cooktops and ovens.

The rangehood draws in air from the kitchen and from neighbouring rooms. This applies to the following modes of operation:

- extraction mode
- recirculation mode with a recirculation box installed outside the room.

If there is insufficient air, an underpressure will occur. The heating appliance may be starved of oxygen. This impairs combustion. Harmful gases could be drawn from the chimney or extraction ducting back into the room.

This could have potentially fatal consequences. Risk of death!

## Warning and Safety instructions

In order to ensure safe operation and to prevent gases given off by a heating appliance from being drawn back into the room, when the rangehood and the heater are both operated simultaneously, an underpressure in the room of 0.04 mbar (4 Pa) is the maximum permissible.

Sufficient ventilation can be maintained by air inlets which cannot be blocked, e.g. in windows, doors and outside wall vents. The diameter of the inlet openings must enable sufficient ventilation. A ventilation brick alone is not generally sufficient to ensure safe ventilation.

The overall ventilation condition of the dwelling must be taken into account. If in any doubt, the advice of a competent builder or, for gas, a qualified gas fitter (registered with an official gas safety body in accordance with national safety regulations) must be sought.

If the rangehood is being operated in recirculation mode, whereby the air is redirected into the room in which it is installed, the above restrictions do not apply.

### Correct use

► Open flames are a fire hazard!

Never use an open flame under the rangehood. To avoid the danger of fire, do not flambé or grill over an open flame. When switched on, the rangehood could draw flames into the filter. Kitchen grease deposits could ignite.

► The rangehood can become damaged when exposed to excessive heat.

- When using the rangehood over a gas cooktop, ensure that any burners in use are always covered by a pan. Switch the cooking zone off when a pan is removed, even for a short time.
- Select a pan which is suitable for the size of the burner.
- Regulate the flame so that it does not burn up the sides of the pan.
- Avoid overheating the pan (e.g. when cooking with a wok).

► Always switch the rangehood on when a cooking zone is in use, otherwise condensation may collect in the rangehood, which could cause corrosion.

## Warning and Safety instructions

---

▶ Overheated oil and fat can ignite, causing fire damage to the rangehood.

When cooking with oil or fat, chip pans and deep fat fryers etc., do not leave the pans unattended. Similarly, never leave an open grill unattended when grilling.

▶ Do not use the rangehood without the filters in place. This way you will avoid the risk of grease and dirt getting into the appliance and hindering its smooth operation.

▶ The rangehood can get very hot during cooking due to heat rising from the cooktop.

Do not touch the housing or the grease filters until the rangehood has cooled down.

### Correct installation

▶ To determine whether a rangehood may be operated above your cooking appliance, please refer to the information provided by the appliance's manufacturer.

▶ Safety regulations prohibit the fitting of a rangehood over solid fuel stoves.

▶ An insufficient safety distance between the stovetop and the rangehood can result in damage to the rangehood.

The minimum safety distances between the top of the cooktop and the bottom of the rangehood given in the "Installation" section of these instructions must be observed, unless the cooktop manufacturer states that a greater safety distance is required.

If more than one cooking appliance is fitted beneath the rangehood, and they have different minimum safety distances to the rangehood, select the greater distance.

▶ The information provided in "Installation" must be observed when installing the rangehood.

▶ There may be a risk of injury due to protruding parts and sharp edges.

Wear gloves that offer protection against cuts during assembly.

▶ All ducting, pipework and fittings must be of non-flammable material and comply with all relevant national and local building regulations.



## Warning and Safety instructions

---

- ▶ The appliance must not be connected to a chimney or vent flue which is in current use for exhausting fumes from appliances burning gas or other fuels. Neither should it be connected to ducting which ventilates rooms with fireplaces.
- ▶ If exhaust air is to be extracted into a chimney or ventilation duct no longer used for other purposes, seek professional advice.

### Cleaning and care

- ▶ There is a risk of fire if cleaning is not carried out as described in these operating instructions.
- ▶ Do not use a steam cleaning appliance to clean this appliance. The steam could reach electrical components and cause a short circuit.

### Accessories and spare parts

- ▶ Use only genuine original Miele spare parts. If spare parts or accessories from other manufacturers are used, the warranty will be invalidated, and Miele cannot accept liability.
- ▶ Faulty components must only be replaced by genuine Miele spare parts. The manufacturer can only guarantee the safety of the appliance when Miele replacement parts are used.
- ▶ Miele will guarantee to supply functional spare parts for a minimum of 10 years and up to 15 years following the discontinuation of your appliance.

# Caring for the environment

---

## Disposal of the packing material

The transport and protective packaging has been selected from materials which are environmentally friendly for disposal, and can normally be recycled.

Recycling the packaging reduces the use of raw materials in the manufacturing process and also reduces the amount of waste in landfill sites.

Ensure that any plastic wrappings, bags etc. are disposed of safely and kept out of the reach of babies and young children. Danger of suffocation.

## Disposing of your old appliance

Electrical and electronic appliances often contain valuable materials. They also contain specific materials, compounds and components, which were essential for their correct function and safety. These could be hazardous to human health and to the environment if disposed of with your domestic waste or if handled incorrectly. Please do not, therefore, dispose of your old appliance with your household waste.



Please dispose of it at your local community waste collection / recycling centre for electrical and electronic appliances. You are also responsible for deleting any personal data that may be stored on the appliance prior to disposal. Please ensure that your old appliance poses no risk to children while being stored prior to disposal.

## Description of the functions

Depending on the model of the rangehood, the following options are available:

### Air extraction mode



The air is drawn in and cleaned by the grease filter and directed outside.

### Recirculation mode

(available as an optional accessory with a conversion kit and charcoal filters: see “Technical Data”)



The air is drawn in and cleaned first by the grease filter and then by charcoal filters. The cleaned air is then recirculated back into the kitchen.

clh001941a

clh001941b

# Guide to the rangehood

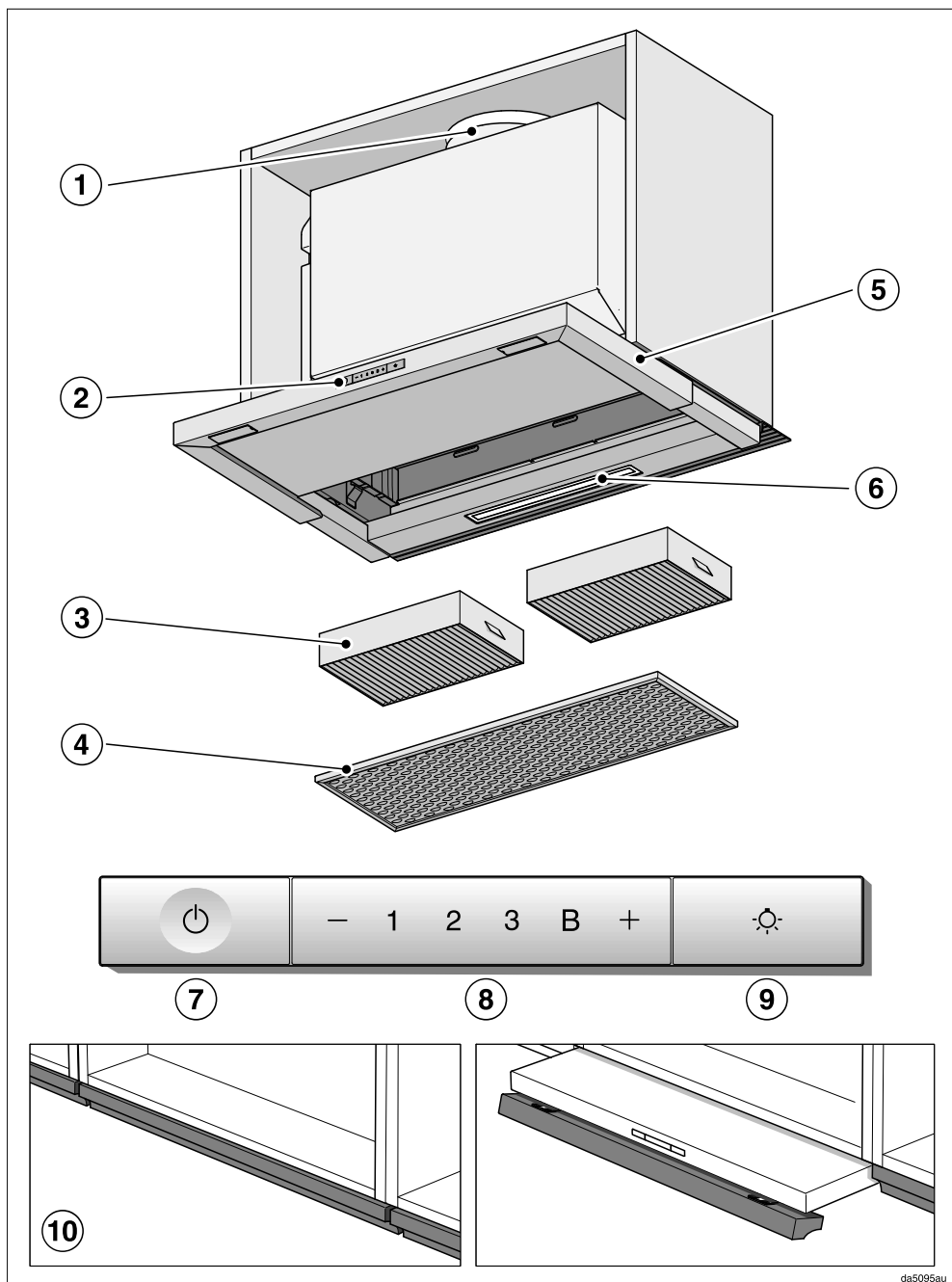

da5095au

- ① Exhaust connection
- ② Control panel
- ③ Charcoal filter  
Single-use or reactivatable charcoal filters  
Optional accessory for recirculation mode
- ④ Grease filter
- ⑤ Pull-out deflector plate
- ⑥ Cooktop lighting
- ⑦ On/Off touch control for the fan
- ⑧ Touch controls for selecting the fan power level
- ⑨ Touch control for switching the cooktop lighting on and off
- ⑩ Foldable front panel  
The front of the deflector plate can be fitted with a front panel matching your furniture fronts. The DML 2000 kit is required for this (accessories can be purchased separately).

# Operation

---

## Switching the fan on

Switch the fan on as soon as you start cooking. This is to ensure that vapours are captured right from the start.

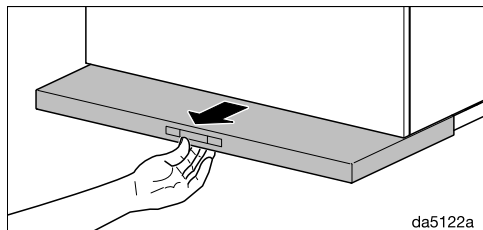

- Pull out the deflector plate. To ensure optimum extraction and a low noise level, pull the canopy all the way out.

The fan will switch on at power level **2**.

## Selecting a power level

For light to heavy cooking vapours and odours, select from power levels **1** to **3**.

For short periods of cooking food with intensive vapours and a strong aroma, e.g. when searing meat, select Booster setting **B**.

- Select the power level you want by pressing the **-** or **+** controls.

## Reducing power down from the Booster setting

If Power management is activated (default setting), the fan automatically switches back to level **3** after 5 minutes.

## Run-on time

- It is advisable to run the fan for a few minutes after cooking has finished.

This helps to remove any lingering vapours and odours from the air.

It also reduces the risk of residues accumulating in the rangehood and any resultant odours.

## Switching the fan off

- Turn off the fan by pushing the deflector plate back in. The next time the deflector plate is pulled out, the range hood will switch on at setting **2** again.
- Press the On/Off touch control  to switch the fan off.

## Switching the cooktop lighting on/off

The cooktop lighting can be switched on and off independently of the fan.

- You can switch the cooktop lighting on and off by pulling the deflector plate out and pushing it in or by pressing the lighting control .

The  symbol will light up when the cooktop lighting is switched on.

## Power management



The rangehood is fitted with a Power management system. The Power management system is designed to help save energy. It ensures that the fan power level is reduced automatically and that the lighting is switched off.

- If the Booster setting has been selected, the fan will automatically switch to setting 3 after 5 minutes.
- From fan power levels 3, 2 and 1, the power will be reduced by one level after 2 hours and then in 30-minute stages until the fan finally switches off.
- The cooktop lighting will switch off automatically after 12 hours.

## Switching Power management on/off

You can deactivate the Power management.

Keep in mind that this may increase energy consumption.

- To set this option, both the fan and the cooktop lighting must be switched off.
- Press the — and + controls at the same time for approx. 10 seconds, until **1** lights up.
- Then press in turn:
  - the lighting control ,
  - then the — touch control, and
  - the lighting control  again.

If Power management is switched on, the **1** and **B** indicators light up constantly.

When it is switched off, the **1** and **B** indicators flash.

- Press — to switch Power management off.

The **1** and **B** indicators will flash.

- To switch it on, press +.

The **1** and **B** indicators will light up constantly.



- Confirm your choice with the On/Off control .

All the indicator lights will go out.

If you don't confirm your selection within 4 minutes, the rangehood will automatically revert to the previous setting.

## Safety switch-off

If Power management has been deactivated, the rangehood will switch itself off automatically after 12 hours if it has been left on (fan and cooktop lighting).

- To switch it back on press the On/Off  control or the lighting control .

## Energy saving tips

---

This rangehood operates very efficiently and economically. The following will help you to save even more energy when using it:

- Ensure that there is sufficient ventilation in the kitchen when cooking. In extraction mode, if there is insufficient air flow the rangehood cannot operate efficiently and this causes increased operating noise levels.
- Always cook with the lowest possible setting. This produces fewer cooking vapours, so you can use a lower rangehood power level and therefore benefit from reduced energy consumption.
- Check the power level selected on the rangehood. A lower power level is generally sufficient for the majority of cooking. Only use the Booster setting when necessary.
- When a large volume of cooking vapours are being produced, switch to a high power level in good time. This is more efficient than operating the rangehood for longer to try to capture cooking vapours which have already been distributed throughout the kitchen.
- Make sure that you switch the rangehood off after use.
- Clean or change the filters at regular intervals. Heavily soiled filters reduce performance, increase the risk of fire and are unhygienic.



 Before carrying out any maintenance or cleaning, the rangehood must be disconnected from the electricity supply (see “Warning and Safety instructions”).

## Housing

### General information

Unsuitable cleaning agents can damage the surfaces and control elements.

Do not use any cleaning agents containing soda, acid, chloride, or solvent.

Do not use any abrasive cleaning agents, e.g. powder cleaners or cream cleaners and abrasive sponges, or pot scourers or sponges which have been used previously with abrasive cleaning agents.

 Moisture in the rangehood can cause damage. Make sure that water does not get into the rangehood.

- Clean all surfaces and control elements using a small amount of warm water and dishwashing liquid. Apply with a soft sponge.
- After cleaning, wipe the surfaces dry using a soft cloth.

### Important information for appliances with stainless steel surfaces

This information does not apply to the control elements.

Stainless steel surfaces can be cleaned with a non-abrasive cleaning agent designed specifically for use on stainless steel.

To prevent the surfaces from quickly becoming dirty again, we recommend treating them with a stainless steel care product (available from Miele).

### Important for appliances with lacquered casing

Minor scratches on the surface are inevitable when cleaning the casing; they may be visible depending on the lighting in the kitchen.

### Important information for the control elements

If soiling is not removed promptly, it could cause the control elements to alter or discolor. Remove any soiling immediately.

The surface of the control elements can be damaged if they are cleaned using stainless steel cleaning agents. Do not use stainless steel cleaning agents on the control elements.

# Cleaning and care

## Grease filter

 Fire hazard!

An oversaturated grease filter is a fire hazard.

Clean the grease filter at regular intervals.

The re-usable metal grease filter in the appliance removes solid particles from the kitchen vapours (grease, dust, etc.), preventing soiling of the rangehood.

The grease filter must be cleaned at regular intervals.

A heavily soiled grease filter hinders air extraction and will lead to increased levels of soiling in the rangehood and in the kitchen.

## Grease filter cleaning intervals

Accumulated grease solidifies over a longer period of time and makes cleaning more difficult. The grease filter should therefore be cleaned at least every 3 to 4 weeks.

## Removing the grease filter

 When handling the grease filter, be careful not to drop it.

This can result in damage to the filter and the cooktop below.

Make sure you hold the filter securely at all times when handling it.

- Pull out the deflector plate.

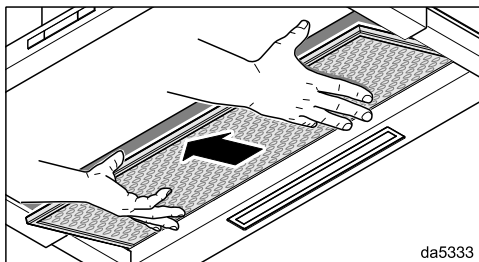
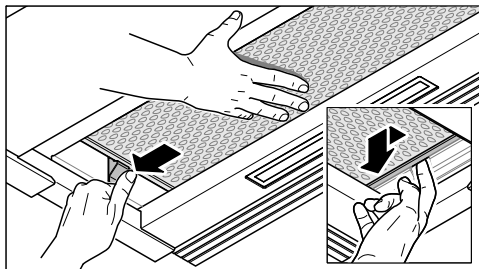

- Support the grease filter with your right hand. Press down on the lock on the left-hand side. The filter slides down.
- Push the grease filter from the right-hand side slightly to the left.
- Pull the grease filter down to remove it.

## Cleaning the grease filter by hand

- Clean the grease filter with a soft nylon brush in a mild solution of hot water and a small amount of washing-up liquid. Do not use undiluted washing-up liquid.

## Unsuitable cleaning agents

Unsuitable cleaning agents can cause damage to the surface of the filters if used regularly.

Do not use:

- cleaning agents containing descaling agents,
- powder cleaners or cream cleaners,
- aggressive all-purpose cleaning agents or spray cleaners for grease,
- oven sprays.

## Cleaning the grease filters in the dishwasher

 Risk of damage due to excessively high temperatures in the dishwasher.

Excessively high temperatures can render the grease filter unusable (due to being warped out of shape, for example).

Select a programme that does not exceed the recommended temperature.

Also follow the information provided in the operating instructions for the dishwasher.

- Place the grease filter upright or slightly inclined in the lower basket. Ensure the spray arm is not obstructed.
- Use a standard household cleaning detergent.

- Select a programme with a maximum wash temperature of 65 °C.

Depending on the detergent used, the internal filter surfaces may become discoloured. This will not affect the functioning of the grease filters in any way.

## After cleaning

- After cleaning, leave the grease filter to dry on an absorbent surface before refitting it.
- When removing the filter for cleaning, also clean off any residues of oil or fat from the now accessible casing to prevent the risk of these catching fire.

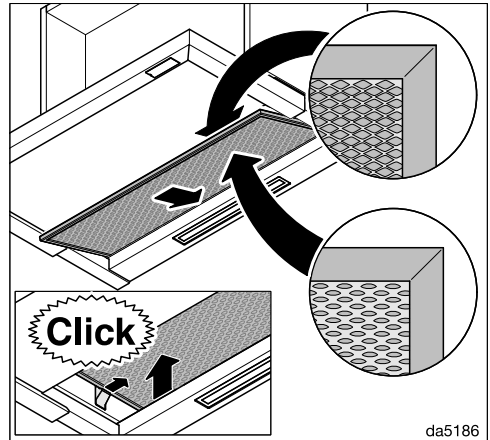

- Refit the grease filter.

## Change grease filters

Regular use and cleaning can cause the filter surfaces to wear.

If you notice any damage, replace the grease filter.

You can obtain the grease filter from Miele customer service (see end of these operating instructions) or your Miele specialist dealer.

## Cleaning and care

### NoSmell active charcoal filters

With recirculation mode, 2 charcoal filters must be inserted in addition to the grease filter. These are designed to absorb cooking odours.

The charcoal filters are fitted in the canopy above the grease filter.

Charcoal filters are available to order via the Miele online shop (see end of this booklet for contact details) or directly from Miele.

The charcoal filters are listed under “Technical data” at the back of this booklet.

### Fitting/Replacing the charcoal filters

The matching frames must be installed in order to use the charcoal filters. Follow the directions on the installation sheet.

- Remove the grease filter from the rangehood.
- Remove the charcoal filter packaging.

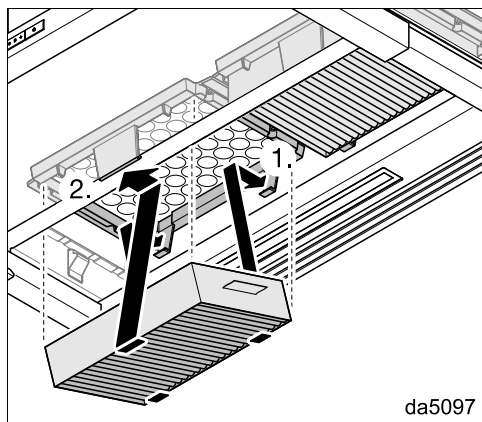

- Push the charcoal filters into the frames until they engage firmly.
- Refit the grease filter.

- To remove the charcoal filters, press the tab forwards slightly and pull the filters down to remove them.

### When to change the NoSmell active charcoal filters

Replace the charcoal filters when they no longer absorb kitchen odours effectively, or at least every 6 months.

### Disposing of the charcoal filters

- Used charcoal filters can be disposed of with the normal household waste.

### Reactivatable charcoal filters

Reactivatable charcoal filters are available for this rangehood. They can be used several times after being reactivated in the oven.

Please follow the operating instructions supplied with the filter.

You can find information on how to remedy faults yourself and about Miele spare parts at [www.miele.com.au/service](http://www.miele.com.au/service) or [www.miele.co.nz/service](http://www.miele.co.nz/service).

## Contact in case of fault

In the event of any faults which you cannot remedy yourself, please contact Miele.

You can book a Miele customer service call-out online at [www.miele.com.au/service](http://www.miele.com.au/service) or [www.miele.co.nz/service](http://www.miele.co.nz/service).

Contact information for Miele can be found at the end of this booklet.

Please quote the model and serial number of your appliance when contacting Miele. This information can be found on the data plate.

## Position of the data plate

The data plate is visible once you have removed the grease filter and, in the case of recirculation mode, the charcoal filters.

## Warranty

The manufacturer's warranty for this appliance is 2 years.

For further information, please refer to your warranty booklet.

# Installation

## Before installation

 Before installation, it is important to read the information given on the following pages as well as the “Warning and Safety instructions” at the beginning of this booklet.

## Installation recommendations

- To achieve optimum vapour extraction, the rangehood must be positioned centrally over the cooktop, not to the side.
- The cooktop should be no wider than the rangehood and, if possible, it should be narrower, especially for safety distances greater than 750 mm.
- The installation area must be easily accessible. The rangehood should be easily accessible and easy to dismantle in the event that service is required. This should be taken into consideration when planning the position of cupboards, shelves, ceilings or features in the vicinity of the rangehood.

## Installation materials

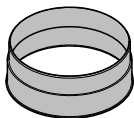

**1 exhaust connection**  
for exhaust ducting  $\varnothing$  150 mm.

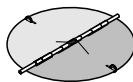

**1 non-return flap**  
for fitting into the exhaust connection on the motor unit (not needed for recirculation mode).

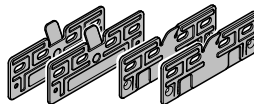

**4 mounting plates**  
for installation in a 600 mm wide cabinet

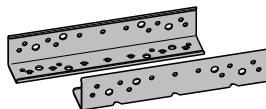

**2 brackets**  
for installation in a 900 mm wide cabinet (only for 896 mm wide appliances)



**2 spring clips**  
for installation in a 900 mm wide cabinet (only for 896 mm wide appliances)



**1 spacer strip**  
for concealing the gap between the rear of the appliance and the wall

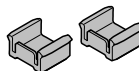

**2 depth stops**  
to limit how far the deflector plate can be pushed in

08272520

11574700

08268021

08363320

11597050

11940470

08565780



4 screws, M4 x 8 mm



5 (9)\* screws, 4 x 15 mm

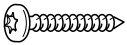

4 screws, 4 x 30 mm



8 (12)\* screws, 4 x 15 mm



4 screws, M4 x 12 mm\*



4 screws, M4 x 8.5 mm\*



2 screws, 3.9 x 7.5 mm with cover caps

\* for 896 mm wide units

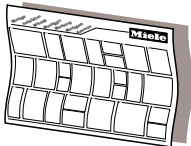

## Installation plan

See the installation plan for details on the individual steps involved in the installation of this appliance.

06095672

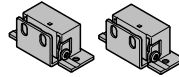

01056271

## DML 2000 installation kit

for installing a hinged front panel to match kitchen cabinetry (not supplied; available as an optional accessory)

09879120

## Installation materials for recirculation mode

You need the following optional accessories for recirculation mode.

04932511

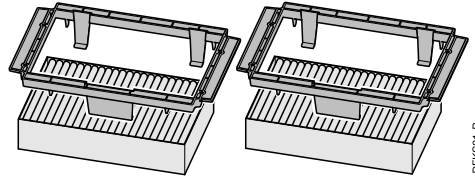

07270730

## DKFS 31-x installation kit

contains 2 holders and 2 charcoal filters (DKFS 31-P with single-use charcoal filters or DKFS 31-R with reactivatable charcoal filters)

06462181

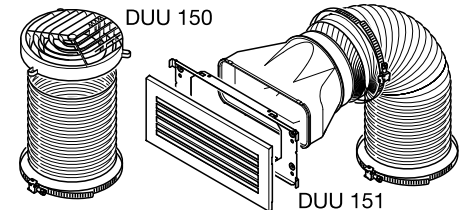

18820mkap

dina3mie

## DUU 15x installation kit

contains a directional unit socket, hose and hose clips (DUU 150 for the top of the cabinet or DUU 151 for the sides or front of the cabinet)

11839870

DFK831-P

DUU 150 151

# Installation

## Appliance dimensions

Figure 1: 596 mm wide rangehood in a 600 mm wide cabinet.

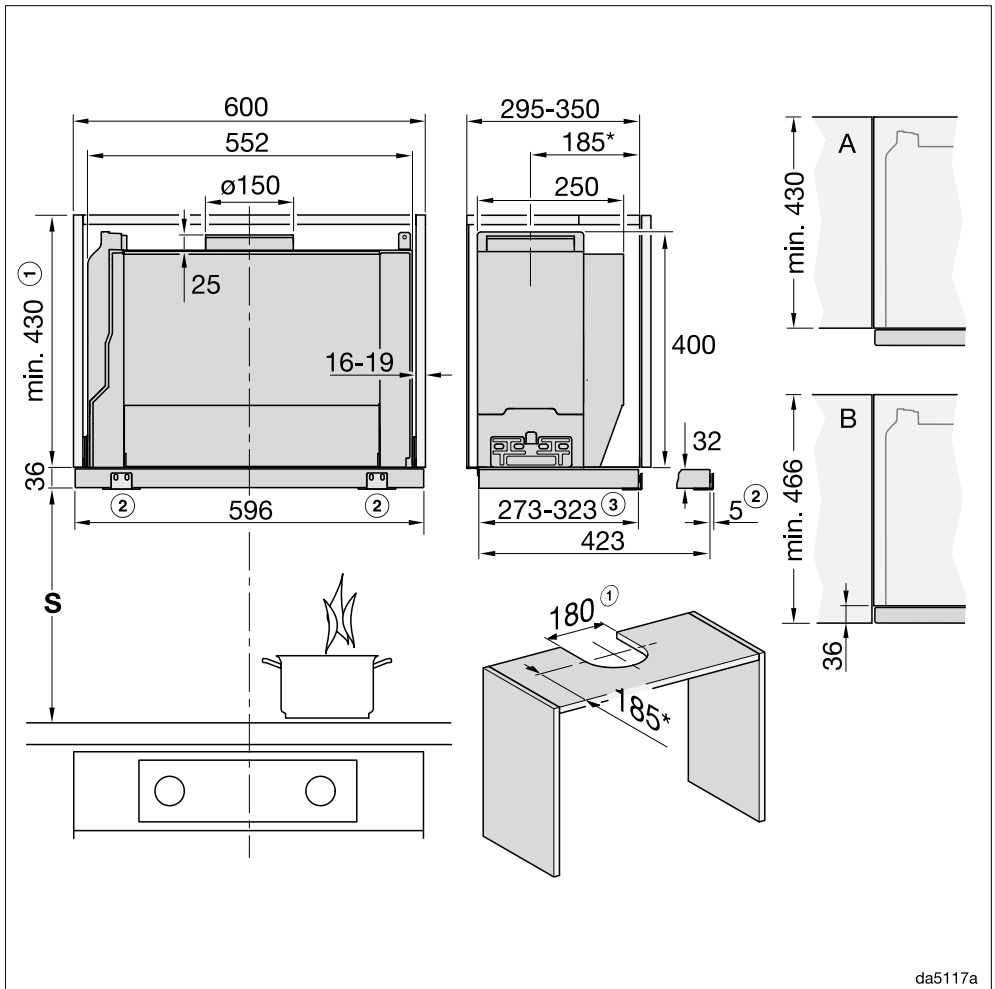

The drawing is not to scale



Figure 2: 896 mm wide rangehood in a 900 mm wide cabinet.

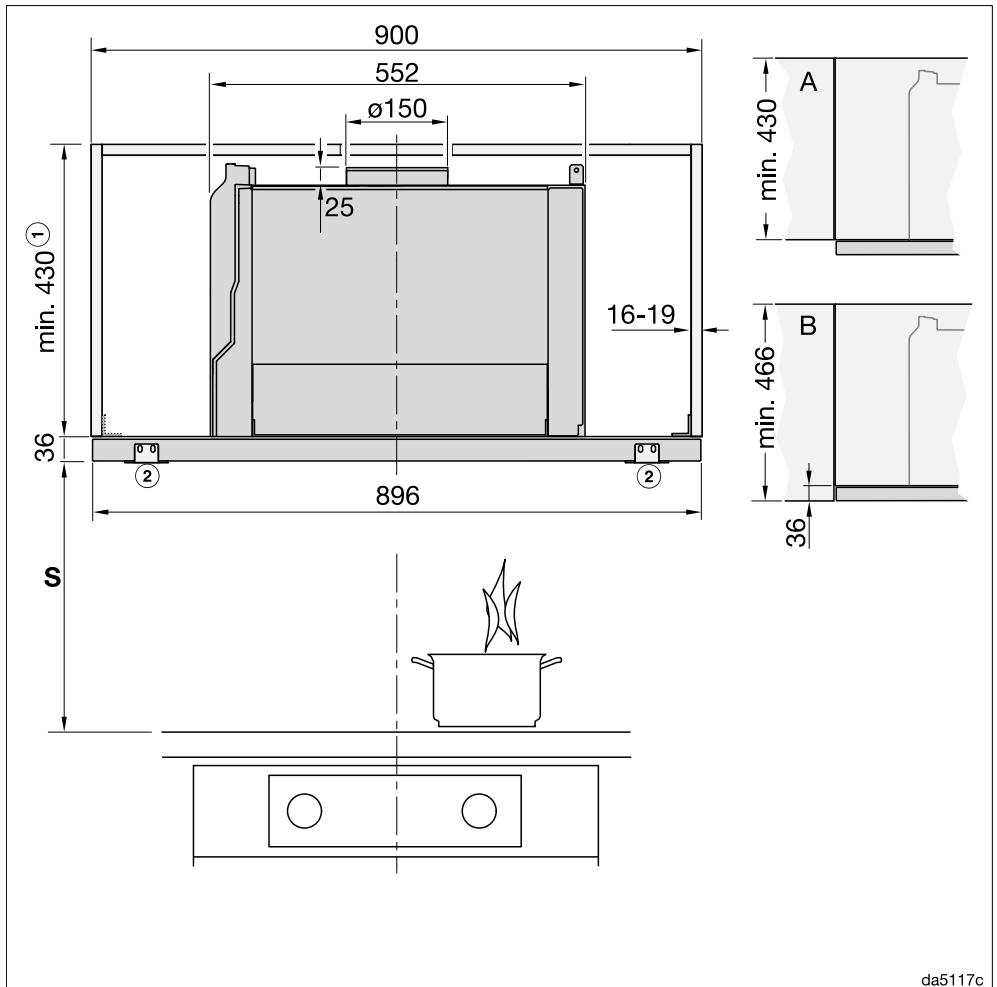

da5117c

The drawing is not to scale  
See diagram 1 for side view

# Installation

Diagram 3: 896 mm wide rangehood in a 600 mm wide cabinet or in a 900 mm wide cabinet with side compartments.

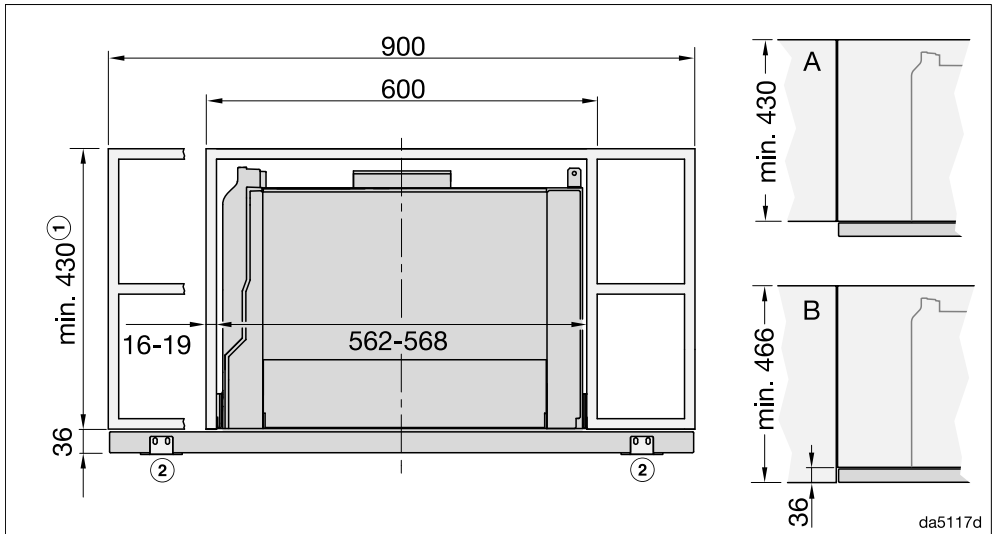

The drawing is not to scale

See diagram 1 for side view

Footnotes for diagrams 1 to 3:

- ① Extraction or recirculation with conversion kit DUU 150
- ② DML 2000 bracket (optional accessory) for fitting a front panel
- ③ Can be adjusted via depth stop

\* In this installation situation, the deflector plate is flush with the front edge of the cabinet niche. If you wish to position the rangehood further forwards or further back, you must adapt the dimensions accordingly (e.g. if you are using a front panel).

The height of the cabinet and the cut-out dimensions must take account of any accessories installed.

AU/NZ: It is recommended to install the rangehood so that the bottom of the rangehood canopy sits flush with the bottom of adjacent furniture units - see detail B.

## Safety distance (S)

The minimum distances between the cooking surface of a cooktop (pan support(s) for gas models) and the bottom of the rangehood are as follows, unless a greater distance is specified by the manufacturer of your cooking appliance. See also “Warning and Safety instructions”.

Cooking appliance	Minimum distance S
Electric cooktop	600 mm (AU, NZ) 450 mm (HK, MY, SG, TH, TW)
Electric grill, deep fat fryer (electric)	650 mm
Multi-burner gas cooktop with maximum 45.4 MJ/h total output, with no burner having a greater output than 16.2 MJ/h.	650 mm
Multi-burner gas cooktop with total output greater than 45.4 MJ/h, but with a maximum of 77.8 MJ/h, with no burner having a greater output than 17.3 MJ/h.	760 mm
Multi-burner gas cooktop with total output greater than 77.8 MJ/h, with a single burner having a greater output than 17.3 MJ/h.	Not possible
Single burner gas cooktop with a maximum output of 21.6 MJ/h.	650 mm
Single burner gas cooktop with an output greater than 21.6 MJ/h, but with a maximum of 29.2 MJ/h.	760 mm
Single burner gas cooktop with an output greater than 29.2 MJ/h.	Not possible

If you are fitting a front panel made of wood or plastic to the rangehood, observe the safety distances given by the cooktop manufacturer regarding the use of easily flammable materials.

# Installation

## Installing the depth stops (optional)

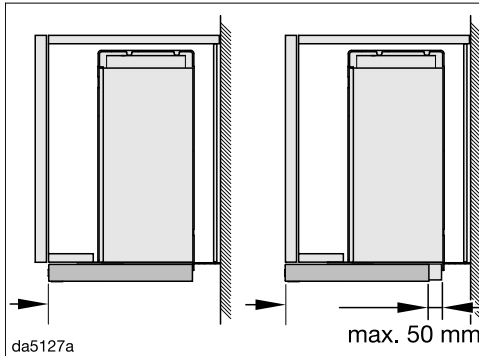

You can limit how far the deflector plate can be pushed in.

For example, if the deflector plate should sit flush with the front edge of the cabinet door when pushed in, rather than with the front edge of the cabinet housing, you can position the depth stop accordingly.

You can move the stops forwards by up to 50 mm.

You must insert the depth stops into the recesses of the deflector plate prior to installing the rangehood. You can fix the depth stops in the required position on completion of installation.

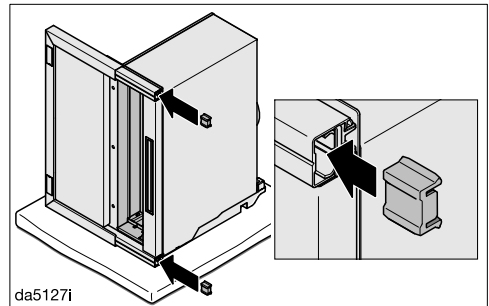

- Insert the depth stops into the recesses of the deflector plate from behind. The lip on the depth stop faces backwards.

- Install the rangehood.

- Pull out the deflector plate.

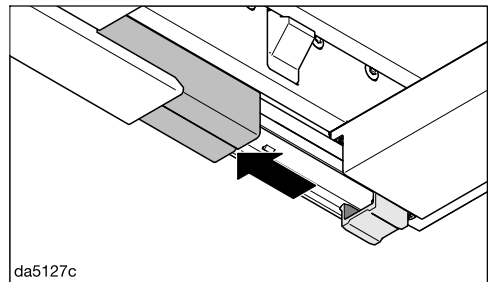

- Slide the recess covers forwards.

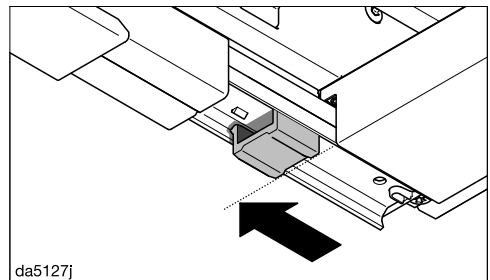

- Slide the depth stops forwards to the position shown.

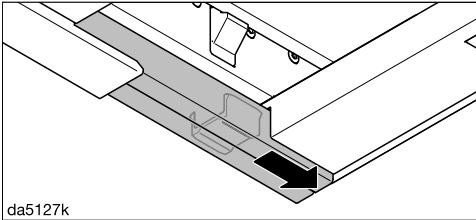

- Slide the covers back again.

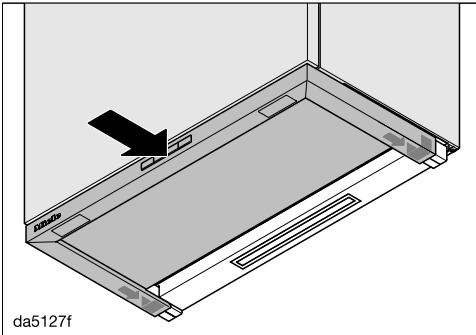

- Carefully push in the deflector plate as far as the required position.

This will push the depth stops into the required position.

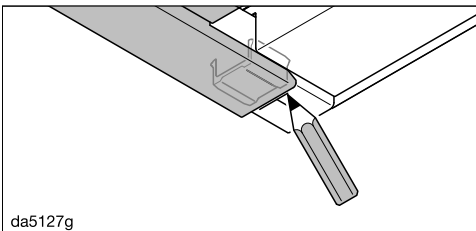

- Use a pencil to mark the back edge of the deflector plate on the cover.
- Pull out the deflector plate.

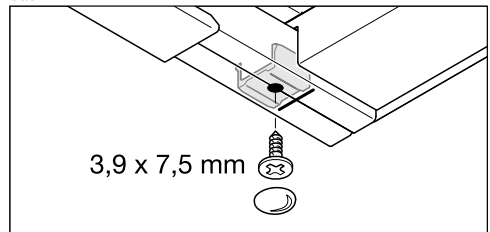
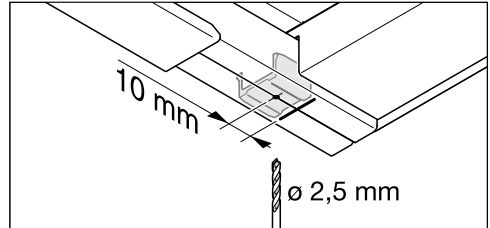

- Drill a pilot hole 10 mm in front of the pencil mark and screw the depth stops into place.

# Installation

## Connection for air extraction

 Before installation, it is important to read the information given on the following pages as well as the “Appliance dimensions” and the “Warning and Safety instructions” at the beginning of this booklet. This is particularly crucial when using the rangehood at the same time as a heating appliance that relies on oxygen from the same room, which could result in the build-up of toxic fumes.

The rangehood should be installed according to local and national building regulations. Seek approval from the building inspector where necessary.

Only use smooth pipes or flexible ducting made from approved non-flammable materials for exhaust ducting.

To achieve the most efficient air extraction with the lowest noise levels, please note the following:

- The diameter of the exhaust ducting must not be smaller than the cross-section of the exhaust connection (see "Appliance dimensions"). This is particularly applicable when using flat ducting.
- The exhaust ducting must be as short and straight as possible.
- Only use wide radius bends.
- The exhaust ducting must not be kinked or compressed.
- All connections must be strong and airtight.

- If the ducting has flaps, these must be opened when the rangehood is switched on.

Any constriction of the airflow will reduce extraction performance and increase operating noise.

## Vent flue

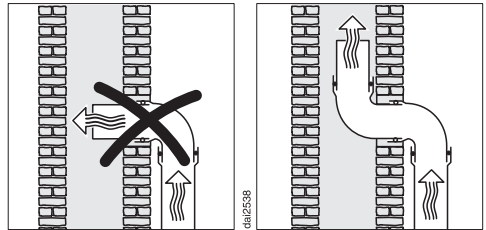

If the exhaust air is to be ducted into a vent flue, the ducting must be directed in the flow direction of the flue.

If the flue is used by several ventilation units, the cross-section of the flue must be large enough.

## Non-return flap

- Make sure you use a non-return flap in the exhaust air system.

A non-return flap ensures that when the rangehood is not in operation, the duct is closed and no exchange of room and outside air can take place.

If the exhaust air is ducted through an outside wall, a Miele wall vent or a Miele roof vent (available as an optional accessory) is recommended. These are fitted with an integrated non-return flap.

If the on-site exhaust air system does not have a non-return flap, one is supplied with the rangehood.

The non-return flap is fitted to the fan's exhaust connection.

## Condensed water

If the exhaust ducting is to run through rooms, ceiling space etc., condensate may form in the ducting due to variations in temperature between the different areas. To minimise temperature variations, the exhaust ducting will need to be suitably insulated.

Where ducting is horizontal, it must be laid to slope away at at least 1 cm per metre. The gradient ensures that condensate cannot drain back into the rangehood.

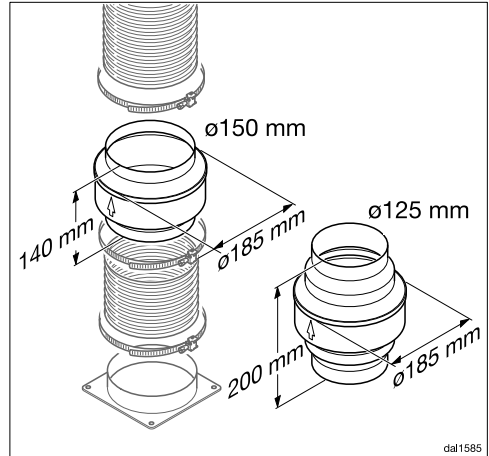

In addition to insulating the exhaust ducting, we recommend that a suitable condensate trap is also installed to collect and evaporate any condensate which may occur.

Condensate traps are available for 125 mm or 150 mm ducting.

When installing a condensate trap, ensure that it is positioned vertically and, if possible, directly above the exhaust socket. The arrow on the housing indicates the direction of airflow.

Miele will not accept warranty claims for any functional defects or damage caused by inadequate ducting.

# Installation

## Silencer

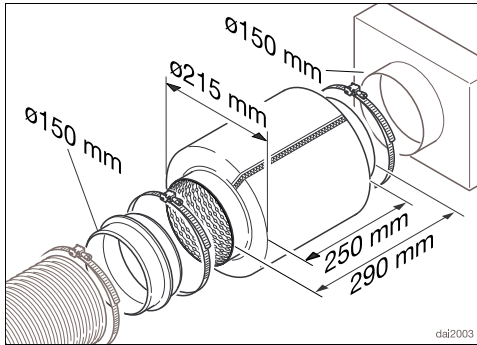

To achieve even further reductions in noise levels, a special silencer (optional accessory) can be fitted in the ducting system.

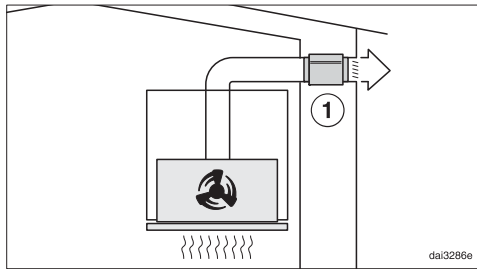

In extraction mode the silencer not only reduces noise from the fan outside the house, but also sounds from outside which reach the kitchen via the vent ducting (e.g. traffic noise). For this reason, the silencer must be positioned as close as possible to the ducting exit ①.

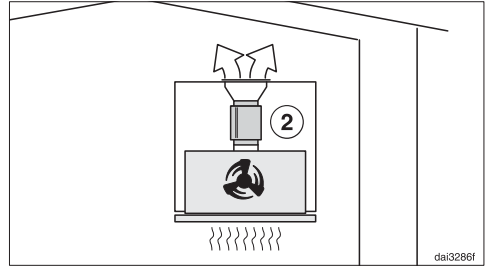

In recirculation mode the silencer needs to be positioned between the exhaust connection and the exhaust grille ②. Please ensure there is adequate installation space.



## Electrical connection

The rangehood is supplied with a mains connection cable with moulded plug ready for connection to a suitable earthed socket.

If the socket is not easily accessible or if the appliance is to be hard-wired, ensure that a suitable means of disconnection is provided on the installation side for each pole.

 Risk of fire from overheating.

Connecting the rangehood to multi-socket adapters or extension cables can overload the cables.

For safety reasons, do not use an extension cable or multi-socket adapter.

All electrical work must be carried out by a suitably qualified and competent person in strict accordance with national and local safety regulations.

For safety reasons, we recommend using a suitable residual current device (RCD) in the relevant electrical installation for connecting the rangehood.

If the mains connection cable is damaged, it must only be replaced with a specific mains connection cable of the same type (available from Miele). For safety reasons, such replacement may only be carried out by a suitably qualified and competent electrician or a Miele authorised service technician, in order to avoid a hazard.

The data plate indicates the nominal power consumption and the connection data. Compare this information with the data of the on-site electrical connection. If in any doubt, consult a qualified electrician.

Temporary or permanent operation with a self-sufficient or non-mains synchronous energy supply system (e.g. isolated networks, back-up systems) is possible. A requirement for the operation is that the energy supply system complies with all current local and national requirements that apply to stand-alone, solar and/or battery systems. The protective measures provided in the domestic installation and in this Miele product must also be assured in their function and operation in isolated operation or in non-mains synchronous operation, or replaced with equivalent measures in the installation.

## Technical data

---

Fan motor	290 W
Cooktop lighting	3.2 W
Total rated load	293.2 W
Voltage, frequency	AC 230 V, 50 Hz
Fuse rating	10 A
Mains connection cable length	1.5 m
Weight	
DAS 2620	14 kg
DAS 2920	16 kg

### Optional accessory for recirculation mode

You will need the following kits for recirculation operation:

- DUU 150 or DUU 151
- DKFS 31-P or DKFS 31-R (reactivable). The kits contain 2 charcoal filters and the necessary installation frames for the initial equipment.

For additional purchase, you need the charcoal filters DKF 31-P or DKF 31-R (reactivable). The packs contain 2 charcoal filters.

**Miele Australia Pty. Ltd.**

ACN 005 635 398

ABN 96 005 635 398

Level 4, 141 Camberwell Road  
Hawthorn East, VIC 3123

**1300 464 353 (1300 4 MIELE)**

**info@miele.com.au**

**www.miele.com.au**

**Miele New Zealand Limited**

IRD 98 463 631

8 College Hill  
Freemans Bay, Auckland 1011

**0800 464 353 (0800 4 MIELE)**

**customercare@miele.co.nz**

**www.miele.co.nz**

**Miele Global Headquarters**

**Germany**

**Miele & Cie. KG**

Carl-Miele-Straße 29

33332 Gütersloh

Federal Republic of Germany

DAS 2620, DAS 2920

en-AU, NZ

M.-Nr. 12 311 700 / 04