









Operating and installation instructions Washing machine



Always read the operating instructions before setting up, installing and commissioning the machine. This prevents both personal injury and damage to the machine.

Contents

Caring for the environment	6
Warning and safety instructions	7
Operating the washing machine	15
Fascia panel	15
Sensor controls and touch display with sensor controls	16
Main menu	16
Examples of how to operate the appliance	17
Operating a laundrette machine	19
Before using for the first time	20
Setting the display brightness	21
Setting the date	21
Selecting programme packages	22
1. Preparing the laundry	26
2. Loading the washing machine	27
3. Selecting a programme	28
4. Selecting programme settings	29
5. Adding detergent	30
Adding fabric conditioner or liquid starch separately	31
Adding starch separately	31
6. Starting the programme – the end of the programme	32
Timer	33
Programme chart	34
Extras	49
Pre-wash 	49
Pre-rinse 	49
Rinse plus 	49
Soak 	49
Intensive 	49
Water plus 	49
Pre-ironing 	49
Rinse hold 	49
Starch stop 	49
Special features in the programme sequence	50
Spinning	50
Anti-crease	50
Changing the programme sequence	51
Changing a programme	51
Cancelling a programme	51
Switching on the washing machine after an interruption to the power supply	51
Adding or removing laundry	52
Cleaning and care	53
Cleaning the casing and fascia panel	53
Cleaning the detergent drawer	53

Cleaning the drum, suds container and drainage system	55
Cleaning the sealing ring	55
Cleaning the water inlet filters	56
Problem solving guide	57
The wash programme does not start	57
Programme cancellation and error message	58
A fault message appears in the display	59
An unsatisfactory wash result	60
General problems	61
The door will not open	62
Opening the door in the event of a blocked drain outlet and/or power cut	63
Miele Service	66
Contact in case of malfunction	66
Optional accessories	66
Installation	67
Front view	67
Rear view	68
Installation locations	69
Installation notes	69
Transporting the washing machine to its installation site	70
Installation surface	71
Removal of transit bars	71
Fitting the transit bars	73
Levelling the washing machine	73
Holding bracket for plinth	74
External control equipment	76
Payment system	76
Water connection	77
Cold water connection	77
Hot water connection*	78
Drainage	78
Drain valve	78
Drain pump	78
Electrical connection	79
Technical data	81
EU Conformity declaration	82
UK Conformity declaration	82
Supervisor level	83
Opening Supervisor level	83
Code-based access	83
Changing the code	83
Closing the settings menu	83

Contents

Operation/display.....	84
Language.....	84
Language menu.....	84
Set languages.....	84
Display brightness.....	84
Clock display.....	85
Date.....	85
Volume.....	85
Visibility parameters.....	85
Display off status.....	86
Machine off status.....	86
Delay start.....	86
Memory.....	86
Temperature unit.....	87
Weight unit.....	87
Logo.....	87
Supervisor code.....	87
Programme selection.....	87
Controls.....	87
Programme packages.....	88
Favourite programmes.....	88
Special programmes.....	90
Sort programmes.....	90
Prog. colour allocation.....	90
Hygiene.....	90
Expert code.....	90
Process technology.....	91
Anti-crease.....	91
Water level Cottons.....	91
Water level Min. iron.....	91
Pre-wash temp Cottons.....	91
Wash time.....	91
Pre-rinse Cottons.....	92
Pre-rinse Minimum iron.....	92
Pre-wash Cotton/M-iron.....	92
Cottons rinses.....	92
Minimum iron rinses.....	92
Disinfection rinse.....	92
Auto load control.....	92
Controlled energy cons.....	93
Service.....	93
Clean drain pump.....	93
Service interval.....	93

External applications.....	94
Availability of Miele digital products.....	94
Empty sensor.....	94
Early warning counter.....	94
Automatic dispensing.....	94
Adjustment value dosage 1–6.....	94
Peak load signal.....	95
Peak load prevention.....	95
COM module selection.....	95
WiFi.....	95
Network time.....	96
Remote.....	97
RemoteUpdate.....	97
SmartGrid.....	98
Machine parameters.....	98
Suds cooling.....	98
Water inlet.....	99
Low water pressure.....	99
Legal information.....	100
Payment system.....	100
Settings for payment systems.....	100
External prog. lock.....	101
Payment system lock.....	101
Programme cancellation.....	101
F-back signal to pay system.....	101
FOC programmes.....	102
Clear paid signal.....	102
Debounce time.....	102

Caring for the environment

Disposing of the packaging material

The packaging material is used for handling and protects the appliance from transport damage. The packaging material used is selected from materials which are environmentally friendly for disposal and can generally be recycled.

Recycling the packaging material reduces the use of raw materials. Use material-specific collection points for valuable materials and take advantage of return options. Your Miele dealer will take the packaging material away.

Disposing of your old appliance

Electrical and electronic appliances contain many valuable materials. They also contain certain materials, compounds and components which were essential for their correct functioning and safety. These could be hazardous to human health and to the environment if disposed of with household waste or if handled incorrectly. Please do not, therefore, dispose of your old appliance with household waste.



Instead, please make use of officially designated collection and disposal points to dispose of and recycle electrical and electronic appliances in your local community, with your dealer or with Miele, free of charge. By law, you are solely responsible for deleting any personal data from the old appliance prior to disposal. You are legally obliged to remove any old batteries which are not securely enclosed by the appliance and to remove any lamps without destroying them, where this is possible. These must be taken to a suitable collection point where they can be handed in free of charge. Please ensure that your old appliance poses no risk to children while being stored for disposal.

Warning and safety instructions

This washing machine complies with all current local and national safety requirements. However, inappropriate use can lead to personal injury and damage to property.

Read the operating instructions carefully before using the washing machine. They contain important information on safety, installation, use and maintenance. This prevents both personal injury and damage to the washing machine.

In accordance with standard IEC 60335-1, Miele expressly and strongly advises that you read and follow the instructions in the chapter on installing the washing machine as well as the safety instructions and warnings.

Miele cannot be held liable for damage caused by non-compliance with these instructions.

Keep these operating instructions in a safe place and pass them on to any future owner.

When instructing other people how to use the washing machine, they must be made aware of these safety and warning instructions.

Appropriate use

- ▶ The washing machine is only suitable for washing fabrics with a care label stating that they are suitable for machine washing. Any other applications may be dangerous. The manufacturer cannot be held liable for damage resulting from incorrect or improper use or operation of the machine.
- ▶ This washing machine must be used as described in the operating instructions and must be checked on a regular basis to make sure it is functioning correctly. Maintenance must be carried out when necessary.
- ▶ The washing machine is not suitable for outdoor use.
- ▶ This washing machine may also be operated in public areas.

Warning and safety instructions

- ▶ This washing machine can only be used by people with reduced physical, sensory or mental capabilities, or lack of experience or knowledge, if they are supervised whilst using it or have been shown how to use it in a safe way and understand and recognise the consequences of incorrect operation.
- ▶ Children under the age of 8 must not be allowed near the washing machine unless they are constantly supervised.
- ▶ Children over the age of 8 may only use the washing machine without supervision if its operation has been clearly explained to them and they are able to use it safely. Children must be able to understand and recognise the possible dangers caused by incorrect operation.
- ▶ Children may not carry out cleaning or maintenance on the washing machine unsupervised.
- ▶ Always supervise any children in the vicinity of the washing machine. Never allow children to play with the washing machine.
- ▶ Disinfection programmes must not be interrupted, as this can have a limiting effect on the disinfection result. It is the operator's responsibility to ensure that the standard of disinfection in thermal as well as chemo thermal procedures is maintained by carrying out suitable validation tests.

Technical safety

▶ Before setting up the washing machine, check it for any externally visible damage. Do not set up or use a damaged washing machine.

▶ The electrical safety of the washing machine can only be guaranteed when correctly earthed.

It is most important that this basic safety requirement is tested and in case of any doubt the on-site wiring system should be inspected by a qualified electrician.

Miele cannot be held liable for the consequences of an inadequate earthing system.

▶ Unauthorised repairs could result in unforeseen dangers for the user, for which the manufacturer cannot accept liability. Repairs should only be undertaken by a Miele approved service technician, otherwise any subsequent damage will not be covered by the warranty.

▶ Do not make any alterations to the machine, unless authorised to do so by Miele.

▶ The machine must be isolated from the electricity supply when cleaning and maintaining the machine and in the event of a fault:

- switch off at the wall and disconnect the plug from the socket, or
- disconnect the fuse at the mains circuit board, or
- unscrew the on-site screw-in fuse.

See “Installation – Electrical connection”.

▶ If the electrical connection cable is faulty it must only be replaced by a Miele authorised service technician to protect the user from danger.

▶ The washing machine must only be connected to the on-site water supply using a new hose kit. Old hoses must not be re-used. Check the hose regularly for signs of wear. Replace it in good time to avoid the risk of leaks and subsequent damage.

Warning and safety instructions

- ▶ Faulty components must only be replaced by genuine Miele original spare parts. Miele can only guarantee the safety standards of the machine when Miele replacement parts are used.
- ▶ For reasons of safety, do not connect the machine to the mains electricity supply by an extension lead, multi-socket adapter, or similar. These can overheat and are a fire hazard.
- ▶ In the case of commercial use, all relevant national provisions and regulations (DGUV in Germany) relating to accident insurance are applicable to this machine. It is recommended to carry out testing in accordance with national regulations (e.g. the regulatory framework described in DGUV100-500/Chapter 2.6/Section 4). The test book required for the documentation is available from Miele.
- ▶ The machine must not be used in a non-stationary location (e.g. on a ship).
- ▶ Please observe the instructions in “Installation” and “Technical data”.
- ▶ If the washing machine is equipped with an electrical plug connection, it must be easily accessible after installation so that the machine can be disconnected from the electricity supply if necessary.
- ▶ If the appliance is hard wired, an on-site all pole circuit breaker must always be accessible to disconnect the washing machine from the mains.
- ▶ This washing machine is supplied with a special lamp to cope with particular conditions (e.g. temperature, moisture, chemical resistance, abrasion resistance and vibration). This special lamp must only be used for the purpose it is intended for. It is not suitable for room lighting. Replacement lamps may only be fitted by a Miele authorised person or the Miele Service Department.

Warning and safety instructions

▶ Temporary or permanent operation on an autonomous power supply system or a power supply system that is not synchronised with the mains power supply (e.g. island networks, backup systems) is possible. A prerequisite for operation is that the power supply system complies with the specifications of EN 50160 or an equivalent standard.

The function and operation of the protective measures provided in the building's electrical installation and in this Miele product must also be maintained in isolated operation or in operation that is not synchronised with the mains power supply, or these measures must be replaced by equivalent measures in the installation. As described, for example, in the current version of VDE-AR-E 2510-2.

Correct use

▶ The maximum dry laundry weight is 7.0 kg. The maximum recommended loads for individual programmes are given in the Programme chart.

▶ Do not install your washing machine in a room where temperatures below freezing may occur. Frozen hoses may burst or split. The reliability of the electronic control unit may be impaired at temperatures below freezing point.

▶ Before using the machine for the first time, check that the transit bars at the rear of the washing machine have been removed (see "Installation – Removing transit bars"). During spinning, transit bars which are still in place may result in damage to both the machine and adjacent furniture or appliances.

▶ Close the stopcock if the machine is to be left for any length of time (e.g. while on holiday), especially if there is no floor drain (gully) in the immediate vicinity.

Warning and safety instructions

- ▶ **Danger of flooding!** If hooking the drain hose into a wash basin, check that the water can drain off quickly enough to prevent the sink from overflowing. Hook the hose over the edge and secure. If the hose is unsecured, the force of the water flowing out of it can dislodge it from the basin.
- ▶ Take care to ensure that foreign objects (e.g. nails, pins, coins, paper clips) do not find their way into the machine with the laundry. These may damage components of the machine (e.g. suds container, drum). Damaged components can damage the laundry.
- ▶ If the correct amount of detergent is dispensed, the machine should not need to be descaled. If, however, you do wish to descale it, only use special non-corrosive descaling agents and strictly observe the instructions on the packaging. Special descaling agent is available from your Miele dealer or from Miele Service. Strictly observe the instructions for the descaling agent.
- ▶ For textiles that have been treated with solvent-based detergents, always check whether they can be washed in a washing machine. To check whether this is possible, refer to safety notes, information concerning the product's environmental properties, and other information.
- ▶ Never use solvent based detergents, e.g. those containing benzene, in this machine. Doing so may result in damage to component parts and create toxic fumes. Risk of fire and explosion.
- ▶ Benzene, petrol, paraffin, or any easily flammable liquid must not be stored or used near the machine. Risk of fire and explosion

Warning and safety instructions

- ▶ Only use dyes suitable for use in a washing machine. Always observe the manufacturer's instructions carefully.
- ▶ Colour run and dye removers contain sulphur compounds which can cause damage such as corrosion. Do not use these products in this washing machine.
- ▶ Avoid contact between stainless steel surfaces (front, lid, casing) and liquid detergents or disinfecting agents which contain chlorine or sodium hypochlorite. These agents can have a corrosive effect on stainless steel. Aggressive vapours containing chlorine can also be corrosive. Do not store open containers of these agents near the machine.
- ▶ Do not use a pressure washer or hose to clean the washing machine.
- ▶ It is particularly important to observe manufacturer's instructions when using a combination of cleaning agents and special application products. Products must only be used for applications approved by the manufacturer to avoid any material damage or the occurrence of strong chemical reactions.
- ▶ If detergent has come into contact with the eyes, rinse out immediately with plenty of lukewarm water. If detergent has accidentally been ingested, seek medical advice immediately. People with damaged or sensitive skin should avoid contact with detergent.
- ▶ When adding or removing laundry during the main wash, your skin may come into contact with detergent, particularly if the detergent is dispensed externally. Take care when placing your hands inside the drum. If suds have come into contact with the skin, rinse off immediately with lukewarm water.

Warning and safety instructions

Accessories

- ▶ Accessory parts may only be fitted when expressly approved by Miele. If other parts are used, warranty, performance, and product liability claims will be invalidated.
- ▶ Miele tumble dryers and Miele washing machines can be installed as a washer-dryer stack. This requires a Miele washer-dryer stacking kit which can be purchased separately. Please ensure that the washer-dryer connection kit is suitable for the Miele tumble dryer and the Miele washing machine.
- ▶ If installing the machine on a Miele plinth (available as an optional accessory), please make sure you order the correct one for this washing machine.

Miele cannot be held liable for damage caused by non-compliance with these warning and safety instructions.

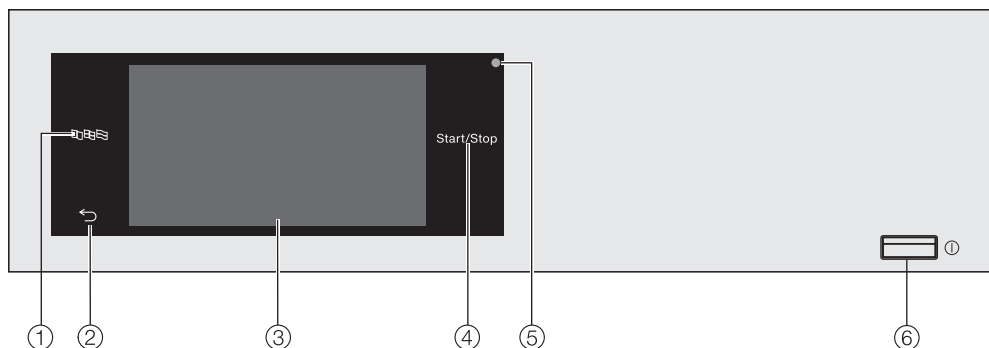

Fascia panel



- ① **Language sensor control**
For selecting the current user language.
The system language is displayed again at the end of the programme.
- ② **Back sensor control** ↶
For going back one level in the menu.
- ③ **Touch display**
- ④ **Sensor control *Start/Stop***
For starting the programme selected and cancelling a programme once it has started. The programme selected can be started as soon as the sensor control starts flashing.
- ⑤ **Optical interface**
For service technicians.
- ⑥ **Button** ①
For switching the washing machine on and off. To save energy, the washing machine will switch off automatically. It is switched off 15 minutes after the end of the programme/anti-crease phase, or after being switched on if no further selection is made.

Operating the washing machine

Sensor controls and touch display with sensor controls

The sensor controls ,  and *Start/Stop* and the sensor controls in the display respond to finger tip contact. Every touch of a sensor is confirmed with an audible tone. You can adjust the volume of the keypad tone or switch it off (see information on “Supervisor level”).

The control panel with sensor controls and the touch display can be scratched by pointed or sharp objects, e.g. pens. Only touch the display with your fingers.

Main menu

After switching on the washing machine, the main menu will appear in the display.

You access all the important sub-menus from the main menu.

Touch the  sensor at any time to return to the main menu. Values set previously are not saved.

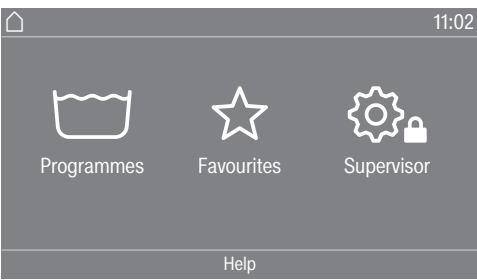

Programmes

For selecting the wash programme.

Favourites

For selecting one of 12 favourite programmes which can be set up and saved by the supervisor (see “Favourite programmes” under “Supervisor level”).

Supervisor

You can alter the washing machine's electronics to suit changing requirements in the supervisor level (see “Supervisor level”).

Operating the washing machine

Examples of how to operate the appliance

Option lists

Programme menu (single option list)

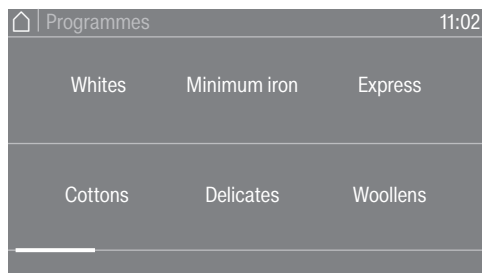

You can scroll to the right or the left by swiping your finger across the screen. To do this place your finger on the touch display and swipe it in the direction you want.

The orange bar under the pictures shows that there are further options to choose from.

Touch a programme name to select the wash programme.

The display will change to the standard display for that programme.

Extras menu (multiple choice)

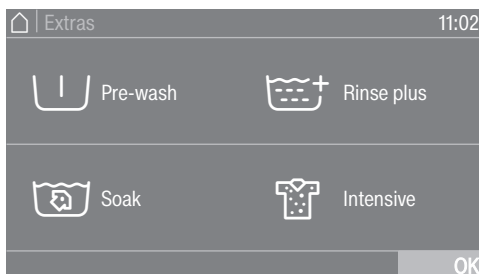

Touch one or several *Extras* to select it/them.

Currently selected *Extras* are marked or-ange.

To deselect an *Extra* simply touch the *Extra* again.

Use the *OK* sensor to activate all selected *Extras*.

Setting numerical values

You can set numerical values in some menus.

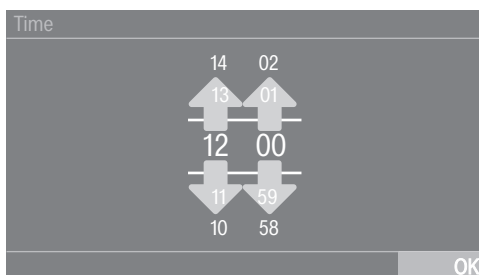

Enter the numbers by swiping upwards or downwards. Place your finger on the number that you want to change and move your finger in the direction you want. Use the *OK* sensor to accept all set figures.

Tip: A numerical keypad may also appear to adjust the value for some settings.

Operating the washing machine

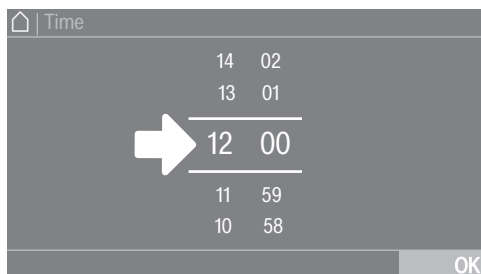

Briefly touching a number between the two lines will bring up the numerical keypad.

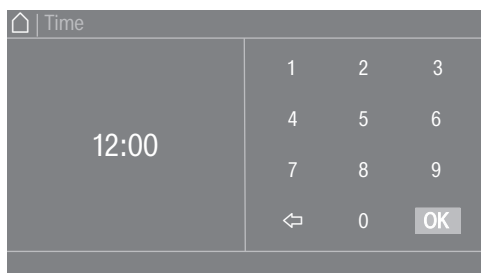

Once a valid number has been entered, the *OK* sensor control will be highlighted green.

Pull-down menu

The pull-down menu can be used to display information, e.g. about a wash programme.

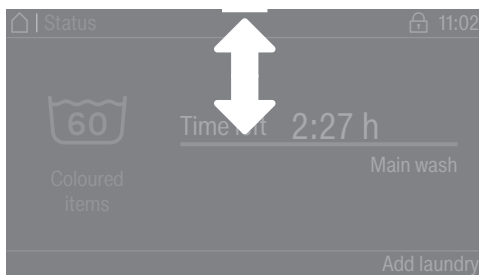

If an orange bar appears at the top of the screen in the middle of the display, you can open the pull-down menu. Touch the bar and drag down with your finger.

Exiting a menu

- Touch the  sensor control to return to the previous screen.

Entries made before this which have not been confirmed with *OK* will not be saved.

Help display

With some menus *Help* appears along the bottom line of the display.

- Touch the *Help* sensor control to display the text.
- Touch the *Close* sensor control to return to the previous screen.

Operating the washing machine

Operating a launderette machine

The main menu will vary depending on the programming status (see “Supervisor level – Controls”).

Shortcuts are the easiest way to operate the machine. Operating staff are unable to change pre-set programmes.

Launderette, basic

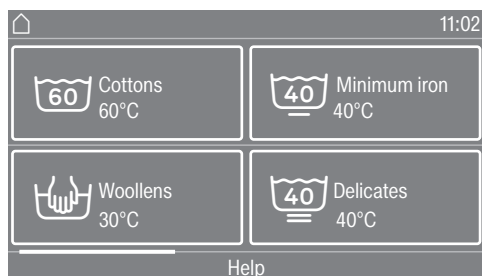

A maximum of 12 programmes can be selected.

Depending on the setting at Supervisor level, the programmes can be displayed with or without a border.

Launderette Logo

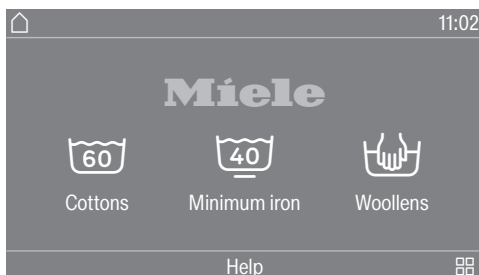

The first 3 programmes can be selected directly. Up to 9 more programmes can be selected from the list .

Before using for the first time

 Damage resulting from incorrect installation and connection. Installing and connecting the washing machine incorrectly will cause serious property damage. See “Installation”.

Emptying the drum

A swivel elbow for the drain hose and/or assembly material may be stored in the drum.

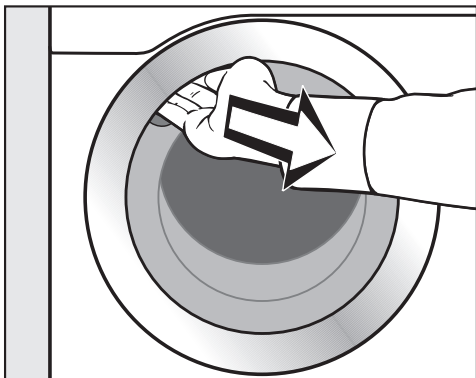

- Pull open the door.
- Remove the swivel elbow and assembly material.
- Shut the door with a gentle swing.

Switching on the washing machine

- Press the  control.

The welcome screen will light up.

When commissioning the washing machine for the first time, you will have to define settings for daily use of the appliance. Some settings can only be configured during the initial commissioning process. After that, they must be changed by Miele Service.

Complete the initial commissioning process.

These settings are also described under “Supervisor level”.

Setting the language

You will be asked to select the language you require for the display. You can change the language at any time (see “Language” under “Supervisor level”).

Language		
deutsch	english (CA)	english (US)
english (AU)	english (GB)	español
		OK

- Scroll to the left or the right until the language you want appears.
- Touch the sensor control for the language you want.

The selected language will be highlighted in orange and the display will change to next setting.

Before using for the first time

Reference to external appliances

A reference to external hardware appears.

- Confirm with the **OK** sensor control.

Before initial commissioning, connect the XCI box or adapter or slide a communication module into the slot on the back of the machine. The washing machine must be disconnected from the mains. Then start the commissioning process.

Setting the display brightness

You will be asked to select the brightness of the display.

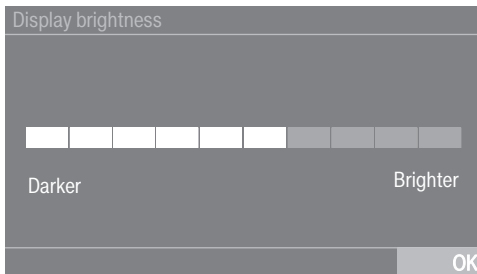

- Touch the segment bars until you reach the required level of brightness.

The selected brightness level will be highlighted orange.

- Confirm with **OK**.

The display will change to the next setting.

Setting the date

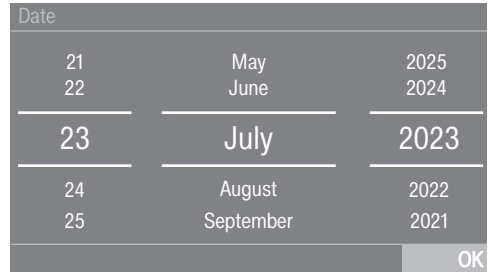

- Place your finger on the number that you want to change and move your finger in the direction you want.
- Once all values have been selected, confirm with the **OK** sensor control.

The display will change to the next setting.

Confirm time request

The following question appears in the display:

Should the time of day display not be shown?

- Touch the sensor control **yes** or **no**.

If you select **yes**, the system will skip the setting **Clock display**.

If you select **no**, the display will switch to the setting **Clock display**.

Before using for the first time

Setting the time of day

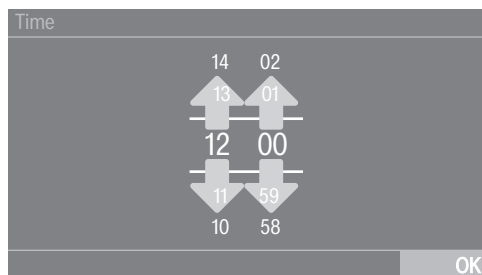

- Place your finger on the number that you want to change and move your finger in the direction you want.
- Confirm with the *OK* sensor control.

The display will change to the next setting.

Selecting programme packages

You can select various programmes from the programme packages. Any programmes already active are marked in orange.

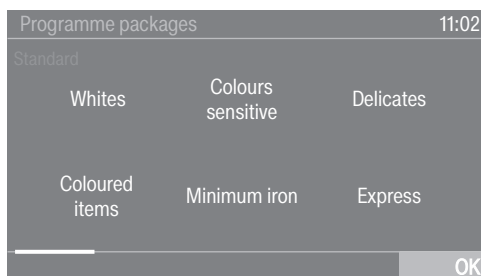

- Scroll right until you reach a programme that is not marked in orange.
- Touch the sensor control for the required programme.

The selected programme is marked in orange.

- You can select further programmes.

Tip: You can disable a selected programme by touching the programme's sensor control again.

- If you do not want to select any more programmes, confirm with the sensor control *OK*.

The display will change to the next setting.

Before using for the first time

Switching on automatic dispensing

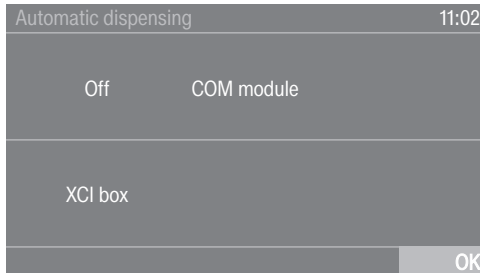

- Touch the COM module or XCI box sensor control if you want to dispense detergent externally.
- Confirm with the *OK* sensor control.

The display will change to the next setting.

Setting up a payment system

If you wish to set up a payment system, read "Payment system" under "Supervisor level".

These settings can only be changed during the initial commissioning process. If you wish to change the settings after the commissioning process, please contact Miele Service.

If you do not wish to set up a payment system, you can skip this stage.

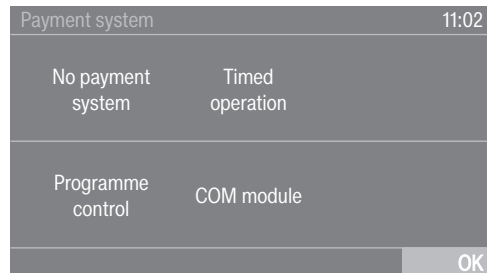

- Touch the No payment system sensor control.

The display will change to the next setting.

Before using for the first time

Select pre-wash water

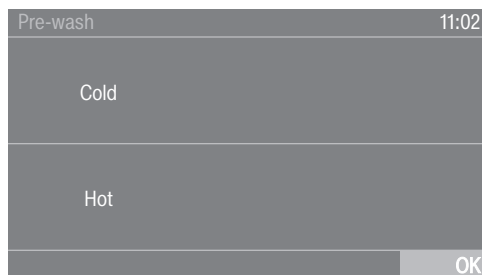

- Touch the **cold** sensor control if the washing machine is only connected to a cold water supply, or touch **hot** if the washing machine is connected to cold and hot water.

The display will change to the next setting.

Select main wash water

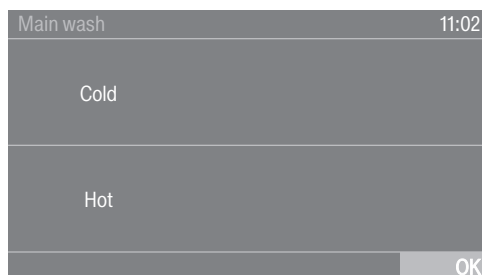

- Touch the **cold** sensor control if the washing machine is only connected to a cold water supply, or touch **hot** if the washing machine is connected to cold and hot water.

Further information will appear on the display.

Removing the transit bars

The display will remind you to remove the transit bars.

 Damage resulting from failure to remove the transit bars.

Failure to remove the transit bars can result in damage to the washing machine and to adjacent furniture or appliances.

Remove the transit bars as described in “Installation”.

- Confirm that the transit bars have been removed with the **OK** sensor control.

Continue setting up as described in the operating instructions appears in the display.

- Confirm the message with the **OK** sensor control.

Before using for the first time

Completing commissioning

To complete commissioning, the *Coloured items 60 °C* programme must be run without laundry and without detergent.

If the power is interrupted prior to the start of the first wash programme (e.g. if the machine is switched off with the ① button), the initial commissioning process can be completed again. Once a wash programme has been running for over 20 minutes, the initial commissioning process does not have to be performed again.

If you have activated disinfection programmes, you must complete the *Thermal disinfection* programme as the first programme; make sure you use a suitable detergent but do not load the machine.

- Open the stopcocks.
- Touch the Programmes sensor control.

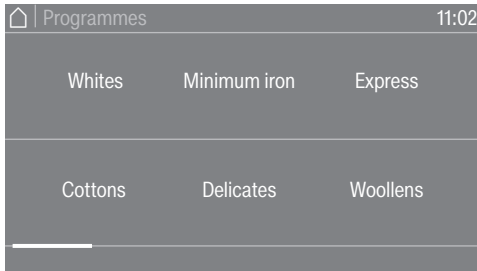

- Touch the Coloured items sensor control.

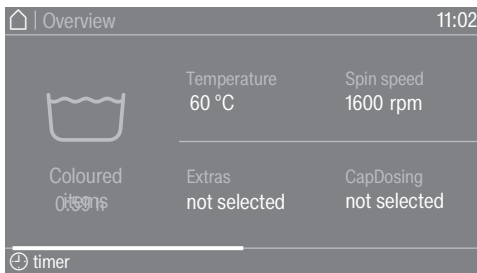

- Touch the *Start/Stop* sensor control.

When the programme has finished, your machine is ready for use.

1. Preparing the laundry

Emptying pockets

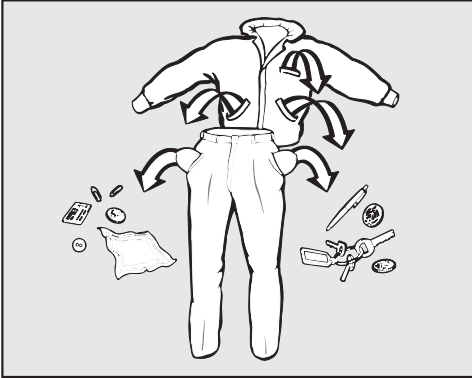

- Empty all pockets.

⚠ Damage due to foreign objects. Nails, coins, paper clips, and so on can cause damage to garments and components in the machine. Check the laundry before washing and remove any foreign objects.

Sorting the laundry

- Sort the laundry according to colour and the garment care label.

Pre-treating stains

- Badly soiled areas and stains should be cleaned as soon as possible. Spillages should be carefully dabbed off using a soft, colourfast cloth.

⚠ Damage due to solvent-based detergents. Detergents containing benzene, stain remover, etc., can damage plastic parts. When pre-treating textiles, make sure that any plastic parts do not come into contact with the detergent.

⚠ Risk of explosion due to solvent-based detergents.

When using solvent-based detergents, an explosive mixture may develop.

Never use solvent-based detergents in the washing machine.

General tips

- Do not machine wash items which are specified by the manufacturer as **not washable** on the care label (☒).
- Curtains: remove rollers and lead weights or place in a laundry bag.
- Sew in or remove any loose underwiring in bras.
- Turn garments inside out, if recommended by the manufacturer.
- Zip up or close any jackets with Velcro or hook and eye fastenings before washing.
- Fasten duvet covers and pillow cases to prevent small items from becoming rolled up inside them.
- Please refer to the Programme chart for more tips and tricks.

2. Loading the washing machine

Opening the door

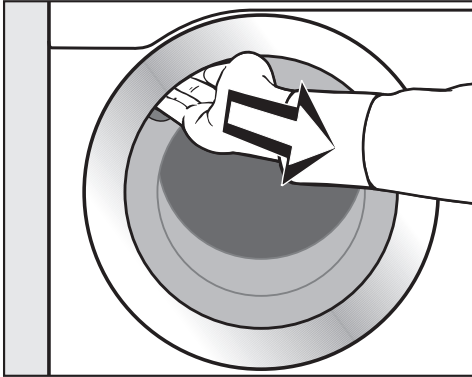

- Reach under the door grip and pull the door open.

Check the drum for foreign objects before loading it with laundry.

- Unfold the laundry and load loosely into the drum.

Mixing both large and small items gives better wash results and also helps to distribute the load evenly during spinning.

The most efficient use of energy and water is achieved when a full load is washed. However, do not overload as this reduces cleaning efficiency and causes creasing.

Closing the door

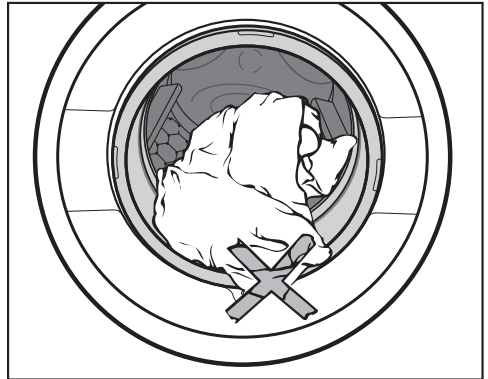

- Make sure that no items are caught between the door and the seal.

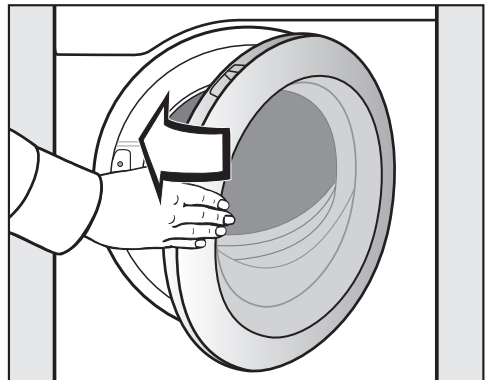

- Shut the door with a gentle swing.

3. Selecting a programme

Switching on the washing machine

- Press the  control.

The drum lighting will come on.

The drum lighting will go out automatically after 5 minutes or when the programme starts.

Selecting a programme

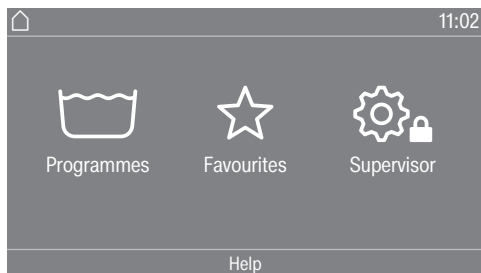

There are different ways to select a programme.

You can select a programme from the Programmes menu.

- Touch the Programmes sensor control.

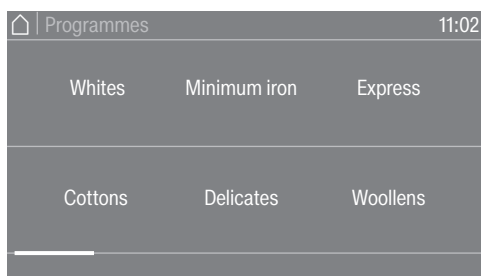

- Scroll to the right in the display until the programme you want appears.
- Touch the sensor control for that programme.

The display will change to the standard menu for that wash programme.

Alternatively, you can select a programme from the Favourites menu.

The programmes under Favourites can be changed by the supervisor (see “Favourite programmes” under “Supervisor level”).

- Touch the Favourites sensor control.

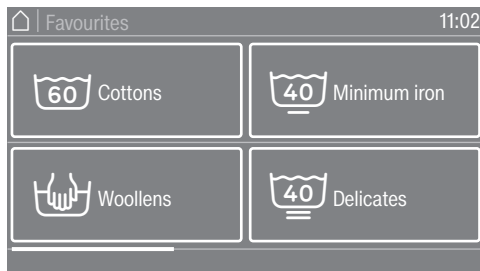

- Scroll to the right in the display until the programme you want appears.
- Touch the sensor control for that programme.

The display will change to the standard menu for that wash programme.

In the case of Favourite programmes, the majority of the programme settings are already fixed and cannot be changed.

4. Selecting programme settings

Selecting a load

To enable load specific dispensing, you can specify the load for some programmes.

- Touch the *Weight sensor control*.
- Enter a valid value for the load quantity.

The display will change to the *Overview menu*.

Selecting the temperature

You can alter the preset temperature of a wash programme.

- Touch the *Temperature sensor control*.
- Select the desired temperature.

The display will change to the *Overview menu*.

Selecting a spin speed

You can alter the preset spin speed of a wash programme.

- Touch the *Spin speed sensor control*.
- Select the spin speed you want.

The display will change to the *Overview menu*.

Selecting Extras

You can select Extras for some wash programmes.

- Touch the *Extras sensor control*.
- Select one or more Extras.
- Confirm with the *OK sensor control*.

The display will change to the *Overview menu*.

See “Extras” for further information.

5. Adding detergent

There are several options for adding detergent to the washing machine.

Detergent drawer

You can use any detergent that is suitable for washing machines.

Detergent dispensing

Please follow the detergent manufacturer's instructions in relation to dosage.

Adding too much detergent will lead to excessive foaming.

Avoid adding excess detergent.

The amount to dispense will depend on:

- the amount of laundry
- the amount of soiling in the laundry
- the water hardness

Hardness range	Hardness in mmol/l	Degree of German hardness °dH
I (soft)	0-1.5	0-8.4
II (medium)	1.5-2.5	8.4-14
III (hard)	above 2.5	above 14

Check with your local water supplier if you do not know the water hardness in your area.

Adding detergent

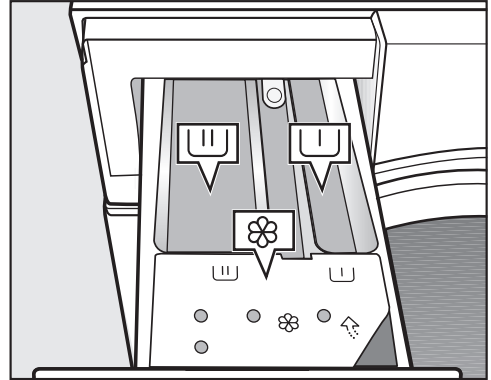

- Pull out the detergent drawer and add detergent to the compartments.

- || Detergent for the pre-wash (divide the total recommended amount as follows: $\frac{1}{3}$ to compartment || and $\frac{2}{3}$ to compartment ||)
- || Detergent for the main wash
- ⊗ Fabric conditioner or liquid starch

For disinfection programmes, the || and || compartments can be filled with detergent for the main wash if you have not selected pre-wash.

5. Adding detergent

Adding fabric conditioner or liquid starch separately

- Select the *Separate rinse* programme.
- Change the spin speed if necessary.

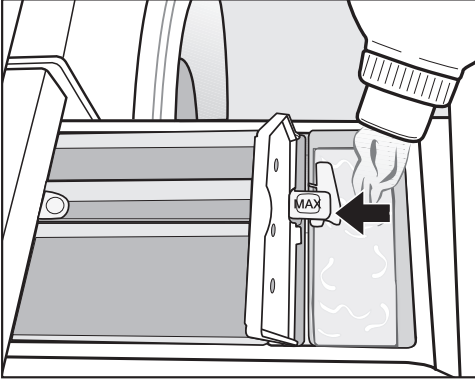

- Add fabric conditioner or liquid starch to the  compartment. **Do not exceed the maximum level mark.**
- Touch the *Start/Stop* sensor.

It will be automatically dispensed in the final rinse. At the end of the wash programme a small amount of water remains in the  compartment.

Adding starch separately

- Prepare the starch solution in accordance with the manufacturer's instructions on the packaging.
- Select the *Starch* programme.
- Add the prepared starch to compartment .
- Touch the *Start/Stop* sensor.

Tip: If starching separately or automatically, thoroughly clean the dispenser compartment, especially the siphon tube, regularly.

Dye removers and dyes

 Damage due to colour run/dye removers.

Colour run and dye removers can cause corrosion in the washing machine.

Do not use colour run or dye removers in this washing machine.

Only use dyes suitable for use in a washing machine. The manufacturer's instructions on the packaging must be observed.

External dispensing

The washing machine is pre-equipped for connecting to external detergent dispensing systems. A separate conversion kit for external dispensing systems is required. This must be fitted by Miele Service or by a Miele Service dealer.

6. Starting the programme – the end of the programme

Payment system

If your machine is connected to a payment system, the amount of payment required will appear in the display.

Do not cancel the programme once it has started. Depending on the settings, money may be lost in the payment system.

Starting the programme

The programme can be started as soon as the *Start/Stop* sensor is flashing on and off.

- Touch the *Start/Stop* sensor control.

The door will lock (🔒 symbol) and the programme will start.

If a delay start period has been selected, this will appear in the display.

Once the delay start period has elapsed (if applied), the programme duration will appear in the display; otherwise, the duration will appear straight away. The programme sequence is also shown in the display.

Tip: You can use the pull-down menu to display the selected temperature, spin speed and any selected Extras.

End of programme

The door remains locked during the anti-crease phase. However, the washing machine door can be unlocked at any time by touching the *Start/Stop* sensor.

Unloading the drum

- Pull open the door.
- Remove the laundry.

Items left in the drum could discolour other items in the next wash or become discoloured themselves. Remove all items from the drum.

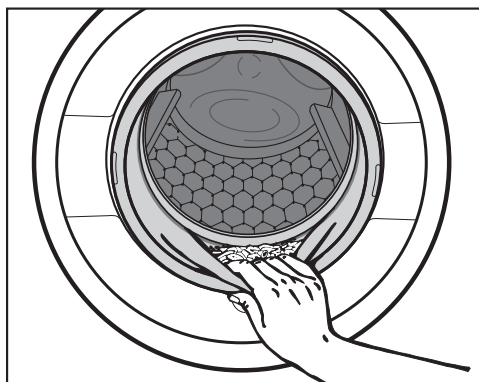

- Check the door seal for any foreign objects.

Tip: Leave the door slightly open to allow the drum to dry.

- Switch the washing machine off with the ① button.

Tip: Leave the detergent drawer slightly open to allow it to dry.



Before the programme starts, the timer can be used to select a programme start time or programme end time.

Setting the timer

- Touch the  timer sensor control.
- Select the option Finish at, Start in or Start at.
- Set the hours and the minutes with the *OK* sensor control.

Changing the timer

The selected delay start time period can be changed before the programme start.

- Touch the ,  or  sensor control.
- If required, change the specified time and confirm with the *OK* sensor control.

Deleting the timer

The selected delay start period can be cancelled before the programme starts.

- Touch the ,  or  sensor control.

The selected delay start period will appear in the display.

- Touch the *Delete* sensor control.
- Confirm with the *OK* sensor control.

The selected delay start period is deleted.

Starting the timer

- Touch the *Start/Stop* sensor control.

The door will lock and the time until the programme starts will appear in the display.

After the programme has started, the selected delay start period can only be changed or cancelled by interrupting the programme.

The programme can now be started at any time.

- Touch the *Start immediately* sensor control.

Programme chart

Programme packages

You can select various programmes from the programme packages. The programmes will appear in the programme list.

Standard programmes

Whites		65 °C to 90 °C	Max. load 7.0 kg
Use for	Textiles made from cotton and linen, e.g. bed linen, baby clothes, underwear		
Tip	An additional pre-rinse can be programmed in.*		
1600 rpm	Extras: Pre-wash, Intensive, Water plus, Rinse hold, Starch stop	Rinses: 1–5*	
Coloured items		Cold to 60 °C	Max. load 7.0 kg
Items	Cotton or mixed fibre textiles, e.g. t-shirts, trousers		
Tip	<ul style="list-style-type: none"> - For dark-coloured fabric, use a colour detergent or liquid detergent. - An additional pre-rinse can be programmed in.* 		
1600 rpm	Extras: Pre-wash, Intensive, Water plus, Rinse hold, Starch stop	Rinses: 1–5*	
Coloured items sensitive		Cold to 90 °C	Max. load 7.0 kg
Use for	Cotton or mixed fibre textiles		
Tip	Coloured items programme for all temperature ranges with particularly good rinse results.		
1600 rpm	Extras: Pre-wash, Intensive, Water plus, Rinse hold, Rinse plus, Starch stop	Rinses: 2	
Minimum iron		Cold to 60 °C	Max. load 3.5 kg
Items	Synthetic and mixed fibre textiles and easy care cotton		
Tip	<ul style="list-style-type: none"> - Reduce the spin speed for fabric that creases easily. - An additional pre-rinse can be programmed in.* 		
1200 rpm	Extras: Pre-wash, Intensive, Water plus, Pre-ironing, Rinse hold	Rinses: 2–4*	

* Settings can be altered in Supervisor level.



Programme chart

Delicates			Cold to 60 °C	Max. load 2.5 kg
Use for	Delicate garments made from synthetic fibres, mixed fibres and viscose			
Tip	- Deselect the final spin speed for fabric that creases easily.			
600 rpm	Extras: Pre-wash, Rinse plus, Pre-Ironing, Rinse hold	Rinses: 2		
Express			Cold to 60 °C	Max. load 3.5 kg
Use for	Cotton garments that have hardly been worn or are only very lightly soiled			
1400 rpm	Extras: Rinse plus	Rinses: 1		
Woollens			Cold to 40 °C	Max. load 2.5 kg
Use for	Machine-washable woollens and woollen blends			
Tip	Use detergent formulated for woollens.			
1200 rpm	Extras: Rinse hold	Rinses: 2		
Towelling			40 °C to 60 °C	Max. load 7.0 kg
Use for	Towels and bathrobes made from terrycloth			
Tip	Use a colour detergent for dark textiles.			
1400 rpm	Extras: Pre-wash, Rinse hold	Rinses: 2		
Shirts			Cold to 60 °C	Max. load 2.5 kg
Items	Shirts and blouses			
Tip	<ul style="list-style-type: none"> - Pre-treat collars and cuffs depending on the level of soiling. - Wash silk shirts and blouses in the Silks programme. - Reduce the maximum load size by half if you have selected the <i>Pre-ironing</i> Extra. 			
800 rpm	Extras: Soak, Rinse plus, Pre-ironing, Rinse hold, Starch stop	Rinses: 2		
Dark garments			30 °C to 60 °C	Max. load 3.5 kg
Items	Black and dark items made from cotton or mixed fibres			
Tip	Wash inside out.			
1000 rpm	Extras: Soak, Rinse plus, Pre-ironing, Rinse hold	Rinses: 3		

Programme chart

Denim		30 °C to 60 °C	Max. load 3.5 kg
Use for	Denim shirts, blouses, trousers and jackets		
Tip	<ul style="list-style-type: none"> - Wash denim inside-out. - Denim often contains excess dye and may run during the first few washes. Wash light and dark coloured items separately. 		
1000 rpm	Extras: Rinse hold	Rinses: 3	
Silks		Cold to 30 °C	Max. load 2.5 kg
Use for	Silks and all hand-washable textiles which do not contain wool		
Tip	<ul style="list-style-type: none"> - Follow the instructions on the care label. - Place tights and bras in a washing bag. 		
600 rpm	Extras: Rinse plus, Rinse hold	Rinses: 2	
ECO 40-60		Max. load 7.0 kg	
Use for	Normally soiled cotton garments		
Tip	<ul style="list-style-type: none"> - A laundry load consisting of mixed cottons that are intended for washing at 40 °C or 60 °C can be washed in the same wash cycle. - This programme is the most efficient in terms of energy and water consumption for washing cottons. 		
1600 rpm	Extras: Pre-wash, Rinse hold	Rinse cycles: 2	
Cottons PRO		60 °C	Max. load 7.0 kg
Use for	Mixed fibre textiles (50 % cotton and 50 % polyester)		
Tip	<ul style="list-style-type: none"> - Extra energy-efficient wash programme for commercial cotton or cotton/synthetic blend textiles with normal levels of soiling, e.g. workwear. 		
1400 rpm	Extras: Pre-wash	Rinses: 2	
Separate rinse		Max. load 7.0 kg	
Items	Items which only need to be rinsed and spun		
Tip	<ul style="list-style-type: none"> - Observe the spin speed for items which crease easily. 		
1400 rpm	Extras: Rinse hold	Cycles: 2	

Programme chart

Starch		Cold to 40 °C	Max. load 3.5 kg
Use for	Table cloths, serviettes and workwear that need starching		
Tip	<ul style="list-style-type: none"> - Laundry that is to be starched should be washed but not treated with fabric conditioner. - Observe the spin for items which crease easily. 		
1200 rpm		Rinses: 1	
Clean machine		70 °C	No load
	For cleaning the suds container and the drainage system. <ul style="list-style-type: none"> - Add universal detergent to the compartment . - Use the <i>Clean machine</i> programme regularly if you frequently use disinfection programmes. 		
Drain/Spin			Max. load 7.0 kg
Tip	<ul style="list-style-type: none"> - Make sure you select the appropriate spin speed. - Drain only: Select 0 rpm for the spin speed. - Select the Rinse plus Extra for one rinse. 		
1600 rpm	Extras: Rinse plus		
Maintenance wash hygiene			No load
	<ul style="list-style-type: none"> - If a programme at a temperature below 60 °C has been used, a request to start the Maintenance wash hygiene programme appears in the display. The Hygiene setting must be switched on for this purpose (see “Supervisor level”). - Add universal detergent to the compartment . 		

Sport

Sportswear		30 °C to 60 °C	Max. load 3.0 kg
Use for	Sports and leisure wear, such as shirts and trousers made from synthetic fibres or mixed blends		
Tip	<ul style="list-style-type: none"> - If you wish to proof the items at the same time, add the proofing agent to the  compartment in the detergent drawer. - Do not use fabric conditioner. - Observe the instructions on the care label. 		
1000 rpm	Extras: Pre-wash, Soak, Rinse hold		Rinses: 2

Programme chart

SportMicrofibre		30 °C to 60 °C	Max. load 3.0 kg
Items	Clothing for sports and fitness such as tops, trousers and base layers made from microfibre		
Tip	<ul style="list-style-type: none"> - Do not use fabric conditioner. - Observe the instructions on the care label. 		
800 rpm	Extras: Rinse plus, Rinse hold	Rinses: 2	
Trainers		30 °C to 60 °C	Max. 2 pairs
Use for	Trainers (no leather shoes), shin pads, elbow protectors and similar items		
Tip	<ul style="list-style-type: none"> - Do not use fabric conditioner. - Coarse soiling should be brushed off first. - Observe the instructions on the care label. - Use the dryer basket for tumble drying. - Close Velcro fasteners. 		
400 rpm	Extras: Pre-wash, Pre-rinse	Rinses: 3	
Hard items		Cold to 40 °C	Max. load 3.0 kg
Use for	Washable plastic items, e.g. toy building blocks or casino chips, or even chain link safety gloves, etc.		
Tip	<ul style="list-style-type: none"> - Use the <i>Soak</i> Extra to loosen dirt. - Use detergent for delicates. 		
–	Extras: Pre-wash, Pre-rinse, Rinse plus	Rinses: 2	

Outerwear

Down-filled items		30 °C to 60 °C	Maximum of 1 article
Use for	Outdoor jackets, sleeping bags and other down-filled items		
Tip	<ul style="list-style-type: none"> - Observe the instructions on the care label. - Do not use fabric conditioner. - Remove any air before washing. To do this, either push the items into a narrow laundry bag to compress them or tie the items together with a washable strap. - The items are spun after wetting to remove any air. 		
1000 rpm	Extras: Pre-wash, Rinse plus, Rinse hold	Rinses: 2	

Programme chart

Outerwear		Cold to 40 °C	Max. load 3.0 kg
Items	Performance outerwear (e.g. outdoor jackets and trousers) made from membrane fabrics such as Gore-Tex®, SYMPATEX®, WIND-STOPPER®, etc.		
Tip	<ul style="list-style-type: none"> - Zip up or close any Velcro fasteners before washing. - Do not use fabric conditioner. - Use the <i>Proofing</i> programme to treat outerwear textiles at regular intervals. Proofing after each wash cycle is not recommended. - Wash down-filled items with the <i>Down filled items</i> programme. 		
1000 rpm	Extras: Pre-rinse, Soak, Rinse plus, Rinse hold	Rinses: 2	
Proofing		Cold to 40 °C	Max. load 3.0 kg
Items	Treating microfibre fabric, skiwear and table linen made from mainly synthetic fibres		
Tip	<ul style="list-style-type: none"> - Add proofing agent to the ☼ compartment. - The items should be freshly laundered and spun or dried before proofing. - To achieve an optimum effect, apply a thermal treatment to the articles by drying in a tumble dryer or ironing. 		
1000 rpm	Extras: Rinse hold	Rinses: 1	

Wellness/Hair salons

Towels		Cold to 40 °C	Max. load 5.5 kg
Use for	Lightly soiled cotton towelling		
Tip	Use a colour detergent for dark textiles.		
1400 rpm		Rinses: 2	
Towels plus		40 °C to 80 °C	Max. load 5.5 kg
Use for	Heavily soiled cotton towelling		
Tip	Use a colour detergent for dark textiles.		
1400 rpm	Extras: Pre-wash	Rinses: 2	
Capes		Cold to 30 °C	Max. load 2.0 kg
Use for	Lightly soiled hairdressers' capes made from synthetic fibres		
Tip	Select the <i>Extra Rinse plus</i> for extra good wash results		
600 rpm	Extras: Rinse plus	Rinses: 2	

Programme chart

Hotels

Bed linen		40 °C to 90 °C	Max. load 7.0 kg
Use for	Cotton or mixed fibre bed linen		
Tip	<ul style="list-style-type: none"> - The items are always soaked after the start. - Use a colour detergent for coloured textiles. 		
1400 rpm	Extras: Pre-wash, Soak, Rinse plus, Pre-Ironing	Rinses: 2	
Table linen		40 °C to 75 °C	Max. load 3.5 kg
Items	Tablecloths and serviettes made from cotton, linen and mixed fibres		
Tip	<ul style="list-style-type: none"> - Select Pre-wash for stubborn soiling. Use detergent with enzymes for the pre-wash. - The items are always soaked after the start. 		
1000 rpm	Extras: Pre-wash, Rinse plus, Soak, Intensive, Pre-ironing, Rinse hold, Starch stop	Rinse cycles: 2	
Kitchen linen		60 °C to 85 °C	Max. load 7.0 kg
Items	Cotton or linen kitchen linen, e.g. chef's jackets and trousers, chef's hats, cleaning cloths		
Tip	<ul style="list-style-type: none"> - Select Pre-wash for stubborn soiling. Use detergent with enzymes for the pre-wash. - A pre-wash cycle is carried out before the main wash. 		
1200 rpm	Extras: Pre-wash, Soak, Intensive	Rinse cycles: 3	

Home textiles

Lightweight curtains		Cold to 40 °C	Max. load 2.5 kg
Use for	Curtains specified as machine-washable by the manufacturer		
Tip	For curtains which crease easily, deselect the spin function.		
600 rpm	Extras: Pre-wash, Rinse plus, Rinse hold	Rinses: 3	
Curtains		Cold to 40 °C	Max. load 2.5 kg
Use for	Curtains specified as machine-washable by the manufacturer		
Tip	For curtains which crease easily, reduce the spin speed or deselect the spin.		
800 rpm	Extras: Pre-wash, Pre-rinse, Rinse hold	Rinses: 3	

Programme chart

Down bedding		40 °C to 75 °C	1 duvet
Items	Down-filled duvets		
Tip	<ul style="list-style-type: none"> - Follow the instructions on the care label. - Remove any air before washing. To do this either push the laundry items into a narrow laundry bag to compress them or tie them together with a washable strap. - The items are spun after wetting to remove any air. 		
1400 rpm	Extras: Rinse hold	Cycles: 3	
Synthetic bedding		40 °C to 75 °C	Max. 7.0 kg or 1 duvet
Items	Bed linen made from microfibre and duvets with a synthetic filling		
Tip	<ul style="list-style-type: none"> - Follow the instructions on the care label. - Use liquid detergent. 		
800 rpm	Extras: Pre-wash, Soak, Rinse plus, Rinse hold	Rinses: 2	
Pillows		Cold to 60 °C	1–2 pillows
Use for	Washable pillows with a down or synthetic filling		
Tip	<ul style="list-style-type: none"> - Follow the instructions on the care label. - Remove any air before washing. To do this, either push the items into a narrow laundry bag to compress them or tie the items together with a washable strap. - The items are spun after wetting to remove any air. 		
1400 rpm	Extras: Pre-wash	Rinses: 3	
Bedspreads		40 °C to 75 °C	Max. load 3.5 kg
Use for	Synthetic or woollen bedspreads, e.g. day blankets		
Tip	Gentle wash programme for covers with delicate fillings.		
800 rpm	Extras: Pre-rinse, Rinse hold	Rinses: 3	

* 1 pillow (80 x 80 cm) or 2 pillows (40 x 80 cm)

Programme chart

Workwear

Oil/fat special		60 °C to 90 °C	Max. load 7.0 kg
Use for	Work coats, jackets, hats, cleaning cloths made from cotton or mixed fibres		
Tip	<ul style="list-style-type: none"> - Activate Pre-wash for heavy contamination. - Use special detergent to improve the wash results. 		
1400 rpm	Extras: Pre-wash, Soak, Intensive, Rinse plus, Rinse hold	Rinses: 3	
Dust/Flour special		40 °C to 90 °C	Max. load 7.0 kg
Use for	Cotton or mixed fibre workwear, table cloths or cleaning cloths soiled with dust or flour		
Tip	<ul style="list-style-type: none"> - Select Pre-rinse for very heavy levels of soiling. - Activate Pre-wash for stubborn soiling. 		
1400 rpm	Extras: Pre-wash, Pre-rinse, Soak, Intensive, Rinse plus, Rinse hold	Rinses: 2	
Intensive wash		40 °C to 90 °C	Max. load 7.0 kg
Use for	Heavily soiled workwear made from cotton, linen and mixed fibres		
Tip	You can achieve particularly good wash and rinse results with a high water level.		
1400 rpm	Extras: Pre-wash, Soak, Rinse plus, Rinse hold	Rinses: 2	

Disinfection/RKI

Dis. RKI		85 °C/15 min	Max. load 7.0 kg
Use for	Cotton, linen, and mixed fibre textiles		
Tip	<ul style="list-style-type: none"> - Thermal disinfection with a 15-minute holding time at 85 °C. - Single-bath disinfection process. - No water intake via the fabric conditioner compartment. 		
1400 rpm	Extras: Soak	Rinses: 2	

Programme chart

☞ Dis. RKI		70 °C/10 min	Max. load 7.0 kg
Use for	Cotton or mixed fibre textiles, sorted by colour, provided they are suitable for disinfection.		
Tip	<ul style="list-style-type: none"> - Chemo-thermal disinfection with a 10-minute holding time at 70 °C. - Single-bath disinfection process. - Use a detergent approved by the Robert Koch Institute. - No water intake via the fabric conditioner compartment. 		
1400 rpm	Extras: Soak	Rinses: 3	
☞ Dis. RKI		60 °C/20 min	Max. load 7.0 kg
Use for	Cotton or mixed fibre textiles, sorted by colour, provided they are suitable for disinfection.		
Tip	<ul style="list-style-type: none"> - Chemo-thermal disinfection with a 20-minute holding time at 60 °C. - Single-bath disinfection process. - Use a detergent approved by the Robert Koch Institute. - No water intake via the fabric conditioner compartment. 		
1400 rpm	Extras: Soak	Rinses: 3	
☞ Dis. RKI		40 °C/20 min	Max. load 7.0 kg
Use for	Cotton or mixed fibre textiles, sorted by colour, provided they are suitable for disinfection.		
Tip	<ul style="list-style-type: none"> - Chemo-thermal disinfection with a 20-minute holding time at 40 °C. - Single-bath disinfection process - Use a detergent approved by the Robert Koch Institute. - No water intake via the fabric conditioner compartment. 		
1400 rpm	Extras: Soak	Rinses: 3	

Programme chart



Laundry (HTM 01-04)

Disinfection 71 °C		71 °C	Max. load 4.0 kg
Use for	Cotton or mixed fibre textiles, sorted by colour, provided they are suitable for disinfection.		
Tip	<ul style="list-style-type: none"> - Disinfection with a 3-minute holding time at 71 °C. - The spin speed cannot be modified. - No water intake via the fabric conditioner compartment. 		
1400 rpm	Extras: Pre-wash, Pre-rinse	Rinses: 3	
Disinfection 65 °C		65 °C	Max. load 4.0 kg
Use for	Cotton or mixed fibre textiles, sorted by colour, provided they are suitable for disinfection.		
Tip	<ul style="list-style-type: none"> - Disinfection with a 10-minute holding time at 65 °C. - The spin speed cannot be modified. - No water intake via the fabric conditioner compartment. 		
1400 rpm	Extras: Pre-wash, Pre-rinse	Rinses: 3	
MRSA		40 °C	Max. load 4.0 kg
Use for	Minimum-iron textiles, sorted by colour, provided they are suitable for disinfection.		
Tip	<ul style="list-style-type: none"> - Add MRSA disinfectants to the fabric softener compartment. - The spin speed cannot be modified. 		
1000 rpm		Rinses: 3	

Disinfection

 Disinfection	85 °C/15 min	Max. load 7.0 kg
Use for	Cotton, linen, and mixed fibre textiles	
Tip	<ul style="list-style-type: none"> - Thermal disinfection with a 15-minute holding time at 85 °C. - No water intake via the fabric conditioner compartment. 	
1400 rpm	Extras: Pre-wash, Pre-rinse, Rinse plus	Rinses: 2



Programme chart

 Disinfection		70 °C/10 min	Max. load 7.0 kg
Use for	Cotton or mixed fibre textiles, sorted by colour, provided they are suitable for disinfection.		
Tip	<ul style="list-style-type: none"> - Chemo-thermal disinfection with a 10-minute holding time at 70 °C. - No water intake via the fabric conditioner compartment. 		
1400 rpm	Extras: Pre-wash, Pre-rinse, Rinse plus	Rinses: 2	
 Disinfection		60 °C/20 min	Max. load 7.0 kg
Use for	Cotton or mixed fibre textiles, sorted by colour, provided they are suitable for disinfection.		
Tip	<ul style="list-style-type: none"> - Chemo-thermal disinfection with a 20-minute holding time at 60 °C. - No water intake via the fabric conditioner compartment. 		
1400 rpm	Extras: Pre-wash, Pre-rinse, Rinse plus	Rinses: 2	
 Disinfection		40 °C/20 min	Max. load 7.0 kg
Use for	Cotton or mixed fibre textiles, sorted by colour, provided they are suitable for disinfection.		
Tip	<ul style="list-style-type: none"> - Chemo-thermal disinfection with a 20-minute holding time at 40 °C. - No water intake via the fabric conditioner compartment. - An extra gentle washing programme allows you to wash even more sensitive textiles. 		
1400 rpm	Extras: Pre-wash, Pre-rinse, Rinse plus	Rinses: 2	

Further programmes

 Disinfection		80 °C/10 min	Max. load 7.0 kg
Use for	Cotton, linen, and mixed fibre textiles		
Tip	<ul style="list-style-type: none"> - Thermal disinfection with a 10-minute holding time at 80 °C. - No water intake via the fabric conditioner compartment. 		
1400 rpm	Extras: Pre-wash, Pre-rinse	Rinses: 2	

Programme chart

 Disinfection		75 °C/10 min	Max. load 7.0 kg
Items	Cotton, linen and mixed fibre textiles		
Tip	<ul style="list-style-type: none"> - Thermal disinfection with a 10-minute holding time at 75 °C. - No water intake via the fabric conditioner compartment. 		
1400 rpm	Extras: Pre-wash, Pre-rinse, Rinse plus	Rinses: 2	
 Disinfection		70 °C/17 min	Max. load 7.0 kg
Items	Cotton or mixed fibre textiles		
Tip	<ul style="list-style-type: none"> - Thermal disinfection with a 17-minute holding time at 70 °C. - No water intake via the fabric conditioner compartment. 		
1400 rpm	Extras: Pre-wash, Pre-rinse, Rinse plus	Rinses: 2	
Dental surgery garments		60 °C/60 min	Max. load 7.0 kg
Use for	Cotton or mixed fibre textiles, sorted by colour, provided they are suitable for disinfection.		
Tip	<ul style="list-style-type: none"> - Chemo-thermal disinfection with a 60-minute holding time at 60 °C. - No water intake via the fabric conditioner compartment. 		
1400 rpm	Extras: Pre-wash, Pre-rinse, Rinse plus	Rinses: 2	

WetCare

WetCare sensitive		Cold to 30 °C	Max. load 4.0 kg
Use for	Outerwear that cannot be washed, e.g. suits, smart dresses marked with the care symbol 		
Tip	<ul style="list-style-type: none"> - A finishing bath is applied after washing. - Use a liquid finishing agent for impregnation; add the detergent to the fabric softener compartment. 		
1100 rpm	Extras: Rinse hold	Rinses: 1	
WetCare Silks		Cold to 30 °C	Max. load 3.0 kg
Use for	Textiles or silk items that cannot be washed and are prone to creasing		
Tip	<ul style="list-style-type: none"> - A finishing bath is applied after washing. - Use a liquid finishing agent for impregnation; add the detergent to the fabric softener compartment. 		
600 rpm	Extras: Rinse hold	Rinses: 1	

Programme chart

WetCare Intensive		30 °C to 40 °C	Max. load 4.0 kg
Use for	Heavily soiled outerwear that cannot be washed		
Tip	<ul style="list-style-type: none"> - A finishing bath is applied after washing. - Use a liquid finishing agent for impregnation; add the detergent to the fabric softener compartment. 		
1100 rpm	Extras: Pre-wash, Rinse hold	Rinses: 2	
WetCare Disinfection		40 °C	Max. load 4.0 kg
Use for	Outerwear that cannot be washed and that is marked with the care symbol (W)		
Tip	- Textiles are washed and disinfected (40 °C for 20 minutes).		
1100 rpm	Extras: Pre-wash	Rinses: 2	
WetCare Hygiene		20 °C to 30 °C	Max. load 4.0 kg
Use for	Sensitive textiles, e.g. outerwear		
Tip	- Textiles are washed and disinfected following the addition of a disinfectant during the rinse phase.		
1100 rpm	Extras: Rinse hold	Rinses: 2	

Programme chart

Special programmes

You can put together 5 special programmes and assign your own programme names. Enter these into the tables.

Load: max. 7.0 kg

Example: *Intensive Plus*

- Pre-wash intensive
- Intensive wash, 90 °C
- Rinse 1
- Rinse 2
- Rinse 3
- Pre-treat
- Spin, 1400 rpm

(1)

-
-
-
-
-
-
-

(2)

-
-
-
-
-
-
-

(3)

-
-
-
-
-
-
-

(4)

-
-
-
-
-
-
-

(5)

-
-
-
-
-
-
-

The 5 special programmes are pre-programmed at the factory, see “Supervisor level”.

You can add Extras to the wash programmes.

Not all Extras can be selected with every programme. If an Extra is not listed, it is not permitted for use with the wash programme in question.

Selecting Extras

- Touch the Extras sensor control.
- Select one or more of the Extras available.
- Confirm with the *OK* sensor control if several Extras are available.

Pre-wash

A Pre-wash can be added for heavily soiled laundry. Coarse soiling is loosened and removed before the main wash.

Pre-rinse

The laundry is rinsed before the main wash to remove larger quantities of soiling, e.g. dust, sand.

Rinse plus

An extra rinse can be activated to achieve a better wash result.

Soak

For heavily soiled and stained items with protein stains. The soak duration is 10 minutes.

Intensive



For hard-wearing laundry that is very heavily soiled. Cleaning efficiency is increased through more intense mechanical action and the application of more heat energy.

Water plus

The water level in the main wash and the rinses will be increased.

Pre-ironing

In order to reduce creasing, the laundry undergoes a smoothing process at the end of the programme. Reducing the maximum load by 50 % will achieve a better result. Small loads achieve a better result.

The textiles must be suitable for drying in a tumble dryer  and suitable for ironing .

Rinse hold

The laundry is not spun after the final rinse and remains in the rinse water. This helps prevent creasing if the laundry is not going to be removed from the drum immediately after the end of the programme.

Starch stop

Water is drained out of the machine before the last rinse and the programme stops. The prepared starch is added directly to the drum. The programme is continued with the *Start/Stop* sensor control.

Special features in the programme sequence

Spinning

Final spin speed

When a programme is selected, the maximum spin speed for this wash programme is shown in the display.

You can reduce the final spin speed.

However, you cannot select a final spin speed higher than that shown in the chart.

Interim spin

There is a spin cycle after the main wash and between the rinses. A reduction in the final spin speed will also reduce the interim spin speed as appropriate.

Omitting the interim spin and the final spin

- Select the programme setting *Spin speed 0*.

After the last rinse, the water will be pumped away and the anti-crease phase will switch on.

Anti-crease

At the end of the programme, the drum continues to turn at intervals for up to 30 minutes to help prevent creasing. The washing machine can be opened at any time.

There is no anti-crease phase at the end of some programmes.
--

Changing the programme sequence

A programme cannot be cancelled or changed when operating a payment system.

If the washing machine is switched off during active programme operation, the standby function does not switch the washing machine off completely after 15 minutes. Safety functions continue to be active because there may still be water inside the drum.

Changing a programme

A programme can no longer be changed once it has been successfully started.

You will need to cancel the current programme before you can select a new one.

Cancelling a programme

You can cancel a wash programme at any time after it has started.

- Touch the *Start/Stop* sensor control.

The following will appear in the display:

i Cancel programme?

- Select *yes*.

The following will appear in the display:

Programme cancelled.

The suds will be pumped away.

- Wait until the door unlocks.
- Pull open the door.
- Remove the laundry.

Switching on the washing machine after an interruption to the power supply

If the washing machine is switched off with the **⓪** button during a wash programme, the programme will be interrupted.

- Switch the washing machine back on with the **⓪** button.
- Note the message in the display.
- Touch the *Start/Stop* sensor.

The programme will also be interrupted if power is interrupted by a power cut.

- When power is resumed, confirm the message in the display with *OK*.
- Touch the *Start/Stop* sensor.

The programme continues.

Changing the programme sequence

Adding or removing laundry

You can add or remove laundry items during the first few minutes after the programme has started.

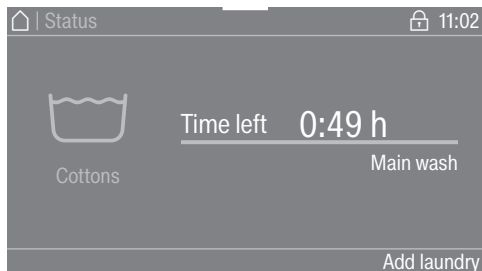

- Touch the Add laundry sensor control.

If the message Add laundry is not visible in the display then it is no longer possible to add items of laundry.

The programme will stop and the door will unlock.

 Risk of chemical burns from detergent.

When adding or removing laundry, your skin may come into contact with detergent, particularly if the detergent is dispensed externally.

Take care when placing your hands inside the drum.

If suds have come into contact with the skin, rinse off immediately with plenty of lukewarm water.

- Pull open the door.
- Add laundry or remove individual items.
- Close the door.
- Touch the *Start/Stop* sensor control.

The programme will continue.

The safety lock will remain activated if the temperature in the drum is above 55 °C. The lock will not deactivate until the temperature has dropped to below 55 °C.

⚠ Risk of electric shock.

Only ever perform cleaning and maintenance work when the appliance is disconnected from the power.

Disconnect the washing machine from the mains electricity supply.

Cleaning the casing and fascia panel

⚠ Damage caused by detergents.

Solvent-based cleaning agents, abrasive cleaners, glass cleaners or multi-purpose cleaning agents can cause damage to plastic surfaces and other parts.

Do not use any of these cleaning agents.

⚠ Risk of damage due to ingress of water.

The pressure of a water jet can cause water to get into the washing machine, resulting in damage to components.

Do not spray the washing machine with a water jet.

- Clean the casing and fascia panel with a mild cleaning agent or soap and water and dry both with a soft cloth.
- The drum and any other stainless steel components can be cleaned using a suitable stainless-steel cleaning agent.

Cleaning the detergent drawer

Washing at low temperatures and the use of liquid detergent can lead to a build-up of mould and bacteria in the detergent drawer.

- For hygiene reasons, clean the entire detergent drawer at regular intervals.

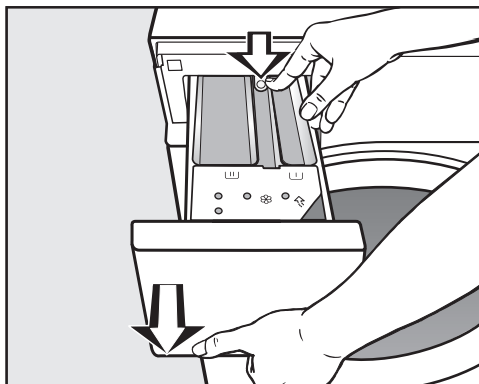

- Pull out the detergent drawer until resistance is felt. Press down the release button and at the same time pull the drawer right out of the machine.
- Clean the detergent drawer with warm water.

Cleaning and care

Cleaning the siphon and the channel

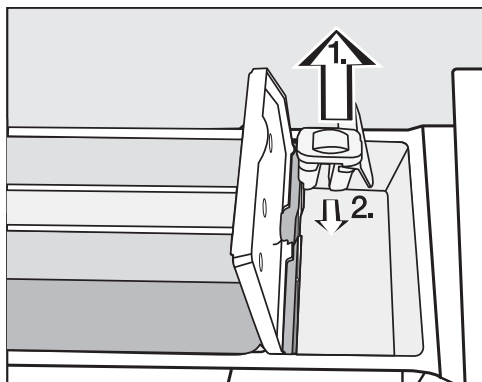

- Pull the siphon out of the ☼ compartment .
Clean the siphon under warm running water.
- Refit the siphon.
- Clean the fabric conditioner channel using a brush and warm water.

Cleaning the detergent dispenser drawer compartment

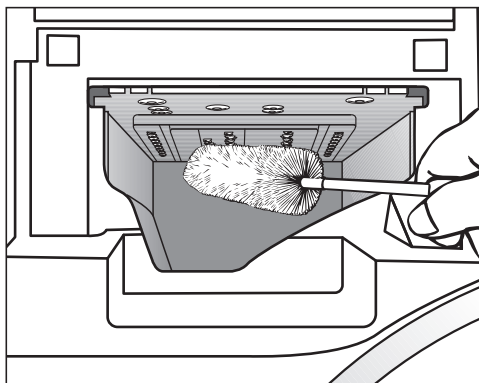

- Use a bottle brush to remove detergent residues and limescale from the jets inside the detergent drawer.
- Replace the detergent drawer.

Tip: Leave the detergent drawer slightly open to allow it to dry.

Cleaning the drum, suds container and drainage system

By using wash programmes with temperatures of 60 °C or higher on a regular basis and using a multi-purpose detergent, you can avoid a build-up of bacteria in the washing machine.

Use the *Maintenance wash* programme regularly, especially if you frequently use wash programmes with low temperatures.

Optimum results can be achieved by using a machine cleaner. Alternatively, a multi-purpose powder detergent can be used.

- Start the *Maintenance wash* programme.
- Dispense the machine cleaner or multi-purpose detergent directly into the drum.
- Do **not** load any laundry. The drum must be empty for the maintenance wash programme.
- At the end of the programme, check the inner drum and remove any coarse residues.

Use the *Maintenance wash* programme regularly if you frequently use disinfection programmes.

Cleaning the sealing ring

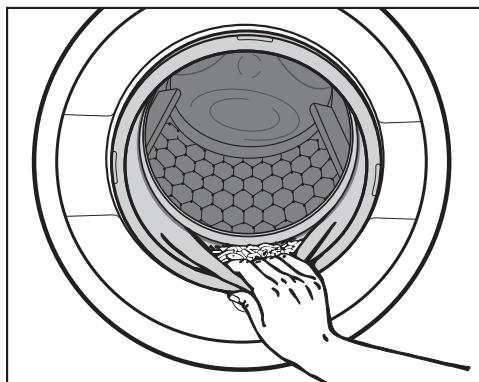

- Check the fold in the sealing ring for foreign objects.
- Clean the sealing ring and the inner fold of the sealing ring with a damp cloth.

Tip: Leave the door slightly open to allow the drum to dry.

Cleaning and care

Cleaning the water inlet filters

The washing machine has filters to protect the water intake valves. Check these filters every 6 months or so. Perform this check more often if there are frequent interruptions to the external water supply.

Cleaning the filters in the water inlet valves

- Using pliers, carefully loosen the nut on the intake valve and unscrew.

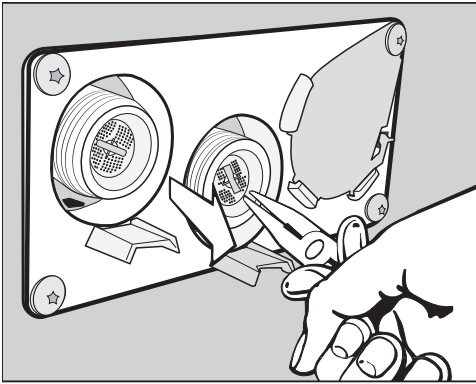



- Use pointed pliers to grip the bar and pull out the filter; then clean the filter. Reassemble in reverse order.

The filters must be put back in place after cleaning.

You are able to correct the majority of faults and problems that arise during day-to-day use without external assistance. You can save time and money in many cases, as you do not need to call Miele Service.





The following tables are designed to help you to find the cause of a malfunction or a fault and to resolve it.

The wash programme does not start

Problem	Cause and remedy
The display remains dark, and the <i>Start/Stop</i> sensor control does not light up or flash.	There is no power to the machine. <ul style="list-style-type: none"> ■ Check whether the washing machine is switched on. ■ Check whether the washing machine is connected to the power supply. ■ Check whether the main fuse or circuit breaker has tripped.
	The washing machine has switched off automatically to save energy. <ul style="list-style-type: none"> ■ Switch the washing machine back on with the  button.
The following appears in the display:  Door will not lock. Call Service.	The door is not closed properly. The door lock could not engage. <ul style="list-style-type: none"> ■ Close the door again. ■ Start the programme again. If the fault message appears again, contact Miele Service.
The programme does not start when <i>Spin</i> has been selected.	You have not yet completed the initial commissioning process. <ul style="list-style-type: none"> ■ Perform the <i>Initial commissioning process</i> as described in these instructions.
The display is dark and the <i>Start/Stop</i> sensor control is flashing slowly.	The display has switched off automatically to save energy. <ul style="list-style-type: none"> ■ Touch any of the controls. The display switches back on.

Problem solving guide

Programme cancellation and error message

Problem	Cause and remedy
 Drainage fault. Clean drain filter and pump. Check drain hose.	The drain is blocked or restricted. The drain hose has been fixed too high. <ul style="list-style-type: none"> ■ Clean the drain filter and the drain pump. ■ The maximum drain height is 1 m.
 Water intake fault. Open stopcock.	The water intake is blocked or restricted. <ul style="list-style-type: none"> ■ Check whether the stopcock has been properly opened. ■ Check whether the intake hose is kinked.
	The water pressure is too low. <ul style="list-style-type: none"> ■ Switch on the Low water pressure setting (see “Low water pressure” under “Supervisor level”).
	The filters in the water intake are blocked. <ul style="list-style-type: none"> ■ Clean the filters (see “Cleaning the filters” under “Cleaning and care”).
 Waterproof system activated	The water protection system has reacted. <ul style="list-style-type: none"> ■ Close the stopcock. ■ Call Miele Service.
 Disinfection temperature not reached	The required temperature was not reached during the disinfection programme. <ul style="list-style-type: none"> ■ The washing machine has not carried out the disinfection cycle correctly. ■ Start the programme again.
 Fault F. If restart fails, call Service	There is a fault. <ul style="list-style-type: none"> ■ Disconnect the washing machine from the mains electricity supply. ■ Wait at least 2 minutes before reconnecting the washing machine to the mains electricity supply. ■ Switch the washing machine on again. ■ Start the programme again. If the fault message appears again, contact Miele Service.

A fault message appears in the display¹⁾

Problem	Cause and remedy
i Container empty	One of the external detergent containers is empty. <ul style="list-style-type: none"> ■ Refill the detergent container.
i Hygiene info: Run the "Maintenance wash hygiene" programme, or a programme of at least 60°C	During the last wash, a wash programme with a temperature below 60 °C or the <i>Drain/Spin</i> programme was selected. <ul style="list-style-type: none"> ■ Start a programme with a minimum temperature of 60 °C or the Maintenance wash hygiene programme.
i Check hot water intake	The hot water supply is blocked or restricted. <ul style="list-style-type: none"> ■ Check whether the hot water stopcock has been properly opened. ■ Check whether the intake hose is kinked.
i Align the machine. Laundry not properly spun	The selected spin speed was not reached during the final spin due to excessive imbalance. <ul style="list-style-type: none"> ■ Check that the washing machine is level. ■ Start the spin cycle again.
i Machine is leaking	The washing machine or drain valve is leaking. <ul style="list-style-type: none"> ■ Close the stopcock. ■ Call Miele Service.



¹⁾ The messages will appear at the end of the programme and when the washing machine is switched on and must be acknowledged with the *OK* sensor control.

Problem solving guide

An unsatisfactory wash result

Problem	Cause and remedy
<p>Liquid detergent does not give the required result.</p>	<p>Liquid detergents usually contain no bleaching agents. They do not remove fruit, coffee, and tea stains.</p> <ul style="list-style-type: none"> ■ Use a general purpose powder detergent containing a bleaching agent. ■ Pour stain removers into the (U) drawer in the dispenser compartment and liquid detergent into a dispenser ball. ■ Never put stain removers and liquid detergent together in the dispenser drawer.
<p>White residues which look like powder detergent are seen on dark textiles after washing.</p>	<p>The detergent contained compounds (zeolites) to aid water softening which are not soluble in water. These have ended up on the laundry.</p> <ul style="list-style-type: none"> ■ Try to brush off the residues with a soft brush once the laundry is dry. ■ In future, wash dark textiles using a detergent which contains no zeolites. Liquid detergents usually contain no zeolites.
<p>Textiles with particularly greasy soiling are not properly clean.</p>	<ul style="list-style-type: none"> ■ Select a programme with pre-wash. Use liquid detergent for the pre-wash. ■ Continue to use universal powder detergent for the main wash. <p>The use of heavy-duty detergent is recommended in the main wash for very heavily soiled work clothing. Please seek advice from the detergent manufacturer.</p>
<p>Grey, greasy particles cling to washed laundry.</p>	<p>Insufficient amounts of detergent were used. The laundry was heavily soiled with grease (oils, ointments).</p> <ul style="list-style-type: none"> ■ Use more detergent or use liquid detergent with this type of soiled laundry. ■ Before washing the next load, run a 60 °C programme with liquid detergent but without a load.

General problems

Problem	Cause and remedy
The machine shakes during the spin cycle.	The machine feet are not level and not secured. <ul style="list-style-type: none"> ■ Level the machine and adjust the feet correctly.
Strange pump noises can be heard.	This is not a fault. These slurping noises occur at the start and end of a pump sequence as a normal part of the operation.
Large amounts of detergent residue remain in the detergent dispenser drawer.	The water pressure is too low. <ul style="list-style-type: none"> ■ Clean the filters in the water inlet.
	Powder detergent used in conjunction with water softeners tends to become sticky. <ul style="list-style-type: none"> ■ Clean the detergent dispenser drawer and, in future, add detergent into the drawer first, and then add the water softener.
Fabric softener is not completely dispensed or too much water remains in the  compartment.	The siphon tube is not correctly positioned or is clogged. <ul style="list-style-type: none"> ■ Clean the siphon, see “Cleaning and care – Cleaning the detergent dispenser compartment”.
The display is in a different language.	A different language has been selected. <ul style="list-style-type: none"> ■ Switch the washing machine off and on again. <p>The selected operator language appears in the display.</p>
	The operator language has been changed. <ul style="list-style-type: none"> ■ Select the language you require (see “Language” under “Supervisor level”).
The laundry has not been spun properly. The laundry is still wet.	The machine detected a high level of imbalance during the final spin and reduced the spin speed automatically. <ul style="list-style-type: none"> ■ Include both large and small items in the load as this will achieve better distribution.
The drum remains stationary but the programme keeps running.	<ul style="list-style-type: none"> ■ Switch the washing machine off and then back on with the  button. ■ Note the message in the display. ■ Touch the <i>Start/Stop</i> sensor control. <p>The drum continues to spin and the programme continues.</p>

Problem solving guide

The door will not open

Problem	Cause and remedy
The door cannot be pulled open during a programme.	The door is locked during the wash programme. <ul style="list-style-type: none">■ Touch the <i>Start/Stop</i> sensor control.■ Select <i>Cancel programme</i> or <i>Add laundry</i>. The door will unlock and you will be able to pull it open.
	There is still water in the drum and the machine is unable to drain. <ul style="list-style-type: none">■ Clean the drainage system as described under “Opening the door in the event of a blocked drain outlet and/or power cut”.
At the end of a programme or when a programme is cancelled, the following appears in the display: Cool down or Comfort cooling.	To protect the user against scalding, the door cannot be opened if the suds temperature is higher than 55 °C. <ul style="list-style-type: none">■ Wait until the temperature in the drum has decreased and the message has gone out in the display.
The following appears in the display:  The door lock is jammed. Call Service.	The door lock has jammed. <ul style="list-style-type: none">■ Call Miele Service.

Opening the door in the event of a blocked drain outlet and/or power cut

 Risk of electric shock.

Only ever perform cleaning and maintenance work when the appliance is disconnected from the power.

Disconnect the washing machine from the mains electricity supply.

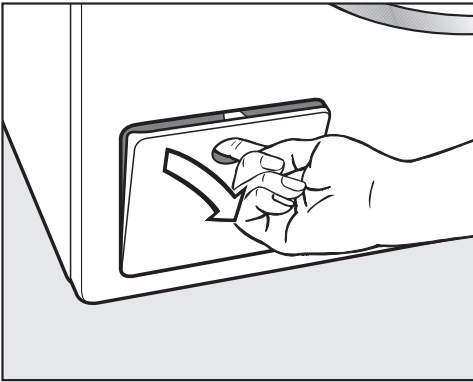

- Open the access panel to the drain system.

Blocked drain outlet

If the drain outlet is blocked, there may be a large quantity of water (max. 30 l) left behind in the washing machine.

 Risk of scalding due to hot suds.

Escaping suds will be hot if laundry has been washed at high temperatures.

Carefully allow all suds to drain off.

Emptying the drum

....For machines with a drain pump

- Place a suitable container under the access flap.

Remove the drain filter, though not completely.

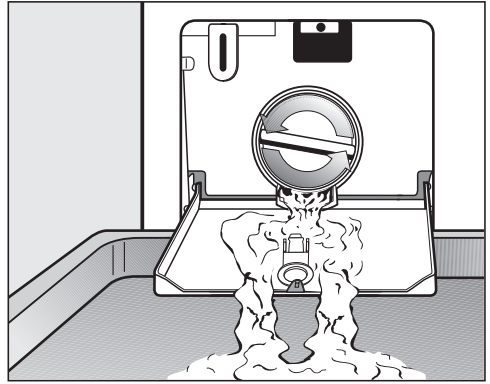

- Slowly unscrew the drain filter to let the water out.
- Tighten the drain filter back up again if you need to interrupt the flow of water.

Problem solving guide

Cleaning the drain filter

Once the flow of water ceases:

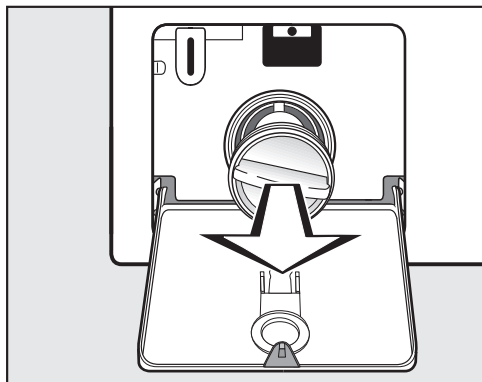

- Remove the drain filter completely.
- Clean the drain filter thoroughly.

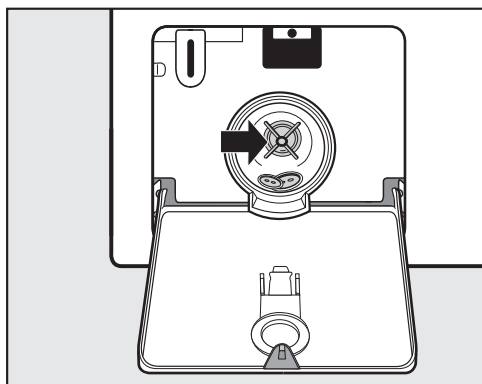

- Check the drain pump impellers to make sure they can rotate freely.
- Remove any foreign objects (e.g. buttons, coins, etc.) and clean the interior.
- Put the drain filter back in place and secure it.

⚠ Water damage.

Water will escape from the machine if you forget to replace the drain filter. Replace the drain filter correctly and tighten it securely.

Opening the door

⚠ Danger of injury due to rotating drum.

Reaching into a moving drum is extremely dangerous.

Always make sure that the drum is stationary before reaching in to remove laundry.

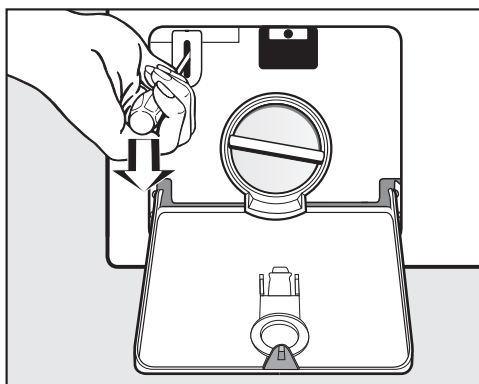

- Use a screwdriver to unlock the door.
- Pull open the door.

Emptying the drum

...In machines with a drain valve

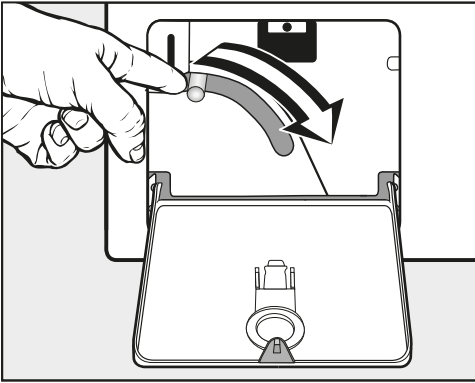

- Push the emergency drain lever downwards and hold until no more water runs out.

Opening the door

 Danger of injury due to rotating drum.

Reaching into a moving drum is extremely dangerous.

Always make sure that the drum is stationary before reaching in to remove laundry.

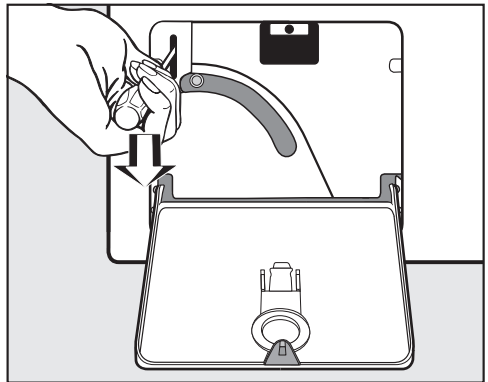

- Use a screwdriver to unlock the door.
- Pull open the door.

Miele Service

Contact in case of malfunction

In the event of any faults which you cannot remedy yourself, please contact your Miele Dealer or Miele Service.

Contact information for Miele Service can be found at the end of this document.

Please quote the model and serial number of your appliance when contacting Miele Service. This information can be found on the data plate.

The data plate is found above the porthole glass when the washing machine door is opened:

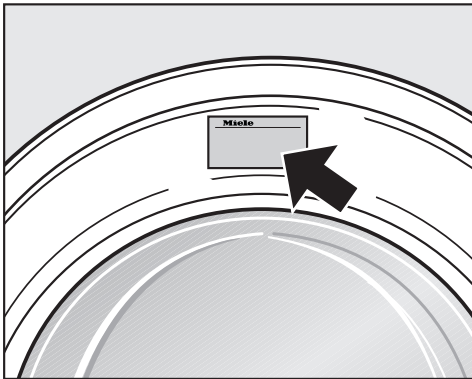

Optional accessories

Optional spare parts and accessories for this washing machine are available from Miele.

Front view

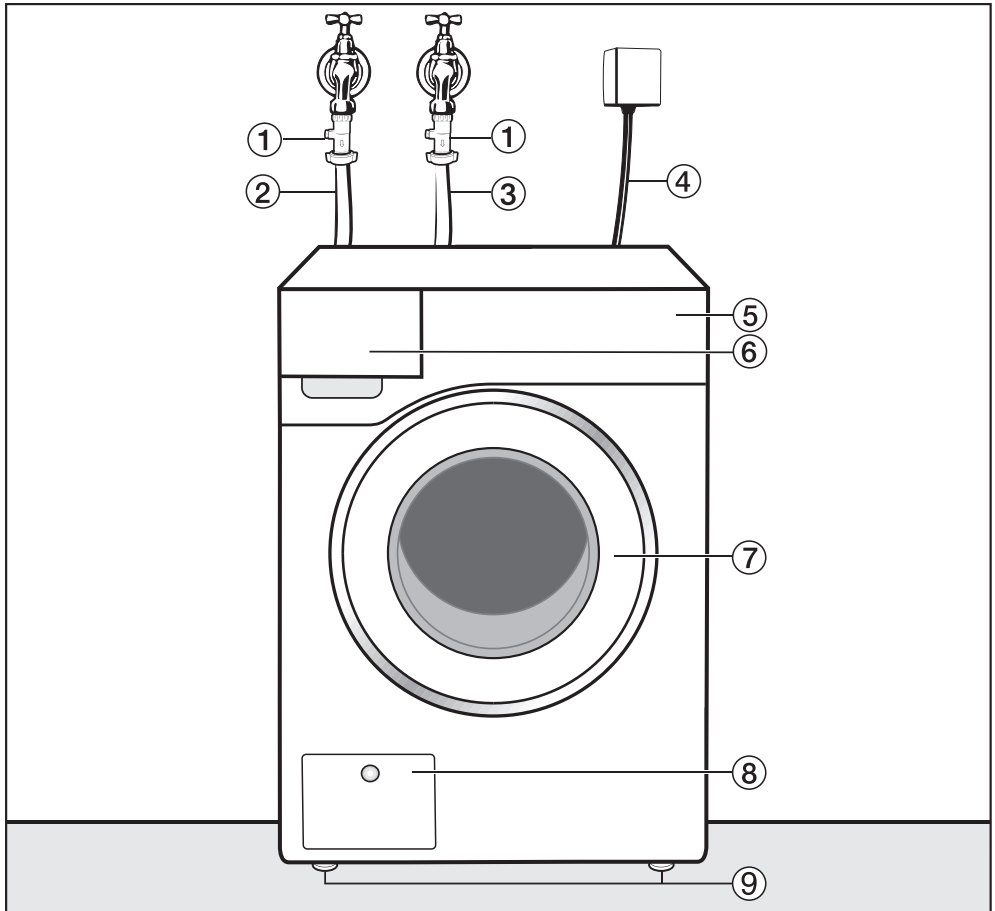

- ① Double check valves (for UK only)
- ② Inlet hose (cold water)
- ③ Inlet hose (hot water)
- ④ Electrical connection
- ⑤ Fascia panel
- ⑥ Detergent drawer
- ⑦ Door
- ⑧ Access to drain filter and drain pump and emergency release
- ⑨ Height-adjustable feet

Installation

Rear view

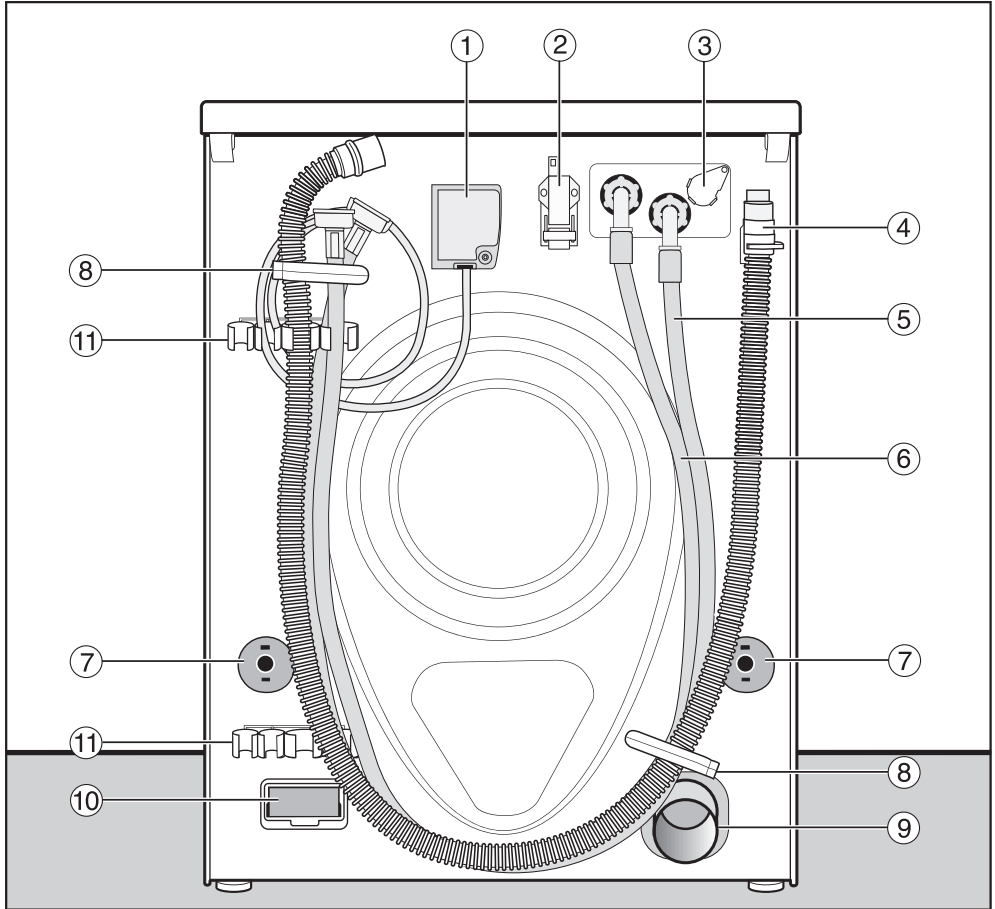

- ① Electrical connection
- ② Interface for communicating with external devices
- ③ Socket for external dispensing system
- ④ Drain hose (LP version)
- ⑤ Inlet hose (cold water)
- ⑥ Inlet hose (hot water), if fitted
- ⑦ Safety caps for transit bars
- ⑧ Transport clips for hoses
- ⑨ Drain pipe (AV version)
- ⑩ Module slot (for external communication module)
- ⑪ Holder for removed transit bars

Installation locations

Side view

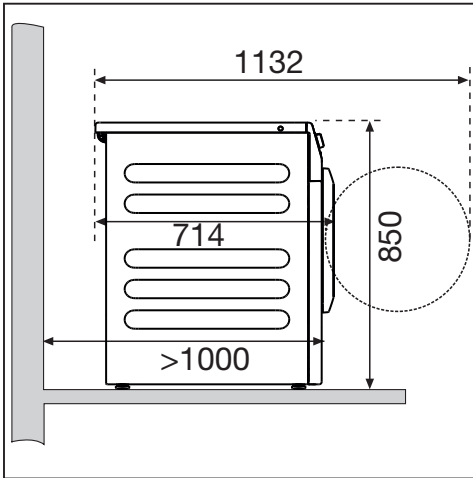

⚠ Installing the washer-dryer stack on a Miele plinth is not permitted.

Installation on a plinth

The washing machine can be installed on a steel plinth (open or closed, available as an optional Miele accessory) or on a concrete plinth.

⚠ Injury can occur if the washing machine has not been adequately secured.

When installing the machine on a plinth, there is the danger of the washing machine falling off the plinth during spinning.

Secure the washing machine using the clamps supplied.

Washer-dryer stack

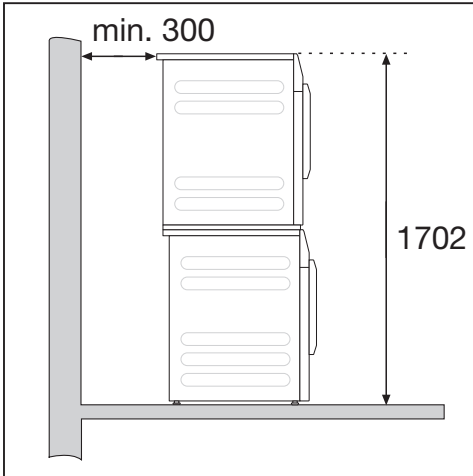

The washing machine can be installed as a washer-dryer stack together with a Miele tumble dryer. This requires a Miele washer-dryer stacking kit which can be purchased separately.

Installation notes

The distances between the machine and the wall are recommendations to help make it easier to carry out service work. If installation space is limited, the machine can also be pushed up against the wall.

This washing machine is not suitable for building under.

⚠ Risk of damage due to moisture ingress.

Moisture can damage electrical components.

Do not install the machine near or directly above an open gully or floor drain.

Installation

Transporting the washing machine to its installation site

⚠ Danger of injury from incorrect transport.

If the washing machine tips up there is a danger of injury to people and damage to property.

Make sure the washing machine is stable during transportation.

Transporting the washing machine with a sack truck

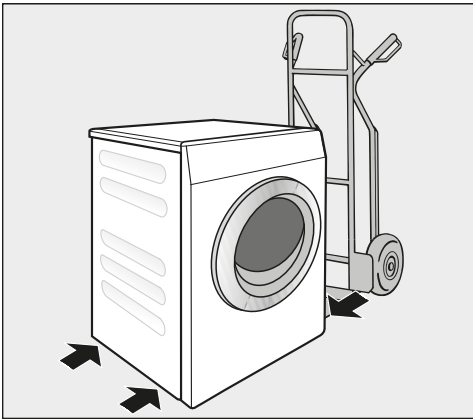

- If transporting the washing machine with a sack truck, make sure its left or right side is resting on the truck.

⚠ Risk of damage from incorrect transport.

The front or back of the washing machine may be damaged if the machine is transported with a sack truck.

Always insert the sack truck under one of the sides of the washing machine.

Transporting the washing machine to its installation site

The protruding lid at the back can be used to hold the machine when transporting.

⚠ Danger of injury due to unsecure lid.

The fixings at the back of the lid could break as a result of external forces. There is a danger of the lid being pulled off when carrying the machine.

Before carrying the machine, check that the lid is secure where it protrudes at the back of the machine.

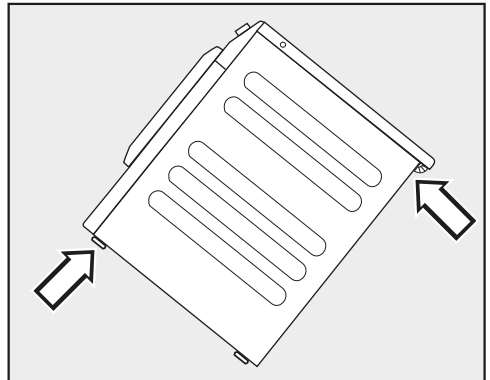

- Carry the washing machine by the front feet and by the lid where it protrudes at the back of the appliance.

Installation surface

A concrete floor is the most suitable installation surface, being far less prone to vibration during the spin cycle than wooden floorboards or a carpeted surface.

- The machine must be level and securely positioned.
- To avoid vibrations during spinning, the machine should not be installed on soft floor coverings.

If installing on a wooden joist floor:

- Install the machine on a plywood base (at least 70 x 60 x 3 cm). The base should span several joists and be bolted to the joists and not only to the floorboards.

Tip: If possible, install the machine in a corner of the room. This is usually the most stable part of the floor.

Removal of transit bars

Removing the left-hand transit bar

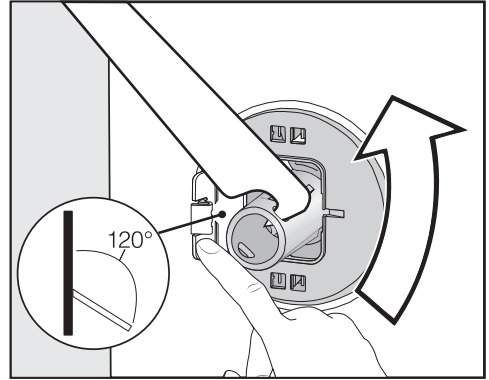

- Push the cover out and turn the transit bar 90° using the open spanner supplied.

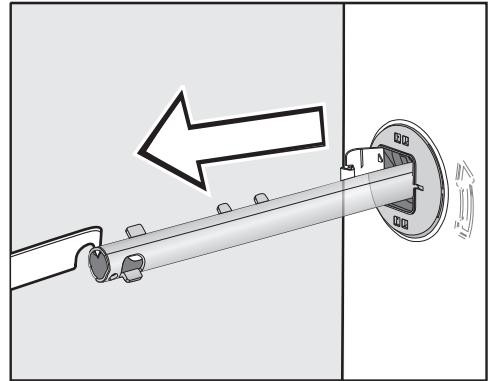

- Pull out the transit bar.

Installation

Removing the right-hand transit bar

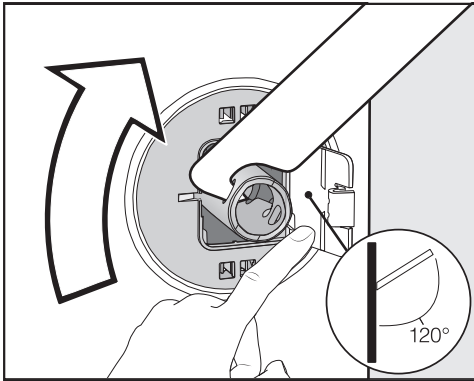

- Push the cover out and turn the transit bar 90° using the open spanner supplied.

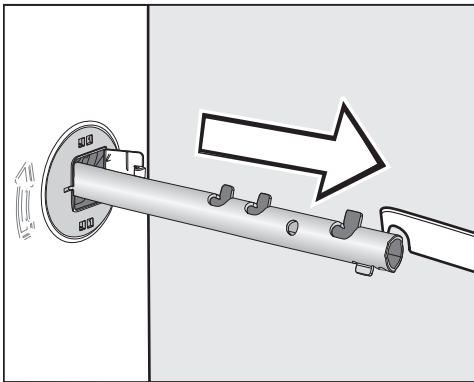

- Pull out the transit bar.

Covering holes

 Danger of injury from sharp edges.

There is a danger of injury from reaching into holes that are not covered.

Cover the holes for the transit bars after they have been removed.

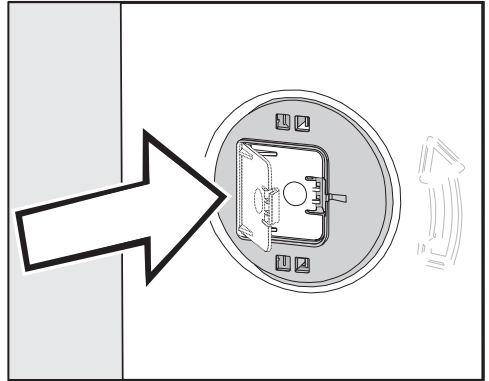

- Push the covers in firmly until they engage in position.

Securing the transit bars

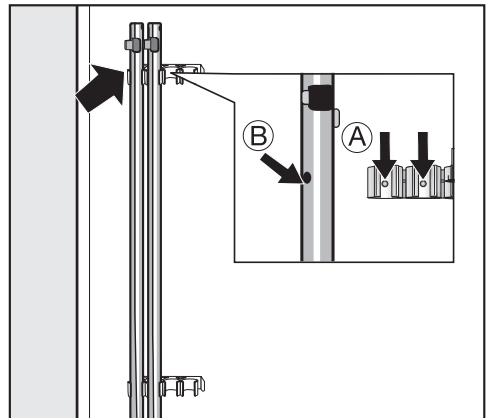

- Secure the transit bars to the back of the washing machine.

Tip: Make sure that the holes **(B)** are fitted over the retainers **(A)**.

 Risk of damage from incorrect transport.
The washing machine may become damaged if moved without the transit bars in place.
Keep the transit bars in a safe place.
Fit them again if the washing machine is to be moved (e.g. when moving house).

Fitting the transit bars

Opening the covers

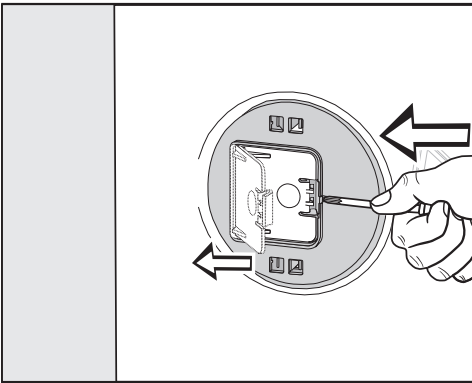

- Press against the retainer with a sharp object (a narrow screwdriver, for example).

The cover opens.

Fitting the transit bars

- To fit the bars, follow the instructions for removing them in reverse order.

Tip: The bars will slide in more easily if you lift the drum slightly.

Levelling the washing machine

The washing machine must stand perfectly level on all four feet to ensure safe and proper operation.

Incorrect installation may increase electric and water consumption and may cause the machine to move about.

Screwing out and adjusting the feet

The 4 adjustable screw feet are used for levelling the washing machine. The machine is supplied with all four feet screwed in.

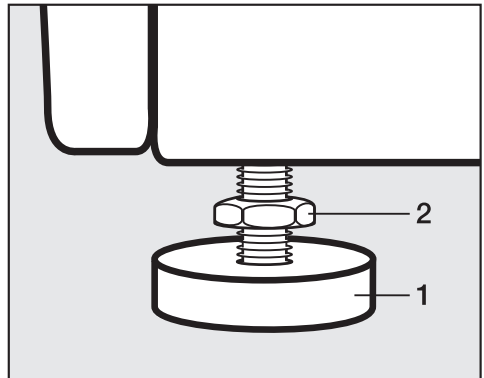

- Using the spanner supplied, turn counter nut **2** in a clockwise direction. Then turn counter nut **2** together with foot **1** to unscrew.

Installation

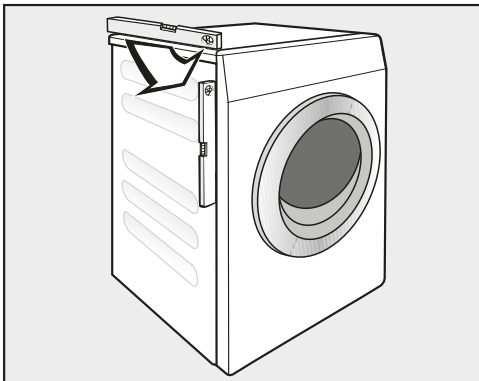

- Use a level to check that the washing machine is standing level.
- Hold foot **1** securely with a pipe wrench. Turn counter nut **2** again using the spanner supplied until it sits firmly up against the housing.

 Risk of damage due to incorrectly aligned washing machine.

There is a danger of the washing machine moving about if the feet are not secured.

Turn all 4 counter nuts for the feet until they sit firmly up against the housing. Please also check this for the feet which did not need adjustment.

Holding bracket for plinth

The holding bracket prevents the washing machine from falling off the plinth during operation.

Fastening with the holding bracket is only intended for plinths made from concrete. The plinth must be flat and level. The surface below the plinth must be able to withstand the physical loads. Prior to installation, check whether the plinth complies with the minimum dimensions.

Height 6 cm

:

Width: 60 cm

Depth: 65 cm

Positioning the holding bracket

 Risk of injury from sharp edges.

The holding bracket has sharp edges. You could cut yourself on the edges.

Take care when handling the holding bracket.

Wear gloves while installing the holding bracket.

The front appliance feet must protrude by at least 3 mm. The washing machine must already be aligned (see “Installation – Aligning the washing machine”)

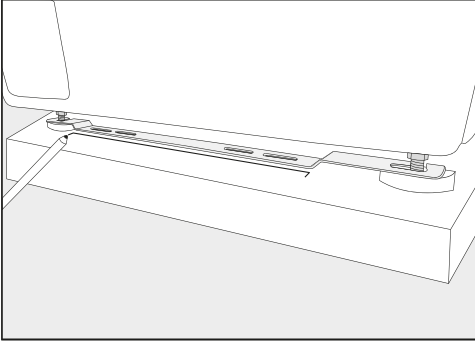

- Place the holding bracket on the front appliance feet.
- Mark the position of the front edge of the holding bracket with a pencil.
- Remove the holding bracket from the feet.
- Carefully move the washing machine until you have enough space to install the holding bracket.

Installing the holding bracket

- Place the holding bracket on the marking on the plinth.
- In the middle of the two outer slotted holes, mark a point for each drill hole.
- Drill 2 holes (8 mm) with a depth of approx. 55 mm.
- Insert the plugs in the holes.

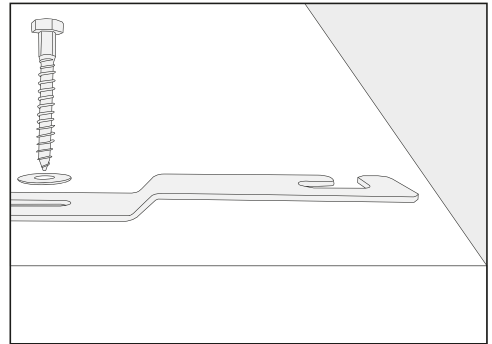

- Install the holding bracket with the hexagon screws and the washers.

Do not tighten the screws yet – this will allow the holding bracket to be moved sideways.

Installation

Securing the washing machine with the holding bracket

- Push the washing machine back on to the installed holding bracket.

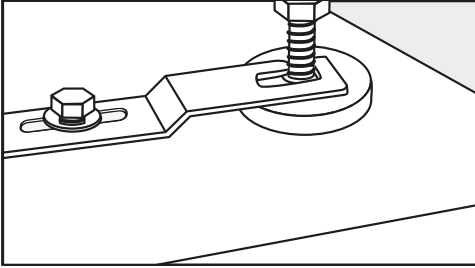

- Insert the appliance feet (the part between the foot and the locknut) into the openings in the holding bracket.
- Push the holding bracket to the right as far as it will go.
- Tighten the hexagon screws using a spanner.

The washing machine is secured in the holding bracket.

External control equipment

The XCI box accessory is needed to connect external control equipment, such as payment systems, dispensing systems or peak load control units.

Payment system

This washing machine can be fitted with a payment system (optional accessory).

The necessary reprogramming must always be carried out by Miele Service or a Miele Service Dealer.

Coins/tokens must be removed from the coin box regularly. Otherwise, the payment system will become blocked.

Water connection

Cold water connection

The washing machine should be connected to a mains water supply in accordance with current local and national safety regulations. The German authorities do not require it to have a non-return valve as the washing machine has been designed to comply with DIN regulations.

In the U.K. both the hot and cold water supplies must be connected to the mains water connection with the provided double check valve. Hot water temperature must not exceed 60 °C.

The flow pressure must amount to a minimum of 100 kPa and must not exceed 1000 kPa. If the pressure exceeds 1000 kPa, a pressure reducing valve must be installed.

For the connection, a stopcock with a $\frac{3}{4}$ " screw thread is required. If this type of stopcock is not available, only a qualified installer may connect the washing machine to the mains water supply.

The connection point is subject to mains water pressure.

Turn on the stopcock slowly and check for leaks. Correct the position of the washer and screw thread if appropriate.

Switching to cold water operation

If the washing machine is not connected to a hot water point, you will have to configure the settings *Main wash water*, *Pre-wash water* and *Rinse water* to cold (see "Supervisor level").

- Unscrew the hot water hose.
- Screw on the stopper provided.

Maintenance

Only use genuine Miele hoses that have been tested to withstand pressure of at least 7000 kPa should you ever need a replacement.

A filter is located in the intake point to protect the water inlet valve. Neither filter may be removed.

Hose extension

Longer hoses are available from Miele or from your Miele dealer as accessories.

Installation

Hot water connection*

The hot water temperature must not exceed 70 °C (60 °C in the UK).

To minimise energy consumption during operation with hot water, the washing machine should be connected to a suitable hot water ring circuit. So-called “transmission pipes” (single pipes to hot water generators) can result in any water remaining in the pipes cooling down if not in constant use. More energy would then be consumed to heat the liquid up again.

The same connection requirements as for cold water also apply to hot water.

The inlet hose is connected to the stopcock.

The washing machine cannot only be connected to a hot water connection.

* Some machine versions do not come with a hot water hose.

Switching to hot water operation

If the washing machine is due to be connected to a hot water point, you can configure the settings *Main wash water*, *Pre-wash water* and *Rinse water* to hot (see “Supervisor level”).

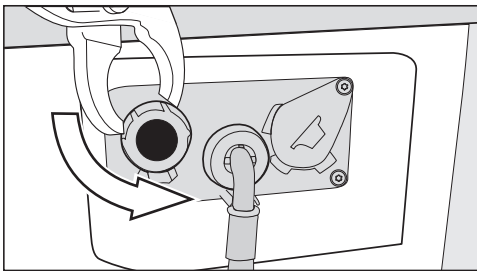

- Unscrew the stopper from the hot water valve.
- Screw on the hot water hose.

Drainage

Drain valve

The machine is drained using a motorised drain valve. A DN 70 angle connector can be used for draining the machine via an on-site floor drain (gully with odour trap).

Drain pump

The suds are drained through a drain pump with a 1 m delivery head. For the water to drain freely, the hose must be free of kinks. The elbow piece (accessory) can be hooked onto the end of the hose.

Drainage options

1. Connected securely to a plastic drain pipe with a rubber nipple (there is no need to use a siphon).
2. Connected securely to a washbasin with a plastic nipple.
3. Connected securely to a floor drain (gully).

If required, the hose can be extended to a length of up to 5 m. Accessories are available from Miele or from your Miele dealer.

For a drain height of more than 1 m (up to a max. of 1.6 m), a replacement drain pump is available from Miele or from your Miele dealer.

Electrical connection

This description applies to washing machines both with and without a mains plug.

The following applies to washing machines with a mains plug:

- The washing machine is ready to be connected.
- The electrical socket must be easily accessible after installation so that the machine can be disconnected from the electricity supply if necessary. It is always recommended to connect the washing machine to the electrical supply with a suitably rated plug and protected socket as per local and national regulations.

 **Damage caused by incorrect supply voltage.**

The data plate indicates the nominal power consumption and the appropriate fuse rating.

Compare the specifications on the data plate with those of the mains electricity supply and make sure that they match.

The washing machine may only be connected to a permanent electrical system that conforms to the national and local codes and regulations.

Do not connect the machine to an extension lead or multi-socket adapter as they do not guarantee the required safety of the appliance (e.g. danger of overheating).

If the machine is hard wired, an all pole circuit breaker must be provided on-site. When switched off there must be an all-pole contact gap of at least 3 mm in the isolator switch (including miniature cir-

cuit breaker, switch, fuses and relays according to IEC/EN 60947). This connection process must be performed by a qualified electrician.

The plug connector or isolator switch should be easily accessible at all times.

 **Risk of electric shock.**

If the washing machine is disconnected from the mains, protective measures must be taken to ensure that the point of disconnection cannot accidentally be switched on again.

Make sure the isolator is lockable or the point of disconnection is monitored at all times.

New connections, modifications to the system, or servicing of the earthing conductor, including determining the correct fuse amperage, must be carried out by a qualified electrician, as they are familiar with the pertinent regulations and the specific requirements of the electric utility company.

If converting the washing machine to an alternative voltage, observe the instructions in the wiring diagram. Conversion must be performed by Miele Service or by an authorised Miele dealer.

Installation

Single phase AC 230 V – country variant 230V 25A

This device is intended for connection to a power supply system where the maximum value of external phase neutral loop impedance Z_{max} of 0.38 Ohms at the point of distributor supply connection is not exceeded.

The user has to ensure that this device is connected only to a power supply system which fulfils the requirement above. If in doubt, please ask your electrical distributor for actual impedance value.

Technical data

Height	850 mm
Width	596 mm
Width (for machines with a stainless steel lid)	605 mm
Depth	714 mm
Depth with door open	1132 mm
Weight	Approx. 100 kg
Maximum floor load in operation	3000 Newton
Capacity	7.0 kg dry laundry
Supply voltage	See data plate on back of machine
Connected load	See data plate on back of machine
Fuse rating	See data plate on back of machine
A-rated sound emissions L_{pA} in accordance with EN ISO 11204/11203	< 70 dB re 20 μ Pa
Minimum water flow pressure	100 kPa (1 bar)
Maximum water flow pressure	1,000 kPa (10 bar)
Intake hose length	1.55 m
Connection cable length	1.80 m
Maximum drain pump head height (drain pump version)	1.00 m
LEDs	Class 1
Product safety standard	EN 50571, EN 60335
Test certifications awarded	See data plate
Frequency band of the WiFi module	2.4000 GHz – 2.4835 GHz
Maximum transmission power of the WiFi module	< 100 mW

Technical data

EU Conformity declaration

Miele hereby declares that this washing machine complies with Directive 2014/53/EU.

The complete text of the EU declaration of conformity is available from one of the following internet addresses:

- Products, Download from www.miele.ie
- For service, information, operating instructions etc: go to <https://miele.co.uk/manuals> and enter the name of the product or the serial number

UK Conformity declaration

Miele hereby declares that this washing machine complies with UK Radio Equipment Regulations 2017, as amended.

The complete text of the UK declaration of conformity is available from one of the following internet addresses:

- Products, Download from www.miele.co.uk
- For service, information, operating instructions etc: go to <https://miele.co.uk/manuals> and enter the name of the product or the serial number

This **Statement of Compliance** confirms this Miele product fully complies with the **Product Security and Telecommunications Infrastructure (Security Requirements for Relevant Connectable Products) Regulations 2023**.

- 1) Household Appliance – *Professional Washing Machine GW06, GW08*
- 2) Manufactured by: Miele & Cie KG,
Carl Miele Street 29, 33332 Gutersloh Germany
Imported by and contact point: Miele Company Ltd, Fairacres, Marcham Road,
Abingdon, Oxon, OX14 ITW Great Britain
- 3) The defined support period at the time of first supply is 10 years
- 4) To report vulnerabilities and cybersecurity issues please contact: psirt@miele.com

5) Signature 

Name: **Paul Wright**

Company Position: **Head of Technical Management**

Date of signature: **19th March 2024**

Place of signature: **Abingdon, Oxfordshire**

Opening Supervisor level

- Switch on the washing machine.

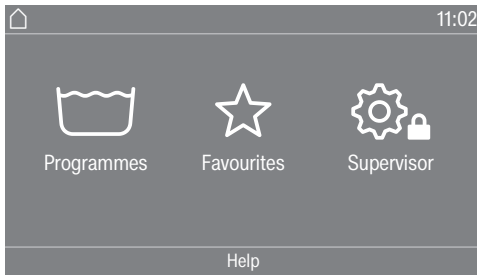

- Touch the Supervisor  sensor control.

The display will change to the Supervisor level menu

Code-based access

Supervisor level is accessed using a code.

The code is **000** (factory default).

Changing the code

You can alter the Supervisor level access code to protect the washing machine from unauthorised access.

Please inform Miele Service if you have forgotten your new code. Miele Service will have to reset the code. Make a note of your new code and store it in a safe place.

Closing the settings menu

- Touch the  sensor control.

The display will then go back to the previous menu level.

- Touch the  sensor control.

The display will change to the main menu.

Supervisor level

Operation/display

Language

The display can be set to appear in one of several different languages. To select the permanent operator language you want, go to the Languages sub-menu.

When a programme is running, you can change the user language using the  sensor control.

Language menu

The display can be set to one of several different user languages. This setting allows you to determine how languages can be selected.

International

6 languages are available. The  sensor control is not active. Note the setting **Set languages**.

Language setting

The  sensor control can be used to select a language. All languages are available (factory default).

You can change the order of the first 4 languages. These slots are allocated to the most commonly used languages.

Standard language

The user language cannot be changed. The user language is the same as the operator language. The  sensor control is not active.

Set languages

The languages for the setting **Language** entry **International** can be changed.

6 languages can be selected. All languages are available.

If you wish to add a new language to the language menu:

- First select the language you want to replace.

All available languages are displayed.

- Select and confirm the language to replace the previous language.

The new language appears instead of the old one.

Display brightness

The brightness of the display can be altered. The setting depends on the various lighting conditions in the place of installation.

It can be set to one of 10 different levels.

Clock display

After selecting the clock format, you can set the time of day.

Clock format

- 24h clock (factory default)
- 12h clock
- No clock

Set

- The time of day can be set.

Date

The date can be set after selecting the date format.

Date format

- DD.MM.YYYY
- YYYY.MM.DD
- MM.DD.YYYY

Date

- The date can be set.

Volume

The volume for various sounds can be changed.

- Finish tone
- Keypad tone
- Welcome tone

It can be set to one of 7 different levels or switched off altogether.

- Fault alarm

The fault alarm can be activated or deactivated.

Visibility parameters

Various parameters, such as the temperature, spin speed, Extras, etc., are displayed when a programme is selected. You can decide which parameters should not be displayed. These parameters can then not be edited during programme selection.

Factory default: all parameters are visible (marked in orange)

Sort Extras

Under the setting *Visibility parameters*, Sort "Extras" appears in the bottom line. Touch the sensor control to change the sequence of Extras (see "Arranging programmes" under "Supervisor level").

Supervisor level

Display off status

The display switches off to save energy. The *Start/Stop* sensor control flashes slowly.

Changing this setting leads to increased energy consumption.

Off

The display does not switch off.

On (10 min.) Not curr.prog.

The display will remain on while the programme is running but will go out 10 minutes after the end of the programme.

Logo (10 min.) Not curr.prog.

The display stays switched on while the programme is running. The logo lights up 10 minutes after the end of the programme.

On after 10 min.

The display will go out after 10 minutes.

On (30 min.) Not curr.prog.

The display will remain on while the programme is running but will go out 30 minutes after the end of the programme.

Logo (30 min.) Not curr.prog.

The display stays switched on while the programme is running. The logo lights up 30 minutes after the end of the programme.

On after 30 min.

The display will go out after 30 minutes.

Machine off status

In order to save energy, the washing machine will switch off automatically after the end of the programme or if no further selection is made. You can change this setting.

Changing this setting leads to increased energy consumption.

- The machine does not switch off
- The machine switches off after 15 minutes (factory default)
- The machine switches off after 20 minutes
- The machine switches off after 30 minutes

Delay start

The delay start (timer) display can be switched on or off.

Factory setting: On

Memory

The washing machine will save the settings (temperature, spin speed and some of the options) which have been selected for a programme after the programme has started.

When the programme is chosen again, the saved settings will appear in the display.

Factory default: Off

Temperature unit

You can select the unit for the temperature display.

Factory default: °C/Celsius

Weight unit

You can decide whether load quantities are displayed in “kg” or “lbs”. You can also switch this information off altogether.

Factory default: kg

Logo

You can choose whether the “Miele Professional” logo or your own logo appears in the display.

The option *Laundrette Logo* must be selected for the setting *Controls*.

Supervisor code

You can alter the access code to the supervisor level.

- Enter the current code.
- Enter a new code.

Programme selection

Controls

You can select whether the machine is operated as a laundrette machine. Shortcuts are the easiest way to operate the machine. Operating staff are unable to change pre-set programmes.

Tip: Start by configuring all necessary settings and changes to the washing machine before adjusting any of the options below.

If “Laundrette, basic” or “Laundrette Logo” are selected, the Supervisor level can no longer be opened from the display after the *Supervisor level* menu is closed. Please follow the instructions below if you wish to change any other settings.

Opening the Supervisor level (wash-salon version)

- Switch on the washing machine and open the door.
- ① Touch the *Start/Stop* sensor control and hold it down whilst carrying out steps ②-③.
- ② Close the washing machine door.
- ③ The *Start/Stop* sensor will now be flashing quickly; wait until it lights up constantly.
- ④ Release the *Start/Stop* sensor control when the *Start/Stop* sensor lights up constantly.

Supervisor level

Control options

Standard (factory default).

All functions and programmes can be displayed.

Launderette, basic

Up to 12 programmes are available. Go to *Favourite programmes* to select which programmes are to be listed.

Laundrette Logo

Up to 12 programmes are available. Go to *Favourite programmes* to select which programmes are to be listed.

External programme selection

Programmes are selected using a communication module, e.g. an external terminal.

Programme packages

The selection of programmes can be expanded by activating single programmes from the target group programme packages.

The programmes selected from the programme packages (marked in orange) are displayed under programme selection.

Favourite programmes

You can save up to 12 of your own customised wash programmes as *Favourites*.

The saved programmes will be displayed under *Favourites*.

All programmes from the *Favourites* list are displayed with the control option *Launderette, basic* and *Laundrette Logo*.

You can specify the control option under *Controls*.

Tip: You can assign a different colour to each programme. In this case, the *Prog. colour allocation* setting must be set to *On*.

Changing Favourite programmes

- Select the programme you wish to change or replace.
- Touch the programme icon or setting to be changed.

Another menu opens, enabling you to select a new programme or change the parameters.

- Touch the *Save sensor*.

Your selection is now active.

Reducing the number of Favourite programmes

You can reduce the number of Favourite programmes by “deactivating” each one individually.

- Select the programme you wish to deactivate.
- Confirm the programme.
- Select <empty> from the list instead of a programme.

The selection in the ☆ Favourites and the selection in the Launderette, basic and Laundrette Logo control option is reduced.

Once a programme has been deactivated, ∅<empty> is displayed in its place. You can add a programme back in at any time.

The number of Favourite programmes can be reduced to 0 if you “deactivate” all programmes. In this case, the ☆ Favourites selection is no longer displayed in the main menu.

Do not reduce the number of Favourites to 0 if you want to set the Launderette, basic or Laundrette Logo control variant afterwards.

Changing the sequence of Favourite programmes

You can change the sequence of Favourite programmes by moving the programmes around.

- Touch the programme that you wish to move.

An orange border appears around the selected programme.

- Touch the programme with your finger and keep your finger pressed down.

- Drag the programme to the required place.

Supervisor level

Special programmes

You can put together 5 special programmes and save them as your own wash programmes with your own programme names.

You must have already activated Special programmes under *Programme packages*.

Enter the name of your special programme and its basic settings into the “Special programmes” table under the “Programme chart”.

- Temperature: you can select a temperature in multiple increments from cold to 90 °C.
- Wash block: you can select one or more wash blocks.
- Spin speed: you can select a spin speed in increments from 0 rpm to 1400 rpm.

Sort programmes

Programmes can be moved within the programme list and in the Favourites list.

Factory default: Off

Moving programmes

- Touch the sensor control for the programme you want to move.
- Press and hold the sensor control until the frame changes.
- Drag the programme to the required place.

Prog. colour allocation

You can assign a colour to a Favourite programme. In the list of Favourites, each Favourite programme is given a coloured frame, which can be adjusted.

Factory setting: On

Hygiene

The Maintenance wash hygiene programme is shown in the list of special programmes.

If a programme at a temperature below 60 °C has been used, a request to start the Maintenance wash hygiene programme appears in the display.

Factory default: Off

Expert code

A code has to be entered to cancel a disinfection programme. The code can be modified.

The code is: 0 0 0

Make a note of your new code if you ever change it.

Process technology

Anti-crease

The Anti-crease function reduces creasing after the end of the programme. At the end of the programme, the drum continues to turn at intervals for up to 30 minutes.

The washing machine door can be opened at any time.

Factory setting: On

Water level Cottons

You can increase the water level for the main wash in the *Whites and Coloured items* programmes.

- + 0 mm wc (factory default)
- + 10 mm wc
- + 20 mm wc
- + 30 mm wc

Water level Min. iron

You can increase the water level for the main wash in the *Minimum iron* programme.

- + 0 mm wc (factory default)
- + 10 mm wc
- + 20 mm wc
- + 30 mm wc

Pre-wash temp Cottons

You can select the temperature for the pre-wash in the *Whites and Coloured items* programmes.

- 30 °C (factory default)
- 35 °C
- 40 °C
- 45 °C

Wash time

Cottons pre-wash

You can increase the duration for the pre-wash in the *Whites and Coloured items* programmes.

- + 0 min (factory default)
- + 6 min
- + 9 min
- + 12 min

Cottons

You can increase the duration for the main wash in the *Whites and Coloured items* programmes.

- + 0 min (factory default)
- + 10 min
- + 20 min
- + 30 min
- + 40 min

Supervisor level

Minimum iron

You can increase the duration for the main wash in the *Minimum iron* programme.

- + 0 min (factory default)
- + 5 min
- + 10 min
- + 15 min
- + 20 min

Pre-rinse Cottons

A pre-rinse can be activated in the *Whites and Coloured items* programmes.

Factory default: Off

Pre-rinse Minimum iron

A pre-rinse can be activated in the *Minimum iron* programme.

Factory default: Off

Pre-wash Cotton/M-iron

In the programmes *Whites, Coloured items* and *Minimum iron*, you can choose whether a pre-wash is permanently activated or whether it can be selected during programme selection.

Factory default: Menu selection

Cottons rinses

You can alter the number of rinses carried out in the *Cottons* programme.

- 1 rinse
- 2 rinses (factory default)
- 3 rinses
- 4 rinses
- 5 rinses

Minimum iron rinses

You can alter the number of rinses carried out in the *Minimum iron* programme.

- 2 rinses (factory default)
- 3 rinses
- 4 rinses

Disinfection rinse

Additional rinses can be activated in disinfection programmes with a temperature of at least 60 °C.

Rinsing is carried out with hot water. The programme duration is longer.

The laundry may feel hot at the end of the programme.
Take care when removing items.

Factory default: Off

Auto load control

This washing machine comes with automatic load control. In some programmes, the water levels and the programme cycle times are adapted to the load.

If the auto load control is deactivated, the machine will always carry out the programme sequence based on a full load.

Factory setting: On

Controlled energy cons.

With this option selected, the machine will optimise the energy it uses in the *Whites*, *Coloured items* and *Minimum iron* programmes.

Factory setting: On

Service

Clean drain pump

The user sees a message when the drain pump filter has to be cleaned.

The message is displayed every 500 operating hours.

The message appears at the end of the programme.

Factory default: Off

Service interval

Service information can appear in the display. You can configure whether a date or the number of operating hours is displayed.

You can select up to 3 messages with their own text.

Your message is displayed at the end of the programme and can be acknowledged with *OK*. The same message appears at the end of the next programme.

Settings

This setting allows you to determine the interval (depending on hours or date) at which the message appears.

- Factory default: Off
- By time
You can then select a time interval from 1–9999 hours.
- By date
You can then enter a date.

Message text

Enter your message for your planned maintenance work.

Reset display

The message appears until the display is permanently reset. The message then appears again once the next interval is reached.

Supervisor level

External applications

Availability of Miele digital products

The ability of Miele digital products depends on the availability of the services in your country.

The different services are not available in all countries.

For information about availability, please visit www.miele.com.

Empty sensor

External hardware is connected via the Miele XCI box.

A siphon contact can be used to detect whether external detergent containers are empty. A message appears if a container is empty.

- Off (factory default)
- Normally open contact

The siphons are equipped with a normally open contact.

- Normally closed contact

The siphons are equipped with a normally closed contact.

Early warning counter

External hardware is connected via the Miele XCI box.

An internal counter reports when an external dispenser container is almost empty. The counter in question then has to be reset.

Automatic dispensing

Automatic dispensing via an external dispensing system can be activated

Factory default: Off

Adjustment value dosage 1–6

To respond to the tolerances that occur in the pump system over time, the dosage amount (ml/min) for the pumps can be corrected.

The calibration value can be reduced by 3 increments or increased by 3 increments.

The calibration value is increased or reduced by 1, 2 or 3 times the adjustment value based on the selected incremental setting.

The calibration value and the adjustment value must be added to the data for the dispenser pumps by the Miele Customer Service Department.

Peak load signal

External hardware is connected via the Miele XCI box.

The peak-load negotiation function enables the washing machine to be connected to an energy management system. When a signal is registered, the washing machine's heater is switched off for a short period.

The washing machine may only be operated with a peak-load system if this system is connected to the washing machine via the Miele XCI box.

- No function (factory default)
- Peak load with 230 V
- Peak load with 0 V
- COM module

Peak load prevention

The peak-load negotiation function can be deactivated with disinfection programmes. When a signal is registered, the washing machine's heater is not switched off.

Factory default: Off

COM module selection

This washing machine is equipped with an integrated WiFi module. However, the washing machine can also be equipped with an external module.

- Off
- Internal module (factory default)
The internal WiFi module is used.
- External module
An XKM module or RS232 module is inserted into the module slot.

WiFi

Control the networking of your washing machine.

- Setup
This message only appears if the washing machine has not yet been connected to a WiFi network.
- Deactivate (visible when the network is activated)
The network remains set up; the WiFi function is switched off.
- Activate (visible if the network is deactivated)
The WiFi function is reactivated.
- Connection status (visible when the network is activated)
 - The quality of WiFi reception
 - The network name
 - The IP address
- Set up again (visible if already set up)
Resets the WiFi login (network) to immediately re-establish a new connection.
- Reset (visible if already set up)

Supervisor level

The network is no longer set up. A new connection has to be established in order to use the network again.

- The WiFi is switched off
- The WiFi connection will be reset to the factory default setting

WiFi setup

There are 2 possible connection methods.

WPS

- Activate the WPS function on your router within 2 minutes.

Tip: If the connection has not been set up when the timeout has finished counting down, repeat the process.

Soft AP

- Activate the function with the Miele app on your smart device within 10 minutes.

Tip: The app will guide you through the remaining steps.

Network time

The date and time can be synchronised over the network.

- Off

The date and time are not synchronised over the network.

- As master

The machines are in a network but are not connected to the Internet. A machine is declared as the master and sends data to the *slave* devices.

- As slave

The machines are in a network and are connected to the Internet. All machines are configured as *slaves*. Data is synchronised over the Internet.

Remote

Programmes are selected on an external terminal.

Factory default: On

RemoteUpdate

The RemoteUpdate function is used to update the software in your washing machine.

Factory default: on

If you do not install a RemoteUpdate, you can continue to use your washing machine in the usual way. However, Miele recommends installing RemoteUpdates.

Activation

The RemoteUpdate menu option is only displayed and can only be selected if you have added your washing machine to your WiFi network.

Some software updates can only be carried out by the Miele Customer Service Department.

Running a RemoteUpdate

If a RemoteUpdate is available for your washing machine, it will be displayed automatically when the operator level is open.

You can choose to start the RemoteUpdate immediately or wait until later. If you select "Start later", the prompt to run the RemoteUpdate will be displayed again the next time you switch on your washing machine.

The RemoteUpdate can take a few minutes.

Please note the following information about the RemoteUpdate function:

- You will only receive a message when a RemoteUpdate is available.
- Once a RemoteUpdate has been installed, it cannot be undone.
- Do not switch off the washing machine during a RemoteUpdate. Otherwise, the RemoteUpdate will be aborted and will not be installed.

Supervisor level

SmartGrid

The SmartGrid setting is only visible if a WiFi network has been set up and activated. This function can be used for starting your washing machine automatically at a time when your energy supplier's energy costs are most economical.

Activating SmartGrid gives the Timer sensor control a new function. Use the "Timer" sensor control to configure SmartStart. The washing machine will then start within the timeframe specified by you when it receives a signal from your energy supplier. If a signal has not been received from the energy supplier by the latest start time set, the washing machine will start automatically.

Factory default: Off

Machine parameters

Suds cooling

Additional water flows into the drum at the end of the main wash to cool the suds down.

Suds cooling takes place when a programme with a temperature of 70 °C or higher is selected.

Suds cooling should be activated:

- to prevent the danger of scalding if the drain hose is hooked over the edge of a sink or basin.
- where the drainage pipes do not comply with DIN 1986.

Factory setting: On

Water inlet

Pre-wash

You can select the water type for the pre-wash.

- Cold
Only cold water is used for the pre-wash.
- Hot
Hot water is also added for the pre-wash.
Hot water can only be added if the wash temperature is above 30 °C.

Main wash

You can select the water type for the main wash.

- Cold
Only cold water is used for the main wash.
- Hot
Hot water is also added for the main wash.
Hot water can only be added if the wash temperature is above 30 °C.

Programme durations will be longer if the machine is not connected for hot water; this may mean that the “Time left” display is incorrect.

First rinse

You can select the water type for the first rinse in some programmes.

- Cold (factory default)
Only cold water is used for the first rinse.
- Hot
Hot water is also added for the first rinse.

Final rinse

You can select the water type for the last rinse in some programmes.

- Cold (factory default)
Only cold water is used for the final rinse.
- Hot
Hot water is also added for the final rinse (only possible for programmes with a temperature of at least 60 °C).

Low water pressure

If the water pressure is below 100 kPa (1 bar), the programme will be cancelled and the fault message **Check water inlet** will appear.

If the on-site water pressure cannot be increased, activating the setting **Low water pressure** will prevent the programme from being cancelled.

Factory default: yes

Supervisor level

Legal information

Open source licences

You can view information here.

Copyrights and licences for operator and control software

Miele uses their own and third party software which is not subject to any so-called open source licence for the operation and control of the machine. This software/these software components are protected by copyright. The copyright powers of Miele and third parties have to be respected.

Furthermore, this machine contains software components which are distributed under open source licence conditions. Please refer to the menu item Settings | Machine parameters | Legal information | Open source licences in the machine for the Open Source components contained therein, together with the corresponding copyright notices, copies of the licencing conditions valid at the time, and any further information. The liability and warranty provisions of the Open Source licence terms and conditions as stated therein apply only in relation to the respective rights holders.

Payment system

The XCI-AD or XCI box accessory unit is required to connect a payment system.

If you wish to change the settings after the commissioning process, please contact the Miele Customer Service Department.

Settings for payment systems

You would like to connect a payment system.

- No payment system
The next settings are skipped and initial commissioning can be completed.
- Programme operation
The machine is operated using a coin box. The user purchases a wash programme.
- Timed operation
The machine is operated using a coin box. The user purchases a time-managed programme.
- Timed operation with pulse counter
For payment systems where the usage period is increased each time a coin is inserted.
- COM module
The machine is operated by a central control unit

External prog. lock

The control unit has an option to block programmes. Programmes are blocked by an external system via the COM interface.

Factory default: off

Payment system lock

To avoid tampering, a programme lock can be set up in programme operation. If the lock is applied, the programme is interrupted and payment credit is lost as soon as the door is opened.

The time for the lock can be adjusted to prevent laundry being added.

- Off
- As soon as the programme starts
- 1 minute after the start of the programme
- 2 minutes after the start of the programme
- 3 minutes after the start of the programme (factory default)
- 4 minutes after the start of the programme
- 5 minutes after the start of the programme

Programme cancellation

A programme that is currently running can be interrupted even if it is locked.

- On, without code (factory default)
- On, with code
(Code from Expert code setting)
- Do not cancel

F-back signal to pay system

Setting the feedback signal for the coin box.

- Factory default: Off
- End of programme
The feedback signal is sent at the end of the programme.
- Release of the start button
The feedback signal is sent when the start button is released.
- Start and programme end
The feedback signal is sent at the start and end of the programme.
- Programme running
The feedback signal is sent constantly between the start and end of the programme.

Supervisor level

FOC programmes

In coin mode, you can decide which programmes can be used for free.

Factory default: Off

Clear paid signal

The “Paid” signal in coin box mode can be applied until the end of the programme or discarded if the programme is not started after 5 minutes.

Factory default: Off

Debounce time

The debounce time for the payment signal can be adjusted.

- Short
For coin boxes. (Factory default)
- Long
For central control units.

United Kingdom

Miele Co. Ltd., Fairacres, Marcham Road
Abingdon, Oxon, OX14 1TW
Professional Sales, Tel: 0845 365 6608
E-mail: professional@miele.co.uk
Internet: www.miele.co.uk/professional

Australia

Miele Australia Pty. Ltd.
ACN 005 635 398, ABN 96 005 635 398
Level 4, 141 Camberwell Road, Hawthorn East, VIC 3123
Tel: 1300 731 411
Internet: www.miele.com.au/professional
E-mail: professional.sales@miele.com.au

China Mainland

Miele Electrical Appliances Co., Ltd.
1-3 Floor, No. 82 Shi Men Yi Road
Jing' an District, 200040 Shanghai, PRC
Tel: +86 21 6157 3500, Fax: +86 21 6157 3511
E-mail: info@miele.cn, Internet: www.miele.cn

Hong Kong, China

Miele (Hong Kong) Ltd.
41/F - 4101, Manhattan Place
23 Wang Tai Road, Kowloon Bay, Hong Kong
Tel: (852) 2610 1025, Fax: (852) 3579 1404
Email: customerservices@miele.com.hk
Website: www.miele.hk

India

Miele India Pvt. Ltd.
1st Floor, Copia Corporate Suites,
Commercial Plot 9, Mathura Road, Jasola,
New Delhi - 110025
E-mail: customercare@miele.in, Website: www.miele.in

Ireland

Miele Ireland Ltd.
2024 Bianconi Ave., Citywest Business Campus,
Dublin 24
Tel: (01) 461 07 10, Fax: (01) 461 07 97
E-Mail: info@miele.ie, Internet: www.miele.ie

Malaysia

Miele Sdn Bhd
Suite 12-2, Level 12
Menara Sapura Kencana Petroleum
Solaris Dutamas No. 1, Jalan Dutamas 1
50480 Kuala Lumpur, Malaysia
Phone: +603-6209-0288
Fax: +603-6205-3768

New Zealand

Miele New Zealand Limited
IRD 98 463 631
8 College Hill
Freemans Bay, Auckland 1011, NZ
Tel: 0800 464 353
Internet: www.miele.com.au/professional
E-mail: professional.sales@miele.com.au

Singapore

Miele Pte. Ltd.
29 Media Circle, #11-04 ALICE@Mediapolis
Singapore 138565
Tel: +65 6735 1191, Fax: +65 6735 1161
E-Mail: info@miele.com.sg
Internet: www.miele.sg

South Africa

Miele (Pty) Ltd
63 Peter Place, Bryanston 2194
P.O. Box 69434, Bryanston 2021
Tel: (011) 875 9000, Fax: (011) 875 9035
E-mail: info@miele.co.za
Internet: www.miele.co.za

United Arab Emirates

Miele Appliances Ltd.
Showroom 1, Eiffel 1 Building
Sheikh Zayed Road, Umm Al Sheif
P.O. Box 114782 - Dubai
Tel. +971 4 3044 999, Fax. +971 4 3418 852
800-MIELE (64353)
E-Mail: info@miele.ae
Website: www.miele.ae



Manufacturer: Miele & Cie. KG, Carl-Miele-Straße 29, 33332 Gütersloh, Germany

PWM 907

en-GB

M.-Nr. 12 300 410 / 01