































Operating instructions Wine unit



To avoid the risk of accidents or damage to the appliance it is **essential** to read these instructions before it is installed and used for the first time.

Contents

Warnings and safety notes	5
Sustainability and environmental protection	13
Caring for the environment	13
How to save energy	14
Familiarisation	15
Guide to the appliance	15
KWTUS 7074	15
KWTUS 7096, KWTUS 7196	16
Display	17
Using the door opening aid correctly	18
Settings mode 	19
Feature lighting 	19
Lock function  / 	19
Switching the wine unit off 	19
Sabbath mode 	19
Information on Sabbath mode i	19
Time before door alarm  is triggered	19
Miele@home 	19
Keypad tone  / 	20
Alarms and buzzers  / 	20
Display brightness 	20
Temperature unit °C/°F	20
Demo mode 	20
Factory defaults 	20
Information on the wine unit i	20
Active AirClean filter display 	21
Accessories supplied	21
Safety	21
Temperature alarm	21
Switching the temperature alarm off early	21
Door alarm	22
Adjusting the interior fittings	22
Removing and reinserting the wooden shelves	22
Adjusting the wooden shelf (FlexiFrame) to the bottle size	23
Maximum capacity	23
Labelling the labelling strip (NoteBoard)	24
Commissioning	25
Before using for the first time	25
Connecting the wine unit	25
Activating the charcoal filter (Active AirClean filter) 	25
Positioning the wooden slats on the wooden shelves	25
Switching the wine unit on	25

Switching the wine unit off	25
Switching off for longer periods of time	26
Operation	27
Setting the temperatures in the wine conditioning zones	27
Temperature range.....	27
Temperature display for the wine conditioning zones	27
Adjusting settings	28
Explanation of the different settings.....	28
Setting the brightness of the feature lighting 	28
Switching the lock function  /  on.....	28
Switching Sabbath mode  on	28
Switching Sabbath mode  off	29
Changing the time before the door alarm  is triggered	29
Setting up Miele@home for the first time	29
Deactivating the WiFi connection.....	29
Activating the WiFi connection.....	29
Switching off the keypad tone 	30
Switching on the keypad tone 	30
Changing the volume of the alarms and buzzers  / 	30
Changing the display brightness 	30
Changing the temperature unit °C/°F	31
Switching off demo mode 	31
Resetting the settings to their factory defaults 	31
Activating the Active AirClean filter display 	31
Cleaning and care	32
Cleaning agents	32
Preparing the wine unit for cleaning	32
Cleaning the inside of the appliance	32
Replacing the Active AirClean filter	33
Cleaning the door seal	34
Cleaning the ventilation gaps	34
After cleaning	34
Automatic defrosting	34
Troubleshooting	35
Customer Service Department	40
Contact in the event of a fault	40
EPREL database	40
Warranty	40
Optional accessories	41

Contents

Installation	42
Installation site	42
Climate range	43
Ventilation.....	43
Side-by-side.....	43
Changing the door hinging.....	44
Limiting the opening angle of the appliance door.....	44
Building-in dimensions	45
Niche/side view	45
Connections	47
Installing the wine conditioning unit.....	49
To install the wine unit, you will need the following tools:.....	49
Setting up the wine unit.....	49
Pushing in the wine unit.....	50
Aligning the wine unit.....	51
Aligning the wine unit to taller furniture doors	52
Securing the wine unit in the niche.....	53
Electrical connection	54
EU Conformity declaration	55
UK Conformity declaration	56
Copyrights and licences	57

Warnings and safety notes

This wine conditioning unit complies with all current local and national safety requirements. Inappropriate use can, however, lead to personal injury and material damage.

Read the operating and installation instructions carefully before using the wine conditioning unit. They contain important information on safety, installation, use and maintenance. This is to protect yourself from injury, and from damaging your wine conditioning unit.

In accordance with standard IEC 60335-1, Miele expressly and strongly advises that you read and follow the instructions in the chapter on installing the wine conditioning unit as well as the safety instructions and warnings.

Miele cannot be held liable for injury or damage caused by non-compliance with these instructions.

Keep these instructions in a safe place and pass them on to any future owner.

 Risk of injury from broken glass.

If installed at altitudes above 1500 m there is a risk of the glass in the appliance door breaking because of changes in air pressure. Shards of glass can cause severe injury.

Correct application

- ▶ This wine conditioning unit is intended for use in the home and in similar environments, for example
 - in shops, offices and similar work settings
 - on agricultural estates
 - by the guests in hotels, motels, bed & breakfasts and other typical home settings.

This wine conditioning unit is not intended for outdoor use.

- ▶ The wine unit is intended for domestic use only for storing wine. The wine unit is not suitable for freezing food. The wine unit is suitable for integrated under-counter installation. Any other usage is not permitted.

Warnings and safety notes

▶ The wine conditioning unit is not suitable for storing and keeping cool medicines, blood plasma, laboratory preparations or other such materials or products. Incorrect use of the wine conditioning unit for such purposes can cause deterioration of the items stored. The wine conditioning unit is not suitable for use in areas where there is a risk of explosion.

Miele cannot be held liable for damage resulting from improper or incorrect use of the appliance.

▶ This wine conditioning unit may only be used by people (including children) with reduced physical, sensory or mental capabilities or lack of experience and knowledge if they are supervised whilst using it. The wine conditioning unit may only be used by these people without supervision if they have been shown how to use it in a safe way and recognise and understand the consequences of incorrect operation.

Safety with children

▶ Children under 8 years of age must be kept away from the wine conditioning unit unless they are constantly supervised.

▶ Children aged 8 and older may only use the wine conditioning unit without supervision if they have been shown how to use it in a safe manner. Children must be able to understand and recognise the possible dangers caused by incorrect operation.

▶ Children must not be allowed to clean or maintain the wine conditioning unit unsupervised.

▶ Please supervise children in the vicinity of the wine conditioning unit and do not let them play with it.

▶ Danger of suffocation! Whilst playing, children could become entangled in packaging (such as plastic wrapping) or pull it over their head and suffocate. Keep packaging material away from children.

Technical safety

▶ The refrigerant circuit has been checked for leaks. The wine conditioning unit complies with statutory safety requirements and the appropriate EU directives.



Warnings and safety notes

► **Warning: fire hazard/flammable materials.** This symbol is on the compressor and indicates flammable materials. Do not remove this sticker.

The refrigerant inside the appliance (details on the data plate) is environmentally friendly but flammable.

The use of this refrigerant does, however, sometimes lead to a slight increase in the noise level of the appliance. In addition to the noise of the compressor, you might be able to hear the refrigerant flowing around the cooling circuit. Unfortunately, this cannot be avoided, but it does not affect the performance of the wine unit.

When transporting and installing the wine unit, ensure that no parts of the cooling circuit are damaged. Splashes of refrigerant can damage the eyes and leaking refrigerant can ignite.

In the event of damage:

- Avoid naked flames or anything which creates a spark.
- Disconnect the wine unit from the mains electricity supply.
- Ventilate the room where the wine unit is located for several minutes.
- Contact the Miele Customer Service Department.

► The more refrigerant there is in a wine unit, the larger the room it should be installed in. In the event of a leakage, if the appliance is in a small room, there is the danger of a combustible gas/air mixture building up. For every 8 g of refrigerant at least 1 m³ of room space is required. The amount of refrigerant in the wine unit is stated on the data plate inside the appliance.

► To avoid the risk of damage to the wine conditioning unit, make sure that the connection data (fuse rating, frequency and voltage) on the data plate corresponds to the household supply.

Check that this is the case before connecting the wine conditioning unit. Consult a qualified electrician if in any doubt.

► The electrical safety of this wine unit can only be guaranteed when continuity is complete between it and an effective earthing system. It is essential that this basic safety feature is present.

If in doubt, the electrical installation should be checked by a qualified electrician.

Warnings and safety notes

► Temporary or permanent operation on an autonomous power supply system or a power supply system that is not synchronised with the mains power supply (e.g. island networks, back-up systems) is possible. A prerequisite for operation is that the power supply system complies with the specifications of EN 50160 or an equivalent standard.

The function and operation of the protective measures provided in the domestic electrical installation and in this Miele product must also be maintained in isolated operation or in operation that is not synchronised with the mains power supply, or these measures must be replaced by equivalent measures in the installation. As described, for example, in the current version of BS OHSAS 18001–2 ISO 45001.

► If the electrical connection cable supplied is damaged, it must only be replaced by an original spare part to prevent a hazard for the user. Miele can only guarantee the safety of the appliance when original Miele spare parts are used. For safety reasons, such replacement may only be carried out by a qualified specialist or the Miele Customer Service Department.

► Do not connect the wine conditioning unit to the mains electrical supply by a multi-socket adapter or extension lead. These are a fire hazard and do not guarantee the required safety of the appliance.

► If moisture gets into electrical components, it could cause a short circuit. Therefore, do not operate this wine conditioning unit in areas which are exposed to moisture (e.g. in a garage or utility room).

► This wine conditioning unit must not be used in a non-stationary location (e.g. on a ship).

► Do not use a damaged wine conditioning unit. It could be dangerous. Check the wine conditioning unit for visible signs of damage.

► For safety reasons, this wine conditioning unit may only be used after it has been built in.

► The wine conditioning unit must be isolated from the electricity supply during installation, maintenance and repair work.

► Unauthorised installation, maintenance and repairs can cause considerable danger for the user.

Installation, maintenance and repairs must only be carried out by a Miele authorised technician.

- ▶ While the wine conditioning unit is under warranty, repairs should only be undertaken by a Miele authorised service technician. Otherwise the warranty is invalidated.
- ▶ Faulty components must only be replaced with genuine Miele original spare parts. Miele can only guarantee the safety standards of the appliance when Miele replacement parts are used.
- ▶ This wine unit is supplied with a special lamp to cope with particular conditions (e.g. temperature, moisture, chemical resistance, abrasion resistance and vibration). This lamp must only be used for the purpose for which it is intended. The lamp is not suitable for room lighting. Replacement lamps may only be fitted by a Miele authorised technician or by the Miele Customer Service Department. This wine unit contains several light sources with at least energy efficiency class G.

Proper installation

- ▶ When installing the refrigeration appliance, it is a mandatory requirement to follow the installation instructions supplied with it.
- ▶ Always wear protective gloves when transporting and installing the wine unit.
- ▶ Two people are required to install the wine unit.
- ▶ Change the door hinging (if necessary) as described in the installation instructions supplied with the appliance.

Correct use

- ▶ This wine unit is designed for use within specific ambient temperatures (climate range). Do not use in ambient temperatures for which it is not designed. The climate range is stated on the data plate inside the wine unit. A lower ambient temperature will cause the compressor to switch off for longer periods, meaning that the wine unit is unable to maintain the required temperature in some circumstances.
- ▶ Do not cover or block the air vents as this could impair the efficiency of the appliance, increase the electricity consumption and could cause damage to the components.
- ▶ If the wine unit is used for storing food which contains fat or oil, make sure that it does not come into contact with plastic components. Any spillages of oil or fat could cause stress cracks to the plastic and cause it to break or split.

Warnings and safety notes

▶ Risk of fire and explosion. Do not store explosive materials in the wine conditioning unit or any products containing propellants (e.g. spray cans). Electrical components can cause flammable mixes of gases to ignite.

▶ Danger of explosion. Do not operate any electrical appliances inside the wine conditioning unit. Danger of sparking and explosion.

Accessories and spare parts

▶ Only use original Miele accessories. If other parts are used, warranty, performance and product liability claims will be invalidated.

▶ Miele will guarantee to supply functional spare parts for a minimum of 10 years and up to 15 years following the discontinuation of your wine unit.

Cleaning and care

▶ Do not use any oils or grease on the door seals, as these will cause the seals to deteriorate and become porous with time.

▶ Do not use a steam cleaning appliance to clean this wine conditioning unit.

The steam could reach electrical components and cause a short circuit.

▶ **WARNING! DANGER of injury and damage!** Do not use any mechanical or other types of aids which are not recommended by the manufacturer to accelerate the defrosting process.

▶ Sharp edged or pointed objects will damage the evaporator, causing irreversible damage to the wine conditioning unit. Do not use sharp edged or pointed objects to

- remove frost and ice,
- remove labels, stickers etc.

Transport

- ▶ Always transport the wine conditioning unit in an upright position and in its original transport packaging to avoid damage in transit.
- ▶ Risk of injury and damage. The wine unit is very heavy and must be transported by two people.

Disposal of your old appliance

- ▶ Children playing could become trapped in the wine unit and could suffocate.
 - Remove the appliance door.
 - Leave the wooden/metal shelves in the wine unit so children cannot climb inside.
 - If the wine unit has a door lock, make sure that children cannot lock themselves inside while playing as this could endanger their lives.
- ▶ Risk of electric shock!
 - Cut the plug off the mains connection cable.
 - Cut the mains connection cable off the old appliance.

Dispose of the plug and mains connection cable separately from the old appliance.

- ▶ During and after disposal, make sure that the wine unit is not placed near petrol or other flammable gases and liquids.

- ▶ Risk of fire due to escaping oil or refrigerant!

The refrigerant and oil inside the appliance are flammable. In high enough concentrations, escaping refrigerant or oil may ignite if they come into contact with an external heat source.

During disposal, make sure that the cooling circuit is not damaged in order to prevent refrigerant and oil escaping in an uncontrolled manner (see the data plate for details of the refrigerant).

- ▶ Splashes of coolant can damage the eyes. Be careful not to damage any part of the pipework whilst awaiting disposal, e.g. by
 - puncturing the coolant channels in the condenser,
 - bending any pipework, or
 - scratching the surface coating.

Warnings and safety notes

Symbol on the compressor (depending on model)

This information is only relevant for recycling. There is no risk during normal operation.



- ▶ The oil in the compressor can be fatal if swallowed or if it penetrates the airways.

Sustainability and environmental protection

Caring for the environment

Disposing of the packaging material

The packaging material is used for handling and protects the appliance from transport damage. The packaging material used is selected from materials which are environmentally friendly for disposal and can generally be recycled.

Recycling the packaging material reduces the use of raw materials. Use material-specific collection points for valuable materials and take advantage of return options. Your Miele dealer will take the packaging material away.

Disposing of your old appliance

Electrical and electronic appliances contain many valuable materials. They also contain certain materials, compounds and components which were essential for their correct functioning and safety. These could be hazardous to human health and to the environment if disposed of with household waste or if handled incorrectly. Please do not, therefore, dispose of your old appliance with household waste.



Take care not to damage your refrigeration appliance before or during disposal in an authorised, environmentally friendly manner. This is to ensure that refrigerant in the cooling circuit and oil in the compressor is contained, and will not leak into the environment.

Instead, please make use of officially designated collection and disposal points to dispose of and recycle electrical and electronic appliances in your local community, with your dealer or with Miele, free of charge. By law, you are solely responsible for deleting any personal data from the old appliance prior to disposal. You are legally obliged to remove any old batteries which are not securely enclosed by the appliance and to remove any lamps without destroying them, where this is possible. These must be taken to a suitable collection point where they can be handed in free of charge. Please ensure that your old appliance poses no risk to children while being stored for disposal.

Sustainability and environmental protection

How to save energy ...

- Installation site** The wine unit has to cool more often at higher ambient temperatures and consumes more energy in the process. Therefore:
- Install the wine unit in a well-ventilated room.
 - Do not install the wine unit near to a heat source (heater element, cooker).
 - Protect the wine unit from direct sunlight.
 - Ensure an ideal ambient temperature of 20 °C.
 - Clean the ventilation gaps on a regular basis to remove any dust.
- Temperature setting** The colder the temperature, the higher the energy consumption. The following settings are recommended:
- +12 to +14 °C
- Use** Energy consumption is increased by heat input and impeded air circulation. Therefore:
- Only open the appliance door when necessary and for as short a time as possible. Arrange the wine bottles in such a way that makes them easy to find in the appliance.
 - Always close the appliance door properly after opening it.
 - Keep wooden shelves arranged as they were when the appliance was delivered.
 - Do not overfill the wooden shelves to allow air to circulate.
 - Keep the fan air ducts in the wine unit clear.

Guide to the appliance

KWTUS 7074

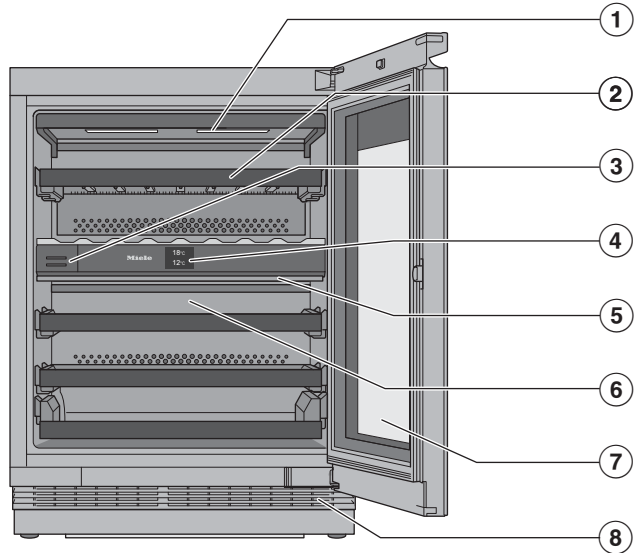

- ① Interior lighting and feature lighting 
Thanks to the use of LEDs, the wine will not be adversely affected by heat or UV light.
- ② Wooden shelves with labelling strips (NoteBoards)
- ③ Charcoal filter (Active AirClean filter)
- ④ Display
- ⑤ Insulating plate between the wine conditioning zones: different types of wine can be stored at different temperatures at the same time.
- ⑥ Dry rear panel to prevent condensate
- ⑦ Glass door: the safety glass door with UV filter and protects your wine from harmful UV rays.
- ⑧ Ventilation grille

Familiarisation

KWTUS 7096, KWTUS 7196

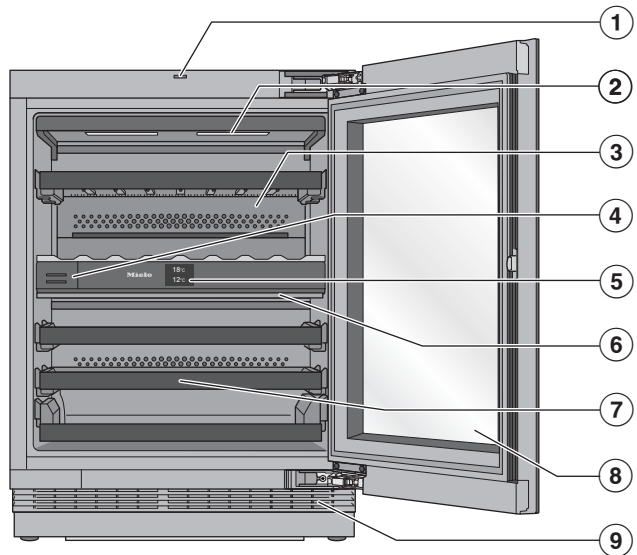

- ① Door-opening mechanism (Push2open)
- ② Interior lighting and feature lighting 
Thanks to the use of LEDs, the wine will not be adversely affected by heat or UV light.
- ③ Dry rear panel to prevent condensate
- ④ Charcoal filter (Active AirClean filter)
- ⑤ Display
- ⑥ Insulating plate between the wine conditioning zones: different types of wine can be stored at different temperatures at the same time.
- ⑦ Wooden shelves with labelling strips (NoteBoards)
- ⑧ Glass door: the safety glass door with UV filter and protects your wine from harmful UV rays.
- ⑨ Ventilation grille

Display

The display can be scratched by pointed or sharp objects, e.g. pens.
Only touch the display with your fingertips.
It is possible that the display will not react to finger contact if your fingers are cold.



- ① Demo mode display
(only visible when the Demo mode function has been switched on)
- ② Temperature display for upper wine conditioning zone and sensor control for setting the temperature
- ③ Feature lighting sensor control ☀
For switching the interior lighting on and off when the appliance door is closed
- ④ Temperature display for lower wine conditioning zone and sensor control for setting the temperature and humidity (ActiveHumidity)
- ⑤ Settings mode ⚙
sensor control for adjusting various settings in Settings mode
- ⑥ Display for Miele@home connection status
(only visible when the Miele@home function has been set up)

Operating the wine unit via the display

- Touch the area/symbol you want on the start display.
- Swipe left or right across the display until the value/symbol you want is shown in the middle.
- Tap on the option you want on the display to confirm.

The selected value/symbol will light up orange (except for a few exceptions).

- To leave the Settings level, tap on ↶ or OK.

Familiarisation

Using the door opening aid correctly

Depending on the model (KWTUS 7096, 7196), your wine unit is equipped with a door opening aid. This Push2open system makes it easy to open the appliance door. The appliance door on your wine unit is sensitive to pressure.

The Push2open system is deactivated at the factory. The function is activated when the wine unit is switched on after installation (see "Commissioning – Switching the wine unit on").

Opening the appliance door

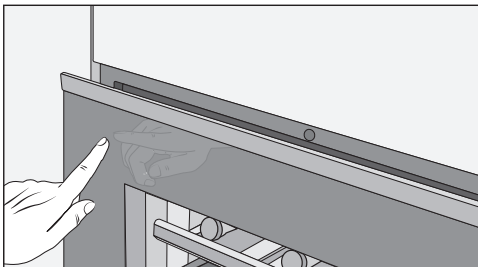

- Press gently against the top left of the appliance door and then release it. The door will open a little.
- Pull the appliance door fully open.

⚠ Risk of damage due to incorrect operation!

Obstructing the appliance door while opening it, or pushing in or holding onto the door opening aid while the door is closing, may cause damage to the door opening aid.

To bring a blocked door opening aid into its original position if necessary, remove the mains plug and reconnect it again after 5 seconds.

To protect against inadvertent opening: if you do not open the appliance door wider, it will close again by itself after approx. 3 seconds.

Closing the appliance door



- Push the appliance door shut.

Please be aware that using magnets in front of the wine unit door can cause it to open by mistake. This is caused by the door-closing mechanism on the wine unit.

Settings mode

Feature lighting

The interior lighting can be set to remain on when the appliance door is closed so your wines can be on display at all times.

The feature lighting is switched on and off using the  sensor control in the display. When the feature lighting is switched on, the  sensor control lights up orange.

The feature lighting can be switched on or off separately for each individual wine conditioning zone (see “Adjusting settings”).

Lock function /

When the lock function is switched on, it protects the wine unit from being switched off unintentionally and being adjusted unintentionally by unauthorised persons, e.g. children.

If you just want to quickly adjust the temperature, for example, you can deactivate the lock function temporarily (see “Adjusting settings”).

Switching the wine unit off

You can switch off the wine unit here (see “Commissioning – Switching the wine unit off”).

Sabbath mode

The wine unit offers a Sabbath mode for the purposes of religious observance (see “Adjusting settings”).

When Sabbath mode is switched on, the following are deactivated temporarily:

- Interior lighting when the appliance door is opened

- Feature lighting when the appliance door is closed
- The display
- All visual and audible signals
- An active WiFi connection
- Reminders (e.g. Active AirClean filter display): the set time interval is paused

All other functions switched on previously remain activated.

When Sabbath mode is switched on, you cannot make any settings on your wine unit.

Information on Sabbath mode

You can call up the Sabbath mode version here.

Time before door alarm is triggered

You can set the time before the appliance door alarm is triggered here (see “Adjusting settings”).

Miele@home

Your wine unit is equipped with an integrated WiFi module.

Networking is deactivated at the factory.

Here you can set up the Miele@home function for the first time, deactivate and activate the WiFi or reset the network configuration (see “Adjusting settings”).

To use this feature, you will need:

- A WiFi network
- The Miele app
- A Miele user account. You can create a user account via the Miele app.

Familiarisation

The Miele app will guide you as you connect your wine unit to your home WiFi network.

Once your wine unit is connected to your WiFi network, you can use the app to carry out the following activities, for example:

- Call up information on the operating status of your wine unit
- Change the settings on your wine unit

Connecting your wine unit to your WiFi network will increase energy consumption, even when the wine unit is switched off.

Make sure that the signal of your WiFi network is sufficiently strong in the place where you want to set up your wine unit.

Keypad tone

You can switch the keypad tone on or off here (see “Adjusting settings”).

Alarms and buzzers

You can change the volume of the alarms and buzzers (e.g. in the event of a door alarm or a fault message) here. Alternatively, you can switch the alarms and buzzers off completely if you find them annoying (see “Adjusting settings”).

Display brightness

You can adjust the display brightness to the lighting conditions in the room here (see “Adjusting settings”).

Temperature unit °C/°F

You can set the required temperature unit (°Celsius or °Fahrenheit) here (see “Adjusting settings”).

Demo mode

You can switch off demo mode here if it has been switched on as a default setting ( will show in the display) (see “Adjusting settings”).

Demo mode allows the wine unit to be presented in the showroom without the cooling system being switched on. This setting is not needed for domestic use.

Factory defaults

You can reset the wine unit’s settings to their factory defaults here (see “Adjusting settings”).

Tip: Reset the settings to the factory defaults when disposing of your wine unit, selling it or putting a used wine unit into operation. This will reset the network configuration so that your personal data is deleted from the wine unit. This will also ensure that a previous owner is no longer able to access the wine unit.

Information on the wine unit

You can call up the model identifier and serial number of your wine unit here.

Keep this appliance data to hand:

- For integrating the wine unit into your WiFi network (see “Adjusting settings – Setting up Miele@home for the first time”)
- When reporting an appliance fault to the Miele Customer Service Department (see “Customer Service Department”)
- When retrieving information from the EPREL database (see “Customer Service Department”)

Active AirClean filter display

Filtering the air through the Active AirClean filter ensures that the air remains free from dust and odours.

The Active AirClean filter display  will remind you approx. every 12 months that the Active AirClean filters have to be replaced (see “Cleaning and care – Replacing the Active AirClean filter (active charcoal filter)”).

You can activate the Active AirClean filter display  here (see “Adjusting settings”).

Accessories supplied

Charcoal filter (Active AirClean filter)

The Active AirClean filter ensures optimum air quality in the wine unit by filtering the incoming air.



Chalk pen

Use the chalk pen supplied to label the NoteBoards on the wooden shelves. By labelling the NoteBoards you will have a good overview of the types of wine being stored.

Safety

Temperature alarm

The wine unit is equipped with a temperature alarm so that the temperature cannot rise or fall unnoticed and therefore damage the wine.

If the temperature becomes too warm or too cold,   will light up red in the corresponding temperature display.

An alarm will also sound until the cause of the alarm is rectified or the alarm is switched off.

The set temperature determines when the appliance recognises a temperature as being too warm or too cold.

The audible and visual signals may be activated in the following situations:



- Too much warm ambient air enters the wine unit when you are rearranging or taking out wine bottles.
- You are storing a large number of wine bottles.
- There was a power failure.
- There is a fault with the wine unit.

Switching the temperature alarm off early

Before you switch the temperature alarm off, you must determine the cause and rectify it.

If you are bothered by the sound of the alarm, you can switch the alarm off early.

■ Tap  .

  goes out and the alarm will stop.



The warmest temperature recorded in the wine conditioning zone concerned will flash for about 1 minute in the temperature display for the wine conditioning zone. Then the temperature display will change to the current temperature in the wine conditioning zone.

Familiarisation

Door alarm

The wine unit is fitted with a door alarm to avoid increased energy consumption if the door is left open and prevent the stored wine bottles being affected by temperature fluctuations.

If the appliance door is left open for a longer period of time,  will light up yellow in the display. An alarm will also sound and the interior lighting will flash.

The amount of time until the door alarm is triggered can be changed (see “Adjusting settings – Changing the time until the door alarm  is triggered”). The door alarm’s audible signal can also be switched off (see “Adjusting settings – Changing the volume of the alarms and buzzers ”).

The alarm will stop and  will go out on the display as soon as the appliance door is closed.

Switching the door alarm off early

■ Tap .

The alarm will stop,  will go out and the interior lighting will light up again constantly.

If the appliance door is not closed, the door alarm will sound again after a short time.

Adjusting the interior fittings

Removing and reinserting the wooden shelves

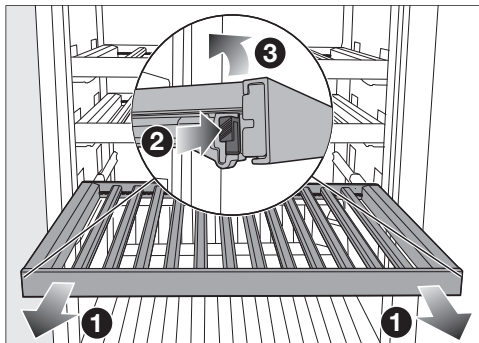

- Pull the wooden shelf out until it stops **1**.
- Press in the latches **2** on both sides of the wooden shelf and lift the wooden shelf upwards **3**.
- To reinsert the wooden shelf, first place it on the rear of the extended rails so that it clicks into place.
- Press the front section of the wooden shelf down onto the extended rails so that the latches click into place.

 Risk of injury from falling wine bottles.

Wine bottles may become wedged in the wooden shelves above and fall out of the wine unit/refrigeration appliance when the shelves are pulled out.

Always pull out the wooden shelves slowly and carefully.

 Risk of damage and injury from broken glass.

If wooden shelves and bottles protrude too far forwards, they may damage the glass door when it is closed.

Please ensure that the wooden shelves and wine bottles do not protrude.

Adjusting the wooden shelf (FlexiFrame) to the bottle size

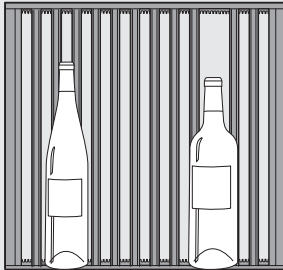

- You can remove or move individual wooden slats on the wooden shelf as required.

This allows you to flexibly adapt the wooden shelf to the size of your wine bottles.

The slats in the bottom shelf cannot be adjusted.

Maximum capacity

KWTUS 7074 and 7096

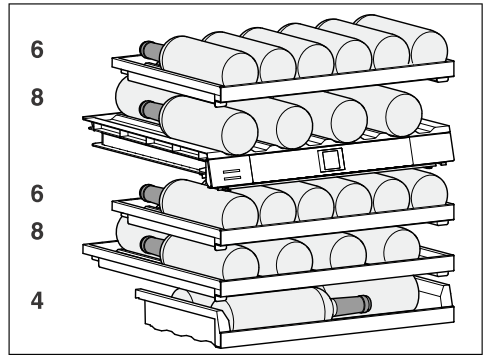

A maximum of 32 Bordeaux-type bottles (0.75 litres) can be stored in the wine unit, with 14 in the upper wine conditioning zone and 18 bottles in the lower zone.

KWTUS 7196

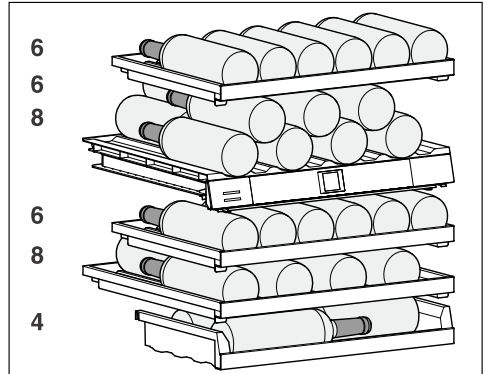

A maximum of 38 Bordeaux-type bottles (0.75 litres) can be stored in the wine unit, with 20 in the upper wine conditioning zone and 18 bottles in the lower zone.

Familiarisation

⚠ Risk of damage due to overload. Exceeding the maximum recommended capacity can lead to damage to the wooden shelves. Do not exceed the maximum load-bearing capacity of 25 kg for each wooden shelf. Do not stack bottles on the wooden shelves.

Labelling the labelling strip (NoteBoard)

For quick and easy identification of the wines stored, you can write on the NoteBoards on the wooden shelves. Depending on the model, you can write directly on the NoteBoard or remove it from the wooden shelf if it is magnetic.

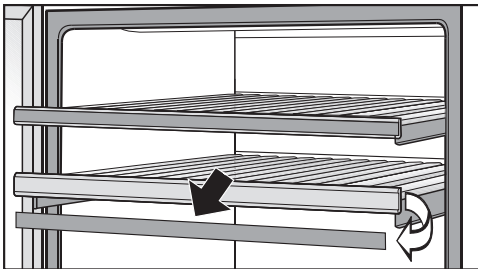

- Hold the magnetic NoteBoard by the sides and pull it forwards.
- The NoteBoard can be wiped clean with a damp cloth.
- The labelling strip can be wiped clean with a damp cloth.

⚠ Risk of damage from unsuitable cleaning agents. Cleaning the labelling strips (NoteBoards) with a cleaning agent may damage the coating on them. Use clean water only to wipe the NoteBoards.

- Label the NoteBoard with the chalk pen supplied. Alternatively, we recommend the following products for labelling:

- Liquid chalk pens, such as an edding 4095 chalk marker
- Traditional blackboard chalk

⚠ Risk of damage due to writing with the wrong products. Never write on the NoteBoard with a ballpoint pen, crayon or pencil, correction pencil, wax crayon, oil chalk or felt-tip pen (e.g. permanent marker, highlighter, foil pen, etc.). They are difficult or impossible to remove from the NoteBoard. Only use the products recommended to write on the NoteBoard as these can be removed easily.

Before using for the first time

- Remove all packaging material and protective foil.

The short, cross-fixed wooden slats are only used to attach the remaining wooden slats to the wooden shelf.

The short wooden slats can be removed and safely disposed of with household waste. These wooden slats come from surplus production and are used as transport safety devices for reasons of sustainability.



- Clean the inside of the appliance and the accessories (see “Cleaning and care”).

Connecting the wine unit

- Connect the wine unit to the electricity supply as described in “Installation – Electrical connection”.

Miele will then appear on the appliance display, followed by .

Activating the charcoal filter (Active AirClean filter)

- Activate the Active AirClean filter display  (see “Adjusting settings – Activating the Active AirClean filter display ”).

Positioning the wooden slats on the wooden shelves

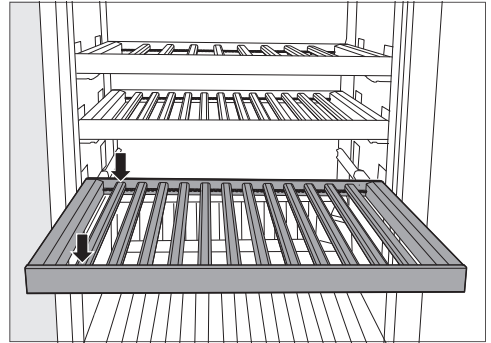

- Position the wooden slats at equal intervals on the wooden shelf and lock them into position.

This provides space on the wooden shelf for the maximum number of bottles (0.75 l; Bordeaux-style bottles).

Switching the wine unit on



- Tap  on the display.

If you do not interact with the display for a certain period of time, it switches to energy-saving mode and goes dark.

The wine unit will start to cool and the interior lighting will come on when the appliance door is opened.

Depending on the ambient temperature and the temperature setting, it can take the appliance a few hours to reach the temperature required in the corresponding wine conditioning zones and for this temperature to then be shown as a constant temperature on the display.

Switching the wine unit off

- Tap .
- Swipe left or right until  is shown in the middle.

Commissioning

- Tap .

The cooling and interior lighting are switched off.

 will appear in the display.

Please note: The wine unit is not disconnected from the power supply when it is switched off.

Switching off for longer periods of time

If, during a long absence, the wine unit is switched off but not cleaned and the door left shut, there is a danger of mould building up inside the appliance.

The wine unit must be cleaned.



If the wine unit is not going to be used for a longer period of time, observe the following:

- Switch the wine unit off.
- Switch off at the wall and disconnect the plug from the socket, or disconnect the fuse.
- Clean the wine unit and leave the door ajar to air the wine unit and avoid odours building up inside it.

Setting the temperatures in the wine conditioning zones

The temperatures in the 2 wine conditioning zones can be set independently of one another.

A temperature of between 12 and 14 °C is recommended to store wine over the long term.

- Touch the temperature display for the wine conditioning zone you want to change.
- **Lower wine conditioning zone:** tap .
- Swipe left or right until the temperature you want is shown in the middle.
- Tap the temperature you want to confirm.
- To leave this Settings level, tap .

The temperature display will then change back to the current temperature in the wine conditioning zone.

The temperature in the wine unit will rise:

- The more often the appliance door is opened and the longer it is kept open
- The more wine bottles are being stored
- The warmer the newly stored wine bottles are
- The higher the ambient temperature surrounding the wine unit This wine unit is designed for use within specific ambient temperatures (climate range). Do not use in ambient temperatures for which it is not designed.

Temperature range

The temperature in the wine conditioning zones can be adjusted from 5 to 20 °C.

Temperature display for the wine conditioning zones

In normal operation, the temperature display shows the **current average temperature** inside the corresponding wine conditioning zone.

Depending on the ambient temperature and the temperature setting, it can take the appliance a few hours to reach the temperature required and for this temperature to then be shown as a constant temperature in the display.





Adjusting settings

Explanation of the different settings



The door alarm and other warnings are automatically disabled when the appliance is in Settings mode .

Setting the brightness of the feature lighting



The feature lighting can be set separately at different brightness levels for each individual wine conditioning zone or switched off completely.

- Tap .
- Swipe left or right until  is shown in the middle.
- Tap .
- Swipe left or right until the wine conditioning zone you want is shown in the middle.
- Tap the wine conditioning zone you want.
- Select the brightness you want by swiping the segment bar to the left or right (level 1–7).
- If you want to switch the feature lighting off completely, swipe to the left until the segment bar goes out completely.
- Confirm the setting you want by tapping the segment bar.
- Alternatively: confirm the setting you want by tapping .
- To leave this Settings level, tap .

Switching the lock function / on

- Tap .
- Swipe left or right until  is shown in the middle.
- Tap .

When the lock function is switched on,  will light up orange.

- To leave this Settings level, tap .
- Close the appliance door. Only then will the lock function  be active.

Deactivating the lock function / temporarily

If you want to adjust the temperature, for example, you can deactivate the lock function temporarily:





- Touch the temperature display for the temperature zone you want to adjust.
- Touch  for approx. 6 seconds.

The display switches to the temperature controls.

- Now select the required settings.

Closing the appliance door will reactivate the lock function .

Switching the lock function / off completely



- Tap .
- Touch  for approx. 6 seconds.
- Swipe left or right until  is shown in the middle.
- Tap .

When the lock function is switched off,  will light up white.

- To leave this Settings level, tap .

Switching Sabbath mode on

When Sabbath mode  is switched on, you cannot change any settings.

- Tap .
- Swipe left or right until  is shown in the middle.
- Tap .

 will light up orange.

- To leave this Settings level, tap .

If Sabbath mode  is switched on, this is indicated on the display for approx. 3 s.

The display then switches off.

Ensure that the appliance door is properly closed, as visual and audible alarms are switched off.

Switching Sabbath mode off

The Sabbath mode function  will switch off automatically after approx. 80 hours.

However, you can switch the Sabbath mode function  off early.

- Tap the black display.

 will appear in the display.

- Tap .

 will light up orange.

- Tap the  symbol again.

When Sabbath mode is switched off,  will light up white.

- To leave this Settings level, tap .

Changing the time before the door alarm is triggered

- Tap .

- Swipe left or right until  is shown in the middle.

- Tap .

- Swipe left or right until the time you want between 30 seconds and 3 minutes 30 seconds is shown in the middle.

- Tap to confirm the setting.

- To leave this Settings level, tap .

Setting up Miele@home for the first time

- Tap .

- Swipe left or right until  is shown in the middle.

- Tap .

- Tap the connection method you wish to use (app or WPS).

After you have successfully logged in,  will appear in the display.

If a connection could not be created,  will appear.

- In this case, start the process again.

- To leave this Settings level, tap .

Deactivating the WiFi connection

- Tap .

- Swipe left or right until  is shown in the middle.

- Tap .

- Tap  to deactivate the WiFi connection.

 will appear in the display.

- To leave this Settings level, tap .

Activating the WiFi connection

- Tap .

- Swipe left or right until  is shown in the middle.

- Tap .

- Tap  to activate the WiFi connection.







 will appear in the display.

- To leave this Settings level, tap .

When the WiFi connection is active,  will light up on the display.

Adjusting settings

Resetting the network configuration



- Tap .
- Swipe left or right until  is shown in the middle.
- Tap .
- Swipe right until  is shown in the middle.
- Tap .
- Tap .
- To leave this Settings level, tap .

All entered settings and values for Miele@home are reset to the default settings.

The WiFi connection has been deactivated.  will go out on the start display.

Reset the network configuration if you are disposing of or selling your refrigeration appliance, or if you are putting a used refrigeration appliance into operation. All personal data is removed from the refrigeration appliance. This will also ensure that a previous owner is no longer able to access the refrigeration appliance.



Switching off the keypad tone

- Tap .
- Swipe left or right until  is shown in the middle.
- Tap .

If the keypad tone is switched off,  will light up white.

- To leave this Settings level, tap .

Switching on the keypad tone



- Tap .
- Swipe left or right until  is shown in the middle.

- Tap .

If the keypad tone is switched on,  will light up orange.

- To leave this Settings level, tap .

Changing the volume of the alarms and buzzers

- Tap .
- Swipe left or right until  is shown in the middle.
- Tap .

- Select the volume you want by swiping the segment bar to the left or right (level 1–7).

- If you want to switch the alarms and buzzers off completely, swipe to the left until the segment bar goes out completely.



- Confirm the setting you want by tapping the segment bar.

When the alarms and buzzers are switched off,  will light up white.

When the alarms and buzzers are switched on,  will light up orange.

- To leave this Settings level, tap .

Changing the display brightness

- Tap .
- Swipe left or right until  is shown in the middle.
- Tap .

- Select the brightness you want by swiping the segment bar to the left or right (level 1–7).

- Confirm the setting you want by tapping the segment bar.

- To leave this Settings level, tap .





Changing the temperature unit °C/°F

- Tap .
- Swipe left or right until °C or °F is shown in the middle.
- Tap °C or °F to change the temperature unit.

°C or °F will appear on the display.





- To leave this Settings level, tap .

Switching off demo mode

- Tap .
- Tap .
- Swipe left or right until  is shown in the middle.
- Tap .



After demo mode  has been switched off, the refrigeration appliance shuts down and must be switched on again.

Resetting the settings to their factory defaults

- Tap .
 - Swipe left or right until  is shown in the middle.
 - Tap .
-  will appear in the display.
- Tap .

The refrigeration appliance shuts down and must be switched on again.

Activating the Active AirClean filter display

- Tap .
- Swipe left or right until  is shown in the middle.
- Tap .

If the Active AirClean filter display is activated,  will light up orange.

- To leave this Settings level, tap .

Cleaning and care

The data plate located inside the wine unit must not be removed. It contains information which is required in the event of a fault.

Do not let water get into the electronic unit or the lighting.

 Risk of damage due to moisture ingress.

The steam from a steam cleaner can damage plastic and electrical components.

Do not use a steam cleaner to clean the wine unit.

 Health risk due to soiling entering the appliance.

Soiling that enters the appliance from outside (such as food or drink residues) can cause mould to form in the wine unit at increased temperature and humidity levels.

Only place clean wine bottles and clean accessories in the wine unit.

Cleaning agents

Cleaning agents and care products used inside the wine unit must be food safe.

To avoid damaging the surfaces of the appliance, **do not use the following:**

- Cleaning agents containing soda, ammonia, acids or chlorides
- Cleaning agents containing descaling agents
- Abrasive cleaning agents (e.g. scouring powder, scouring liquid or pumice stones)
- Cleaning agents containing solvents
- Stainless steel cleaners

- Dishwasher cleaning agents
- Oven sprays
- Cleaning agents for ceramic hobs (except to clean the glass front)
- Glass-cleaning agents (except to clean the glass front: for this, a glass-cleaning agent containing a little alcohol, but no citric or similar additives, may be used)
- Hard, abrasive sponges and brushes (e.g. pot scourers)
- Eraser stain remover blocks
- Sharp metal scrapers

We recommend using a clean sponge cloth and lukewarm water with a little washing-up liquid to clean the surfaces of the appliance.

Preparing the wine unit for cleaning

- Switch the wine unit off.

 appears in the display and the cooling system is switched off.

- Take any wine bottles out of the wine unit and store them in a cool place.
- If necessary, take out all removable parts for cleaning (see “Familiarisation – Adjusting the interior fittings”).
- Before cleaning the wooden shelves, remove the labelling strips (NoteBoards) if they are removable (depending on the model).

Cleaning the inside of the appliance

Clean the wine unit at least once a month.

If soiling is left on for any length of time, it may become impossible to remove under certain circumstances. Surfaces may suffer discolouration or damage. It is therefore best to remove any soiling immediately.

- Clean the interior with a clean sponge cloth, lukewarm water and a little washing-up liquid.
- Rinse all parts by hand. Do not wash in a dishwasher.
- The **wooden** shelves should only be wiped with a well wrung-out damp cloth. They must **not** be allowed to get wet.

 Risk of damage from unsuitable cleaning agents. Cleaning the labelling strips (NoteBoards) with a cleaning agent may damage the coating on them. Use clean water only to wipe the NoteBoards.

- After cleaning, wipe with clean water and dry with a cloth.
- Leave the door open to air the wine unit sufficiently for a short while and to prevent odour build-up.
- Clean the appliance door with a proprietary glass cleaner.

Replacing the Active AirClean filter

New Active AirClean filters can be obtained from the Miele Customer Service Department, your Miele dealer or the Miele website.

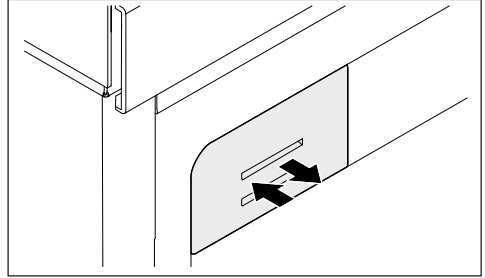

- Press in the filter holder, release it again and pull it out.

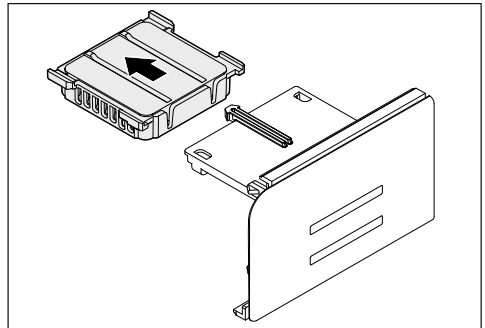

- Remove the used Active AirClean filter.
- Used Active AirClean filters can be disposed of with normal household waste.

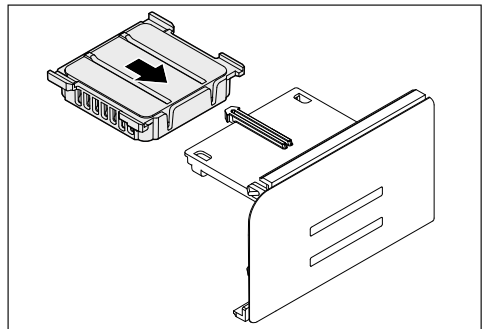

- Insert the new Active AirClean filter.

Cleaning and care

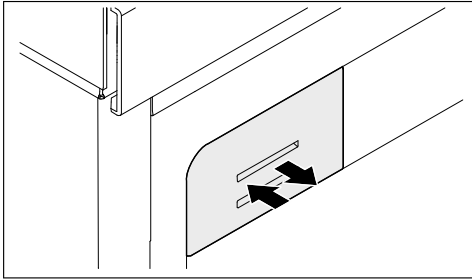

Automatic defrosting

The wine unit defrosts automatically.

- Push the filter cover in as far as it will go.

Cleaning the door seal

 Risk of damage as a result of incorrect cleaning.

If you treat the door seal with oils or grease, it can become porous. Do not use any oils or grease on the door seal.

- The door seal should be cleaned regularly with clean water, and then wiped dry with a soft cloth.

Cleaning the ventilation gaps

A build-up of dust will increase the energy consumption of the appliance.

- The ventilation gaps should be cleaned on a regular basis with a brush or vacuum cleaner (you could use a Miele vacuum cleaner dusting brush, for example).

After cleaning

- Replace all shelves and accessories in the wine unit.
- Switch the wine unit on.
- Place the wine bottles in the wine unit and close the appliance door.

Many malfunctions and faults can be easily remedied. You can save time and money in many cases, as you do not need to contact Customer Service.

More information to help you remedy faults yourself can be found at www.miele.co.uk/support/customer-assistance.







To prevent cold from escaping, open the appliance as little as possible until the fault has been corrected.













Problem	Cause and remedy
The compressor is switching on more frequently and for longer periods of time, the temperature in the wine unit is falling.	The ventilation openings have been covered or become dusty. <ul style="list-style-type: none"> ■ Do not block the ventilation openings. ■ Dust the ventilation openings regularly.
	The appliance door has been opened too frequently. A large number of wine bottles have been placed in the appliance. <ul style="list-style-type: none"> ■ Only open the appliance door when necessary and for as short a time as possible. After a while, the temperature will return to normal by itself.
	The appliance door is not properly closed. <ul style="list-style-type: none"> ■ Close the appliance door. After a while, the temperature will return to normal by itself.
	The ambient temperature is too high. The higher the ambient temperature, the longer the compressor runs. <ul style="list-style-type: none"> ■ See the information in “Installation – Installation site”.
	The temperature in the wine unit is set too low. <ul style="list-style-type: none"> ■ Correct the temperature setting.

Troubleshooting











General problems with the wine conditioning unit

Problem	Cause and remedy
<p>There is no audible alarm even though the appliance door has been open for a long time.</p>	<p>This is not a fault. The alarm has been switched off in Settings mode. If you want to switch the audible alarm back on again:</p> <ul style="list-style-type: none"> ■ Tap . ■ Swipe left or right until  is shown in the middle. ■ Tap . ■ Select the volume you want by swiping the segment bar to the right. ■ Confirm the setting you want by tapping the segment bar. <p>When the alarms and buzzers are switched on,  orange will appear.</p>







Display warnings

Message	Cause and remedy
<p> lights up in the display and the wine unit is not getting cold. However, the appliance and the interior lighting are working fine.</p>	<p>Demo mode has been activated.</p> <ul style="list-style-type: none"> ■ Tap . ■ Tap . ■ Swipe left or right until  is shown in the middle. ■ Tap . <p>After demo mode  has been switched off, the wine unit shuts down and must be switched on again.</p>
<p>Nothing is visible in the display. The display is completely blank.</p>	<p>Sabbath mode  is switched on: the interior lighting is switched off and the wine unit is cooling down.</p> <ul style="list-style-type: none"> ■ Tap the black display. <p> will appear in the display.</p> <ul style="list-style-type: none"> ■ Tap . <p> will light up orange.</p> <ul style="list-style-type: none"> ■ Tap the  symbol again. <p>When Sabbath mode is switched off, the  symbol will light up white.</p> <hr/> <p>Energy-saving mode is switched on: if you do not interact with the display for a certain period of time, it switches to energy-saving mode and goes dark.</p>











Troubleshooting

Message	Cause and remedy
 lights up in the display and the wine unit cannot be used.	<p>The lock function has been activated.</p> <ul style="list-style-type: none"> ■ Unlock the wine unit temporarily or switch the lock function off completely (see “Adjusting settings”).
 lights up in the display and a buzzer sounds.	<p>The Active AirClean filter display  is reminding you that the Active AirClean filter needs to be changed.</p> <ul style="list-style-type: none"> ■ Replace the Active AirClean filter (see “Cleaning and care – Replacing the Active AirClean filter”). Confirm that you have changed the Active AirClean filter by touching  in the display. <p> will go out on the display.</p>
 will light up yellow in the display, an alarm will also sound and the interior lighting will flash.	<p>The door alarm has been activated.</p> <ul style="list-style-type: none"> ■ Tap . <p>The alarm will stop,  will go out and the interior lighting will light up again constantly.</p>
 will light up red in one of the wine conditioning zones and an alarm will also sound.	<p>The temperature alarm has been activated. The temperature in the wine conditioning zone concerned has risen higher or fallen lower than the temperature set.</p> <ul style="list-style-type: none"> ■ Tap . <p> goes out and the alarm will stop.</p> <p>The warmest temperature recorded in the wine conditioning zone concerned will flash for about 1 minute in the temperature display for the wine conditioning zone. Then the temperature display will change to the current temperature in the wine conditioning zone.</p> <p>You can exit from the flashing temperature display early:</p> <ul style="list-style-type: none"> ■ Touch the temperature display for the wine conditioning zone. <p>The warmest temperature display will disappear. The temperature display will then revert to showing the current temperature in the wine conditioning zone.</p> <ul style="list-style-type: none"> ■ Remedy the cause of the alarm.

Troubleshooting

Message	Cause and remedy
<p> lights up red in the display and an alarm also sounds.</p>	<p>Indication of a power failure: the temperature in the wine unit over the last few days or hours has risen too high because of a power failure or interruption to the power supply.</p> <ul style="list-style-type: none"> ■ Tap . <p> goes out and the alarm will stop.</p> <p>The warmest temperature recorded in the wine unit will flash for about 1 minute in the temperature display. Then the temperature display will change to the current temperature.</p> <p>You can exit from the flashing temperature display early:</p> <ul style="list-style-type: none"> ■ Tap the temperature display. <p>The warmest temperature display will disappear. The temperature display will then revert to showing the current temperature. The wine unit will go back to the last temperature setting when the power is back on.</p> <ul style="list-style-type: none"> ■ Remedy the cause of the alarm.
<p> lights up red in the display and a fault code F with numbers may appear. An alarm is also sounding.</p>	<p>There is a fault.</p> <ul style="list-style-type: none"> ■ Tap  on the display to switch the alarm off. ■ Contact the Miele Customer Service Department. <p>To report the fault, you need the fault code and also the model identifier and serial number of your wine unit. You can access this information on the display:</p> <ul style="list-style-type: none"> ■ To do this, touch  on the display. <p>The appliance data required will be shown on the display.</p> <p>Confirm with  to exit the information display and the fault code will be shown again on the display.</p> <p>The wine unit can be switched off directly from the fault message display.</p> <hr/> <p>There is an appliance fault: this display always has priority over any settings which have just been selected.</p> <p>An appliance fault has priority over any current door and/or temperature alarms displayed.</p>

Interior lighting

Problem	Cause and remedy
<p> Risk of electric shock due to exposed, live electrical components. When removing the lighting cover, there is a risk of coming into contact with live electrical components. Do not remove the lighting cover. The LED lighting may only be repaired or replaced by the Miele Customer Service Department.</p>	
<p> Risk of injury from LED lighting. This lighting corresponds to risk group RG 2. If the cover is defective, there is a risk of eye injury. If the lighting cover is defective, do not look from a close range directly into the lighting with optical instruments (e.g. magnifying glass or similar).</p>	
Problem	Cause and remedy
<p>The interior lighting is not working.</p>	<p>The wine unit is not switched on.</p> <ul style="list-style-type: none"> ■ Switch the wine unit on.
	<p>Sabbath mode  is switched on: the display is dark and the wine unit is cooling.</p> <ul style="list-style-type: none"> ■ Tap the black display. <p> will appear in the display.</p> <ul style="list-style-type: none"> ■ Tap . <p> will light up orange.</p> <ul style="list-style-type: none"> ■ Tap the  symbol again. <p>When Sabbath mode is switched off,  will light up white.</p>
	<p>To avoid overheating, the interior lighting switches itself off automatically after approx. 15 minutes if the appliance door is left open. If this is not the case, then there is a fault.</p> <ul style="list-style-type: none"> ■ Contact the Miele Customer Service Department.
<p>The interior lighting is on even when the appliance door is closed.</p>	<p>This is not a fault. The feature lighting is switched on.</p> <ul style="list-style-type: none"> ■ To switch off the feature lighting, touch the sensor control for the feature lighting  in the display. <p>The  sensor control no longer lights up orange.</p>

Customer Service Department

Information to help you rectify faults yourself and about Miele spare parts can be found at www.miele.com/service.

Contact in the event of a fault

In the event of a fault which you cannot remedy yourself, please contact your Miele dealer or Miele Customer Service.

You can book a Miele Customer Service call-out online at www.miele.com/service.

Contact information for Miele Customer Service can be found at the end of this document.

Please quote the model identifier and serial number of your appliance (SN) when contacting Miele Customer Service. Both numbers can be found on the data plate inside the refrigeration appliance or, depending on the model, in Settings mode under Information **i**.

EPREL database

Since 1 March 2021, information on energy labelling and ecodesign requirements has been available in the European Product Database (EPREL). You can find the product database at the following link <https://eprel.ec.europa.eu/>. You will be asked to enter the model identifier.

The model identifier can be found on the data plate inside the refrigeration appliance or, depending on the model, in Settings mode under Information **i**.

Miele			
XXXXXX		Nr. XX/XXXXXXXXXX.	
WEINTEMPERIER-SCHRANK-UNTERTISCH-MODELL MULTI-TEMPERATURE WINE STORAGE CABINET-UNDER-COUNTER TOP ARMOIRE DE MISE EN TEMP. DES VINS/MO.C. ENCASTRABLE SOUS PLAN АРМОРИТ-ПЛАЩЕДКОСТАТО. ВИНС-МОДЕЛ ПОТРУБНОЈ ИНСТАЛАЦИЈЕ ВІННИЙ ТЕМПЕРАТУРНИЙ ШКАП			
Klasse/Class Classe/Clase SN-ST	Ap-Typ/AP-Type AP-Tipo/AP-Tipo	Bruttinhalt/Gross Capacity Volume Brut/Capacità Bruta XXXX l	Gefriervermögen/Freezing Capacity Pouvoir de Congel/Capac. Congeladora
Netzhalt Net Capacity Volume Utile Capac. Util	Ges. /K /G Tot. /R /F To. /R /C Tot. /F /C	/WEN /KALT /WINE /CHILL /WINE /CHILL /WINE /CHILL	R600a: XXg

Warranty

For information on the appliance warranty specific to your country please contact Miele. See back cover for address.

In the UK, your appliance warranty is valid for 2 years from the date of purchase. However, you must activate your cover by calling 0330 160 6640 or registering online at www.miele.co.uk.

Multi-purpose microfibre cloth

The microfibre cloth is suitable for removing fingerprints and light soiling from surfaces such as stainless steel, glass, plastic and chrome without the use of chemicals.

MicroCloth Kit

The MicroCloth Kit contains a universal cloth, a glass cloth and a polishing cloth. These cloths are extremely resistant to tearing and very robust. Thanks to very fine microfibres these cloths achieve an excellent cleaning performance.

MicroCloth HyClean

The MicroCloth HyClean is a multi-purpose antibacterial cloth and is particularly tear resistant and durable. It can be used wet or dry, with or without cleaning agent.

Charcoal filter (Active AirClean filter)

The Active AirClean filter ensures optimum air quality in the wine unit by filtering the incoming air.

Optional accessories can be ordered from the Miele webshop. They can also be ordered from the Miele Customer Service Department (see end of this booklet for contact details) or from your Miele dealer.

Installation

Installation site

 Risk of damage and danger of injury due to the wine unit tipping over.

This wine unit is very heavy and can tip forwards when the appliance door is open.

Keep the appliance door(s) closed until the wine unit has been built in. The wine unit must be secured in its building-in niche in accordance with the operating and installation instructions.

 Fire risk and risk of damage from appliances which give off heat.

Appliances which give off heat can catch fire and set fire to the wine unit.

This wine unit must not be installed underneath a hob.

 Risk of damage due to high humidity.

In environments with high humidity, condensation can build up on the external wine unit panels.

This condensation can cause corrosion on external appliance panels.

Install the wine unit with sufficient ventilation in a dry and/or air-conditioned room.

After installation, please make sure that the appliance door closes properly and that the specified ventilation gaps are adhered to.

 Risk of damage caused by appliances discharging vapours. Installing appliances that discharge vapours behind the wine unit will put it at risk of damage.

Do not install appliances that discharge air or vapours behind the wine unit. Provide a separate air guide or install a partition wall between the appliances.

 Fire risk and risk of damage from open flames.

Open flames can set fire to the wine unit.

Keep open flames (e.g. a candle) away from the wine unit.

This appliance should be installed in a dry, well-ventilated room.

When deciding on the installation site, please bear in mind that the energy consumption increases if the wine unit is installed near to a heater, a cooker or another appliance that gives off heat. Direct sunlight should also be avoided. The higher the room temperature, the longer the compressor runs and the higher the energy consumption is.

When installing the wine unit, please note the following:

- The socket must be easily accessible in an emergency, not concealed behind the appliance.
- The mains plug and mains connection cable must not touch the rear of the wine unit as they could be damaged by vibrations from the wine unit.
- Do not plug in other appliances into sockets behind this wine unit.
- When installing the wine unit, make sure that the mains connection cable does not get trapped or damaged.

- Do not position or operate multi-socket adapters, distributor strips or other electronic devices (e.g. halogen transformers) at the rear of the appliance.
- The floor at the installation site must be horizontal and level and must be as high as the surrounding floor.

 **Danger from broken glass!**
 Danger of injury from broken glass. If installed at altitudes above 1500 m there is a risk of the glass in the door breaking because of changes in air pressure. Shards of glass can cause severe injury if not handled with care.

Climate range

This wine unit is designed for use within specific ambient temperatures (climate range). Do not use in ambient temperatures for which it is not designed. The climate range is stated on the data plate inside the wine unit.

Climate range	Ambient temperature
SN	10 to 32 °C
N	16 to 32 °C
ST	16 to 38 °C
T	16 to 43 °C
SN-ST	10 to 38 °C
SN-T	10 to 43 °C

A lower ambient temperature will cause the compressor to switch off for longer periods, meaning that the wine unit is unable to maintain the required temperature in some circumstances.

Ventilation

Ventilation takes place through a ventilation grille in the wine unit plinth.

 Fire risk and risk of damage due to insufficient ventilation.

If the wine unit is not ventilated sufficiently, the compressor will run more frequently and for longer periods. This will result in increased energy consumption and a higher operating temperature for the compressor. This may, in turn, cause damage to the compressor.

Please ensure that there is adequate ventilation around the wine unit.

It is essential to observe the required ventilation gaps.

The ventilation gaps must not be covered or blocked in any way.

They must also be regularly dusted.

Side-by-side

This wine conditioning unit can be installed side-by-side with another refrigeration appliance.

A side-by-side installation kit is required for this. This is available from Miele or your Miele dealer.

Your dealer will be able to advise you which combination of models is possible.

Instructions for fitting appliances side-by-side are given in the side-by-side fitting kit instruction manual.

Installation

Changing the door hinging

⚠ Danger of injury and damage to the appliance due to heavy door. There is an increased risk of injury and damage if the door hinging is installed by a single person. Always change the door hinging with the help of a second person.

⚠ Risk of crushing at the hinge. Fingers can get trapped in or around the hinge. Do not reach into the hinge when opening and closing the door.

The wine unit is supplied with right-hand hinging. If left-hand hinging is required, the hinges must be changed (see accompanying installation instructions) before the wine unit is installed in the niche.

Tip: Place a suitable cover on the floor in front of the wine unit to protect the appliance door and your floor from damage when changing the door hinging.

⚠ Risk of injury and damage. The glass door can drop. When changing the door hinging make sure that all fixing parts are securely screwed into position.

Be careful not to damage the door seal. If the door seal is damaged, the appliance door may not close properly and cooling will be insufficient.

Limiting the opening angle of the appliance door

The door hinges are set ex works to enable the appliance door to be opened wide.

If the opening angle of the appliance door needs to be limited to approx. 90°, the hinge can be adjusted to accommodate this (depending on the model, KWTUS 7096, 7196).

The locking pins for limiting the door opening must be fitted before the refrigeration appliance is installed.

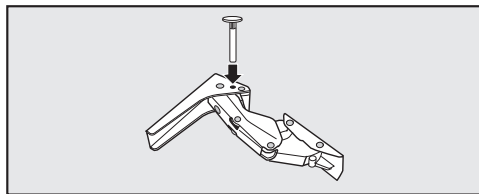

- Insert the locking pins supplied for limiting the door opening into the hinges from above.

The appliance door opening angle is now limited to approx. 90°.

Building-in dimensions

Niche/side view

All dimensions are given in mm.

The wine unit will function correctly if the specified ventilation openings are kept clear.

KWTUS 7074

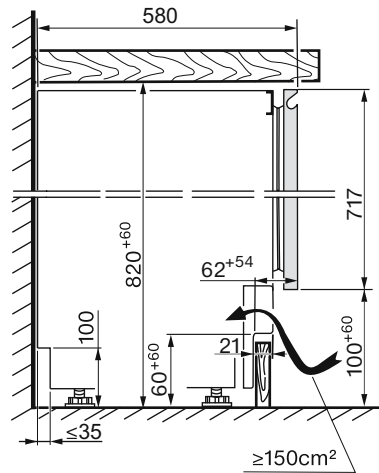
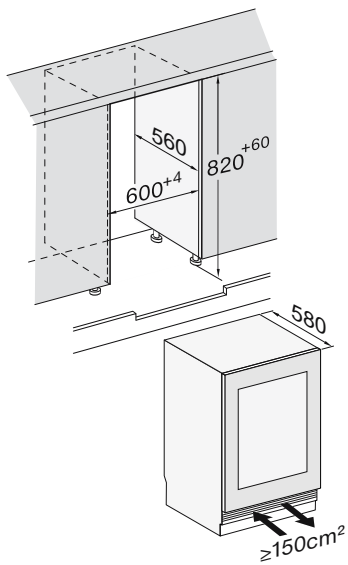

Installation

KWTUS 7096

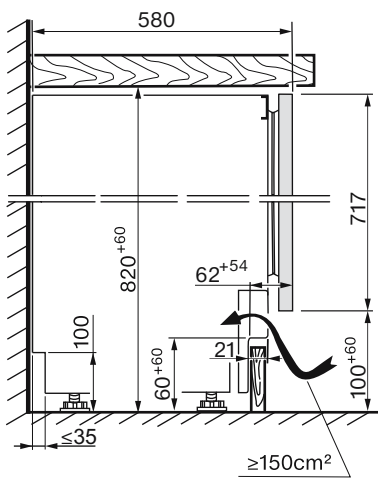
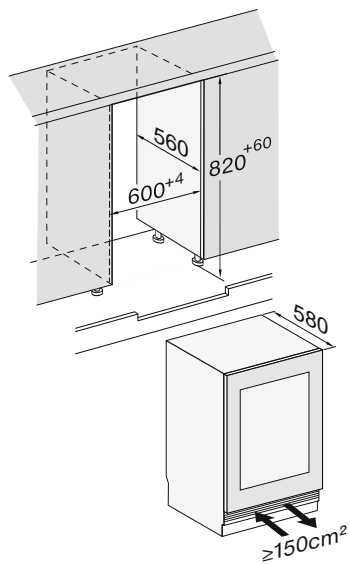

KWTUS 7196

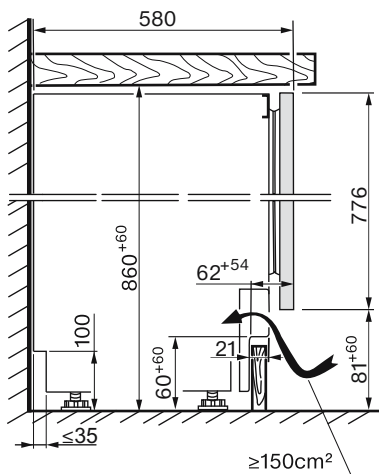
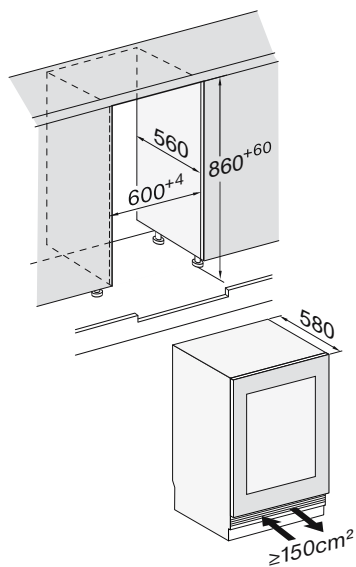

Connections

All dimensions are given in mm.

KWTUS 7074

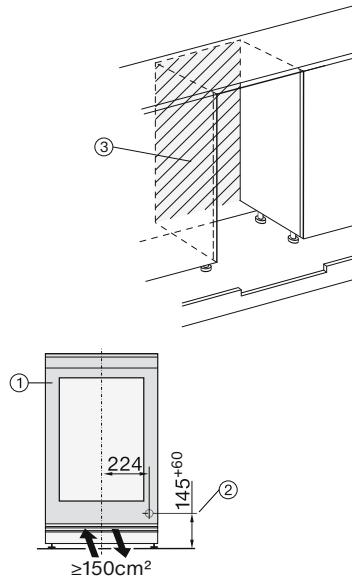
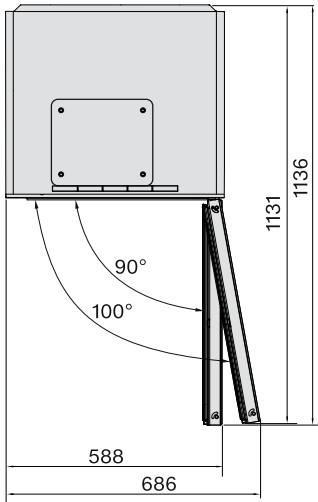

Installation

KWTUS 7096, 7196

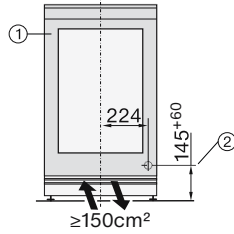
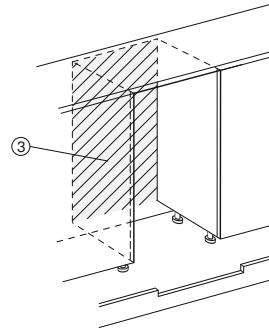
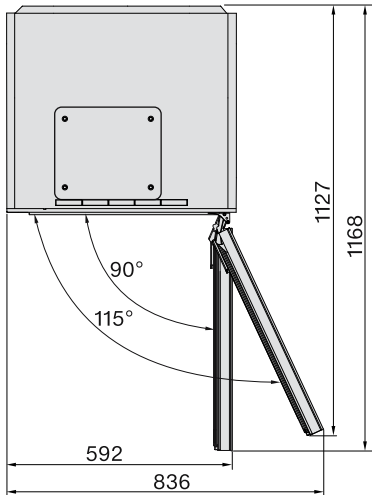

- ① View from the front
- ② Mains connection cable, length = 2200 mm
A longer mains connection cable is available to order from the Miele Customer Service Department.
- ③ No connection sockets in this area

Installing the wine conditioning unit

To install the wine unit, you will need the following tools:

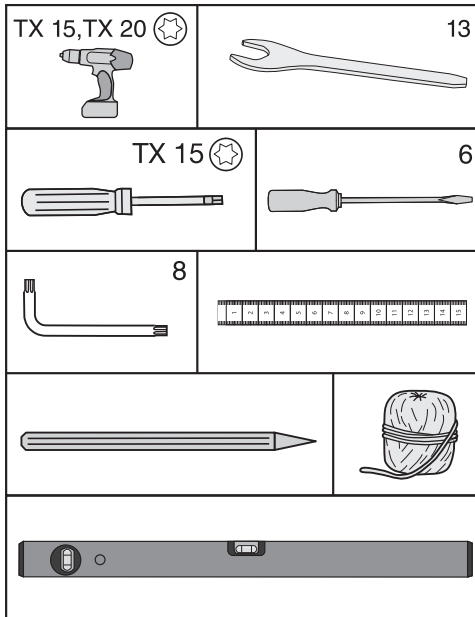

Tip: Store the enclosed metal rod in a safe place. It is required for adjusting the rear appliance feet.

Setting up the wine unit

- Position the wine unit in front of the niche.
- Hold the plinth panel at the side and pull it forwards and off.

You have a choice of two different ways of securing your wine unit:

1. Secured at the top
This method is suitable for securing the appliance underneath a plastic worktop, e.g. laminate. The worktop must be suitable for screwing a fixing bracket on to.

With the feet fully extended the wine unit should sit lightly tensioned between the floor and the worktop.

2. Secured at the side
This method is suitable for securing the appliance underneath a solid worktop, e.g. granite. The furniture side walls to the right and left of the wine unit must be suitable for screwing fixing brackets to. With the feet fully extended the wine unit will sit lower than the worktop.

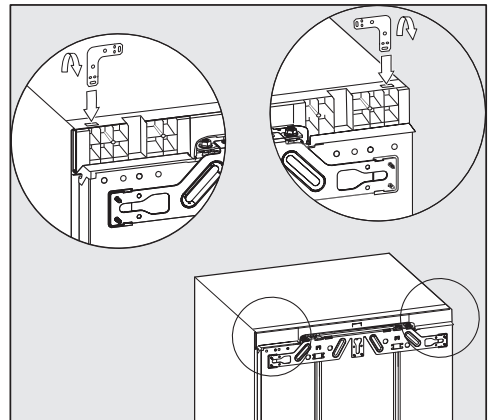

1. Secured at the top
 - Fit the bracket in the opening in the appliance lid.
 - Bend the bracket at the perforated position.

Installation

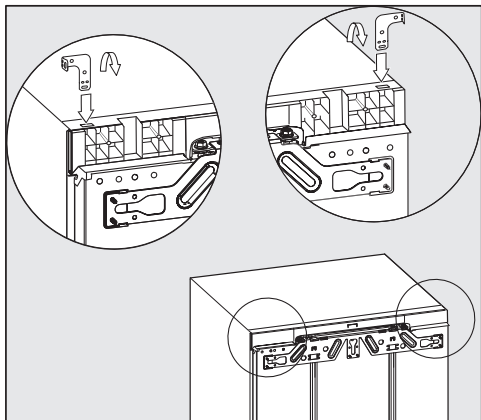

2. Secured at the side

Both ends of the bracket must be bent.

- Fit the bracket in the opening in the appliance lid.
- Bend the bracket at the perforated position.
- Remove the bracket from the opening and insert the straight end of the bracket.
- Now bend this end of the bracket at the perforated position.

Pushing in the wine unit

⚠ Risk of damaging the mains connection cable.

When pushing the wine unit into its niche, the mains connection cable can get trapped and damaged. Push the wine unit carefully into the niche.

⚠ Risk of damaging the floor.

Moving the wine unit can cause damage to the floor.

Move the wine unit carefully on floors that are sensitive to scratching.

⚠ Risk of damaging the appliance feet.

The appliance feet can break off.

The feet should be almost fully screwed in when you push the wine unit into the niche.

Tip: Before pushing the appliance into the niche the two rear feet should be loosened by half a turn. After pushing it into the niche, the feet will be easier to adjust from the front (see “Aligning the wine unit”).

- Position the mains connection cable so that the wine unit can be connected easily once installed.

Tip: To help you push it into position, tie a piece of string around the mains plug to “lengthen” the mains connection cable.

Then pull the mains connection cable by the end of the string through the housing unit.

If the wine unit is pushed too far into the niche, the appliance door may not close properly once the furniture panel has been fitted. This can cause ice to build up, condensate to accumulate and lead to faults in the appliance. These can all lead to increased energy consumption.

Push the wine unit into the building-in niche, making sure a gap of **42 mm** is maintained all round between the appliance carcass and the front of the housing unit side walls.

- Push the refrigeration appliance into the niche until the front edges of the hinges at the top and bottom are flush with the front edge of the housing unit side wall.

This will create a gap all round of **42 mm** to the front edges of the housing unit side walls.

On furniture with door fittings (e.g. stubs, seals, etc.), the dimension of these must be taken into account to ensure there is a gap all round of **42 mm**.

- Pull the wine unit forwards by the appropriate dimension.
- Check again to make sure there is a gap of **42 mm** to the front edges of the door fittings.

Tip: If possible, remove the door fittings and push the wine unit into the niche until all fixing brackets at the top and bottom are touching the front edge of the housing unit side wall.

Aligning the wine unit

When securing the wine unit in the niche at the top, it should sit lightly tensioned between the floor and the worktop.

- Adjust the front and rear feet alternately according to the niche height and make sure the wine unit is correctly aligned.

Proceed as follows:

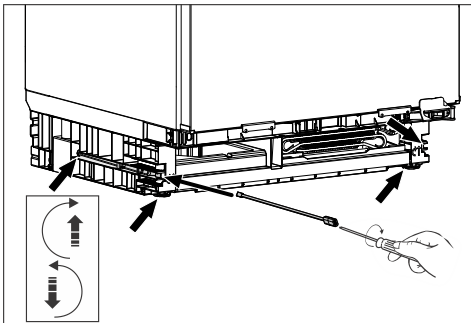

- Adjust both rear feet with appropriate screws at the front right and left in the appliance plinth using the rod supplied and a flat-head screwdriver.
- Unscrew the two front levelling feet alternately with the rear ones. The maximum adjustment range is 6 cm.

Tip: As soon as the feet have been unscrewed slightly, you can adjust them with a screwdriver at the bottom of the foot.

The foam ① attached to the ventilation grille ensures the airflow is separated to prevent malfunctioning of the appliance.

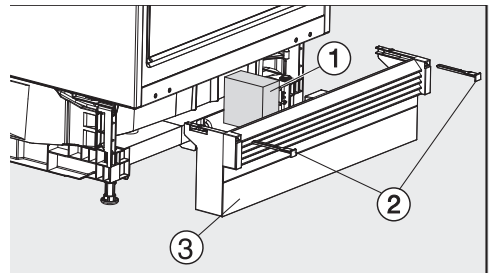

- Replace the plinth panel with the ventilation grille ③, but do not fix it in place yet.

Without a continuous plinth facing:

- Pull the plinth panel ③ forwards until the ventilation slots are in alignment with adjacent cabinet plinth panels.

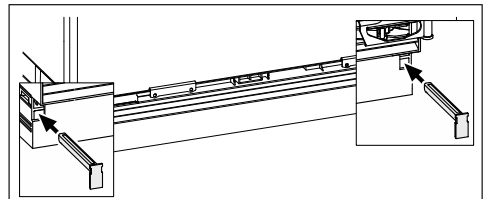

- Hold the plinth panel securely and attach it to the right and left using the bolts supplied ②.

Installation

With the plinth panel attached, the rear feet can only be adjusted when the plinth panel is fully inserted. Otherwise, the bar is not long enough.

With a continuous plinth facing:

- Push the plinth panel with the ventilation grille ③ right up against the wine unit, and attach it to the right and left using bolts ②.

If a continuous plinth facing is to be fitted, a suitable ventilation gap will need to be made in it for the ventilation grille of the wine unit.

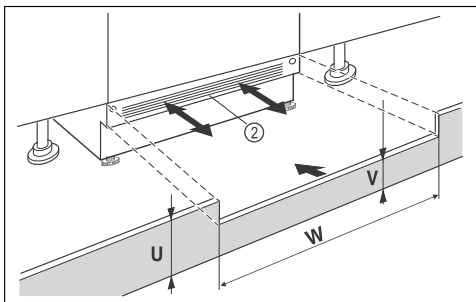

- Trim the furniture plinth facing (U) to the correct height.
- Adjust the height (V) along the niche width (W) underneath the appliance plinth facing ②.

Aligning the wine unit to taller furniture doors

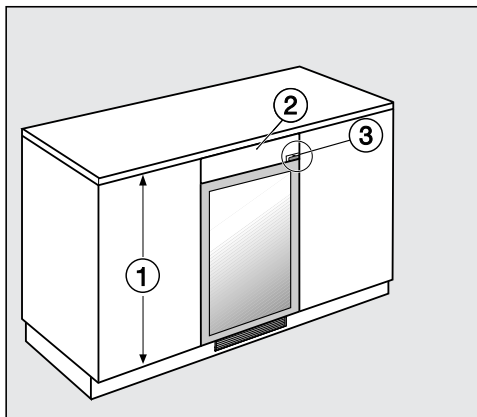

If adjacent furniture doors ① are taller than the wine unit door, the wine unit can be aligned to the adjacent furniture doors using a filler panel ②.

The filler panel must be made exactly to measure. Please also take into account the door hinge ③ when having the filler panel made (depending on the model).

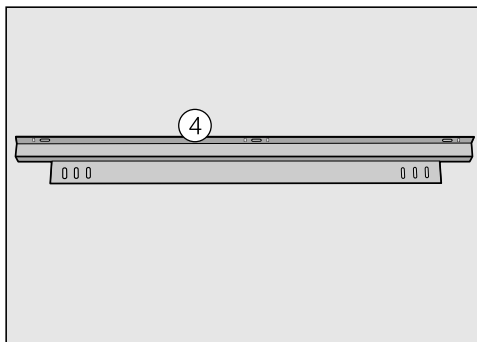

A fixing bracket ④ is required to secure the filler panel. This is available from Miele Customer Service or from specialist dealers. The fixing bracket is fitted on the wine unit:

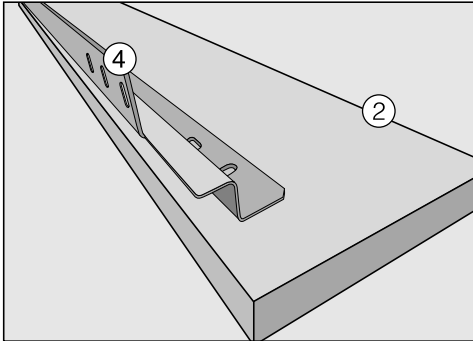
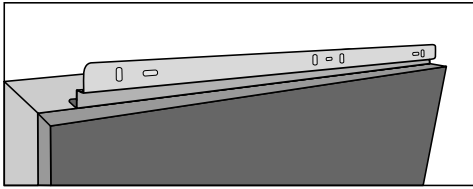

- Fix the fixing bracket ④ to the back of filler panel ②.
- Pull the wine unit as far as you need to out of the niche so that you can tilt it towards you.
- Loosely hand-screw the fixing bracket ④ with the filler panel ② to the wine unit.
- Align the filler panel to the wine unit door to give a flush finish.
- Now tighten the screws.
- You can now push the wine unit into the niche.

Securing the wine unit in the niche

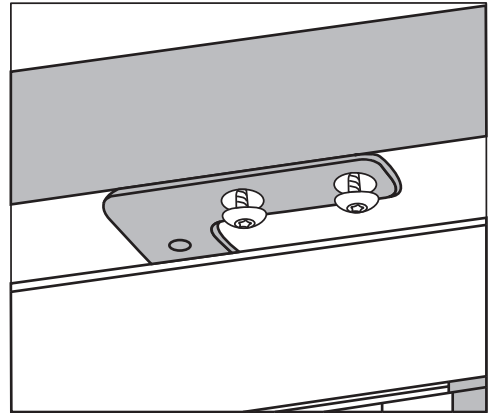

1. Secured at the top

- Screw the wine unit in place underneath the worktop with two screws in each case.

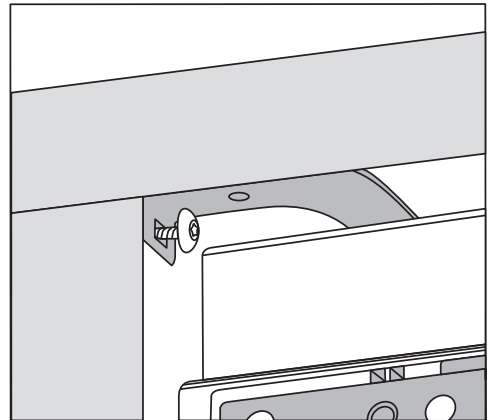

2. Secured at the side

- Screw the wine unit into the niche on the right and left with one screw in each case.

Installation

Electrical connection

The refrigeration appliance must only be connected to an earthed socket using the mains connection cable supplied.

The socket must be easily accessible after the refrigeration appliance has been installed. If the socket is not easily accessible, ensure that a suitable means of disconnection is provided on the installation side for each pole.

 Risk of fire from overheating.

Connecting the refrigeration appliance to a multi-socket plug adapter or to an extension lead can overload the cable.

For safety reasons, do not use an extension lead or multi-socket adapter.

The electrical installation must comply with VDE 0100 requirements.

For safety reasons, we recommend using a type  residual current device (RCD) in the assigned electrical installation for connecting the refrigeration appliance.

If the mains connection cable is damaged, it must only be replaced with a specific mains connection cable of the same type (available from the Miele Customer Service Department). For safety reasons, such replacement may only be carried out by a qualified specialist or the Miele Customer Service Department.

These operating instructions and the data plate indicate the nominal power consumption and the appropriate fuse rating. Compare this information with the data of the on-site electrical connection. If in any doubt, consult a qualified electrician.

Temporary or permanent operation on an autonomous power supply system or a power supply system that is not synchronised with the mains power supply (e.g. island networks, back-up systems) is possible. A prerequisite for operation is that the power supply system complies with the specifications of EN 50160 or an equivalent standard. The function and operation of the protective measures provided in the domestic electrical installation and in this Miele product must also be maintained in isolated operation or in operation that is not synchronised with the mains power supply, or these measures must be replaced by equivalent measures in the installation. As described, for example, in the current version of VDE-AR-E 2510-2.

Connecting the refrigeration appliance

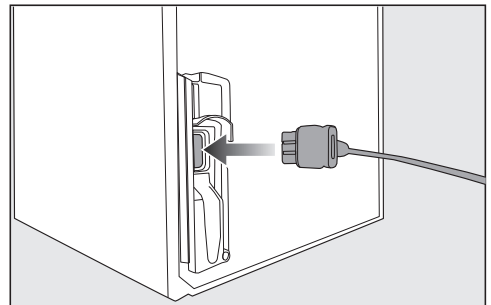

- Insert the plug connector into the socket at the back of the refrigeration appliance.

Make sure that the plug connector has clicked into position correctly.

- Insert the plug of the refrigeration appliance into the socket.

The refrigeration appliance is now connected to the electricity supply.

EU Conformity declaration

Miele hereby declares that this wine unit complies with Directive 2014/53/EU.

The complete text of the EU declaration of conformity is available from one of the following internet addresses:

- Products, Download from www.miele.ie
- For service, information, operating instructions etc: go to <https://miele.co.uk/manuals> and enter the name of the product or the serial number

Frequency band of the WiFi module	2.4000 GHz – 2.4835 GHz
-----------------------------------	-------------------------

Maximum transmitting power of the WiFi module	< 100 mW
---	----------

UK Conformity declaration

Miele hereby declares that this wine unit complies with UK Radio Equipment Regulations 2017, as amended.

The complete text of the UK declaration of conformity is available from one of the following internet addresses:

- Products, Download from www.miele.co.uk
- For service, information, operating instructions etc: go to <https://miele.co.uk/manuals> and enter the name of the product or the serial number

Frequency band of the WiFi module	2.4000 GHz – 2.4835 GHz
-----------------------------------	-------------------------

Maximum transmitting power of the WiFi module	< 100 mW
---	----------

This **Statement of Compliance** confirms this Miele product fully complies with the **Product Security and Telecommunications Infrastructure (Security Requirements for Relevant Connectable Products) Regulations 2023**.

- 1) Household Appliance – *Freezer - 120002, 120003, 320001, 320002*
Refrigerator - 110001, 110002, 310001, 310002, 310003
Fridge-freezer - 130001, 130002, 130003, 130004, 330001, 330002
Wine unit - 210007, 310004, 330004
- 2) Manufactured by: Miele & Cie KG,
Carl Miele Street 29, 33332 Gutersloh Germany
Imported by and contact point: Miele Company Ltd, Fairacres, Marcham Road, Abingdon, Oxon, OX14 ITW Great Britain
- 3) The defined support period at the time of first supply is 10 years
- 4) To report vulnerabilities and cybersecurity issues please contact: psirt@miele.com

5) Signature 

Name: **Paul Wright**

Company Position: **Head of Technical Management**

Date of signature: **19th March 2024**

Place of signature: **Abingdon, Oxfordshire**

Copyrights and licences

For the purpose of operating and controlling the communication module, Miele uses proprietary or third-party software that is not covered by open source licensing terms. This software/these software components are protected by copyright. The copyrights held by Miele and third parties must be respected.

Furthermore, the communication module integrated in the appliance contains software components which are distributed under open source licence conditions. The open source components contained in the appliance along with the corresponding copyright notices, copies of the licensing terms valid at the time and any further information can be accessed locally by IP via a web browser ([http\[s\]://<IP address>/Licenses](http[s]://<IP address>/Licenses)). The liability and warranty arrangements for the open source licences displayed in this location only apply in relation to the respective rights holders.

United Kingdom

Miele Co. Ltd., Fairacres, Marcham Road, Abingdon, Oxon, OX14 1TW
Tel: 0330 160 6600, Internet: www.miele.co.uk, E-mail: info@miele.co.uk

Australia

Miele Australia Pty. Ltd.
ACN 005 635 398
ABN 96 005 635 398
Level 4, 141 Camberwell Road
Hawthorn East, VIC 3123
Tel: 1300 464 353
E-mail: info@miele.com.au
Internet: www.miele.com.au

China Mainland

Miele Electrical Appliances Co. Ltd.
No. 82, Shimenyi Road, JingAn District
Shanghai, China, P.R.C
Post Code: 200040
Phone: +86 21 6157 3500
Fax: +86 21 6157 3511
E-mail: info@miele.cn
Internet: www.miele.cn

Hong Kong, China

Miele (Hong Kong) Ltd.
41/F - 4101, Manhattan Place
23 Wang Tai Road
Kowloon Bay, Hong Kong
Tel: (852) 2610 1025
Fax: (852) 3579 1404
E-mail:
customerservices@miele.com.hk
Website: www.miele.hk

India

Miele India Pvt. Ltd.
1st Floor, Copia Corporate Suites,
Commercial Plot 9, Mathura Road,
Jasola, New Delhi - 110025
E-mail: customercare@miele.in
Website: www.miele.in

Ireland

Miele Ireland Ltd.
2024 Bianconi Avenue
Citywest Business Campus
Dublin 24
Tel: (01) 461 07 10
Fax: (01) 461 07 97
E-mail: info@miele.ie
Internet: www.miele.ie

Malaysia

Miele Sdn Bhd
Suite 12-2, Level 12
Menara Sapura Kencana
Petroleum
Solaris Dutamas No. 1
Jalan Dutamas 1
50480 Kuala Lumpur, Malaysia
Phone: +603-6209-0288
Fax: +603-6205-3768

New Zealand

Miele New Zealand Limited
IRD 98 463 631
8 College Hill
Freemans Bay, Auckland 1011
Tel: 0800 464 353
E-mail: customercare@miele.co.nz
Internet: www.miele.co.nz

Singapore

Miele Pte. Ltd.
29 Media Circle
#11-04 ALICE@Mediapolis
Singapore 138565
Tel: +65 6735 1191
Fax: +65 6735 1161
E-mail: info@miele.com.sg
Internet: www.miele.sg

South Africa

Miele (Pty) Ltd.
63 Peter Place, Bryanston 2194
P.O. Box 69434, Bryanston 2021
Tel: (011) 875 9000
Fax: (011) 875 9035
E-mail: info@miele.co.za
Internet: www.miele.co.za

Thailand

Miele Appliances Ltd.
BHIRAJ TOWER at EmQuartier
43rd Floor Unit 4301-4303
689 Sukhumvit Road
North Klongton Sub-District
Vadhana District
Bangkok 10110, Thailand

United Arab Emirates

Miele Appliances Ltd.
Showroom 1, Eiffel 1 Building
Sheikh Zayed Road, Umm Al Sheif
P.O. Box 114782 - Dubai
Tel. +971 4 3044 999
Fax. +971 4 3418 852
800-MIELE (64353)
E-mail: info@miele.ae
Website: www.miele.ae

Manufacturer: Miele & Cie. KG, Carl-Miele-Straße 29, 33332 Gütersloh, Germany

KWTU 7096 ..., KWTU 7196 ...