

Operating instructions

Coin control unit



C 4070

Always read the operating instructions before setting up, installing and commissioning the machine. This prevents both personal injury and damage to the machine.

en-GB

M.-Nr. 10 690 200

Warning and Safety instructions	4
Caring for the environment	5
Description of the appliance	6
General information about the C 4070 Coin control unit	6
Programming	8
Access to programming level	8
Exit from programming level	8
List of input positions	9
Display example	12
Display total day count of all coins (without entering into programming level)	12
Display total day count of all coins (after entering into programming level)	13
Programming example	14
To change the main time (in timed operation) from the standard option of 60 minutes to 30 minutes	15
Displays	17
Total day count of all coins	17
Displays in programme operation	18
Display before and after programme access has been granted	18
Programming in timed operation	19
Programming the main time Input position P03	19
Programming coin time for the lowest value coin Input position P08	19
Special functions	20
Programming the brightness of the display Input position P23	20
Programming coin recognition Input positions P11 to P16	20
Allocating a value to the coin Input positions P17 to P22	21
To switch from Block 1 to Block 2	22
Cleaning and maintenance	23
After sales service	24
Abbreviated operating instructions	25

Warning and Safety instructions

Read the operating and programming instructions before using the coin control unit for the first time.

They contain important information about the safety, use and maintenance of the unit. This way you will avoid the risk of accidents and damage to the unit. Keep these operating and programming instructions in a safe place and ensure that new users are familiar with the content. Pass them on to any future owner of the unit.

- Before connecting the unit to the mains supply make sure that the connection data on the data plate (fusing, volt-age and frequency) matches the mains electricity supply.
- The electrical safety of this unit can only be guaranteed when continuity is complete between the unit and an effective earthing system which complies with local and national safety regulations. In case of doubt consult a suitably qualified person. The manufacturer cannot be held liable for the consequences of an inadequate earthing system (e.g. electric shock).
- Do not use this unit if there is any sign of external damage, e.g. to the cable insulation, until it has been repaired.
- If the connection cable is damaged in any way it must be replaced by a suitably qualified technician to ensure safety. Do not use the unit if there is any sign of damage, until it has been repaired.
- Under no circumstances should the housing of the unit be opened. Tampering with electrical connections or components and mechanical parts is highly dangerous to the user and can cause mechanical faults.
- Repairs to electrical appliances should only be carried out by a suitably qualified and competent person in accordance with local and national safety regulations. Unauthorised repairs could result in unforeseen dangers for the user, for which the manufacturer cannot accept liability.

- The unit is only completely isolated from the electricity supply either when it is switched off at the isolator switch or the mains fuse has been withdrawn.
- Do not install the unit in rooms where temperatures below freezing may occur. Temperatures below freezing may impair the functioning of the unit.
- Do not use a high pressure cleaner or hose to clean the unit.
- Faulty components must only be exchanged for Miele original spare parts. Only when these parts are fitted can the safety standards of the unit be guaranteed.

Using accessories

- Accessory parts may only be fitted when expressly approved by Miele. If other parts are used, guarantee, performance and product liability claims may be invalidated.
- Empty the coin box daily. If coins are not emptied regularly they will build-up and prevent the control unit from functioning properly.

Disposal of the packing material

The transport and protective packing has been selected from materials which are environmentally friendly for disposal and can normally be recycled. Packaging e.g. cling film, polystyrene and plastic wrappings must be kept out of the reach of babies and young children. Danger of suffocation.

Rather than just throwing these materials away, please ensure that they are recycled.

Disposal of your old machine

Electrical and electronic machines often contain materials which, if handled or disposed of incorrectly, could be potentially hazardous to human health and to the environment. They are, however, essential for the correct functioning of your machine. Please do not therefore dispose of it with your household waste.

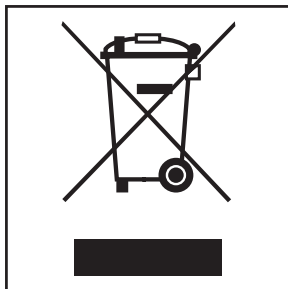

Please dispose of it at your local community waste collection/recycling centre, and ensure that it presents no danger to children while being stored for disposal.

It should be unplugged or disconnected from the mains electricity supply by a competent person. The plug must be rendered useless, and the cable cut off directly behind it to prevent misuse.

Energy saving tips

Energy and water consumption

- Water consumption and energy usage are determined by the size of the load.
To make the most out of your machine load the maximum dry load for the programme you are using.

Detergent

- Do not exceed the amounts of detergent recommended by the manufacturer on the packaging.
- Reduce the amount of detergent for smaller loads.
When drying with a tumble dryer
Selecting the highest possible spin speed for the wash programme will save energy when drying in a tumble dryer afterwards.

Description of the appliance

General information about the C 4070 Coin control unit

The C 4070 is fitted with an electronic coin tester which can be programmed to recognise up to 12 different coins.

The tester is divided into two blocks. Block 1 (Channels 1-6) is for coins and Block 2 (Channels 7-12) is for tokens (see page 20 for details on how to change over).

The C 4070 can be used as a timer or programme control unit for Miele laundry machines.

For programme operation (standard setting):

As a control unit for machines which are fitted with a programme timer or an electronic control unit where a complete programme sequence is required (e.g. a wash programme).

For timed operation*:

As a control unit allowing laundry machines to be used for specific lengths of time only (e.g. a period of ironing).

* Reprogramming necessary on the coin control unit.

Coin control unit C 4070

- ① Display
- ② Programming buttons
- ③ Coin feed
- ④ Coin return button
- ⑤ Coin return
- ⑥ Connection cable
- ⑦ Coin box
- ⑧ Front panel
- ⑨ Lock
- ⑩ Front

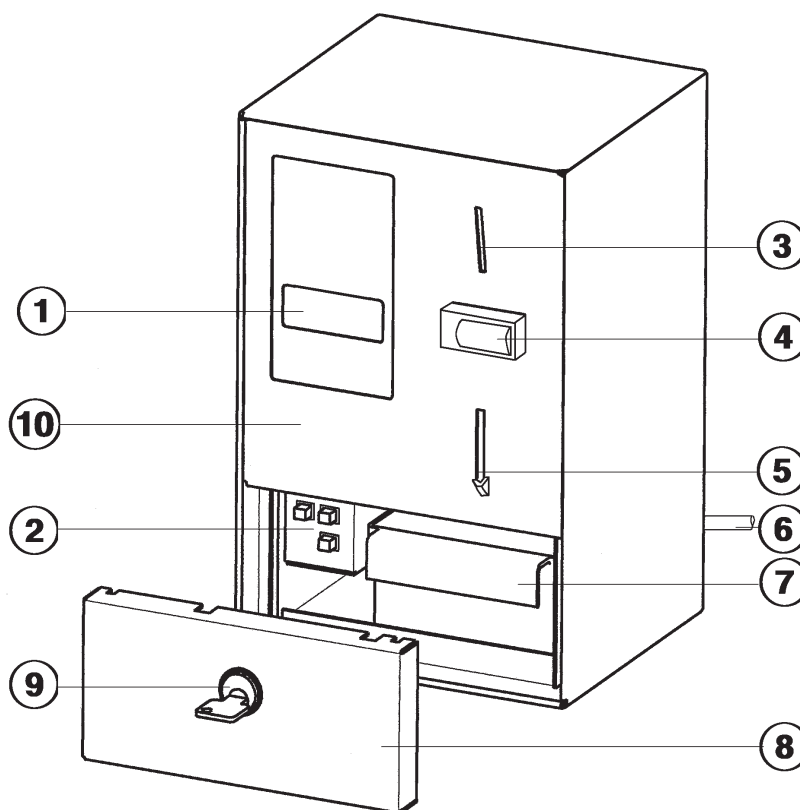

Display

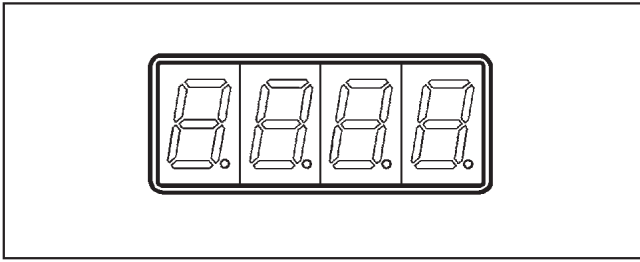

The display can show the following:

- the amount of money to be inserted,
- the operating status of the connected unit (programme operation, time operation),
- any input positions and options,
- counter status and
- test and service information.

Programming buttons

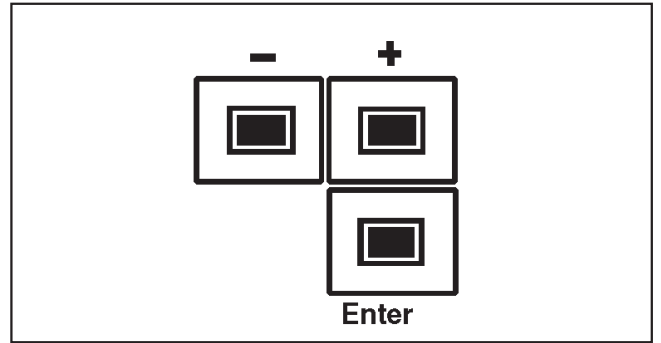

The programming buttons are used for selecting various input positions and setting different options.

The " + " and " - " buttons

These buttons are used to select the individual input positions and to change the option values.

Each time the button is pressed the display changes by one digit.

If the button is kept pressed in the display will change continuously.

Further functions:

" + " button

Access to read the counter contents from outside programming level.

" - " button

To delete the counter contents and reset the settings.

"Enter" button

This button has several functions.

- Access to programming level.
- Jumping from input position to option.
- Saving the option and returning to the input position.
- Selecting the counter status outside programming level.

Programming

Access to programming level

Before you begin, first ensure that:

- the unit is switched on and
- washer extractor or tumble dryer doors are shut.

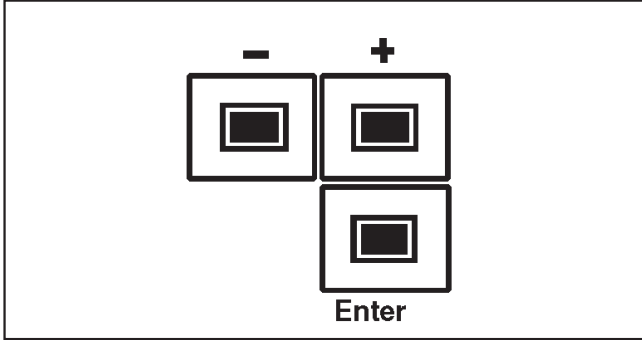

- Press and release the "Enter" button 4 times within 5 seconds.

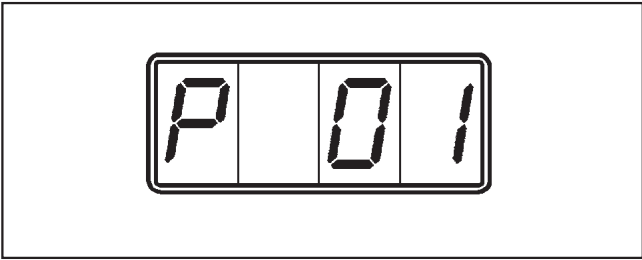

The letter "P" (code for programming level) will appear on the left hand side of the display. The "01" on the right of the display shows the first input position.

Selecting an "Input position"

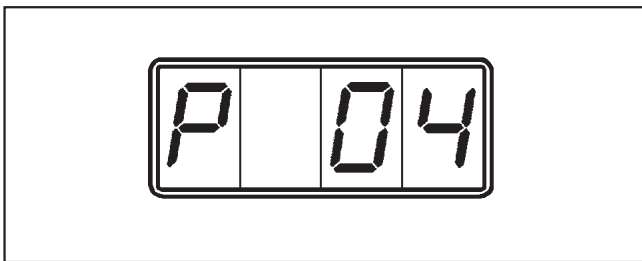

- Press the "+" or "-" button until the required input position (00, 01, 02 ...25) shows in the display (e.g. "04").
- Press the "Enter" button.

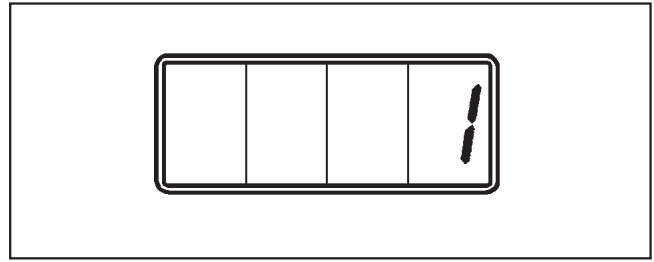

The option for the input position then appears to the right of the display (e.g. "1").

Selecting an "Option"

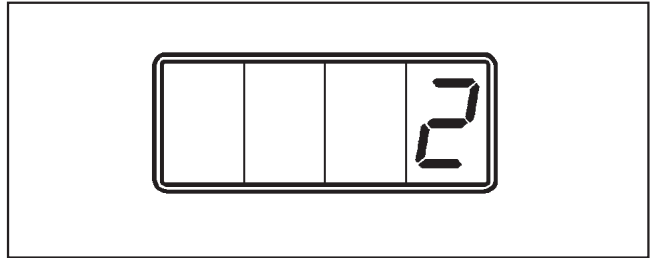

- Press the "+" or "-" button until the required option (1,2,3,4 ...9999) shows in the display (e.g. "2" for timed operation).

Saving the "Option"

- Press the "Enter" button.

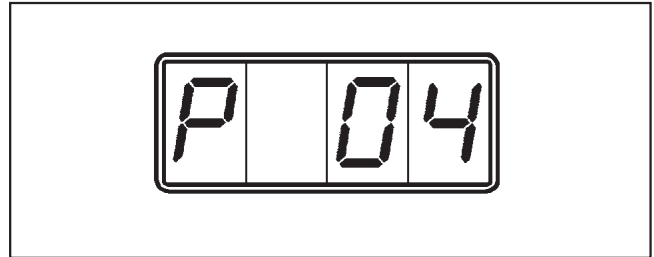

"P 04" will appear in the display.

Option "2" has been saved in input position "4".

Exit from programming level

There are three possible ways of exiting:

- Switch the unit off.
- Exit will occur automatically if you do not press any programming buttons for 50 seconds.
- By selecting and confirming Input position "00".













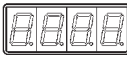

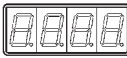

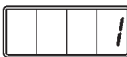

List of input positions

Options can be programmed in and the counter status queried in the input positions.

Any changes made to standard options must be entered in the "Standard" column.

 = Input can be carried out by the operator or a service technician.

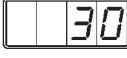
 = Input can only be carried out by a service technician.

Input position	Display (Standard)	Note	Explanation of individual functions	Options			Further explanations
				Standard			
P 00			Exit from programming level				Page 7
P 01			Display total day count of all coins (amount) -deletable with " - " button				Pages 11, 12, 16, 17
P 02			Display total sum of all coins (amount) -cannot be deleted				
P 03			For programme operation changes depend on programming of the decimal places.	2.00 GBP			Pages 17, 18
			For timed operation: Main time in minutes (Only if input position 4 is set to time operation) -can be changed depending on the programmed coin time. Up to 1440 times the programmed coin time and in coin time value steps.				
P 04			1 Programme operation 2 Timed operation	1	2		
P 05			Number of decimal places to be shown - Only when showing amounts of money. - 1 two decimal places (e.g. 4.50) 2 no decimal places (e.g. 4) **	1	2		
P 06			For programme operation: Notification 1 Programme end with 230 V Signal OFF (AUS) ** (also with power cut) 2 Programme end with 230 V Signal ON (EIN) ** 3 Programme end only with power cut **	1	2	3	
P 07			For Programme operation: Storage time - Can be changed in one second increments from 2 to 180 seconds.	180 Sec.	2 - 180 seconds		
P 08			For timed operation: Coin time for the smallest value coin (which is programmed) - Can be changed in one minute increments from 1 to 120 minutes.	30 min.	1 - 120 minutes		Page 18

** this function is not the same as it was for the C 4030. When upgrading a C 4030 to a C 4070 please bear this in mind! See Adapter leaflet, M.-Nr. 4423920.

- Continued next page -











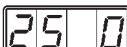





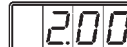

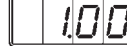
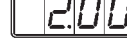









Programming

Input position	Display (Standard)	Note	Explanation of individual functions	Options					Further explanations
				Standard					
P 09			For timed operation: Later payment mode 1 Coin requirement (always full main time) 2 Minimum coins inserted (first money for main time, then ≥ 1 minute extra purchase option according to amount of money added later 3 Short time purchase according to amount of money inserted as a proportion of time at ≥ 1 minute can be purchased)	1	2	3			
P 10			For timed operation: Time access / Time stop 1 Time access direct with coin insertion 2 Time access with 230 V Signal OFF (AUS) Time stop with 230 V Signal ON (EIN) 3 Time access with 230 V Signal ON (EIN) Time stop with 230 V Signal OFF (AUS) 4 Time access with 230 V Signal OFF (AUS) with storage function via the switch on the main relay 5 Time access with 230 V Signal ON (EIN) with storage function via switch on time on the main relay	1	2	3	4	5	
P 11	Block 1 Channel 1 Option 1 Block 2		Coin recognition for channel 1 / 7 ** 1.00 GBP (new) / Token 2 0 barred 1 free	1 / 0	0	1			
P 12	Block 1 Block 2 		Coin recognition for channel 2 / 8 ** 1.00 GBP (old) / Token 5 0 barred 1 free	1 / 0	0	1			
P 13	Block 1 Block 2 		Coin recognition for channel 3 / 9 ** 2.00 GBP / Token 7 0 barred 1 free	1 / 0	0	1			
P 14	Block 1 Block 2 		Coin recognition for channel 4 / 10 ** 0.50 GBP / Token 8 0 barred 1 free	1 / 0	0	1			

** this function is not the same as it was for the C 4030 or C 4031. When upgrading to a C 4070 please bear this in mind!

- Continued next page -

Programming

Input position	Display (Standard)	Note	Explanation of individual functions	Options				Further explanations
				Standard				
P 15	Block 1  Block 2 		Coin recognition for channel 5 / 11 ** 0.20 GBP / Token 9 0 barred 1 free	1 / 0	0	1		
P 16	Block 1  Block 2 		Coin recognition for channel 6 / 12 ** 0.10 GBP / free 0 barred 1 free	0 / 0	0	1		
P 17	1  2 		Value allocation** for channel 1 / 7 1.00 GBP (new) / Token 2	Block 1 1.00 GBP Block 2 2.00 GBP				
P 18	1  2 		Value allocation** for channel 2 / 8 1.00 GBP (old) / Token 5	Block 1 1.00 GBP Block 2 2.00 GBP				Page 19
P 19	1  2 		Value allocation** for channel 3 / 9 2.00 GBP / Token 7	Block 1 2.00 GBP Block 2 2.00 GBP				
P 20	1  2 		Value allocation** for channel 4 / 10 0.50 GBP / Token 8	Block 1 0.50 GBP Block 2 2.00 GBP				
P 21	1  2 		Value allocation** for channel 5 / 11 0.20 GBP / Token 9	Block 1 0.20 GBP Block 2 2.00 GBP				
P 22	1  2 		Value allocation** for channel 6 / 12 0.10 GBP / free	Block 1 0.10 GBP Block 2 2.00 GBP				
P 23			Display brightness level Can be changed from 1 to 7	3	1 - 7			Page 19
P 24			Reset to standard settings	S	i			
P 25			Block switching (via Dil-Switch 8) 1 Block 1 (channel 1 - 6 for GBP) 2 Block 2 (channel 7 - 12 for tokens)	1	2			Page 20

** this function is not the same as it was for the C 4030 or C 4031. When upgrading to a C 4070 please bear this in mind!

Display example

Display total day count of all coins (without entering into programming level)

General

The contents of the total day count for coins (amount) and the total count for coins can be called up without going into programming level. It is also possible to delete the total day count without going into programming level.

Before you begin, first ensure that:

- The unit is switched on and washer extractor or tumble dryer doors are shut.

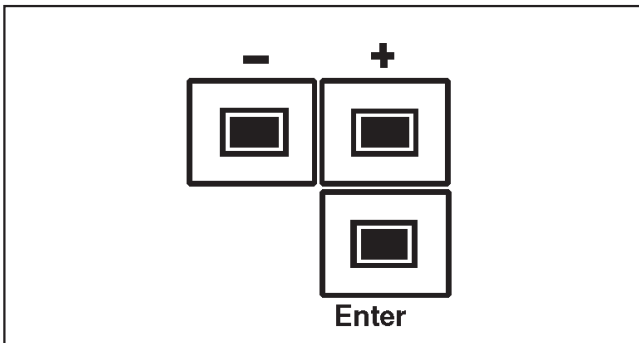

- Press the " + " button in for approx. 5 seconds and then release it.

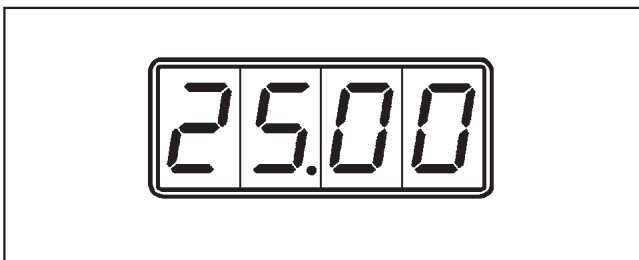

Contents of total day count for coins (amount) - (can be deleted) The total amount for the day, e.g. *25.00* GBP is shown in the display.

Contents of the total sum count (cannot be deleted)

- Press and release the " **Enter** " button.

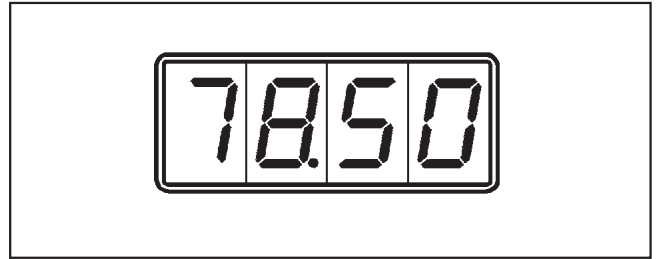

The total amount, e.g. *78.00* GBP is shown in the display.

To delete the total day count

This can only be deleted if it has been selected and is visible in the display. It does not matter which digits are showing in the display.

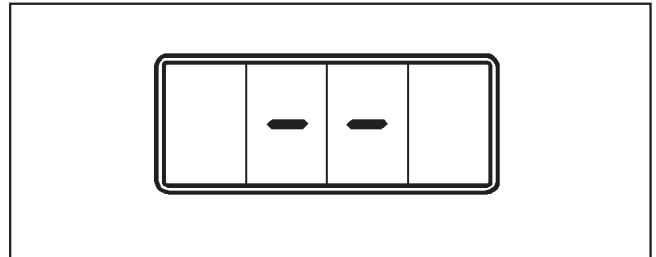

- Press the " - " button in until two horizontal bars appear in the display.
- Then release the " - " button.

The counter contents have now been deleted and "*0.00*" shows in the display.

Exit from the display

There are three possible ways of exiting:

- Isolate the coin control unit from the mains supply (e.g. by switching off at the on-site mains switch).
- Exit will occur automatically if you do not press the "Enter" button for 50 seconds.
- After the total count display (i.e. the final display in the sequence) Press the "Enter" button.

Display total day count of all coins (after entering into programming level)

Before you begin, first ensure that:

- The unit is switched on and washer extractor or tumble dryer doors are shut.

The coin control unit will display the standard amount to pay, e.g. *2.00* GBP. 5 wash programmes at 2.00 GBP have been purchased.

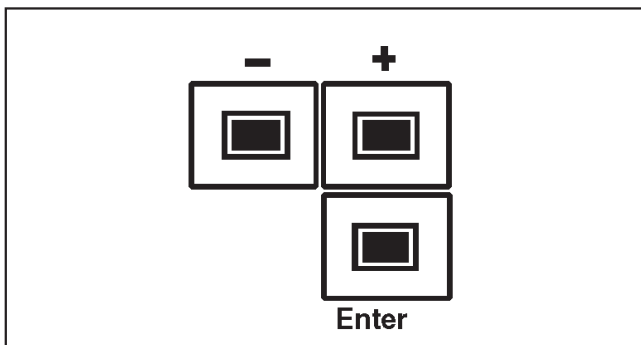

- Press and release the " **Enter** " button **4 times within 5 seconds** .

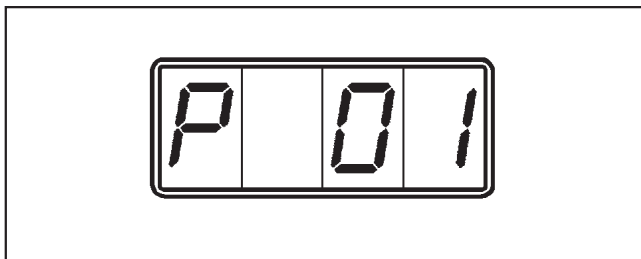

The letter " **P** " (code for programming level) will appear on the left hand side of the display, and the first input position will show on the right hand side of the display.

- Press the " **Enter** " button again **once**.

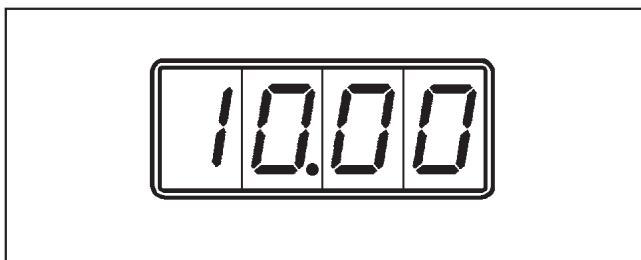

The total amount, e.g. *10.00* GBP is shown in the display.

Larger amounts (over 99.00 or 99.80 GBP depending on coin acceptor being used) are shown scrolling across the screen. Amounts with 4 digits or less do not rotate in the display.

To delete the total day count:

- Press the " - " button in for approx. 5 seconds.

Exit from programming level

There are three possible ways of exiting:

- Switch the unit off.
- Exit will occur automatically if you do not press any programming buttons for 50 seconds.
- By selecting Input position "00" and pressing the " **Enter** " button.

Programming example

To change the cost from the standard option of 2.00 GBP to 2.50 GBP

Before you begin, first ensure that:

- The machine is switched on and washer extractor or tumble dryer doors are shut.

The coin control unit will display the programmed amount of 2.00 GBP.

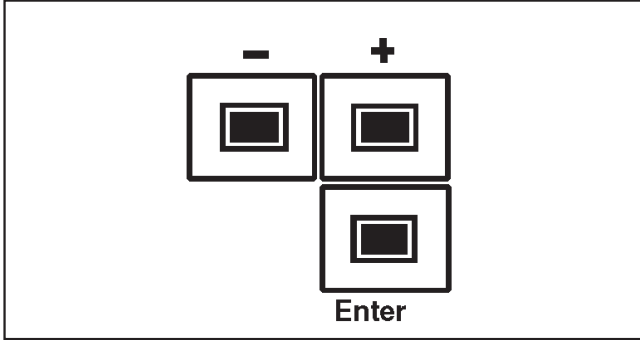

- Press and release the "Enter" button 4 times within 5 seconds .

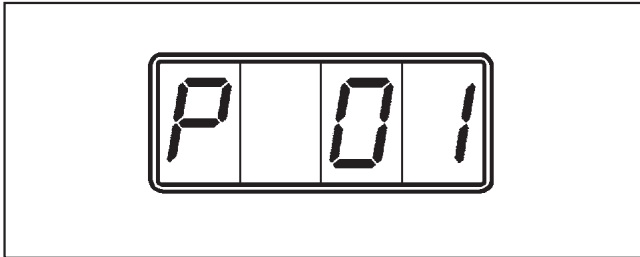

The letter "P" (code for programming level) will appear on the left hand side of the display. The "01" on the right of the display shows the first input position.

- Press the "+" button until input position "03" shows in the display.
- Press the "Enter" button.



The display will show the standard programmed amount of 2.00 GBP.

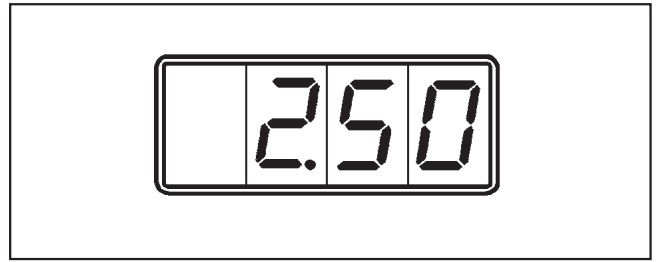

- Press the "+" button until the amount "2.50 GBP" shows in the display.

The amount will change in increments to the value of the smallest coin (0.10 GBP). -

- Press the "Enter" button.

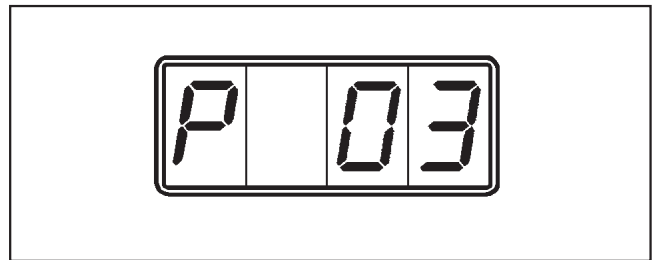

"P 03" will appear in the display.

The display will change from "P 03" to 2.50 GBP after approx. 50 seconds.

The new price of 2.50 GBP is now stored in memory.

To change the main time (in timed operation) from the standard option of 60 minutes to 30 minutes

Before you begin, first ensure that:

- The unit is switched on and washer extractor or tumble dryer doors are shut.
- Timed operation must previously have been programmed via input position "4". The standard programmed main time is 60 minutes. The coin time for the smallest value coin (0.10 GBP) is 30 minutes.



The display will show the an amount of 0.20 GBP.

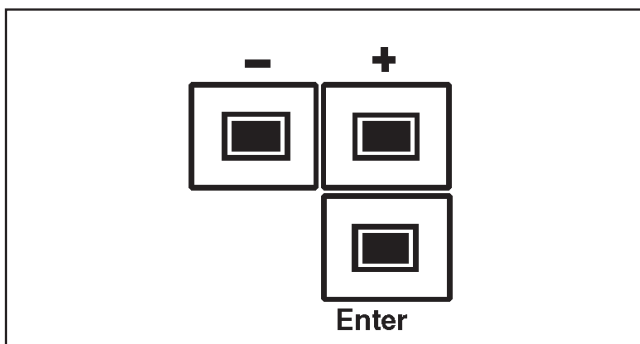

- Press and release the " **Enter** " button **4 times within 5 seconds** .

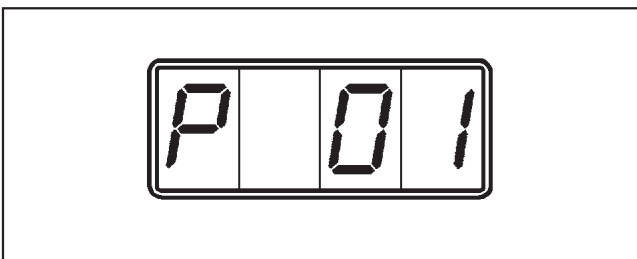

The letter " *P* " will appear on the left hand side of the display. The " *01* " on the right of the display shows the first input position.

- Press the " **+** " button until input position " *03* " shows in the display.
- Press the " **Enter** " button.



The display will show the standard programmed main time of 60 minutes.

- Press the " **-** " button **once**.

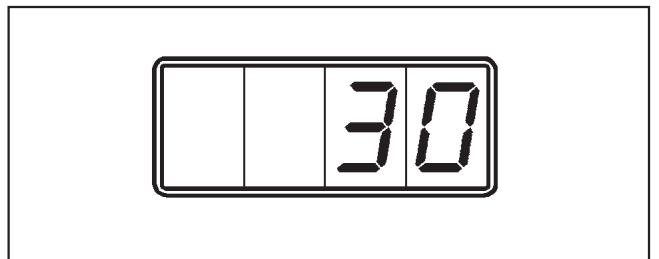

The display will now show the new programmed main time.

- Press the " **Enter** " button.

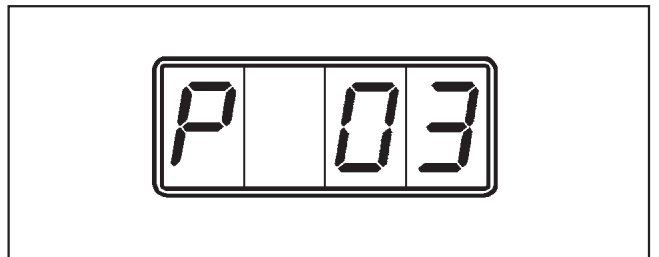

" *P 03* " will appear in the display.

The display will change from " *P 03* " to *0.10* GBP after approx. 50 seconds.

The new main time of 30 minutes is now stored in memory.

Programming example

To block channel 3 (0.50 GBP)

Before you begin, first ensure that:

- The unit is switched on and washer extractor or tumble dryer doors are shut.

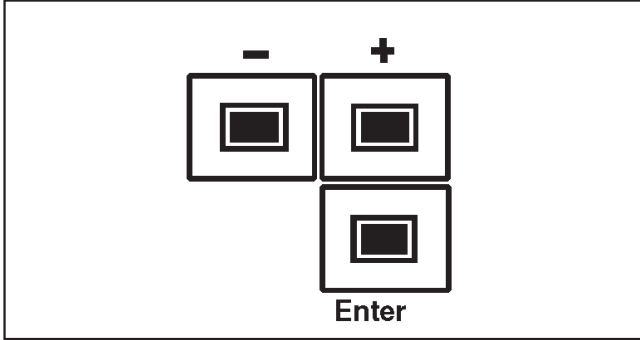

- Press and release the " **Enter** " button **4 times within 5 seconds** .

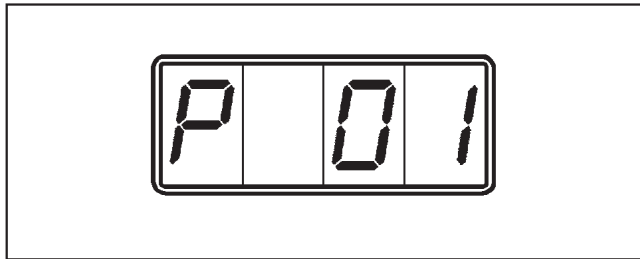

The letter " *P* " (code for programming level) will appear on the left hand side of the display. The " *01* " on the right of the display shows the first input position.

- Press the " + " button until input position " *13* " shows in the display.
- Press the " **Enter** " button.

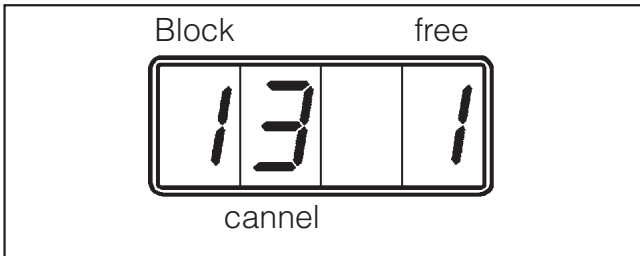

Channel *3* (0.50 GBP) will show in the display.

The " *1* " (1 = free) on the right hand side shows that the channel has been released.

The " *1* " on the left hand side shows Block 1 (see pages 9 and 19 for further information).

- Press the " - " button **once**.

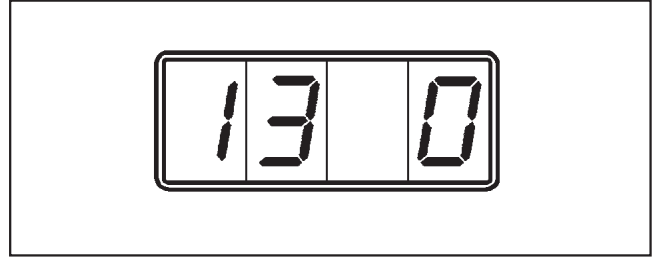

The " *0* " on the right of the display shows that the channel is " **barred** " .

- Press the " **Enter** " button.

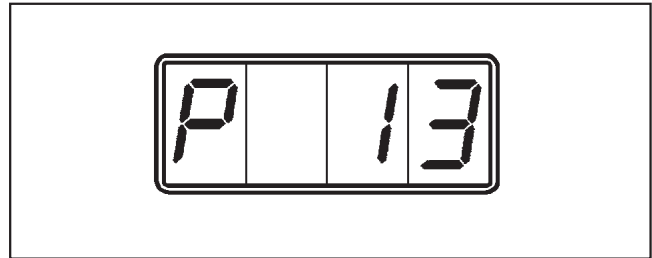

" *P 13* " will appear in the display.

The display will change from " *P 13* " to *0.50* GBP after approx. 50 seconds.

Channel 3 from Block 1 (0.50 GBP) is barred.

Total day count of all coins









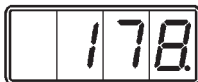

The total day count counter adds up all coin payments according to the coins received. The total day count can be deleted.

To display the total day count

- In order to view the contents of the total day count input position **1** has to be selected.
- To display the contents of the total day count press the "**Enter**" button. If the sum is a 5 figure number or more, it will be shown scrolling across the screen from right to left starting with the highest value position.

Once the lowest value has scrolled across and nothing is left in the display (position 9) the process will repeat itself.

An amount of 178.50 GBP would look like this:

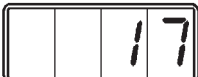
- | | |
|---|---|
| 1. | 2. |
|  |  |
| 3. | 4. |
|  |  |
| 5. | 6. |
|  |  |
| 7. | 8. |
|  |  |
| 9. | 10. |
|  |  |
| 11. | |
|  | etc. |

To delete the total day count

Input position P01

This can only be deleted if it has been selected and is visible in the display. It does not matter which digits are showing in the display.

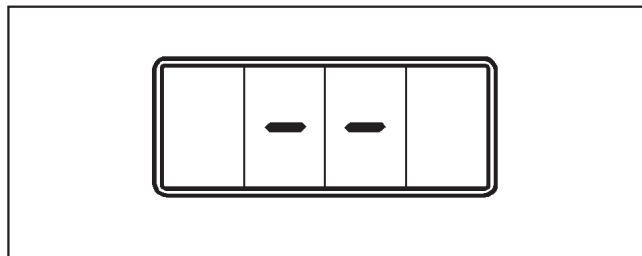

- Press the "-" button in until two horizontal bars appear in the display.
- Then release the "-" button.

The counter contents have now been deleted and "0.00" shows in the display.

Total sum count

Input position P02

The total sum count counter adds up the amount of money received according to the coins received.

The total sum count cannot be deleted.

- In order to view the contents of the total sum count proceed in the same way as for viewing the total day count.

Displays in programme operation

Display before and after programme access has been granted

In programme operation the amount of money to be inserted appears in the display after the machine (e.g. washer extractor) has been switched on and before free access has been granted to the programme.

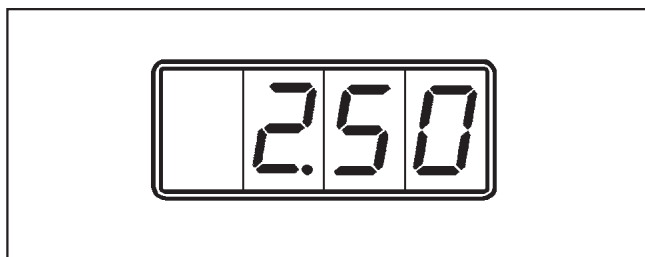

The display will show an amount such as 2.50 GBP. The number of decimal places depends on how they were programmed (in this example 1 \triangleq 2 decimal places).

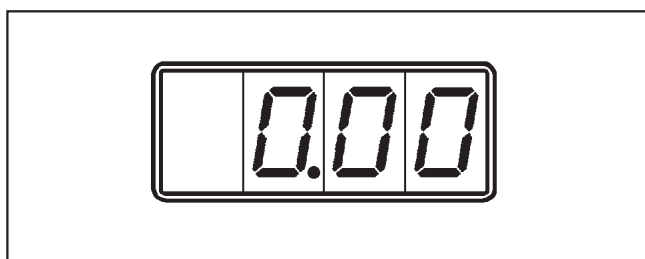

The display will count down to " 0.00 " as you feed the coins in.

After approx. 2 seconds the display will move into a dynamic state.

1.



2.



3.



4.



The two middle positions show a rotating circle (to represent a rotating drum) and a point. If this point is visible in the display you can open the drum door (e.g. to add items of laundry) without losing your money.

The point will disappear after a maximum of 3 minutes (see P07).

At this stage the coin control unit will not accept any more money. Any money fed in will be rejected.

Programming the main time

Input position P03

The main time can only be altered in steps to match the coin time of the lowest value coins. The limits for this time lie between once and 1440 times.

Programming coin time for the lowest value coin

Input position P08

Coin time for the lowest value can be programmed between 1 and 120 minutes.

This coin time also appears in the display whenever programming option "time access direct with coin insertion" is selected (see page 10, Input position P 10).

The amount of money required for the main time is calculated as follows:
Programmed main time in minutes divided by the relevant programmed coin time for the lowest value coin in minutes.

For example:

The standard programmed main time is 80 minutes.

The coin time for 2 minutes is 0.10 GBP.

The amount required for

$$\begin{aligned} \text{the Main time} &= \frac{80 \text{ minutes} \times 0.10 \text{ GBP}}{2 \text{ minutes}} \\ &= 40 \times 0.10 \text{ GBP} \\ &= \mathbf{4 \text{ GBP}} \end{aligned}$$

Special functions

Programming the brightness of the display

Input position P23

The brightness of the display can be adjusted if required. A setting can be chosen between 1 and 7.

Changing the setting changes the brightness immediately. This way you can check the brightness level before saving it in memory.

This function can also be used to avoid over payment by barring a coin higher in value than the payment amount, e.g. if the cost is 1.00 GBP the 2.00 GBP coin can be barred.

(Input position P 11, Option 0)

If for example coin 5 (0.10 GBP coin) is barred, you must make sure that you don't set the price to 2.30 GBP. It will need to be set to 2.20 or 2.40 GBP!

Programming coin recognition

Input positions P11 to P16

It is possible to grant free access or bar any coin. This is useful, for example, to prevent the use of counterfeit money. Any incorrect coins fed in will be rejected.

The following appears in the display depending on the programming:

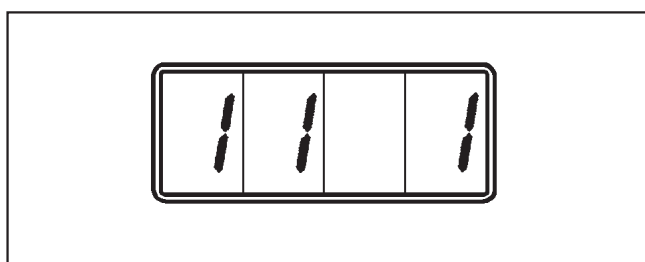

Display for coin 1, if access is free
($\bar{1}$ = Block, 1 = Coin, $\bar{1}$ = free).

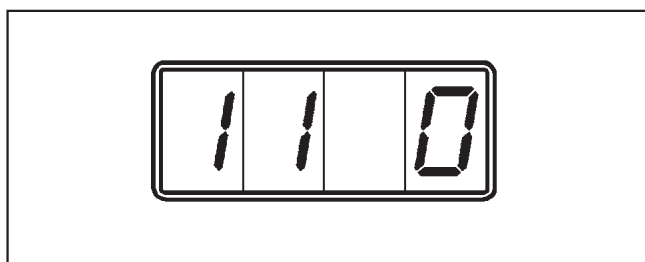

Display for coin 1, if access is barred
($\bar{0}$ = barred).

The displays for coins 2 to 6 are similar.

Allocating a value to the coin

Input positions P17 to P22

All coins (e.g. coin 7, Token WM 2) can be allocated a specific value - from 0.10 GBP to 99.90 GBP - (Standard option 2.00 GBP).

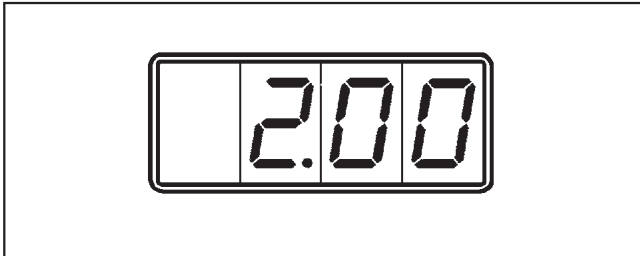

- After selecting coin 7, Token WM 2 "2.00" will appear in the display.
- This value can be changed in 0.10 GBP increments by using the "+" and "-" buttons.
- After setting the value press the "Enter" button to confirm your selection.

Example 1

To allocate a value of 1.00 GBP to coin 7 (Token WM2).

- After selecting coin 7, Token WM 2 "2.00" will appear in the display.
- Press "Enter" and use the "-" button to change the displayed value of 2.00 GBP (Standard option) to 1.00 GBP.
- Press the "Enter" button again
The value of 1.00 GBP is now saved in memory.

It will now cost 2 x Token WM 2 to purchase a programme (Standard option 2.00 GBP).

Example 2

To allocate a value of 1.00 GBP to coin 7 (Token WM2).

- Follow the same procedure as given in example 1, however allocating a value of 1.00 GBP.
- This change also requires a change from 2.00 GBP to 3.00 GBP for a programme (see page 14).

It will now cost 3.00 x Token WM 3 to purchase a programme (Standard option 3.00 GBP).

Special functions

To switch from Block 1 to Block 2

To switch from Block 1 to Block 2

Before you begin, first ensure that:

- DIL switch 8 or 10 (depending on version) on the coin tester has been changed over.

 The following conversion must only be carried out by a suitably qualified technician!

- Switch off at the mains or remove the fuse.
- Open up the front panel and take it off.
- Loosen the two cross-slotted screws now visible.
- Pull the front off.

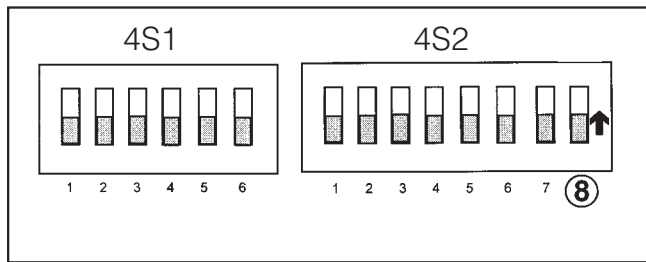

- Switch the DIL switch 8 (4S2)

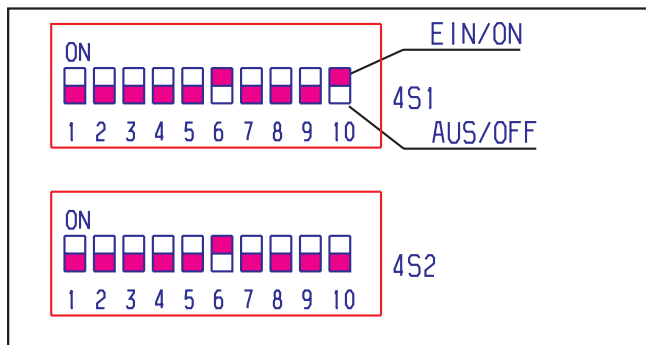

or 10 (4S1), depending on coin tester, upwards. Use a suitable tool, e.g. a ball-point pen to do this.

- Refit the front and then the front panel.
- Switch back on at the mains or replace the fuse.

Programming from Block 1 to Block 2

Input position P25

The coin tester has 12 channels in Block 1 (channels 1 - 6) for coins and Block 2 (channels 7 -12) for tokens.

- Use the " + " or " - " buttons to switch from Block 1 to Block 2.
- Press the " **Enter** " button to save the setting in memory.

The following appears in the display depending on the programming:

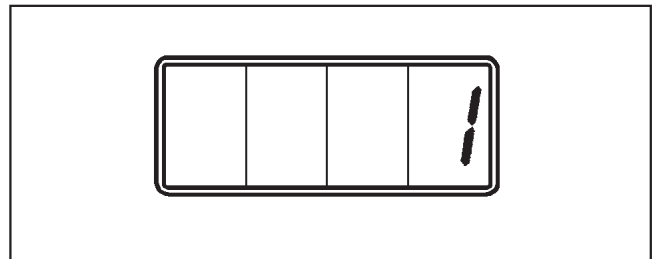

Display with Block 1 activated (Standard option)

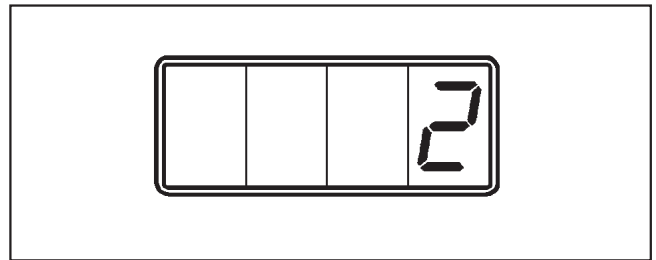

Display with Block 2 activated

 Do not use a high pressure cleaner or hose to clean the unit.

The stainless steel outer casing should be cleaned using a suitable proprietary stainless steel cleaning agent. Do not use abrasive cleaning agents as they will damage the surface material.

If you are unsure about a particular product or need further advice please contact your nearest Miele Sales office. See back page for address.





Plastic components should be cleaned using a suitable mild cleaning agent, applied with a soft damp cloth. Rub dry with a soft cloth after cleaning.

The coin control unit requires no maintenance.

After sales service

In the event of any faults please contact your Dealer or the nearest Service Department.

When contacting the Service Department please quote the model and serial number of your unit.

Miele Miele & Cie. GmbH & Co Postfach D-33325 Gütersloh CE IBN	Typ	.	
	Fabr.-Nr.	.	
	Art.-Nr.	.	
	M.-Nr.	.	
		.	
		.	A
		.	A
	Total	A	. kW
		.	kW
		.	kW

This information is given on the data plate located at the back of the coin control unit or inside the unit behind the coin/token box.

Sometimes a coin is not accepted by the coin control unit when it is first inserted. This may be because the coin has been damaged or is worn down.

- Try again using a different coin.

Abbreviated operating instructions

Before starting to use the C 4070 coin control unit:

Instructions on how to use the coin control unit with a Miele washer extractor, dryer or Miele rotary ironer are also given in the Instruction Booklet supplied with the relevant machine.

It is important to operate the unit in the correct order, as shown below. Otherwise coins will be lost.

Washer-extractors, dryers and rotary ironers

The following will show in the display on the coin control unit if the machine is operated in the correct order

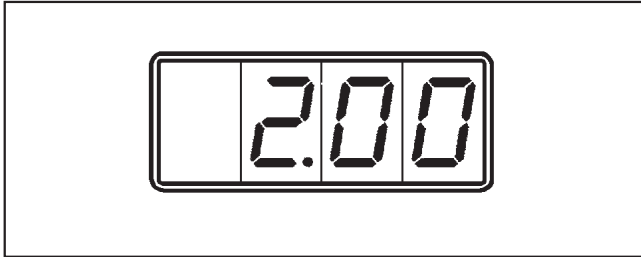

The coin control unit will display the amount to pay, e.g. *2.00* GBP

- Insert coins.

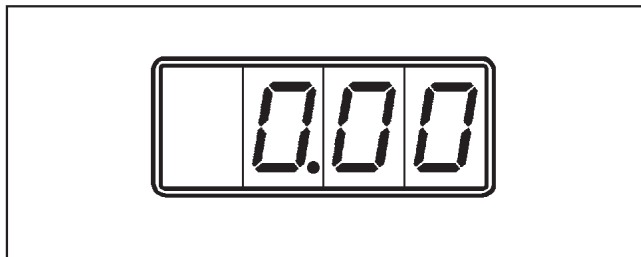

The display will count down to " *0.00* " as you feed the coins in.

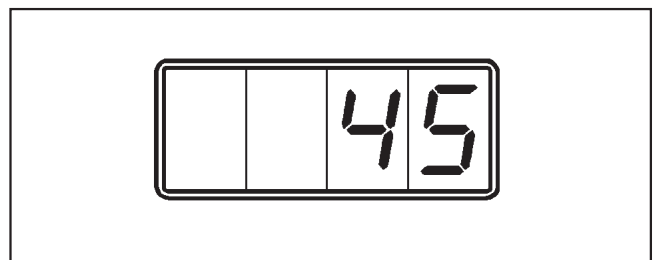
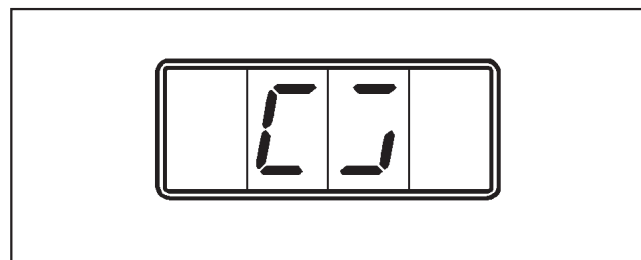

About 2 seconds later the display will change and show a rotating circle or the amount of time purchased if in timed operation, e.g. 45 minutes of ironing time.

The machine is now ready to start. It will not accept any more coins.

- Press the Start  button on the machine.
Or the " On  " button on the HM 5316.

When the programme has finished the display on the coin control unit will show that it is ready to accept coins again.

Before inserting coins make sure you have to correct amount of money. Avoid making overpayments. The coin control unit does not give change!

United Kingdom

Miele Co. Ltd., Fairacres, Marcham Road
Abingdon, Oxon, OX14 1TW
Professional Sales, Tel: 0845 365 6608
E-mail: professional@miele.co.uk
Internet: www.miele.co.uk/professional

Australia

Miele Australia Pty. Ltd.
ACN 005 635 398, ABN 96 005 635 398
Level 4, 141 Camberwell Road, Hawthorn East, VIC 3123
Tel: 1300 731 411
Internet: www.miele.com.au/professional
E-mail: professional.sales@miele.com.au

China Mainland

Miele Electrical Appliances Co., Ltd.
1-3 Floor, No. 82 Shi Men Yi Road
Jing' an District, 200040 Shanghai, PRC
Tel: +86 21 6157 3500, Fax: +86 21 6157 3511
E-mail: info@miele.cn, Internet: www.miele.cn

Hong Kong, China

Miele (Hong Kong) Ltd.
41/F - 4101, Manhattan Place
23 Wang Tai Road, Kowloon Bay, Hong Kong
Tel: (852) 2610 1025, Fax: (852) 3579 1404
Email: customerservices@miele.com.hk
Website: www.miele.hk

India

Miele India Pvt. Ltd.
1st Floor, Copia Corporate Suites,
Commercial Plot 9, Mathura Road, Jasola,
New Delhi - 110025
E-mail: customercare@miele.in, Website: www.miele.in

Ireland

Miele Ireland Ltd.
2024 Bianconi Ave., Citywest Business Campus, Dublin 24
Tel: (01) 461 07 10, Fax: (01) 461 07 97
E-Mail: info@miele.ie, Internet: www.miele.ie

Malaysia

Miele Sdn Bhd
Suite 12-2, Level 12
Menara Sapura Kencana Petroleum
Solaris Dutamas No. 1, Jalan Dutamas 1
50480 Kuala Lumpur, Malaysia
Phone: +603-6209-0288
Fax: +603-6205-3768

New Zealand

Miele New Zealand Limited
IRD 98 463 631
8 College Hill
Freemans Bay, Auckland 1011, NZ
Tel: 0800 464 353
Internet: www.miele.com.au/professional
E-mail: professional.sales@miele.com.au

Singapore

Miele Pte. Ltd.
29 Media Circle, #11-04 ALICE@Mediapolis
Singapore 138565
Tel: +65 6735 1191, Fax: +65 6735 1161
E-Mail: info@miele.com.sg
Internet: www.miele.sg

South Africa

Miele (Pty) Ltd
63 Peter Place, Bryanston 2194
P.O. Box 69434, Bryanston 2021
Tel: (011) 875 9000, Fax: (011) 875 9035
E-mail: info@miele.co.za
Internet: www.miele.co.za

United Arab Emirates

Miele Appliances Ltd.
Showroom 1, Eiffel 1 Building
Sheikh Zayed Road, Umm Al Sheif
P.O. Box 114782 - Dubai
Tel. +971 4 3044 999, Fax. +971 4 3418 852
800-MIELE (64353)
E-Mail: info@miele.ae, Website: www.miele.ae



Manufacturer: Miele & Cie. KG
Carl-Miele-Straße 29, 33332 Gütersloh, Germany