

## Operating and installation instructions Downdraft extractor



To prevent the risk of accidents or damage to the appliance, it is **essential** to read these instructions before it is installed and used for the first time.

# Contents

---

<b>Caring for the environment</b> .....	4
<b>Warning and Safety instructions</b> .....	5
<b>Guide to the cooker hood</b> .....	14
<b>Modes of operation</b> .....	16
Recirculation mode Plug&Play .....	16
<b>Before using for the first time</b> .....	17
Selecting extraction mode or recirculation mode .....	17
Setting up Miele@home .....	18
Connecting via the app .....	18
Connecting via WPS .....	20
Sign out of WiFi (reset to factory settings) .....	21
Setting up Con@ctivity .....	22
Con@ctivity via the home WiFi network (Con@ctivity 3.0) .....	22
Con@ctivity via a direct WiFi connection (Con@ctivity 3.0) .....	23
Reattempting the connection .....	23
<b>Operation (Automatic mode)</b> .....	24
Cooking with Con@ctivity (Automatic mode) .....	24
Cooking process .....	25
Leaving automatic mode temporarily .....	25
Returning to automatic mode .....	25
<b>Operation (Manual mode)</b> .....	27
Cooking without Con@ctivity (Manual mode) .....	27
Switching on the fan .....	27
Selecting the second Booster level .....	27
Selecting the run-on time .....	28
Switching the fan off .....	28
Run-on in Plug&Play operation .....	28
Switching on and dimming the hob lighting .....	29
Switching the hob lighting off .....	29
Retracting the deflector plate .....	29
Automatic retraction .....	29
Power management .....	29
<b>Changing settings</b> .....	30
Altering the operating hours counter for the grease filter(s) .....	30
Altering or deactivating the charcoal filter operating hours counter .....	31
Deactivating power management .....	31
Buzzer for the sensor controls .....	32

---

<b>Energy saving tips</b> .....	33
<b>Cleaning and care</b> .....	34
Housing .....	34
Important information for appliances with stainless steel surfaces .....	34
Grease filters and panel for edge extraction .....	35
Removing the panel .....	37
Cleaning the drip tray .....	37
Inserting the panel.....	38
Resetting the grease filter operating hours counter .....	38
Replacing the grease filters.....	38
Charcoal filters .....	39
Resetting the charcoal filter operating hours counter .....	39
Disposing of charcoal filters .....	39
Reactivatable charcoal filters .....	40
<b>Problem solving guide</b> .....	41
<b>Service</b> .....	42
Contact in case of malfunction .....	42
Position of the data plate .....	42
Guarantee.....	42
<b>Installation</b> .....	43
Before installation.....	43
Installation materials.....	43
Appliance dimensions .....	44
Installation dimensions.....	45
Installation examples.....	50
Sealing the gaps.....	51
Connection for air extraction.....	52
Non-return flap .....	52
Electrical connection .....	53
<b>Technical data</b> .....	54
Optional accessories for recirculation mode.....	54

# Caring for the environment

---

## Disposing of the packaging material

The packaging material is used for handling and protects the appliance from transport damage. The packaging material used is selected from materials which are environmentally friendly for disposal and can generally be recycled.

Recycling the packaging material reduces the use of raw materials. Use material-specific collection points for valuable materials and take advantage of return options. Your Miele dealer will take the packaging material away.

## Disposal of your old appliance

Electrical and electronic appliances often contain valuable materials. They also contain materials which, if handled or disposed of incorrectly, could be potentially hazardous to human health and to the environment. They are, however, essential for the correct functioning of your appliance. Please do not therefore dispose of it with your household waste.

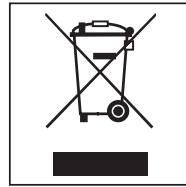

Please dispose of it at your local community waste collection / recycling centre or contact your Miele dealer for advice.

Ensure that it presents no danger to children while being stored for disposal.

## Warning and Safety instructions

This cooker hood complies with all relevant local and national safety requirements. Inappropriate use can, however, lead to personal injury and material damage.

Read the operating and installation instructions carefully before using the cooker hood. They contain important information on its safety, installation, use and maintenance. This prevents both personal injury and damage to the cooker hood.

In accordance with standard IEC 60335-1, Miele expressly and strongly advises that you read and follow the instructions in the chapter on installing the appliance as well as the safety instructions and warnings.

Miele cannot be held liable for injury or damage caused by non-compliance with these instructions.

Keep these instructions in a safe place and pass them on to any future owner.

### Correct application

- ▶ The cooker hood is not intended for outdoor use.
- ▶ It must only be used as a domestic appliance to extract vapours and remove odours from cooking. Any other usage is not supported by the manufacturer and could be dangerous.
- ▶ The cooker hood can only be used by people with reduced physical, sensory or mental capabilities, or lack of experience and knowledge, if they are supervised whilst using it, or have been shown how to use it in a safe way and recognise and understand the consequences of incorrect operation.

# Warning and Safety instructions

---

## Safety with children

- ▶ Children under 8 years of age must be kept away from the cooker hood unless they are constantly supervised.
- ▶ Children aged 8 and older may only use the cooker hood without supervision if they have been shown how to use it and are able to do so in a safe manner. Children must be able to understand and recognise the possible dangers caused by incorrect operation.
- ▶ Children must not be allowed to clean or maintain the cooker hood unsupervised.
- ▶ Please supervise children in the vicinity of the cooker hood and do not let them play with it.
- ▶ Danger of suffocation. Packaging, e.g. plastic wrappings, must be kept out of the reach of babies and children. Whilst playing, children could become entangled in packaging or pull it over their head and suffocate.

## Technical safety

- ▶ Unauthorised installation, maintenance and repairs can cause considerable danger for the user. Installation, maintenance and repairs must only be carried out by your Miele dealer.
- ▶ A damaged appliance can be dangerous. Check it for visible signs of damage. Do not use a damaged appliance.
- ▶ The electrical safety of this appliance can only be guaranteed when correctly earthed. It is essential that this standard safety requirement is met. If in any doubt please have the electrical installation tested by a qualified electrician.
- ▶ Temporary or permanent operation on an autonomous power supply system or a power supply system that is not synchronised with the mains power supply (e.g. island networks, back-up systems) is possible. A prerequisite for operation is that the power supply system complies with the specifications of EN 50160 or an equivalent standard.

The function and operation of the protective measures provided in the domestic electrical installation and in this Miele product must also be maintained in isolated operation or in operation that is not synchronised with the mains power supply, or these measures must be replaced by equivalent measures in the installation. As described, for example, in the current version of BS OHSAS 18001–2 ISO 45001.
- ▶ The connection data (voltage and frequency) on the data plate of the cooker hood must match the mains electricity supply in order to avoid the risk of damage to the cooker hood  
Compare this before connecting the appliance to the mains. Consult a qualified electrician if in any doubt.
- ▶ Do not connect the appliance to the mains electricity supply by a multi-socket unit or an extension lead. These are a fire hazard and do not guarantee the required safety of the appliance.

## Warning and Safety instructions

---

- ▶ For safety reasons, this appliance may only be used after it has been built in.
- ▶ The cooker hood must not be used in a non-stationary location (e.g. on a ship).
- ▶ Touching electrical components and tampering with electrical and mechanical parts is highly dangerous to the user and can cause operational faults.  
Only open the housing as described in the instructions given in the installation sheet and in the Cleaning and care section of this booklet. Under no circumstances should any other parts of the housing be opened.
- ▶ The manufacturer's warranty will be invalidated if the appliance is not repaired by a Miele authorised technician.
- ▶ If the electrical connection cable is faulty it must only be replaced by a Miele authorised technician to protect the user from danger.
- ▶ The LED lamps are a built-in component of the lighting.  
Replacement LED lamps may only be fitted by a Miele authorised technician or by the Miele Customer Service Department.
- ▶ During installation, maintenance and repair work, the appliance must be disconnected from the mains electricity supply.



# Warning and Safety instructions

Using at the same time as another heating appliance that depends on the air from the room

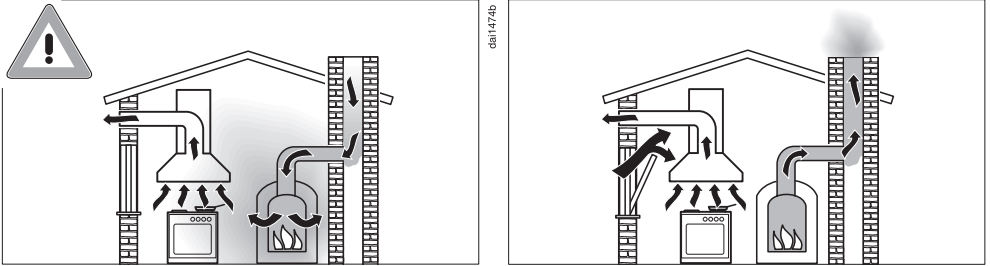

## Danger of toxic fumes!

Great care should be taken when using the cooker hood in the same room or the same area of the house at the same time as another heating appliance that depends on the air from the room. Such heating appliances draw in air from the room and duct exhaust gases out through a chimney or extraction ducting. They include gas, oil, wood and coal-fired boilers and heaters, continuous flow or other water heaters, gas hobs and ovens.

The cooker hood draws in air from the kitchen and from neighbouring rooms. This applies to the following modes of operation:

- Extraction mode
- Recirculation mode with a recirculation box installed outside the room.

If there is insufficient air, negative pressure will occur. The heating appliance may be starved of oxygen. This impairs combustion. Harmful gases could be drawn from the chimney or extraction ducting back into the room.

**Risk of death!**

## Warning and Safety instructions

---

In order to ensure safe operation and to prevent gases given off by the heating appliance from being drawn back into the room when the cooker hood and the heater are both operated simultaneously, an underpressure in the room of 0.04 mbar (4 Pa) is the maximum permissible.

Sufficient ventilation can be maintained by air inlets which cannot be blocked, e.g. in windows, doors and outside wall vents. The cross-section of the inlet openings must enable sufficient ventilation. A ventilation brick alone is not generally sufficient to ensure safe ventilation.

The overall ventilation condition of the dwelling must be taken into account. If in any doubt, the advice of a competent builder or, for gas a qualified gas fitter (registered with an official gas safety body in accordance with national safety regulations) must be sought.

If the cooker hood is being operated in recirculation mode, whereby the air is redirected into the room in which it is installed, the above restrictions do not apply.

## Correct use

▶ Risk of crushing! Do not reach into the travel area of the extractor as it moves up or down.

▶ Open flames are a fire hazard.

The use of an open flame under the cooker hood is not permitted. To avoid the danger of fire, do not flambé or grill over an open flame.

When switched on, the cooker hood could draw flames into the filter. Fat deposits could ignite, presenting a fire hazard.

▶ Always switch the cooker hood on when a cooking zone is in use, otherwise condensation may collect in the hood, which could cause corrosion.

▶ Overheated oil and fat can ignite, causing fire damage to the cooker hood.

When cooking with oil or fat, chip pans and deep fat fryers, etc, do not leave the pans unattended. Similarly, never leave an open grill unattended when grilling.

▶ Do not use the cooker hood without the filters in place. This way you will avoid the risk of grease and dirt getting into the appliance and hindering its smooth operation.

▶ There is a risk of fire if the cooker hood is not cleaned as described in these operating instructions.

▶ The cooker hood can get very hot during cooking due to heat rising from the hob.

Do not touch the housing or the grease filters until the cooker hood has cooled down.

## Warning and Safety instructions

---

### Proper installation

- ▶ To determine whether a cooker hood may be operated above your cooking appliance, please refer to the information provided by the appliance's manufacturer.
- ▶ The downdraft extractor must not be installed next to solid fuel stoves.
- ▶ The cooker hood must not be operated in combination with a gas hob.
- ▶ The distances given in "Installation" must be observed when fitting the downdraft extractor.
- ▶ Exhaust ducting must be of non-inflammable material. Suitable material is available from your Miele dealer.
- ▶ The appliance must not be connected to a chimney or flue which is in use. Neither should it be connected to ducting which ventilates rooms with fireplaces.
- ▶ If exhaust air is to be extracted into a chimney or ventilation duct no longer used for other purposes, seek professional advice.

## **Cleaning and care**

▶ Do not use a steam cleaning appliance to clean this appliance. The steam could reach electrical components and cause a short circuit.

## **Accessories and spare parts**

▶ Only use genuine original Miele accessories and spare parts with this appliance. Using accessories or spare parts from other manufacturers will invalidate the guarantee, and Miele cannot accept liability.

▶ Miele can only guarantee the safety of the appliance when genuine original Miele replacement parts are used. Faulty components must only be replaced by Miele spare parts.

▶ Miele will guarantee to supply functional spare parts for a minimum of 10 years and up to 15 years following the discontinuation of your vapour extraction unit.

# Guide to the cooker hood

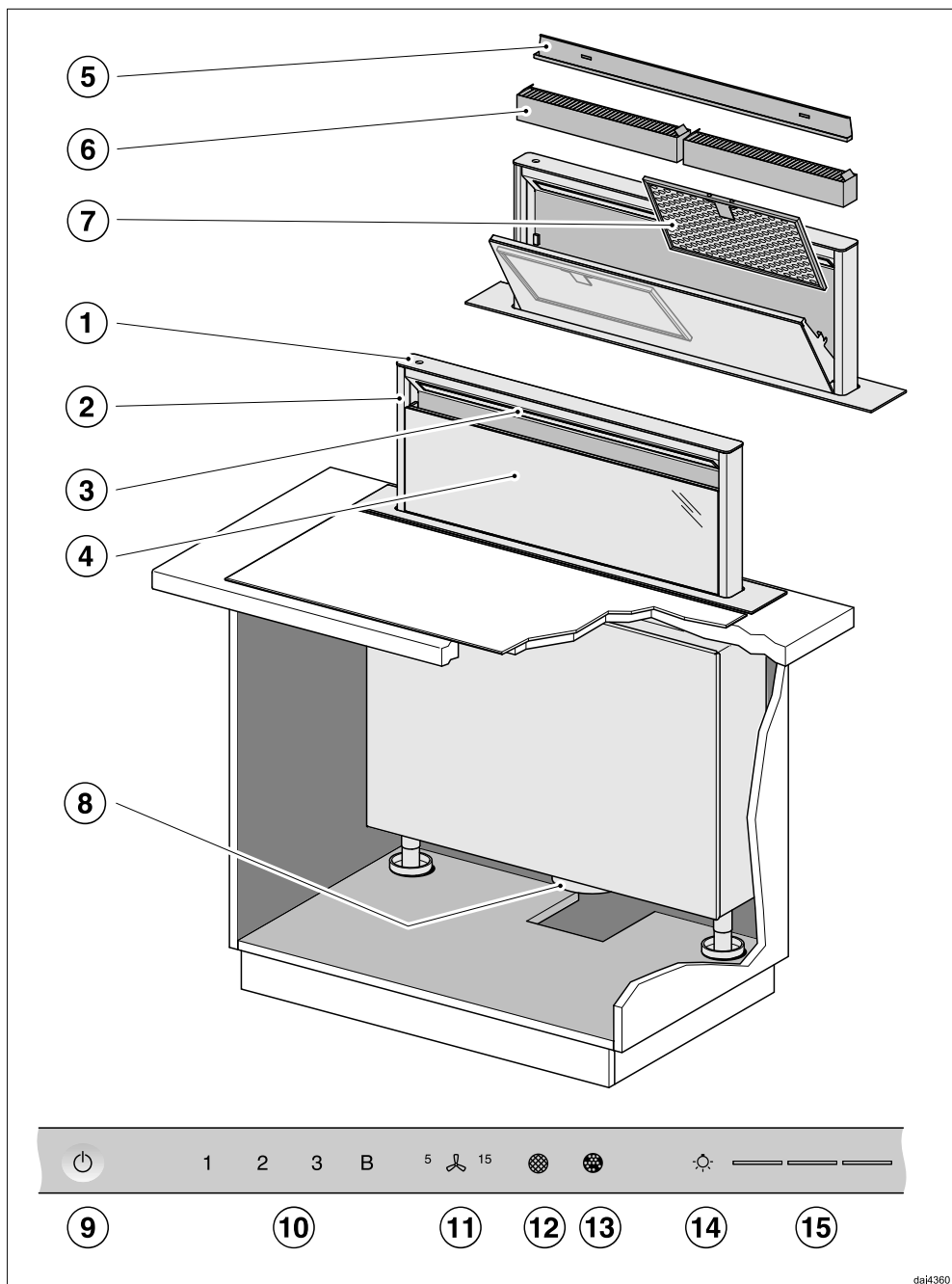

da14360

- ① Control elements
- ② Retractable deflector plate
- ③ Hob lighting
- ④ Edge extraction panel
- ⑤ Drip tray
- ⑥ Charcoal filter
  - Single-use or reactivatable charcoal filters
  - Optional accessories for recirculation mode
- ⑦ Grease filters
- ⑧ Exhaust duct
- ⑨ Sensor control for switching the cooker hood on and off
- ⑩ Sensor controls for switching the fan on and off and for setting the fan power level
- ⑪ Sensor control for the run-on function
- ⑫ Sensor control for the grease filter operating hours counter
- ⑬ Sensor control for the charcoal filter operating hours counter
- ⑭ Sensor control for switching the lighting on and off and for dimming the lighting
- ⑮ Sensor controls for selecting and displaying lighting levels

# Modes of operation

---

Depending on the model of the cooker hood, the following options are available:

## **Extraction mode**

The cooking vapours are drawn in by the cooker hood. The air is then passed via the edge extraction panel through the grease filters, cleaned and then directed outside.

## **Recirculation mode**

(with conversion kit and charcoal filter as optional accessories)

The air is drawn in via the edge extraction panel and cleaned first by the grease filters and then by charcoal filters. The air is then circulated back into the kitchen.

For recirculation operation, we recommend that the air is fed into the kitchen through a duct with an outlet, e.g. in the plinth panel.

## **Recirculation mode Plug&Play**

If the installation space is not sufficient for an air duct, the air can also be guided into the plinth under the kitchen furniture in Plug&Play operation. Please follow the instructions in "Installation".







## Selecting extraction mode or recirculation mode

The cooker hood is suitable for both extraction mode and recirculation mode. The power of the fan is adapted to suit the selected operating mode. The cooker hood is delivered set up for recirculation mode. It has to be reset for extraction mode.

To reset it for extraction mode, the operating hours counter for the charcoal filter(s) has to be deactivated.

- With the deflector plate retracted, touch the On/Off switch .

All symbols light up with reduced brightness.

- Press and hold the run-on option control  until the grease filter  and charcoal filter  symbols light up.
- Touch the charcoal filter symbol .

The charcoal filter symbol  and one of the fan power levels will flash.

- Touch **B**.
- Confirm your choice by touching the charcoal filter control .

All the indicator lights will go out.

Extraction mode has now been set.



If you do not confirm your selection within 4 minutes, the cooker hood will automatically revert to the original setting.

## Activating/Deactivating Plug&Play

- Touch the On/Off switch .



All symbols light up with reduced brightness.

- Press and hold the run-on option control .

After a few seconds, the grease filter  and charcoal filter  symbols light up, and after a further 5 seconds the **1** fan power level indicator lights up.

The deflector plate extends.

- Then touch the following controls in turn:

- **1**
- The lighting control  and
- The lighting control  again

When Plug&Play is deactivated, the indicators **1** and **3** will flash.

When Plug&Play is activated, the indicators **1** and **3** will light up constantly.

- To activate, touch **B**.

The **1** and **3** indicators light up constantly.

- Touch **1** to deactivate.

The **1** and **3** indicators flash.

- Confirm the setting with the run-on option control .

All the lights will go out.

If you do not confirm your choice of setting within 4 minutes, the cooker hood will revert to the old setting.

# Before using for the first time

---

## Setting up Miele@home

Requirements:

- A WiFi network
- The Miele app
- A Miele user account. The user account can be created via the Miele app.

Your cooker hood is equipped with an integrated WiFi module. Connect the cooker hood to your household WiFi network. You will then be able to operate the cooker hood via the Miele app.

If your Miele hob is connected to a home WiFi network, you can control the cooker hood automatically via the Con@ctivity function.

Before installing the cooker hood in its final location, ensure that the signal of your WiFi network is strong enough.

You can connect to the household WiFi network via the Miele app or via WPS.

## Miele@home availability

The ability to use the Miele app depends on the availability of the Miele@home service in your country.

The Miele@home service is not available in every country.

For information about availability, please visit [www.miele.com](http://www.miele.com).

## Miele App

The Miele App is available to download free of charge from the Apple App Store® or from the Google Play Store™.



## Connecting via the app

The Miele app can be used to connect to your network.

- Install the Miele app on your mobile device.

## Before using for the first time

For the registration, you will need:

1. Your WiFi network password
2. Your cooker hood password



The password for your cooker hood consists of the last 9 digits of the serial number. This can be found on the appliance's data plate.

The data plate can be found on the front of the housing.







- Follow the instructions to start registering the appliance in the app.

If requested to activate WiFi on the cooker hood, proceed as follows:

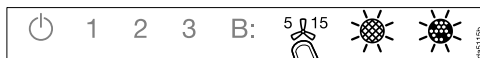
- With the deflector plate retracted, touch the On/Off switch .

All symbols light up with reduced brightness.



- Press and hold the run-on option control  until the grease filter  and charcoal filter  symbols light up.

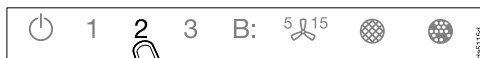

- Touch **2**.

The deflector plate extends.

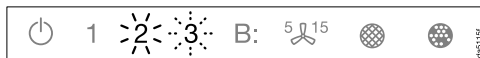

**2** will light up constantly, **3** will flash.

The cooker hood will be ready for connection in the next 2 minutes.



- Follow the instructions in the app.

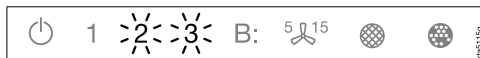

When successfully connected, **2** and **3** will light up constantly.

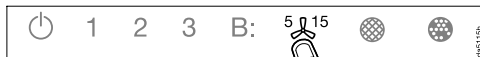

- Quit connection mode on the cooker hood by touching the run-on option control .

The cooker hood can now be operated via the app.

# Before using for the first time



## Connecting via WPS

Your WiFi router must support WPS (WiFi Protected Setup).

- With the deflector plate retracted, touch the On/Off switch .

All symbols light up with reduced brightness.



- Press and hold the run-on option control  until the grease filter  and charcoal filter  symbols light up.

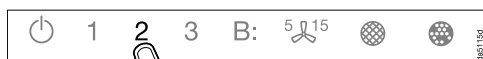

- Touch **2**.

The deflector plate extends.



**2** will light up constantly, **3** will flash.

The WiFi connection must be started on the cooker hood at the same time as on the WPS router.

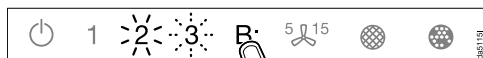

- Press **B** on the cooker hood after a few seconds.

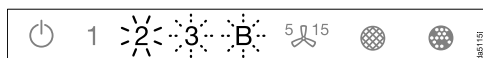

After a short while, **2** will light up constantly, and **3** and **B** will flash.

The cooker hood is ready for connection for the next two minutes.



- Start the WPS connection on your WiFi router.

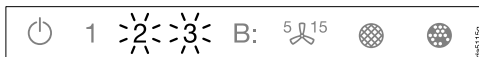

When successfully connected, **2** and **3** will light up constantly.



- Quit connection mode on the cooker hood by touching the run-on option control .

The cooker hood can now be operated via the app.

If the connection fails, you have probably not activated WPS on your router quickly enough. Repeat the steps above.

**Tip:** If your WiFi router does not support WPS, please connect via the Miele app.

## Before using for the first time



### Sign out of WiFi (reset to factory settings)

To set up a new WiFi connection, the existing WiFi connection must be disconnected.

- With the deflector plate retracted, touch the On/Off switch .

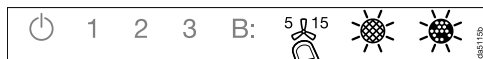
All symbols light up with reduced brightness.



- Press and hold the run-on option control  until the grease filter  and charcoal filter  symbols light up.



- Touch **1**.

The deflector plate extends.

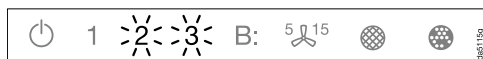

If a WiFi connection exists, **2** and **3** will light up constantly.

The cooker hood will be ready for disconnection in the next 2 minutes.

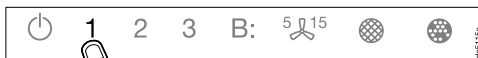

- Touch **1**.



**2** will light up constantly, **3** will flash.

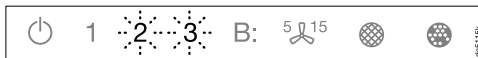

After a few seconds, **2** and **3** will flash. The connection has now been disconnected.



- Quit signing-off mode on the cooker hood by touching the run-on option control .

The WiFi connection has now been disconnected. A new connection can now be set up.

# Before using for the first time

---

## Setting up Con@ctivity

Con@ctivity is the direct communication system between an electric Miele hob and a Miele cooker hood. It enables the cooker hood to operate automatically depending on the operational state of a Miele hob with onset controls.

- When the hob is switched on, the cooker hood lighting comes on automatically and then after a short time the fan also comes on.
- The cooker hood selects the power level automatically during cooking. The power level selected by the cooker hood depends on the number of cooking zones being used and their power levels.
- After switching the hob off the fan and the hob lighting will switch off automatically after a specified period of time.

See “Operation” for detailed information about this function.

## Con@ctivity via the home WiFi network (Con@ctivity 3.0)

Prerequisite:

- Home WiFi network
- WiFi-enabled Miele hob

- Connect the cooker hood and hob to your home WiFi network (see “Setting up Miele@home”).

The Con@ctivity function will be activated automatically.

# Before using for the first time

## Con@ctivity via a direct WiFi connection (Con@ctivity 3.0)

Prerequisite:



- WiFi enabled Miele hob

If you do not have a home network, you can establish a direct connection between the hob and the cooker hood.

- With the deflector plate retracted, touch the On/Off switch .

All symbols light up with reduced brightness.



- Press and hold the run-on option control  until the grease filter  and charcoal filter  symbols light up.



- Touch **3**.

The deflector plate extends.

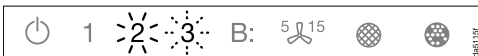

**2** will light up constantly, **3** will flash.

The cooker hood will be ready for connection in the next 2 minutes.

- Start the WiFi connection on the hob. For further details, see the hob operating instructions.

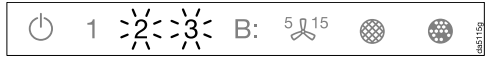

When successfully connected, **2** and **3** will light up constantly.



- Quit connection mode on the cooker hood by touching the run-on option control .

Con@ctivity is now activated.

With a direct WiFi connection, it is not possible to connect the hob and the cooker hood to a home network. Should this be required at a later date, the WiFi connection between the hob and the cooker hood must be disconnected (see “Sign out of WiFi”).

## Reattempting the connection



If it is not possible to connect, **2** and **3** flash or the cooker hood cancels the process.

- Disconnect the connection to the cooker hood (see “Signing out of WiFi”) and to the hob.
- Attempt to make the connection again.

# Operation (Automatic mode)

## Risk of crushing!

Do not reach into the motion range of the deflector plate as it moves up or down.

When Con@ctivity is active, the cooker hood always operates in automatic mode (see “Before using for the first time” – “Setting up Con@ctivity”).

If you wish to manually operate the cooker hood, see “Operation (Manual mode)” – “Cooking without Con@ctivity”.

## Cooking with Con@ctivity (Automatic mode)

- Switch a cooking zone on at the desired power level.

The deflector plate extends.

The hob lighting will come on.

After a few seconds the fan will come on, first at power level **2**, then it will switch immediately to power level **1**.

The cooker hood selects the fan power level automatically during cooking.

This is determined by the total output of the hob, i.e. the number of cooking zones in operation and the power levels selected.

- If you select a higher power level or are using several cooking zones on the hob, the cooker hood will switch to a higher fan power level.
- When you reduce the power level or the number of cooking zones on the hob, the fan power level is also reduced.

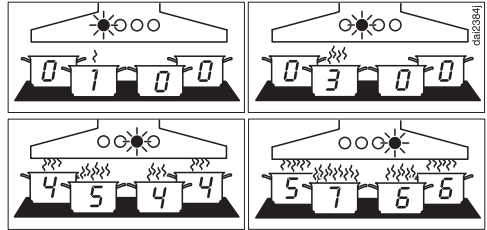

Examples for power levels **1** to **B**

## Reaction time

The cooker hood reacts with a slight delay because altering the power level on the hob does not immediately result in a reduction or increase in cooking vapours.

Because the hob transmits the information to the cooker hood at intervals, this can also cause delays.

The reaction can vary from a few seconds to a couple of minutes.



## Cooking process

- For example, you switch on a cooking zone at the highest power level to heat a pan for frying. You reduce the power level after approx. 10 seconds to 4 minutes (60 seconds to 5 minutes for a for a HiLight hob).

The cooker hood recognises a cooking process.

The cooker hood switches itself on and when the hob power level has been reduced, the hood switches to fan power level 3 and remains at that level for approx. 5 minutes.

After that, the cooker hood power level is determined automatically by the Con@ctivity function.

You can select another power level manually before then.

## Switching off

- Switch off all cooking zones.

The power level is gradually reduced until the fan finally switches off.

This helps to neutralise any lingering vapours and odours in the air.

Depending on the last active fan level, the process takes 2 to 5 minutes.

30 seconds after the fan is switched off, the hob lighting switches off.

1 minute later, the deflector plate retracts.

The cooking process is then finished.

## Leaving automatic mode temporarily

To leave automatic mode temporarily during cooking:

- Manually select a different fan power level, or
- Manually switch the cooker hood off, or
- Activate the run-on function  on the cooker hood. The fan will switch itself off after the selected run-on time, and the lighting will remain on.

The cooker hood functions are now operated manually (see “Operation (Manual mode)”).

If you switch off the fan manually in Plug&Play mode, it continues to run at level 1 (see “Operation (Manual mode)” – “Switching off the fan”).

## Returning to automatic mode

The cooker hood will resume automatic mode:

- If the cooker hood has not been used for approx. 5 minutes after selecting a fan power level manually, or
- If the manually selected fan power level corresponds to the automatic one again, or
- The cooker hood fan and the hob have been switched off for at least 30 seconds.  
Automatic mode will resume next time the hob is switched on.

## Operation (Automatic mode)

---

You can also operate the cooker hood manually for a complete cooking process.

- Switch the cooker hood fan on **before** the hob.

If the cooker hood fan and the hob have been switched off for at least 30 seconds after cooking, automatic mode will resume next time the hob is switched on.

## Risk of crushing!

Do not reach into the motion range of the deflector plate as it moves up or down.

## Cooking without Con@ctivity (Manual mode)

The cooker hood can be operated manually if:

- The Con@ctivity function is not activated.
- You have temporarily deactivated the Con@ctivity function (see “Operation (Manual operation)” – “Leaving automatic mode temporarily”).

## Switching on the fan

Select power levels **1** to **3** for light to heavy cooking vapours, odours or heating.

Increase the power level as the level of vapours, odours or heat increases.

For short periods of cooking food with intensive vapours, odours or heat, e.g. when searing meat, select Booster level **B**.

- With the deflector plate retracted, touch the On/Off switch .

All symbols light up with reduced brightness.

- Touch one of the controls **1** to **B**.

The deflector plate extends.

The fan switches to the desired level.

## Selecting the second Booster level

- When you select the Booster level, the **B** symbol lights up. To increase the power level further, touch **B** again.

The **B** symbol lights up.

The second Booster level is activated. The air throughput is increased for a short time.

## Switching back the booster levels

If Power management is activated (default setting), the first booster level **B** automatically switches back to level **3** after 5 minutes.

The second booster level **B** switches back after 2 minutes (even if Power management is deactivated).

# Operation (Manual mode)





---

## Selecting the run-on time

It is advisable to run the fan for a few minutes after cooking has finished. This helps to remove any lingering vapours and odours from the air.

It also reduces the risk of residues accumulating in the cooker hood and any resultant odours.

The run-on function enables the fan to continue running for a pre-determined time before switching itself off automatically.

- After you have finished cooking, touch the run-on option control .
- Once: the fan will switch itself off after 5 minutes (**5**  lights up).
- Twice: The fan will switch itself off after 15 minutes ( **15** lights up).
- If you touch the run-on option control  again, the fan will remain on ( will go out).

## Switching the fan off

- Touching the control for the active power level again switches the fan off.

The deflector plate remains extended.

## Run-on in Plug&Play operation

If you switch off the fan in Plug&Play mode, it will run on at level **1**.

Run-on ensures that the plinth is ventilated after cooking.

Depending on the last active fan level, run-on lasts between 2 and 30 minutes.

You can switch off the fan immediately during run-on by pressing **1** or the On/Off switch .

This function is independent of the run-on function .

### Switching on and dimming the hob lighting

The hob lighting can be switched on and off and dimmed independently of the fan.



- With the deflector plate retracted, touch the On/Off switch .

All symbols light up with reduced brightness.

- Touch the lighting control  briefly.

The deflector plate extends.

The lighting will switch on at maximum brightness. All 3 bars next to the lighting control  light up.

- With the lighting switched on, press and hold the lighting control . The brightness will gradually dim until you release the control.
- Press and hold the lighting control  again to increase the brightness to the level required and then release it.
- Alternatively, you can select 3 brightness levels by touching the bars next to the lighting control .

### Switching the hob lighting off

- Touching the lighting control  again switches the hob lighting off.

The deflector plate remains extended.

### Retracting the deflector plate

- Touch the On/Off switch .

The fan and the hob lighting are switched off.

All symbols go out.

The deflector plate retracts.

### Automatic retraction

If you switch off the fan and the lighting when the deflector plate is extended, the deflector plate will automatically retract after 1 minute.

### Power management

The cooker hood is fitted with a power management system. Power management helps to save energy. It ensures that the fan power level is reduced automatically and that the lighting is switched off.

- If the Booster setting has been selected, the fan will automatically switch to level 3 after 5 minutes.
- From fan power levels 3, 2 or 1, the power will be reduced by one level after 2 hours and then in 30-minute stages until the fan finally switches off.
- The hob lighting will switch off automatically after 12 hours.

## Changing settings

---

All settings are made with the cooker hood switched off.

- Switch off the fan and the lighting and retract the deflector plate.

### Altering the operating hours counter for the grease filter(s)



You can set the operating hours counter to suit the type of cooking you do.

The factory default setting is a cleaning interval of 30 hours.

- Select a shorter time of 20 hours if you fry a lot.
- If you only cook occasionally, we recommend that you still select a short time. This is to prevent grease hardening on the filter(s) and making cleaning more difficult.
- Select a longer time of 40 or 50 hours if you use very little fat for cooking.

- Touch the On/Off switch .

All symbols light up with reduced brightness.

- Press and hold the run-on option control <sup>5</sup> <sup>15</sup> until the grease filter  and charcoal filter  symbols light up.

- Touch the grease filter symbol .

The grease filter symbol  and one of the fan power level indicators will flash.

Fan power level indicators **1** to **B** show the time set:

Indicator <b>1</b> .....	20 hours
Indicator <b>2</b> .....	30 hours
Indicator <b>3</b> .....	40 hours
Indicator <b>B</b> .....	50 hours

- Touch the relevant control to select the duration required.
- Confirm your choice by touching the grease filter control . If you do not confirm your selection within 4 minutes, the cooker hood will automatically revert to the original setting.

## Altering or deactivating the charcoal filter operating hours counter

Charcoal filters are needed for recirculation mode.



You can set the operating hours counter to suit the type of cooking you do.

It has to be deactivated for extraction mode.

It is set at the factory for 180 hours of use before the filters need replacing.

- Touch the On/Off switch .

All symbols light up with reduced brightness.

- Press and hold the run-on option control  until the grease filter  and charcoal filter  symbols light up.

- Touch the charcoal filter symbol .

The charcoal filter symbol  and one of the fan power levels will flash.

Fan power level indicators **1** to **B** show the time set:

Indicator **1** ..... 120 hours

Indicator **2** ..... 180 hours

Indicator **3** ..... 240 hours

Indicator **B** ..... deactivated

- Touch the relevant control to select the duration required.
- Confirm your choice by touching the charcoal filter control . If you do not confirm your selection within 4 minutes, the cooker hood will automatically revert to the original setting.



## Deactivating power management



Keep in mind that deactivating this function may increase energy consumption.

### Activating/deactivating Power management

- Touch the On/Off switch .



All symbols light up with reduced brightness.

- Press and hold the run-on option control  <sup>5</sup>  <sup>15</sup>.

After a few seconds, the grease filter  and charcoal filter  symbols light up, and after a further 5 seconds the **1** fan power level indicator lights up.

The deflector plate extends.

- Then touch the following controls in turn:

- the lighting control ,
- the **1** control and then
- The lighting control  again

When Power management is activated, the **1** and **B** indicators light up constantly.

When it is deactivated, the **1** and **B** indicators flash.

- To deactivate Power management, touch **1**.

The **1** and **B** indicators will flash.

- To activate, touch **B**.

The **1** and **B** indicators will light up constantly.

## Changing settings

---

- Confirm the setting with the run-on option control .

All the lights will go out.

If you do not confirm your choice of setting within 4 minutes, the cooker hood will revert to the old setting.



### Buzzer for the sensor controls

When a function is selected with the sensor controls, a short buzzer will sound for confirmation.

The buzzer can be switched off.

- Touch the On/Off switch .

All symbols light up with reduced brightness.

- Press and hold the run-on option control  until the grease filter  and charcoal filter  symbols light up.

- Touch **B**.

The buzzer is switched off.

- If you want to switch the buzzer on again, proceed in the same way.

Regardless of the previous setting, the buzzer will be reactivated when power is restored to the cooker hood after it has been disconnected from the mains electricity supply or after a power cut.



This cooker hood operates very efficiently and economically. The following will help you to save even more energy when using it:

- Ensure that there is sufficient ventilation in the kitchen when cooking. In extraction mode, if there is insufficient air flow the cooker hood cannot operate efficiently and this causes increased operating noise levels.
- Always cook with the lowest possible setting. This produces fewer cooking vapours, so you can use a lower cooker hood power level and therefore benefit from reduced energy consumption.

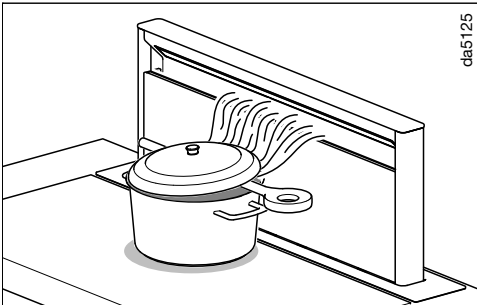

- If strong cooking vapours are produced during cooking, place the cookware as close as possible to the cooker hood.

Cook in covered pots and pans if possible. This prevents heat escaping unnecessarily.

If you are cooking with open pots, put a lid on at an angle. For example, place a cooking spoon between the pot and the lid. The deflection of the cooking vapours in the direction of the extractor ensures optimum extraction.

- Clean or change the filters at regular intervals. Heavily soiled filters reduce performance, increase the risk of fire and are unhygienic.
- Use the Con@ctivity function. The cooker hood will switch on and off automatically at the optimum power level for the cooking you are doing, which ensures low energy consumption.
- If you are operating the cooker hood manually, please note the following:
  - Check the power level selected on the cooker hood. A low power level is usually sufficient. Only use the Booster setting when necessary.
  - When a large volume of cooking vapours are being produced, switch to a high power level in good time. This is more efficient than operating the cooker hood for longer to try to capture cooking vapours which have already been distributed throughout the kitchen.
  - Make sure that you switch the cooker hood off after use. If cooking vapours and odours still need to be removed from the kitchen air after cooking, use the run-on function. The fan will switch off automatically after the selected run-on time.

# Cleaning and care

---

## Housing

### General information

Unsuitable cleaning agents can damage the surfaces and control elements.

Do not use any cleaning agents containing soda, acid, chloride or solvent.

Do not use any abrasive cleaning agents, e.g. powder cleaners or cream cleaners and abrasive sponges, as well as pot scourers or sponges which have been used previously with abrasive cleaning agents.

 Moisture in the cooker hood can cause damage.

Make sure that water does not get into the cooker hood.

- All external surfaces and control elements can be cleaned using hot water with a small amount of washing-up liquid applied with a well wrung-out soft sponge or cloth.
- After cleaning, wipe the surfaces dry using a soft cloth.

### Important information for appliances with stainless steel surfaces

Stainless steel surfaces can be cleaned with a non-abrasive cleaning agent designed specifically for use on stainless steel.

To prevent the surfaces from quickly becoming dirty again, we recommend treating them with a stainless steel care product (available from Miele).

### Important for appliances with glass surfaces

- Glass surfaces can be cleaned using a proprietary non-abrasive cleaning agent designed specifically for use on glass.

## Grease filters and panel for edge extraction

### Fire hazard

Oversaturated grease filters are a fire hazard.

Clean the grease filters at regular intervals.

The edge extraction panel and the reusable metal grease filters in the appliance remove solid particles (grease, dust, etc.) from the kitchen vapours, preventing soiling of the cooker hood.

The grease filters and the panel must be cleaned at regular intervals.

Heavily soiled grease filters hinder air extraction and will lead to increased levels of soiling in the cooker hood and in the kitchen.



## Cleaning interval

The edge extraction panel should be cleaned regularly (at least every 3 - 4 weeks) to avoid a build-up of grease.

The operating hours counter will illuminate the grease filter symbol  to remind you to clean the edge extraction panel and the grease filters regularly.

## Removing the panel and grease filters

### Opening the panel

- With the deflector plate retracted, touch the On/Off switch .
- Touch the lighting control  briefly.

The deflector plate extends.

### Risk of crushing

If you switch off the fan and the lighting when the deflector plate is extended, the deflector plate will automatically retract after 1 minute. Risk of injury. Risk of damage to the opened panel.

To prevent the deflector plate from retracting, leave the lighting switched on.

The panel is held in place by magnets.

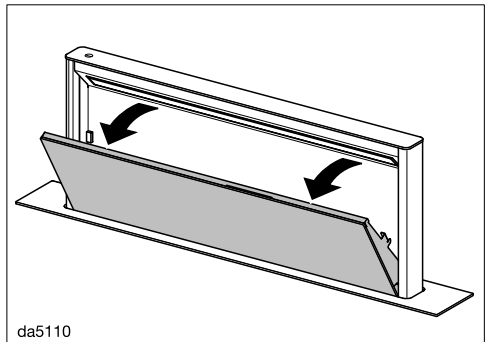

- Pull the top of the panel forwards and swing it open.

# Cleaning and care

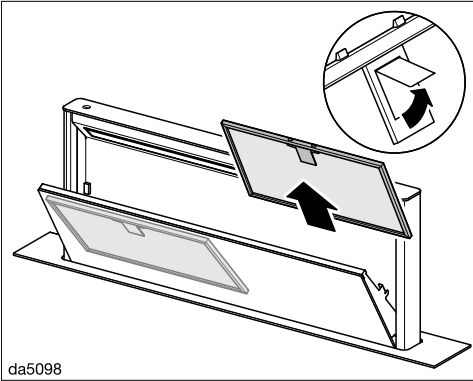

- Open the grease filter retainer catch and remove them.

## Cleaning the grease filters by hand

- Clean the filters with a soft nylon brush in a mild solution of hot water and a small amount of washing-up liquid. Do not use “neat” washing up liquid.

## Unsuitable cleaning agents

Unsuitable cleaning agents can cause damage to the surface of the filters if used regularly.

Do not use:

- cleaning agents containing descaling agents
- powder cleaners, cream cleaners
- aggressive multi-purpose cleaning agents or spray cleaners for grease
- oven sprays

## Cleaning the grease filters in the dishwasher

⚠ Risk of damage due to excessively high temperatures in the dishwasher.

Excessively high temperatures may cause the grease filters to become unusable, if they become deformed, for example.

Select a programme that does not exceed the recommended temperature.

Also follow the information provided in the operating instructions for the dishwasher.

- Place the grease filters upright or at a slight angle in the lower basket. Ensure the spray arm is not obstructed.
- Use a standard household cleaning detergent.
- Select a programme with a maximum wash temperature of 65 °C.

Depending on the detergent used, the internal filter surfaces may become discoloured. This will not affect the functioning of the grease filters in any way.

- After cleaning, leave the filters to dry on an absorbent surface before replacing them.

## Removing the panel

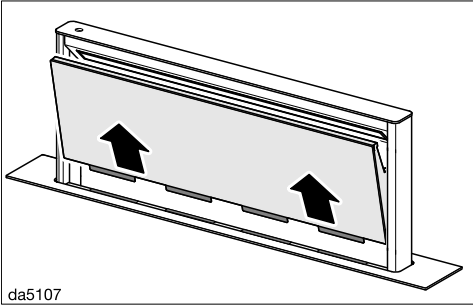

- Pull the opened panel up and out to remove it and place it on a soft surface.

## Cleaning the panel

- Follow the instructions under “Housing”.

The panel is not suitable for cleaning in a dishwasher.

- When removing the panel and filters for cleaning, also clean off any residues of oil or fat from the now accessible parts of the casing to prevent the risk of these catching fire.

## Cleaning the drip tray

Condensate collects in the drip tray underneath the grease filters. The drip tray can be removed for cleaning.

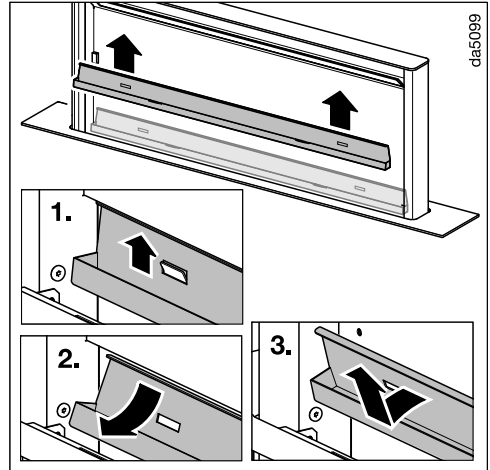

- Carefully pull the drip tray up and out of the holders. Pour away any condensate that has collected in it and then clean the tray with a damp cleaning cloth.

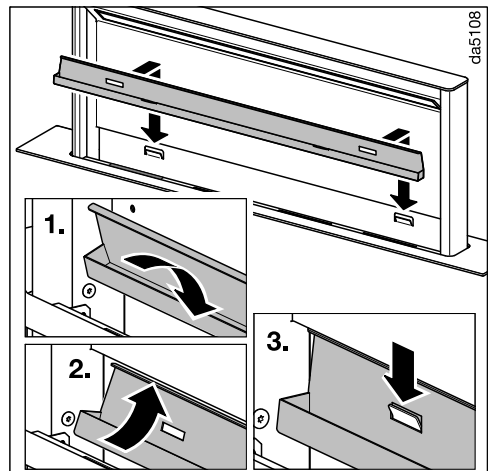

- Hook the drip tray back into the holders after cleaning.

# Cleaning and care

## Inserting the panel

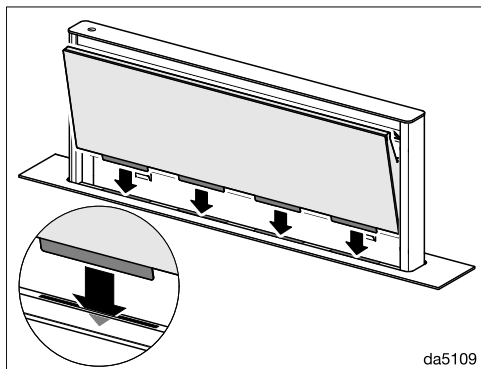

- Insert the panel into the slots on the deflector plate.
- Refit the grease filters, making sure that the latch faces outwards.

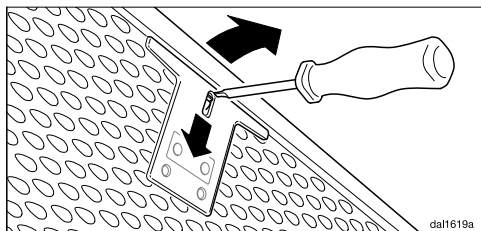

- If a grease filter is inadvertently fitted upside down, insert a small screwdriver blade into the slit to disengage the clip.
- Swing the panel closed until the magnets hold it in place.

## Resetting the grease filter operating hours counter

After cleaning, the operating hours counter needs to be reset.

- With the fan switched on, press the grease filter control  for approx. 3 seconds, until only **1** is flashing.

The grease filter symbol  goes out.

## Replacing the grease filters

Regular usage and cleaning can cause the filter surfaces to become worn.

If you identify any damage, replace the grease filters.

Grease filters are available to order via the Miele Customer Service Department (see end of these operating instructions for contact details) or from your Miele dealer.

## Charcoal filters

With recirculation mode, two charcoal filters must be fitted in addition to the grease filters. These are designed to absorb cooking odours.

Charcoal filters are available to order from your Miele dealer (see end of this booklet for contact details).

The charcoal filters are listed under „Technical data“ at the end of this booklet.

### Fitting/replacing charcoal filters

- Remove the panel and remove the drip tray as previously described.
- Take the charcoal filters out of their packaging.

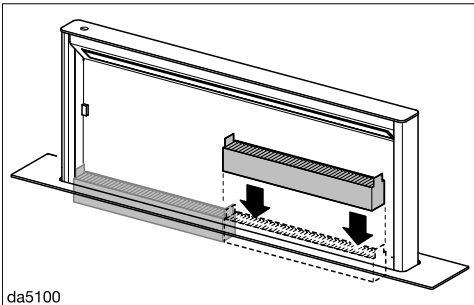

- Insert the charcoal filters into the deflector plate. Make sure the tabs are facing up.
- Refit the drip tray and the panel.

### When to change the charcoal filters

Replace the charcoal filters when they no longer absorb kitchen odours effectively, and at least every 6 months.

The operating hours counter will remind you to replace the charcoal filters by lighting up the charcoal filter symbol .

### Resetting the charcoal filter operating hours counter

After changing the charcoal filters, the operating hours counter needs to be reset.

- With the fan switched on, press the charcoal filter control  for approx. 3 seconds, until only 1 is flashing.

The charcoal filter symbol  will go out.

### Disposing of charcoal filters

- Used charcoal filters can be disposed of with normal household waste.

## Cleaning and care

---

### Reactivatable charcoal filters

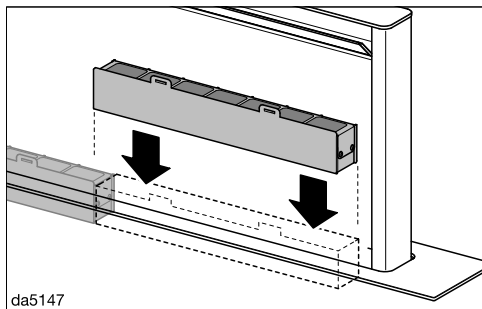

Reactivatable charcoal filters are available for this cooker hood. They can be used several times after being reactivated in the oven.



Please follow the operating instructions supplied with the filters.



## Problem solving guide

Many malfunctions and faults that can occur in daily operation can be easily remedied. You can save time and money in many cases, as you do not need to call the the Miele Dealer.

The following tables are designed to help you to find the cause of a malfunction or a fault and to resolve it.

Issue	Cause and remedy
<b>The deflector plate locks when extended.</b>	<p>The deflector plate is blocked by a heavy object, for example.</p> <p>If the deflector plate is blocked when it is extended, it retracts a little and stops.</p> <ul style="list-style-type: none"><li>■ Touch the On/Off switch .</li></ul> <p>The deflector plate extends and then retracts.</p>
<b>The deflector plate blocks on retraction.</b>	<p>An object has become lodged in the deflector plate.</p> <p>If the deflector plate is blocked during retraction, it extends a little and stops.</p> <ul style="list-style-type: none"><li>■ Touch the On/Off switch .</li><li>■ Switch on the fan or the lighting.</li></ul> <p>The deflector plate extends.</p>

# Service

---

Information to help you rectify faults yourself and about Miele spare parts can be found at [www.miele.com/service](http://www.miele.com/service).

## Contact in case of malfunction

In the event of any faults which you cannot remedy yourself, please contact your Miele dealer.

Contact details for your Miele dealer are given at the end of this document.

Please note that telephone calls may be monitored and recorded for training purposes and that a call-out charge will be applied to service visits where the problem could have been resolved as described in this booklet.

Please quote the model and serial number of your appliance when contacting your Miele dealer. This information can be found on the data plate.

## Position of the data plate

The data plate can be found on the front of the housing.

## Guarantee

For information on the appliance guarantee specific to your country please contact your Miele dealer. See end of this booklet for contact details.

## Before installation

 Before installation, it is important to read the information given on the following pages as well as the “Warning and Safety instructions” at the beginning of this booklet.

## Installation materials



08095672

**6 screws, M4 x 8 mm**



01056271

**8 screws, 4 x 15 mm**



11597030

**2 screws, M4 x 100 mm**

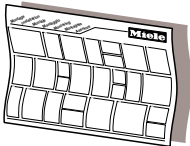

dfha3mie

## Installation plan

See the installation plan for details on the individual steps involved in the installation of this appliance.

# Installation

## Appliance dimensions

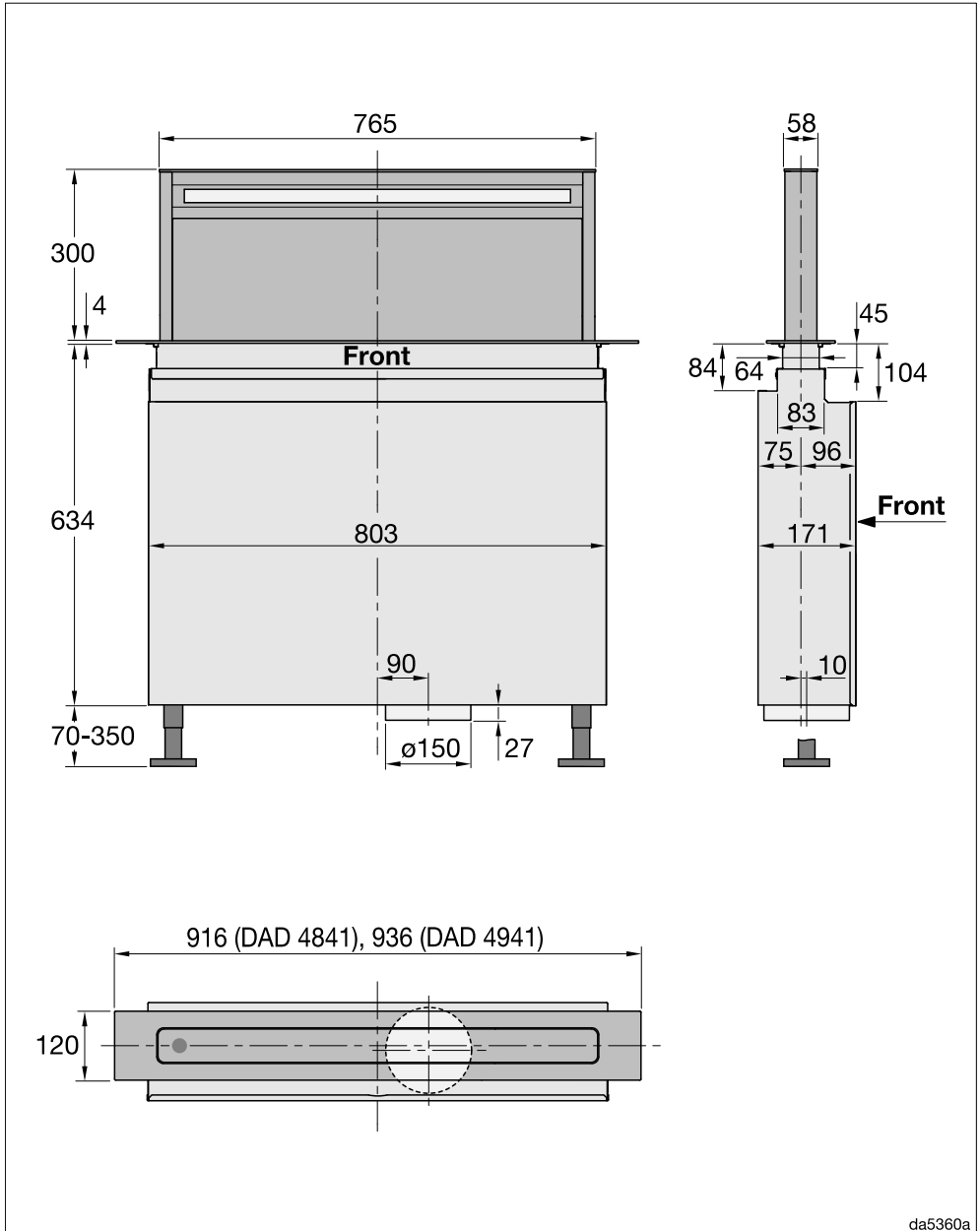

da5360a

## Installation dimensions



Risk of heat damage.

The heat generated by a gas hob may damage the cooker hood.

The cooker hood must not be operated in combination with a gas hob.

If you are planning to install an oven/cooker in front of the appliance, the appropriate installation advice and dimensions regarding cool air circulation must be observed.

Make sure that the installation location is easily accessible. The cooker hood must also be freely accessible and located such that it can be dismantled in the event of future service requirements.

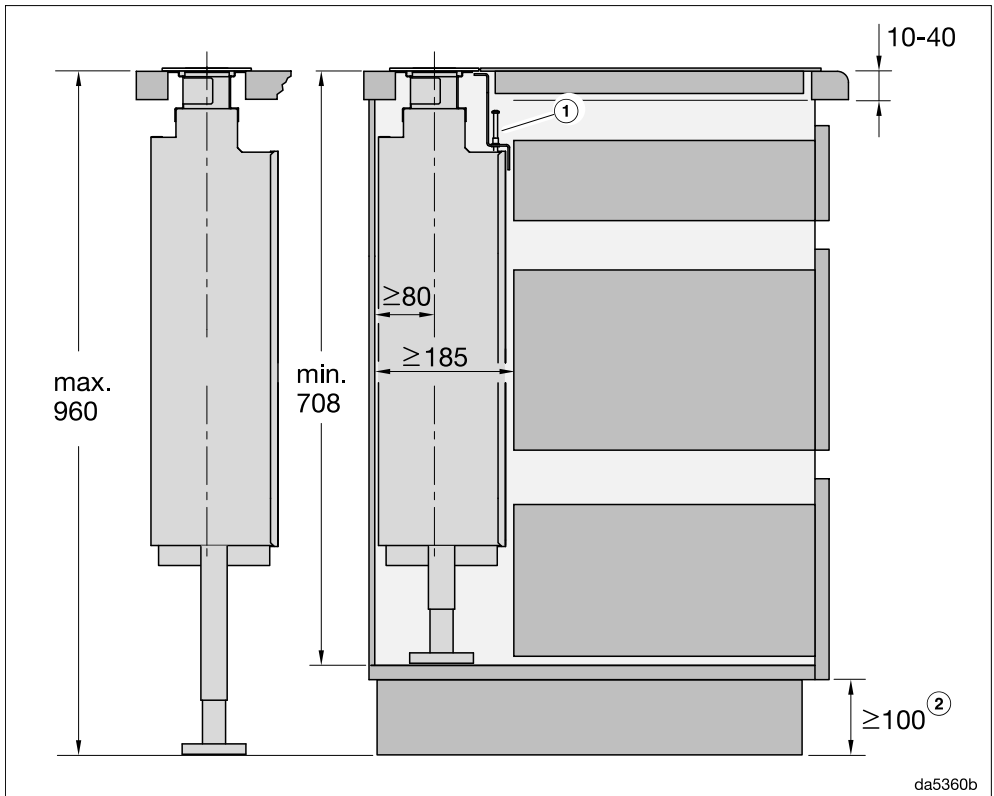

# Installation

Installation of the downdraft extractor and the hob in separate cut-outs

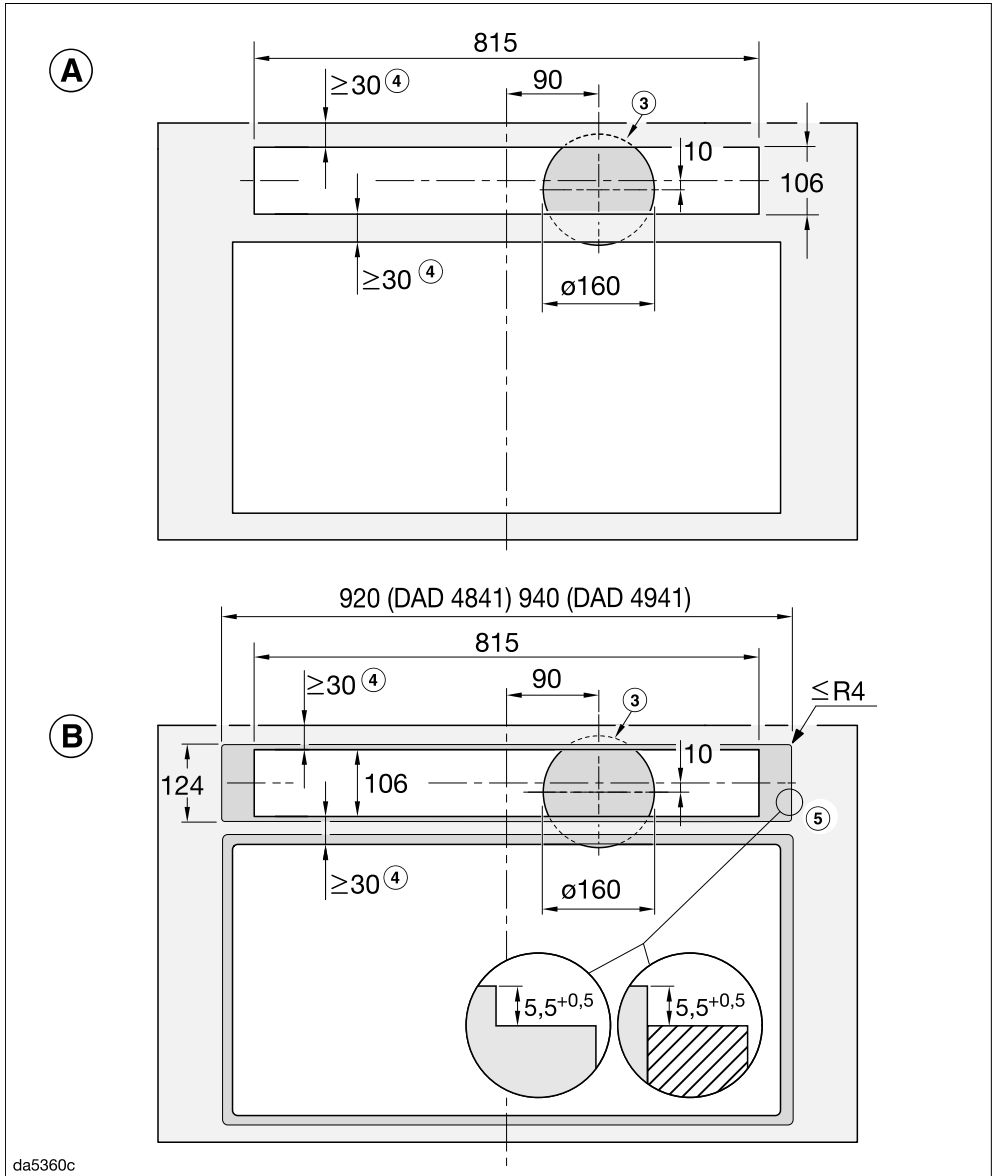

da5360c

- (A) Surface-mounted installation
- (B) Flush-fit installation

Side-by-side installation of the downdraft extractor and the hob in the same cut-out

Example: combination with KM 7697 FL or KM 7594 FL

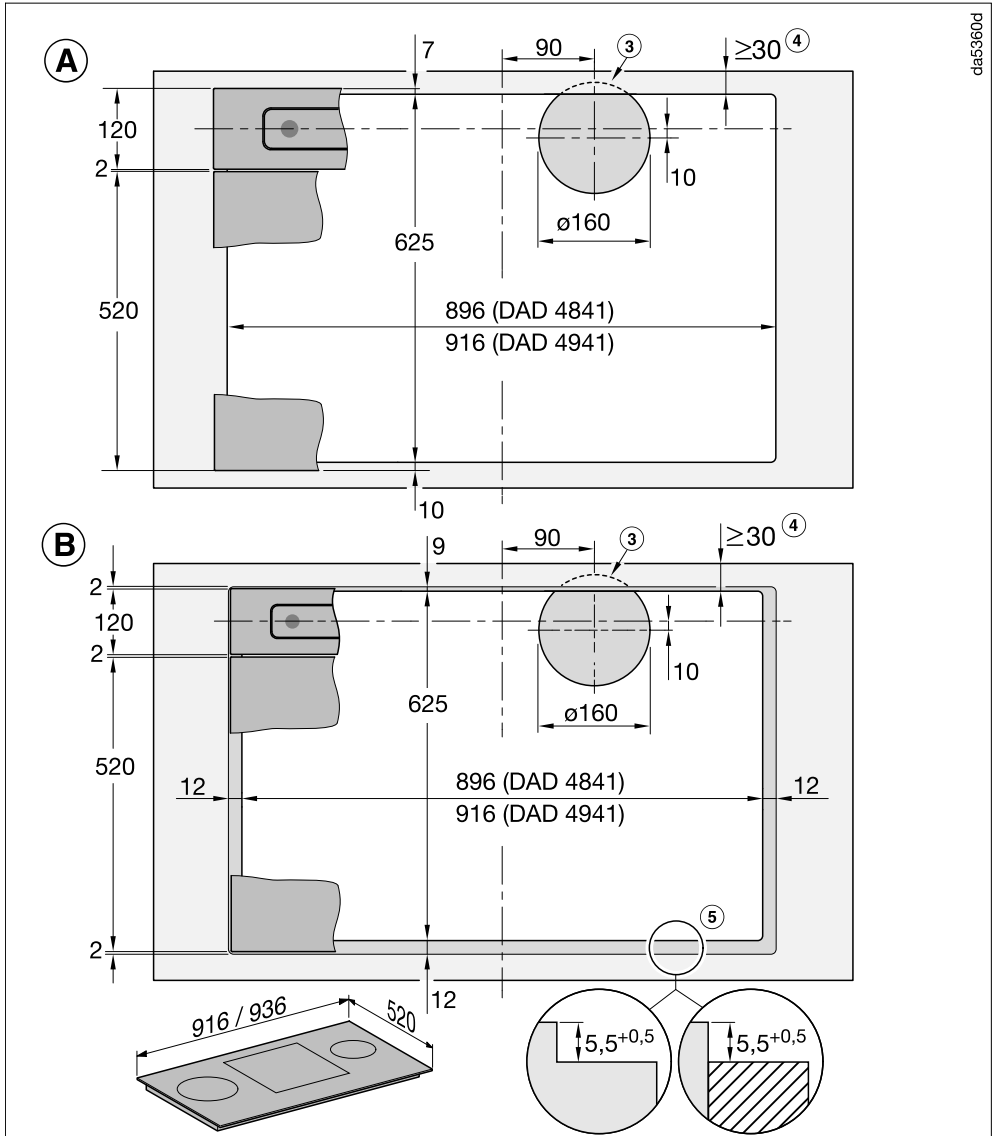

das5360d

- (A) Surface-mounted installation
- (B) Flush-fit installation

# Installation

Side-by-side installation of the downdraft extractor and the hob in the same cut-out

Example: combination with KM 7684 FL or KM 7689 FL

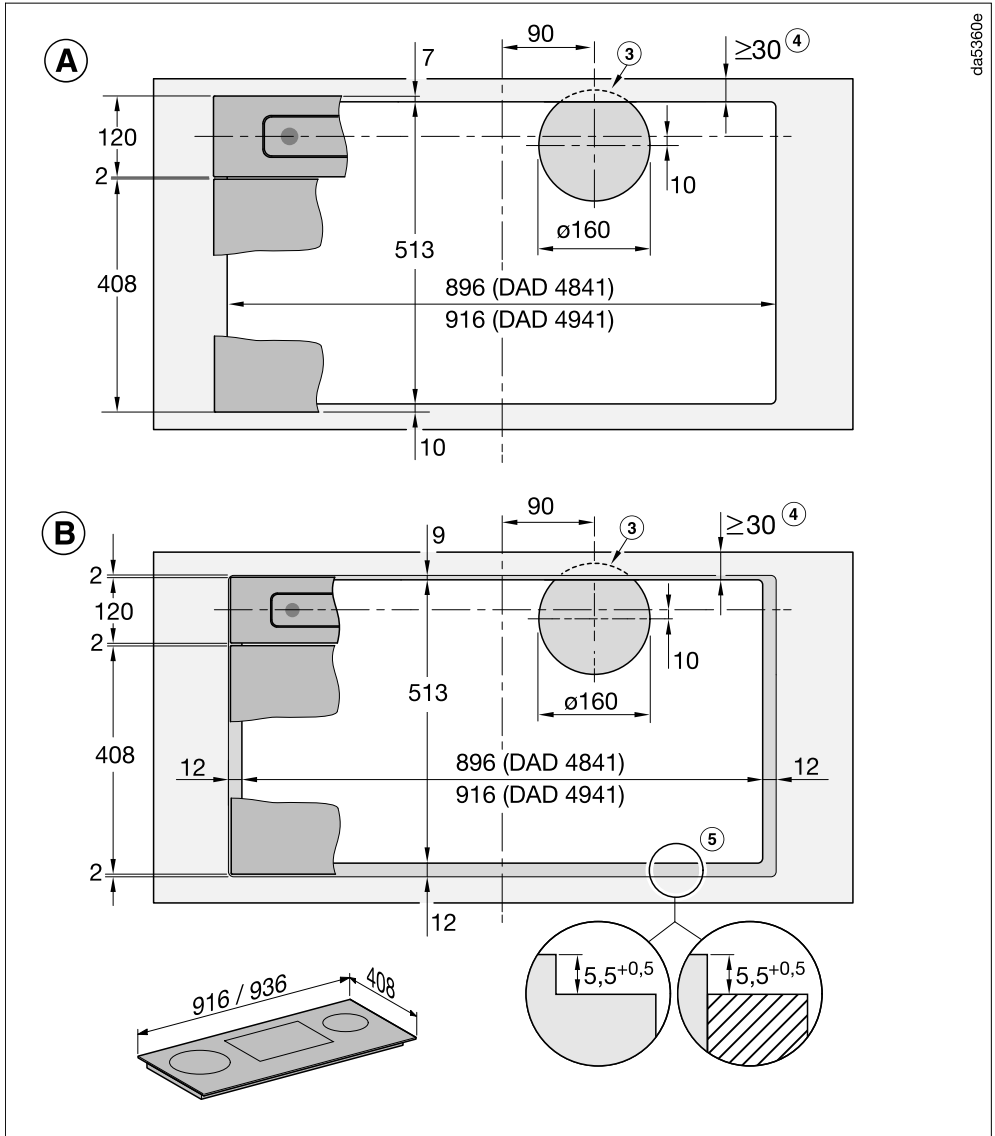

- ① Surface-mounted installation
- ② Flush-fit installation



- ① If you install the downdraft extractor and the hob flush-fit against each other in the same cut-out, you must use the enclosed angle trim.
- ② The minimum dimension is required if flat ducting is laid under the cabinets or the DUU 600 recirculation box is used.
- ③ Cut-out for exhaust ducting in unit floor
- ④ Ensure that the worktop is sufficiently stable.
- ⑤ Stepped cut-out for flush-fit installation in a worktop. Note the different milling widths for the hob and the downdraft extractor. Instead of a stepped cut-out, a wooden frame (not supplied) that has been moved downwards by 5.5 mm can be installed as an alternative.

Exhaust duct  $\varnothing$  150 mm.

See also the operating and installation instructions for the hob for more information.

# Installation

## Installation examples

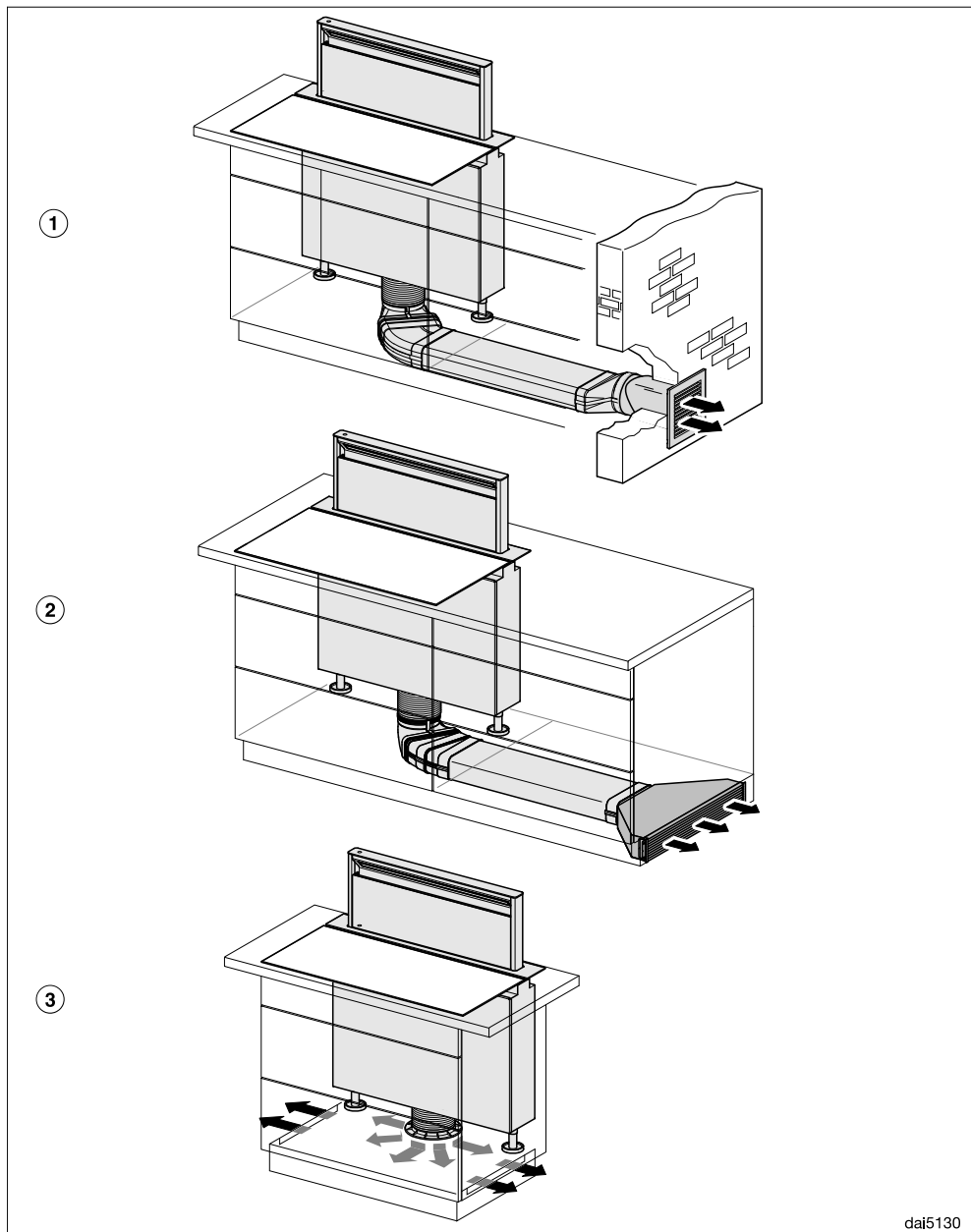

dai5130

- ① Extraction mode with flat ducting and DMK 150-1 wall box
- ② Recirculation mode with flat ducting and DUU 600 recirculation box
- ③ Plug&Play operation with DUP 150 conversion kit  
During Plug&Play operation, ensure sufficient ventilation of the plinth area, e.g. through gaps in the plinth panel.  
The cross-section of the openings must be at least 425 cm<sup>2</sup> in total. If the floor meets the ground or is exposed to outside air, the heat transfer coefficient of the floor must not exceed 0.5 W/(m<sup>2</sup> K).  
The electronic module for vapour extraction must be switched to Plug&Play operation, see “Before using for the first time” – “Setting up Plug&Play”.

## Sealing the gaps

 Damage from unsuitable sealant. Unsuitable sealant can damage natural stone.

For natural stone worktops and natural stone tiles, only use silicone sealant that is specially formulated for natural stone. Follow the manufacturer's instructions.

- Use a silicone sealant that is heat-resistant to at least 160 °C to seal the gap between the downdraft extractor and worktop (flush-fit installation) or between the downdraft extractor and hob (side-by-side installation).

# Installation

## Connection for air extraction

Only use smooth pipes or flexible exhaust ducting made from approved non-flammable materials for exhaust ducting.

To achieve the most efficient air throughput with the lowest noise levels, please note the following:

- The diameter of the exhaust ducting must not be smaller than the cross-section of the exhaust duct (see "Appliance dimensions"). This applies in particular when using flat ducting.
- The exhaust ducting should be as short and straight as possible.
- Only use wide radius bends.
- The exhaust ducting must not be kinked or compressed.
- All connections must be strong and airtight.
- If the exhaust ducting has flaps, these must be opened whenever the cooker hood is switched on.

Any constriction of the air throughput will reduce extraction performance and increase operating noise.

## Flue

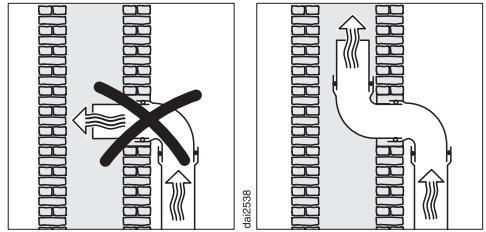

If the exhaust air is to be ducted into a flue, the ducting must be directed in the flow direction of the flue.

If the flue is used by several ventilation units, the cross-section of the flue must be large enough.

## Non-return flap

- Use a non-return flap in the exhaust system.

A non-return flap ensures that when the cooker hood is not in operation, the duct is closed to prevent unwanted exchange of room air and outside air.

If the exhaust is ducted through an outside wall, a Miele wall vent or roof vent (available as an optional accessory) is recommended. Both of these have a built-in non-return flap.

Miele shall not accept warranty claims for any functional defects or damage caused by inadequate exhaust ducting.

## Electrical connection

The cooker hood is supplied with a mains cable with moulded plug ready for connection to a suitable earthed socket.

If the socket is not easily accessible or a fixed connection is envisaged, ensure that a suitable means of disconnection is provided on the installation side for each pole.

 Risk of fire from overheating. Connecting the cooker hood to multi-socket adapters or extension cables can overload the cables. For safety reasons, do not use an extension cable or multi-socket adapter.

The electrical system must comply with local and national safety regulations (BS 7671 in the UK).

For safety reasons, we recommend using a type  residual current device (RCD) in the relevant electrical installation for connecting the cooker hood.

If the mains connection cable is damaged, it must only be replaced with a specific mains connection cable of the same type (available from the Miele Customer Service Department). For safety reasons, such replacement may only be carried out by a qualified specialist or the Miele Customer Service Department.

These operating instructions and the data plate indicate the nominal power consumption and the appropriate fuse rating. Compare this information with the data of the on-site electrical

connection.

If in any doubt, consult a qualified electrician.

Temporary or permanent operation on an autonomous power supply system or a power supply system that is not synchronised with the mains power supply (e.g. island networks, back-up systems) is possible. A prerequisite for operation is that the power supply system complies with the specifications of EN 50160 or an equivalent standard. The function and operation of the protective measures provided in the domestic electrical installation and in this Miele product must also be maintained in isolated operation or in operation that is not synchronised with the mains power supply, or these measures must be replaced by equivalent measures in the installation. As described, for example, in the current version of VDE-AR-E 2510-2.

## Technical data

Fan motor	180 W
Deflector plate motor	60 W
Hob lighting	11.2 W
Total rated load	251.2 W
Mains voltage, frequency	AC 230 V, 50 Hz
Fuse rating	10 A
Length of mains connection cable	1.5 m
Weight	34 kg

### WiFi module

Frequency band	2.400–2.4835 GHz
Maximum transmission power	< 100 mW

### Optional accessories for recirculation mode

Charcoal filter set DKF 30-P or DKF 30-R (reactivatable). The sets contain 2 charcoal filters.

You need the DUP 150 installation kit for Plug&Play operation. The kit contains a socket, a hose and the DKF 30-P charcoal filter set.

Miele hereby declares that this cooker hood complies with Directive 2014/53/EU.

Miele hereby declares that this downdraft extractor complies with UK Radio Equipment Regulations 2017, as amended.

### Note for test institutes

Energy efficiency must be calculated using extraction mode. The cooker hood is set up ex-works for recirculation mode. To re-set it for extraction mode the operating hours counter for the charcoal filter(s) has to be deactivated (see “Before using for the first time”).

**Miele in Saudi Arabia:**

**Awad Badi Nahas Trading Co. Ltd.**

Medina Road, P.O. Box 11529  
Jeddah 21463  
Kingdom of Saudi Arabia  
Tel. +966 12 2560888  
Hotline for customer care 920003240  
(Sat – Thu; 8 am – 5 pm)  
Fax +966 12 2560555  
E-mail: info@awadnahas.com  
Website: www.awadnahas.com

**Miele in United Arab Emirates:**

**Miele Appliances Ltd.**

Showroom 1 Eiffel 1 Building  
Sheikh Zayed Road, Umm Al Sheif  
P.O. Box 114782 - Dubai  
United Arab Emirates  
Tel. +971 4 3044 999  
Fax +971 4 3418 852  
800-MIELE (64353)  
E-mail: info@miele.ae  
Website: www.miele.ae  
Webshop: shop.miele.ae

**Miele in Kuwait:**

**Al Wazzan United Trading Co.**

P. O. Box : 3379 Hawally 32034  
Kuwait  
Tel. 00965-22001010  
Fax 00965-24838292  
E-mail: mail@alwazzanunited.com  
Website: www.alwazzanunited.com

**Miele in Egypt:**

**B.Tech for Trade and Distribution**

Ramses Extension, 6th Zone,  
Nasr City - Cairo  
Egypt  
Tel. +202 23480700/15  
Customer service contact: 15997  
Fax +202 23426076  
E-mail: info@btech.com  
Website: www.mieleegypt.com

**Manufacturer:** Miele & Cie. KG, Carl-Miele-Straße 29, 33332 Gütersloh, Germany

DAD 4841, DAD 4941

en-SA

M.-Nr. 12 477 770 / 00