



Operating and installation instructions Refrigerators



To avoid the risk of accidents or damage to the appliance it is **essential** to read these instructions before it is installed and used for the first time.

Contents

Warning and Safety instructions	5
Sustainability and environmental protection	13
Caring for the environment	13
How to save energy	14
Familiarisation	16
Guide to the appliance	16
K 4002	16
K 4003	17
Display	18
Operating the refrigeration appliance via the display	19
Operation	20
Briefly touching the  symbol	20
Touching and holding the  symbol for 3 seconds	20
Touching and holding the  symbol for 7 seconds	20
Main menu	20
Sub-menu	20
Display idle mode	20
LED indicators	20
Safety	21
Lock function	21
Door alarm	21
Appliance functions	22
Miele@home @	22
SuperCool ❄️	22
Sabbath mode	23
Factory defaults	24
Demo mode	24
Adjusting the interior fittings	24
Moving the door shelf/bottle shelf	24
Clipping the egg trays on	24
Adjusting or removing the bottle holder	24
Moving the adjustable shelves	25
Moving the split shelf	25
Moving a split shelf	26
Commissioning	27
Before using for the first time	27
Switching on and off	27
Switching the refrigeration appliance on	27
Switching off the refrigeration appliance	27
To note when switching off for longer periods of time	28

Operation	29
Setting the temperature	29
Switching on SuperCool ❄️	29
Switching off SuperCool ❄️	29
Storing food in the fridge zone	30
Different storage zones	30
Food which is not suitable for storage in the refrigerator section	31
Notes on buying food	31
Storing food correctly	31
Storing food in the DailyFresh drawer	32
Freezing and storing food	34
Freezing fresh food	34
Using the freezer compartment	34
Storing frozen food	34
Home freezing	34
Cooling drinks quickly	35
Making ice cubes	35
Defrosting	36
Good to know	39
The correct temperature	39
Storage time for frozen food	39
Adjusting settings	40
Switching the lock function on	40
Switching the lock function off	40
Switching Sabbath mode on	40
Switching Sabbath mode off	40
Resetting the settings to their factory default settings	40
Activating the WiFi connection	41
Deactivating the WiFi connection	41
Switching on demo mode	41
Switching off demo mode	41
Exiting service mode	42
Cleaning and care	43
Cleaning agents	43
Preparing the refrigeration appliance for cleaning	44
Cleaning the inside of the appliance	44
Cleaning accessories by hand or in the dishwasher	44
Removing and dismantling accessories for cleaning	45
Cleaning the front of the appliance and the side panels	46
Cleaning the door seal	46
Cleaning the ventilation gaps	46
Cleaning the compressor and metal grille at the back of the appliance	46

Contents

Troubleshooting	47
Noises	51
Customer Service Department	53
Contact in the event of a fault	53
EPREL database	53
Warranty	53
Optional accessories	54
Installation	55
Installation site	55
Climate range	55
Ventilation requirements	56
Installing several refrigeration appliances.....	57
Changing the door hinging	57
Fitting supplied wall spacers	59
Setting up the refrigeration appliance	59
Aligning the refrigeration appliance.....	60
Integrating the refrigeration appliance in a run of kitchen units	60
Building under	62
Appliance dimensions.....	63
Installation dimensions/View from above	63
Connections	64
Electrical connection	65
EU Conformity declaration	66
UK Conformity declaration	67
Copyrights and licences	68

Warning and Safety instructions

This refrigeration appliance complies with current safety requirements. Inappropriate use can, however, lead to personal injury and material damage.

Please read the operating and installation instructions carefully before using the refrigeration appliance for the first time. They contain important information on safety, installation, use and maintenance. This is to protect yourself from injury, and from damaging your refrigeration appliance.

In accordance with standard IEC 60335-1, Miele expressly and strongly advises that you read and follow all information provided on installing the refrigeration appliance, as well as the safety notes and warnings.

Miele cannot be held liable for injury or damage caused by non-compliance with these instructions.

Keep these operating and installation instructions in a safe place and pass them on to any future owner.

Correct application

► This refrigeration appliance is intended for use in the home and in similar environments, for example

- in shops, offices and similar work settings
- by the guests in hotels, motels, bed & breakfasts and other typical home settings.

This refrigeration appliance is not intended for outdoor use.

► This appliance is intended for domestic use only for cooling and storing food and drink as well as for storing deep frozen food, freezing fresh food and for making ice.

Any other usage is not supported by the manufacturer and could be dangerous.

Warning and Safety instructions

▶ This refrigeration appliance is not suitable for storing and keeping cool medicines, blood plasma, laboratory preparations or similar substances or products that are subject to the Medical Device Directive. Incorrect use of the refrigeration appliance for such purposes may cause deterioration of the items stored. The refrigeration appliance is also not suitable for use in areas where there is a risk of explosion.

Miele cannot be held liable for damage caused by improper or incorrect use or operation of the appliance.

▶ The appliance can only be used by people with reduced physical, sensory or mental capabilities, or lack of experience and knowledge, if they are supervised whilst using it, or have been shown how to use it in a safe way and recognise and understand the consequences of incorrect operation.

Safety with children

▶ Children under 8 years of age must be kept away from the refrigeration appliance unless they are constantly supervised.

▶ Children 8 years and older may only use the appliance unsupervised if they have been shown how to use it in a safe way and recognise and understand the consequences of incorrect operation.

▶ Children must not be allowed to clean or maintain the appliance unsupervised.

▶ Please supervise children in the vicinity of the appliance and do not let them play with it.

▶ Danger of suffocation! Whilst playing, children could become entangled in packaging (such as plastic wrapping) or pull it over their head and suffocate. Keep packaging material away from children.

Technical safety

▶ The coolant circuit has been checked for leaks. The refrigeration appliance complies with statutory safety requirements and the appropriate EU directives.



Warning and Safety instructions

▶ **Warning:** fire hazard/flammable materials. This symbol is on the compressor and indicates flammable materials. Do not remove this sticker.

The refrigerant inside the appliance (details on the data plate) is environmentally friendly but flammable.

The use of this refrigerant does, however, sometimes lead to a slight increase in the noise level of the appliance. In addition to the noise of the compressor, you might be able to hear the refrigerant flowing around the cooling circuit. Unfortunately, this cannot be avoided, but it does not affect the performance of the refrigeration appliance.

When transporting and installing the refrigeration appliance, ensure that no parts of the cooling circuit are damaged. Splashes of refrigerant can damage the eyes and leaking refrigerant can ignite.

In the event of damage:

- Avoid naked flames or anything which creates a spark.
- Disconnect the refrigeration appliance from the mains electricity supply.
- Ventilate the room where the refrigeration appliance is located for several minutes.
- Contact the Miele Customer Service Department.

▶ The more refrigerant there is in a refrigeration appliance, the larger the room it should be installed in. In the event of a leakage, if the appliance is in a small room, there is the danger of a combustible gas/air mixture building up. For every 8 g of refrigerant at least 1 m³ of room space is required. The amount of refrigerant in the refrigeration appliance is stated on the data plate inside the appliance.

▶ To avoid the risk of damage to the appliance, make sure that the connection data (fuse rating, frequency and voltage) on the data plate corresponds to the household supply.

Check that this is the case before connecting the appliance. Consult a qualified electrician if in any doubt.

▶ The electrical safety of this appliance can only be guaranteed when correctly earthed. It is essential that this standard safety requirement is met. If in any doubt please have the electrical installation tested by a qualified electrician.

Warning and Safety instructions

► Temporary or permanent operation on an autonomous power supply system or a power supply system that is not synchronised with the mains power supply (e.g. island networks, back-up systems) is possible. A prerequisite for operation is that the power supply system complies with the specifications of EN 50160 or an equivalent standard.

The function and operation of the protective measures provided in the domestic electrical installation and in this Miele product must also be maintained in isolated operation or in operation that is not synchronised with the mains power supply, or these measures must be replaced by equivalent measures in the installation. As described, for example, in the current version of BS OHSAS 18001–2 ISO 45001.

► If the electrical connection cable supplied is damaged, it must only be replaced by an original spare part to prevent a hazard for the user. Miele can only guarantee the safety of the appliance when original Miele spare parts are used. For safety reasons, such replacement may only be carried out by a qualified specialist or the Miele Customer Service Department.

► Do not connect the appliance to the mains electrical supply by a multi-socket adapter or extension lead. These are a fire hazard and do not guarantee the required safety of the appliance.

► If moisture gets into electrical components or into the mains connection cable, it could cause a short circuit. Therefore, do not operate this refrigeration appliance in areas which are exposed to moisture (e.g. in a garage or utility room).

► This appliance must not be used in a non-stationary location (e.g. on a ship).

► Do not use a damaged appliance. It could be dangerous. Check the appliance for visible signs of damage.

► This refrigeration appliance is not intended for use as a built-in appliance.

► The appliance must be isolated from the electricity supply during installation, maintenance and repair work.

► Unauthorised installation, maintenance and repairs can cause considerable danger for the user.

Installation, maintenance and repairs must only be carried out by a Miele authorised technician.

Warning and Safety instructions

- ▶ While the appliance is under warranty, repairs should only be undertaken by a Miele authorised service technician. Otherwise the warranty is invalidated.
- ▶ Faulty components must only be replaced with genuine Miele original spare parts. Miele can only guarantee the safety standards of the appliance when Miele replacement parts are used.
- ▶ This refrigeration appliance is supplied with a special lamp to cope with particular conditions (e.g. temperature, moisture, chemical resistance, abrasion resistance and vibration). This lamp must only be used for the purpose for which it is intended. The lamp is not suitable for room lighting. Replacement lamps may only be fitted by a Miele authorised technician or by the Miele Customer Service Department. This refrigeration appliance contains several light sources with at least energy efficiency class G.

Proper installation

- ▶ Always wear protective gloves when transporting and installing the refrigeration appliance.
- ▶ Two people are required to install the refrigeration appliance.

Correct use

- ▶ This refrigeration appliance is designed for use within specific ambient temperatures (climate range). Do not use in ambient temperatures for which it is not designed. The climate range is stated on the data plate in the interior cabinet of the refrigeration appliance. A lower ambient temperature will cause the compressor to switch off for longer periods, meaning that the refrigeration appliance is unable to maintain the required temperature.
- ▶ Do not cover or block the air vents as this could impair the efficiency of the appliance, increase the electricity consumption and could cause damage to the components.
- ▶ The refrigeration appliance lid has a plastic edge. Make sure that no oil or grease leaks onto this edge as this could cause stress cracks in the plastic and cause it to break or split.
- ▶ If storing food which contains a lot of fat or oil in the appliance or the door, make sure that it does not come into contact with plastic components as this could cause stress cracks or break the plastic.

Warning and Safety instructions

- ▶ Risk of fire and explosion. Do not store explosive materials in the refrigeration appliance or any products containing propellants (e.g. spray cans). Electrical components can cause flammable mixes of gases to ignite.
- ▶ Danger of explosion. Do not operate any electrical equipment (e.g. an electric ice-cream maker) inside the refrigeration appliance.
Danger of sparking and explosion.
- ▶ Danger of injury and damage to the appliance. Do not store cans or bottles containing carbonated drinks or liquids which could freeze in the freezer compartment. Otherwise they could burst.
- ▶ Danger of injury and damage to the appliance. When chilling drinks in the freezer section, make sure that bottles are not left in for more than one hour. Otherwise they could burst.
- ▶ Danger of injury. Never handle frozen food or the metal parts of the appliance with wet hands. Your hands may freeze to the frozen food or to the metal.
- ▶ Danger of injury. Do not take ice cubes out with your bare hands and never place ice cubes or ice lollies in your mouth straight from the freezer compartment.
The very low temperature of the frozen food could cause frost burn to the lips and tongue.
- ▶ Do not refreeze partially or fully defrosted food. Consume defrosted food as soon as possible, as it will lose its nutritional value and spoil if left for too long. Defrosted food may only be re-frozen after it has been cooked.
- ▶ Observe the manufacturer's "use-by" dates and storage instructions given on food to avoid the risk of food poisoning. Storage times will depend on several factors, including the freshness and quality of the food, as well as the temperature at which it is stored.

Accessories and spare parts

- ▶ Only use original Miele accessories. If other parts are used, warranty, performance and product liability claims will be invalidated.
- ▶ Miele will guarantee to supply functional spare parts for a minimum of 10 years and up to 15 years following the discontinuation of your refrigeration appliance.

Cleaning and care

- ▶ Do not use any oils or grease on the door seals, as these will cause the seals to deteriorate and become porous with time.
- ▶ Do not use a steam cleaning appliance to clean or defrost this appliance.
Steam could reach electrical components and cause a short circuit.
- ▶ **WARNING! DANGER of injury and damage!** Do not use any mechanical or other types of aids which are not recommended by the manufacturer to accelerate the defrosting process.
- ▶ Sharp edged or pointed objects will damage the evaporator, causing irreversible damage to the appliance. Do not use sharp edged or pointed objects to
 - remove frost and ice,
 - separate frozen food or remove ice trays.
- ▶ Do not place electric heaters or candles in the appliance to defrost it. These can damage the plastic parts.
- ▶ Do not use defrosting sprays or de-icers, as they could contain substances which could damage the plastic parts or which might cause the build-up of gases and pose a danger to health.

Transporting the appliance

- ▶ Always transport the appliance in an upright position and in its original transport packaging to avoid damage in transit.
- ▶ Danger of injury and damage to the appliance. The refrigeration appliance is very heavy and must be transported by two people.

Disposing of your old appliance

- ▶ Children playing could become trapped in the appliance and could suffocate.
 - Remove the appliance doors.
 - Remove the drawers.
 - Leave the adjustable shelves in the refrigeration appliance so children cannot climb inside.
 - If your old refrigeration appliance has a door lock, destroy it. This will prevent the risk of children playing accidentally locking themselves in and endangering their lives.

Warning and Safety instructions

▶ Risk of electric shock!

- Cut the plug off the mains connection cable.
- Cut the mains connection cable off the old appliance.

▶ Dispose of the plug and mains connection cable separately from the old appliance.

▶ During and after disposal, make sure that the refrigeration appliance is not placed near petrol or other flammable gases and liquids.

▶ Risk of fire due to escaping oil or refrigerant!

The refrigerant and oil inside the appliance are flammable. In high enough concentrations, escaping refrigerant or oil may ignite if they come into contact with an external heat source.

During disposal, make sure that the cooling circuit is not damaged in order to prevent refrigerant and oil escaping in an uncontrolled manner (see the data plate for details of the refrigerant).

▶ Splashes of coolant can damage the eyes. Be careful not to damage any part of the pipework whilst awaiting disposal, e.g. by

- puncturing the coolant channels in the condenser,
- bending any pipework, or
- scratching the surface coating.

Symbol on the compressor (depending on model)

This information is only relevant for recycling. There is no risk during normal operation.



▶ The oil in the compressor can be fatal if swallowed or if it penetrates the airways.

Sustainability and environmental protection

Caring for the environment

Disposing of the packaging material

The packaging material is used for handling and protects the appliance from transport damage. The packaging material used is selected from materials which are environmentally friendly for disposal and can generally be recycled.

Recycling the packaging material reduces the use of raw materials. Use material-specific collection points for valuable materials and take advantage of return options. Your Miele dealer will take the packaging material away.

Disposing of your old appliance

Electrical and electronic appliances contain many valuable materials. They also contain certain materials, compounds and components which were essential for their correct functioning and safety. These could be hazardous to human health and to the environment if disposed of with household waste or if handled incorrectly. Please do not, therefore, dispose of your old appliance with household waste.



Take care not to damage your refrigeration appliance before or during disposal in an authorised, environmentally friendly manner. This is to ensure that refrigerant in the cooling circuit and oil in the compressor is contained, and will not leak into the environment.

Instead, please make use of officially designated collection and disposal points to dispose of and recycle electrical and electronic appliances in your local community, with your dealer or with Miele, free of charge. By law, you are solely responsible for deleting any personal data from the old appliance prior to disposal. You are legally obliged to remove any old batteries which are not securely enclosed by the appliance and to remove any lamps without destroying them, where this is possible. These must be taken to a suitable collection point where they can be handed in free of charge. Please ensure that your old appliance poses no risk to children while being stored for disposal.

Sustainability and environmental protection

How to save energy ...

- Installation site** The refrigeration appliance has to cool more often at higher ambient temperatures and consumes more energy in the process. Therefore, you should:
- Install the refrigeration appliance in a well-ventilated room.
 - Do not install the refrigeration appliance near to a heat source (heater element, cooker).
 - Protect the refrigeration appliance from direct sunlight.
 - Ensure an ideal ambient temperature of 20 °C.
 - Clean the ventilation gaps on a regular basis to remove any dust.
 - Dust the compressor and the metal grille (heat exchanger) at the back of the refrigeration appliance at least once a year.
- Temperature setting** The colder the temperature, the higher the energy consumption. The following settings are recommended:
- 4 to 5 °C in the refrigerator section.
 - Freezer compartment -18 °C.
- Use** Energy consumption is increased by heat input and impeded air circulation. Therefore, you should:
- Only open the appliance door(s) when necessary and for as short a time as possible. Arrange the food in such a way that makes it easy to find in the appliance.
 - Always close the appliance door(s) properly after opening them.
 - Allow hot food and drinks to cool down before placing them in the refrigeration appliance.
 - Store food well packaged or covered.
 - Do not overfill the compartments to allow air to circulate.
 - Keep drawers and shelves arranged as they were when the appliance was delivered.

Sustainability and environmental protection

- Place frozen food in the fridge zone to defrost.

Defrosting

A layer of ice hinders the cold from reaching the frozen food. Therefore, you should:

- Defrost the freezer compartment when a layer of ice max. 0.5 cm thick has built up.

Familiarisation

Guide to the appliance

K 4002

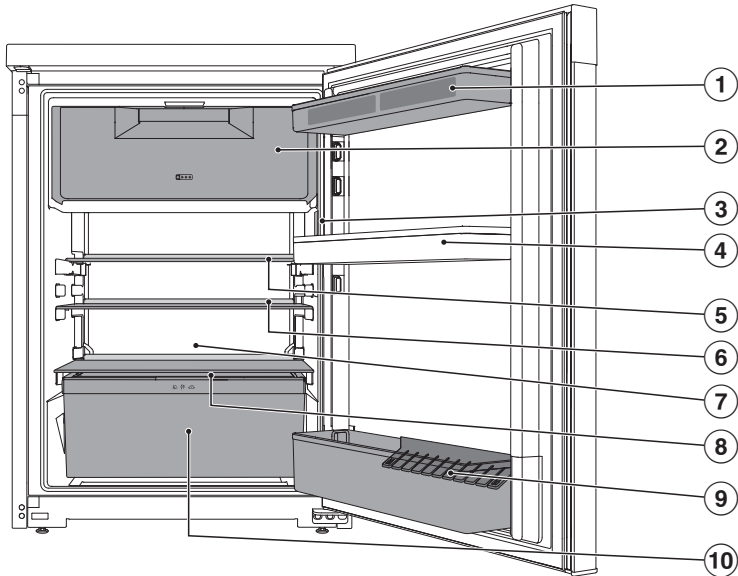

- ① Shelf with egg tray in the appliance door
- ② Freezer compartment
- ③ Display
- ④ Shelves in the appliance door
- ⑤ Split shelf (FlexiBoard)
- ⑥ Adjustable shelf
- ⑦ Condensate channel and drain hole
- ⑧ Compartment lid for setting the humidity level in the DailyFresh drawer
- ⑨ Bottle shelf with bottle holder
- ⑩ DailyFresh drawer for fruit and vegetables (humidity-controlled)

K 4003

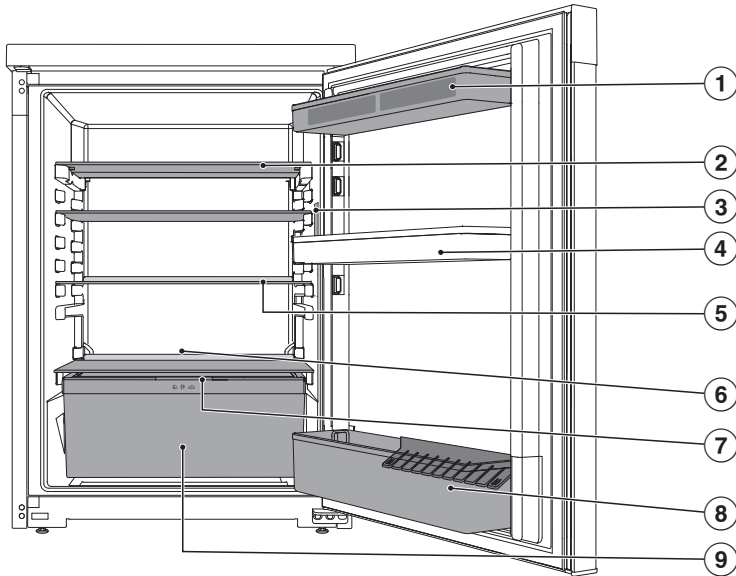

- ① Shelf with egg tray in the appliance door
- ② Split shelf (FlexiBoard)
- ③ Display
- ④ Shelves in the appliance door
- ⑤ Adjustable shelf
- ⑥ Condensate channel and drain hole
- ⑦ Compartment lid for setting the humidity level in the DailyFresh drawer
- ⑧ Bottle shelf with bottle holder
- ⑨ DailyFresh drawer for fruit and vegetables (humidity-controlled)

Familiarisation

Display

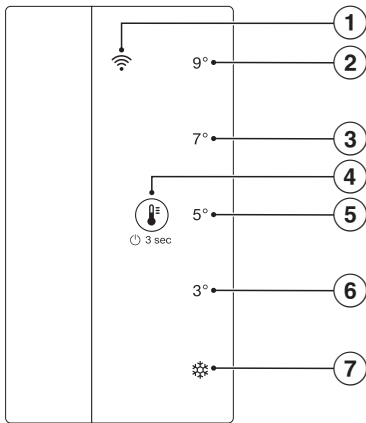

The display can be scratched by pointed or sharp objects, e.g. pens. Only touch the display with your fingertips.

It is possible that the display will not react to finger contact if your fingers are cold.



- ① WiFi LED
- ② 9 °C LED
- ③ 7 °C LED
- ④ Control symbol
- ⑤ 5 °C LED
(sub-menu:
back to factory default settings)
- ⑥ 3 °C LED
(sub-menu: Sabbath mode)
- ⑦ SuperCool
(sub-menu: lock function)

Operating the refrigeration appliance via the display

- Touch and hold the  symbol for 3 seconds to switch on the refrigeration appliance.
- Touch the  symbol a few times in succession to activate the LEDs in the main menu and in the sub-menu.

The LED for the selected temperature or function lights up.

- Touch and hold the  symbol for 7 seconds to switch from the main menu to the sub-menu.



If 5 seconds pass without a function being selected, the display will return to the main menu.

When a function is selected in the sub-menu, the corresponding LED lights up.

- Touch and hold the  symbol for 3 seconds to exit the sub-menu and return to the main menu.

Familiarisation

Operation

The refrigeration appliance is operated using the  symbol on the display. This symbol can be used to switch between the main menu and sub-menu and to navigate in both menus. Which functions are selected depends on how long the  symbol is pressed.

Briefly touching the symbol

Briefly touch the  symbol to navigate through the main menu and the sub-menu until you reach the required temperature or function.

Touching and holding the symbol for 3 seconds

If you touch and hold the  symbol for 3 seconds, the current status of the refrigeration appliance does not matter. A switched-off appliance will be switched on. The appliance is switched off in the main menu. An appliance in the sub-menu switches to the main menu. An active function is deactivated.

Touching and holding the symbol for 7 seconds

If you touch and hold the  symbol in the main menu for 7 seconds, the sub-menu opens. You are in the sub-menu when all 5 LEDs light up at the same time. If no function is selected within 5 seconds, the display returns to the main menu.



Main menu

In the main menu, you can choose between 5 settings; specifically, temperatures 9 °C, 7 °C, 5 °C and 3 °C, and the SuperCool  function.

Sub-menu

In the sub-menu, you can choose from 3 functions; specifically, the lock function at  LED, Sabbath mode at 3 °C LED and resetting to the factory default settings at 5 °C LED.

Display idle mode

Idle mode switches on when the  symbol in the main menu has not been touched for 10 seconds. This prevents the temperature from being changed inadvertently. Idle mode is ended by briefly touching the  symbol.

LED indicators

The LEDs can light up or flash to indicate the appliance status. If the LED lights up, the temperature is selected or the function is active. A flashing LED indicates a power failure or a temperature alarm until the set temperature is reached. If several LEDs flash at the same time, a fault has occurred. If the  symbol flashes, the WiFi connection can be established or the appliance is in the process of connecting.

Safety

Lock function

When the lock function is switched on, it protects the refrigeration appliance from being switched off unintentionally and being adjusted unintentionally by unauthorised persons, e.g. children.

The lock function is located in the  LED sub-menu.

Door alarm

The refrigeration appliance is fitted with a door alarm to avoid increased energy consumption and food becoming warm if the door is left open.

The alarm will sound and the interior lighting pulses if the door is left open for a long time.

As soon as the appliance door is closed, the alarm tone will stop.

Switching the door alarm off early

■ Tap  briefly.

The alarm tone will stop.

If the appliance door is not closed, the alarm will sound again after a short time.

Familiarisation

Appliance functions

Miele@home @

Your refrigeration appliance is equipped with an integrated WiFi module.

Networking is deactivated at the factory.

Here you can set up the Miele@home function for the first time, deactivate and activate the WiFi or reset the network configuration (see “Adjusting settings”).

To use this feature, you will need:

- A WiFi network
- The Miele app
- A Miele user account. You can create a user account via the Miele app

The Miele app will guide you as you connect your refrigeration appliance to your home WiFi network.

Once the refrigeration appliance is connected to your WiFi network, you can use the app to carry out the following activities, for example:

- Call up information on the operating status of your refrigeration appliance
- Change the settings on your refrigeration appliance

Connecting your refrigeration appliance to your WiFi network will increase energy consumption, even when the appliance is switched off.

Make sure that the signal of your WiFi network is sufficiently strong in the place where you want to set up your refrigeration appliance.

Availability of the WiFi connection

The WiFi connection shares a frequency range with other appliances (including microwave ovens and remote control toys). This can give rise to sporadic or even complete connection failures. Therefore, the availability of featured functions cannot be guaranteed.

Miele@home availability

The ability to use the Miele app depends on the availability of the Miele@home service in your country.

The Miele@home service is not available in every country.

For information about availability, please visit www.miele.com.

Miele App

The Miele App is available to download free of charge from the Apple App Store® or from the Google Play Store™.



SuperCool ❄️

When switched on, the SuperCool ❄️ function can be used to rapidly reduce the temperature in the **fridge zone** and the **freezer compartment** (depending on the model) to its lowest setting (depending on the ambient temperature). The refrigeration appliance will work at full power and lower the temperature. Select this function for the rapid chilling of large amounts of fresh food or drink or before

freezing fresh food. This helps food to freeze quickly and retain its nutrients, vitamins, flavours and appearance.

When the SuperCool ❄️ function is switched on, the appliance may make more noise than usual.

The SuperCool ❄️ function should be switched on **3 hours before** placing food or drinks in the fridge zone.

The SuperCool ❄️ function will switch itself off automatically after a maximum of 30 hours. The refrigeration appliance will then run at normal power again.

Tip: To save energy, you can switch the SuperCool ❄️ function off yourself once food and drinks are sufficiently chilled.

Sabbath mode

The refrigeration appliance offers a Sabbath mode for the purposes of religious observance.

When Sabbath mode is switched on, the following are deactivated:

- Interior lighting when the door is opened
- All acoustic and visual signals
- Temperature display
- WiFi connection
- Deactivate all functions in the display except for the Sabbath mode function

All other functions switched on previously remain activated.

The Sabbath mode function will switch off automatically after approx. 80 hours.

After a power failure, the appliance returns to Sabbath mode.

This product is certified by Star-K, an international institute for kosher certification. You can find the Star-K certification version [here](#).

The Sabbath mode function is located in the 3 °C LED sub-menu.

Familiarisation

Factory defaults

You can reset the refrigeration appliance's settings to their factory default settings. The WiFi connection is also reset.

Tip: We recommend doing this if you are disposing of or selling your refrigeration appliance, or if you are putting a used refrigeration appliance into operation.

The factory default settings function is located in the 5 °C LED sub-menu.

Demo mode

Demo mode allows the refrigeration appliance to be presented in the showroom without the cooling system being switched on. This setting is not needed for domestic use.

Adjusting the interior fittings

Moving the door shelf/bottle shelf

Only move the door/bottle shelves in the appliance door when they are empty.

- Push the door/bottle shelves upwards, then remove them by pulling them forwards.
- Replace the door/bottle shelves at the required height.

Clipping the egg trays on

- Clip the egg trays onto the rear edge of the door shelf.

Adjusting or removing the bottle holder

The non-slip fins of the bottle holder make bottles more secure when you open and close the appliance door.

The bottle holder can be moved to the left or right to create more room for drink cartons.

The bottle holder can be removed completely, e.g. for cleaning:

- pull the bottle holder up to remove it.

Moving the adjustable shelves

The shelves can be adjusted according to the height of the food.

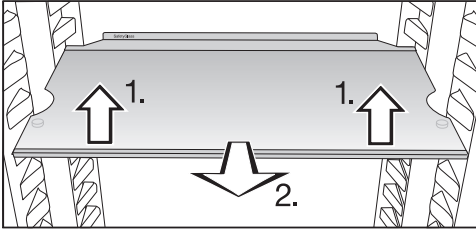

- Raise the shelf slightly at the front and pull it forwards a little.
- Lift it until the notches at the side are in line with the shelf supports. The shelf can then be raised or lowered to the required level.
- Push the shelf in.

Stoppers prevent the shelves from being dislodged by mistake.

The raised edge on the protective strip at the back must face upwards to prevent food from touching the back of the appliance and freezing to it.

Moving the split shelf

To accommodate tall items such as bottles or large containers, the front section of the split shelf slides underneath the rear section.

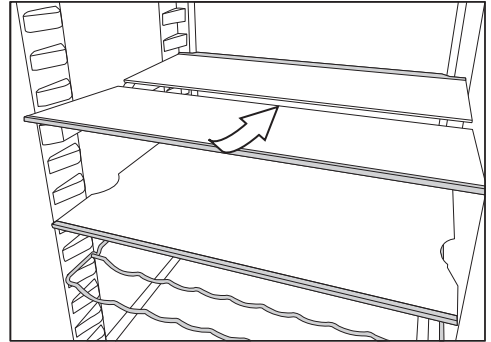

- Lift up the front section of the glass shelf slightly at the front and slide it carefully underneath the rear section.

Familiarisation

Moving a split shelf

The split shelf can be moved to a different location inside the appliance.

- Take both sections of the glass shelf out of the appliance.

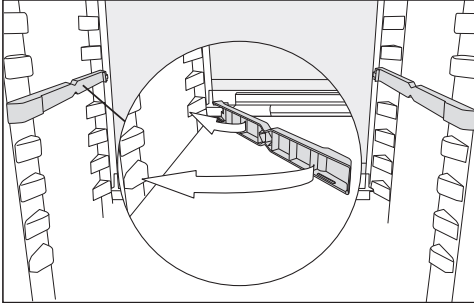

- Attach the two adapters to the support ribs on the left and right at the desired height.

The section of the glass shelf with the raised edge must be fitted at the back.

Before using for the first time

- Remove all packaging material and protective film.
- Clean the inside of the appliance and the accessories (see “Cleaning and care”).

Connecting the refrigeration appliance

- Connect the refrigeration appliance to the electricity supply as described in “Electrical connection”.

Switching on and off

Switching the refrigeration appliance on

- Open the appliance door.
- Touch the  symbol for 3 seconds until a buzzer sounds.

The refrigeration appliance will start to cool and the interior lighting will come on when the appliance door is opened.

The refrigeration appliance will adjust to the preset temperature.

During initial commissioning or if the appliance was not previously connected to the WiFi, the connection process may take several minutes. If the appliance was already connected to the WiFi, it will connect automatically.

To enable the temperature to get sufficiently cold inside the refrigeration appliance, allow the appliance to run for a few hours before placing food in it.

Switching off the refrigeration appliance

You are in the main menu.

- Touch the  symbol for 3 seconds until a buzzer sounds.

The LEDs in the display no longer light up, the interior lighting is switched off and the appliance is no longer cooling.

Please note: The refrigeration appliance is not disconnected from the power supply when it is switched off.

Commissioning

To note when switching off for longer periods of time

If, during a long absence, the refrigeration appliance is switched off but not cleaned and the door is left shut, there is a danger of mould building up inside the appliance. It is essential to clean the refrigeration appliance before a long period of absence.

If the refrigeration appliance is not going to be used for a longer period of time, observe the following:

- Switch the refrigeration appliance off.
- Switch off at the wall and disconnect the plug from the socket, or disconnect the fuse.
- Defrost the freezer compartment (depending on model).
- Clean the refrigeration appliance and leave the door ajar to air the appliance and avoid odours building up inside.

Setting the temperature

You are in the main menu.

- Touch the  symbol a few times in succession until you reach the LED for the required temperature.

 Health risk caused by decomposing food.

The preset temperature of **5 °C** in the fridge zone results in **-18 °C** in the freezer compartment.

Please note that if the temperature in the fridge zone is any warmer, the temperature in the freezer compartment will exceed -18 °C.

To freeze fresh food in the freezer compartment, a temperature of **-18 °C** is required.



If the temperature in the freezer compartment is any warmer, the food will also have a shorter shelf life.

Please note that the temperatures in the freezer compartment may fluctuate if there is not much food stored in it. Under certain circumstances, temperatures that are warmer than -18 °C can be reached.

Switching on SuperCool

The SuperCool  function should be switched on **3 hours before** placing food or drinks in the fridge zone.

When the SuperCool  function is switched on, the appliance may make more noise than usual.

- Touch the  symbol a few times in succession until you reach the  LED.

The  LED lights up orange.

Switching off SuperCool

The SuperCool  function will switch itself off automatically after a maximum of 30 hours. The refrigeration appliance will then run at normal power again.

Tip: To save energy, you can switch the SuperCool  function off yourself once food and drinks are sufficiently chilled.

- Touch the  symbol a few times in succession until you reach the required temperature.

SuperCool is deactivated and the  LED no longer lights up orange.

Operation

Storing food in the fridge zone

 Risk of explosion due to flammable mixes of gases. Electrical components can cause flammable mixes of gases to ignite. Do not store explosive materials in the refrigeration appliance or any products containing propellants (e.g. spray cans). The spray cans in question can be identified by the contents printed on the can or by a flame symbol. Electrical components can cause escaping gases to ignite.

 Risk of damage due to greasy or oily foods. If storing food which contains a lot of fat or oil in the refrigeration appliance or the appliance door, make sure that it does not come into contact with plastic components as this could cause stress cracks or break the plastic. Make sure that no fat or oil leaks onto the plastic parts of the refrigeration appliance.

If there is insufficient air circulation, the cooling performance will decrease and energy consumption will increase. To allow air to circulate efficiently, do not pack food too closely together in the appliance.

Different storage zones

Due to natural air circulation, there are different temperature regions in the refrigerator section.

Cold, heavy air sinks to the lowest section of the refrigeration section. Make use of the different zones when placing food in the appliance.

Warmest area

The warmest area in the refrigerator section is at the top in the front area and in the door. Use this for storing butter and cheese.

Coldest area

The coldest area in the fridge zone is directly above the DailyFresh drawer and at the back of the appliance.

A temperature setting of 4 °C or colder combined with appropriate hygiene measures delays the propagation of bacteria, e.g. salmonella and listeria, which can lead to serious food poisoning.

Therefore, you should use these areas to store all delicate and highly perishable food, including:

- Fish, meat, poultry
- Cold cuts, ready meals
- Dishes or baked goods containing eggs or cream
- Fresh dough, cake mixtures, pizza or quiche dough
- Raw milk cheese and other raw milk products
- Hummus, vegetable spreads, plant-based cream cheese substitutes
- Pre-packed vegetables

- Other fresh food (with a label stating it should be kept at a temperature of approx. 4 °C)

Tip: Store food in such a way that it does not touch the rear wall of the fridge zone. Otherwise it could freeze to the rear wall.

Food which is not suitable for storage in the refrigerator section

Not all food is suitable for refrigeration at temperatures below 5 °C, because it may be sensitive to cold. Depending on the type of food, the appearance, consistency, flavour and/or vitamin content may be altered if stored at too cold a temperature.

Food which is sensitive to cold includes:

- Pineapples, avocados, bananas, pomegranates, mangoes, melons, papayas, passionfruit, citrus fruit such as lemons, oranges, mandarins, grapefruit
- Fruit (which is not yet ripe)
- Aubergines, cucumbers, potatoes, peppers, tomatoes, courgettes
- Hard cheeses (e.g. Parmesan, mountain cheese)

Notes on buying food

The freshness of the food when it is first placed in the appliance is the most important factor for how long it stays fresh.

Take into account the use-by date and the correct storage temperature.

Time out of the refrigerator, e.g. transporting food in a warm car, should be kept to a minimum.

Storing food correctly

Ensure that food stored in the fridge zone is in packaging or covered properly (some exceptions apply in the DailyFresh drawer).

This will prevent food odours from affecting other food, stop food from drying out and also prevent any cross-contamination of bacteria. This is particularly important when storing meat products. Make sure that food such as raw meat and fish in particular does not come into contact with other food.

By ensuring that the temperature settings are correct and by taking appropriate hygiene measures, you can prolong the storage life of your food considerably. This prevents food waste.

Protein-rich food

Please note that food rich in protein deteriorates faster than other types of food. Shellfish, for example, deteriorates faster than fish, and fish deteriorates faster than meat.

Operation

Storing food in the DailyFresh drawer

The DailyFresh drawer provides good storage conditions for fruit and vegetables.

The humidity level in the DailyFresh drawer can also be regulated to suit the food being stored. Food retains its own moisture if stored at a higher humidity and so does not dry out as quickly. The temperature is approximately equivalent to the temperature in the fridge zone.

Remember that the fresher the food when placed in the appliance, the longer it will stay fresh.

Adjusting the humidity level in the DailyFresh drawer for fruit and vegetables

The moisture level greatly depends on the type and quantity of food being stored, if stored unwrapped. If the quantity of food being stored in this compartment is small, the humidity level may be too low.

Tip: If you are only storing a small amount of food, wrap it in airtight packaging.

Selecting low humidity δ

The appliance is delivered with increased humidity and the compartment cover pushed backwards $\delta\delta\delta$.

Only change this position if the DailyFresh drawer is excessively humid:

- Open the DailyFresh drawer.

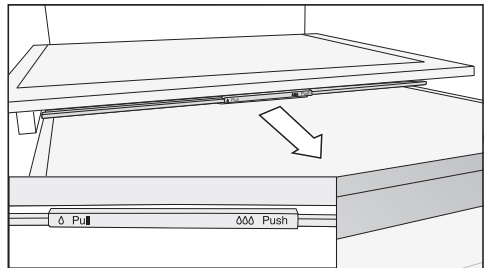

- Pull the compartment cover forwards as far as it will go.

The compartment cover is open and the humidity drops δ .

Selecting increased humidity $\delta\delta\delta$

- Open the DailyFresh drawer.

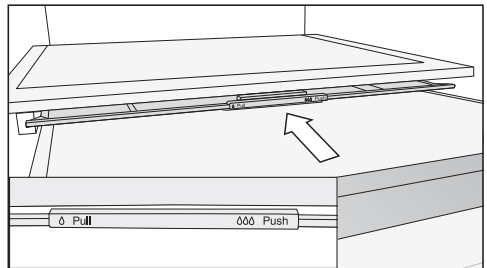

- Slide the compartment cover backwards as far as it will go.

The compartment cover is closed and the humidity remains in the compartment $\delta\delta\delta$.

Observe the following tips if you find that food you have stored does not keep well (e.g. food becomes limp or wilts after only being stored for a short time):

- Only place fresh food in the appliance. The initial condition of the food is crucial to maintaining freshness.
- Clean the DailyFresh drawer before storing food in it.
- Very wet food should be dried off before storing it.
- Do not store food which is sensitive to cold in the DailyFresh drawer (see “Storing food in the fridge zone – Food which is not suitable for storage in the fridge zone”).
- Set the compartment cover to the correct position for the food being stored (humidity not increased δ or humidity increased $\delta\delta\delta$).
- An increased humidity level $\delta\delta\delta$ in the humidity-controlled compartment is achieved with the moisture present in the food being stored if it is stored unwrapped. The more food stored in the compartment, the higher the humidity.
- If too much moisture collects in the compartment at the $\delta\delta\delta$ setting and the food is affected, dry the floor and place a rack or similar item in the compartment so that excess moisture can drip down. Alternatively, reduce the humidity δ by pulling the compartment cover forwards.
- If the humidity level is too low despite the $\delta\delta\delta$ setting, wrap the food in airtight packaging.

Operation

Freezing and storing food

Freezing fresh food

 Health risk caused by decomposing food.

If the temperature in the freezer remains above $-18\text{ }^{\circ}\text{C}$ for a long time, the frozen food can start to defrost. This will reduce the storage life of the food.

Check whether the frozen food has started to defrost. If it has, check that the food is safe to use and if it is, then use it as soon as possible or cook it before freezing it again.

Fresh food should be frozen as quickly as possible. This way the nutritional value of the food, its vitamin content, appearance and taste are not impaired.

If food is frozen quickly, the cells have less time to lose moisture, so they shrink significantly less. As there is not so much moisture loss, it is easier for the food to reabsorb it during the defrosting process, and very little water collects around the defrosted food.

Using the freezer compartment

Use the freezer compartment to:

- Store frozen food
- Make ice cubes
- Freeze small quantities of fresh food

Information on the maximum freezing capacity can be found on the data plate.

The freezing capacity indicates the amount of food that can be frozen through to the core and the number of hours it takes to do so.

Storing frozen food

- When buying frozen food to store in your freezer, check:
 - That the packaging is not damaged
 - The use-by date
 - That the temperature at which the frozen food is being stored in the shop is $-18\text{ }^{\circ}\text{C}$ or colder
- Where possible, transport frozen food in an insulated bag and then store it quickly in the refrigeration appliance.

Home freezing

Not suitable for freezing

Please note that some food is not suitable for freezing. This includes, for example, vegetables that are usually eaten raw, such as lettuce or radishes.

To note before placing food in the freezer

- Switch on the SuperCool ❄ function 3 hours before placing food and drinks in the appliance.

This helps the frozen food which is already stored in the freezer to stay frozen.

- Only freeze fresh food which is in good condition.

Tip: To retain colour, taste, aroma and vitamin C, vegetables should be blanched before they are frozen. To do so, place vegetables portion by portion into boiling water for 2–3 minutes. Then remove and plunge the vegetables into ice-cold water to cool quickly. Leave the vegetables to drain.

Packaging food for freezing

- Freeze food in portions.

Tip: Use suitable packaging to avoid freezer burn (such as freezer containers).

- Expel as much air as possible from the packaging and close it tightly.
- Make a note of the contents and the date of freezing on the packaging.

Placing food in the freezer

Unfrozen food should not touch frozen food as this will cause the frozen food to begin to thaw.

- To prevent food sticking together when frozen, make sure that the packaging and containers are dry.
- Place the food to be frozen flat in the bottom of the freezer compartment or in contact with the interior side walls, so that it freezes through to the core as quickly as possible.

After freezing

- Switch off the SuperCool ❄️ function.

Cooling drinks quickly

- When chilling drinks in the freezer compartment, make sure that bottles are **not left in for more than 1 hour**. Otherwise they could burst.

Making ice cubes

- Fill the ice cube tray 3/4 full with water and place it on the bottom of the freezer compartment.
- Once frozen, use a blunt instrument, for example a spoon handle, to remove the ice cube tray from the freezer if it is stuck.

Tip: Ice cubes can be removed easily from the tray by twisting the tray gently or by holding it under cold running water for a short time.

Operation

Defrosting

Fridge zone and DailyFresh drawer

The fridge zone and the DailyFresh drawer defrost automatically.

Condensate and frost can build up on the back wall of the fridge zone and the DailyFresh drawer whilst the compressor is running. You do not need to remove this.

The condensate drains through a channel and drain hole into an evaporation system at the back of the refrigeration appliance. The warmth generated by the compressor causes the condensate to evaporate automatically.

Keep the condensate channel and drain hole clean to enable this. Condensate must be able to drain away unhindered at all times.

Defrosting the freezer compartment

The freezer compartment does not defrost automatically.

In normal use, ice and frost will form in the freezer compartment, e.g. on the internal walls. How much ice and frost accumulates in the appliance will depend on the following:

- Whether the freezer compartment door has been opened frequently or left open for a while
- Whether a large quantity of food has been placed in the freezer at once
- Whether the humidity in the room has increased

Too thick a layer of ice will make it hard to open the freezer compartment. Too thick a layer of ice also reduces cooling performance and thus increases energy consumption.

- The freezer compartment should be defrosted from time to time. It must be defrosted if a layer of ice approx. 0.5 cm thick has accumulated.

Tip: It is best to defrost when only very little or no frozen food at all is left in the freezer compartment or the humidity level and the ambient temperature in the room are low.

 Risk of damage from an incorrect defrosting process.

When defrosting the freezer, make sure that you do not damage the evaporator as this would cause irreversible damage to the refrigeration appliance.

Do not scrape off ice and frost. Do not use sharp objects.

Do not use any mechanical tools or other types of aid which are not recommended by the manufacturer to accelerate the defrosting process.

- Switch on the SuperCool ❄️ function 1 day before defrosting. This helps the frozen food to retain the cold reserve for longer when taken out of the freezer.
- Remove the frozen food and wrap it in several layers of newspaper or cloths.

Tip: You could also place the frozen food in a cool box or bag.

- Store it in a cool place until the freezer compartment is ready for use again.

The longer the frozen food is left out at room temperature, the faster it deteriorates.

Carry out the defrosting procedure as quickly as possible.

 Risk of damage due to heat and moisture ingress.

The steam from a steam cleaner as well as electric heaters and candles can damage plastic and electrical components.

Do not use a steam cleaner, electric heaters or candles to defrost the refrigeration appliance.

 Risk of damage and risk to health caused by defrosting sprays or de-icers.

Defrosting sprays or de-icers can contain substances which could damage the plastic parts or which might cause a build-up of explosive gases and pose a danger to health.

Never use defrosting sprays or de-icers to defrost the refrigeration appliance.

Ensure that water does not get into the surrounding cabinetry.

- Switch the refrigeration appliance off.
- Switch off at the wall and disconnect the plug from the socket, or disconnect the fuse.
- Leave the freezer compartment door and the appliance door open.

Tip: To speed up defrosting, a bowl of hot water (not boiling) can be placed on a saucer in the freezer compartment. Closing the freezer compartment door in this instance will help retain the warmth and speed up the defrosting process.

- Remove any loose pieces of ice.
- Use a sponge or cleaning cloth to soak up the defrosted water as often as necessary.

After defrosting

- Clean and dry the freezer compartment.
- Close the freezer compartment door and the appliance door.
- Reconnect the refrigeration appliance to the mains and switch it back on.

Operation

- Switch on the SuperCool ❄️ function for a while so that the freezer compartment can cool down quickly.
- Place the food back into the freezer compartment.

The correct temperature

It is very important to set the correct temperature to ensure the shelf life of food. Reducing the temperature reduces the growth rate of microorganisms. Food does not spoil as quickly.

The temperature in the refrigeration appliance will rise:

- The more often the appliance door is opened and the longer it is kept open
- The more food that is stored in it
- The warmer the food is which is being put into it
- The higher the ambient temperature surrounding the refrigeration appliance. This refrigeration appliance is designed for use within specific ambient temperatures (climate range). Do not use in ambient temperatures for which it is not designed.

... in the fridge zone

We recommend a temperature of **5 °C** in the fridge zone.

... in the freezer compartment (depending on the model)

To freeze fresh food, a temperature of **-18 °C** is required. This will prolong the storage life of your food and retain its quality.

As soon as the temperature rises above -10 °C, the bacteria become active in the food again so it cannot be kept as long. For this reason, partially defrosted or defrosted food must not be re-frozen. Food may be re-frozen once it has been cooked, as the high temperatures achieved when cooking destroy most bacteria.

Storage time for frozen food

Food group	Storage time (Months)
Ice cream	2 to 6
Bread, baked goods	2 to 6
Cheese	2 to 4
Fish, oily	1 to 2
Fish, lean	1 to 5
Sausage, ham	1 to 3
Game, pork	1 to 12
Poultry, beef	2 to 10
Vegetables, fruit	6 to 18
Herbs	6 to 10

The storage times given are guidelines only.

For standard freezing results, follow the advice on packaging.

By keeping the freezer compartment at a constant temperature of -18 °C and taking appropriate hygiene measures you can maximise the storage life of your food and avoid food waste.



Adjusting settings

Switching the lock function on

The refrigeration appliance must be switched on.

- Touch the  symbol until a dual buzzer sounds after 7 seconds.

All 5 LEDs light up. You are in the sub-menu. If 5 seconds pass without a function being selected, the display will return to the main menu.

- Touch the  symbol multiple times briefly until you reach the  LED.

The  LED lights up and the safety lock has been activated.

Switching the lock function off

- Touch the  symbol for 3 seconds until a buzzer sounds.

The lock function has been switched off. You are back in the main menu.

Switching Sabbath mode on

The refrigeration appliance must be switched on.

When Sabbath mode is switched on, you cannot make any settings on your refrigeration appliance.

- Touch the  symbol until a dual buzzer sounds after 7 seconds.

All 5 LEDs light up. You are in the sub-menu. If 5 seconds pass without a function being selected, the display will return to the main menu.

- Touch the  symbol multiple times briefly until you reach the 3 °C LED.

The 3 °C LED lights up and Sabbath mode is switched on.

Ensure that the appliance door is properly closed, as visual and audible alarms are switched off.

 Health risk caused by decomposing food.

As power failures are not indicated while Sabbath mode is active, food may be exposed to increased temperatures for a certain period of time. This will reduce the storage life of the food.

If there is a power failure during Sabbath mode, check the quality of the food.

Switching Sabbath mode off

The Sabbath Mode function will switch off automatically after approx. 80 hours.

However, you can switch the Sabbath mode function off early.

- Touch the  symbol for 3 seconds until a buzzer sounds.

Sabbath mode is switched off. You are back in the main menu.

The interior lighting is activated. The LED for the previously set temperature lights up. The appliance connects to the WiFi if it was previously connected to the WiFi. If the appliance was not previously connected to the WiFi, the  symbol flashes for several minutes. A connection can be established during this time.

Resetting the settings to their factory default settings

- Touch the  symbol until a dual buzzer sounds after 7 seconds.

All 5 LEDs light up. You are in the sub-menu. If 5 seconds pass without a function being selected, the display will return to the main menu.



- Touch the  symbol multiple times briefly until you reach the 5 °C LED.

The 5 °C LED lights up and all settings are reset to the factory default settings. The appliance is restarted.

The LED for the factory-set temperature of 5 °C lights up. The WiFi LED  flashes for several minutes. A connection can be established during this time.

Activating the WiFi connection

The WiFi connection is switched off at the factory. The  symbol is dark.

- Touch and hold the  symbol for 3 seconds to switch off the refrigeration appliance.
- Then touch and hold the  symbol for 3 seconds to switch on the refrigeration appliance.

The  symbol flashes in the display for several minutes. During this time, you can connect the appliance to the WiFi. If the time window for the connection is not long enough, switch the appliance off and on again.

As soon as the connection is established, the  symbol lights up.

Deactivating the WiFi connection

To deactivate the WiFi connection, you must reset the appliance to the factory default settings.

- Touch the  symbol until a dual buzzer sounds after 7 seconds.
- All 5 LEDs light up. You are in the sub-menu. If 5 seconds pass without a function being selected, the display will return to the main menu.



- Touch the  symbol multiple times briefly until you reach the 5 °C LED.

The 5 °C LED lights up and all settings are reset to the factory default settings. The appliance is restarted.

The  symbol flashes in the display for several minutes. The connection is deactivated after this time.



Reset the network configuration if you are disposing of or selling your refrigeration appliance, or if you are putting a used refrigeration appliance into operation. All personal data is removed from the refrigeration appliance. This will also ensure that a previous owner is no longer able to access the refrigeration appliance.

Switching on demo mode

- Touch and hold the  symbol for 3 seconds to switch off the appliance.
- Touch the  symbol for 10 seconds until a buzzer sounds.

All LEDs light up twice briefly. Demo mode has been activated.

Switching off demo mode

- Touch and hold the  symbol for 3 seconds to switch off the appliance.
- Touch the  symbol for 10 seconds until a buzzer sounds.

All LEDs light up twice briefly. The display goes dark. Demo mode is switched off.

After demo mode is switched off, the appliance is reset to the factory default settings.

Adjusting settings

Exiting service mode

If you have accidentally entered service mode, you can easily exit it again. The WiFi LED and the 9 °C LED flash simultaneously.

- Either wait 5 minutes or touch the  symbol for 3 seconds to exit service mode.

The data plate located inside the interior cabinet of the refrigeration appliance must not be removed. It contains information which is required in the event of a fault.

Do not let water get into the electronic unit or the lighting.

 Risk of damage due to moisture ingress.

The steam from a steam cleaner can damage plastic and electrical components.

Do not use a steam cleaner to clean the refrigeration appliance.

Cleaning water must not get into the drain hole.

Cleaning agents

Cleaning and conditioning agents used in the interior cabinet of the refrigeration appliance must be food safe.

To avoid damaging the surfaces of the appliance, **do not use the following:**

- Cleaning agents containing soda, ammonia, acids or chlorides
- Cleaning agents containing descaling agents
- Abrasive cleaning agents (e.g. scouring powder, scouring liquid or pumice stones)
- Cleaning agents containing solvents
- Stainless steel cleaners
- Dishwasher cleaner
- Oven sprays
- Glass cleaning agents
- Hard, abrasive sponges and brushes (e.g. pot scourers)
- Eraser stain remover blocks
- Sharp metal scrapers

We recommend using a clean sponge and lukewarm water with a little washing-up liquid to clean the surfaces of the appliance.

Cleaning and care

Preparing the refrigeration appliance for cleaning

- Switch the refrigeration appliance off.
- Take any food out of the refrigeration appliance and store it in a cool place.
- Defrost the freezer compartment (depending on the model; see “Defrosting”).
- Take out all other removable parts for cleaning.

Cleaning the inside of the appliance

Clean the refrigeration appliance regularly, at least once a month, and the freezer compartment each time it is defrosted.

If soiling is left on for any length of time, it may become impossible to remove under certain circumstances. Surfaces may suffer discolouration or damage.

It is therefore best to remove any soiling immediately.

- Clean the **interior** with a clean sponge cloth, lukewarm water and a little washing-up liquid.
- After cleaning, wipe with clean water and dry with a cloth.
- Clean the freezer compartment each time it is defrosted.
- Clean the condensate channel and drain hole frequently using a cotton swab or similar item to ensure that condensate can drain away freely.
- Leave the door open to air the refrigeration appliance sufficiently for a short while and to prevent odour build-up.

Cleaning accessories by hand or in the dishwasher

The following components must be cleaned **by hand** only:

- The stainless steel trim
- Protective strips at the back of the adjustable shelves
- Adjustable shelf with printing
- All drawers and compartment lids (these vary depending on model)
- The flexible bottle rack (available as an optional accessory)
- Organisation box (available as an optional accessory)

The following components are **dishwasher-safe**:

 Risk of damage due to high dishwasher temperatures. Parts of the refrigeration appliance may become unusable, e.g. deform, if they are washed in the dishwasher at more than 55 °C. For dishwasher-safe components, always select dishwasher programmes with a maximum temperature of 55 °C.

Contact with natural dyes from carrots, tomatoes and ketchup, etc., may discolour the plastic parts in the dishwasher. This discolouration does not affect the stability of the parts.

- Bottle holder, egg tray
- The door and bottle shelves in the appliance door (without stainless steel trim)
- Adjustable shelves (without the trim or printing)

- The holder for the charcoal filter (available as an optional accessory)

Removing and dismantling accessories for cleaning

Dismantling the door shelf/bottle shelf

Remove the stainless steel trim before cleaning the door shelf/bottle shelf in the dishwasher.

To remove the stainless steel trim, proceed as follows:

- Place the door shelf/bottle shelf on the worktop.
- Pull the trim off the shelf beginning at one side.
- After cleaning the door shelf/bottle shelf, reattach the trim.

Dismantling an adjustable shelf

Remove the trim and the rear protective strip before cleaning the shelf. Proceed as follows:

- Place the shelf on a worktop covered with a soft material (e.g. a tea towel).

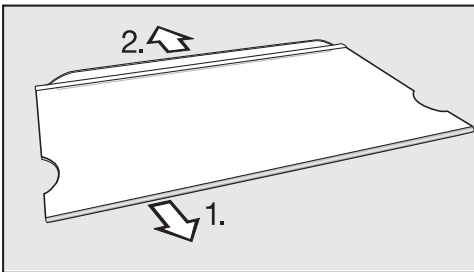

- Pull the trim off the shelf, beginning at one side.
- Then pull the protective strip off.
- After cleaning the shelf, reattach the trim and the protective strip.

Removing the DailyFresh drawer

- Lift the DailyFresh drawer slightly at the front and pull it out.

Removing the dividing plate

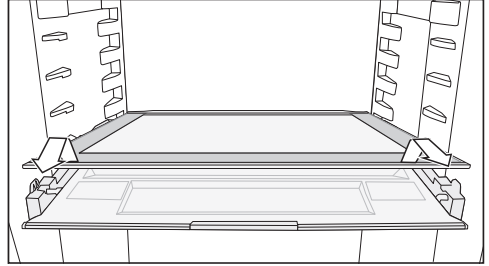

- Remove the dividing plate.
- After cleaning, slide the dividing plate back in again.

Removing the compartment cover

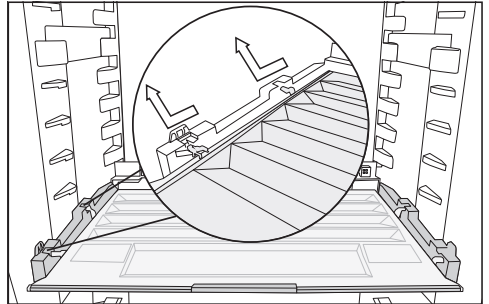

- Lift the cover at the front and pull it out.
- After cleaning, slide the compartment cover back in again.

Cleaning and care

Cleaning the front of the appliance and the side panels

If soiling is left on for any length of time, it may become impossible to remove. Surfaces may suffer discolouration or damage.

Therefore, it is best to remove soiling from the appliance front and side panels immediately.

All surfaces are susceptible to scratching. Contact with unsuitable cleaning agents can alter or discolour the surfaces.

See the information on “Cleaning agents” at the beginning of this section.

- Clean the surfaces with a clean sponge and a solution of warm water and washing-up liquid. A clean, damp microfibre cloth without cleaning agent can also be used.
- After cleaning, wipe with clean water and dry with a soft cloth.

Cleaning the door seal

 Risk of damage as a result of incorrect cleaning.

If you treat the door seal with oils or grease, it can become porous.

Do not use any oils or grease on the door seal.

- The door seal should be cleaned regularly with clean water, and then wiped dry with a soft cloth.

Cleaning the ventilation gaps

A build-up of dust will increase the energy consumption of the appliance.

- The ventilation gaps should be cleaned on a regular basis with a brush or vacuum cleaner (you could use a Miele vacuum cleaner dusting brush, for example).

Cleaning the compressor and metal grille at the back of the appliance

A build-up of dust will increase the energy consumption of the appliance.

 Risk of damage as a result of incorrect cleaning.

Cables and other components can get broken off, bent or damaged.

Carefully clean the compressor and metal grille.

The compressor and metal grille at the back of the refrigeration appliance (heat exchanger) should be dusted at least once a year.

After cleaning

- Replace all shelves and accessories in the refrigeration appliance.
- Switch the refrigeration appliance back on.
- Switch on the SuperCool function for a while so that the fridge zone can cool down quickly.
- Place food in the fridge zone and close the appliance door.
- When the temperature in the freezer compartment is low enough, place food back in the freezer compartment and close the door.

Many malfunctions and faults that can occur in daily operation can be easily remedied. You can save time and money in many cases, as you do not need to call the Miele Customer Service Department.

Information to help you remedy faults yourself can be found at www.miele.com/service.

The following tables are designed to help you to find the cause of a malfunction or a fault and to resolve it.

To prevent unnecessary loss of temperature it is advisable not to open the door while waiting for the appliance to be serviced.

Problem	Cause and remedy
The refrigeration appliance is not getting cold and the interior lighting does not come on when the appliance door is opened.	The refrigeration appliance has not been switched on. The temperature display on the control panel is not showing a temperature. ■ Switch the refrigeration appliance on.
	The plug is not inserted into the socket correctly. ■ Insert the plug into the socket.
	The mains fuse has tripped. There could be a fault with the refrigeration appliance, the household electrical wiring or another electrical appliance. ■ Contact a qualified electrician or the Miele Customer Service Department.
The refrigeration appliance is not getting cold and the interior lighting does not come on when the appliance door is opened.	Demo mode has been activated. This allows the refrigeration appliance to be presented in the dealer showroom without the cooling system being switched on. This setting is not needed for domestic use. ■ Switch off demo mode (see “Adjusting settings – Switching off demo mode”).
The compressor runs continuously.	This is not a fault. To save energy, the compressor runs at a lower speed, but for longer, when less cooling is required.
The compressor is switching on more frequently and for longer periods of time. The temperature in the refrigeration appliance is too low.	The ventilation gaps have been covered or become too dusty. ■ Do not block the ventilation gaps. ■ Dust the ventilation gaps regularly.
	The appliance door and the freezer compartment door (depending on the model) have been opened too frequently, or a large amount of fresh food has been placed in the appliance at once for chilling or freezing.

Troubleshooting

Problem	Cause and remedy
	<p>■ Only open the appliance doors when necessary and for as short a time as possible.</p> <p>After a while, the temperature will return to normal by itself.</p>
	<p>The appliance doors are not closed properly. A thick layer of ice may have already formed in the freezer compartment.</p> <p>■ Close the appliance doors.</p> <p>After a while, the temperature will return to normal by itself.</p> <p>If a thick layer of ice has already formed, this will affect cooling and increase energy consumption.</p> <p>■ Defrost the freezer compartment and clean it.</p>
	<p>The ambient room temperature is too high. The higher the ambient temperature, the longer the compressor has to run.</p> <p>■ See the information in “Installation – Installation site”.</p>
	<p>The temperature setting in the refrigeration appliance is too low.</p> <p>■ Correct the temperature setting.</p>
	<p>A large amount of food has been frozen at once.</p> <p>■ See the information in “Operation – Freezing and storing food”.</p>
	<p>The SuperCool function is still switched on.</p> <p>■ Switch off SuperCool earlier to save energy.</p>

Troubleshooting





Problem	Cause and remedy
The compressor comes on less and less often and for shorter periods of time. The temperature in the refrigeration appliance rises.	This is not a fault. The temperature setting is too high. <ul style="list-style-type: none"> ■ Correct the temperature setting. ■ Check the temperature again after 24 hours.
	The frozen food begins to defrost. The ambient temperature is too low for this refrigeration appliance. If the ambient temperature is too low, the compressor will run less frequently. This may cause the freezer compartment to become too warm. <ul style="list-style-type: none"> ■ See the information in “Installation – Installation site”. ■ Increase the ambient temperature.
Ice or condensation has built up inside the refrigeration appliance. The appliance door may not close correctly.	The door seal has come out of its groove. <ul style="list-style-type: none"> ■ Check that the door seal is correctly positioned in the groove.
	The door seal is damaged. <ul style="list-style-type: none"> ■ Check whether the door seal is damaged.
The door seal is damaged or needs to be replaced.	No tools are required to change the door seal. <ul style="list-style-type: none"> ■ Change the door seal. A replacement is available from Miele or from specialist retailers.

Other problems

Problem	Cause and remedy
Food has frozen together.	The food packaging was not dry when placed in the freezer. <ul style="list-style-type: none"> ■ Use a blunt instrument, e.g. a spoon handle or plastic scraper, to prise it apart carefully.
The external walls of the appliance feel warm.	This is not a fault. The heat created by the evaporator is used to prevent condensation.
The floor of the refrigerator section is wet.	The condensate drain hole is blocked. <ul style="list-style-type: none"> ■ Clean the condensate channel and drain hole.

Troubleshooting

Display warnings

Message	Cause and remedy
The 3 °C, 7 °C and  LEDs flash in the display.	This message appears if the appliance cannot be connected to the WiFi or the connection is interrupted. <ul style="list-style-type: none">■ Briefly touch the  symbol to switch the alarm off, and then check the WiFi connection (see “Familiarisation” and “Adjusting settings – “Activating the WiFi connection”).
 and the 9 °C LED flash simultaneously in the display.	This message appears if you have accidentally entered service mode. <ul style="list-style-type: none">■ Either wait 5 minutes or touch the  symbol for 3 seconds to exit service mode.

Interior lighting



Risk of electric shock due to exposed, live electrical components.

When removing the lighting cover, there is a risk of coming into contact with live electrical components.

Do not remove the lighting cover. The LED lighting may only be repaired or replaced by the Miele Customer Service Department.



Risk of injury from LED lighting.

This lighting corresponds to risk group RG 2. If the cover is defective, there is a risk of eye injury.

If the lighting cover is defective, do not look from a close range directly into the lighting with optical instruments (e.g. magnifying glass or similar).

Noises

The refrigeration appliance is producing various noises during operation. If the cooling performance is low, the refrigeration appliance will conserve energy but operate for longer. The volume will be lower. Food will be chilled faster if the cooling performance is high. The volume will be higher.

Normal noises	What is causing them?
Hissing	Refrigerant is being injected into the cooling circuit.
Bubbling, gurgling, splashing	Refrigerant is circulating through the pipes.
Humming	The refrigeration appliance is cooling.
Clicking	The thermostat is switching the compressor on or off.
Humming, whirring	The fan is running. Automatic door opening is opening or closing the appliance door.
Cracking	Materials are expanding inside the refrigeration appliance.
Rattling	Valves or flaps are active.
Buzzing (refrigeration appliances with water container)	Water is being pumped out of the water container.
Slurping (refrigeration appliances with soft-close mechanism)	The appliance door with soft-close mechanism is being opened or closed.

Please bear in mind that a certain amount of noise is unavoidable (from the compressor and the refrigerant circulating through the cooling circuit).

Troubleshooting

Noises	Cause and remedy
Vibrating, rattling, clinking	The refrigeration appliance is uneven. Use a level to check and adjust the alignment of the refrigeration appliance by raising or lowering the adjustable feet underneath the refrigeration appliance.
	The refrigeration appliance is touching another appliance or piece of furniture. Move it away.
	Drawers, baskets or shelves are jiggling or are stuck. Check all removable items and refit them correctly.
	Bottles or containers are touching. Separate bottles or containers slightly.
	The transport cable clips (depending on the model) are hanging loose at the back of the appliance. Remove the transport cable clips.

Information to help you rectify faults yourself and about Miele spare parts can be found at www.miele.com/service.

Contact in the event of a fault

In the event of a fault which you cannot remedy yourself, please contact your Miele dealer or Miele Customer Service.

You can book a Miele Customer Service call-out online at www.miele.com/service.

Contact information for Miele Customer Service can be found at the end of this document.

Please quote the model identifier and serial number of your appliance (SN) when contacting Miele Customer Service. Both numbers can be found on the data plate inside the refrigeration appliance or, depending on the model, in Settings mode under Information **i**.

EPREL database

Since 1 March 2021, information on energy labelling and ecodesign requirements has been available in the European Product Database (EPREL). You can find the product database at the following link <https://eprel.ec.europa.eu/>. You will be asked to enter the model identifier.

The model identifier can be found on the data plate inside the refrigeration appliance or, depending on the model, in Settings mode under Information **i**.

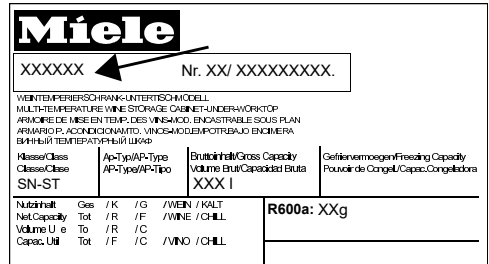

Warranty

For information on the appliance warranty specific to your country please contact Miele. See back cover for address.

In the UK, your appliance warranty is valid for 2 years from the date of purchase. However, you must activate your cover by calling 0330 160 6640 or registering online at www.miele.co.uk.

Optional accessories

Multi-purpose microfibre cloth

The microfibre cloth is suitable for removing fingerprints and light soiling from surfaces such as stainless steel, glass, plastic and chrome without the use of chemicals.

MicroCloth Kit

The MicroCloth Kit contains a universal cloth, a glass cloth and a polishing cloth. These cloths are extremely resistant to tearing and very robust. Thanks to very fine microfibres these cloths achieve an excellent cleaning performance.

MicroCloth HyClean

The MicroCloth HyClean is a multi-purpose antibacterial cloth and is particularly tear resistant and durable. It can be used wet or dry, with or without cleaning agent.

KKF-FF charcoal filter with holder (Active AirClean)

Charcoal filters neutralise unpleasant odours in the fridge zone for improved air quality.

KKF-RF replacement charcoal filters (Active AirClean)

Replacement filters to fit the holder are available. We recommend replacing the charcoal filters every 6 months.

Bottle rack

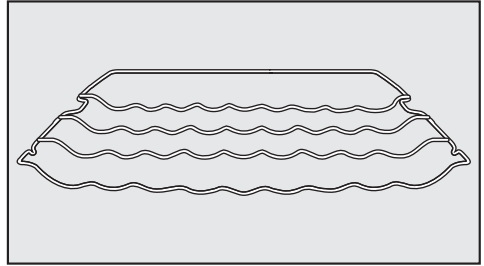

Bottles can be stored horizontally using the bottle rack to save space. The bottle rack can be placed at different positions in the appliance.

Organisation box

The organisation box makes it easier to sort the food in the fridge zone drawer in a clear manner.

Depending on the model, you may need to remove the entire drawer to insert and remove the organisation box.

Accessories are available to order via the Miele Webshop, from Miele directly (see back cover for contact details) or from your Miele dealer.

Installation site

 Risk of damage due to high humidity.

In environments with high humidity, condensation can build up on external refrigeration appliance panels.

This condensate can cause corrosion on external appliance panels.

Install the refrigeration appliance in a dry and/or air-conditioned room with sufficient ventilation.

After installation please make sure that the appliance door(s) closes/closes properly and that the specified ventilation gaps are adhered to.

 Fire risk and risk of damage from appliances which give off heat.

Appliances which give off heat can catch fire and set fire to the refrigeration appliance.

Do not place appliances which give off heat, such as mini-ovens, double burner hobs or toasters on the refrigeration appliance.

 Fire risk and danger of damage from open flames.

Open flames can set fire to the refrigeration appliance.

Keep open flames (e.g. a candle) away from the refrigeration appliance.

This appliance should be installed in a dry, well-ventilated room.

When deciding on the installation site, please bear in mind that your refrigeration appliance will use more energy if installed near to a heater, a cooker or other appliance that gives off heat.

Avoid direct sunlight.

The higher the ambient temperature, the longer the compressor runs and the higher the energy consumption is.

When installing the refrigeration appliance, please note the following:

- The socket must be easily accessible in an emergency, not concealed behind the appliance.
- The mains plug and mains connection cable must not touch the rear of the refrigeration appliance as they could be damaged by vibrations from the appliance.
- Do not plug in other appliances into sockets behind this appliance.
- When installing the refrigeration appliance, make sure that the mains connection cable does not get trapped or damaged.
- Do not position or operate multi-socket adapters, distributor strips or other electronic devices (e.g. halogen transformers) at the rear of the appliance.
- The floor at the installation site must be horizontal and level and must be as high as the surrounding floor.

Climate range

This refrigeration appliance is designed for use within specific ambient temperatures (climate range). Do not use in ambient temperatures for which

Installation

it is not designed. The climate range is stated on the data plate in the interior cabinet of the refrigeration appliance.

Climate range	Ambient temperature
SN	10 to 32 °C
N	16 to 32 °C
ST	16 to 38 °C
T	16 to 43 °C
SN-ST	10 to 38 °C
SN-T	10 to 43 °C

A lower ambient temperature leads to the compressor switching off for longer periods. This can cause the internal temperature in the refrigeration appliance to rise with the risk of food deteriorating and going off.

Air at the back of the refrigeration appliance gets warm. Sufficient space for proper ventilation must therefore be ensured (see “Installation dimensions”).

Ventilation requirements

 Risk of fire and damage due to insufficient ventilation.

If the refrigeration appliance is not ventilated sufficiently, the compressor will run more frequently and for longer periods. This will result in increased energy consumption and a higher operating temperature for the compressor. This may, in turn, cause damage to the compressor.

Please ensure that there is adequate ventilation around the refrigeration appliance.

It is essential to observe the required ventilation gaps.

The ventilation gaps must not be covered or blocked in any way.

They must also be regularly dusted.

Installing several refrigeration appliances

⚠ Risk of damage due to condensation on external appliance panels.

In environments with high humidity, condensation can build up on external appliance panels, which can cause corrosion.

Do not place different refrigeration appliance models directly next to or on top of one other.

Your refrigeration appliance must not be installed next to another refrigeration appliance (“side-by-side”), or above another one, because it is not equipped with built-in heating units in the side panels.

If you want to place several refrigeration appliances next to each other, a distance of 100 mm must be maintained between them.

Changing the door hinging

⚠ Danger of injury and damage to the appliance due to heavy door.

There is an increased risk of injury and damage if the door hinging is installed by a single person.

Always change the door hinging with the help of a second person.

⚠ Risk of crushing at the hinge.

Fingers can get trapped in or around the hinge.

Do not reach into the hinge when opening and closing the door.

The refrigeration appliance is supplied with right-hand hinging. If left-hand hinging is required, the hinges must be changed.

- Place a suitable cover on the floor in front of the appliance to protect the appliance door and your floor from damage while you are changing the hinging.
- Make sure that the appliance is empty.
- Close the appliance door.

Be careful not to damage the door seal. If the door seal is damaged, the appliance door may not close properly and cooling will be insufficient.

Tip: To change the door hinging, you will need the following tools:

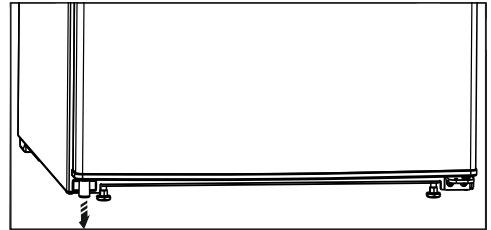
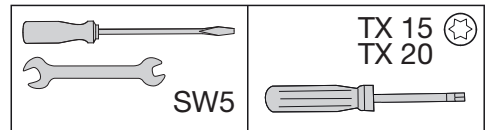

- With the help of a second person, tilt the appliance back and remove the spacer on the bottom left (only in the case of appliances without a freezer compartment).

Installation

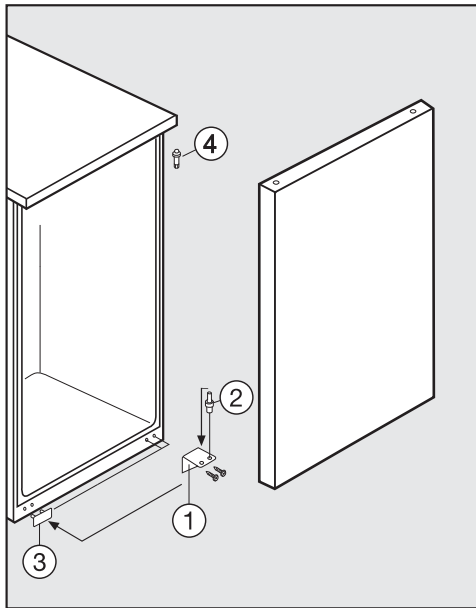

⚠ Risk of injury when removing the appliance door.

The appliance door is not secure once the screws on the hinge plate have been removed.

The second person must support the appliance door.

- Unscrew the lower hinge plate (1) and remove it.
- Take the appliance door off downwards.
- Pull the hinge pin (2) out of the hinge plate (1), and screw it into the second hole in the hinge plate. (The hinge pin can be screwed in and unscrewed using the open spanner.)
- Remove the cover (3) and use it to cover the empty holes on the opposite side.

- Unscrew the upper hinge pin (4) with the open spanner and refit it on the opposite side.

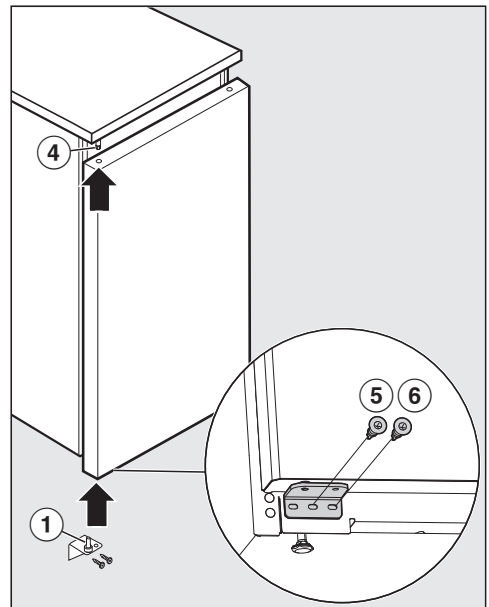

- Fit the appliance door from below up onto the upper hinge pin (4) and then close the appliance door.
- Fit the hinge plate (1) from below into the lower door bearing and screw it on tight, first tightening the middle screw (5) and then the inner screw (6).
- The appliance door can be aligned using the long slots in the hinge plate. Ensure that all screws have been properly tightened.

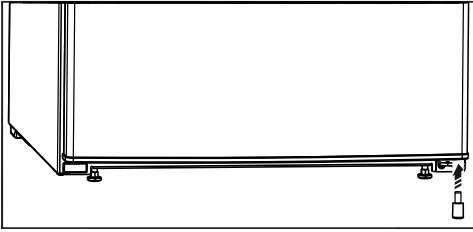

- Reinsert the spacer in the door on the bottom right to improve stability.

Fitting supplied wall spacers

The wall spacers supplied must be used in order to achieve declared energy consumption values and to prevent the build-up of condensation at high ambient temperatures. The refrigeration appliance depth is increased by approx. 35 mm for appliances with wall spacers fitted.

If the wall spacers are not used, the functionality of the refrigeration appliance is not affected. Energy consumption does, however, increase slightly with less distance between the appliance and the wall.

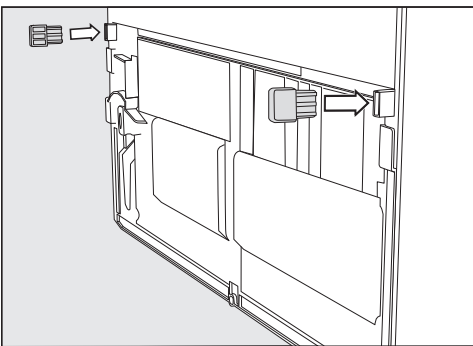

- Fit the wall spacers onto the back of the refrigeration appliance on the bottom left and right.

Setting up the refrigeration appliance

 Risk of injury and damage due to the refrigeration appliance tipping over.

There is an increased risk of injury and damage if the refrigeration appliance is installed by a single person.

Two people are required for installing the refrigeration appliance.

 Risk of damage to the appliance door caused by impact.

The appliance door could hit the wall of the room resulting in damage to the door.

Protect the appliance door by fitting a felt stopper, for example, to the wall of the room.

 Risk of damaging the floor.

Moving the refrigeration appliance can cause damage to the floor.

Move the refrigeration appliance carefully on floors that are sensitive to scratching.

Tip: The refrigeration appliance must be empty when it is installed.

- Prepare the refrigeration appliance for installation as close as possible to its intended installation site.
- Connect the refrigeration appliance to the electricity supply as described in “Electrical connection”.
- Move the refrigeration appliance carefully to its intended installation site.
- Position the refrigeration appliance with the wall spacers (if used) or the back close to the wall.

Installation

Aligning the refrigeration appliance

 Risk of damage caused by floor unevenness.

If the adjustable feet are not used to compensate for any unevenness in the floor, the body of the appliance may warp slightly, potentially preventing the appliance door from closing properly.

Use the adjustable feet to compensate for any unevenness in the floor.

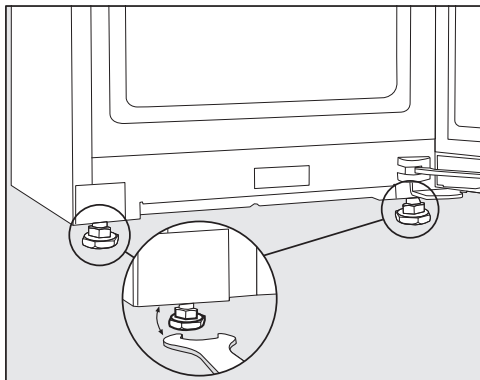

- To align the refrigeration appliance, adjust the front feet using a spirit level and the spanner supplied.

Integrating the refrigeration appliance in a run of kitchen units

The refrigeration appliance can be surrounded by kitchen units.

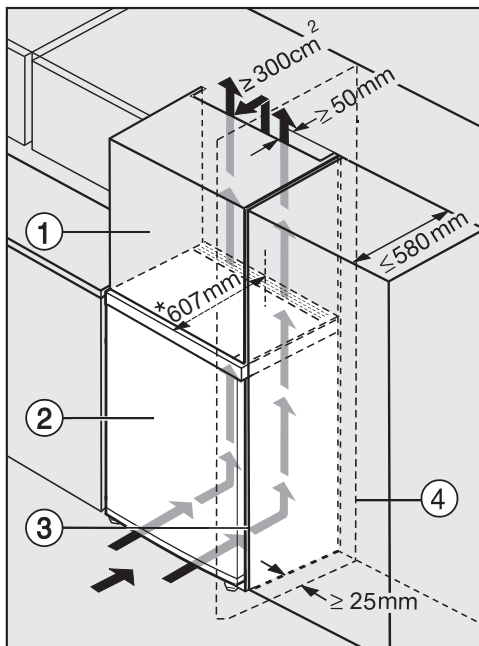

- ① Top box
- ② Refrigeration appliance
- ③ Housing unit
- ④ Wall

* The appliance depth is increased by approx. 35 mm for refrigeration appliances with wall spacers fitted.

 Risk of fire and damage due to insufficient ventilation.
If the refrigeration appliance is not ventilated sufficiently, the compressor will run more frequently and for longer periods. This will result in increased energy consumption and a higher operating temperature for the compressor. This may, in turn, cause damage to the compressor. Please ensure that there is adequate ventilation around the refrigeration appliance.
It is essential to observe the required ventilation gaps.
The ventilation gaps must not be covered or blocked in any way. They must also be regularly dusted.

The larger the ventilation gap, the more economically the compressor will work.

The ventilation gap under the ceiling must be at least 300 cm² to ensure that warm air can escape without obstruction.

- Install the refrigeration appliance next to the kitchen unit.
- The appliance front must protrude in front of furniture fronts by at least the door depth. This enables the appliance door to be opened and shut without being obstructed.
- When installed next to a wall ④, a distance of 25 mm must be maintained on the hinge side between the wall ④ and the refrigeration appliance ②.
- To match the height of the rest of the kitchen units, the refrigeration appliance can be fitted with a suitable top box ①.

A ventilation duct of at least 50 mm depth must be provided across the whole width of the top box.

Installation

Building under

The refrigeration appliance can be pushed under a worktop. If this is done, the refrigeration appliance lid must first be removed.

 Risk of fire and damage due to insufficient ventilation.

If the refrigeration appliance is not ventilated sufficiently, the compressor will run more frequently and for longer periods. This will result in increased energy consumption and a higher operating temperature for the compressor. This may, in turn, cause damage to the compressor.

Please ensure that there is adequate ventilation around the refrigeration appliance.

It is essential to observe the required ventilation gaps.

The ventilation gaps must not be covered or blocked in any way.

They must also be regularly dusted.

* The appliance depth is increased by approx. 35 mm for refrigeration appliances with wall spacers fitted.

With a building-under depth of 600 mm, any back mould on the worktop must not exceed 10 mm in depth.

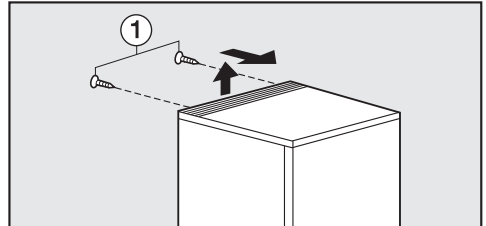

- To remove the lid, unscrew the screws ① from the back of the refrigeration appliance.
- Lift the appliance lid up at the back and then pull it forwards to remove it.

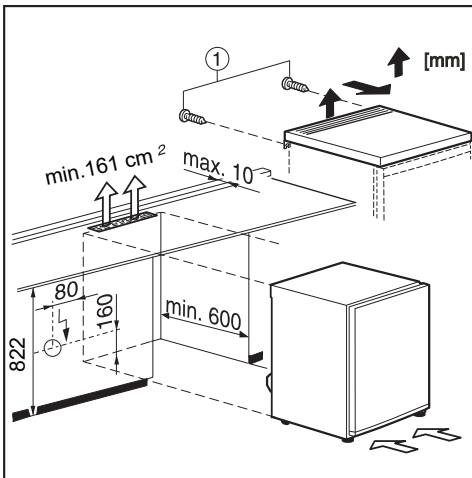

Appliance dimensions

Installation dimensions/View from above

All dimensions are given in mm.

The refrigeration appliance will function correctly if the specified ventilation cross-sections are kept clear.

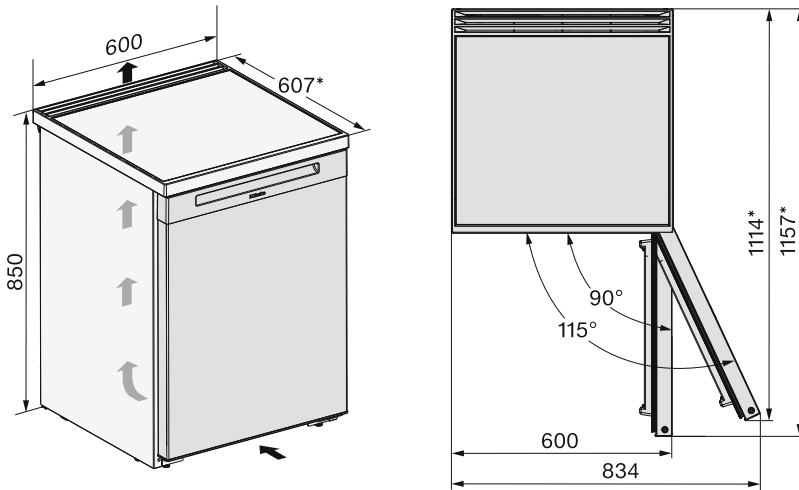

* Dimensions without wall spacers fitted. Appliance depth is increased by 35 mm with the wall spacers supplied fitted.

Installation

Connections

All dimensions are given in mm.

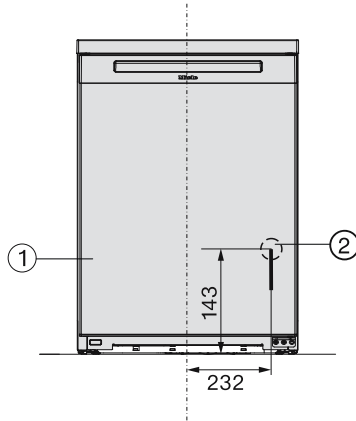

- ① View from the front
- ② Mains connection cable, length = 2200 mm
A longer mains connection cable is available to order from the Miele Customer Service Department.

Electrical connection

The refrigeration appliance must only be connected to an earthed socket using the mains connection cable supplied.

The socket must be easily accessible after the refrigeration appliance has been installed. If the socket is not easily accessible, ensure that a suitable means of disconnection is provided on the installation side for each pole.

 Risk of fire from overheating.

Connecting the refrigeration appliance to a multi-socket plug adapter or to an extension lead can overload the cable.

For safety reasons, do not use an extension lead or multi-socket adapter.

The electrical installation must comply with VDE 0100 requirements.

For safety reasons, we recommend using a type  residual current device (RCD) in the assigned electrical installation for connecting the refrigeration appliance.

If the mains connection cable is damaged, it must only be replaced with a specific mains connection cable of the same type (available from the Miele Customer Service Department). For safety reasons, such replacement may only be carried out by a qualified specialist or the Miele Customer Service Department.

These operating instructions and the data plate indicate the nominal power consumption and the appropriate fuse rating. Compare this information with the data of the on-site electrical connection. If in any doubt, consult a qualified electrician.

Temporary or permanent operation on an autonomous power supply system or a power supply system that is not synchronised with the mains power supply (e.g. island networks, back-up systems) is possible. A prerequisite for operation is that the power supply system complies with the specifications of EN 50160 or an equivalent standard. The function and operation of the protective measures provided in the domestic electrical installation and in this Miele product must also be maintained in isolated operation or in operation that is not synchronised with the mains power supply, or these measures must be replaced by equivalent measures in the installation. As described, for example, in the current version of VDE-AR-E 2510-2.

Connecting the refrigeration appliance

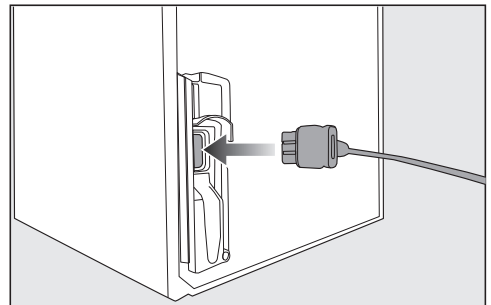

- Insert the plug connector into the socket at the back of the refrigeration appliance.

Make sure that the plug connector has clicked into position correctly.

- Insert the plug of the refrigeration appliance into the socket.

The refrigeration appliance is now connected to the electricity supply.

EU Conformity declaration

Miele hereby declares that this refrigerator complies with Directive 2014/53/EU.

The complete text of the EU declaration of conformity is available from one of the following internet addresses:

- Products, Download from www.miele.ie
- For service, information, operating instructions etc: go to <https://miele.co.uk/manuals> and enter the name of the product or the serial number

Frequency band of the WiFi module	2.4000 GHz – 2.4835 GHz
-----------------------------------	-------------------------

Maximum transmitting power of the WiFi module	< 100 mW
---	----------

UK Conformity declaration

Miele hereby declares that this refrigerator complies with UK Radio Equipment Regulations 2017, as amended.

The complete text of the UK declaration of conformity is available from one of the following internet addresses:

- Products, Download from www.miele.co.uk
- For service, information, operating instructions etc: go to <https://miele.co.uk/manuals> and enter the name of the product or the serial number

Frequency band of the WiFi module	2.4000 GHz – 2.4835 GHz
-----------------------------------	-------------------------

Maximum transmitting power of the WiFi module	< 100 mW
---	----------

This **Statement of Compliance** confirms this Miele product fully complies with the **Product Security and Telecommunications Infrastructure (Security Requirements for Relevant Connectable Products) Regulations 2023**.

- 1) Household Appliance – *Freezer - 120002, 120003, 320001, 320002*
Refrigerator - 110001, 110002, 310001, 310002, 310003
Fridge-freezer - 130001, 130002, 130003, 130004, 330001, 330002
Wine unit - 210007, 310004, 330004
- 2) Manufactured by: Miele & Cie KG,
Carl Miele Street 29, 33332 Gutersloh Germany
Imported by and contact point: Miele Company Ltd, Fairacres, Marcham Road,
Abingdon, Oxon, OX14 ITW Great Britain
- 3) The defined support period at the time of first supply is 10 years
- 4) To report vulnerabilities and cybersecurity issues please contact: psirt@miele.com
- 5) Signature 
Name: **Paul Wright**
Company Position: **Head of Technical Management**
Date of signature: **19th March 2024**
Place of signature: **Abingdon, Oxfordshire**

Copyrights and licences

For the purpose of operating and controlling the communication module, Miele uses proprietary or third-party software that is not covered by open source licensing terms. This software/these software components are protected by copyright. The copyrights held by Miele and third parties must be respected.

Furthermore, the communication module integrated in the appliance contains software components which are distributed under open source licence conditions. The open source components contained in the appliance along with the corresponding copyright notices, copies of the licensing terms valid at the time and any further information can be accessed locally by IP via a web browser ([http\[s\]://<IP address>/Licenses](http[s]://<IP address>/Licenses)). The liability and warranty arrangements for the open source licences displayed in this location only apply in relation to the respective rights holders.

United Kingdom

Miele Co. Ltd., Fairacres, Marcham Road, Abingdon, Oxon, OX14 1TW
Tel: 0330 160 6600, Internet: www.miele.co.uk, E-mail: info@miele.co.uk

Australia

Miele Australia Pty. Ltd.
ACN 005 635 398
ABN 96 005 635 398
Level 4, 141 Camberwell Road
Hawthorn East, VIC 3123
Tel: 1300 464 353
E-mail: info@miele.com.au
Internet: www.miele.com.au

China Mainland

Miele Electrical Appliances Co., Ltd.
1-3 Floor, No. 82 Shi Men Yi Road
Jing' an District
200040 Shanghai, PRC
Tel: +86 21 6157 3500
Fax: +86 21 6157 3511
E-mail: info@miele.cn
Internet: www.miele.cn

Hong Kong, China

Miele (Hong Kong) Ltd.
41/F - 4101, Manhattan Place
23 Wang Tai Road
Kowloon Bay, Hong Kong
Tel: (852) 2610 1025
Fax: (852) 3579 1404
E-mail:
customerservices@miele.com.hk
Website: www.miele.hk

India

Miele India Pvt. Ltd.
1st Floor, Copia Corporate Suites,
Commercial Plot 9, Mathura Road,
Jasola, New Delhi - 110025
E-mail: customercare@miele.in
Website: www.miele.in

Ireland

Miele Ireland Ltd.
2024 Bianconi Avenue
Citywest Business Campus
Dublin 24
Tel: (01) 461 07 10
Fax: (01) 461 07 97
E-mail: info@miele.ie
Internet: www.miele.ie

Malaysia

Miele Sdn Bhd
Suite 12-2, Level 12
Menara Sapura Kencana
Petroleum
Solaris Dutamas No. 1
Jalan Dutamas 1
50480 Kuala Lumpur, Malaysia
Phone: +603-6209-0288
Fax: +603-6205-3768

New Zealand

Miele New Zealand Limited
IRD 98 463 631
8 College Hill
Freemans Bay, Auckland 1011
Tel: 0800 464 353
E-mail: customercare@miele.co.nz
Internet: www.miele.co.nz

Singapore

Miele Pte. Ltd.
29 Media Circle
#11-04 ALICE@Mediapolis
Singapore 138565
Tel: +65 6735 1191
Fax: +65 6735 1161
E-mail: info@miele.com.sg
Internet: www.miele.sg

South Africa

Miele (Pty) Ltd.
63 Peter Place, Bryanston 2194
P.O. Box 69434, Bryanston 2021
Tel: (011) 875 9000
Fax: (011) 875 9035
E-mail: info@miele.co.za
Internet: www.miele.co.za

Thailand

Miele Appliances Ltd.
BHIRAJ TOWER at EmQuartier
43rd Floor Unit 4301-4303
689 Sukhumvit Road
North Klongton Sub-District
Vadhana District
Bangkok 10110, Thailand

United Arab Emirates

Miele Appliances Ltd.
Showroom 1, Eiffel 1 Building
Sheikh Zayed Road, Umm Al Sheif
P.O. Box 114782 - Dubai
Tel. +971 4 3044 999
Fax. +971 4 3418 852
800-MIELE (64353)
E-mail: info@miele.ae
Website: www.miele.ae

Manufacturer: Miele & Cie. KG, Carl-Miele-Straße 29, 33332 Gütersloh, Germany

K 4002 ..., K 4003 ...

en-GB

M.-Nr. 12 539 200 / 02