





















Operating instructions Wine unit



It is **essential** to read the operating and installation instructions before setup, installation, and commissioning. This prevents both personal injury and damage to the appliance.

Contents

Warnings and safety notes	4	Adjusting the interior fittings	22
Sustainability and environmental protection	13	Removing and reinserting the wooden shelves	22
How to save energy	14	Adjusting the wooden shelf (FlexiFrame) to the bottle size	22
Familiarisation	15	Maximum capacity.....	23
Appliance description	15	Maximum load for the wooden shelves	23
Appliance overview	15	Maximum load with the stacking aid	24
Display.....	17	Labelling the labelling strip (NoteBoard)	24
Settings mode 	18	Using the PresenterFrame	25
Feature lighting 	18	Accessories supplied.....	25
Lock function  / 	18	Optional accessories	26
Switching off the wine unit (all wine conditioning zones together) 	18	Commissioning	27
Sabbath mode 	18	Before using for the first time.....	27
Information on Sabbath mode 	18	Connecting the wine unit	27
Time before door alarm  is triggered	18	Activating the charcoal filter (Active AirClean filter) 	27
Networking 	18	Positioning the wooden slats on the wooden shelves	27
Keypad tone  / 	18	Setting up the stacking aid	27
Alarms and buzzers  / 	18	Switching the wine unit on	27
Display brightness 	19	Switching the wine unit off.....	28
Temperature unit °C/°F	19	Switching off for longer periods of time	28
Demo mode 	19	Requirements for networking	28
Factory defaults 	19	Setting up networking for the first time.....	28
Information on the wine unit 	19	Performing Scan & Connect.....	29
Active AirClean filter display 	19	Operation	30
Networking	20	Setting the temperatures in the wine conditioning zones.....	30
Safety	20	Temperature range	30
Temperature alarm.....	20	Temperature display for the wine conditioning zones	30
Door alarm	21	Setting the humidity (ActiveHumidity) in the lower wine conditioning zone 	31
Using the door lock.....	21	Humidity range	31
		Querying the current humidity level 	31

Adjusting settings	32
Cleaning and care	37
Cleaning agents	37
Preparing the wine unit for cleaning	38
Cleaning the inside of the appliance	38
Replacing the Active AirClean filter (charcoal filter)	38
Confirming that the Active AirClean filter has been changed	39
Cleaning the front of the appliance and the side panels	39
Cleaning the door seal	40
Cleaning the ventilation openings... ..	40
After cleaning	40
Automatic defrosting	40
Troubleshooting	41
Interior lighting	48
Noises	49
Customer Service Department	51
Contact in the event of a fault	51
EPREL database	51
Warranty	51
Installation	52
Installation site	52
Ventilation requirements	53
Installing several wine units/refrigeration appliances	53
Changing the door hinging	54
Installing the wine unit	54
Aligning the wine unit	55
Integrating the wine unit in a run of kitchen units	55
Appliance dimensions	57
Electrical connection	59
EU Conformity declaration	61
UK Conformity declaration	62
Copyrights and licences	63

Warnings and safety notes

This wine unit complies with all current local and national safety requirements. Inappropriate use can, however, lead to personal injury and material damage.

Read the operating and installation instructions carefully before using the wine unit. They contain important information on installation, safety, use and maintenance. This is to protect yourself from injury, and from damaging your wine unit.

In accordance with standard IEC 60335-1, Miele expressly and strongly advises that you read and follow the instructions in the section on installing the wine unit as well as the warning and safety notes.

Miele cannot be held liable for injury or damage caused by non-compliance with these instructions.

Keep these operating and installation instructions in a safe place and pass them on to any future owner.

 Risk of injury from broken glass.

If installed at altitudes above 1500 m there is a risk of the glass in the appliance door breaking because of changes in air pressure. Shards of glass can cause severe injury.

Correct application

► This wine conditioning unit is intended for use in the home and in similar environments, for example

- in shops, offices and similar work settings
- on agricultural estates
- by the guests in hotels, motels, bed & breakfasts and other typical home settings.

This wine conditioning unit is not intended for outdoor use.

► The wine unit is intended for domestic use only for storing wine. The wine unit is not suitable for freezing food. Any other usage is not permitted.

▶ The wine conditioning unit is not suitable for storing and keeping cool medicines, blood plasma, laboratory preparations or other such materials or products. Incorrect use of the wine conditioning unit for such purposes can cause deterioration of the items stored. The wine conditioning unit is not suitable for use in areas where there is a risk of explosion.

Miele cannot be held liable for damage resulting from improper or incorrect use of the appliance.

▶ This wine conditioning unit may only be used by people (including children) with reduced physical, sensory or mental capabilities or lack of experience and knowledge if they are supervised whilst using it.

The wine conditioning unit may only be used by these people without supervision if they have been shown how to use it in a safe way and recognise and understand the consequences of incorrect operation.

Safety with children

▶ Children under 8 years of age must be kept away from the wine conditioning unit unless they are constantly supervised.

▶ Children aged 8 and older may only use the wine conditioning unit without supervision if they have been shown how to use it in a safe manner. Children must be able to understand and recognise the possible dangers caused by incorrect operation.

▶ Children must not be allowed to clean or maintain the wine conditioning unit unsupervised.

▶ Please supervise children in the vicinity of the wine conditioning unit and do not let them play with it.

▶ Danger of suffocation. Whilst playing, children may become entangled in packaging material (such as plastic wrapping) or pull the packaging material over their head, presenting the risk of suffocation. Keep packaging material away from children.

Warnings and safety notes

Technical safety

▶ The refrigerant circuit has been checked for leaks. The wine conditioning unit complies with statutory safety requirements and the appropriate EU directives.



▶ Warning: fire hazard/flammable materials. This symbol is on the compressor and indicates flammable materials. Do not remove this sticker.

The refrigerant inside the appliance (details on the data plate) is environmentally friendly but flammable.

The use of this refrigerant does, however, sometimes lead to a slight increase in the noise level of the appliance. In addition to the noise of the compressor, you might be able to hear the refrigerant flowing around the cooling circuit. Unfortunately, this cannot be avoided, but it does not affect the performance of the wine unit.

When transporting and installing the wine unit, ensure that no parts of the cooling circuit are damaged. Splashes of refrigerant can damage the eyes and leaking refrigerant can ignite.

In the event of damage:

- Avoid naked flames or anything which creates a spark.
- Disconnect the wine unit from the mains electricity supply.
- Ventilate the room where the wine unit is located for several minutes.
- Contact the Miele Customer Service Department.

▶ The more refrigerant there is in a wine unit, the larger the room it should be installed in. In the event of a leakage, if the appliance is in a small room, there is the danger of a combustible gas/air mixture building up. For every 8 g of refrigerant at least 1 m³ of room space is required. The amount of refrigerant in the wine unit is stated on the data plate inside the appliance.

▶ To avoid the risk of damage to the wine conditioning unit, make sure that the connection data (fuse rating, frequency and voltage) on the data plate corresponds to the household supply.

Check that this is the case before connecting the wine conditioning unit. Consult a qualified electrician if in any doubt.

Warnings and safety notes

▶ The electrical safety of this wine unit can only be guaranteed when continuity is complete between it and an effective earthing system. It is essential that this basic safety feature is present.

If in doubt, the electrical installation should be checked by a qualified electrician.

▶ Temporary or permanent operation on an autonomous power supply system or a power supply system that is not synchronised with the mains power supply (e.g. island networks, back-up systems) is possible. A prerequisite for operation is that the power supply system complies with the specifications of EN 50160 or an equivalent standard.

The function and operation of the protective measures provided in the domestic electrical installation and in this Miele product must also be maintained in isolated operation or in operation that is not synchronised with the mains power supply, or these measures must be replaced by equivalent measures in the installation. As described, for example, in the current version of BS OHSAS 18001–2 ISO 45001.

▶ The socket must not be concealed behind the wine conditioning unit and must be easily accessible so that the appliance can be quickly disconnected from the electrical supply in case of an emergency.

▶ If the mains connection cable is damaged, disconnect the wine unit from the mains power supply immediately. Contact the Miele Customer Service Department.

▶ If the mains connection cable is damaged, it must only be replaced with a specific mains connection cable of the same type (available from the Miele online shop or Miele Customer Service). For safety reasons, such replacement may only be carried out by a qualified specialist or Miele Customer Service.

▶ Do not connect the wine conditioning unit to the mains electrical supply by a multi-socket adapter or extension lead. These are a fire hazard and do not guarantee the required safety of the appliance.

▶ If moisture gets into electrical components, it could cause a short circuit. Therefore, do not operate this wine conditioning unit in areas which are exposed to moisture (e.g. in a garage or utility room).

▶ This wine conditioning unit must not be used in a non-stationary location (e.g. on a ship).

Warnings and safety notes

- ▶ Do not use a damaged wine conditioning unit. It could be dangerous. Check the wine conditioning unit for visible signs of damage.
- ▶ This wine unit is not intended for use as a built-in appliance.
- ▶ The wine conditioning unit must be isolated from the electricity supply during installation, maintenance and repair work. It is only completely isolated from the power supply when:
 - the mains fuses are switched off, or
 - the screw-out fuse is removed (where applicable), or
 - the mains cable has been unplugged. Pull on the plug and not the cable when disconnecting it from the power supply.
- ▶ Unauthorised installation, maintenance or repairs could result in unforeseen dangers for the user, for which the manufacturer cannot accept liability.
Installation, maintenance or repairs must only be carried out by a qualified specialist or Miele Customer Service.
- ▶ The manufacturer's warranty will be invalidated if the wine unit is not repaired by a qualified specialist or Miele Customer Service.
- ▶ We recommend replacing defective components with original spare parts. If original Miele spare parts are installed correctly, Miele ensures full compliance with safety requirements and the warranty remains valid.
- ▶ This wine unit is fitted with a special lamp to cope with particular conditions (e.g. temperature, moisture, chemical resistance, abrasion resistance and vibration). This lamp must only be used for the purpose for which it is intended. The lamp is not suitable for room lighting. Replacement lamps may only be fitted by a qualified specialist or by Miele Customer Service. This wine unit contains several light sources with at least energy efficiency class G.

Proper installation

- ▶ Change the door hinging (if necessary) as described in the installation instructions.
- ▶ Always wear protective gloves when transporting, changing the door hinging and setting up the wine unit.
- ▶ The wine unit is heavy and can tip forwards when the appliance door(s) is (are) open:

Warnings and safety notes

- At least 2 people are required to transport or move the wine unit.
- At least 2 people are required to change the door hinging of the wine unit.
- At least 2 people are required to install the wine unit.
- Never leave the wine unit unattended while it is being installed.

Correct use

▶ This wine unit is designed for use within specific ambient temperatures (climate range). Do not use in ambient temperatures for which it is not designed. The climate range is stated on the data plate inside the wine unit. A lower ambient temperature will cause the compressor to switch off for longer periods, meaning that the wine unit is unable to maintain the required temperature in some circumstances.

▶ The ventilation cross-sections must not be covered or blocked in any way. This can impair the proper ventilation of the appliance, increase the energy consumption and cause damage to the components.

▶ Risk of damage due to greasy or oily foods. If the wine unit is used for storing food which contains fat or oil, make sure that it does not come into contact with plastic components. Any spillages of oil or fat could cause stress cracks to the plastic and cause it to break or split.

▶ Risk of fire and explosion due to flammable mixes of gases. Do not store explosive materials in the wine unit or any products containing propellants (e.g. spray cans). Electrical components can cause flammable mixes of gases to ignite. The spray cans in question can be identified by the contents printed on the can or by a flame symbol. Electrical components can cause escaping gases to ignite.

▶ Danger of explosion. Do not operate any electrical appliances inside the wine conditioning unit. Danger of sparking and explosion.

Accessories and spare parts

▶ We recommend using original Miele accessories. If other parts are used, warranty, performance and/or product liability claims will be invalidated.

▶ Miele original spare parts are kept in stock for at least 10 years and up to 15 years after discontinuation of your wine unit.

Warnings and safety notes

Cleaning and care

▶ Do not use any oils or grease on the door seals, as these will cause the seals to deteriorate and become porous with time.

▶ Do not use a steam cleaning appliance to clean this wine conditioning unit.

The steam could reach electrical components and cause a short circuit.

▶ Warning. Do not use any mechanical tools or other types of aid which are not recommended by the manufacturer to accelerate the defrosting process.

▶ Sharp edged or pointed objects will damage the evaporator, causing irreversible damage to the wine conditioning unit. Do not use sharp edged or pointed objects to

- remove frost and ice,
- remove labels, stickers etc.

Transport

▶ Always transport the wine conditioning unit in an upright position and in its original transport packaging to avoid damage in transit.

▶ Risk of injury and damage. The wine unit is very heavy and must be transported by two people.

Disposal of your old appliance

▶ Children playing could become trapped in the wine unit and could suffocate.

- Remove the appliance door.
- Leave the wooden/metal shelves in the wine unit so children cannot climb inside.
- If the wine unit has a door lock, make sure that children cannot lock themselves inside while playing as this could endanger their lives.

▶ Risk of electric shock!

- Cut the plug off the mains connection cable.
- Cut the mains connection cable off the old appliance.

Dispose of the plug and mains connection cable separately from the old appliance.

▶ During and after disposal, make sure that the wine unit is not placed near petrol or other flammable gases and liquids.

▶ Risk of fire due to escaping oil or refrigerant.

The refrigerant and oil inside the appliance are flammable. In high enough concentrations, escaping refrigerant or oil can ignite if they come into contact with an external heat source.

During disposal, make sure that the cooling circuit is not damaged.

This prevents refrigerant and oil escaping in an uncontrolled manner (see the data plate for details of the refrigerant).

▶ Splashes of coolant can damage the eyes. Be careful not to damage any part of the pipework whilst awaiting disposal, e.g. by

- puncturing the coolant channels in the condenser,
- bending any pipework, or
- scratching the surface coating.

Symbol on the compressor (depending on model)

This information is only relevant for recycling. There is no risk during normal operation.
--

Warnings and safety notes



- ▶ The oil in the compressor can be fatal if swallowed or if it penetrates the airways.

Disposing of the packaging material

The packaging material is used for handling and protects the appliance from transport damage. The packaging material used is selected from materials which are environmentally friendly for disposal and can generally be recycled.

Recycling the packaging material reduces the use of raw materials. Use material-specific collection points for valuable materials and take advantage of return options. Your Miele dealer will take the packaging material away.

Disposing of your old appliance

Electrical and electronic appliances contain many valuable materials. They also contain certain materials, compounds and components which were essential for their correct functioning and safety. These could be hazardous to human health and to the environment if disposed of with household waste or if handled incorrectly. Please do not, therefore, dispose of your old appliance with household waste.



Take care not to damage your refrigeration appliance before or during disposal in an authorised, environmentally friendly manner.

This is to ensure that refrigerant in the cooling circuit and oil in the compressor is contained, and will not leak into the environment.

Instead, please make use of officially designated collection and disposal points to dispose of and recycle electrical and electronic appliances in your local community, with your dealer or with Miele, free of charge. By law, you are solely responsible for deleting any personal data from the old appliance prior to disposal. You are legally obliged to remove any old batteries which are not securely enclosed by the appliance and to remove any lamps without destroying them, where this is possible. These must be taken to a suitable collection point where they can be handed in free of charge. Please ensure that your old appliance poses no risk to children while being stored for disposal.

Sustainability and environmental protection

How to save energy ...

- Installation site** The wine unit has to cool more often at higher ambient temperatures and consumes more energy in the process. Therefore:
- Install the wine unit in a well-ventilated room.
 - Do not install the wine unit near to a heat source (heater element, cooker).
 - Protect the wine unit from direct sunlight.
 - Ensure an ideal ambient temperature of 20 °C.
 - Clean the ventilation gaps on a regular basis to remove any dust.
- Temperature setting** The colder the temperature, the higher the energy consumption. The following settings are recommended:
- +12 to +14 °C
- Use** Energy consumption is increased by heat input and impeded air circulation. Therefore:
- Only open the appliance door when necessary and for as short a time as possible. Arrange the wine bottles in such a way that makes them easy to find in the appliance.
 - Always close the appliance door properly after opening it.
 - Keep wooden shelves arranged as they were when the appliance was delivered.
 - Do not overfill the wooden shelves to allow air to circulate.
 - Keep the fan air ducts in the wine unit clear.
 - Maintain a distance of 25 mm between the back of the appliance and the wall.

Appliance description

Appliance overview

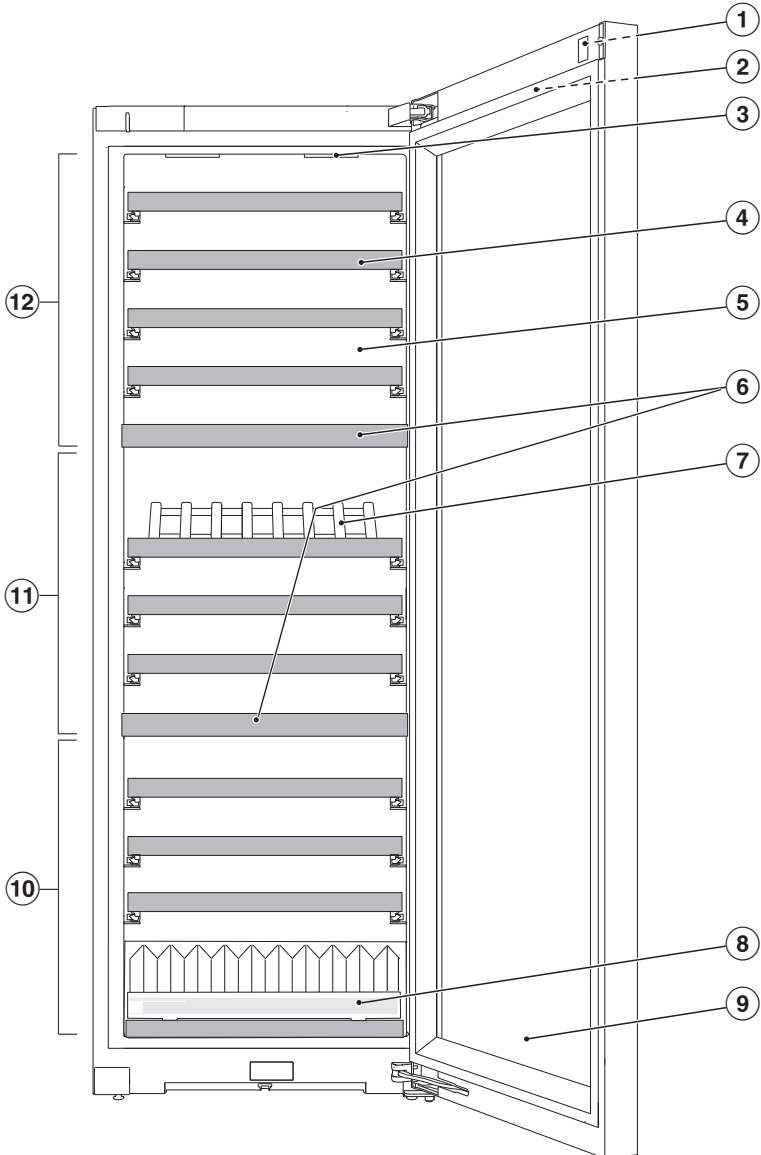

Familiarisation

- ① Door lock
- ② Outer display on appliance door
- ③ Interior lighting and feature lighting 
(in all wine conditioning zones)
- ④ Wooden shelves with labels (FlexiFrames with Noteboard)
- ⑤ Dry rear panel to prevent condensate
- ⑥ Insulating plate between the wine conditioning zones: different types of wine can be stored at different temperatures at the same time.

Charcoal filters: the Active AirClean filters are located behind the NoteBoards.

- ⑦ PresenterFrame
- ⑧ Stacking aid for optimised bottle storage
- ⑨ Glass door: the safety glass door with UV filter and protects your wine from harmful UV rays.
- ⑩ Lower wine conditioning zone with humidity setting (ActiveHumidity) for long-term storage
- ⑪ Middle wine conditioning zone
- ⑫ Upper wine conditioning zone

Display

The display can be scratched by pointed or sharp objects, e.g. pens.
Only touch the display with your fingertips.
It is possible that the display will not react to finger contact if your fingers are cold.

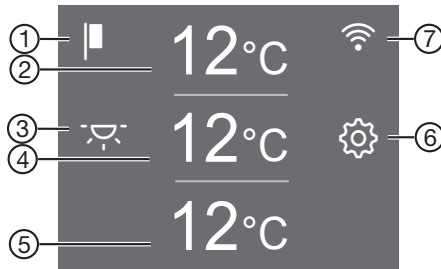



- ① Demo mode display
(only visible when the Demo mode function has been switched on)
- ② Temperature display for upper wine conditioning zone and sensor control for setting the temperature
- ③ Feature lighting sensor control ☀
For switching the interior lighting on and off when the appliance door is closed
- ④ Temperature display for middle wine conditioning zone and sensor control for setting the temperature
- ⑤ Temperature display for lower wine conditioning zone and sensor control for setting the temperature and humidity (ActiveHumidity)
- ⑥ Settings mode ⚙
sensor control for adjusting various settings in Settings mode
- ⑦ Display for connection status
(only visible if the network has been set up)

Familiarisation

Settings mode

Feature lighting

The interior lighting can be set to remain on when the appliance door is closed so your wines can be on display at all times.

The feature lighting is switched on and off using the  sensor control in the display. When the feature lighting is switched on, the  sensor control lights up orange.

The feature lighting can be switched on or off separately for each individual wine conditioning zone (see “Adjusting settings”).

Lock function /

When the lock function is switched on, it protects the wine unit from being switched off unintentionally and being adjusted unintentionally by unauthorised persons, e.g. children.

If you just want to quickly adjust the temperature, for example, you can deactivate the lock function temporarily (see “Adjusting settings”).

Switching off the wine unit (all wine conditioning zones together)

See “Commissioning – Switching the wine unit off”.

Sabbath mode

The wine unit offers a Sabbath mode for the purposes of religious observance (see “Adjusting settings”).

When Sabbath mode is switched on, the following are deactivated temporarily:

- Interior lighting when the appliance door is opened
- Feature lighting when the appliance door is closed
- The display
- All visual and audible signals
- An active WiFi connection
- Reminders (e.g. Active AirClean filter display): the set time interval is paused

All other functions switched on previously remain activated.

When Sabbath mode is switched on, you cannot make any settings on your wine unit.

Information on Sabbath mode

You can call up the Sabbath mode version here.

Time before door alarm is triggered

You can set the time before the appliance door alarm is triggered here.

Networking

Here you can set up networking for the first time, deactivate and activate the WiFi or reset the network configuration (see “Adjusting settings”).

Keypad tone /

You can switch the keypad tone on or off here (see “Adjusting settings”).

Alarms and buzzers

You can change the volume of the alarms and buzzers (e.g. in the event of a door alarm or a fault message) here.

Alternatively, you can switch the alarms and buzzers off completely if you find them annoying (see “Adjusting settings”).

Display brightness

You can adjust the display brightness to the lighting conditions in the room here (see “Adjusting settings”).

Temperature unit °C/°F

You can set the required temperature unit (°Celsius or °Fahrenheit) here (see “Adjusting settings”).

Demo mode

You can switch off demo mode here if it has been switched on as a default setting ( will show in the display) (see “Adjusting settings”).

Demo mode allows the wine unit to be presented in the showroom without the cooling system being switched on. This setting is not needed for domestic use.

Factory defaults

You can reset the wine unit’s settings to their factory defaults here (see “Adjusting settings”).

Tip: Reset the settings to the factory defaults when disposing of your wine unit, selling it or putting a used wine unit into operation. This will reset the network configuration so that your personal data is deleted from the wine unit. This will also ensure that a previous owner is no longer able to access the wine unit.

Information on the wine unit

You can call up the model identifier and serial number of your wine unit here.

Keep this appliance data to hand:

- For integrating the wine unit into your WiFi network (see “Adjusting settings – Setting up Miele@home for the first time”)
- When reporting an appliance fault to the Miele Customer Service Department (see “Customer Service Department”)
- When retrieving information from the EPREL database (see “Customer Service Department”)

Active AirClean filter display

Filtering the air through the Active AirClean filters ensures that the air remains free from dust and odours.

The Active AirClean filter display  will remind you approx. every 12 months that the Active AirClean filters have to be replaced (see “Cleaning and care – Replacing the Active AirClean filter (charcoal filter)”).

You can activate the Active AirClean filter display  here (see “Adjusting settings”).

Familiarisation

Networking

Your wine unit is equipped with an integrated WiFi module. The WiFi module makes it possible to connect to your home network and to use the Miele app on a mobile device.

Once your wine unit has been connected via WiFi, the connection is automatically re-established every time it is switched on.

Make sure that your WiFi network signal is strong enough in the place where you intend to install your wine unit.

Connecting your wine unit to your WiFi network will increase energy consumption, even when the unit is switched off.

Smart Extras via the Miele app*

Networking via the Miele app gives you access to numerous Smart Extras, including:

- Access status information.
- Use additional helpful functions.
- Keep your wine unit up to date with the latest Miele developments via software updates.

You can find more detailed information about Smart Extras on the Miele website, in the Apple App Store® or in the Google Play Store™.

*This is a separate digital offer from Miele & Cie. KG. The range of functions can vary depending on the model and the country. Acceptance of the Terms and Conditions and Privacy Policy for Miele digital products & services in the Miele app required. Miele reserves the right to change or discontinue the digital offer at any time.

Safety

Temperature alarm

The wine unit is equipped with a temperature alarm so that the temperature cannot rise or fall unnoticed and therefore damage the wine.

If the temperature becomes too warm or too cold,  will light up red in the corresponding temperature display. An alarm will also sound until the cause of the alarm is rectified or the alarm is switched off.

The set temperature determines when the appliance recognises a temperature as being too warm or too cold.

The audible and visual signals may be activated in the following situations:

- Too much warm ambient air enters the wine unit when you are rearranging or taking out wine bottles.
- You are storing a large number of wine bottles.
- There was a power failure.
- There is a fault with the wine unit.

Switching the temperature alarm off early

Before you switch the temperature alarm off, you must determine the cause and rectify it.

If you are bothered by the sound of the alarm, you can switch the alarm off early.

■ Tap .

 goes out and the alarm will stop.

The warmest temperature recorded in the wine conditioning zone concerned will flash for about 1 minute in the temperature display for the wine conditioning zone. Then the temperature display will change to the current temperature in the wine conditioning zone.

Door alarm

The wine unit is fitted with a door alarm to avoid increased energy consumption if the door is left open and prevent the stored wine bottles being affected by temperature fluctuations.

If the appliance door is left open for a longer period of time,  will light up yellow in the display. An alarm will also sound and the interior lighting will flash.

The amount of time until the door alarm is triggered can be changed (see “Adjusting settings – Changing the time until the door alarm  is triggered”).

The door alarm’s audible signal can also be switched off (see “Adjusting settings – Changing the volume of the alarms and buzzers /”).

The alarm will stop and  will go out on the display as soon as the appliance door is closed.

Switching the door alarm off early

■ Tap the  symbol.

The alarm will stop, the  symbol will go out and the interior lighting will light up again constantly.

If the appliance door is not closed, the door alarm will sound again after around 1 minute.

Using the door lock

You can use the mechanical door lock to protect your wine collection against unauthorised access.

Locking and unlocking the wine unit

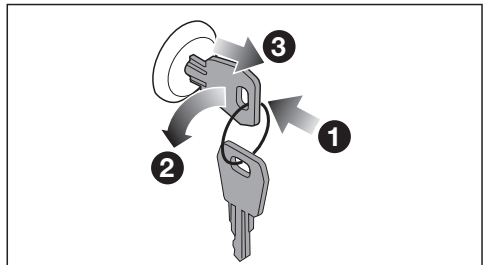

- Insert the key in the door lock **1** in the appliance door.
- To lock the door: press the door lock in and turn the key 90° anticlockwise **2**.
- Pull the key out **3** and keep it in a safe place.
- To unlock the door: insert the key into the door lock, press the door lock in and turn the key 90° clockwise.

Familiarisation

Adjusting the interior fittings

Removing and reinserting the wooden shelves

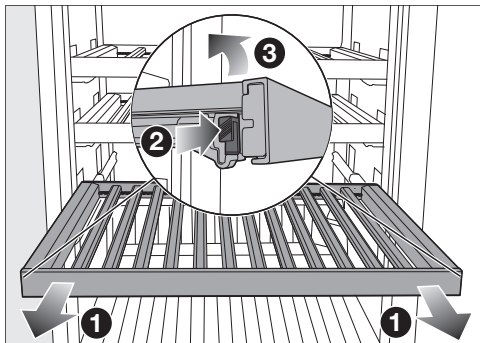

- Pull the wooden shelf out until it stops ①.
- Press in the latches ② on both sides of the wooden shelf and lift the wooden shelf upwards ③.
- To reinsert the wooden shelf, first place it on the rear of the extended rails so that it clicks into place.
- Press the front section of the wooden shelf down onto the extended rails so that the latches click into place.

 Risk of injury from falling wine bottles.

Wine bottles may become wedged in the wooden shelves above and fall out of the wine unit/refrigeration appliance when the shelves are pulled out.

Always pull out the wooden shelves slowly and carefully.

 Risk of damage and injury from broken glass.

If wooden shelves and bottles protrude too far forwards, they may damage the glass door when it is closed.

Please ensure that the wooden shelves and wine bottles do not protrude.

Adjusting the wooden shelf (FlexiFrame) to the bottle size

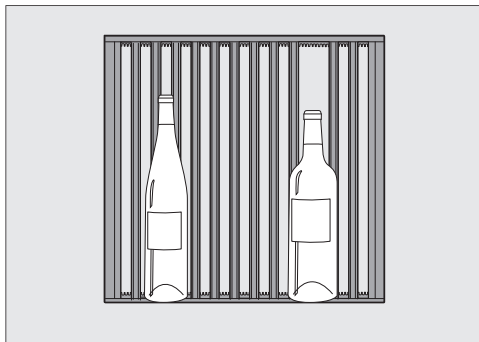

- You can remove or move individual wooden slats on the wooden shelf as required.

This allows you to flexibly adapt the wooden shelf to the size of your wine bottles.

Maximum capacity

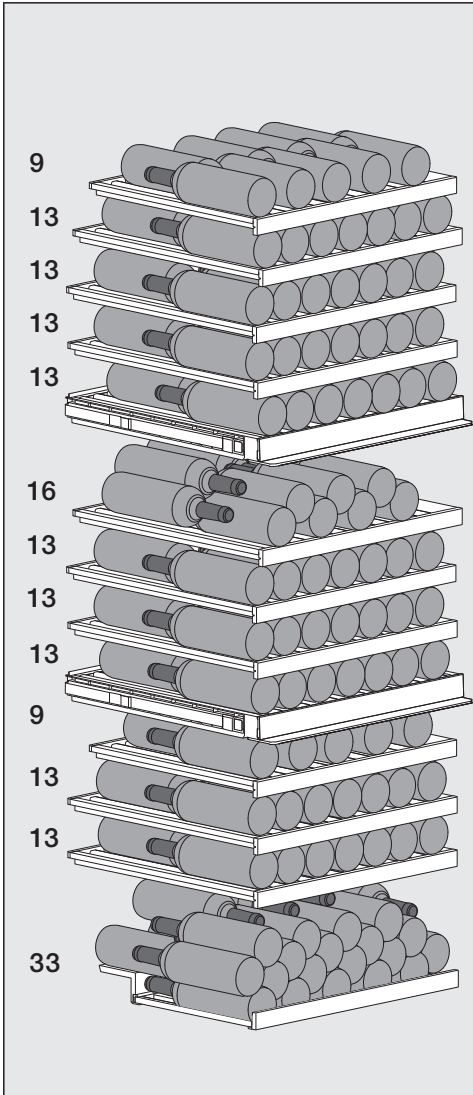

Up to 184 Bordeaux bottles (0.75 l) can be stored in the wine unit:

- 61 bottles in the upper wine conditioning zone
- 55 bottles in the middle wine conditioning zone
- 68 bottles in the lower wine conditioning zone (of which 33 bottles stacked on the stacking aid on the lower wooden shelf)

Maximum load for the wooden shelves

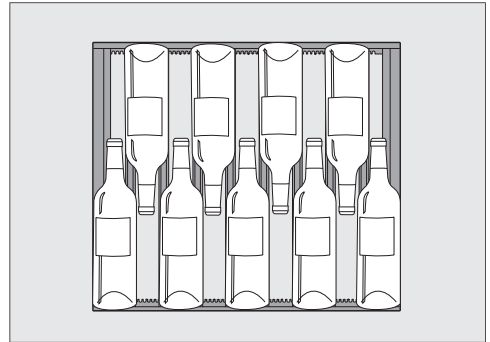

Arrangement of 9 bottles on the top wooden shelves in the upper and lower wine conditioning zones

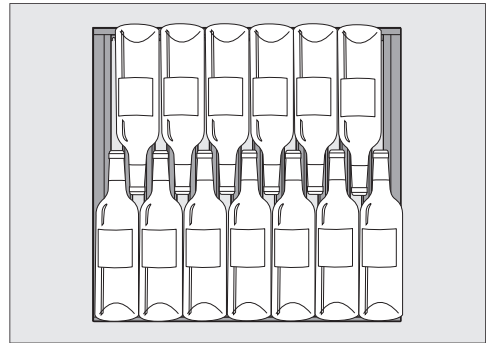

Arrangement of 13 bottles on the other wooden shelves

Familiarisation

 Risk of damage due to overload. Exceeding the maximum recommended capacity can lead to damage to the wooden shelves.

Do not exceed the maximum load-bearing capacity of 25 kg for each wooden shelf. The PresenterFrame can bear a load of 40 kg.

Do not stack bottles on the wooden shelves.

Maximum load with the stacking aid

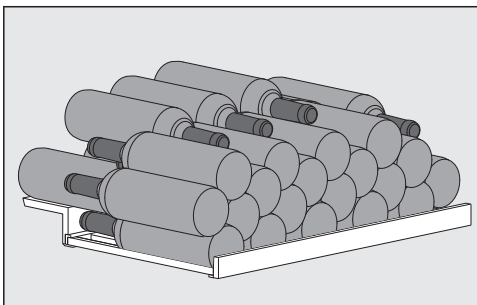

Arrangement of 33 wine bottles on the stacking aid

Labelling the labelling strip (NoteBoard)

For quick and easy identification of the wines stored, you can write on the NoteBoards on the wooden shelves.

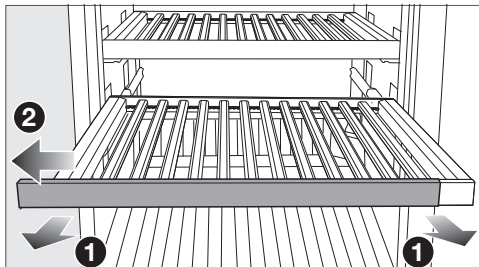

- Pull the wooden shelf out a little towards the front ①.
- Pull the NoteBoard to one side away from the wooden shelf ②.
- The labelling strip can be wiped clean with a damp cloth.

 Risk of damage from unsuitable cleaning agents.

Cleaning the labelling strips (NoteBoards) with a cleaning agent may damage the coating on them. Use clean water only to wipe the NoteBoards.

- Label the NoteBoard with the chalk pen supplied. Alternatively, we recommend the following products for labelling:
 - Liquid chalk pens, such as an edding 4095 chalk marker
 - Traditional blackboard chalk

 Risk of damage due to writing with the wrong products.

Never write on the NoteBoard with a ballpoint pen, crayon or pencil, correction pencil, wax crayon, oil chalk or felt-tip pen (e.g. permanent marker, highlighter, foil pen, etc.). They are difficult or impossible to remove from the NoteBoard.

Only use the products recommended to write on the NoteBoard as these can be removed easily.

- Slide the NoteBoard onto the wooden shelf from the side.

Using the PresenterFrame

The PresenterFrame can be used to present selected wines so that the wine bottle labels are visible even with the appliance door closed.

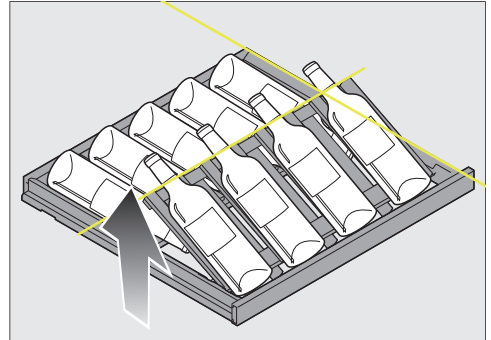

- Set up the front part of the PresenterFrame.
- Position your wine bottles on the PresenterFrame.

Wine bottles that have already been opened can also be perfectly stored on the PresenterFrame.

- If required, switch on the feature lighting  to highlight the selected wine bottles.

Accessories supplied

Key for locking the appliance door

Active AirClean filter

The Active AirClean filters between the wine conditioning zones ensure optimum air quality by filtering the incoming air.

Familiarisation

Chalk pen

Use the chalk pen supplied to label the NoteBoards on the wooden shelves. By labelling the NoteBoards you will have a good overview of the types of wine being stored.

Optional accessories

Products specially tailored to your wine unit – such as appliance care products and accessories – are available from the Miele online shop, from Miele Customer Service or from your Miele specialist dealer.

You can access the Miele online shop via the following QR code:



Before using for the first time



- Remove all packaging material and protective film.
- Clean the inside of the appliance and the accessories (see “Cleaning and care”).

Connecting the wine unit

- Connect the wine unit to the electricity supply as described in “Installation – Electrical connection”.

Miele will then appear on the appliance display, followed by .

Activating the charcoal filter (Active AirClean filter)

- Activate the Active AirClean filter display  (see “Adjusting settings – Activating the Active AirClean filter display ”).

Positioning the wooden slats on the wooden shelves

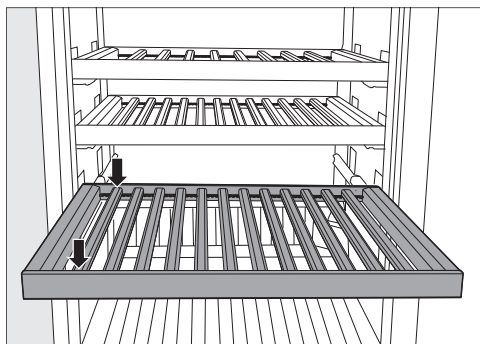

- Position the wooden slats at equal intervals on the wooden shelf and lock them into position.

This provides space on the wooden shelf for the maximum number of bottles (0.75 l; Bordeaux-style bottles).

Setting up the stacking aid

The stacking aid helps to achieve the maximum capacity in the lower wine conditioning zone.

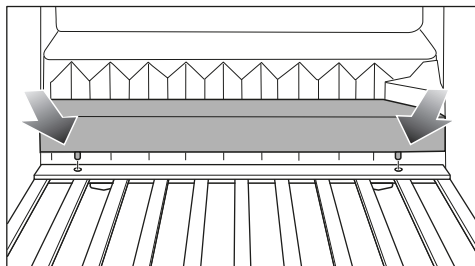

- Insert the stacking aid behind the lower wooden shelf.
- Snap the feet of the stacking aid into the holders on the left and right.

Switching the wine unit on

- Tap  on the display.



If you do not interact with the display for a certain period of time, it switches to energy-saving mode and goes dark.

The wine unit will start to cool and the interior lighting will come on when the appliance door is opened.

Depending on the ambient temperature and the temperature setting, it can take the appliance a few hours to reach the temperature required in the corresponding wine conditioning zones and for this temperature to then be shown as a constant temperature on the display.

Commissioning

Switching the wine unit off

- Tap .
- Swipe left or right until  is shown in the middle.
- Tap .

The cooling and interior lighting are switched off.

 will appear in the display.

Please note: The wine unit is not disconnected from the power supply when it is switched off.

Switching off for longer periods of time

If, during a long absence, the wine unit is switched off but not cleaned and the door left shut, there is a danger of mould building up inside the appliance.
The wine unit must be cleaned.

If the wine unit is not going to be used for a longer period of time, observe the following:

- Switch the wine unit off.
- Switch off at the wall and disconnect the plug from the socket, or disconnect the fuse.
- Clean the wine unit and leave the door ajar to air the wine unit and avoid odours building up inside it.

Requirements for networking

Note the following requirements for networking:



1. A home network is available at the installation site.
Have the WiFi password ready.
2. The Miele app is available on a mobile device.
3. You have a user account in the Miele app.

Miele App

The Miele App is available to download free of charge from the Apple App Store® or from the Google Play Store™.



Setting up networking for the first time

- Tap the .
- Swipe left or right until the  symbol is shown in the middle.
- Tap the .
- Tap the connection method you wish to use (app or WPS).

After you have successfully logged in, the  symbol will appear on the display.

If a connection could not be established, the  symbol will appear.

- In this case, start the process again.
- To leave the Settings level, tap the .

Performing Scan & Connect

- Scan the QR code.

If you have installed the Miele app and have a user account, you will be taken directly to the networking steps.

If you have not yet installed the Miele app, you will be taken to the Apple App Store® or the Google Play Store™.

- Install the Miele app and set up a user account.
- Scan the QR code again.

The Miele app will guide you through the setup process.





Operation

Setting the temperatures in the wine conditioning zones

The temperatures in the 3 wine conditioning zones can be set independently of one another.

A temperature of between 12 and 14 °C is recommended to store wine over the long term.

- Touch the temperature display for the wine conditioning zone you want to change.
- **Lower wine conditioning zone:** tap .
- Swipe left or right until the temperature you want is shown in the middle.
- Tap the temperature you want to confirm.
- To leave this Settings level, tap .

The temperature display will then change back to the current temperature in the wine conditioning zone.

The temperature in the wine unit will rise:

- The more often the appliance door is opened and the longer it is kept open
- The more wine bottles are being stored
- The warmer the newly stored wine bottles are
- The higher the ambient temperature surrounding the wine unit This wine unit is designed for use within specific ambient temperatures (climate range). Do not use in ambient temperatures for which it is not designed.

Temperature range

In all wine conditioning zones, it is possible to set temperatures between 5 and 20 °C.

Temperature display for the wine conditioning zones

In normal operation, the temperature display shows the **current average temperature** inside the corresponding wine conditioning zone.

Depending on the ambient temperature and the temperature setting, it can take the appliance a few hours to reach the temperature required and for this temperature to then be shown as a constant temperature in the display.

Setting the humidity (ActiveHumidity) in the lower wine conditioning zone $\delta\text{--}\Delta$

An ambient temperature of between 19 and 28 °C is required to ensure that the humidity level is set perfectly.

- Touch the temperature display for the lower wine conditioning zone.
- Swipe left or right until $\delta\text{--}\Delta$ is shown in the middle.
- Tap $\delta\text{--}\Delta$.
- Swipe left or right until the humidity (δ , $\delta\delta$, $\delta\delta\delta$) you want is shown in the middle.
- Tap to confirm the setting.
- To leave this Settings level, tap \leftarrow .

Depending on the ambient temperature and the set humidity level, it can take the appliance a few days to reach the set humidity level and for this to then be shown in the display.

Humidity range

You can set the humidity to 3 levels and therefore adapt it to your individual needs.

- δ : Low humidity
- $\delta\delta$: Medium humidity
- $\delta\delta\delta$: High humidity

Please bear in mind that energy consumption will increase slightly as the set humidity level is increased.

If you would like to use the lower wine conditioning zone for the long-term storage of wine bottles with natural corks, we recommend setting a medium humidity level $\delta\delta$.

Querying the current humidity level **i**

















Depending on the ambient temperature and the set humidity level, it can take the appliance a few days to reach the set humidity level and for this to then be shown in the display.

- Touch the temperature display for the lower wine conditioning zone.
- Swipe left or right until $\delta\text{--}\Delta$ is shown in the middle.
- Tap **i**.

The display shows the **current humidity level** in the lower wine conditioning zone (the value is averaged over approx. 2 hours).

- Tap \checkmark to exit the display.





Adjusting settings

	Settings mode
	Set the brightness of the feature lighting.
	Switch the locking function on, deactivate it temporarily or switch it off completely.
	Switch Sabbath mode on or off.
	Call up the Sabbath mode version.
	Change the time before the door alarm is triggered.
	Networking
	APP / WPS Set up networking for the first time.
	Activate or deactivate the WiFi connection.
	Reset the network configuration.
	Switch the keypad tone on or off.
	Change the volume of the alarms and buzzers or switch off the alarms and buzzers completely.
	Adjust the display brightness.
	Change the temperature unit.
	Switch the demo mode off (only visible when switched on).
	Reset the settings to their factory default settings.
	Access information about your refrigeration appliance.
	Activate the Active AirClean filter display.



The door alarm and other warnings are automatically disabled when the appliance is in Settings mode .

Setting the brightness of the feature lighting



The feature lighting can be set separately at different brightness levels for each individual wine conditioning zone or switched off completely.

- Tap .
- Swipe left or right until  is shown in the middle.
- Tap .
- Swipe left or right until the wine conditioning zone you want is shown in the middle.
- Tap the wine conditioning zone you want.
- Select the brightness you want by swiping the segment bar to the left or right (level 1–7).
- If you want to switch the feature lighting off completely, swipe to the left until the segment bar goes out completely.
- Confirm the setting you want by tapping the segment bar.
- Alternatively: confirm the setting you want by tapping .
- To leave this Settings level, tap .

Switching the lock function / on

- Tap .
- Swipe left or right until  is shown in the middle.
- Tap .

When the lock function is switched on,  will light up orange.

- To leave this Settings level, tap .
- Open and close the appliance door. Only then will the lock function  be active.

Deactivating the lock function / temporarily





- Touch the temperature display for the wine conditioning zone you want to change.
- Touch  for approx. 6 seconds.

The display switches to the temperature controls.

- Now select the required settings.

Opening and closing the appliance door will reactivate the lock function .

Switching the lock function / off completely



- Tap the .
- Touch the  symbol for approx. 6 seconds.
- Swipe left or right until the  symbol is shown in the middle.
- Tap the .

When the lock function is switched off, the  symbol will light up white.

- To leave the Settings level, tap the .

Switching Sabbath mode on

When Sabbath mode  is switched on, you cannot change any settings.

- Tap the .
- Swipe left or right until the  symbol is shown in the middle.

Adjusting settings

- Tap the  symbol.

The  symbol will light up orange.

- To leave the Settings level, tap the  symbol.

If Sabbath mode  is switched on, this is indicated on the display for approx. 3 seconds.

The display then switches off.

Ensure that the appliance door is properly closed, as visual and audible alarms are switched off.

Switching Sabbath mode off

The Sabbath mode function  will switch off automatically after approx. 80 hours.

However, you can switch the Sabbath mode function  off early.

- Tap the black display.

The  symbol appears.

- Tap the  symbol.

The  symbol will light up orange.

- Tap the  symbol again.

When Sabbath mode is switched off, the  symbol will light up white.

- To leave the Settings level, tap .

Changing the time before the door alarm is triggered

- Tap the  symbol.

- Swipe left or right until the  symbol is shown in the middle.

- Tap the  symbol.

- Swipe left or right until the time you want between 30 seconds and 3 minutes 30 seconds is shown in the middle.

- Tap to confirm the setting.

- To leave the Settings level, tap the  symbol.

Setting up networking for the first time

- Tap the  symbol.

- Swipe left or right until the  symbol is shown in the middle.

- Tap the  symbol.

- Tap the connection method you wish to use (app or WPS).

After you have successfully logged in, the  symbol will appear on the display.

If a connection could not be established, the  symbol will appear.

- In this case, start the process again.

- To leave the Settings level, tap the  symbol.

Activating the WiFi connection

- Tap the  symbol.

- Swipe left or right until the  symbol is shown in the middle.

- Tap the  symbol.

- Tap the  symbol to activate the WiFi connection.

The  symbol appears.

- To leave the Settings level, tap the  symbol.

When the WiFi connection is active, the  symbol will light up on the display.

Deactivating the WiFi connection

- Tap the  symbol.

- Swipe left or right until the  symbol is shown in the middle.







- Tap the  symbol.

- Tap the  symbol to deactivate the WiFi connection.

The  symbol appears.

- To leave the Settings level, tap the  symbol.

Resetting the network configuration



- Tap .
- Swipe left or right until  is shown in the middle.
- Tap .
- Swipe right until  is shown in the middle.
- Tap .
- Tap .
- To leave this Settings level, tap .

All entered settings and values for Miele@home are reset to the default settings.

The WiFi connection has been deactivated.  will go out on the display.

The network configuration should be reset whenever a wine unit is being disposed of or sold, or if a used wine unit is being put into operation. All personal data is removed from the wine unit. This will also ensure that a previous owner is no longer able to access the wine unit.



Switching on the keypad tone

- Tap the .
- Swipe left or right until the  symbol is shown in the middle.
- Tap the .

If the keypad tone is switched on, the  symbol will light up orange.

- To leave the Settings level, tap the  symbol.



Switching off the keypad tone

- Tap the .
- Swipe left or right until the  symbol is shown in the middle.
- Tap the .

If the keypad tone is switched off, the  symbol will light up white.

- To leave the Settings level, tap the  symbol.

Changing the volume of the alarms and buzzers /



- Tap the .
- Swipe left or right until the  symbol is shown in the middle.
- Tap the .
- Select the volume you want by swiping the segment bar to the left or right (level 1–7).
- If you want to switch the alarms and buzzers off completely, swipe to the left until the segment bar goes out completely.
- Confirm the setting you want by tapping the segment bar.

When the alarms and buzzers are switched off, the  symbol will light up white.

When the alarms and buzzers are switched on, the  symbol will light up orange.

- To leave the Settings level, tap the  symbol.

Changing the display brightness

- Tap the .
- Swipe left or right until the  symbol is shown in the middle.
- Tap the .

Adjusting settings

- Select the brightness you want by swiping the segment bar to the left or right (level 1–7).
- Confirm the setting you want by tapping the segment bar.
- To leave the Settings level, tap the ↩ symbol.





Changing the temperature unit °C/°F

- Tap the ⚙ symbol.
- Swipe left or right until °C or °F is shown in the middle.
- Tap °C or °F to change the temperature unit.

°C or °F will appear on the display.



- To leave the Settings level, tap the ↩ symbol.

Switching off demo mode

- Tap .
- Tap .
- Swipe left or right until  is shown in the middle.
- Tap .

After demo mode  has been switched off, the wine unit shuts down and must be switched on again.

Resetting the settings to their factory defaults



- Tap .
- Swipe left or right until  is shown in the middle.
- Tap .

 will appear in the display.

- Tap .

The wine unit shuts down and must be switched on again.

Activating the Active AirClean filter display

- Tap .
- Swipe left or right until  is shown in the middle.
- Tap .

If the Active AirClean filter display is activated,  will light up orange.

- To leave this Settings level, tap ↩.

The data plate located inside the wine unit must not be removed. It contains information which is required in the event of a fault.

Do not let water get into the electronic unit or the lighting.

 Risk of damage due to moisture ingress.

The steam from a steam cleaner can damage plastic and electrical components.

Do not use a steam cleaner to clean the wine unit.

 Health risk due to soiling entering the appliance.

Soiling that enters the appliance from outside (such as food or drink residues) can cause mould to form in the wine unit at increased temperature and humidity levels.

Only place clean wine bottles and clean accessories in the wine unit.

- Dishwasher cleaning agents
- Oven sprays
- Cleaning agents for ceramic hobs (except to clean the glass front)
- Glass-cleaning agents (except to clean the glass front: for this, a glass-cleaning agent containing a little alcohol, but no citric or similar additives, may be used)
- Hard, abrasive sponges and brushes (e.g. pot scourers)
- Eraser stain remover blocks
- Sharp metal scrapers

We recommend using a clean sponge cloth and lukewarm water with a little washing-up liquid to clean the surfaces of the appliance.

Cleaning agents

Cleaning agents and care products used inside the wine unit must be food safe.

To avoid damaging the surfaces of the appliance, **do not use the following:**

- Cleaning agents containing soda, ammonia, acids or chlorides
- Cleaning agents containing descaling agents
- Abrasive cleaning agents (e.g. scouring powder, scouring liquid or pumice stones)
- Cleaning agents containing solvents
- Stainless steel cleaners

Cleaning and care

Preparing the wine unit for cleaning

- Switch the wine unit off.

⏻ appears in the display and the cooling system is switched off.

- Take any wine bottles out of the wine unit and store them in a cool place.
- If necessary, take out all removable parts for cleaning (see “Familiarisation – Adjusting the interior fittings”).
- Remove the labelling strips (NoteBoards) from the wooden shelves before cleaning them.

Cleaning the inside of the appliance

Clean the wine unit at least once a month.

If soiling is left on for any length of time, it may become impossible to remove under certain circumstances. Surfaces may suffer discolouration or damage.

It is therefore best to remove any soiling immediately.

- Clean the interior with a clean sponge cloth, lukewarm water and a little washing-up liquid.
- Rinse all parts by hand. Do not wash in a dishwasher.
- The **wooden** shelves should only be wiped with a well wrung-out damp cloth. They must **not** be allowed to get wet.

⚠ Risk of damage from unsuitable cleaning agents.

Cleaning the labelling strips (NoteBoards) with a cleaning agent may damage the coating on them.

Use clean water only to wipe the NoteBoards.

- After cleaning, wipe with clean water and dry with a cloth.
- Leave the door open to air the wine unit sufficiently for a short while and to prevent odour build-up.

Replacing the Active AirClean filter (charcoal filter)

New Active AirClean filters can be obtained from the Miele Customer Service Department, your Miele dealer or the Miele website.

The Active AirClean filters are located behind the NoteBoards (labelling strips) between the wine conditioning zones.

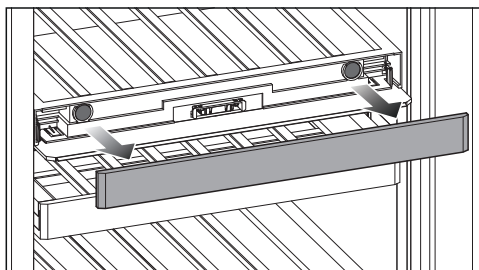

- Pull the NoteBoard off.

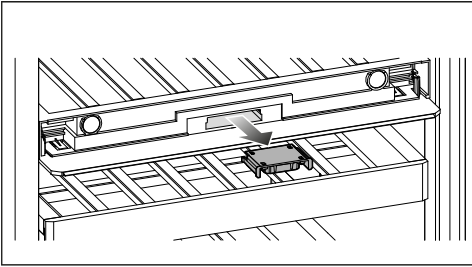

- Pull the filter holder out.

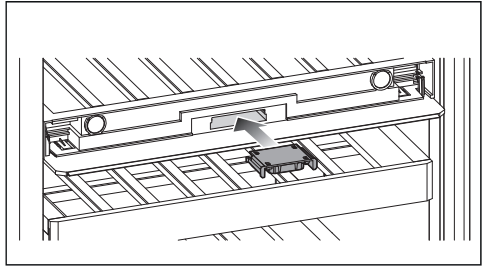

- Reinsert the filter holder with the new AirClean filter.

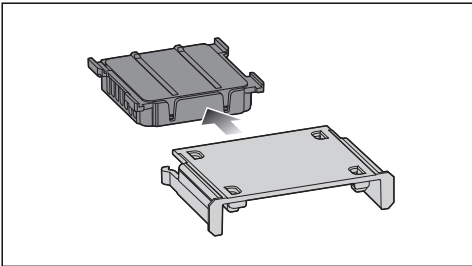

- Remove the used Active AirClean filter.
- Used Active AirClean filters can be disposed of with normal household waste.

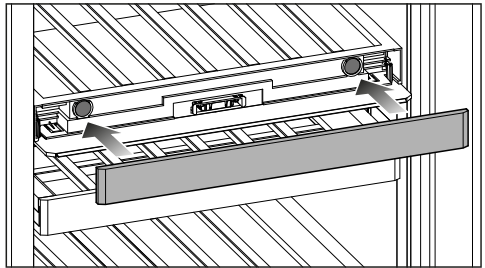

- Fit the NoteBoard in position.

Confirming that the Active AirClean filter has been changed

- Touch the 🌐 symbol on the display.

The 🌐 symbol will go out and the counter will be reset.

Cleaning the front of the appliance and the side panels

If soiling is left on for any length of time, it may become impossible to remove. Surfaces may suffer discoloration or damage. Therefore, it is best to remove soiling from the appliance front and side panels immediately.

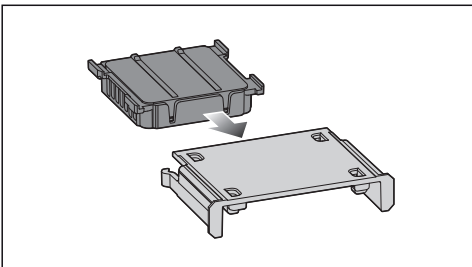

- Insert the new Active AirClean filter into the filter holder.

Cleaning and care

All surfaces are susceptible to scratching. Contact with unsuitable cleaning agents can alter or discolour the surfaces.

See the information on “Cleaning agents” at the beginning of this section.

- Clean the surfaces with a clean sponge and a solution of warm water and washing-up liquid. A clean, damp microfibre cloth without cleaning agent can also be used.
- After cleaning, wipe with clean water and dry with a soft cloth.
- Clean the appliance door with a proprietary glass cleaner.

Cleaning the door seal

 Risk of damage as a result of incorrect cleaning.

If you treat the door seal with oils or grease, it can become porous.

Do not use any oils or grease on the door seal.

- The door seal should be cleaned regularly with clean water, and then wiped dry with a soft cloth.

Cleaning the ventilation openings

- The ventilation openings should be cleaned on a regular basis with a feather duster or vacuum cleaner (you could use a Miele vacuum cleaner dusting brush, for example).

After cleaning

- Replace all shelves and accessories in the wine unit.
- Switch the wine unit on.
- Place the wine bottles in the wine unit and close the appliance door.

Automatic defrosting

The wine unit defrosts automatically.

Many malfunctions and faults can be easily remedied. You can save time and money in many cases, as you do not need to contact Customer Service.

More information to help you remedy faults yourself can be found at www.miele.co.uk/support/customer-assistance.



To prevent cold from escaping, open the appliance as little as possible until the fault has been corrected.

General problems with the wine conditioning unit





Problem	Cause and remedy
The wine unit is not cooling.	The wine unit is not switched on. ■ Switch the wine unit on.
	The mains plug is not inserted in the socket correctly or the plug connector is not inserted into the socket at the back of the appliance correctly. ■ Insert the mains plug into the mains socket and the plug connector into the appliance socket correctly and switch on.
	The mains fuse has tripped. There could be a fault with the wine unit, the household electrical wiring or another electrical appliance. ■ Contact a qualified electrician or the Miele Customer Service Department.

Troubleshooting







Problem	Cause and remedy
<p>The compressor is switching on more frequently and for longer periods of time, the temperature in the wine unit is falling.</p>	<p>The ventilation openings have been covered or become dusty.</p> <ul style="list-style-type: none"> ■ Do not block the ventilation openings. ■ Dust the ventilation openings regularly.
	<p>The appliance door has been opened too frequently. A large number of wine bottles have been placed in the appliance.</p> <ul style="list-style-type: none"> ■ Only open the appliance door when necessary and for as short a time as possible. <p>After a while, the temperature will return to normal by itself.</p>
	<p>The appliance door is not properly closed.</p> <ul style="list-style-type: none"> ■ Close the appliance door. <p>After a while, the temperature will return to normal by itself.</p>
	<p>The ambient temperature is too high. The higher the ambient temperature, the longer the compressor runs.</p> <ul style="list-style-type: none"> ■ See the information in “Installation – Installation site”.
	<p>The temperature in the wine unit is set too low.</p> <ul style="list-style-type: none"> ■ Correct the temperature setting.
	<p>The temperature in the wine unit is too high.</p>
<p>The ambient temperature is too low for this wine unit. If the ambient temperature is too low, the compressor will run less frequently. The temperature in the wine unit rises.</p> <ul style="list-style-type: none"> ■ See the information in “Installation – Installation site”. ■ Increase the ambient temperature. 	















Problem	Cause and remedy
<p>The humidity inside the lower wine conditioning zone cannot be set to the required level.</p>	<p>The display shows changes in the actual humidity in the wine unit with a time delay.</p> <ul style="list-style-type: none"> ■ Check the humidity again at a later point in time.
	<p>The ambient temperature is too high or too low.</p> <ul style="list-style-type: none"> ■ Ensure an ambient temperature of 19 to 28 °C.
	<p>The temperature in the lower wine conditioning zone was set too high.</p> <ul style="list-style-type: none"> ■ Set a maximum temperature of 10 °C in the lower wine conditioning zone.
	<p>The ambient humidity is too low.</p> <ul style="list-style-type: none"> ■ If the ambient humidity is very low, it is sometimes not possible to achieve a high humidity level inside the wine unit.
	<p>The humidity inside the wine unit depends on how often and for how long the door is opened, on the ambient temperature and ambient humidity, on how full the appliance is, and on the appliance settings.</p>
<p>The wooden slats in the wooden shelves are warping.</p>	<p>A change in volume due to moisture absorption or drying out is a typical characteristic of wood. An increase in humidity in the wine unit causes wooden components to warp. Therefore, under certain circumstances, wooden parts can warp and cracks can develop. Knots and grain patina are part of the natural character of the wood.</p>
<p>Mildew has begun to form on the wine bottle labels.</p>	<p>Mildew can begin to form on the labels, depending on the type of label adhesive used.</p> <ul style="list-style-type: none"> ■ Clean the wine bottles and remove any adhesive residue.
<p>A white deposit has formed on the wine bottle corks.</p>	<p>The corks have oxidised due to contact with the air.</p> <ul style="list-style-type: none"> ■ Use a dry cloth to wipe off the deposit. The deposit will not affect the quality of the wine.

Troubleshooting



Problem	Cause and remedy
<p>There is no audible alarm even though the appliance door has been open for a long time.</p>	<p>This is not a fault. The alarm has been switched off in Settings mode. If you want to switch the audible alarm back on again:</p> <ul style="list-style-type: none"> ■ Tap the  symbol. ■ Swipe left or right until the  symbol is shown in the middle. ■ Tap the  symbol. ■ Select the volume you want by swiping the segment bar to the right. ■ Confirm the setting you want by tapping the segment bar. <p>When the alarms and buzzers are switched on, the  orange symbol will light up.</p>
<p>Condensation has built up inside the wine unit. The appliance door may not close correctly.</p>	<p>The door seal has come out of its groove.</p> <ul style="list-style-type: none"> ■ Check that the door seal is correctly positioned in the groove. <p>The door seal is damaged.</p> <ul style="list-style-type: none"> ■ Check whether the door seal is damaged.
<p>The door seal is damaged or needs to be replaced.</p>	<p>No tools are required to change the door seal.</p> <ul style="list-style-type: none"> ■ Change the door seal. A replacement is available from Miele or from specialist retailers.







Display warnings

Message	Cause and remedy
<p> lights up in the display and the wine unit is not getting cold. However, the appliance and the interior lighting are working fine.</p>	<p>Demo mode has been activated.</p> <ul style="list-style-type: none"> ■ Tap . ■ Tap . ■ Swipe left or right until  is shown in the middle. ■ Tap . <p>After demo mode  has been switched off, the wine unit shuts down and must be switched on again.</p>

Message	Cause and remedy
<p>Nothing is visible in the display. The display is completely blank.</p>	<p>Sabbath mode  is switched on: the interior lighting is switched off and the wine unit is cooling down.</p> <ul style="list-style-type: none"> ■ Tap the black display. <p> will appear in the display.</p> <ul style="list-style-type: none"> ■ Tap . <p> will light up orange.</p> <ul style="list-style-type: none"> ■ Tap the  symbol again. <p>When Sabbath mode is switched off, the  symbol will light up white.</p> <hr/> <p>The display is not connected to the wine unit correctly.</p> <ul style="list-style-type: none"> ■ Was the door hinging changed correctly? Check the plug connection between the wine unit and the display again (see accompanying installation instructions). <hr/> <p>Energy-saving mode is switched on: if you do not interact with the display for a certain period of time, it switches to energy-saving mode and goes dark.</p>
<p> lights up in the display and the wine unit cannot be used.</p>	<p>The lock function has been activated.</p> <ul style="list-style-type: none"> ■ Unlock the wine unit temporarily or switch the lock function off completely (see “Adjusting settings”).
<p> lights up in the display and a buzzer sounds.</p>	<p>The Active AirClean filter display  is reminding you that the Active AirClean filter needs to be changed.</p> <ul style="list-style-type: none"> ■ Replace the Active AirClean filter (see “Cleaning and care – Replacing the Active AirClean filter”). Confirm that you have changed the Active AirClean filter by touching  in the display. <p> will go out on the display.</p>
<p> will light up yellow in the display, an alarm will also sound and the interior lighting will flash.</p>	<p>The door alarm has been activated.</p> <ul style="list-style-type: none"> ■ Tap . <p>The alarm will stop,  will go out and the interior lighting will light up again constantly.</p>

Troubleshooting

Message	Cause and remedy
<p> will light up red in one of the wine conditioning zones and an alarm tone will also sound.</p>	<p>The temperature alarm has been activated. The temperature in the wine conditioning zone concerned has risen higher or fallen lower than the temperature set. Possible reasons for this include:</p> <ul style="list-style-type: none">– The appliance door has been opened frequently.– The ventilation openings have been blocked.– A prolonged power cut has occurred. <p>■ Tap .</p> <p> goes out and the alarm will stop.</p> <p>The warmest temperature recorded in the wine conditioning zone concerned will flash for about 1 minute in the temperature display for the wine conditioning zone. Then the temperature display will change to the current temperature in the wine conditioning zone.</p> <p>You can exit from the flashing temperature display early:</p> <p>■ Touch the temperature display for the wine conditioning zone.</p> <p>The warmest temperature display will disappear. The temperature display will then revert to showing the current temperature in the wine conditioning zone.</p> <p>■ Remedy the cause of the alarm.</p>

Message	Cause and remedy
<p> lights up red in the display and an alarm also sounds.</p>	<p>Indication of a power failure: the temperature in the wine unit over the last few days or hours has risen too high because of a power failure or interruption to the power supply.</p> <ul style="list-style-type: none"> ■ Tap . <p> goes out and the alarm will stop.</p> <p>The warmest temperature recorded in the wine unit will flash for about 1 minute in the temperature display. Then the temperature display will change to the current temperature.</p> <p>You can exit from the flashing temperature display early:</p> <ul style="list-style-type: none"> ■ Tap the temperature display. <p>The warmest temperature display will disappear. The temperature display will then revert to showing the current temperature. The wine unit will go back to the last temperature setting when the power is back on.</p> <ul style="list-style-type: none"> ■ Remedy the cause of the alarm.
<p> lights up red in the display and a fault code F with numbers may appear. An alarm is also sounding.</p>	<p>There is a fault.</p> <ul style="list-style-type: none"> ■ Tap  on the display to switch the alarm off. ■ Contact the Miele Customer Service Department. <p>To report the fault, you need the fault code and also the model identifier and serial number of your wine unit. You can access this information on the display:</p> <ul style="list-style-type: none"> ■ To do this, touch  on the display. <p>The appliance data required will be shown on the display.</p> <p>Confirm with  to exit the information display and the fault code will be shown again on the display.</p> <p>The wine unit can be switched off directly from the fault message display.</p> <hr/> <p>There is an appliance fault: this display always has priority over any settings which have just been selected.</p> <p>An appliance fault has priority over any current door and/or temperature alarms displayed.</p>

Troubleshooting

Interior lighting



Risk of electric shock due to exposed, live electrical components.

When removing the lighting cover, there is a risk of coming into contact with live electrical components.









Do not remove the lighting cover. The LED lighting may only be repaired or replaced by the Miele Customer Service Department.



Risk of injury from LED lighting.

This lighting corresponds to risk group RG 2. If the cover is defective, there is a risk of eye injury.

If the lighting cover is defective, do not look from a close range directly into the lighting with optical instruments (e.g. magnifying glass or similar).

Problem	Cause and remedy
The interior lighting is not working.	The wine unit is not switched on. ■ Switch the wine unit on.
	Sabbath mode  is switched on: the display is dark and the wine unit is cooling. ■ Tap the black display.  will appear in the display. ■ Tap  .  will light up orange. ■ Tap the  symbol again. When Sabbath mode is switched off,  will light up white.
	To avoid overheating, the interior lighting switches itself off automatically after approx. 15 minutes if the appliance door is left open. If this is not the case, then there is a fault. ■ Contact the Miele Customer Service Department.
The interior lighting is on even when the appliance door is closed.	This is not a fault. The feature lighting is switched on. ■ To switch off the feature lighting, touch the sensor control for the feature lighting  in the display. The  sensor control no longer lights up orange.
The interior lighting is pulsating.	This is not a fault. The door alarm has been activated.

Noises

The wine unit is producing various noises during operation.
 If the cooling performance is low, the wine unit will conserve energy but operate for longer. The volume will be lower.
 Items will be chilled faster if the cooling performance is high.
 The volume will be higher.

Normal noises	What is causing them?
Hissing	Refrigerant is being injected into the cooling circuit.
Bubbling, gurgling, splashing	Refrigerant is circulating through the pipes.
Humming	The wine unit is cooling.
Clicking	The thermostat is switching the compressor on or off.
Humming, whirring	The fan is running.
Cracking	Materials are expanding inside the wine unit.
Rattling	Valves or flaps are active.
Slurping (wine unit with soft-close mechanism)	The appliance door with soft-close mechanism is being opened or closed.

Please bear in mind that a certain amount of noise is unavoidable (from the compressor and the refrigerant circulating through the cooling circuit).

Troubleshooting

Noises	Cause and remedy
Vibrating, rattling, clinking	The wine unit is uneven. Realign the wine unit using a spirit level. Do this by raising or lowering the adjustable feet underneath the wine unit (depending on the model). For built-in appliances: For niches of 140 cm and more: place the stabilising rods supplied underneath the appliance base.
	The wine unit is touching another appliance or piece of furniture. Move the wine unit away.
	Drawers, baskets or shelves are jiggling or are stuck. Check all removable items and refit them correctly.
	Bottles or containers are touching. Separate bottles or containers slightly.
	The transport cable clips (depending on the model) are hanging loose at the back of the appliance. Remove the transport cable clips.

Information to help you rectify faults yourself and about Miele spare parts can be found at www.miele.com/service.

Contact in the event of a fault

In the event of a fault which you cannot remedy yourself, please contact your Miele dealer or Miele Customer Service.

You can book a Miele Customer Service call-out online at www.miele.com/service.

Contact information for Miele Customer Service can be found at the end of this document.

Please quote the model identifier and serial number of your appliance (SN) when contacting Miele Customer Service. Both numbers can be found on the data plate inside the refrigeration appliance or, depending on the model, in Settings mode under Information **i**.

EPREL database

Since 1 March 2021, information on energy labelling and ecodesign requirements has been available in the European Product Database (EPREL). You can find the product database at the following link <https://eprel.ec.europa.eu/>. You will be asked to enter the model identifier.

The model identifier can be found on the data plate inside the refrigeration appliance or, depending on the model, in Settings mode under Information **i**.

Miele			
XXXXXX		Nr. XX/XXXXXXXXXX.	
WEINTEMPERATURSCHRANK-UNTERTISCHMODELL MULTI-TEMPERATURE WINE STORAGE CABINET-UNDERCOUNTER TOP ARMOIRE DE MISE EN TEMP. DES VINS/BOC. ENCASTRABLE SOUS PLAN АРМОРИТЪП.АССОЦИЦИОНАТО. ВЪНСАМОДЕЛПОТРУБНОУСЪОМЕРНА ВИННИЙ ТЕМПЕРАТУРНЫЙ ШРАФ			
Klasse/Class Classe/Clase SN-ST	Ap-Typ/AP-Type AP-Tipo/AP-Tipo	Bruttinhalt/Gross Capacity Volume Brut/Capacità Bruta XXXX l	Gefriervermögen/Freezing Capacity Pouvoir de Congel/Capac. Congeladora
Nutzinhalt Net Capacity Volume Utile Capac. Util	Ges. / K / F / G Tot. / R / F / C Tot. / R / C Tot. / F / C	/WEIN / KALT /WINE / CHILL /WINE / CHILL /WINE / CHILL	R600a: XXg

Warranty

For information on the appliance warranty specific to your country please contact Miele. See back cover for address.

In the UK, your appliance warranty is valid for 2 years from the date of purchase. However, you must activate your cover by calling 0330 160 6640 or registering online at www.miele.co.uk.

Installation

Installation site

 Risk of fire and damage from appliances which give off heat.

Appliances which give off heat can catch fire and set fire to the wine unit.

The mains connection cable must not come into contact with heat sources.

Do not place appliances which give off heat, such as mini-ovens, double burner hobs or toasters, on the wine unit.

 Fire risk and risk of damage from open flames.

Open flames can set fire to the wine unit.

Keep open flames (e.g. a candle) away from the wine unit.

 Risk of fire and damage due to improper installation.

If the mains plug and mains connection cables touch the back of the wine unit, they may be damaged by vibrations and cause a short circuit.

Mains plugs or mains connection cables must not touch the wine unit.

Mains connection cables must not be trapped or damaged.

Do not connect any other appliances to sockets located directly behind this wine unit.

Do not place or operate multi-socket adapters, distributor strips or other electronic devices (such as halogen transformers) behind the appliance.

This appliance should be installed in a dry, well-ventilated room.

The floor at the installation site must be horizontal and level and must be as high as the surrounding floor.

 Risk of damage due to high humidity.

In environments with high humidity, condensation can build up on the external wine unit panels.

This condensation can cause corrosion on external appliance panels.

Install the wine unit with sufficient ventilation in a dry and/or air-conditioned room.

After installation, please make sure that the appliance door(s) closes (close) properly and the wine unit is installed in accordance with these installation instructions. It is essential to comply with the specified ventilation cross-sections.

When deciding on the installation site, please bear in mind that the energy consumption increases if the wine unit is installed near a heater, a cooker or another appliance that gives off heat. Avoid direct sunlight. Higher ambient temperatures increase energy consumption as the compressor runs for longer.

Climate range

This wine unit is designed for use within specific ambient temperatures (climate range). Do not use in ambient temperatures for which it is not designed. The climate range is stated on the data plate inside the wine unit.

Climate range	Ambient temperature
SN	10 to 32 °C
N	16 to 32 °C
ST	16 to 38 °C
T	16 to 43 °C
SN-ST	10 to 38 °C
SN-T	10 to 43 °C

A lower ambient temperature will cause the compressor to switch off for longer periods, meaning that the wine unit is unable to maintain the required temperature in some circumstances.

Ventilation requirements

 Fire risk and risk of damage due to insufficient ventilation.

If the wine unit is not ventilated sufficiently, the compressor will run more frequently and for longer periods.

This will result in increased energy consumption and a higher operating temperature for the compressor. This may, in turn, cause damage to the compressor.

Please ensure that there is adequate ventilation around the wine unit.

It is essential to observe the required ventilation gaps.

The ventilation gaps must not be covered or blocked in any way.

They must also be regularly dusted.

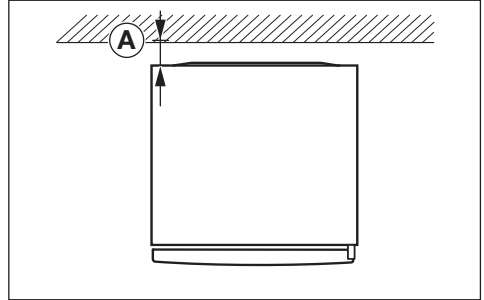

The energy consumption was calculated with a distance of $\textcircled{A} = 25 \text{ mm}$ between the back of the appliance and the wall. If the distance to the wall is less than 25 mm, the functionality of the wine unit is maintained, but energy consumption increases slightly. Condensation can also form at high ambient temperatures.

Air at the back of the wine unit gets warm. Sufficient space for proper ventilation must therefore be ensured (see “Appliance dimensions”).

Installing several wine units/refrigeration appliances

 Risk of damage due to condensation on external appliance panels.

In environments with high humidity, condensation can build up between the external wine unit panels, which can cause corrosion.

Do **not** place different wine units/refrigeration appliances **directly** next to one another.

A distance of at least 70 mm must be maintained between the wine units/refrigeration appliances.

Installation

Changing the door hinging

The wine unit is supplied with right-hand hinging. If left-hand hinging is required, the door hinging must be changed.

Tip: Place a suitable cover on the floor in front of the wine unit to protect the appliance door and your floor from damage when changing the door hinging.

⚠ Risk of injury and damage due to live electrical components.

You will come into contact with live electrical components while you are changing the hinging.

Switch off the appliance at the wall socket and withdraw the plug before changing the hinging.

⚠ Danger of injury and damage to the appliance due to heavy door.

There is an increased risk of injury and damage if the door hinging is installed by a single person.

Always change the door hinging with the help of a second person.

i Change the door hinge in accordance with the installation instructions (see QR code).



Mat. no. 12350120

Installing the wine unit

⚠ Risk of injury and damage due to the wine unit tipping over.

There is an increased risk of injury and damage if the wine unit is installed by a single person.

Two people are always required to install the wine unit.

⚠ Risk of damage and injury caused by appliance door impact.

The appliance door could hit the wall of the room resulting in damage to the door. If the door is made of glass, the damaged glass can lead to injuries.

Protect the appliance door by fitting a felt stopper, for example, to the wall of the room.

⚠ Risk of damaging the floor.

Moving the wine unit can cause damage to the floor.

Move the wine unit carefully on floors that are sensitive to scratching.

For easier installation, there are transport handles on the back at the top and transport wheels underneath the wine unit.

The wine unit must be empty when it is installed.

- Prepare the wine unit for installation as close as possible to its intended installation site.
- Connect the wine unit to the mains power supply as described in “Installation – Electrical connection”.

- Move the wine unit carefully to its intended installation site.
- Position the wine unit with its back facing the wall, taking the necessary distance into account.

Aligning the wine unit

⚠ Risk of damage and injury caused by the appliance door falling out or the wine unit tipping over.

If the additional adjustable foot on the hinge plate at the bottom is not resting firmly on the floor, the appliance door can fall out or the wine unit can tip over.

Use the open spanner supplied with the appliance to unscrew the adjustable foot until it is resting on the floor.

Then unscrew the adjustable foot by a further quarter turn.

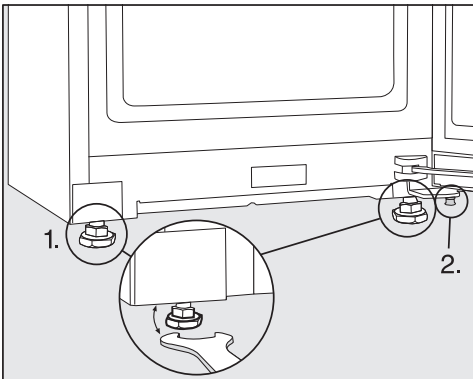

- Use the spirit level and the open spanner supplied to align the wine unit and support the appliance door.
1. Adjust the front adjustable feet.
 2. Unscrew the additional adjustable foot until it is touching the floor. Then unscrew the adjustable foot by a further quarter turn.

Integrating the wine unit in a run of kitchen units

The wine unit can be surrounded by kitchen units.

The energy consumption was calculated with a distance of 25 mm between the back of the appliance and the wall. If the distance to the wall is less than 25 mm, the functionality of the wine unit is maintained, but energy consumption increases slightly. Condensation can also form at high ambient temperatures.

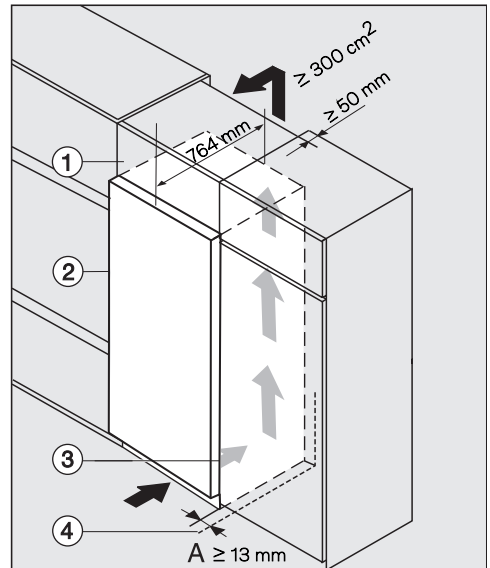

- ① Top box
- ② Wine unit, door depth = 75 mm
- ③ Kitchen unit
- ④ Wall

Installation



Fire risk and risk of damage due to insufficient ventilation.

If the wine unit is not ventilated sufficiently, the compressor will run more frequently and for longer periods.

This will result in increased energy consumption and a higher operating temperature for the compressor. This may, in turn, cause damage to the compressor.

Please ensure that there is adequate ventilation around the wine unit.

It is essential to observe the required ventilation gaps.

The ventilation gaps must not be covered or blocked in any way.

They must also be regularly dusted.

The larger the ventilation cross-sections, the less energy the compressor will use.

- Install the wine unit next to the kitchen unit.
- The appliance front must protrude in front of the kitchen unit front by at least the door depth. This enables the appliance door to be opened and shut without being obstructed.
- When installing the wine unit next to a wall ④, a distance (A) must be maintained on the hinge side between the wall ④ and the wine unit ②.
- To match the height of the rest of the kitchen units, the wine unit can be fitted with a suitable top box ①.

An air outlet of 50 mm depth must be provided across the whole width of the top box.

The ventilation cross-section under the ceiling must be at least 300 cm² to ensure that warm air can escape without obstruction.

Appliance dimensions

Installation dimensions/view from above

All dimensions are given in mm.

The wine unit will function correctly if the specified ventilation openings are kept clear.

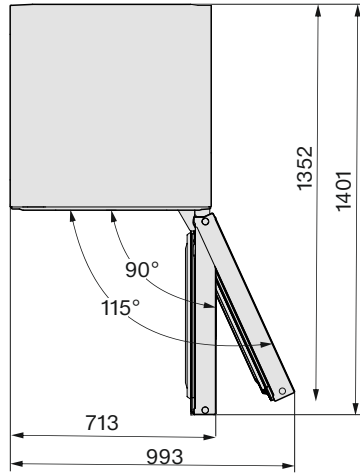
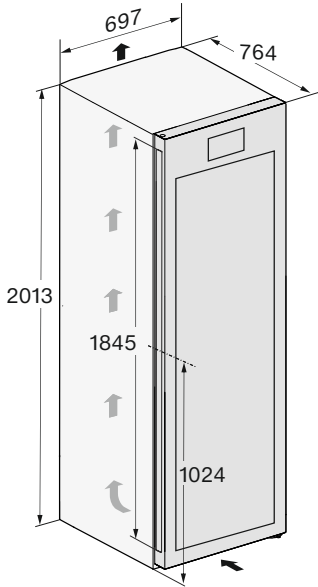

Installation

Connections

All dimensions are given in mm.

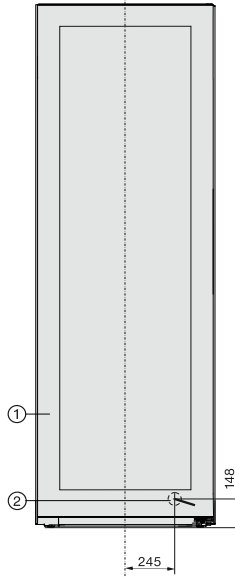

- ① Front view
- ② Mains connection cable, length = 2000 mm
A longer mains connection cable is available to order from the Miele Customer Service Department.

Electrical connection

The wine unit must only be connected to an earthed socket using the mains connection cable supplied.

The socket must be easily accessible after the wine unit has been installed. If the socket is not easily accessible, ensure that a suitable means of disconnection for each pole is provided on the installation side.

 Risk of fire from overheating.

Connecting the wine unit to a multi-socket adapter or to an extension cable can overload the mains connection cable.

For safety reasons, do not use an extension cable or multi-socket adapter.

The electrical system must comply with local and national safety regulations (BS 7671 in the UK).

For safety reasons, we recommend using a type  residual current device (RCD) in the assigned electrical installation for connecting the wine unit.

If the mains connection cable is damaged, it must only be replaced with a specific mains connection cable of the same type (available from the Miele Customer Service Department). For safety reasons, such replacement may only be carried out by a qualified specialist or the Miele Customer Service Department.

These operating instructions and the data plate indicate the nominal power consumption and the appropriate fuse rating. Compare this information with the data of the on-site electrical connection. If in any doubt, consult a qualified electrician.

Temporary or permanent operation on an autonomous power supply system or a power supply system that is not synchronised with the mains power supply (e.g. island networks, backup systems) is possible. A prerequisite for operation is that the power supply system complies with the specifications of EN 50160 or an equivalent standard. The function and operation of the protective measures provided in the domestic electrical installation and in this Miele product must also be maintained in isolated operation or in operation that is not synchronised with the mains power supply, or these measures must be replaced by equivalent measures in the installation. As described, for example, in the current version of VDE-AR-E 2510-2.

Installation

Connection dimensions

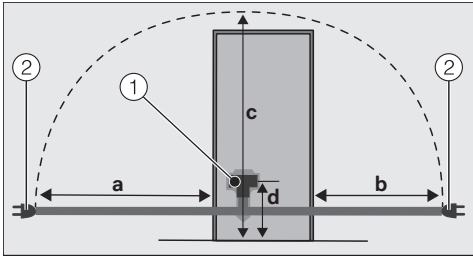

Back of the refrigeration appliance/wine unit

- ① Appliance plug connector
- ② Power plug

a	b	c	d
1750 mm	1350 mm	2100 mm	200 mm

Connecting the wine unit

- Plug the appliance plug connector into the socket.

Make sure that the appliance plug connector has clicked into position correctly.

- Insert the power plug of the wine unit into the socket.

The wine unit is now connected to the electricity supply.

EU Conformity declaration

Miele hereby declares that this wine unit complies with Directive 2014/53/EU.

The complete text of the EU declaration of conformity is available from one of the following internet addresses:

- Products, Download from www.miele.ie
- For service, information, operating instructions etc: go to <https://miele.ie/manuals> and enter the name of the product or the serial number

Frequency range of the WiFi module	2.4000–2.4835 GHz
------------------------------------	-------------------

Maximum transmission power of the WiFi module	< 100 mW
---	----------

UK Conformity declaration

Miele hereby declares that this wine unit complies with UK Radio Equipment Regulations 2017, as amended.

The complete text of the UK declaration of conformity is available from one of the following internet addresses:

- Products, Download from www.miele.co.uk
- For service, information, operating instructions etc: go to <https://miele.co.uk/manuals> and enter the name of the product or the serial number

Frequency band of the WiFi module	2.4000 GHz – 2.4835 GHz
-----------------------------------	-------------------------

Maximum transmitting power of the WiFi module	< 100 mW
---	----------

This **Statement of Compliance** confirms this Miele product fully complies with the **Product Security and Telecommunications Infrastructure (Security Requirements for Relevant Connectable Products) Regulations 2023**.

- 1) Household Appliance – *Freezer - 120002, 120003, 220009, 320001, 320002*
Refrigerator - 110001, 110002, 210010, 310001, 310002, 310003
Fridge-freezer - 130001, 130002, 130003, 130004, 330001, 330002, 330005
Wine unit - 210007, 210011, 310004, 330004
- 2) Manufactured by: Miele & Cie KG,
Carl Miele Street 29, 33332 Gutersloh Germany
Imported by and contact point: Miele Company Ltd, Fairacres, Marcham Road,
Abingdon, Oxon, OX14 ITW Great Britain
- 3) The defined support period at the time of first supply is 10 years
- 4) To report vulnerabilities and cybersecurity issues please contact: psirt@miele.com
- 5) Signature 
Name: **Paul Wright**
Company Position: **Head of Technical Management**
Date of signature: **19th March 2024**
Place of signature: **Abingdon, Oxfordshire**

Copyrights and licences

For the purpose of operating and controlling the communication module, Miele uses proprietary or third-party software that is not covered by open source licensing terms. This software/these software components are protected by copyright. The copyrights held by Miele and third parties must be respected.

Furthermore, the communication module integrated in the appliance contains software components which are distributed under open source licence conditions. The open source components contained in the appliance along with the corresponding copyright notices, copies of the licensing terms valid at the time and any further information can be accessed locally by IP via a web browser ([http\[s\]://<IP address>/Licenses](http[s]://<IP address>/Licenses)). The liability and warranty arrangements for the open source licences displayed in this location only apply in relation to the respective rights holders.

United Kingdom

Miele Co. Ltd., Fairacres, Marcham Road, Abingdon, Oxon, OX14 1TW
Tel: 0330 160 6600, Internet: www.miele.co.uk, E-mail: info@miele.co.uk

Australia

Miele Australia Pty. Ltd.
ACN 005 635 398
ABN 96 005 635 398
Level 4, 141 Camberwell Road
Hawthorn East, VIC 3123
Tel: 1300 464 353
E-mail: info@miele.com.au
Internet: www.miele.com.au

China Mainland

Miele Electrical Appliances Co. Ltd.
No. 82, Shimenyi Road, JingAn District
Shanghai, China, P.R.C
Post Code: 200040
Phone: +86 21 6157 3500
Fax: +86 21 6157 3511
E-mail: info@miele.cn
Internet: www.miele.cn

Hong Kong, China

Miele (Hong Kong) Ltd.
41/F - 4101, Manhattan Place
23 Wang Tai Road
Kowloon Bay, Hong Kong
Tel: (852) 2610 1025
Fax: (852) 3579 1404
E-mail:
customerservices@miele.com.hk
Website: www.miele.hk

India

Miele India Pvt. Ltd.
1st Floor, Copia Corporate Suites,
Commercial Plot 9, Mathura Road,
Jasola, New Delhi - 110025
E-mail: customercare@miele.in
Website: www.miele.in

Ireland

Miele Ireland Ltd.
2024 Bianconi Avenue
Citywest Business Campus
Dublin 24
Tel: (01) 461 07 10
Fax: (01) 461 07 97
E-mail: info@miele.ie
Internet: www.miele.ie

Malaysia

Miele Sdn Bhd
Suite 12-2, Level 12
Menara Sapura Kencana
Petroleum
Solaris Dutamas No. 1
Jalan Dutamas 1
50480 Kuala Lumpur, Malaysia
Phone: +603-6209-0288
Fax: +603-6205-3768

New Zealand

Miele New Zealand Limited
IRD 98 463 631
8 College Hill
Freemans Bay, Auckland 1011
Tel: 0800 464 353
E-mail: customercare@miele.co.nz
Internet: www.miele.co.nz

Singapore

Miele Pte. Ltd.
29 Media Circle
#11-04 ALICE@Mediapolis
Singapore 138565
Tel: +65 6735 1191
Fax: +65 6735 1161
E-mail: info@miele.com.sg
Internet: www.miele.sg

South Africa

Miele (Pty) Ltd.
63 Peter Place, Bryanston 2194
P.O. Box 69434, Bryanston 2021
Tel: (011) 875 9000
Fax: (011) 875 9035
E-mail: info@miele.co.za
Internet: www.miele.co.za

Thailand

Miele Appliances Ltd.
BHIRAJ TOWER at EmQuartier
43rd Floor Unit 4301-4303
689 Sukhumvit Road
North Klongton Sub-District
Vadhana District
Bangkok 10110, Thailand

United Arab Emirates

Miele Appliances Ltd.
Showroom 1, Eiffel 1 Building
Sheikh Zayed Road, Umm Al Sheif
P.O. Box 114782 - Dubai
Tel. +971 4 3044 999
Fax. +971 4 3418 852
800-MIELE (64353)
E-mail: info@miele.ae
Website: www.miele.ae

Manufacturer: Miele & Cie. KG, Carl-Miele-Straße 29, 33332 Gütersloh, Germany

KWT 4995 ...

en-GB

M.-Nr. 12 546 870 / 02 / 002