

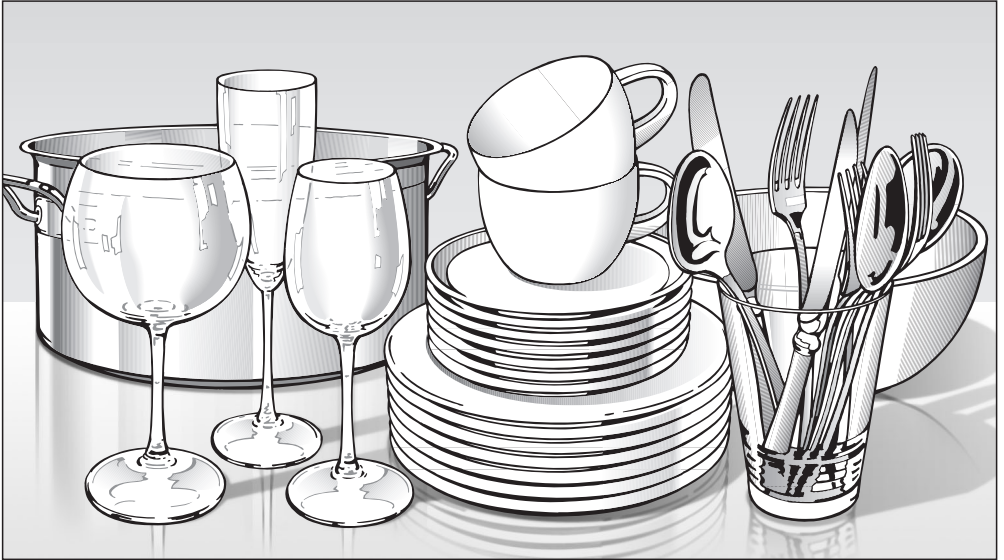

Miele

Operating instructions



Commercial dishwasher PFD 104 SCVi

en-GB

 To avoid the risk of accidents or damage to the appliance, it is **essential** to read these instructions before it is installed and used for the first time.



M.-Nr. 11 961 470



Notes about these instructions	6
Operating steps	6
Guide to the appliance	7
Appliance overview	7
Control panel	8
Display functions	9
Correct use	10
Warning and Safety instructions	12
Caring for the environment	18
Before using for the first time	19
Basic settings	19
Setting the language	19
Setting up Miele@home	19
Setting the time of day	19
Setting the water hardness level	20
Miele@home	21
Opening the door	22
Closing the door	22
Dishwasher salt	23
Filling the salt reservoir	24
Refilling the salt	24
Rinse aid	25
Adding rinse aid	25
Filling the rinse aid reservoir	26
Caring for the environment	27
Economical dishwashing	27
EcoFeedback consumption indicator	28
Loading the dishwasher	29
General information	29
Upper basket	31
Adjust the upper basket	33
Lower basket	33
Cutlery tray	36
Loading the 3D MultiFlex tray	36
Loading examples	37
Dishwashers with cutlery tray	37
Detergent	39
Field of application	39
Dispensing detergent	40

Contents

Adding detergent	40
Changing detergent.....	42
Operation	43
Switching on the dishwasher.....	43
Selecting a programme	43
Display of programme running time	43
Starting the programme	44
End of the programme	44
Energy management	45
Switching off the dishwasher	45
Unloading the dishwasher	45
Interrupting a programme	45
Programme options	46
Options	46
Timer ⌚.....	47
Activating Remote start 	51
Programme chart	52
Cleaning and care	56
Periodic checks.....	56
Cleaning the wash cabinet.....	56
Cleaning the door and the door seal	56
Cleaning the control panel	57
Cleaning the reflector panel.....	57
Cleaning the appliance front.....	57
Cleaning the spray arms	58
Checking the filters in the wash cabinet.....	60
Cleaning the filters	60
Cleaning the water inlet filter.....	62
Cleaning the drain pump	63
Troubleshooting.....	64
Technical problems	64
Fault messages	66
Door release	67
Water inlet fault	68
Water drainage fault.....	69
General problems with the dishwasher	69
Noises	70
Unsatisfactory washing result	71
Customer service.....	74
Contact in the event of a fault	74

Warranty	74
Installation	75
Electrical connection	75
The Miele Waterproof system	76
Water inlet	76
Connecting the drainage system	78
Technical data	79
Settings 	81
Opening the Settings menu	81
Changing settings	81
Language 	81
Time of day	81
Water hardness	82
Rinse aid	83
Temperature unit	83
Final rinse temperature	83
Miele@home	83
Remote control	85
RemoteUpdate	85
SmartStart	86
EcoStart	86
Consumption (EcoFeedback)	88
Display brightness	88
Volume	88
Refill reminders	89
BrilliantLight	89
Software version	89
Showroom	89
Factory default	89

Notes about these instructions

Warnings

 Information which is important for safety is highlighted in a thick framed box with a warning symbol. This alerts you to the potential danger of injury to people or damage to property.
Read these warning notes carefully and observe the procedural instructions and codes of practice they describe.

Notes

Information of particular importance that must be observed is highlighted in a thick framed box.

Additional information and comments

Additional information and comments are highlighted in a box framed with a single black line.

Operating steps

Instructions on how to operate the commercial dishwasher are identified by marked operating steps. They explain the procedure step by step.
Operating steps are indicated by a black square/bullet point.

Example:

■ Select the desired setting and press the middle button to confirm.

Display

Information given via the commercial dishwasher display appears in a special display font to match the font on the machine.

Example:

When the message  Finished appears in the display

Appliance overview

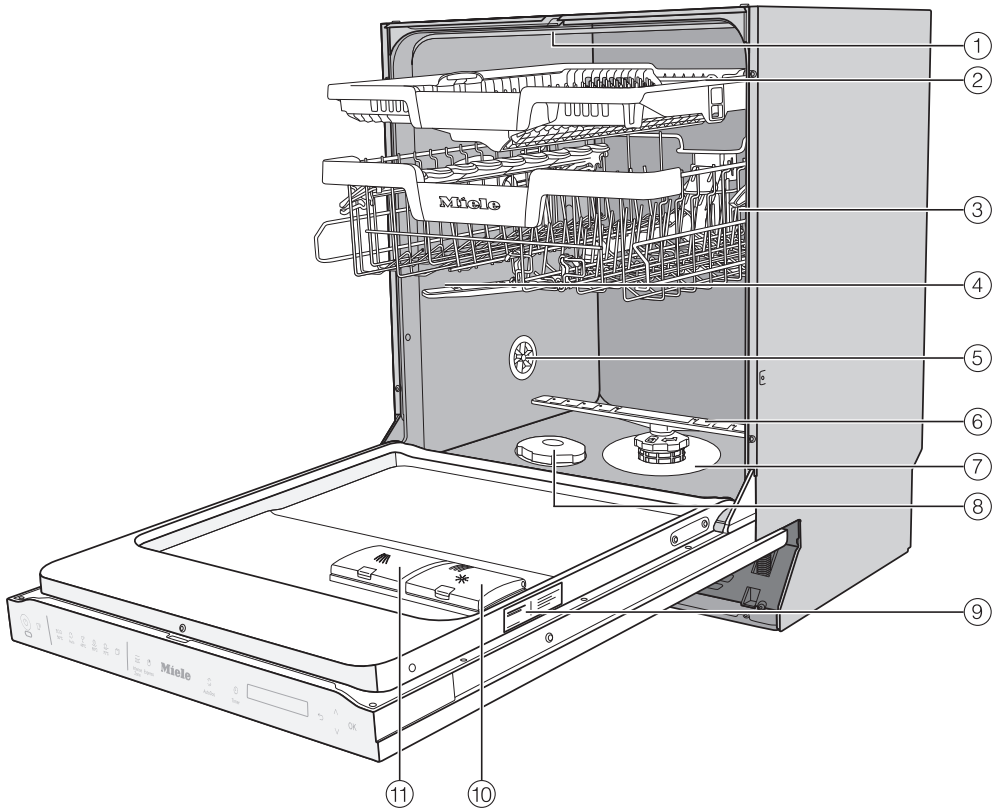

- ① Top spray arm
- ② 3D MultiFlex tray (depending on model)
- ③ Upper basket (depending on model)
- ④ Middle spray arm
- ⑤ Ventilation
- ⑥ Bottom spray arm
- ⑦ Filter combination
- ⑧ Salt reservoir
- ⑨ Data plate
- ⑩ Rinse aid reservoir
- ⑪ Detergent compartment

Guide to the appliance

Control panel



- ① **On/Off** sensor control
For switching the dishwasher on and off.
- ② **Optical in-operation indicator light**
For indicating an ongoing wash programme when the door is closed.
- ③ **Remote start** sensor control
For activating/deactivating the Remote start option.
- ④ **Programme selection**
 - = Short
 - = Universal
 - = Intensive
 - = Glasses
 - = ECO
 - = Further programmes
- ⑤ **Settings** sensor control
Open the Settings menu.
- ⑥ **Temperature** sensor control
For displaying the current temperature.
- ⑦ **Extra dry** sensor control
For activating drying.
- ⑧ **Timer** sensor control
For selecting a later programme start.
- ⑨ **Display**
For further information, see the “Display functions” section in the “Guide to the appliance” section.
- ⑩ **Back** sensor control
For navigating back to the previous menu level or deleting values that have been set previously.
- ⑪ **Scroll** sensor controls
For selecting programmes.
For changing the values displayed.
For scrolling to other menu pages.
- ⑫ **OK** sensor control
To select menu options and values displayed.
To confirm messages.

Display functions

The display is used to select or set the following:



- The programme
- The timer
- The Settings 

The display can show the following:

- The programme stage
- The estimated time left for the programme to run
- The water consumption (EcoFeedback)
- Any relevant fault messages and information

To save energy, the dishwasher switches off after a few minutes if you do not press any sensor controls during this time.
Touch the  sensor control to switch the dishwasher back on.

The *OK* sensor control is used to confirm a message or setting and also to move to the next menu or another level.

Under  *Further programmes/settings*, a scroll bar  will appear in the right of the display. This offers further options. These options can be shown using the \vee/\wedge sensor controls.

You can alter the dishwasher's controls to suit changing requirements in the Settings menu (see "Settings" chapter).

The option that is selected will have a tick  next to it.

To exit a sub-menu again, use the  *Back* sensor control.

If you do not press any sensor controls for several seconds, the display will revert to the previous menu. You may then have to enter your settings again.

Correct use

This commercial dishwasher complies with all current local and national safety requirements. Inappropriate use can, however, lead to personal injury and material damage.

Read the operating instructions carefully before using the commercial dishwasher for the first time. They contain important information on the safety, use and maintenance of the appliance. This way you will prevent the risk of accidents and damage to the commercial dishwasher. Keep these operating instructions in a safe place and pass them on to any future owner.

- ▶ This Miele commercial dishwasher with its short programme running times and powerful cleaning performance is intended for commercial use. The commercial dishwasher can also be used on ships with a hull of longer than 24 metres, as well as on oil rigs.
- ▶ This commercial dishwasher is subsequently referred to as a dishwasher in these operating instructions. Glasses, cutlery and crockery are referred to generally as crockery when not more specifically defined.
- ▶ This dishwasher is not intended for continuous use.
- ▶ This dishwasher may not be used to clean medical products or devices.
- ▶ This appliance is designed exclusively for use as a “dishwasher” for cleaning loads as described in these instructions. Conversions, modifications and any other use are not permitted.
- ▶ This dishwasher is intended for stationary, indoor use only.
- ▶ The special inserts in the baskets should only be used for their specific application.
- ▶ This dishwasher can only be used by people with reduced physical, sensory or mental capabilities, or lack of experience or knowledge, if they are supervised whilst using it or have been shown how to use it in a safe way and understand and recognise the consequences of incorrect operation.
- ▶ The commercial dishwasher should only be used in calmer waters (ports and harbours).

- ▶ This commercial dishwasher can only be used on a ship if:
 - The ship's hull is longer than 24 metres.
 - The list of the vessel is not more than 2°.
 - Any external vibration is no more than 150 Hz at an amplitude of 0.35 mm.

The safe operation and correct functioning of the commercial dishwasher can only be guaranteed if the above conditions are met.

- ▶ The door of the commercial dishwasher must not be opened during operation.
- ▶ Inappropriate use can lead to water leakage.
- ▶ The commercial dishwasher may not be operated on an open deck.
- ▶ This dishwasher is supplied with a special lamp (depending on the model) to cope with particular conditions (e.g. in terms of temperature, moisture, chemical resistance, abrasion resistance and vibration). This lamp must only be used for the purpose for which it is intended. The lamp is not suitable for room lighting. Replacement lamps may only be fitted by a Miele authorised technician or by the Miele Customer Service Department.

This dishwasher contains several light sources in energy efficiency class D.

The lighting control element is integrated into the appliance control and cannot be removed separately. As a result, electricity consumption cannot be measured separately.

Warning and Safety instructions

Correct installation

▶ This dishwasher may only be installed and assembled on ships with a hull longer than 24 metres by qualified persons who will ensure that the requirements for the safe installation of this dishwasher are met.

▶ When the commercial dishwasher is being installed, it must be equipped with a mechanism that prevents the door opening accidentally while at sea.

▶ When installing the dishwasher, it must be securely fixed to the floor.

Failure to do this could result in personal injury, damage to the dishwasher and damage to other objects and installations.

▶ This dishwasher can be securely bolted to the floor using the floor anchoring kit included.

▶ Do not install this dishwasher in an area where there is a risk of explosion or freezing conditions.



▶ Take care, both before and during installation of the dishwasher, not to cut yourself on the metal parts. Danger of injury. Wear protective gloves.

▶ To ensure stability a built-under dishwasher must only be installed beneath a continuous worktop that is bolted to the adjacent cabinetry.

▶ In order to reduce the risk of damage from condensation, the furniture in the area around the dishwasher should ideally be designed for commercial use.

Furniture can be protected using the vapour protection set, which is available as an optional accessory.

The vapour barrier film should be stuck under the worktop in the area around the dishwasher door.

▶ The door springs must be evenly adjusted on both sides. They are correctly adjusted when the door remains stationary when left half open (approx. 45° opening angle). It is also important that the door cannot fall open.

The machine must only be operated with properly adjusted door springs.

If the door cannot be adjusted properly, contact the Miele Customer Service Department.

Technical safety

- ▶ This dishwasher must only be commissioned, repaired and maintained by the Miele Customer Service Department, a dealer or a suitably qualified service technician. Unauthorised installation, maintenance and repairs can cause considerable danger for the user.
- ▶ This dishwasher must only be operated by appropriately trained personnel. They must be instructed and trained regularly.
- ▶ Before using the dishwasher, check it for any externally visible damage. Do not use a damaged dishwasher. This could be dangerous.
- ▶ In the event of a damaged or leaking dishwasher, switch off at the power supply immediately and call the Miele Customer Service Department, a Miele dealer or a suitably qualified service technician.
- ▶ Faulty components must only be replaced by genuine Miele original spare parts. Only when these parts are fitted can Miele guarantee the correct functioning and safety of the appliance.
- ▶ The electrical safety of this dishwasher can only be guaranteed when correctly earthed. If in any doubt, please have the electrical installation tested by a qualified electrician.
- ▶ Please follow the advice on installation in these operating instructions and the installation plan.
- ▶ Before connecting the appliance, ensure that the connection data on the data plate (voltage, frequency and fuse rating) match the mains electrical supply.
- ▶ The dishwasher may only be operated if the door opening mechanism is working correctly. Otherwise, there could be a risk of danger whilst the automatic door opening mechanism (depending on the model) is active.
The maximum weight of the front panel that can be aligned with the factory-fitted door springs is 5–12 kg (depending on the model).
Signs that the door opening mechanism is working correctly:
 - The door springs must be evenly adjusted on both sides. They are correctly adjusted when the door remains stationary when left half open (approx. 45° opening angle). It is also important that the door cannot fall open.
- ▶ There must be no electrical sockets behind the dishwasher. Danger of overheating and fire risk if the dishwasher were to be pushed up against a plug. See “Electrical connection”.

Warning and Safety instructions

- ▶ Do not connect the dishwasher to the mains electricity supply via a multi-socket unit or an extension lead. These do not guarantee the required safety of the appliance (e.g. danger of overheating).
- ▶ Never open the casing of the dishwasher. Any contact with live connections or tampering with the electrical or mechanical components of the dishwasher will endanger your safety and may lead to appliance malfunctions.
- ▶ The dishwasher must not be used if the electrical connection cable is damaged. A damaged connection cable may only be replaced by a suitable connection cable of the same type. For safety reasons, such replacement may only be carried out by the Miele Customer Service Department or a qualified service technician.
- ▶ The dishwasher must be disconnected from the mains electricity supply before any maintenance or repair work is carried out.
- ▶ The plastic housing of the water connection contains electrical components. It must not be dipped in water.
- ▶ There are electrical wires in the water inlet hose. Do not shorten the water inlet hose, even if it is too long.
- ▶ The integrated Waterproof system offers protection from water damage, provided that the following conditions are met:
 - Installation has been carried out correctly.
 - The dishwasher is properly maintained and parts are replaced where it can be seen that this is necessary.
 - The stopcocks have been turned off during longer periods of inactivity (e.g. whilst on holiday).

The Waterproof system will work even when the dishwasher is switched off. However, the dishwasher must remain connected to the electricity supply.

- ▶ While the dishwasher is under warranty, repairs should only be undertaken by a Miele authorised service technician. Otherwise the warranty is invalidated.

Correct use

- ▶ This dishwasher is designed for operation with water and detergents suitable for use in commercial dishwashers only. Organic solvents and flammable liquid agents must not be used in it. This could cause an explosion, damage rubber or plastic components in the dishwasher and cause liquids to leak out of it.

Warning and Safety instructions

- ▶ You could injure yourself on the open dishwasher door or trip over it. Avoid leaving the door open unnecessarily.
- ▶ Do not sit, stand or lean on the opened door. This would tip or damage the dishwasher.
- ▶ After any plumbing work the water pipework to the dishwasher will need to be vented. If this is not done, components can be damaged.
- ▶ Please be aware that the dishwasher may be operating at high temperatures. When the door is opened there is a danger of burning or scalding. Items, baskets and inserts must be allowed to cool down before they are unloaded. Any water remaining in containers could still be very hot. Empty them into the wash chamber before taking them out.
- ▶ The water in the cabinet must not be used as drinking water.
- ▶ Pre-treating items (for example with washing-up liquid and other cleaning agents) as well as some types of soiling and some cleaning agents can cause a build-up of foam in the wash cabinet. Foam can have an adverse effect on the cleaning result.
- ▶ Foam escaping from the wash cabinet can cause damage to the dishwasher. If foam escapes the programme must be cancelled immediately and the appliance must be disconnected from the mains electrical supply.
- ▶ There may be a risk of slipping if liquid is spilt on the floor depending on the type of flooring and footwear being worn. Keep the floor dry where possible and take care to clean up any liquid spills straight away. Take the necessary precautions when cleaning up hazardous substances and hot liquids.
- ▶ When using cleaning agents and specialised products, it is essential that the manufacturer's instructions are followed. Cleaning agents must only be used for the purpose they are designed for by the manufacturer to avoid any material damage or the occurrence of strong chemical reactions (e.g. oxyhydrogen explosion).
- ▶ Miele cannot be held liable for any effect chemical cleaning agents may have on the material of the items being cleaned. Observe the cleaning agent manufacturer's instructions with regard to storage conditions, use and dosage.

Warning and Safety instructions

- ▶ Do not inhale or ingest powder detergent. Dishwasher detergent contains irritant or corrosive ingredients which can cause burning in the nose, mouth and throat if swallowed, or inhibit breathing. Seek medical attention immediately if detergent has been swallowed or inhaled.
- ▶ People aged 16 and above may refill the dishwasher detergent or change the media canister provided that they have been trained to do so.
- ▶ Powder and liquid detergents containing active chlorine must not be used. They can damage plastics and seals in the dishwasher.
- ▶ To avoid material damage and corrosion, do not allow any acids or solutions containing chloride to get into the wash cabinet or onto the casing. Similarly avoid any ferrous materials with a corrosive effect.
- ▶ Do not wash items soiled with ash, sand, wax, lubricating grease or paint in the dishwasher. These materials will cause damage to the dishwasher.
- ▶ Do not clean the dishwasher or near vicinity with a hose or a pressure washer.
- ▶ Be careful when sorting items with sharp pointed ends and positioning them in the dishwasher that you do not hurt yourself or create a danger for others. Sharp knives, forks, etc. should be placed in baskets with the pointed ends facing downwards.
- ▶ Remove any coarse food deposits and empty out any containers or utensils before loading them in the dishwasher.

Safety with children

- ▶ Children should be supervised in the vicinity of the dishwasher. Never allow children to play with the appliance. There is a danger that children might shut themselves in the dishwasher.
- ▶ Children under eight years of age must be kept away from the dishwasher unless they are constantly supervised.
- ▶ Children aged eight and older may only use the dishwasher without supervision if they have been shown how to use it in a safe manner. Children must be able to recognise and understand the potential risks of improper use.
- ▶ If the automatic door opening mechanism is active, keep young children away from the area in which the door opens. There is a danger of injury in the unlikely event of a fault with the opening mechanism.

Warning and Safety instructions

▶ Keep children away from chemical agents. These contain irritant and corrosive ingredients which can cause burning in the mouth, or inhibit breathing. Keep children away from the dishwasher when the door is open. There could still be residual chemical agent in the wash cabinet. Seek medical advice immediately if a child has swallowed or inhaled chemical agent.

Accessories

- ▶ Only use original Miele accessories. If other parts are used, warranty, performance and product liability claims will be invalidated.
- ▶ Miele will guarantee the supply of functional spare parts for a minimum of 10 years and up to 15 years following the discontinuation of your dishwasher.

Transport

- ▶ Only transport the dishwasher in an upright position so that no water flows into the electrical controls, as this would cause faults.
- ▶ If you wish to transport the dishwasher, empty it and securely fasten all loose parts such as baskets, hoses and cables.

Miele cannot be held liable for damage caused by non-compliance with these Warning and Safety instructions.

Caring for the environment

Disposing of the packaging material

The packaging material is used for handling and protects the appliance from transport damage. The packaging material used is selected from materials which are environmentally friendly for disposal and can generally be recycled.

Recycling the packaging material reduces the use of raw materials. Use material-specific collection points for valuable materials and take advantage of return options. Your Miele dealer will take the packaging material away.

Disposing of your old appliance

Electrical and electronic appliances contain many valuable materials. They also contain certain materials, compounds and components which were essential for their correct functioning and safety. These could be hazardous to human health and to the environment if disposed of with household waste or if handled incorrectly. Please do not, therefore, dispose of your old appliance with household waste.



Instead, please make use of officially designated collection and disposal points to dispose of and recycle electrical and electronic appliances in your local community, with your dealer or with Miele, free of charge. By law, you are solely responsible for deleting any personal data from the old appliance prior to disposal. You are legally obliged to remove any old batteries which are not securely enclosed by the appliance and to remove any lamps without destroying them, where this is possible. These must be taken to a suitable collection point where they can be handed in free of charge. Please ensure that your old appliance poses no risk to children while being stored for disposal.

Before using for the first time

Basic settings

Switching on the dishwasher

- Open the door.
- Switch the dishwasher on using the  sensor control.

The welcome screen will appear when the dishwasher is switched on and the welcome melody will sound.

For further information about the display functionality, see the “Display functions” section in the “Guide to the appliance” chapter.

Setting the language

The display will then change automatically to the screen for setting the language.

- Select the language you want as well as the country, if appropriate, using the ∇/\wedge sensor controls and confirm with *OK*.

For further information on setting the language, see the “Settings” chapter under the “Language” section.

A tick  will appear next to the language that has been set.

Setting up Miele@home

The message Miele@home will appear on the display.

- To set up Miele@home now, confirm by touching *OK*.

Tip: To postpone setup until later, select the option *Skip* and confirm by touching *OK*.

There are two ways of connecting your dishwasher to your WiFi network:

- Select the connection method you want and confirm your choice with *OK*.

1. Connect using App
2. Connect using WPS (WPS = WiFi Protected Setup)

You will then be guided by the display and the relevant Miele networking solution.

For further information on Miele@home, see the “Miele@home” section in the “Settings” chapter.

Setting the time of day

The time of day is set automatically if a connection is established with the WiFi network.

The display will then change to the screen for setting the time of day.

The current time of day must be set before you can use the timer option.

- Use the ∇/\wedge sensor controls to enter the hour and confirm your entry by touching *OK*.
- Then set the minutes and confirm with *OK*.

Holding down the relevant ∇ or \wedge sensor control will increase or decrease the time automatically.

Before using for the first time

Setting the water hardness level

The display will change to the screen for setting the water hardness.

- You should programme the dishwasher to the correct water hardness for your area.
- Your local water authority will be able to advise you of the water hardness level in your area.
- Where the water hardness fluctuates e.g. between 1.8 and 2.7 mmol/l (10 - 15 °dH - German scale) always programme the dishwasher to the higher value (2.7 mmol/l or 15 °dH in this example).

In the event of a fault, it will help the service technician if you know the hardness of your local water supply.

Therefore, please enter the water hardness:



_____ °dH or mmol/l

The dishwasher is programmed at the factory for a water hardness level of 2.5 mmol/l (14 °dH – German scale).

- Set the water hardness level in your area and confirm using *OK*.

See the “Settings” chapter, “Water hardness” section for more information.

Prompts will then appear in the display.

After confirming these prompts with *OK*, the messages  Refill salt and  Refill rinse aid may appear.

- Add salt and rinse aid if necessary (see the “Dishwasher salt” and “Rinse aid” sections in the “Before using for the first time” chapter).
- Select *OK* to confirm the messages.

The programme selected will appear briefly in the display and the appropriate sensor control will be illuminated.

Next, the estimated water consumption may be shown for the chosen programme for several seconds.

Then the display will show the estimated running time for the programme selected.

Before using for the first time

Miele@home

Your dishwasher is equipped with an integrated WiFi module.

To use this feature, you will need:

- A WiFi network
- A Miele networking solution, e.g. the Miele app
- A Miele user account. The user account can be created via the Miele networking solutions, e.g. via the Miele app

The networking solution you are using will guide you as you connect your dishwasher to your home WiFi network.

Once your dishwasher is connected to your WiFi network, you can use the networking solution, for example, to carry out the following activities:

- Call up information on the operating status of your dishwasher
- Call up information on the programme sequence of your dishwasher

Connecting your dishwasher to your WiFi network will increase energy consumption, even when the dishwasher is switched off.

Make sure that your WiFi network signal strength is strong enough at the installation site of your dishwasher.

Availability of the WiFi connection

The WiFi connection shares a frequency range with other appliances (including microwave ovens and remote control toys). This can give rise to sporadic or even complete connection failures. Therefore, the availability of featured functions cannot be guaranteed.

Miele@home availability

If you wish to use the Miele@mobile app or other Miele networking solutions, the Miele@home services must be available in your country.

The Miele@home service is not available in every country.

For information about availability, please visit www.miele.com.

Miele app

You can connect the dishwasher to the Miele app.

The app is available to download free of charge from the Apple App Store® or from the Google Play Store™.

Miele app



Before using for the first time

Every dishwasher is tested at the factory. There will be residual water in the appliance from this test. It is not an indication that the dishwasher has been used previously.

⚠ Keep the area around the door free of obstructions.

Opening the door

⚠ Damage due to leaking water.

The door of the commercial dishwasher must not be opened during operation.

Once the programme has started, leave the door closed to ensure that no water drips out.

⚠ Risk of damage due to opening the door accidentally.

When the commercial dishwasher is being installed, it must be equipped with a mechanism that prevents the door opening accidentally while at sea.

Bolt the door with the mechanism to ensure no items or baskets fall out of the dishwasher.

Closing the door

- Push the baskets right in.
- Then raise the door up, and push until it clicks into position.

The door will then close automatically.

⚠ Risk of crushing due to the door closing.

When closing the door, you are at risk of shutting your fingers in it.

Do not put your hand inside the door as it is closing.

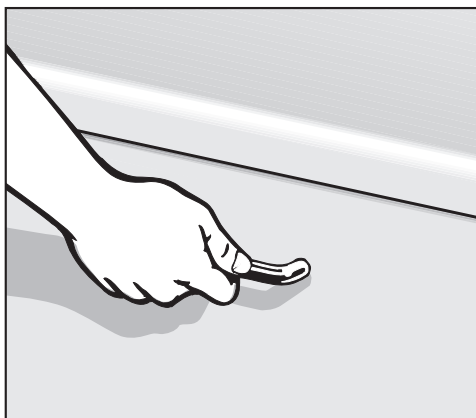

- Pull the handle to open the door.

Dishwasher salt

In order to achieve good cleaning results, the dishwasher needs to operate with soft water. Hard water results in the build-up of calcium deposits on crockery and on the wash cabinet walls.

Mains water with a water hardness level higher than 0.9 mmol/l (5 °dH – German scale) must be softened. This occurs automatically in the integrated water softener. The water softener is suitable for a water hardness level of up to 6.5 mmol/l (36 °dH – German scale).

In order to maintain the functions of the water softener, it must be reactivated regularly. Reactivation occurs automatically every ninth programme sequence. At the start of the next programme, an additional 4.4 l of water is required for this process. Energy consumption increases by 0.015 kWh and the programme is extended by 3 minutes.

The above only applies to the ECO programme at a water hardness of 2.5 mmol/l (14 °dH – German scale).

For other programmes and water hardness levels, the frequency of reactivation will differ.

In order to be reactivated, the water softener requires dishwasher salt.

Depending on the water hardness level (< 3.8 mmol/l, or < 21 °dH – German scale), dishwasher salt is not required if combination detergents are being used (see the “Powder detergent and detergent tabs” section in the “Detergent” chapter).

 Damage caused by using unsuitable salts.

Some types of salt may contain insoluble components which can cause the water softener to malfunction.

Only use special coarse-grained dishwasher salt or other pure kitchen salt for reactivation.

 Damage to the water softener from detergent.

Detergent will damage the water softener.

Do not fill the salt reservoir with powder or liquid detergent.

If the water in your area is very soft and constantly **lower than 0.9 mmol/l (5 °dH – German scale)**, you do **not** need to add dishwasher salt. The salt refill indicator will automatically switch off after the water hardness has been set accordingly (see the “Water hardness” section in the “Settings” chapter).

If you only ever use combination detergent products in your dishwasher, you can turn off both refill reminders if you wish (see “Refill reminders” under “Settings”).

Please make sure that if you stop using combination detergents, you refill the dishwasher salt and rinse aid. Switch the refill reminders back on if required.

Before using for the first time

Filling the salt reservoir

Before filling the salt reservoir for the first time, you must fill it with approx. 2 l of water to enable the salt to dissolve.

Once the dishwasher has been used once, there is always sufficient water in the salt reservoir.

- Remove the lower basket from the wash cabinet and unscrew the salt reservoir cap.
- Fill the salt reservoir with approx. 2 l of water (first use only).

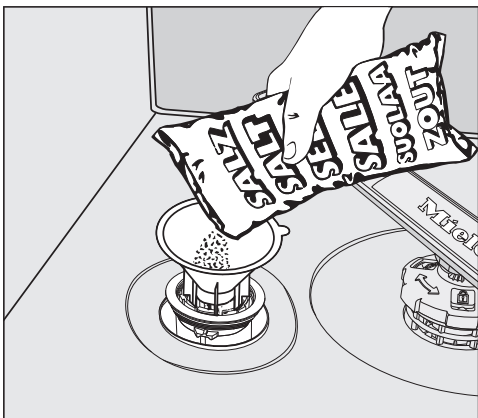

- Place the funnel provided over the salt reservoir and carefully fill with dishwasher salt until the reservoir is full. The salt reservoir holds up to 2 kg of salt, depending on the type of salt used.
- Clean off salt residues from around the salt reservoir opening. Next, screw the salt reservoir cap on again firmly.

Only use special coarse grained reactivation salt with granules of approx. 1 - 4 mm. Do not use other types of salt such as cooking salt, agricultural grade or gritting salt. These may contain

insoluble additives which can impair the functioning of the water softener. If in doubt consult the Miele Professional Department.

Refilling the salt

- When the refill reminder  Refill salt appears in the display, wait until the end of the programme and then refill the salt reservoir.
- Confirm with *OK*.

The salt refill indicator will go out.

 Risk of corrosion due to saline solution.

Saline solution that runs out can cause corrosion in the wash cabinet and to the load items.

Each time you remove the salt reservoir cap, you must run the  *Cold pre-wash* programme without any load items in the dishwasher. This will dissolve and remove any traces of salt from the wash cabinet.

After the salt reservoir has been filled, the salt refill indicator may still appear in the display if the salt concentration has not yet reached the correct level. In this case, confirm the message again with *OK*.

Before using for the first time

Rinse aid

Rinse aid is necessary to ensure water does not cling to and leave marks on crockery during the drying phase, and it helps crockery dry faster after it has been washed.

Rinse aid is poured into the storage reservoir and the amount set is dispensed automatically.

 Washing-up liquid or detergent can cause damage.

Washing-up liquid and dishwasher detergent will damage the rinse aid reservoir.

Only fill it with rinse aid formulated for domestic dishwashers.

Alternatively, you could use liquid citric acid at a concentration of up to 10 %. The resulting rinsing and drying quality will not, however, be as good as when rinse aid is used.

 Risk of acid damage.

The dishwasher can be damaged by high concentrations of acid.

Under no circumstances should you use citric acid with a higher acid content.

If you only ever wish to use combination detergent products in your dishwasher, you do not need to add rinse aid.

However, for optimum rinsing and drying results, use dishwasher detergent and add dishwasher salt and rinse aid separately.

If you only ever use combination detergent products in your dishwasher, you can turn off both refill reminders if you wish (see “Refill reminders” under “Settings”).

Please make sure that if you stop using combination detergents, you refill the dishwasher salt and rinse aid. Switch the refill reminders back on if required.

Adding rinse aid

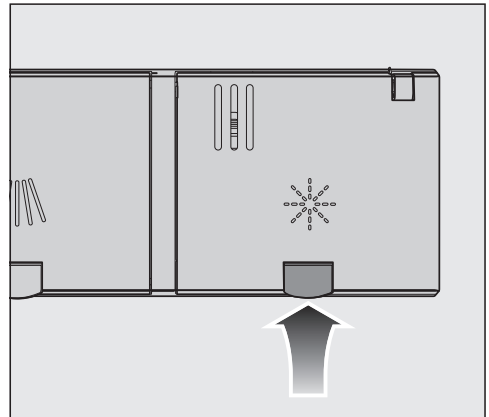

- Press the yellow button  on the lid of the rinse aid reservoir.

The lid will spring open.

Before using for the first time

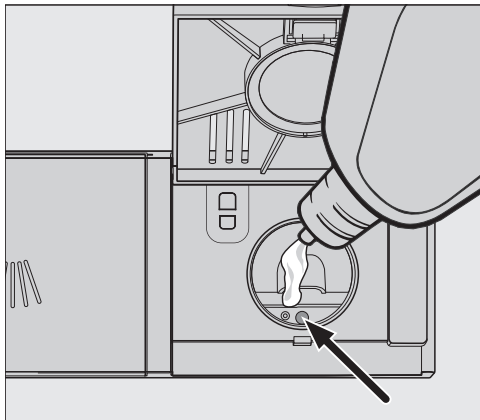

Filling the rinse aid reservoir

When the refill reminder ☼ Refill rinse aid appears in the display, the reservoir contains sufficient rinse aid for 2 to 3 programmes only.

- Refill with rinse aid in plenty of time.
- Confirm with *OK*.

The rinse aid refill reminder will disappear.

- Fill with rinse aid until the filling level indicator (arrow) changes to a dark colour while the door is horizontally open.

The rinse aid reservoir holds approximately 110 ml.

- Close the lid firmly until you hear it click into place. Otherwise, water can enter the rinse aid reservoir during a programme.
- Wipe up any spilled rinse aid. This prevents excess foam developing during the next programme.

You can adjust the rinse aid dosage for the best wash result (see “Settings” chapter, “Rinse aid” section).

Economical dishwashing

This dishwasher is exceptionally economical in its use of water and electricity.

You can make the most of your appliance by following these tips:

- Washing in a dishwasher generally uses less water and energy than washing by hand.
 - There is no need to pre-wash items under running water, and this unnecessarily increases water and energy consumption.
 - Make full use of the basket capacity without overloading the dishwasher. This results in the most economical dishwashing in terms of energy and water consumption.
 - Choose the programme to suit the type of crockery being washed and the degree of soiling (see "Programme chart").
- Select the  *ECO* programme for energy-saving dishwashing. This programme is the most efficient in terms of its combined energy and water consumption for cleaning crockery with a normal level of soiling.
 - Follow the detergent manufacturer's recommendations on detergent dosage.
 - If you are manually dosing the detergent, reduce the amount by $\frac{1}{3}$ when using powder detergent if the baskets are only half full.

Caring for the environment

EcoFeedback consumption indicator

The “Consumption” function is used for calling up information about the water consumption of your dishwasher (see the “Consumption” section in the “Settings” chapter).

The following information can be shown on the display:

- An estimate of the consumption before the programme sequence
- The actual consumption at the end of the programme
- The total consumption of the dishwasher

1. Estimated consumption

After a programme has been selected, first the name of the programme and then the estimated water consumption δ will appear in the display for a few seconds.

The estimated consumption will be shown as a bar chart. The more bars that are visible (■■■), the higher the water consumption.

The values are influenced by the programme, any programme options selected, the ambient conditions and the size of the load.

The display will change automatically from showing the estimated consumption to showing the time remaining.

The estimated consumption function is activated as standard. This function can be deactivated, though, if preferred (see the “Consumption” section in the “Settings” chapter).

2. Displaying consumption

At the end of the programme, you can call up the actual water consumption for the programme that has just been run.

- Confirm the message Consumption (OK) with *OK*.

Switching the dishwasher off at the end of the programme will delete the actual consumption values for the programme that has just been run.

3. Total consumption

You can view the total consumption of water for all previously used programmes of your dishwasher (see the “Consumption” section in the “Settings” chapter).

General information

Remove coarse food residues from crockery.

There is no need to pre-rinse items under running water.

 Damage can be caused by ash, sand, wax, lubricating grease or paint. These substances will contaminate the dishwasher and can then no longer be removed. Do not wash items soiled with these substances in the dishwasher.

Crockery can be loaded anywhere in the baskets, but the following notes should be observed:

- Do not place crockery and cutlery inside other items where they will cover one another.
- Load the crockery so that water can access all surfaces. This ensures that they get properly cleaned.
- Make sure that all items are securely positioned.
- Hollow items such as cups, glasses, pots etc. must be placed upside down in the baskets.
- Tall and narrow hollow items, such as champagne glasses, should be placed in the middle of the basket rather than in the corners. This ensures the hollow items are more easily accessed by the water jets.
- Wide-based items should be placed at an angle so that water can run off them freely.
- The spray arms must not be blocked by items that are too tall or hang through the baskets. Test for free movement by manually rotating the spray arms.

- Make sure that small items cannot fall through the holders in the baskets. Small items such as lids should therefore be placed in the 3D MultiFlex tray or cutlery basket (depending on model).

Some foods may contain natural dyes, e.g. carrots, tomatoes or ketchup. These dyes can discolour plastic items in the dishwasher if large quantities of these foods are in contact with the crockery inside the appliance. The stability of plastic items is not affected by this discolouration. Washing silverware can also cause plastic items to discolour.

Loading the dishwasher

Items not suitable for dishwashers:

- Wooden cutlery and crockery or items with wooden parts: these may discolour and fade. The glue used in these items is not dishwasher-proof and wooden handles may come loose after being washed in a dishwasher.
- Craft items, antiques, valuable vases and decorative glassware: such items are not suitable for dishwashers.
- Plastic items that are not heat resistant: the high temperatures in the dishwasher may cause them to melt or lose shape.
- Copper, brass, tin and aluminium items: these may discolour or become dull.
- Colours painted over a glaze: these may fade after a number of washes.
- Delicate glassware and glassware containing lead crystal: clouding may occur over time.

Silver

Silver that has been in contact with foods containing sulphur can discolour. These include egg yolk, onions, mayonnaise, mustard, pulses, fish, fish brine and marinades.

Silverware previously cleaned with a **silver polish** may still be damp or spotted at the end of a programme, where water has not run off smoothly.

Tip: Rub the silver dry with a cloth.



Damage due to caustic alkaline detergents.

Aluminium parts (e.g. the grease filters of cooker hoods) can be damaged by caustic alkaline detergents. In extreme cases, there is a risk of an explosive chemical reaction (such as an explosive oxyhydrogen gas reaction).

Aluminium components must not be cleaned in the dishwasher with caustic alkaline commercial or industrial detergents.

Tip: When purchasing new crockery and cutlery, make sure they are dishwasher-proof if you want to wash them in the dishwasher.

Glass care

- Clouding may occur on glasses after frequent washing in the dishwasher. When washing delicate glassware in the dishwasher, ensure that only a special glass-care programme with very low temperatures is selected (see "Programme overview"). This will reduce the risk of clouding.
- Purchase glassware that is dishwasher-safe (e.g. Riedel glassware).
- Use detergents with glass protective additives.
- Visit <http://www.mieleglasscare.com> for more information on glass care.

Loading the dishwasher

Upper basket

See the “Loading the dishwasher” chapter, “Loading examples” section for examples of how to load crockery and cutlery.

Loading the upper basket

 Damage due to leaking water.

If you run the dishwasher without the upper basket, water can leak out of the dishwasher.

Only run the dishwasher with the upper basket in place.

- Use the upper basket for small, lightweight and delicate items such as cups, saucers, glasses and dessert bowls.
Shallow pots can also be placed in the upper basket.
- Long items such as soup ladles and mixing spoons should be placed lying down across the front of the upper basket.

Loading the FlexCare cup rack

You can put cups, small bowls and flat crockery on the FlexCare cup rack. Glasses can be arranged along the cup rack so they sit securely during the programme.

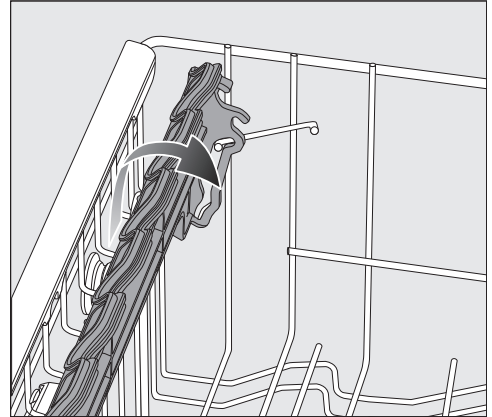

- Lower the cup rack to do so.
- Raise the cup rack upwards to make room for tall items.

Adjusting the FlexCare cup rack

You can set the height and depth of the cup rack at two different levels, so that it can accommodate larger cups and so that taller crockery can be placed underneath it.

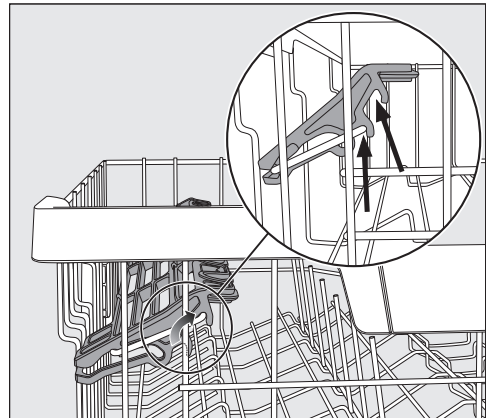

- Pull the cup rack upwards and click it into the desired position (see arrow).

Loading the dishwasher

Loading the silicone elements of the FlexCare cup rack

The silicone elements in the cup rack are specially designed to hold tall glasses with long stems securely.

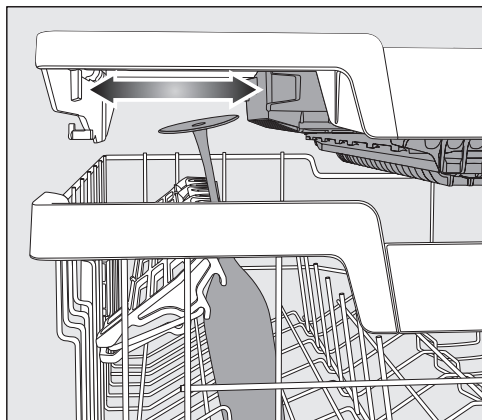

- Lower the cup rack and lean the glasses against the openings.
- If you wish you can adjust the left insert of the 3D MultiFlex tray to make space for taller glasses (see the “Cutlery” chapter, “3D MultiFlex tray” section).

Lower the spikes

On both right-hand rows of spikes, you can lower every other spike to make it easier to arrange larger crockery, like cereal bowls.

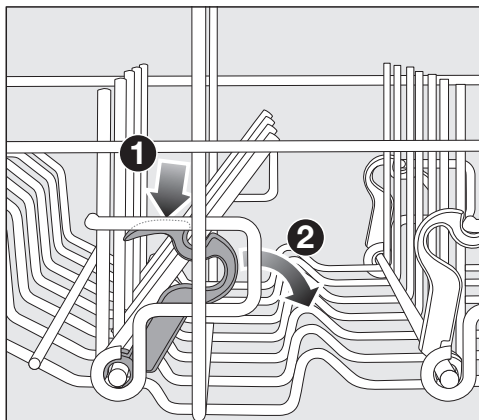

- Press the yellow lever downwards ①, and then lower the dark grey spikes ②.
- Place the bowls vertically in the row of spikes.

Loading the dishwasher

Adjust the upper basket

In order to gain more space for taller pieces of crockery in the lower or upper basket, the upper basket can be adjusted on three levels with 2 cm between each level.

The upper basket can also be set at an angle so that water can run off freely from recesses. Make sure, however, that the basket can slide smoothly in and out of the wash cabinet.

- Pull out the upper basket.

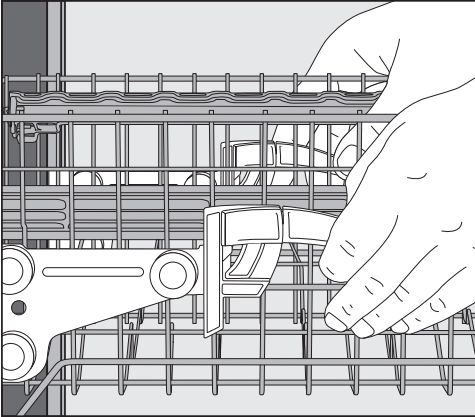

To raise the upper basket:

- Lift the basket up until it clicks into place.

To lower the upper basket:

- Pull upwards on the levers at either side of the upper basket.
- Adjust the basket to the desired height and then push the levers securely back down into position.

When adjusting the upper basket, make sure it does not block the middle spray arm.

Lower basket

See the “Loading the dishwasher” chapter, “Loading examples” section for examples of how to load crockery and cutlery.

Loading the lower basket

- Place larger and heavier items such as plates, serving platters, saucepans, bowls etc., in the lower basket. Glasses, cups and small plates and saucers can also be placed in the lower basket.

Loading the MultiComfort zone

The rear section of the lower basket is used for washing cups, glasses, plates and pots.

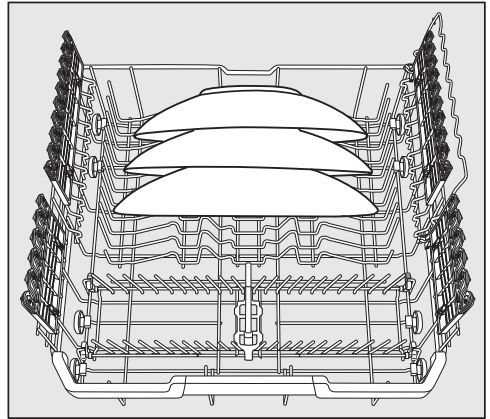

- Place very large plates in the middle of the lower basket.

Tip: When tilted, plates up to 35 cm in diameter can be accommodated.

Loading the dishwasher

Lower the spikes

The spikes at the front are used for washing plates, soup bowls, platters, dessert bowls and saucers.

Both rows of spikes can be lowered to make more room for large items such as pots, pans and serving dishes.

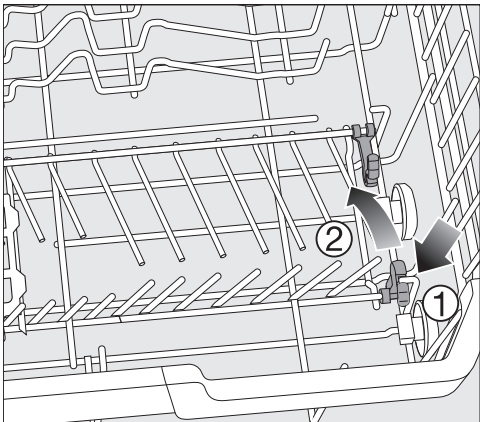

- Press the yellow lever downwards ①, and then lower the spikes ②.

Loading the FlexCare glass holder with MultiClips

The silicone elements in the glass holder provide a stable and secure hold for delicate stemware.

- Stemware such as wine glasses, champagne flutes and beer glasses can be leaned against the glass rack or suspended from it.
- The glass rack can be raised to make more room for tall items.

You can set the glass rack at two different heights.

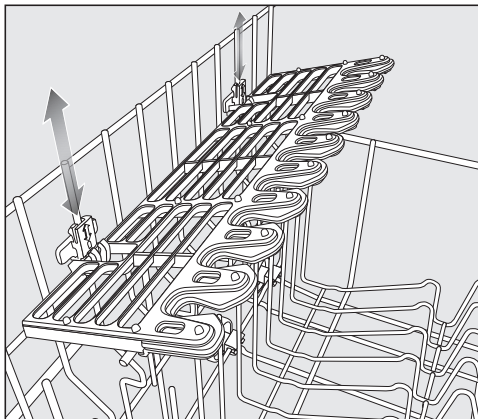

- Slide the glass rack to the desired height until the catches click into place at the top or the bottom.

Loading the dishwasher

The MultiClips enable you to fasten light items such as those made from plastic onto the glass holder.

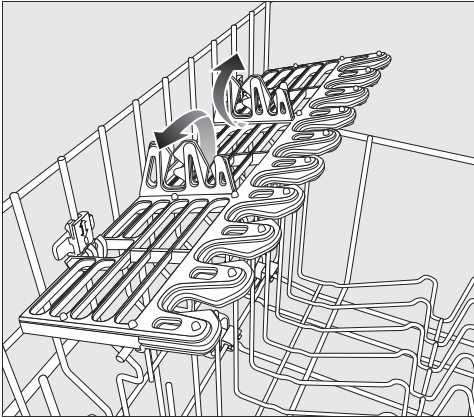

- Fold up the MultiClips.

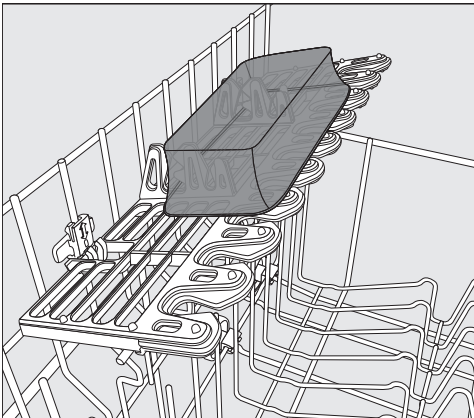

- Secure light items to the MultiClips.

Loading the glass rail

This rail is designed to hold glasses with long stems securely.

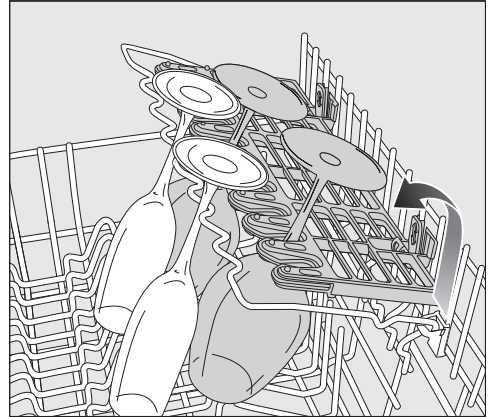

- Lower the glass rail and lean the glasses against it.

Lower the bottle holder

The bottle holder can be used to keep narrow items such as milk and baby bottles secure during a programme.

- Raise the bottle holder upwards and push it down until it clicks into place.

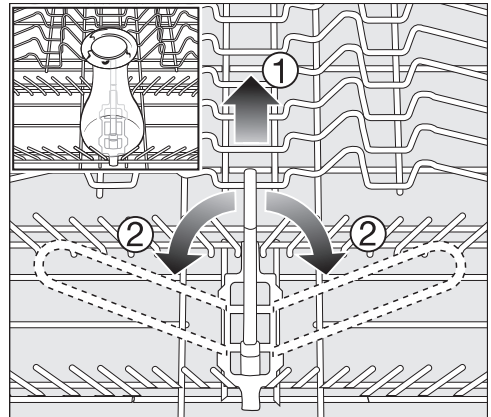

- If the bottle holder is not needed, lift it up using the yellow lever ① and fold it to the side ②.

Loading the dishwasher

Cutlery tray

See the “Loading the dishwasher” chapter, “Loading examples” section for examples of how to load crockery and cutlery.

- Load the cutlery into the 3D MultiFlex tray.

Loading the 3D MultiFlex tray

To make unloading easier, cutlery should be grouped in zones, one for knives, one for forks, one for spoons, etc.

Spoon heads should be placed in contact with at least one of the serrated retainers on the base of the cutlery tray to ensure that water runs off them freely.

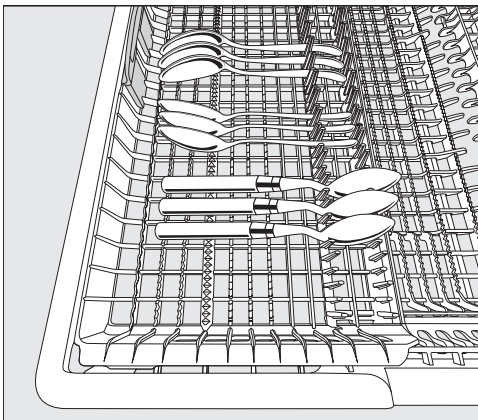

- If spoon handles do not fit between the holders, then lay them the other way round.

You can push the left insert to the middle in order to accommodate tall items of crockery and long stemmed glasses in the upper basket (see “Upper basket” chapter, “Loading the silicone elements of the FlexCare cup rack” section).

You can put large and long cutlery (such as salad servers and chef’s knives) in the recessed centre part of the tray.

Arrange tall items (such as cake slices) so that they do not block the upper spray arm.

You can adjust the height of the right-hand insert to create more space in the right-hand part of the tray for larger cutlery items or smaller pieces of crockery.

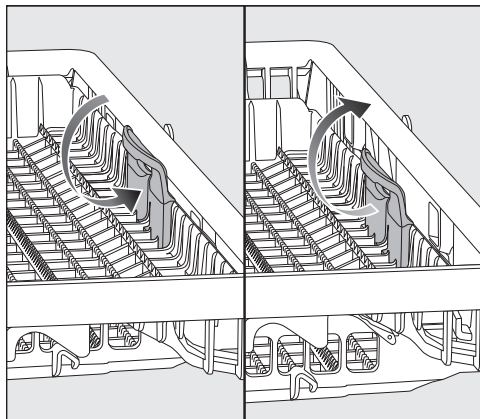

- Pull the insert inwards by the yellow handle and click it into place in one of the two positions.

Loading the dishwasher

Loading examples

Dishwashers with cutlery tray

Upper basket

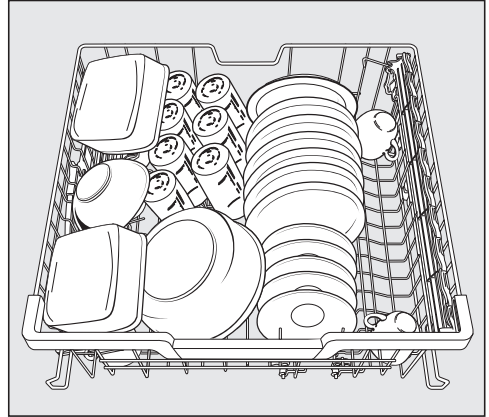
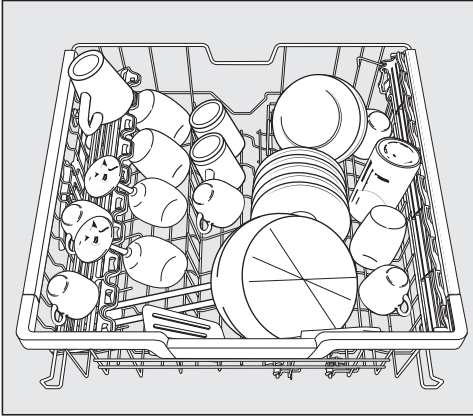

Lower basket

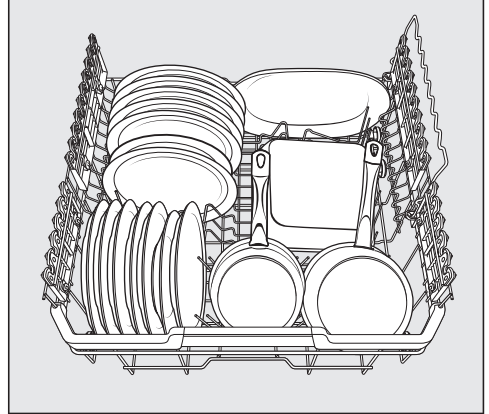
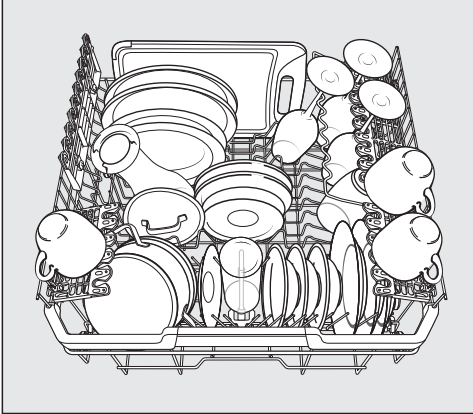

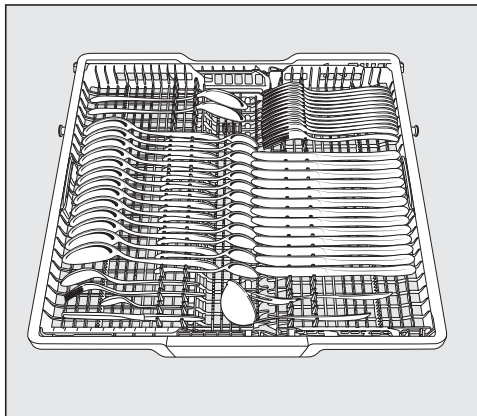
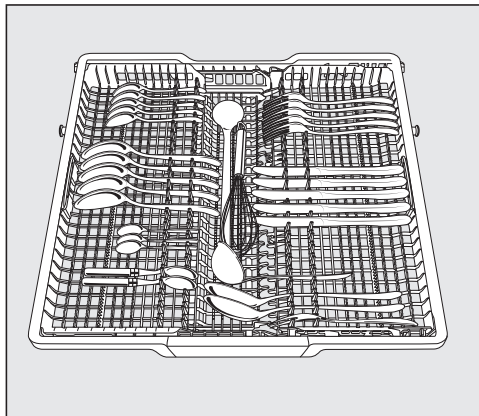

Loading the dishwasher

Cutlery tray

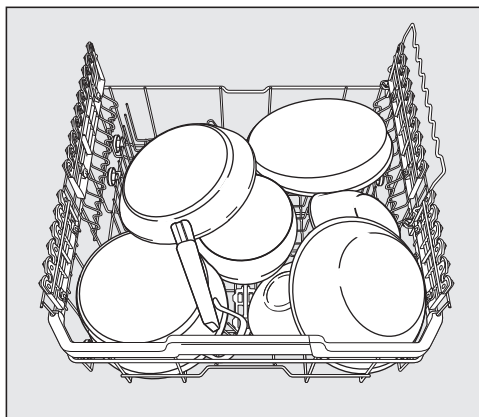

Heavily soiled items



 Risk of chemical burns from detergent.

Dishwasher detergents can cause burning on the skin and in the eyes, nose, mouth and throat.

Avoid contact with detergents.

Do not inhale powder detergents. Do not swallow dishwasher detergents.

Seek medical attention immediately if detergent has been swallowed or inhaled.

Keep children away from detergents.

Detergent residues could still be present in the dishwasher. Keep children away from the dishwasher when the door is open. Do not fill the detergent dispenser until just before starting the programme and activate the door safety lock (depending on model).

 Risk of damage due to detergents containing active chlorine.

Powder and liquid detergents containing active chlorine must not be used. They can damage plastics and seals in the dishwasher.

Do not use detergents containing active chlorine.

Field of application

To set the field of application, see “Settings  – Field of application”.

The detergent selected must be appropriate for the setting in which the dishwasher is being used. If the dishwasher is being used in a **commercial setting**, it is recommended that commercial detergents are used. You can easily order powder and liquid detergents and other process chemicals for your dishwasher for commercial use via the Miele professional website: <https://miele.co.uk/p/>. Look for ProCare Shine products under cleaning agents.



If you are using your dishwasher in a **private setting**, it is recommended that detergents designed for domestic dishwashers are used. Suitable detergents are available from Miele. You can easily order powder detergents and other consumables for your dishwasher for domestic use via the Miele app or the Miele website: <https://www.miele.de/haushalt/produktauswahl-miele-spuelmittel>



Detergent

Powder detergents and detergent tabs

Use powder detergent or detergent tabs only in the door dispenser compartment.

Only use detergent tabs that are quick dissolving. Suitable detergent tabs are available from the Miele range. When using combination detergents (tabs that offer rinse aid as well as water softeners and detergent), it is recommended that you also add rinse aid and dishwasher salt (at a lower concentration) owing to the short programme running times and potentially the water quality.

- Add powder detergent or detergent tabs to the detergent compartment.

Dispensing detergent

The detergent compartment holds a maximum of 50 ml.

There are marks in the detergent compartment to aid with dispensing: 20, 30, max. When the door is opened to a horizontal position, they show the approximate fill level in ml and the maximum fill height.

They also indicate the approximate fill level in grams for powder detergents, depending on the manufacturer and the coarseness.

- Follow the detergent dosage recommended by the manufacturer on the packaging.
- Unless directed otherwise, use one detergent tab or add 20 to 30 ml of powder detergent to the detergent compartment, depending on the degree of soiling of the crockery.

Failure to dispense the recommended amount of detergent may impair cleaning results.

Adding detergent

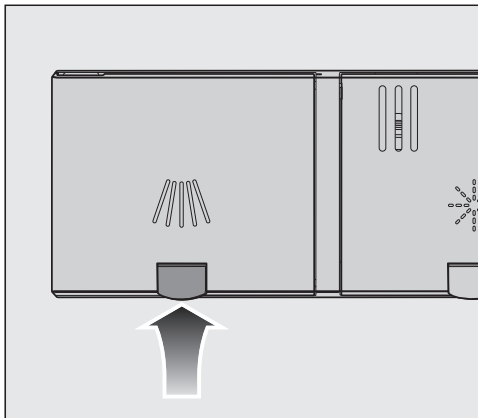

- Press the yellow button  on the lid of the detergent compartment.

The lid will spring open.

The lid will also open at the end of a programme sequence.

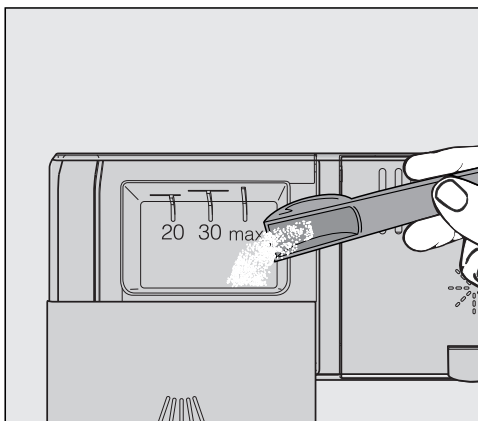

- Add the detergent to the detergent compartment.
- Push the lid shut until you hear it click into place.

The detergent must not cause the detergent compartment lid to get stuck. This can prevent the lid from opening during the programme sequence.

Do not overfill the detergent compartment.

- Ensure that the detergent packaging is properly closed after use. This prevents the detergent from getting damp and clumping together.

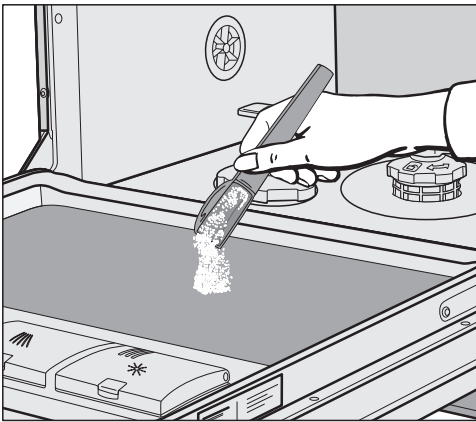

- You can also apply a small amount of detergent to the inner panel of the door in programmes that have a pre-wash stage (see “Programme chart”).

Liquid detergent

This dishwasher can be fitted with an external dispenser pump for liquid detergent (DOS module).

See “Settings menu - External dispensing” to activate the dispenser pump and set the dosage.

For special soiling and if using liquid detergent, contact Miele for advice on how to set the dosage for best results.

Refilling or changing containers

The dispensing module is equipped with a level monitoring function. Refill detergent will appear in the display when the level drops below the minimum.

- As soon as the message appears in the display, refill or replace the container with a full one containing the appropriate process chemical at the end of the programme.
- Confirm the message shown with the *OK* button.

Replace the container in good time to prevent the dispensing system being emptied completely.

An empty dispensing system must be vented before starting the next programme.

- Place the container on the open dishwasher door or on a surface which is easy to clean.
- Take the lid off the media canister and remove the suction lance. Place the suction lance on the open wash cabinet door.
- Fill or replace the container, fit the suction lance and secure the lid. Observe the colour coding.

Detergent

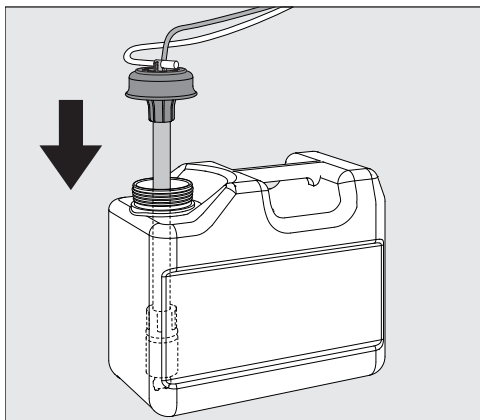

- Feed the suction lance into the canister until it reaches the bottom.
- Wipe up any spilled process chemical thoroughly.
- Place the canister on the floor beside the dishwasher or in an adjacent cabinet. The container must be at the same level as the appliance and not be placed on top of or above the appliance.
- The dispensing system must then be vented.

Checking consumption

Monitor the amount of process chemicals used by regularly checking the level in the container in order to detect any dispensing irregularities.

Changing detergent

If you want to change the detergent used, the system must first be rinsed through with water to avoid a reaction between the different detergents.

- Remove the siphon from the canister and place it in a container of water.
- Start “Vent dispensing system” **twice** (see “Settings menu, External dispensing”) to the rinse the system.
- Then place the siphon in the new canister and start “Vent dispensing system” again.

The dispensing system is ready for operation.

Always follow the recommendations of the detergent manufacturer whether using powder or liquid detergent.

Switching on the dishwasher

- Open the stopcock, if it is closed.
- Open the door.
- Make sure the spray arms can rotate freely.
- Touch the  sensor control.

If the dishwasher has been switched off for longer than 1 minute, you will need to hold the  sensor control for a bit longer (wipe protection).

The programme selected will appear briefly in the display and the appropriate sensor control will be illuminated.

Next, the estimated water consumption may be shown for the chosen programme for several seconds.

Then the display will show the estimated duration for the selected programme.

Selecting a programme

Choose your programme according to the type of crockery and the degree of soiling.

The different programmes and their uses are described in the **“Programme chart”** later on in this booklet.

- Touch the sensor control for the required programme.

The sensor control for the selected programme will light up.

Further programmes can be selected under .

- To do so, touch the  sensor control.

The first of the further programmes will appear in the display.

- Use the \vee/\wedge sensor controls in the display to select the programme you want.





You can now select programme options (see “Programme options”).

If any programme options are selected, the appropriate sensor controls will also light up.

Display of programme running time

The estimated duration of the selected programme appears in the display before the programme begins. If the door is opened during the programme sequence, the time left until the end of the programme is displayed.

Symbols appear to indicate which stage the programme is at:

-  Pre-wash/Soak
-  Main wash
-  Interim rinse
-  Final rinse
-  Drying
-  Finished

The displayed duration may vary for the same programme. It is influenced by, for example, the temperature of the incoming water, the reactivation cycle of the water softener and the amount of crockery and how soiled it is.

When a programme is selected for the first time, the display will show the average running time for a hot water connection.

The running times shown in the “Programme overview” chapter refer to standard test loads and temperatures.

Operation

For each programme sequence, the control module calculates the programme running time according to the temperature of the incoming water and the amount of crockery.

Starting the programme

- Start the programme by closing the door.
Confirm the previously displayed messages with *OK*.

The in-operation indicator light comes on to show that a programme sequence has been started.

During a programme sequence, you can use *OK* to display the name of the programme that is currently running while the door is open.

 Risk of scalding due to hot water.
During operation, water in the dishwasher may be very hot.
During operation, only open the door with extreme caution.

End of the programme

At the end of a programme, the in-operation indicator light will flash slowly with the door shut. The buzzer might also sound.

The in-operation indicator light will go out 10 minutes after the end of the programme if the door is closed.

The programme has ended when the display shows the message  Finished.

If the Consumption programmable function is switched on, you can now call up the actual water consumption of the programme that has just finished (see the “EcoFeedback consumption indicator” section in the “Caring for the environment” chapter).

The drying fan may continue to run for a few minutes at the end of the programme.

 Risk of damage due to steam.
Steam from the dishwasher could damage the edges of worktops when you open the door at the end of the programme if the fan is no longer running.
If you would like to open the door at the end of the programme, then make sure that you open the door fully.

Energy management

To save energy the dishwasher will switch off automatically 10 minutes after the last time a sensor control is pressed or after the end of a programme.

You can switch the dishwasher back on again with the  sensor control.

If the dishwasher has been switched off for longer than 1 minute, you will need to hold the  sensor control for a bit longer (wipe protection).



The dishwasher will not switch itself off whilst a programme is running or if there is a fault.

Switching off the dishwasher

- Open the door.
- The dishwasher can be switched off at any time using the  sensor control.
- Confirm the query Switch appliance off with *OK*.

Switching the dishwasher off during a programme stops the programme.

You can also do this to stop an ongoing timer.

- If you have touched the  sensor control, but in fact do not wish to cancel the programme, use the  button to select the Do not switch off option on the display and confirm with *OK*.

 Risk of damage from leaking water.

Water leakage can cause damage.

If the dishwasher is not going to be used for a longer period of time, e.g. whilst on holiday, the stopcock should be closed as a precaution.

Unloading the dishwasher

Dishes tend to break and chip more easily when they are hot. Allow the dishes to cool until they are comfortable enough to handle before unloading them.

If you open the door fully after switching off, the dishes will cool much faster.

- First unload the lower basket, then the upper basket and finally the 3D MultiFlex tray (if present). This will prevent water drops from the upper basket and 3D MultiFlex tray from falling onto the dishes in the lower basket.

Interrupting a programme

 Damage due to leaking water.

The door of the commercial dishwasher must not be opened during operation.

Once the programme has started, leave the door closed to ensure that no water drips out.

Programme options

Options

Options can be selected and deselected using the appropriate buttons and the display before starting the programme.

- Open the door.
- Switch the dishwasher on by touching the  sensor control.

The *Start* sensor control flashes.

- Select a programme.
- Press the button for the option you want.

The indicator light for the relevant button will come on if the option is available for the programme selected.

If the option is not compatible with the programme selected, a message to this effect will appear in the display.

- In this instance, confirm the message with *OK*.
- Start the programme by closing the door.

The option selected will remain active for that particular programme until the setting is changed.

Time left indicator

The Time left indicator  option is selected as standard and displays the time remaining until the end of the programme.

Temperature

The Temperature  option shows the current temperature of the wash block.

Extra dry

The Extra dry  option improves the drying performance in programmes in which this option is available.

Energy consumption is increased due to an extended fan running time.

Settings

The Settings  option opens the menu to enable settings to be selected on the appliance and changes to be made to programme parameters.

See the “Settings” menu for more information.

Timer



The timer  gives you several options for starting a programme at a later time. You can set the start time or the finish time of a programme. You can also use the EcoStart or SmartStart functions to benefit from cheaper electricity tariffs at night.

With manual detergent dispensing, the detergent can clump together if the detergent compartment is not dry, and it may not be fully rinsed out. When using the timer function, make sure that the detergent compartment is dry before adding detergent. Wipe dry with a cloth first, if necessary. Do not use liquid detergents. These can leak out.

 Danger to health due to detergent.

To prevent children coming into contact with dishwasher detergent: Do not fill the detergent dispenser **until just before starting the programme**, i.e. before you activate the timer.

Activating the timer

- Open the door.
- Switch the dishwasher on using the  sensor control.
- Select the programme you want to use.
- Touch the  sensor control.

The  sensor control lights up.

You can use the ∇/\wedge sensor controls to choose between the Start at, Finish at or EcoStart functions, or SmartStart if applicable.

- Confirm selection of the function you want with *OK*.

The last time set for the timer will be displayed and the hour number block will be highlighted.

- Enter the time you want for the timer using the ∇/\wedge sensor controls and confirm with *OK*.

If, while you are setting the time, you do not apply any settings for several seconds, the display will revert to the previous menu level. You will then have to enter your settings again.

After you have activated the timer, all the displays will switch off after a few minutes to save energy.

You can also activate a timer via the Miele app.

Programme options

Setting “Start at”

With the *Start at* function, you set the exact time you want the programme to start at.

- Use the \vee/\wedge sensor controls to enter the hour and confirm your entry by touching *OK*.

The hour will be saved and the minute number block will be highlighted.

- Use the \vee/\wedge sensor controls to enter the minutes and confirm your entry by touching *OK*.

The saved start time for the selected programme will appear in the display for several minutes.

- Close the door.

When the set time is reached, the selected programme will begin automatically.

Setting “Finish at”

Use the *Finish at* function to set the latest time by which the selected programme has to be finished.

- Use the \vee/\wedge sensor controls to enter the hour and confirm your entry by touching *OK*.

The hour will be saved and the minute number block will be highlighted.

- Use the \vee/\wedge sensor controls to enter the minutes and confirm your entry by touching *OK*.

The estimated start time for the selected programme will appear in the display for several minutes.

A message will appear in the display if the programme cannot be completed by the set finish time because it has too long a running time. It will show the time that can be set.

- If it appears, confirm the message with *OK*.
- Close the door.

The selected programme will start automatically when the estimated start time is reached.

Setting EcoStart

You can use the EcoStart function to benefit from cheaper electricity tariffs at night. Before you can use this option, you need to set up to three electricity tariff time zones (see the “EcoStart” section in the “Settings” chapter).

Then set the latest time by which the selected programme has to be finished. The dishwasher will then start automatically in the most economical tariff zone within the time set.

- Use the ∇/\wedge sensor controls to enter the hour and confirm your entry by touching *OK*.

The hour will be saved and the minute number block will be highlighted.

- Use the ∇/\wedge sensor controls to enter the minutes and confirm your entry by touching *OK*.

The estimated start time for the selected programme will appear in the display for several minutes.



- Close the door.

The selected programme will start automatically when the estimated start time is reached.

Setting SmartStart

The SmartStart function is used for starting your dishwasher automatically at a time when your energy costs are most economical.

To use this function you may need further technical accessories.

If you have activated the SmartStart function in the Settings  menu, the *Timer*  menu will no longer show the EcoStart function but will instead show SmartStart (see the “Miele@home” section in the “Settings” chapter).

If your energy provider offers this service, they will send a signal to your dishwasher when energy costs are at their most economical.

This signal will start the dishwasher.

You can set the latest time by which the selected programme has to be finished. The dishwasher will then calculate the latest possible start time for the programme selected and will wait until this start time for the signal from the energy provider.

Programme options

Set the latest time by which the selected programme has to be finished.

- Use the \vee/\wedge sensor controls to enter the hour and confirm your entry by touching *OK*.

The hour will be saved and the minute number block will be highlighted.

- Use the \vee/\wedge sensor controls to enter the minutes and confirm your entry by touching *OK*.

The message *Waiting for SmartStart* will appear in the display.

- Close the door.

The selected programme will start automatically as soon as the energy provider has sent the signal or the latest possible calculated start time has been reached.

Changing or deleting set times

You can change the time set for the timer or delete it.

- Open the door.
- Touch the \oplus sensor control.
- Use the \vee/\wedge sensor controls in the display to select the previously activated timer function and confirm your entry with *OK*.
- Use the \vee/\wedge sensor controls to select the *Change* or *Delete* function and confirm with *OK*.

After confirming the *Change* function using *OK*, you can change the time set for the timer.

After confirming the *Delete* function using *OK*, the running time of the selected programme will appear in the display.

The \oplus sensor control goes out and the sensor control for the selected programme will light up.



You can now start a programme or switch the dishwasher off.

Switching the dishwasher off while a timer is running stops the timer.

You can also change or delete the time set for the timer using the Miele app.

Activating Remote start

You can start your dishwasher remotely using the Miele app. To do this, you first need to install the app on your mobile device, connect the dishwasher to your WiFi network (see “Settings – Miele@home”) and, if applicable, activate the Remote control option (see “Settings – Remote control”).

- Open the door.
- Switch the dishwasher on using the  sensor control.
- Touch the  sensor control.

The  sensor control lights up.

- Switch the dishwasher off using the  sensor control.
- Close the door.









The dishwasher can now be operated remotely using the Miele app.

The Remote start option will remain activated until you deactivate it again using the  sensor control. The option will also remain active if you switch the dishwasher off and back on again in the meantime.

Even if the Remote start option is not active, you can check the status of your dishwasher and apply settings using the Miele app.

If you start a programme by closing the dishwasher door, the Remote start option will automatically be activated for the duration of the programme.

Programme chart

Programme	Application	Detergent
		The following dosages are based on Miele detergents. Please follow the manufacturer's instructions. Detergent compartment  ¹⁾
 Short	For fresh, easily removed food residues.	20–25 g or 1 tab
 Universal	For normal, slightly dried food residues.	20–25 g or 1 tab
 Intensive	For burnt-on, stubborn, dried-on food deposits containing starch or protein ¹⁾	20–25 g or 1 tab
 Glasses	Special glassware programme.	20–25 g or 1 tab
 ECO *)	Energy-saving programme with a long duration for normal, slightly dried food residues.	20–25 g or 1 tab
 Plastics	Special plastics programme.	20–25 g or 1 tab
 Hygiene	Special hygiene programme for items that need to be hygienically clean	20–25 g or 1 tab
 Cold pre-wash	To rinse heavily soiled items, e.g. for initial removal of soiling or to prevent residues drying on to dishes when a complete programme does not yet need to be run.	

*) This programme is the most efficient in terms of its combined energy and water consumption for cleaning crockery with a normal level of soiling.
(Fixed programme sequence which cannot be altered)

¹⁾ See “Detergent” chapter

Programme chart

Programme sequence				
Pre-wash	Cleaning	Interim rinse I	Final rinse	Drying
	X 70 °C 30 s	X 10 s	X 65 °C ³⁾ 10 s	(X) 15 min
	X 65 °C 10 min	X 3 min	X 65 °C ³⁾ 1.5 min	(X) 30 min
X 8 min	X 75 °C 10 min	X 3 min	X 65 °C ³⁾ 1.5 min	(X) 30 min
	X 50 °C 1 min	X 3 min	X 50 °C 1 min	(X) 20 min
	X 52 °C 30 min	X 12 min	X 46 °C 10 min	X 92 min
X 8 min	X 75 °C 10 min	X 3 min	X 70 °C ³⁾ 3 min	X 30 min
X 10 min	X 50 °C 1 min	X 5 min	X 60 °C 30 s	X 45 min
	X Cold 10 min			

X = stages included in a programme

(X) = optional stages which can be selected (see "Programme options, Options")







²⁾ Select Interim rinse II via the Settings button  (see "Settings menu, 2nd interim rinse").

³⁾ Optional temperature increase to 82 °C.

⁴⁾ Due to the short programme duration AutoOpen does not take place at the end of the programme.

⁵⁾ Without rinse aid and with cold water.

Programme chart

Programme	Consumption ⁶⁾			Duration ⁶⁾	
	Energy		Water	Cold water 15 °C	Hot water 55 °C
	Cold water 15 °C	Hot water 55 °C			
 Short	1.4 kWh	0.9 kWh	14.7 l	25 min ⁷⁾	18 min ⁷⁾
 Universal	1.5 kWh	0.9 kWh	14.8 l	36 min ⁷⁾	31 min ⁷⁾
 Intensive	1.7 kWh	1.0 kWh	19.2 l	50 min ⁷⁾	44 min ⁷⁾
 Plastics	1.2 kWh	0.5 kWh	19.5 l	67 min	60 min
 Glasses	1.0 kWh	0.4 kWh	15.3 l	25 min ⁷⁾	20 min ⁷⁾
 Hygiene	1.8 kWh	1.1 kWh	19.2 l	56 min ⁷⁾	49 min ⁷⁾
 Cold pre-wash	0.02 kWh	0.02 kWh	4.5 l	13 min	13 min

⁶⁾ Values are calculated in accordance with EN 50242 for a connected load of 6.3 kW. In practice, considerable variations may be noted due to differing conditions. The duration displayed is adjusted to the on-site conditions.

⁷⁾ The figure refers to the wash duration without drying.

Programme chart

Consumption data in ECO programme

Programme	Consumption ⁸⁾			Duration ⁸⁾	
	Electrical energy		Water	Cold water 15 °C	Hot water 55 °C
	Cold water 15 °C	Hot water 55 °C			
 EnergySave 14 standard place settings	0.950 kWh	0.6 kWh	12 l	250 min	245 min

⁸⁾ Values for the *ECO* programme were calculated under standardised testing conditions. In practice, the selected settings, programme options or operating conditions may result in different values.

Cleaning and care

Periodic checks

To prolong the service life of the dishwasher, maintenance should be carried out **at least once a year** by the Miele Customer Service Department.

Maintenance covers the following:

- Electrical safety according to national regulations (e.g. VDE 0701/0702 in Germany)
- Door mechanism and door seal
- Any screw connections and connectors in the wash chamber
- Water inlet and drainage
- Internal and external dispensing systems
- Spray arms
- Filter combination
- Sump including drain pump and non-return valve
- All baskets and inserts

The following operational tests will be carried out as part of the maintenance:

- A programme sequence will be run as a test run
- Seals will be tested for water tightness
- All relevant measuring systems will be safety tested, including fault displays
- Safety features

Check the condition of your dishwasher regularly (approx. every 4–6 months). In this way, faults and problems can be avoided.

 Damage due to unsuitable cleaning agents.

All surfaces are susceptible to scratching. Contact with unsuitable cleaning agents can alter or discolour all surfaces.

Only use cleaning agents formulated for use on the relevant surfaces.

Cleaning the wash cabinet

The wash cabinet is largely self-cleaning, provided that the correct amount of detergent is always used.

If, despite this, limescale or grease deposits build up in the chamber, these can be removed with a proprietary dishwasher cleaner (available from the Miele Customer Service Department or the Miele webshop). Follow the instructions on the product packaging.

- Clean the filters in the wash cabinet regularly.

Cleaning the door and the door seal

The door seals and the sides of the dishwasher door cannot be reached and cleaned by the spray arm jets.

- Wipe off any food or drink residues which may have dripped onto the sides and seals of the dishwasher door with a damp cloth on a regular basis to prevent the build-up of mould.

Cleaning the control panel

- The control panel should **only** be wiped with a damp cloth.

Cleaning the reflector panel

The reflector panel for the optical in-operation indicator light is situated on the cover sheeting underneath the worktop.

- The reflector panel should only be cleaned with a damp cloth if necessary.

Cleaning the appliance front



Damage due to soiling.

Soiling that is left too long might become impossible to remove and could cause the external surfaces to alter or discolour.

It is therefore best to remove any soiling immediately.

- Clean the appliance front with a clean soft sponge and a solution of warm water and washing-up liquid. After cleaning, wipe the surfaces dry using a soft cloth.
A clean, damp microfibre cloth without detergent can also be used.

To avoid damaging the external surfaces, do not use the following:

- Detergents containing soda, ammonia, acids or chlorides
- Detergents containing descaling agents
- Abrasive detergents, e.g. scouring powder, scouring liquid, or pumice stones
- Detergents containing solvents
- Stainless steel cleaning agents
- Dishwasher cleaner
- Oven cleaner
- Glass cleaning agents
- Hard, abrasive brushes or sponges, e.g. pot scourers, brushes or sponges that have been previously used with abrasive cleaning agents
- Eraser stain remover blocks
- Sharp metal scrapers
- Wire wool
- Steam cleaners

Cleaning and care

Cleaning the spray arms

Particles of food can get stuck in the spray arm nozzles and bearings. The spray arms should therefore be inspected regularly (approx. every 2–4 months).

 Damage due to soiling entering the circulation system.

Without filters, soiling can enter the circulation system and cause a blockage.

Do not run a wash programme without the lower spray arm or without the filters.

When cleaning the filters and spray arms, make sure that coarse soiling cannot get into the circulation system.

- Switch the dishwasher off.

Removing the upper and middle spray arms

- Take out the 3D MultiFlex tray (if your dishwasher is fitted with one).
- Push the upper spray arm upwards to engage the inner ratchet. Then unscrew the spray arm by rotating the screw thread anti-clockwise.

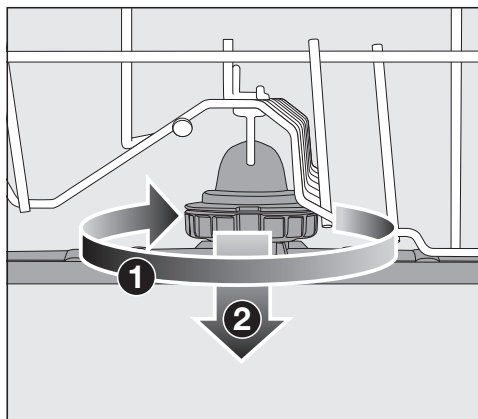

- Rotate the screw thread of the middle spray arm clockwise ① (see diagram) and remove the spray arm ②.

Removing the lower spray arm

- Remove the lower basket.

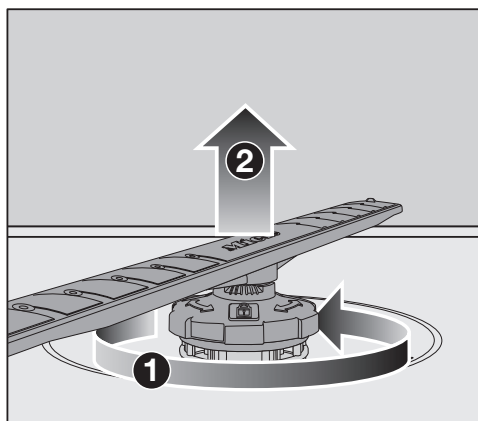

- Rotate the screw thread of the lower spray arm anti-clockwise ① and pull the spray arm upwards to remove ②.

Cleaning the spray arms

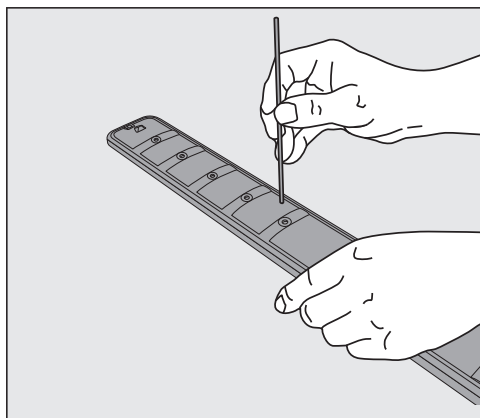



- Use a pointed object to push food particles in the nozzles into the spray arm.
- Rinse the spray arm thoroughly under running water.

Refitting the spray arms

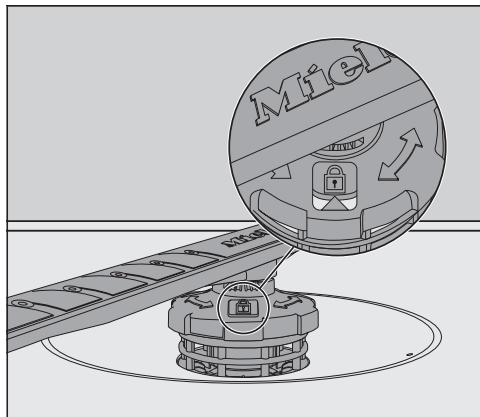
- Refit the upper and middle spray arms.
- Refit the lower spray arm and ensure that the filter combination lies flat in the base of the wash cabinet.



- Rotate the screw thread of the lower spray arm clockwise until the arrow in the viewing window points to the lock symbol .
- Make sure the spray arms can rotate freely.

 Damage due to soiling entering the circulation system.

The lower spray arm is used to secure the filter combination. Without filters, coarse soiling can enter the circulation system and cause a blockage.

Do not run a wash programme without the lower spray arm or without the filters.

Cleaning and care

Checking the filters in the wash cabinet

The filter combination in the base of the wash cabinet retains coarse soiling from the suds solution. This prevents soiling getting into the circulation system and re-entering the wash cabinet through the spray arms.

 **Damage due to soiling entering the circulation system.**

Without filters, soiling can enter the circulation system and cause a blockage.

Do not run a wash programme without the lower spray arm or without the filters.

When cleaning the filters and spray arms, make sure that coarse soiling cannot get into the circulation system.

The filters can become blocked by soiling that collects over time. The level of soiling and time it takes before the filters need cleaning will vary depending on use.

The message **Check filters** will appear in the display after every 50 programme sequences.

- Check the filter combination.
- Clean the filter combination if necessary.
- Then confirm the message with *OK*.

Cleaning the filters

- Switch the dishwasher off.
- Remove the lower spray arm (see “Cleaning and care” chapter, “Cleaning the spray arms” section).
- Before removing the filter combination, remove any coarse soiling to prevent it from entering the circulation system.

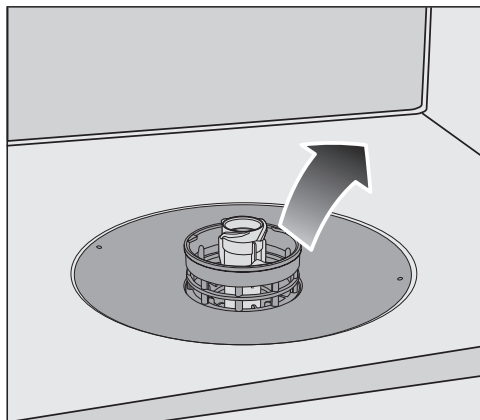

- Remove the filter combination.

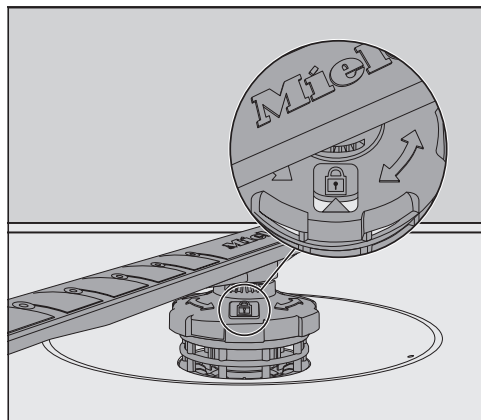
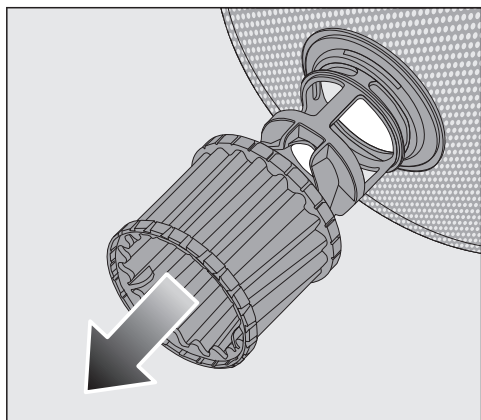

- In order to clean the inside of the filter, pull the microfilter on the plastic ring downwards and away from the filter combination.
- Rinse all the parts under running water.
If necessary, use a soft cleaning brush to remove soiling.
- Insert the microfilter back into the filter combination.
- Refit the filter combination so that it lies flat in the base of the wash cabinet.
- Refit the lower spray arm to the filter combination using the screw thread.

- Rotate the screw thread clockwise until the arrow in the viewing window points to the lock symbol .

 Damage due to soiling entering the circulation system.

The lower spray arm is used to secure the filter combination. Without filters, coarse soiling can enter the circulation system and cause a blockage.

Do not run a wash programme without the lower spray arm or without the filters.

Cleaning and care

Cleaning the water inlet filter

A filter is incorporated in the screw thread to protect the water inlet valve. If the filter is soiled, insufficient water flows into the wash cabinet.

 Risk of electric shock from mains voltage.

The plastic housing of the water connection contains an electrical valve.

The housing must not be dipped in water.

- Disconnect the dishwasher from the mains.
To do this, turn off the dishwasher, switch off at the socket and remove the plug.
- Close the stopcock.
- Unscrew the water inlet valve.

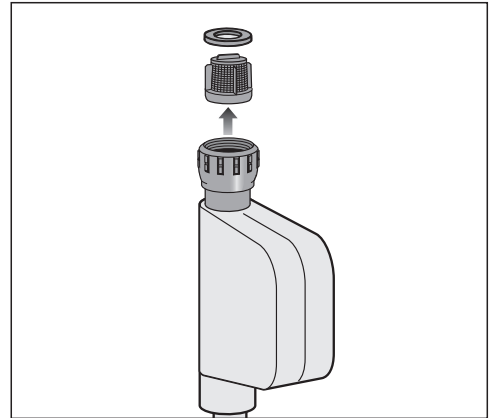

- Remove the seal from the screw thread.
- Using pointed pliers, take hold of the plastic filter slat and remove the filter.
- Rinse the filter under running water.
- Reassemble in reverse order.

Screw the screw thread securely back onto the stopcock. Slowly open the stopcock. If water drips out, tighten the screw thread.

Never forget to put the filter back in place after cleaning.

Cleaning the drain pump

If water remains in the wash cabinet after the end of a programme, the water has not been pumped away. The drain pump may be blocked by foreign objects. These are easy to remove.

- Disconnect the dishwasher from the mains.
To do this, turn off the dishwasher, switch off at the socket and withdraw the plug.
- Take the filter combination out of the wash cabinet (see “Cleaning and care” chapter, “Cleaning the filters”).
- Scoop the water out of the cabinet using a suitable small container or utensil.

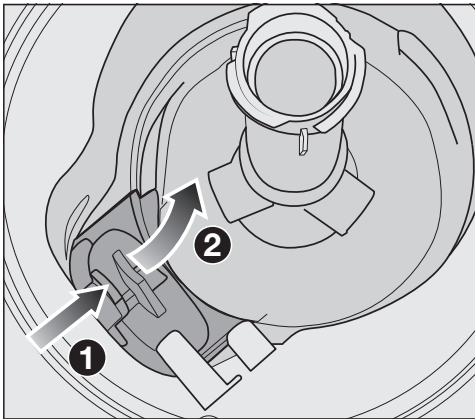

- Press the catch of the drain pump cover inwards ①.
- Tip the cover inwards until it is released ②.
- Rinse the cover thoroughly under running water and remove all foreign objects.

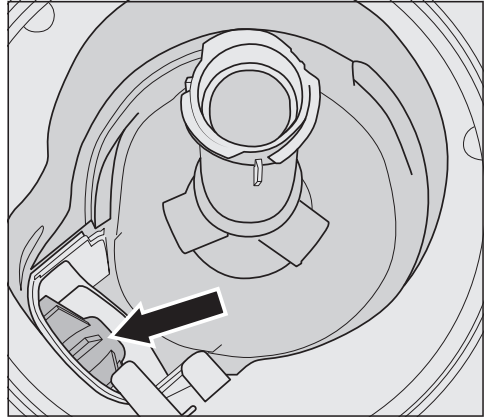

The drain pump (see arrow) is underneath the cover.

⚠ Risk of injury from glass splinters. It is especially difficult to see glass splinters in the drain pump. Take care when cleaning the drain pump.

- Carefully remove all foreign objects from the drain pump. Check the drain pump impeller by manually turning it. You will feel a little resistance when you turn the impeller.
- Refit the cover by placing it down vertically from above.

Ensure that the catch engages correctly.

⚠ Damage due to incorrect cleaning. The components are delicate and can be damaged during cleaning. Take care when cleaning the drain pump.

Troubleshooting

With the aid of the following guide, most minor problems that can occur during daily operation can be corrected without contacting Miele. You can save time and money in many cases, as you do not need to call the Miele Customer Service Department.

The following guide should help you to find the reason for a malfunction or fault and to correct it. You should, however, note the following:







Danger due to incorrect repairs.

Incorrect repairs can cause considerable danger to users.

Repairs must only be carried out by the Miele Customer Service Department, an authorised Miele dealer or a suitably qualified specialist.



Technical problems

Problem	Cause and remedy
The dishwasher will not start.	The door is not closed properly. ■ Raise the door upwards until the catch engages.
	The dishwasher is not plugged in. ■ Insert the plug and switch on at the socket.
	The mains fuse has tripped. ■ Reset the trip switch in the fuse box or replace the fuse in the plug (see data plate for minimum fuse rating). ■ If the mains fuse trips again, contact the Miele Customer Service Department.
	The dishwasher is not switched on. ■ Switch the dishwasher on using the  sensor control.
The dishwasher stops during a programme.	The mains fuse has tripped. ■ Reset the trip switch in the fuse box or replace the fuse in the plug (see data plate for minimum fuse rating). ■ If the mains fuse trips again, contact Miele Service.
After the programme has started, the optical in-operation indicator light is not visible.	The reflector panel was not correctly fitted. ■ Re-fit the reflector panel correctly (see installation sheet).

Problem	Cause and remedy
The  sensor control does not respond or only responds once it has been touched several times.	<p>Energy management: the door was opened or closed shortly before the  sensor control was touched. As a result, the dishwasher was already switched on. The electronic module requires a few seconds to be ready for operation.</p> <ul style="list-style-type: none">■ Wait a few seconds after opening or closing the door.■ Then touch the  sensor control.

Troubleshooting

Fault messages



Problem	Cause and remedy
The optical in-operation indicator light is flashing quickly. The alarm tone is sounding. One of the following faults appears in the display:	Before rectifying the problem: ■ Switch the dishwasher off.
 Fault FXX	There may be a technical fault. ■ Switch the dishwasher back on after a few seconds. ■ Restart the desired programme. If the fault message appears again, there is a technical fault. ■ Switch the dishwasher off. ■ Close the stopcock. ■ Call the Miele Customer Service Department.
 Waterproof	The Waterproof system has reacted. ■ Switch the dishwasher off. ■ Close the stopcock. ■ Call the Miele Customer Service Department.
 Fault F78	Circulation pump fault. ■ Switch the dishwasher off. ■ Switch the dishwasher back on. ■ Restart the desired programme. If the fault message appears again, there is a technical fault. ■ Switch the dishwasher off. ■ Close the stopcock. ■ Call the Miele Customer Service Department.

Door release

Problem	Cause and remedy
<p>The optical in-operation indicator light is flashing quickly. The alarm tone is sounding. The following fault is indicated via the display:</p>	<p>Before rectifying the problem:</p> <ul style="list-style-type: none"> ■ Switch the dishwasher off.
<p> F33</p>	<p>The door does not open automatically. There may be a technical fault.</p> <ul style="list-style-type: none"> ■ Open the door manually (see the “Opening the door” section in the “Before using for the first time” chapter) and switch the dishwasher back on again. ■ If the same fault message appears again, call the Miele Customer Service Department.
	<p>The door does not close automatically. The door might be obstructed by an item inside the dishwasher.</p> <ul style="list-style-type: none"> ■ If this is the case, remove the item causing an obstruction and switch the dishwasher on again. ■ If the same fault message appears again, call the Miele Customer Service Department.

Troubleshooting

Water inlet fault

Problem	Cause and remedy
The optical in-operation indicator light is flashing quickly. The alarm tone is sounding. One of the following messages appears in the display:	
 Open stopcock	The stopcock is closed. ■ Open the stopcock fully.
 Water intake	Before rectifying the problem: ■ Switch the dishwasher off. The water inlet is restricted. ■ Open the stopcock fully and start the programme again. ■ Clean the filter in the water inlet (see the “Cleaning the filter in the water inlet” section in the “Cleaning and care” chapter). ■ The water-connection pressure is lower than 50 kPa. Seek professional advice. ■ The on-site connection for the water drainage may be too low and you will need to raise the water drainage (see the “Hose installation” section in the “Installation” chapter).
 Fault F18	A technical fault has occurred. ■ Switch the dishwasher off. ■ Close the stopcock. ■ Call the Miele Customer Service Department.

Water drainage fault

Problem	Cause and remedy
<p>The in-operation indicator light is flashing quickly.</p> <p>The alarm tone is sounding.</p> <p>The message  Drain appears in the display.</p>	<p>Before rectifying the problem:</p> <ul style="list-style-type: none"> ■ Switch the dishwasher off.
	<p>Water drainage fault.</p> <p>There might be water in the wash cabinet.</p> <ul style="list-style-type: none"> ■ Clean the filter combination (see the “Cleaning the filters” section in the “Cleaning and care” chapter). ■ Clean the drain pump (see the “Cleaning the drain pump” section in the “Cleaning and care” chapter). ■ Remove any kinks or loops in the drain hose.

General problems with the dishwasher

Problem	Cause and remedy
<p>The indicator lights and the display are dark.</p>	<p>The dishwasher has switched off automatically to save energy.</p> <ul style="list-style-type: none"> ■ Switch the dishwasher back on using the  sensor control.
<p>The wash cabinet lighting does not come on when the door is opened.</p>	<p>The wash cabinet lighting has been switched off permanently.</p> <ul style="list-style-type: none"> ■ Switch the lighting back on again (see “Settings” chapter, “BrilliantLight” section).
	<p>Faulty wash cabinet lighting.</p> <ul style="list-style-type: none"> ■ Call Miele Service.
<p>Detergent residue is left in the detergent compartment at the end of a programme.</p>	<p>The detergent compartment was still damp when detergent was added.</p> <ul style="list-style-type: none"> ■ Only add the detergent when the detergent compartment is dry.
<p>The detergent compartment lid cannot be closed.</p>	<p>Residual detergent is blocking the catch.</p> <ul style="list-style-type: none"> ■ Remove the residual detergent.
<p>At the end of a programme there is a film of moisture on the inside of the door and possibly on the interior cabinet walls.</p>	<p>This is part of the normal function of the drying system. The moisture will dissipate after a short while.</p>

Troubleshooting

Problem	Cause and remedy
Water remains in the wash cabinet at the end of a programme.	Before rectifying the problem: ■ Switch the dishwasher off.
	The filter combination in the wash cabinet is clogged. ■ Clean the filter combination (see “Cleaning and care” chapter, “Cleaning the filters” section).
	The drain pump is blocked. ■ Clean the drain pump (see “Cleaning and care” chapter, “Cleaning the drain pump” section).
	The drain hose is kinked. ■ Remove any kinks from the drain hose.

Noises

Problem	Cause and remedy
Knocking noise in the wash cabinet	A spray arm is knocking against a wash item. ■ Carefully open the door and rearrange the wash items that are obstructing the spray arm.
Rattling noise in the wash cabinet	Wash items are insecure in the wash cabinet. ■ Carefully open the door and rearrange the wash items so that they sit securely.
	There is a foreign object (e.g. glass shard) in the drain pump. ■ Remove the foreign object from the drain pump (see “Cleaning and care” chapter, “Cleaning the drain pump” section).
Knocking noise in the water pipes	This may be caused by the on-site installation or the cross-section of the piping. ■ However, this will not affect the functioning of the dishwasher in any way. If in doubt, contact a suitably qualified plumber.

Unsatisfactory washing result

Problem	Cause and remedy
<p>The wash items are not clean.</p>	<p>The wash items were not loaded correctly. ■ See notes in the “Loading the dishwasher” chapter.</p>
	<p>The programme was not powerful enough. ■ Select a more powerful programme (see “Programme overview” chapter).</p>
	<p>Not enough detergent was dispensed during manual detergent dispensing. ■ Use more detergent or change the detergent you are using.</p>
	<p>Items are blocking the path of the spray arms. ■ Carry out a rotation check and if needed rearrange the items so that the spray arms can rotate freely.</p>
	<p>The filter combination in the wash cabinet is not clean or was incorrectly fitted. This may have caused the spray arm jets to become blocked. ■ Clean and/or fit the filter combination correctly. ■ Clean the spray arm jets if necessary (see “Cleaning and care” chapter, “Cleaning the spray arms” section).</p>
<p>There are smears on glassware and cutlery. There is a bluish sheen on the surface of glassware. The film can be wiped off.</p>	<p>The rinse aid dosage is set too high. ■ Reduce the dosage (see “Settings” chapter, “Rinse aid” section).</p>

Troubleshooting

Problem	Cause and remedy
<p>The crockery is not dry or cutlery and glasses are flecked.</p>	<p>The rinse aid dosage is set too low or the rinse aid reservoir is empty.</p> <ul style="list-style-type: none"> ■ Replenish the rinse aid, increase the dosage, or change the brand of rinse aid (see “Using for the first time - Rinse aid”).
	<p>The crockery was taken out of the wash cabinet too soon.</p> <ul style="list-style-type: none"> ■ Leave the crockery in longer (see the “Unloading the dishwasher” section in the “Operation” chapter).
	<p>You have used combination products that have insufficient drying performance.</p> <ul style="list-style-type: none"> ■ Switch to another detergent or add rinse aid (see “Using for the first time - Rinse aid”).
<p>Glassware has a brown or blue tinge. The film cannot be wiped off.</p>	<p>Ingredients from the detergent have formed a deposit.</p> <ul style="list-style-type: none"> ■ Switch to another detergent straight away.
<p>Glassware is dull and discoloured. The film cannot be wiped off.</p>	<p>The glassware is not dishwasher-proof. The surface has altered.</p> <ul style="list-style-type: none"> ■ No remedy. Purchase glassware that is dishwasher-proof.
<p>Tea or lipstick stains have not been completely removed.</p>	<p>The wash temperature of the selected programme was too low.</p> <ul style="list-style-type: none"> ■ Select a programme with a higher main wash temperature.
	<p>The bleaching effect of the detergent used is too low.</p> <ul style="list-style-type: none"> ■ Switch to another detergent.
<p>Plastic items are discoloured.</p>	<p>Natural dyes, e.g. from carrots, tomatoes or ketchup, may be the cause. The amount of detergent used or its bleaching effect was not sufficient to deal with natural dyes.</p> <ul style="list-style-type: none"> ■ Use more detergent (see “Detergent”). Parts that are already discoloured will not revert to their original colour.

Problem	Cause and remedy
<p>White residue is visible on the crockery. Clouding has occurred on glassware and cutlery. The film can be wiped off.</p>	<p>The rinse aid dosage is set too low.</p> <ul style="list-style-type: none"> ■ Increase the dosage (see “Settings” chapter, “Rinse aid” section).
	<p>There is no salt in the salt reservoir.</p> <ul style="list-style-type: none"> ■ Fill the salt reservoir (see “Before using for the first time”, “Dishwasher salt” section).
	<p>The salt reservoir cap has not been screwed on correctly.</p> <ul style="list-style-type: none"> ■ Replace it, making sure that it screws back on correctly.
	<p>Unsuitable combination detergents were used.</p> <ul style="list-style-type: none"> ■ Switch to another detergent. If using tabs or powder detergent, do not choose combination products and ensure you refill the dishwasher salt and rinse aid.
	<p>The water softener is programmed to too low a water hardness level.</p> <ul style="list-style-type: none"> ■ Programme the water softener to a higher water hardness level (see “Settings” chapter, “Water hardness” section).
<p>There are rust stains on cutlery.</p>	<p>The affected items are not corrosion-resistant.</p> <ul style="list-style-type: none"> ■ No remedy. Purchase cutlery that is dishwasher-safe.
	<p>A programme was not run after dishwasher salt was added. Traces of salt have got into the normal wash cycle.</p> <ul style="list-style-type: none"> ■ Always run the  <i>Cold pre-wash</i> programme without any load items in the dishwasher immediately after refilling salt.
	<p>The salt reservoir cap has not been screwed on correctly.</p> <ul style="list-style-type: none"> ■ Replace the cap, making sure that it screws back on correctly.

Customer service

Contact in the event of a fault

In the event of any faults which you cannot remedy yourself, please contact your Miele dealer or the Miele Customer Service Department.

You can book a Miele Customer Service Department call-out online at www.miele.com/service. Contact information for the Miele Customer Service Department can be found at the end of this document.

Please quote the model and serial number of your dishwasher when contacting Miele. These can be found on the data plate on the right side of the open door.

The data plate is located on the right side of the door.

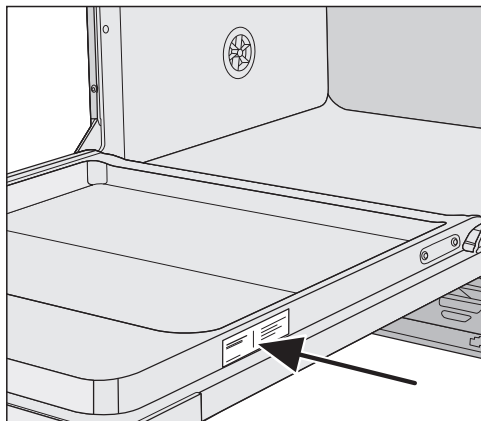

Warranty

The warranty period for this appliance is 1 year from date of purchase.

For further information, please refer to the warranty conditions in the booklet provided.

Electrical connection

 All work on the electrical connection must be carried out by the Miele Customer Service Department, an authorised Miele dealer or a qualified electrician.

- The electrical installation must be in compliance with current local and national safety regulations (DIN VDE 0100 in Germany).
- The connection to the power supply must comply with national regulations (plug and socket must be accessible after the appliance has been installed). An electrical safety test can then easily be carried out, e.g. after any service or maintenance work.
- It is recommended that the electrical connection is made with a suitably rated plug and socket.
- If the dishwasher is hard wired to the power supply, connection should be made via a mains switch with all-pole isolation. The mains switch must ensure a gap of at least 3 mm between all open contacts and must be able to be locked in the off position.
- Equipotential bonding should be carried out if required.
- If replacing the mains cable, use only original Miele spare parts or a suitable cable with **core cable ends**.
- For technical data, see the data plate or wiring diagram supplied.

The dishwasher must only be operated with the voltage, frequency and fuse rating shown on the **data plate**.

This appliance **can be converted to a different type of power supply** in accordance with the conversion diagram and wiring diagram supplied.

Converting the appliance to a different type of power supply can lead to longer programme running times, resulting in increased energy consumption.

The declared consumption values will only be achieved if the appliance remains in the state in which it was delivered.

The **data plates** (with VDE test certificate, etc.) are located at the back of the dishwasher and on the inner panel of the door.

The **wiring diagram** is supplied with the dishwasher.

The **conversion diagram** is attached to the electrical connection plinth panel.

Equipotential bonding connection

There is a screw connection point marked \downarrow at the back of the appliance, to which additional equipotential bonding can be connected.

Installation

The Miele Waterproof system

As long as your dishwasher has been installed correctly, the Miele Waterproof system will provide extensive protection against water damage throughout its service life.

Water inlet

 Water in the dishwasher must not be used as drinking water.

- The dishwasher must be connected to the water supply in strict accordance with current local and national water authority regulations.
- The water used must comply with European regulations for drinking water quality as a minimum. If the water supply has a high iron content, there is a danger of corrosion occurring on items being cleaned in the dishwasher, as well as the appliance itself. If the chloride content of the water exceeds 100 mg/l, the risk of corrosion to items being cleaned in the dishwasher will be further increased.
- In certain regions (e.g. mountainous regions), the water composition may cause precipitates to form, requiring the use of softened water for the dishwasher.
- The dishwasher complies with all valid European standards on the protection of drinking water.
- The water connection pressure (flow pressure at the water connection) must be between 100 and 1000 kPa (1.0 and 10 bar). If the water pressure is lower than this, the fault message *Water intake* will appear in the display (see “Troubleshooting”). If the water pressure is too high, a pressure reducing valve must be fitted.
- A stopcock valve with a $\frac{3}{4}$ inch threaded union must be provided on site. The valve should be easily accessible, since the water inlet should be shut off whenever the appliance is not in use.
- The DN 10 inlet hose is approx. 1.5 m long terminating in a $\frac{3}{4}$ inch screw thread. A 1.5 m long flexible metal extension hose tested to 140 bar (14,000 kPa) is available as an optional accessory if required. The inlet filter or the flow regulator in the screw thread must not be removed under any circumstances.

 Risk of damage from leaking water.

The connection point is subject to mains water pressure. Water leaking from it can cause damage.

You should therefore open the stopcock slowly and check for leaks. Correct the position of the seal and screw thread if appropriate. Check the screw connections regularly to make sure they are still tight.

 Risk of damage due to excessive pressure.

A brief increase in the water connection pressure can damage components of the dishwasher.

This dishwasher must only be operated when it is connected to a fully vented plumbing system.

Regulations in the UK

To comply with the water regulations requirements, this dishwasher must be connected to the mains potable water supply via the double check valve supplied with the machine.

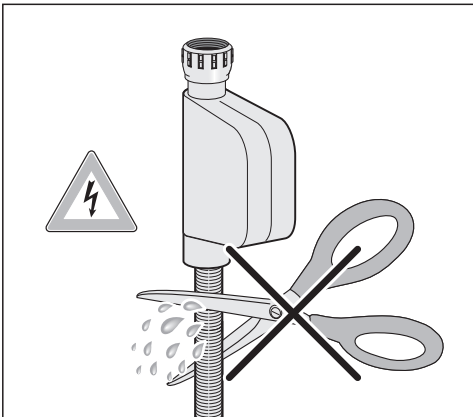

 Risk of electric shock from mains voltage.

There are live electrical components in the water inlet hose.

The water inlet hose must not be shortened or damaged in any way (see illustration).

Installation

Connecting the drainage system

- The appliance drainage system is fitted with a non-return valve, which prevents dirty water from flowing back into the dishwasher via the drain hose.
- The dishwasher drain hose should be connected to a separate on-site drain for the dishwasher only. If no separate drain is available, we recommend connecting it to a dual-chamber siphon.
- The dishwasher is supplied with approx. 1.5 m of flexible drain hose with an internal diameter of 22 mm. Hose clips are supplied with the dishwasher.
- The drain hose must not be shortened! The hose can be extended using a connection piece to attach a further length of hose. The drainage length must not be longer than 4 m and the delivery head no higher than 1 m.
- The drainage system must be able to accommodate a minimum drainage flow of 16 l/min.

 Make sure that there are no kinks in the hose, and that it is not squashed or stretched.

Hose installation when water drainage is low

If the on-site water drainage connection is situated lower than the guide path for the lower basket rollers in the door, the water drain hose must be installed at that level with a bend in it. Otherwise, water may flow out of the wash cabinet during a programme.

Tall unit installation

APFD 101 and APFD 102 are available as optional accessories for use when installing the dishwasher in a tall unit.

Technical data

Model	XXL
Dishwasher	PFD 104 SCVi
Height of freestanding appliance	-
Height of built-in appliance	845 mm (adjustable + 65 mm)
Height of building-in niche	From 845 mm (adjustable + 65 mm)
Width	598 mm
Width of building-in niche	600 mm
Depth of freestanding appliance	-
Depth of built-in appliance	570 mm
Weight	Max. 51 kg
Voltage	
Rated load	See data plate
Fuse rating	
Power rating in off mode	0.4 W
Power rating when not switched off	5.0 W
Network standby	0.9 W
Frequency range	2.4000–2.4835 GHz
Maximum transmission power	< 100 mW
Water connection pressure	100-1000 kPa
Cold or hot water connection	Up to max. 60 °C
Mains water hardness	Max. 36 °d
Delivery head	Max. 1.0 m
Drainage length	Max. 4.0 m
Ambient temperature	5 °C to 40 °C
Relative humidity	
Maximum	80 % for temperatures up to 31 °C
Linear decreasing to	50 % for temperatures up to 40 °C
Mains connection cable	Approx. 1.7 m
Capacity	14 standard place settings
Noise emission values	
Sound power LwA	45 dB (A)
Sound pressure LpA	32.5 dB (A)
Test certifications awarded	EMC, VDE, radio and television suppressed
CE mark	Machinery Directive 2006/42/EC
UKCA mark (UK only)	The Supply of Machinery (Safety) Regulations 2008
Manufacturer's address	Miele & Cie. KG, Carl-Miele-Straße 29, 33332 Gütersloh, Germany

Technical data

This **Statement of Compliance** confirms this Miele product fully complies with the **Product Security and Telecommunications Infrastructure (Security Requirements for Relevant Connectable Products) Regulations 2023**.

- 1) Professional Appliance – *PFD 100, PFD 101, PFD 103, PFD 104 (GG11)*
- 2) Manufactured by: Miele & Cie KG,
Carl Miele Street 29, 33332 Gutersloh Germany
Imported by and contact point: Miele Company Ltd, Fairacres, Marcham Road,
Abingdon, Oxon, OX14 1TW Great Britain
- 3) The defined support period at the time of first supply is 10 years
- 4) To report vulnerabilities and cybersecurity issues please contact: psirt@miele.com

- 5) Signature 
Name: **Paul Wright**
Company Position: **Head of Technical Management**
Date of signature: **19th March 2024**
Place of signature: **Abingdon, Oxfordshire**



You can alter the dishwasher's controls to suit changing requirements by adjusting the settings.

The settings can be altered at any time.

The flag after the word **Language**  serves as a guide if a language that you do not understand has been set.

In this case keep selecting the menu option that has a flag after it until you reach the **Language**  sub-menu.

Opening the Settings menu

- Switch the dishwasher on with the  sensor control if it is switched off.
- Touch the Settings  sensor control.

The first option in the Settings menu will appear in the display.

For further information about the display functionality, see the "Display functions" section in the "Guide to the appliance" chapter.

Changing settings

- Use the \vee/\wedge sensor controls to select the menu option you want to change and confirm your selection with *OK*.

Sub-menu options that have already been selected will have a tick  beside them.

- Select the setting you want using the \vee/\wedge sensor controls and confirm with *OK*.
- To exit a sub-menu again use the  Back sensor control.

The display will revert to the menu above.

Language

The display can be set to appear in one of several different languages.

You can change the language used in the display and also the country via the **Language**  sub-menu.

Time of day

The current time of day must be set before you can use the timer option.

Setting the clock format

You can select either a 24-hour or 12-hour clock.

- Select the **Clock format** menu option.
- Select the setting you want and confirm with *OK*.

Setting the time of day

You can set the time of day.

- Select the **Set** menu option.
- Use the \vee/\wedge sensor controls to enter the hour and confirm your entry by touching *OK*.
Then set the minutes and confirm with *OK*.

The time of day has now been saved.

Water hardness

Your dishwasher is fitted with a water softener.

- You should programme the dishwasher to the correct water hardness for your area.
- Your local water authority will be able to advise you on the water hardness level in your area.
- Where the water hardness fluctuates, e.g. between 1.8 and 2.7 mmol/l (10–15 °dH – German scale), always programme the dishwasher to the higher value (2.7 mmol/l or 15 °dH in this example).

If the water hardness in your area is available in a unit other than °dH, you can convert the values as follows:
 $1\text{ °dH} = 0.18\text{ mmol/l} = 1.78\text{ °fH}$

°d	mmol/l	°f	Display
1	0.2	2	1
2	0.4	4	2
3	0.5	5	3
4	0.7	7	4
5	0.9	9	5
6	1.1	11	6
7	1.3	13	7
8	1.4	14	8
9	1.6	16	9
10	1.8	18	10
11	2.0	20	11
12	2.2	22	12
13	2.3	23	13
14	2.5	25	14
15	2.7	27	15
16	2.9	29	16
17	3.1	31	17
18	3.2	32	18
19	3.4	34	19
20	3.6	36	20
21	3.8	38	21
22	4.0	40	22
23	4.1	41	23
24	4.3	43	24
25	4.5	45	25
26	4.7	47	26
27	4.9	49	27
28	5.0	50	28
29	5.2	52	29
30	5.4	54	30
31	5.6	56	31
32	5.8	58	32
33	5.9	59	33
34	6.1	61	34
35	6.3	63	35
36	6.5	65	36

Rinse aid

You can adjust the rinse aid dosage for best results.

The rinse aid dosage can be set from 0 to 6 ml.

3 ml is the factory default setting.

The rinse aid amount dispensed can turn out to be higher than the set value due to an automatic adjustment of the programme.

If spots appear on crockery and glassware:

- Increase the rinse aid dosage.

If clouding or smearing appears on crockery and glassware:

- Decrease the rinse aid dosage.

Temperature unit

The temperature can be shown in the display in degrees Celsius or degrees Fahrenheit.

- Select the setting you want and confirm with *OK*.

Final rinse temperature

For better drying, the final rinse temperature can be increased for individual programmes. This function is not available for all programmes (see “Programme chart”).

- Select the setting you want and confirm with *OK*.

Miele@home

Your dishwasher is equipped with an integrated WiFi module.

You can connect your dishwasher to your local network in order to use digital solutions from Miele. An overview of these digital solutions is available on the webpage: <https://www.miele.de/p/digitale-loesungen-4345.htm>.

Connecting your dishwasher to your local network will increase energy consumption, even when the dishwasher is switched off.

The “Settings” and “Miele@home settings” menus will be added as additional menu options.

Make sure that your WiFi network signal strength is strong enough at the installation site of your dishwasher.

There are a number of ways of connecting your dishwasher to your WiFi network:

Setting up Miele@home

You can connect your dishwasher to your network using WPS or via the app.

Connect using WPS

You can connect your dishwasher to your WiFi network using WPS (Wi-Fi Protected Setup).

Your WiFi router must support WPS.

- Confirm the message *Press WPS button with OK*.
- Activate the WPS function on your router within 2 minutes.
- Once the connection has been established, confirm the message with *OK*.

If the connection fails, you have probably not activated WPS on your router quickly enough. Repeat the steps above.

Connect using App

You can connect the dishwasher to the Miele app.

The apps are available to download free of charge from the Apple App Store® or from the Google Play Store™.

Miele app



- Select the **Connect using App** menu option and confirm with **OK**.
- Follow the user navigation in the app.

Once your dishwasher is connected to your WiFi network, you can use the app to carry out the following tasks:

- Call up information on the operating status of your dishwasher
- Call up information on the programme sequence of your dishwasher
- Set up a Miele@home network with other WiFi-enabled Miele domestic appliances

Deactivate

If you do not wish to use the WiFi module of your dishwasher, you can switch it off.

- Select the **Deactivate** menu option and confirm with **OK**.

In the Miele@home menu, the menu option **Activate** will now be displayed instead of **Deactivate**.

Activate

If you wish to connect your dishwasher to your WiFi network, you can turn on the WiFi module.

- Select the **Activate** menu option and confirm with **OK**.

In the Miele@home menu, the menu option **Deactivate** will now be displayed instead of **Activate**.

Displaying Connection status

You can call up the current connection status of your dishwasher.

- Select the **Connection status** menu option and confirm with **OK**.
- Use the ∇/\wedge sensor controls to consecutively call up the WiFi signal strength, the name of your router and the associated IP address.
- Select **OK** to confirm the messages.

Set up again

This menu option only appears if you have already connected your dishwasher to your WiFi network.

Connect using App

- Select the **Connect using App** menu option and confirm with **OK**.
- Follow the user navigation in the app.

Connect using WPS

- Select the **Connect using WPS** menu option and confirm with **OK**.
- Follow the instructions in the display.

Network configuration

You can use this menu option to reset all WiFi module settings (if available) to the factory default settings.

The network configuration should be reset whenever a dishwasher is being disposed of or sold, or if a used dishwasher is being put into operation. This is the only way to ensure that all

personal data has been removed and the previous owner will no longer be able to access the dishwasher.

Remote control

This menu option will only be displayed if you have connected your dishwasher to your WiFi network (see “Settings – Miele@home”).

If you wish to permanently switch off the Remote control option, you can do so under this menu option. The  sensor control will then no longer be available to select until you change this setting again.

Even if the Remote control option is switched off, you can use the Miele app to call up information about your appliance. However, you cannot start any programmes or change any settings from it.

RemoteUpdate

The RemoteUpdate menu option is only displayed and can only be selected if the requirements for using Miele@home have been met (see “Before using for the first time” chapter, “Miele@home” section).

The RemoteUpdate function is used for updating the software in your dishwasher. If an update is available for your dishwasher, it will automatically download it. Updates will not be installed automatically. They must be initiated manually.

If you do not install an update, you can continue to use your dishwasher as usual. However, Miele recommends installing updates.

Activating/deactivating

The RemoteUpdate function is activated as standard. Available updates will be downloaded automatically and will only be installed if you initiate them.

Deactivate RemoteUpdate if you do not wish any updates to be downloaded automatically.

Running a RemoteUpdate

Information about the content and scope of a RemoteUpdate will be provided in the Miele app.

A message will appear in your dishwasher display if a software update is available.

You can install the update immediately or postpone this until later. When the appliance is switched on again, you will be reminded about the update.

Deactivate RemoteUpdate if you do not want to install the update.

The update may take several minutes.

Please note the following information about the RemoteUpdate function:

- You will only receive a message when an update is available.
- Once an update has been installed, it cannot be undone.
- Do not switch the dishwasher off during the update. Otherwise, the update will be aborted and will not be installed.
- Some software updates can only be carried out by the Miele Customer Service Department.

SmartStart

This menu option will only be displayed if you have connected your dishwasher to your WiFi network (see the “Miele@home” section in the “Settings” chapter)

The SmartStart function is used for starting your dishwasher automatically at a time when your energy costs are most economical.

To use this function you may need further technical accessories.

If you have activated SmartStart Permitted, the Timer  menu of the selected programme will no longer show EcoStart but will instead show SmartStart. The dishwasher will then start within the timeframe specified when it receives a signal from the energy supplier.

If it has not received a signal from the energy supplier by the latest possible start time, the dishwasher will start automatically.

EcoStart

In order to run your dishwasher in the most economical way, you can use the EcoStart option to take advantage of your electricity supplier’s cheaper energy tariffs (see the “Timer” section in the “Options” chapter).

With this option selected, your dishwasher will start automatically at your electricity supplier’s cheapest tariff times.

To use this option you must first set up to three electricity tariff times in which the dishwasher can start. You can allocate different priorities to these time zones. The time with the cheapest electricity tariff will be given Priority 1.

Contact your electricity supplier to find out the times of the cheapest energy tariffs.

Once the energy tariff times have been set, you can use the EcoStart option to set the latest finish time required for each programme.

The dishwasher will then start automatically during the cheapest energy tariff time. The programme will end at the set finish time at the latest.

Setting the energy tariff times

Before you can use the EcoStart option, you must set at least one energy tariff time.

- Use the \vee/\wedge sensor controls to select an energy tariff time T1–T3 and confirm with *OK*.

The start of the energy tariff time selected will appear in the display and the hour number block will be highlighted.

- Use the \vee/\wedge sensor controls to set the hours and minutes for the start time and confirm both with *OK*.

The end of the energy tariff time selected will appear in the display and the hour number block will be highlighted.

- Use the \vee/\wedge sensor controls to set the hours and minutes for the end time and confirm both with *OK*.

The energy tariff time will be saved and its priority will appear in the display.

- Use the \vee/\wedge sensor controls to set the priority you want and confirm with *OK*.
- Confirm the message with *OK*.

The energy tariff time will be activated.

Changing the electricity tariff times

You can change the start, end or priority of an electricity tariff time.

- Use the \vee/\wedge sensor controls to select an electricity tariff time T1–T3 that you wish to change and confirm with *OK*.
- Select the setting you want to change and confirm with *OK*.
- Use the \vee/\wedge sensor controls to change the setting and confirm with *OK*.

- Confirm the message with *OK*.

The change will be saved.

Deleting the energy tariff times

You can delete the settings for an energy tariff time and in doing so deactivate the EcoStart option for this time zone.

- Use the \vee/\wedge sensor controls to select an electricity tariff time T1–T3 that you wish to delete and confirm with *OK*.
- For example, select *Delete T1* and confirm with *OK*.
- For example, select *Delete T1?* and confirm with *OK*.

The settings for the energy tariff time selected will be reset.

- Confirm the message with *OK*.

The energy tariff time will be deleted.

Consumption (EcoFeedback)

You can set whether the water consumption is displayed for the selected programme. This function shows the estimated consumption before a programme sequence and the actual consumption after the end of the programme.

In this menu you can also call up the total consumption of water for all the wash programmes you have previously run on your dishwasher (see the “EcoFeedback consumption display” section in the “Caring for the environment” chapter).

Displaying Consumption

- Select the **Consumption display** menu option and confirm with *OK*.
- Select the setting you want and confirm with *OK*.

Displaying Total consumption

- Select the **Total consumption** menu option and confirm with *OK*.
- You can display the total consumption via the **Water** menu option.

You can reset the value for the total consumption to 0.

- Select the **Reset** menu option and confirm with *OK*.
- Select the **Yes** menu option and confirm with *OK*.
- Confirm the message with *OK*.

The values are now reset to 0.

Display brightness

You can set the display brightness to one of seven different levels.

Volume

A buzzer sequence will sound at the end of a programme or if there is a fault as long as the buzzers are activated.

Buzzers in the event of a fault

In the event of a fault, the alarm tone will sound four times at intervals with a short pause between each set of tones.

The alarm tone that sounds when there is a fault cannot be deactivated.

Buzzers

The buzzer at the end of a programme will sound four times at intervals with a short pause between each set of tones.

The volume of the buzzer at the end of the programme can be selected from one of seven levels. If no volume is selected, the buzzer is switched off.

Keypad tone

An audible tone sounds each time a sensor control is pressed.

The volume for the keypad tone can be set to one of seven different levels. If no volume is selected, the keypad tone is switched off (except the **On/Off** sensor control).

Welcome melody

If you switch the dishwasher on or off, a brief melody will sound.

You can switch this melody off.

Refill reminders

If you only ever use combination detergents or automatic dispensing using Miele PowerDisks (if available), you can switch off the refill reminders for dishwasher salt and rinse aid if you wish.

Please make sure that if you stop using combination detergents, you refill the dishwasher salt and rinse aid. Switch the refill reminders back on.

BrilliantLight

This dishwasher is equipped with wash cabinet interior lighting.

When the door is open, the lighting switches off automatically after 15 minutes.

You can also switch off the wash cabinet interior lighting permanently.

Software version

You can display the software version of your dishwasher electronics for technical support purposes.

Showroom

For demonstration purposes only.

The dishwasher is equipped with a demo mode for showroom use.

Factory default

You can reset all the appliance settings to the factory default settings.

WiFi module settings (where applicable) have to be reset separately (see the “Miele@home” section in the “Settings” chapter).

Appliance settings

You can use this menu option to reset all dishwasher settings, except WiFi module settings, to the factory default settings.



Miele

International Service Contacts

America: +1 866 694 5849

Australia, Asia, Oceania: +61 3 9764 7880

Europe, Africa, Middle East: +49 5241 89 66 877

E-mail: service@miele-marine.com

www.miele.com/marine-service

Manufacturer: Miele & Cie. KG, Carl-Miele-Straße 29, 33332 Gütersloh, Germany