















Operating instructions Freezer



To avoid the risk of accidents or damage to the appliance it is **essential** to read these instructions before it is installed and used for the first time.

Contents

Warning and Safety instructions	5
Caring for the environment	14
Installation	15
Installation site	15
Climate range	16
Ventilation.....	17
Side-by-side combinations	17
Installation	18
Knock sensor	18
Spacer plates.....	18
Aligning the refrigeration appliance.....	19
Levelling rails	19
Connecting to the power supply	19
Cover strip	20
Furniture door panel.....	20
Weight of the furniture door.....	20
Building-in dimensions	21
Installation in a tall unit/side view	21
Connections and ventilation	22
Mains water connection.....	23
Information about the mains water connection.....	23
Water supply	24
Electrical connection	26
Saving energy	27
Guide to the appliance	28
Start display	30
Using the appliance	30
Settings mode 	31
Automatic door opening (ActiveDoor)	33
... via knocking signal	33
... via voice commands.....	34
Adjusting the interior fittings	34
Ice&PizzaBox	34
Tilting the top drawer	35
Creating a flexible design for the freezer zone(VarioRoom)	35
Accessories supplied	35
Optional accessories	35
Switching on and off	36
Before using for the first time	36
Connecting the refrigeration appliance	36
Switching the refrigeration appliance on	36

Switching off the refrigeration appliance	36
To note when switching off for longer periods of time	36
The correct temperature	38
Temperature display	38
Setting the temperature	38
Possible temperature settings	38
Using Super freeze	39
Selecting further settings	40
Explanation of the different settings	40
Party mode 	40
Switching the lock function  /  on	40
Sabbath mode 	40
Automatic door opening (ActiveDoor) 	42
Change the time until the door alarm is triggered  when the door is opened manually	45
Miele@home	45
Changing the volume of the alarms and buzzers  / 	46
Adjusting the display brightness 	47
Switching off Demo mode 	47
Resetting the settings to their default settings 	47
Information 	47
Temperature and door alarm	48
Freezing and storing food	50
Freezing fresh food	50
Maximum freezing capacity	50
Storing frozen food	50
Home freezing	50
Cooling drinks quickly	51
Making ice cubes	52
Switching the ice cube maker  on and off	53
Cleaning and care	54
Defrosting	54
Cleaning agents	54
Preparing the refrigeration appliance for cleaning	54
Cleaning the inside of the appliance	55
Cleaning accessories by hand or in the dishwasher	55
Removing and dismantling accessories for cleaning	55
Cleaning the door seal	59
Cleaning the ventilation gaps	60
After cleaning	60

Contents

Troubleshooting	61
Service	70
Contact in the event of a fault	70
EPREL database	70
Warranty	70
Information	71
EU Conformity declaration.....	71
UK Conformity declaration	71
Copyrights and licences	72

Warning and Safety instructions

This refrigeration appliance complies with current safety requirements. Inappropriate use can, however, lead to personal injury and material damage.

Please read the operating and installation instructions carefully before using the refrigeration appliance for the first time. They contain important information on safety, installation, use and maintenance. This is to protect yourself from injury, and from damaging your refrigeration appliance.

In accordance with standard IEC 60335-1, Miele expressly and strongly advises that you read and follow all information provided on installing the refrigeration appliance, as well as the safety notes and warnings.

Miele cannot be held liable for injury or damage caused by non-compliance with these instructions.

Keep these operating and installation instructions in a safe place and pass them on to any future owner.

Warning and Safety instructions

Correct application

▶ This refrigeration appliance is intended for use in the home and in similar environments, for example

- in shops, offices and similar work settings
- by the guests in hotels, motels, bed & breakfasts and other typical home settings.

This refrigeration appliance is not intended for outdoor use.

▶ It must only be used as a domestic appliance to store deep frozen food, freeze fresh food and to make ice.

Any other usage is not supported by the manufacturer and could be dangerous.

▶ This refrigeration appliance is not suitable for storing and keeping cool medicines, blood plasma, laboratory preparations or similar substances or products that are subject to the Medical Device Directive. Incorrect use of the refrigeration appliance for such purposes may cause deterioration of the items stored. The refrigeration appliance is also not suitable for use in areas where there is a risk of explosion.

Miele cannot be held liable for damage caused by improper or incorrect use or operation of the appliance.

▶ The appliance can only be used by people with reduced physical, sensory or mental capabilities, or lack of experience and knowledge, if they are supervised whilst using it, or have been shown how to use it in a safe way and recognise and understand the consequences of incorrect operation.

Safety with children

▶ Children under 8 years of age must be kept away from the refrigeration appliance unless they are constantly supervised.

▶ Children 8 years and older may only use the appliance unsupervised if they have been shown how to use it in a safe way and recognise and understand the consequences of incorrect operation.

▶ Children must not be allowed to clean or maintain the appliance unsupervised.

▶ Please supervise children in the vicinity of the appliance and do not let them play with it.

▶ Danger of suffocation! Whilst playing, children could become entangled in packaging (such as plastic wrapping) or pull it over their head and suffocate. Keep packaging material away from children.

Technical safety

► The coolant circuit has been checked for leaks. The refrigeration appliance complies with statutory safety requirements and the appropriate EU directives.



If the cooling circuit is damaged, refrigerant and oil can escape and ignite.

► **Warning: fire hazard/flammable materials.** This symbol is on the compressor and indicates flammable materials. Do not remove this sticker.

The refrigerant inside the appliance (details on the data plate) is environmentally friendly but flammable.

The use of this refrigerant does, however, sometimes lead to a slight increase in the noise level of the appliance. In addition to the noise of the compressor, you might be able to hear the refrigerant flowing around the cooling circuit. Unfortunately, this cannot be avoided, but it does not affect the performance of the refrigeration appliance.

When transporting and installing the refrigeration appliance, ensure that no parts of the cooling circuit are damaged. Splashes of refrigerant can damage the eyes and leaking refrigerant can ignite.

In the event of damage:

- Avoid naked flames or anything which creates a spark.
- Disconnect the refrigeration appliance from the mains electricity supply.
- Ventilate the room where the refrigeration appliance is located for several minutes.
- Contact the Miele Customer Service Department.

► The more refrigerant there is in a refrigeration appliance, the larger the room it should be installed in. In the event of a leakage, if the appliance is in a small room, there is the danger of a combustible gas/air mixture building up. For every 8 g of refrigerant at least 1 m³ of room space is required. The amount of refrigerant in the refrigeration appliance is stated on the data plate inside the appliance.

Warning and Safety instructions

▶ To avoid the risk of damage to the appliance, make sure that the connection data (fuse rating, frequency and voltage) on the data plate corresponds to the household supply.

Check that this is the case before connecting the appliance. Consult a qualified electrician if in any doubt.

▶ The electrical safety of this appliance can only be guaranteed when correctly earthed. It is essential that this standard safety requirement is met. If in any doubt please have the electrical installation tested by a qualified electrician.

▶ Temporary or permanent operation on an autonomous power supply system or a power supply system that is not synchronised with the mains power supply (e.g. island networks, back-up systems) is possible. A prerequisite for operation is that the power supply system complies with the specifications of EN 50160 or an equivalent standard.

The function and operation of the protective measures provided in the domestic electrical installation and in this Miele product must also be maintained in isolated operation or in operation that is not synchronised with the mains power supply, or these measures must be replaced by equivalent measures in the installation. As described, for example, in the current version of BS OHSAS 18001–2 ISO 45001.

▶ If the electrical connection cable supplied is damaged, it must only be replaced by an original spare part to prevent a hazard for the user. Miele can only guarantee the safety of the appliance when original Miele spare parts are used. For safety reasons, such replacement may only be carried out by a qualified specialist or the Miele Customer Service Department.

▶ Do not connect the appliance to the mains electrical supply by a multi-socket adapter or extension lead. These are a fire hazard and do not guarantee the required safety of the appliance.

▶ If moisture gets into electrical components or into the mains connection cable, it could cause a short circuit. Therefore, do not operate this refrigeration appliance in areas which are exposed to moisture (e.g. in a garage or utility room).

▶ This appliance must not be used in a non-stationary location (e.g. on a ship).

▶ Do not use a damaged appliance. It could be dangerous. Check the appliance for visible signs of damage.

Warning and Safety instructions

- ▶ For safety reasons, this appliance may only be used after it has been built in.
- ▶ The appliance must be disconnected from the power supply during installation, maintenance and repair work, and during installation work on the mains water connection. It is only completely isolated from the power supply when:
 - the mains fuses are switched off, or
 - the screw-out fuse is removed (where applicable), or
 - the mains cable has been unplugged. Pull on the plug and not the cable when disconnecting it from the power supply.
- ▶ Unauthorised installation, maintenance and repairs, or a faulty mains water connection can cause considerable danger for the user. Installation, maintenance and repairs, installation work on the mains water connection, and all repairs on the ice/water outlet should only ever be carried out by a Miele-authorised technician.
- ▶ The ice-cube maker must only be connected to a cold water supply.
- ▶ Miele cannot be held liable for damage caused by a faulty mains water connection.
- ▶ While the appliance is under warranty, repairs should only be undertaken by a Miele authorised service technician. Otherwise the warranty is invalidated.
- ▶ Faulty components must only be replaced with genuine Miele original spare parts. Miele can only guarantee the safety standards of the appliance when Miele replacement parts are used.
- ▶ This refrigeration appliance is supplied with a special lamp to cope with particular conditions (e.g. temperature, moisture, chemical resistance, abrasion resistance and vibration). This lamp must only be used for the purpose for which it is intended. The lamp is not suitable for room lighting. Replacement lamps may only be fitted by a Miele authorised technician or by the Miele Customer Service Department. This refrigeration appliance contains several light sources with at least energy efficiency class G.
- ▶ In areas which may be subject to infestation by cockroaches or other vermin, pay particular attention to keeping the appliance and its surroundings clean at all times. Any damage caused by cockroaches or other vermin will not be covered by the warranty.

Warning and Safety instructions

Proper installation

- ▶ When installing the refrigeration appliance, it is a mandatory requirement to follow the installation instructions supplied with it.
- ▶ Always wear protective gloves when transporting and installing the refrigeration appliance.
- ▶ Two people are required to install the refrigeration appliance.
- ▶ Only install the refrigeration appliance in a solid, rectangular and level housing unit, positioned on an even and level floor.

Correct use

- ▶ This refrigeration appliance is designed for use within specific ambient temperatures (climate range). Do not use in ambient temperatures for which it is not designed. The climate range is stated on the data plate in the interior cabinet of the refrigeration appliance. A lower ambient temperature will cause the compressor to switch off for longer periods, meaning that the refrigeration appliance is unable to maintain the required temperature.
- ▶ Do not cover or block the air vents as this could impair the efficiency of the appliance, increase the electricity consumption and could cause damage to the components.
- ▶ If storing food which contains a lot of fat or oil in the appliance or the door, make sure that it does not come into contact with plastic components as this could cause stress cracks or break the plastic.
- ▶ Risk of fire and explosion. Do not store explosive materials in the refrigeration appliance or any products containing propellants (e.g. spray cans). Electrical components can cause flammable mixes of gases to ignite.
- ▶ Danger of explosion. Do not operate any electrical equipment (e.g. an electric ice-cream maker) inside the refrigeration appliance.
Danger of sparking and explosion.
- ▶ Danger of injury and damage to the appliance. Do not store cans or bottles containing carbonated drinks or liquids which could freeze in the freezer zone. Otherwise they could burst.
- ▶ Danger of injury and damage to the appliance. When cooling drinks quickly in the freezer zone, make sure bottles are not left in for more than one hour. Otherwise they could burst.

Warning and Safety instructions

- ▶ Danger of injury. Never handle frozen food or the metal parts of the appliance with wet hands. Your hands may freeze to the frozen food or to the metal.
- ▶ Danger of injury. Do not take ice cubes out with your bare hands and never place ice cubes or ice lollies in your mouth straight from the freezer zone. The very low temperature of the frozen food can cause frost burn to the lips and tongue.
- ▶ Do not refreeze partially or fully defrosted food. Consume defrosted food as soon as possible, as it will lose its nutritional value and spoil if left for too long. Defrosted food may only be re-frozen after it has been cooked.
- ▶ Observe the manufacturer's "use-by" dates and storage instructions given on food to avoid the risk of food poisoning. Storage times will depend on several factors, including the freshness and quality of the food, as well as the temperature at which it is stored.

Accessories and spare parts

- ▶ Only use original Miele accessories. If other parts are used, warranty, performance and product liability claims will be invalidated.
- ▶ Miele will guarantee to supply functional spare parts for a minimum of 10 years and up to 15 years following the discontinuation of your refrigeration appliance.

Cleaning and care

- ▶ Throw away the first 3 batches of ice to rinse the ice cube maker and the water pipes. Do this:
 - before using for the first time
 - if the ice cube maker has not been used for a long time
 - regularly when in continuous use (at least once a month) to remove ice residues from the system (to avoid a blockage of the water supply)
 - before switching off the ice cube maker for a long period of time
- ▶ Do not use any oils or grease on the door seals, as these will cause the seals to deteriorate and become porous with time.
- ▶ Do not use a steam cleaning appliance to clean or defrost this appliance.
Steam could reach electrical components and cause a short circuit.

Warning and Safety instructions

- ▶ Sharp edged or pointed objects will damage the evaporator, causing irreversible damage to the appliance. Do not use sharp edged or pointed objects to
 - remove frost and ice,
 - separate frozen food or remove ice trays.
- ▶ Do not place electric heaters or candles in the appliance to defrost it. These can damage the plastic parts.
- ▶ Do not use defrosting sprays or de-icers, as they could contain substances which could damage the plastic parts or which might cause the build-up of gases and pose a danger to health.

Transport

- ▶ Always transport the appliance in an upright position and in its original transport packaging to avoid damage in transit.
- ▶ Danger of injury and damage to the appliance. The refrigeration appliance is very heavy and must be transported by two people.

Disposal of your old appliance

- ▶ Children playing could become trapped in the appliance and could suffocate.
 - Remove the appliance doors.
 - Remove the drawers.
 - Leave the adjustable shelves in the refrigeration appliance so children cannot climb inside.
 - If your old refrigeration appliance has a door lock, destroy it. This will prevent the risk of children playing accidentally locking themselves in and endangering their lives.
- ▶ Risk of electric shock!
 - Cut the plug off the mains connection cable.
 - Cut the mains connection cable off the old appliance.

Dispose of the plug and mains connection cable separately from the old appliance.

- ▶ During and after disposal, make sure that the refrigeration appliance is not placed near petrol or other flammable gases and liquids.

Warning and Safety instructions

▶ Risk of fire due to escaping oil or refrigerant!

The refrigerant and oil inside the appliance are flammable. In high enough concentrations, escaping refrigerant or oil may ignite if they come into contact with an external heat source.

During disposal, make sure that the cooling circuit is not damaged in order to prevent refrigerant and oil escaping in an uncontrolled manner (see the data plate for details of the refrigerant).

▶ Splashes of coolant can damage the eyes. Be careful not to damage any part of the pipework whilst awaiting disposal, e.g. by

- puncturing the coolant channels in the condenser,
- bending any pipework, or
- scratching the surface coating.

Symbol on the compressor (depending on model)

This information is only relevant for recycling. There is no risk during normal operation.



▶ The oil in the compressor can be fatal if swallowed or if it penetrates the airways.

Caring for the environment

Disposing of the packaging material

The packaging material is used for handling and protects the appliance from transport damage. The packaging material used is selected from materials which are environmentally friendly for disposal and can generally be recycled.

Recycling the packaging material reduces the use of raw materials. Use material-specific collection points for valuable materials and take advantage of return options. Your Miele dealer will take the packaging material away.

Disposing of your old appliance

Electrical and electronic appliances contain many valuable materials. They also contain certain materials, compounds and components which were essential for their correct functioning and safety. These could be hazardous to human health and to the environment if disposed of with household waste or if handled incorrectly. Please do not, therefore, dispose of your old appliance with household waste.



Take care not to damage your refrigeration appliance before or during disposal in an authorised, environmentally friendly manner. This is to ensure that refrigerant in the cooling circuit and oil in the compressor is contained, and will not leak into the environment.

Instead, please make use of officially designated collection and disposal points to dispose of and recycle electrical and electronic appliances in your local community, with your dealer or with Miele, free of charge. By law, you are solely responsible for deleting any personal data from the old appliance prior to disposal. You are legally obliged to remove any old batteries which are not securely enclosed by the appliance and to remove any lamps without destroying them, where this is possible. These must be taken to a suitable collection point where they can be handed in free of charge. Please ensure that your old appliance poses no risk to children while being stored for disposal.

Installation site

 Risk of damage and danger of injury due to the refrigeration appliance tipping over.

This refrigeration appliance is very heavy and can tip forwards when the appliance door is open.

Keep the appliance door(s) closed until the refrigeration appliance has been built in. The refrigeration appliance must be secured in its building-in niche in accordance with the operating and installation instructions.

 Fire risk and risk of damage from appliances which give off heat.

Appliances which give off heat can catch fire and set fire to the refrigeration appliance.

This refrigeration appliance must not be installed underneath a hob.

 Fire risk and danger of damage from open flames.

Open flames can set fire to the refrigeration appliance.

Keep open flames (e.g. a candle) away from the refrigeration appliance.

This appliance should be installed in a dry, well-ventilated room.

 Risk of damage due to high humidity.

In environments with high humidity, condensation can build up on external refrigeration appliance panels.

This condensate can cause corrosion on external appliance panels.

Install the refrigeration appliance in a dry and/or air-conditioned room with sufficient ventilation.

After installation please make sure that the appliance door(s) closes (close) properly and the refrigeration appliance is installed in accordance with these installation instructions. It is essential to comply with the specified ventilation cutout requirements.

When deciding on the installation site, please bear in mind that your refrigeration appliance will use more energy if installed near to a heater, a cooker or another appliance that gives off heat. Avoid direct sunlight. The higher the ambient temperature, the longer the compressor runs and the higher the energy consumption is.

When installing the refrigeration appliance, please note the following:

- The socket must be easily accessible in an emergency, not concealed behind the appliance.
- The plug and mains connection cable must not touch the rear of the refrigeration appliance as they could be damaged by vibrations from the appliance.

Installation

- Other appliances must also not be plugged into a socket located directly behind the refrigeration appliance.
- When installing the refrigeration appliance, make sure that the mains connection cable does not get trapped or damaged.
- Do not position or operate multi-socket adapters, distributor strips or other electronic devices (e.g. halogen transformers) at the rear of the appliance.
- The floor at the installation site must be horizontal and level and must be as high as the surrounding floor.

Climate range

This refrigeration appliance is designed for use within specific ambient temperatures (climate range). Do not use in ambient temperatures for which it is not designed.

A lower ambient temperature leads to the compressor switching off for longer periods. This can cause the internal temperature in the refrigeration appliance to rise with the risk of food deteriorating and going off.

The climate range is stated on the data plate in the interior cabinet of the refrigeration appliance.

Climate range	Ambient temperature
SN	10 to 32 °C
N	16 to 32 °C
ST	16 to 38 °C
T	16 to 43 °C
SN-ST	10 to 38 °C
SN-T	10 to 43 °C

A freezer from the SN climate range can operate without any difficulties in rooms with a cooler ambient temperature (down to +5 °C).

Ventilation

 Risk of fire and damage due to insufficient ventilation.

If the refrigeration appliance is not ventilated sufficiently, the compressor will run more frequently and for longer periods. This will result in increased energy consumption and a higher operating temperature for the compressor. This may, in turn, cause damage to the compressor.

Please ensure that there is adequate ventilation around the refrigeration appliance.

It is essential to observe the required ventilation gaps.

The ventilation gaps must not be covered or blocked in any way.

They must also be regularly dusted.

Air at the back of the refrigeration appliance gets warm. The appliance housing unit must therefore be constructed to allow sufficient space for ventilation (see “Installation dimensions” and the installation instructions provided).

Side-by-side combinations

 Risk of damage due to condensation on external appliance panels.

In environments with high humidity, condensation can build up on external appliance panels, which can cause corrosion.

Do not place different refrigeration appliance models directly next to or on top of one other.

Exception: your refrigeration appliance can be installed next to another refrigeration appliance with an integrated heating unit if each appliance is built into a separate niche. Please contact your dealer for specific information about which combinations will work with your refrigeration appliance.

It is **not** possible to change the door hinging as the refrigeration appliance features automatic door opening.

Installation

Installation

When installing the refrigeration appliance, it is a mandatory requirement to follow the installation instructions supplied with it.

Knock sensor

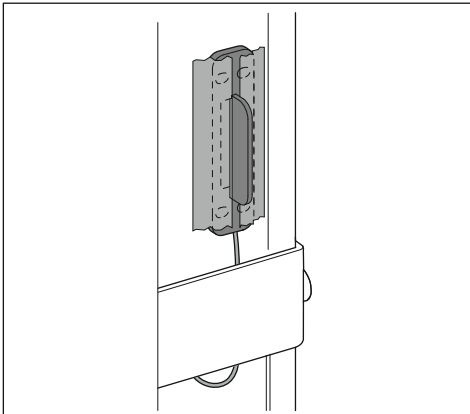

- When installing the knock sensor, ensure that the connecting cable is not damaged.
- Gluing the knock sensor to the furniture front optimises the transmission of the knocking signal. Before installation, it is essential to remove the protective foil from the contact surface of the sensor.
- Permanently securing the knock sensor with the screws that are included helps it function more reliably.

The sensitivity of the knock sensor is set using a slide switch (see “Automatic door opening (ActiveDoor)” in “Guide to the appliance”).

Spacer plates

 Risk of damage caused by the door dragging on the floor. Damage to the drive unit of the appliance door.

If the spacer plates included are not installed in the niche, the distance from the appliance door to the niche floor will be too short.

Install the spacer plates on the niche floor.

Always maintain a distance of 300 mm from the front edge of the niche.

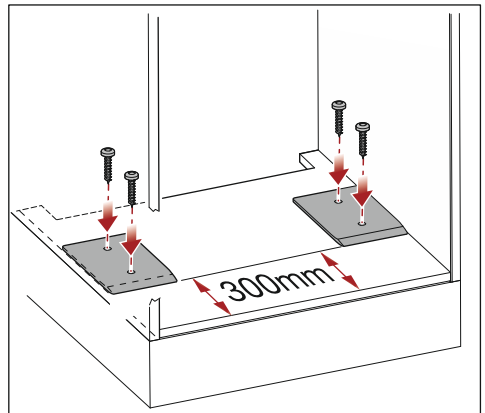

The way in which the spacer plates are installed has an impact on the function.

The distance from the appliance door to the niche floor is increased.

Aligning the refrigeration appliance

The refrigeration appliance must be aligned exactly vertically in the niche. This is the only way to ensure that the appliance door's automatic opening motion is smooth.

Levelling rails

These are enclosed from a niche height of 1400 mm.

The noise level is reduced when they are installed.

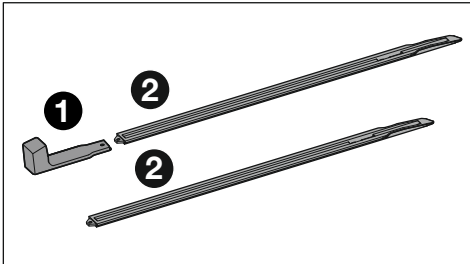

1 – installation handle, 2 – levelling rails

Slide the two levelling rails underneath the refrigeration appliance using the installation handle (see installation instructions).

Connecting to the power supply

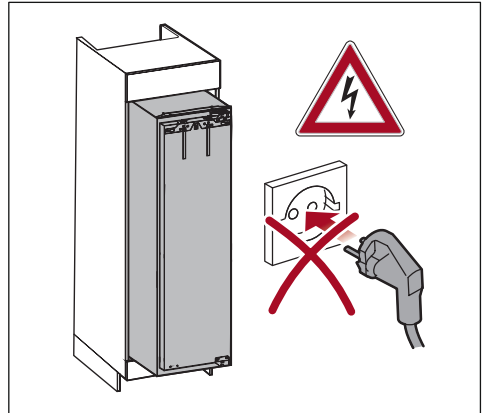

 Risk of damage due to automatically opening door. Damage to the drive unit of the appliance door.

If the refrigeration appliance is not yet fully installed in the kitchen unit, but you have already connected it to the power supply, the door may open unexpectedly. If the appliance door is too close to the niche floor, the door may drag on the floor and damage parts of the drive unit.

Do not insert the mains plug into the socket until the refrigeration appliance has been installed correctly.

- The socket must be easily accessible in an emergency, not concealed behind the appliance.
- The mains plug and mains connection cable must not touch the rear of the refrigeration appliance as they could be damaged by vibrations from the appliance.
- Other appliances must also not be plugged into a socket located directly behind the refrigeration appliance.

Installation

- When installing the refrigeration appliance, make sure that the mains connection cable does not get trapped or damaged.
- Do not position or operate multi-socket adapters, distributor strips or other electronic devices (e.g. halogen transformers) at the rear of the appliance.

Cover strip

For installation in a niche with a niche height of less than 1777 mm but at least 1772 mm.

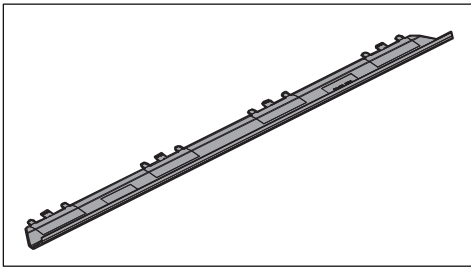

If the cover strip does not fit between the refrigeration appliance and the niche ceiling, it does not need to be fitted.

Furniture door panel

Weight of the furniture door

⚠ If the furniture door panel is too heavy, this can cause damage. Fitting a furniture door panel which is heavier than the maximum permitted weight could damage the hinges. This can cause subsequent functional problems.

The maximum permissible weight of the furniture door is:

Refrigeration appliance	kg
FNS 7794 ...	26

Building-in dimensions

Installation in a tall unit/side view

All dimensions are given in mm.

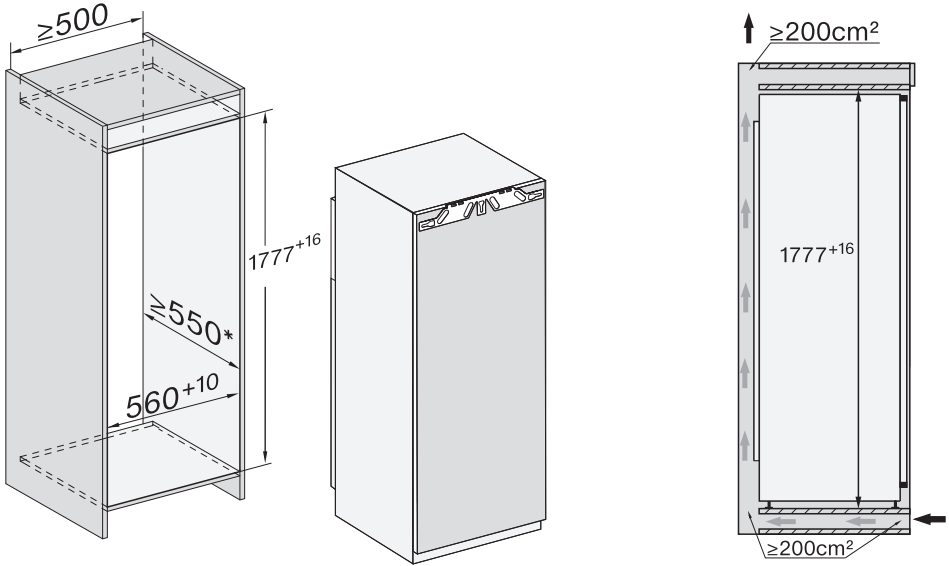

* The declared energy consumption was calculated in a 560 mm deep niche. The refrigeration appliance is fully functional in a 550 mm niche but the energy consumption will be slightly higher.

Before installation, ensure the housing unit dimensions are the correct size.

Installation

Connections and ventilation

All dimensions are given in mm.

The specified ventilation cross-sections must be adhered to in order to ensure the correct functioning of the refrigeration appliance.

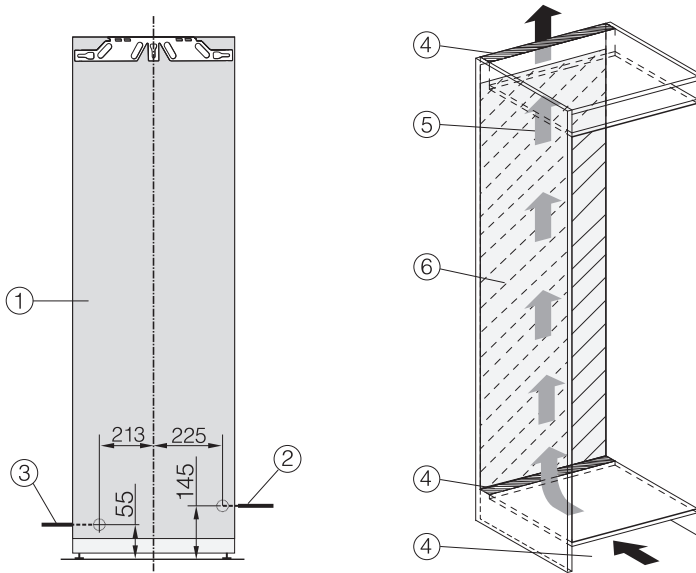

- ① View from the front
- ② Mains connection cable, length = 2200 mm
- ③ Water connection, length = 2000 mm
- ④ Ventilation cross-section min. 200 cm²
- ⑤ Ventilation
- ⑥ No connection sockets in this area

Mains water connection

Information about the mains water connection

 Risk of injury and appliance damage if appliance is not connected properly.

Failing to connect the appliance properly can result in personal injury and/or material damage.

The appliance may only be connected to the mains water connection by suitably qualified specialists.

 Disconnect the refrigeration appliance from the power supply before connecting it to the mains water supply.

Close the stopcock before connecting the refrigeration appliance to the mains water supply.

 Risk to health and risk of damage due to contaminated water.

The quality of the incoming water must conform to the requirements for drinking water in the country where the refrigeration appliance is being used.

Connect the refrigeration appliance to the drinking water supply.

This refrigeration appliance meets the requirements of IEC 61770 and EN 61770.

Connection to the water supply must comply with the applicable regulations in the country where the appliance is being installed. All appliances and systems used to supply water to the refrigeration appliance must also comply with the applicable regulations in the respective country.

For correct functioning (dispensing rate, size of ice cubes, noise level) the water connection pressure needs to be between 150 kPa and 620 kPa (1.5 bar and 6.2 bar).

If the water connection pressure exceeds 620 kPa (6.2 bar), a pressure reducing valve must be fitted.

The water supply line and the inlet solenoid valve on the refrigeration appliance are suitable for a water connection pressure of up to 1000 kPa (10 bar).

Use fresh water to ensure that the quality of the ice cubes remains high. Connect the hose to the fresh water supply and avoid connection to a water supply in which the water might stagnate.

Only use the hose supplied. The hose must not be shortened, extended or replaced by a different hose.

The hose must only be replaced by an original Miele spare part. The food-grade hose is available to order from the Miele webshop, from the Miele Customer Service Department or from your local Miele dealer.

Installation

A stopcock must be provided between the hose and the mains water connection to ensure that the water supply can be cut off if necessary.

Make sure that the stopcock remains accessible after the appliance has been installed.

Water supply

Ensure that the connections are tight and leak-proof.

 Risk of damage to the hose. The water supply from the stopcock to the ice cube maker has been interrupted. Do not bend or damage the hose.

A stopcock with a metric R3/4 thread must be incorporated when connecting to the water supply.

The solenoid valve is located at the back of the refrigeration appliance on the bottom right. It also has a metric R3/4 thread.

– Connecting the hose to the refrigeration appliance

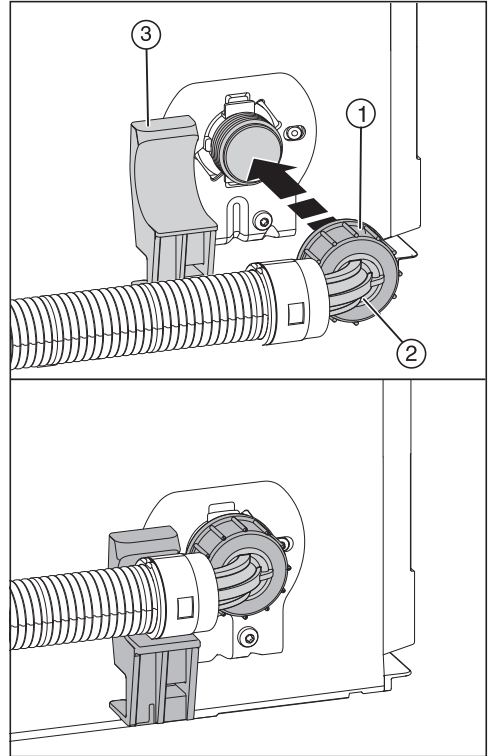

- Pull the cover off the thread of the solenoid valve.
- Position the angled end of the hose (2) horizontally on the holder (3) and hold onto it securely.
- Screw the nut (1) onto the thread by hand until it is securely in place.

– Connecting the hose to the stopcock

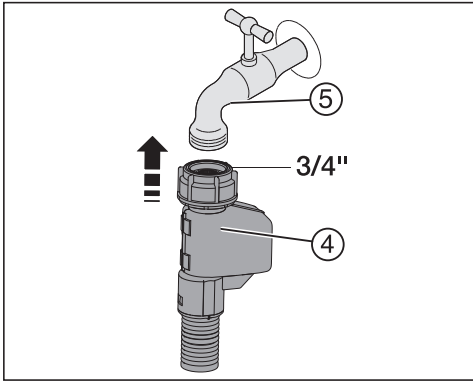

- Connect the nut (4) to the stopcock (5).

– Checking the mains water connection

Test the water connection for leaks before installing the appliance in the niche.

- Slowly open the stopcock (5) and check the screw connections.

Installation

Electrical connection

The refrigeration appliance must only be connected to an earthed socket using the mains connection cable supplied.

The socket must be easily accessible after the refrigeration appliance has been installed. If the socket is not easily accessible, ensure that a suitable means of disconnection is provided on the installation side for each pole.

 Risk of fire from overheating.

Connecting the refrigeration appliance to a multi-socket plug adapter or to an extension lead can overload the cable.

For safety reasons, do not use an extension lead or multi-socket adapter.

The electrical installation must comply with VDE 0100 requirements.

For safety reasons, we recommend using a type  residual current device (RCD) in the assigned electrical installation for connecting the refrigeration appliance.

If the mains connection cable is damaged, it must only be replaced with a specific mains connection cable of the same type (available from the Miele Customer Service Department). For safety reasons, such replacement may only be carried out by a qualified specialist or the Miele Customer Service Department.

These operating instructions and the data plate indicate the nominal power consumption and the appropriate fuse rating. Compare this information with the data of the on-site electrical connection. If in any doubt, consult a qualified electrician.

Temporary or permanent operation on an autonomous power supply system or a power supply system that is not synchronised with the mains power supply (e.g. island networks, back-up systems) is possible. A prerequisite for operation is that the power supply system complies with the specifications of EN 50160 or an equivalent standard. The function and operation of the protective measures provided in the domestic electrical installation and in this Miele product must also be maintained in isolated operation or in operation that is not synchronised with the mains power supply, or these measures must be replaced by equivalent measures in the installation. As described, for example, in the current version of VDE-AR-E 2510-2.

Connecting the refrigeration appliance

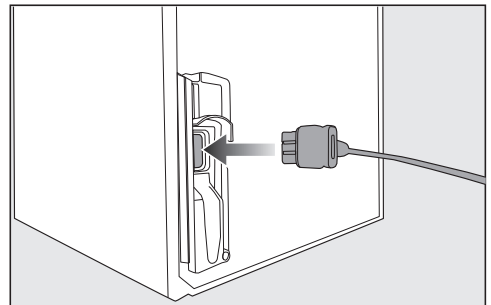

- Insert the plug connector into the socket at the back of the refrigeration appliance.

Make sure that the plug connector has clicked into position correctly.

- Insert the plug of the refrigeration appliance into the socket.

The refrigeration appliance is now connected to the electricity supply.

How to save energy:

- Installation site** The refrigeration appliance has to cool more often at higher ambient temperatures and consumes more energy in the process. Therefore, you should:
- Install the refrigeration appliance in a well-ventilated room.
 - Do not install the refrigeration appliance near to a heat source (heater element, cooker).
 - Protect the refrigeration appliance from direct sunlight.
 - Ensure an ideal ambient temperature of 20 °C.
 - Clean the ventilation gaps on a regular basis to remove any dust.
- Temperature setting** The colder the temperature, the higher the energy consumption. The following settings are recommended:
- -18 °C in the freezer section.
- Use** Energy consumption is increased by heat input and impeded air circulation. Therefore, you should:
- Only open the appliance door(s) when necessary and for as short a time as possible. Arrange the food in such a way that makes it easy to find in the appliance.
 - Always close the appliance door(s) properly after opening them.
 - Allow hot food and drinks to cool down before placing them in the refrigeration appliance.
 - Store food well packaged or covered.
 - Do not overfill the compartments to allow air to circulate.
 - Keep drawers and shelves arranged as they were when the appliance was delivered.
 - When placing food in the appliance, make sure that the ventilation slots are not blocked.

Guide to the appliance

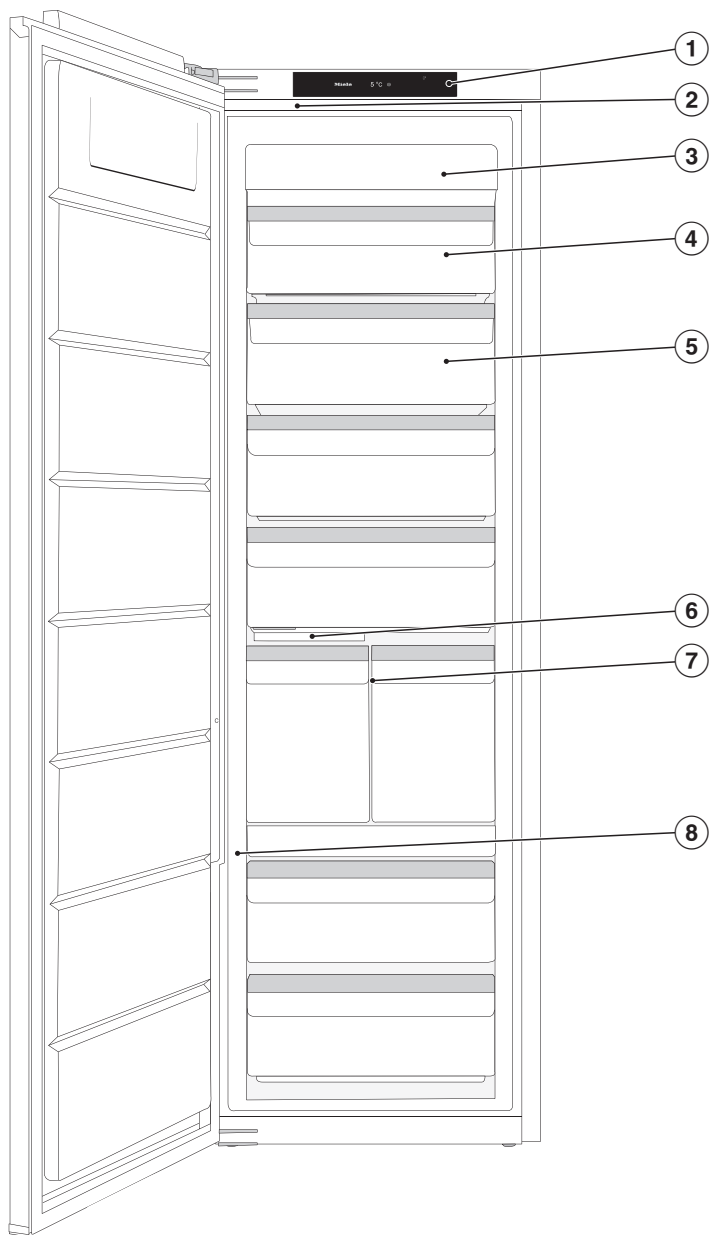

This image shows an example of an appliance model with left-hand hinging.

- ① Display
- ② Interior lighting
- ③ NoFrost module
- ④ Tiltable freezer drawer
- ⑤ Freezer drawers
- ⑥ Ice cube maker with integrated ice cube tray and light
- ⑦ Ice&PizzaBox
- ⑧ Sliding switch for setting the sensitivity of the knock sensor (ActiveDoor)

Guide to the appliance

Start display

The display can be scratched by pointed or sharp objects, e.g. pens.
Only touch the display with your fingertips.
It is possible that the display will not react to finger contact if your fingers are cold.

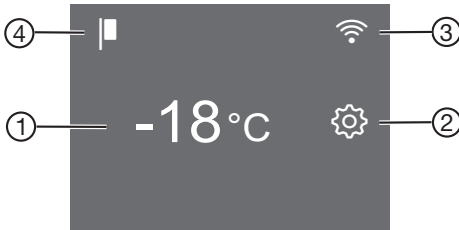













- ① Temperature display for freezer section
- ② Settings mode 
sensor control for adjusting various settings in Settings mode
- ③ Display for Miele@home connection status
(only visible when the Miele@home function has been set up)
- ④ Demo mode display
(only visible when the Demo mode function has been switched on)

Using the appliance







- Touch the area/symbol you want on the start display.
- Swipe left or right across the display until the value/symbol you want is shown in the middle.
- Tap on the option you want on the display to confirm.
The selected value/symbol will light up orange (except for a few exceptions).
- To leave the Settings level, tap on  or OK.

Settings mode

In Settings mode, you can select the following appliance functions and alter their settings to some extent:

Symbol	Function	Factory default
	Switch the Party mode function on or off (see “Selecting further settings”)	Off
	Switching the ice cube maker on and off (see “Making ice cubes”)	Off
	Switching the lock function on or off (see “Selecting further settings”)	 (off)
	Switching off the refrigeration appliance	—
	Switch the Sabbath mode function on or off (see “Selecting further settings”)	Off
	Call up the Sabbath mode version	—
	Configure or deactivate the automatic door opening (ActiveDoor) function. (See “Selecting additional settings”)	
	Activate/deactivate ActiveDoor (only appears when ActiveDoor is activated, see “Selecting further settings”)	
	Change the set door opening angle (only appears if a door opening angle has already been set, see “Selecting further settings”)	
	Change the time until the door alarm is triggered when the door is opened manually (see “Selecting further settings”)	1:00
	Set up the Miele@home function for the first time, activate and deactivate WiFi or reset the network configuration (see “Selecting further settings”)	App
	Switch the keypad tone on or off	On

Guide to the appliance

	Change the volume of the alarms and buzzers or switch them off entirely (see “Selecting further settings”)	On /level 5
	Change the display brightness (see “Selecting further settings”)	Level 4
	Change the temperature unit (°Celsius or °Fahrenheit)	°C
	Switch the Demo mode function off (only visible when switched on) (see “Selecting further settings”)	Off
	Reset to default settings (see “Selecting further settings”)	—
	Call up information (model identifier and serial number) about your refrigeration appliance (see “Selecting further settings”)	—
	Setting the cleaning position of the ice cube tray (only appears if the ice cube maker is switched on) (see “Cleaning and care”)	—

Automatic door opening (ActiveDoor)

 Risk of injury during automatic opening and closing of the appliance door

Body parts such as fingers can become jammed in the area of the door opening range and in the door hinge area.

Leave the area of the door opening range clear.

Do not reach into the door hinge area or inside the refrigeration appliance with your hand while the door is closing.

Do not block the door.

 Risk of damage caused by manual movement of the appliance door when automatic door opening is activated. Damage to the drive unit of the appliance door.

If you open or close the appliance door by using your hand against the automatic door movement, the drive unit and the door hinge will be damaged.



Do not move the appliance door by using your hand against the automatic door movement.

 Risk of damage while the appliance door is closing automatically

Drawers or telescopic runners that are pulled out can be damaged (depending on the model).

Push in drawers fully.

Push in telescopic runners fully after removing a drawer.

This function must be activated and configured in Settings mode  (see “Selecting further settings – Automatic door opening (ActiveDoor) ”).

During automatic door movement,  flashes in the display and a buzzer sounds.

When automatic door opening is activated, you can open the appliance door using the knocking signal or voice commands.

The appliance door can be opened manually if you decide not to activate ActiveDoor or if you deactivate it.

When the function is activated, the refrigeration appliance runs at a higher power level. This means that the movement noises may be louder. The energy consumption will be higher.

... via knocking signal

Knock twice on the outside or inside of the door to open or close it.

The sensitivity of the knocking signal can be changed at any time.

Guide to the appliance

Sensitivity of the knock sensor

A sliding switch is used to set the sensitivity of the knock sensor. This sliding switch is located on the hinge-side outer edge in the lower third of the door (see “Guide to the appliance”).

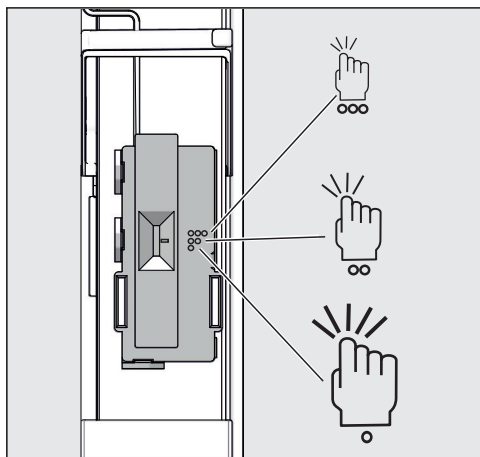

Settings

Switch setting	Meaning
Top (3 dots)	High sensitivity, light knocking sufficient.
Middle (2 dots)	Medium sensitivity, slightly heavy knocking required. This is the default setting.
Bottom (1 dot)	Low sensitivity, heavy knocking required.

... via voice commands

depending on model

In addition to the knocking signal, you can also open and close the appliance door via voice commands. All settings are configured in the Miele app.

- Activate and configure ActiveDoor (see “Selecting further settings”, section “1. Activate and configure ActiveDoor for the first time”).

For information on the following settings, see “Miele@home” in “Selecting further settings”.

- Install the Miele app on your smartphone.
- Establish a WiFi connection to your refrigeration appliance.
- Register your refrigeration appliance in the Miele app by following the instructions in the app.
- Install a voice assistant.

Adjusting the interior fittings

Ice&PizzaBox

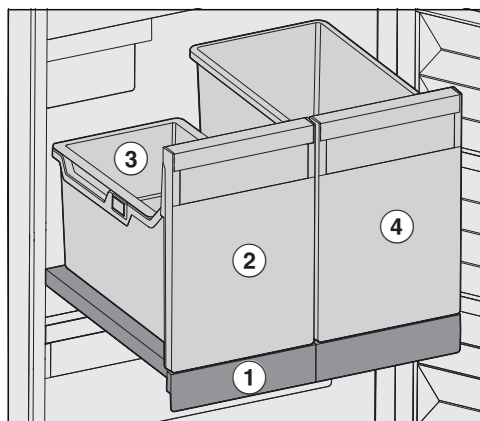

The Ice&PizzaBox is located on a pull-out shelf ① and can only ever be pulled out as a whole.

There is a clip-on container ② in the ice cube drawer ③. The clip-on container can contain a normal amount of ice cubes. The clip-on container can be easily removed and reinserted for use.

If you ever need a larger quantity of ice cubes, you can simply remove the clip-on container.

Pizza boxes can be placed vertically in the PizzaBox ④ next to it.

The pizza boxes can be conveniently removed and sorted.

In addition, you have a good overview of the stored pizzas.

You can also use the PizzaBox for storing high types of food.



Risk of damage caused by loading too much food.

Loading food which is too heavy can damage the drawers and the pull-out shelf.

Do not exceed the maximum load size of the pull-out shelf of 20 kg.

Tilting the top drawer

The top drawer can be tilted to make it easier to remove frozen food.

- Pull the drawer out.

The drawer is secured with pull-out stops and cannot fall out.

Creating a flexible design for the freezer zone (VarioRoom)

If you wish to freeze large items such as a turkey or game, you can remove the upper freezer drawers and the glass plates between the freezer drawers. This creates more volume and space for storing bulky and tall items of frozen food.

Accessories supplied

Ice cube scoop

Optional accessories

A range of useful Miele accessories and care products are available for your appliance.

Multi-purpose microfibre cloth

The microfibre cloth is suitable for removing fingerprints and light soiling from surfaces such as stainless steel, glass, plastic and chrome without the use of chemicals.

MicroCloth Kit

The MicroCloth Kit contains a universal cloth, a glass cloth and a polishing cloth. These cloths are extremely resistant to tearing and very robust. Thanks to very fine microfibrils these cloths achieve an excellent cleaning performance.

MicroCloth HyClean

The MicroCloth HyClean is a multi-purpose antibacterial cloth and is particularly tear resistant and durable. It can be used wet or dry, with or without cleaning agent.

Optional accessories can be ordered from the Miele webshop. They can also be ordered from the Miele Customer Service Department (see end of this booklet for contact details) or from your Miele dealer.

Switching on and off

Before using for the first time

- Remove all packaging material and protective film.
- Clean the inside of the appliance and the accessories (see “Cleaning and care”).

Connecting the refrigeration appliance



- Connect the refrigeration appliance to the electricity supply as described in “Electrical connection”.



Miele will then appear on the appliance display, followed by .

Switching the refrigeration appliance on

- Open the appliance door.
- Tap  on the display.

The refrigeration appliance will start to cool and the interior lighting will come on.

When the set temperature is reached, the   symbol disappears, the temperature display lights up constantly and the alarm tone stops.



- If the alarm annoys you, tap  .

The alarm will stop.

The refrigeration appliance will gradually reach the pre-set temperatures.

Do not place food in the freezer zone until it has reached the preset temperature (min. -18 °C).

Switching off the refrigeration appliance

- Touch the temperature display on the display.
- Swipe right until  is shown in the middle.
- Tap .

The cooling and interior lighting are switched off.

 will appear in the display.

Please note: The refrigeration appliance is not disconnected from the power supply when it is switched off.

To note when switching off for longer periods of time

If, during a long absence, the refrigeration appliance is switched off but not cleaned and the door is left shut, there is a danger of mould building up inside the appliance. It is essential to clean the refrigeration appliance before a long period of absence.

If the refrigeration appliance is not going to be used for a longer period of time, observe the following:

- Switch the refrigeration appliance off.
- Switch off at the wall and disconnect the plug from the socket, or disconnect the fuse.
- Empty the ice cube drawer.



Risk of damage to the ice cube maker.

If the water inlet is blocked while the ice cube maker is still in use, the water inlet pipe can freeze up.

Turn the ice cube maker off if the water supply is turned off (e.g. while on holiday).

- Close the stopcock for the water inlet.
- Clean the refrigeration appliance and leave the door ajar to air the refrigeration appliance and avoid odours building up inside.

The correct temperature

It is very important to set the correct temperature to ensure the shelf life of food. Reducing the temperature reduces the growth rate of microorganisms. Food does not spoil as quickly.

To freeze fresh food, a temperature of **-18 °C** is required. This will prolong the shelf life of your food and retain its quality.

As soon as the temperature rises above -10 °C, the bacteria become active in the food again so it cannot be kept as long. For this reason, partially defrosted or defrosted food must not be re-frozen. Food may be re-frozen once it has been cooked, as the high temperatures achieved when cooking destroy most bacteria.

The temperature in the refrigeration appliance will rise:

- The more often the appliance door is opened and the longer it is kept open
- The more food is stored in it
- The warmer the food is which is being put into it
- The higher the ambient temperature surrounding the refrigeration appliance This refrigeration appliance is designed for use within specific ambient temperatures (climate range). Do not use in ambient temperatures for which it is not designed.

By keeping the freezer zone at a constant temperature of -18 °C and taking appropriate hygiene measures you can maximise the storage life of your food and avoid food waste.

Temperature display

In normal operation, the temperature display shows the current **maximum freezer section temperature** in the refrigeration appliance.

Depending on the ambient temperature and the temperature setting, it can take the appliance a few hours to reach the temperature required and for this temperature to then be shown as a constant temperature in the display.

Setting the temperature

- Touch the temperature display on the display.
- Swipe left or right until the temperature you want is shown in the middle.
- Tap on the temperature you want to confirm.

The temperature display will then change back to the current temperature in the refrigeration appliance.

Possible temperature settings

- Freezer section: -15 to -28 °C

SuperFreeze ❄️

When switched on, the SuperFreeze function ❄️ can be used to rapidly reduce the temperature in the **freezer section** to its lowest setting (depending on the ambient temperature). The refrigeration appliance will work at full power and lower the temperature. Select this function before freezing fresh food. This helps food to freeze quickly and retain its nutrients, vitamins, flavours and appearance.

When the SuperFreeze function ❄️ is switched on, the appliance may make more noise than usual.

SuperFreeze should be switched on approx. **6 hours before** placing food in the freezer section.

When freezing the **maximum amount of food**, the SuperFreeze function ❄️ should be switched on **24 hours beforehand**.

The SuperFreeze function ❄️ will switch itself off automatically after a maximum of 72 hours. The refrigeration appliance will then run at normal power again. The quantity of fresh food placed in the freezer will determine the duration before it switches off.

Tip: To save energy, you can switch the SuperFreeze function off yourself once food and drinks are sufficiently chilled.

You do not need to switch on the SuperFreeze function:

- If you are placing food that is already frozen in the freezer
- If you only freeze up to 2 kg of fresh food daily

Switching SuperFreeze ❄️ on and off

- Touch the temperature display.
- Tap ❄️ to switch the SuperFreeze function on and off again.

When the SuperFreeze function is **switched on**, ❄️ will light up orange.

- Tap on the temperature display to leave the Settings level.

Selecting further settings

Explanation of the different settings

Only the settings that require further explanation are described below.

The door alarm and other warnings are automatically suppressed when you are in Settings mode .



Party mode

The Party mode function  is recommended if you wish to freeze large amounts of fresh food quickly and if you need ice cubes.

Tip: Switch on the Party mode function  approx. 4 hours before placing food and drinks in the appliance.

When Party mode  is switched on, the following are switched on automatically:



- The SuperFreeze function 
- The ice cube maker (ice cubes will be produced)

The Party mode function  will switch itself off automatically after approx. 24 hours. However, you can switch the Party mode function  off early at any time.

If there is a power cut, the Party mode function  is switched off.

Switching the lock function / on

When the lock function is switched on, it protects the refrigeration appliance from being switched off unintentionally and being adjusted unintentionally by unauthorised persons, e.g. children.

- Tap .
- Swipe left or right until  is shown in the middle.

- Tap .

When the lock function is switched on,  will light up orange.

- Close the appliance door. Only then will the lock function  be active.

Deactivating the lock function / temporarily

If you want to adjust the temperature, for example, you can deactivate the lock function temporarily:





- Touch the temperature display.
- Touch  for approx. 6 seconds.

The display switches to the temperature controls.

- Now select the required settings.

Closing the appliance door will reactivate the lock function .

Switching the lock function / off completely

- Tap .
- Touch  for approx. 6 seconds.
- Swipe left or right until  is shown in the middle.
- Tap .

When the lock function is switched off,  will light up.

Sabbath mode

The refrigeration appliance offers a Sabbath mode for the purposes of religious observance.

If Sabbath mode  is switched on, this will be indicated on the start display.

The display switches off after 3 seconds.

Selecting further settings

When Sabbath mode  is switched on, you cannot make any settings on your refrigeration appliance.

Ensure that the appliance door is properly closed, as visual and audible alarms are switched off.

The Sabbath mode function  will switch off automatically after approx. 80 hours.

When Sabbath mode  is switched on, the following are deactivated:

- Interior lighting when the door is opened
- All visual and audible signals
- The temperature display
- An active WiFi connection

All other functions switched on previously remain activated.

 Health risk caused by decomposing food.

As power failures are not indicated while Sabbath mode  is active, food may be exposed to increased temperatures for a certain period of time. This will reduce the storage life of the food.

If there is a power failure during Sabbath mode , check the quality of the food.

Switching Sabbath mode off

- Tap on the black display.

 will appear in the display.

- Tap .

 will light up orange.

- Tap the  symbol again.

When Sabbath mode is switched off, the  symbol will light up white.

Selecting further settings

Automatic door opening (ActiveDoor)





The following settings can be configured:

1. Activate and configure ActiveDoor when commissioning the refrigeration appliance or at a later point
2. Deactivate ActiveDoor
3. Activate ActiveDoor if the function has already been configured and deactivated
4. Change the set door opening angle

1. Activate and configure ActiveDoor for the first time

Activation and configuration consist of multiple steps:

Activating ActiveDoor

- Tap .
- Swipe left or right until  is shown in the middle.
- Tap .
-  will light up yellow in the display.
- Tap *OK*.

 will light up yellow in the display. You now need to set the door opening angle.

Setting the door opening angle

Leave the area of the door opening range clear.

- Open the door to the required door opening angle (at least 70°).

Tip: To ensure the drawers can be pulled out without any problems, select a door opening angle of at least 90°.



- Tap *OK*.

 will light up yellow in the display.

- Tap *OK*.

- If  appears in the display, the door opening angle was **not** successfully saved.

Tap  to confirm the information.

 will light up yellow in the display. Start again from the " Setting the door opening angle" step.

- If  appears in the display, the door opening angle has been saved successfully.

Tap  to confirm the information.

 will light up yellow in the display. You now need to perform a reference run.

Performing a reference run

 Risk of injury during automatic opening and closing of the appliance door

Body parts such as fingers can become jammed in the area of the door opening range and in the door hinge area.

Leave the area of the door opening range clear.

Do not reach into the door hinge area or inside the refrigeration appliance with your hand while the door is closing.

Do not block the door.

 Risk of damage while the appliance door is closing automatically

Drawers or telescopic runners that are pulled out can be damaged (depending on the model).

Push in drawers fully.

Push in telescopic runners fully after removing a drawer.



- Tap *OK*.

The reference run will start. During the reference run, the door will close and open again automatically once.

At the same time,  will flash in the display and a buzzer will sound.

- If  appears in the display, the reference run was **not** successful.

Tap  to confirm the information.

 will light up yellow in the display. Start again from the “ Activating ActiveDoor” step.

- If  appears in the display, the reference run was successful.

Tap  to confirm the information.

 will light up yellow in the display. You now need to save the selected door opening angle.

Saving the selected door opening angle







- Tap *OK*.

If  appears in the display, the door opening angle has been saved successfully.







- Tap  to confirm the information.

 will light up orange in the display. ActiveDoor is activated.

2. Deactivate ActiveDoor





- Tap .
- Swipe left or right until  is shown in the middle.
- Tap .
-  will light up orange in the display.
- Tap .
-  will light up white and ActiveDoor will be deactivated.

3. Activate ActiveDoor

- Tap .
- Swipe left or right until  is shown in the middle.
- Tap .
-  will appear in the display.
- Tap .
-  will light up orange and ActiveDoor will be activated.

Selecting further settings

4. Change the set door opening angle

- Tap .
- Swipe left or right until  is shown in the middle.
- Tap .
- Ⓜ will light up orange in the display.
- Swipe left or right until  is shown in the middle.

- Tap .

 will light up yellow in the display. You now need to set the door opening angle.

Setting the door opening angle

Leave the area of the door opening range clear.

- Open the door to the required door opening angle (at least 70°).

Tip: To ensure the drawers can be pulled out without any problems, select a door opening angle of at least 90°.



- Tap *OK*.

 will light up yellow in the display.

- Tap *OK*.

- If  appears in the display, the door opening angle was **not** successfully saved.

Tap  to confirm the information.

 will light up yellow in the display. Start again from the “ Setting the door opening angle” step.

- If  appears in the display, the door opening angle has been saved successfully.

Tap  to confirm the information.

 will light up yellow in the display. You now need to perform a reference run.

Performing a reference run

 Risk of injury during automatic opening and closing of the appliance door

Body parts such as fingers can become jammed in the area of the door opening range and in the door hinge area.

Leave the area of the door opening range clear.

Do not reach into the door hinge area or inside the refrigeration appliance with your hand while the door is closing.

Do not block the door.

 Risk of damage while the appliance door is closing automatically

Drawers or telescopic runners that are pulled out can be damaged (depending on the model).

Push in drawers fully.

Push in telescopic runners fully after removing a drawer.



- Tap *OK*.

The reference run will start. During the reference run, the door will close and open again automatically once.

At the same time,  will flash in the display and a buzzer will sound.



- If  appears in the display, the reference run was **not** successful.

Tap  to confirm the information.

 will light up yellow in the display. Start again from the “ Activating ActiveDoor” step.

- If  appears in the display, the reference run was successful.

Selecting further settings

Tap  to confirm the information.  will light up yellow in the display. You now need to save the selected door opening angle.

Saving the selected door opening angle

- Tap *OK*.



If  appears in the display, the door opening angle has been saved successfully.

- Tap  to confirm the information.

 will light up orange in the display. ActiveDoor is activated.

Change the time until the door alarm is triggered when the door is opened manually

You can set how quickly the door alarm should sound after the appliance door has been opened manually.

- Tap .
- Swipe left or right until  is shown in the middle.
- Tap .
- Swipe left or right until the time you want between 30 seconds and 3 minutes 30 seconds is shown in the middle.
- Tap to confirm the setting.

Miele@home

Your refrigeration appliance is equipped with an integrated WiFi module. Networking is deactivated at the factory.

To use this feature, you will need:

- A WiFi network
- The Miele app

- A Miele user account You can create a user account via the Miele app.

The Miele app will guide you as you connect your refrigeration appliance to your home WiFi network.

Once the refrigeration appliance is connected to your WiFi network, you can use the app to carry out the following activities, for example:

- Call up information on the operating status of your refrigeration appliance
- Change the settings on your refrigeration appliance

Connecting your refrigeration appliance to your WiFi network will increase energy consumption, even when the appliance is switched off.

Make sure that the signal of your WiFi network is sufficiently strong in the place where you want to set up your refrigeration appliance.

Availability of the WiFi connection

The WiFi connection shares a frequency range with other appliances (including microwave ovens and remote control toys). This can give rise to sporadic or even complete connection failures. Therefore, the availability of featured functions cannot be guaranteed.

Miele@home availability

The ability to use the Miele app depends on the availability of the Miele@home service in your country.

The Miele@home service is not available in every country.

For information about availability, please visit www.miele.com.



Selecting further settings

Miele App

The Miele App is available to download free of charge from the Apple App Store® or from the Google Play Store™.



Setting up Miele@home for the first time







- Tap .
- Swipe left or right until  is shown in the middle.
- Tap .
- Tap on the connection method you wish to use (app or WPS).

After you have successfully logged in,  will appear on the start display.

If a connection could not be created,  will appear.





- In this case, start the process again.

Deactivating or activating the WiFi connection

- Tap .
 - Swipe left or right until  is shown in the middle.
 - Tap .
 - Tap  to deactivate the WiFi connection.
-  will appear on the display.
- Tap  to reactivate the WiFi connection.
 - Tap  to exit the menu level.

When the WiFi connection is active,  will light up on the start display.

Resetting the network configuration

- Tap .
- Swipe left or right until  is shown in the middle.
- Tap .
- Swipe right until  is shown in the middle.
- Tap .
- Tap OK.



All entered settings and values for Miele@home are reset to the default settings.

The WiFi connection has been deactivated.  will go out on the start display.

Reset the network configuration if you are disposing of or selling your refrigeration appliance, or if you are putting a used refrigeration appliance into operation. All personal data is removed from the refrigeration appliance. This will also ensure that a previous owner is no longer able to access the refrigeration appliance.

Changing the volume of the alarms and buzzers /

You can change the volume of the alarms and buzzers (e.g. in the event of a door alarm or a fault message). Alternatively, you can switch the alarms and buzzers off if you find them annoying.

- Tap .
- Swipe left or right until  is shown in the middle.
- Tap .
- Select the volume you want by swiping the segment bar to the left or right.



Selecting further settings

- Confirm the volume you want by tapping on the segment bar.

When the alarms and buzzers are switched off,  will appear.

Adjusting the display brightness





You can adjust the display brightness to the lighting conditions in the room.

- Tap .
- Swipe left or right until  is shown in the middle.
- Tap .
- Select the brightness you want by swiping the segment bar to the left or right.
- Confirm the brightness you want by tapping on the segment bar.

Switching off Demo mode

Demo mode  allows the refrigeration appliance to be presented in the showroom without the cooling system being switched on. This setting is not needed for domestic use.





If Demo mode has been switched on as a default setting,  will show on the start display.

- Tap .
- Tap .
- Swipe left or right until  is shown in the middle.
- Tap .

After Demo mode  has been switched off, the refrigeration appliance shuts down and must be switched on again.

Resetting the settings to their default settings

All settings made on the refrigeration appliance will be reset to default settings (for settings, see “Guide to the appliance”).

- Tap .
- Swipe left or right until  is shown in the middle.
- Tap .
-  will appear on the display.
- Tap *OK*.

The refrigeration appliance shuts down and must be switched on again.

Information

Appliance data (model identifier and serial number) is shown on the display.

Keep this appliance data to hand:

- For integrating the refrigeration appliance into your WiFi network (see “Selecting further settings – Miele@home”) (depending on the model).
- When reporting an appliance fault to the Miele Customer Service Department (see “Service”).
- When retrieving information from the EPREL database (see “Service”).

Temperature and door alarm



Health risk caused by decomposing food.

If the temperature in the freezer remains above $-18\text{ }^{\circ}\text{C}$ for a long time, the frozen food can start to defrost. This will reduce the storage life of the food.

Check whether the frozen food has started to defrost. If it has, check that the food is safe to use and if it is, then use it as soon as possible or cook it before freezing it again.

Temperature alarm

The refrigeration appliance has been fitted with a temperature alarm so that the temperature in the freezer zone cannot rise unnoticed.

If the temperature becomes too warm,  will light up red in the temperature display.

An alarm will also sound until the cause of the alarm is rectified or the alarm is switched off.

The temperature the refrigeration appliance is set at determines the temperature the appliance recognises as being too warm.

The audible and visual signals may be activated in the following situations:

- You switch on the refrigeration appliance and the temperature in a temperature zone differs greatly from the set temperature.
- A lot of warm room air enters the freezer when you are rearranging or taking out frozen food.
- You are freezing large amounts of food at once.
- You are freezing warm food.
- There was a power cut.
- The refrigeration appliance has a fault.

Before you switch the temperature alarm off, you must determine the cause and rectify it.

If the alarm annoys you, it can be turned off early.

■ Tap .

The alarm message is confirmed:  goes out and the alarm stops.

The start screen appears in the display: the warmest temperature recorded in the refrigeration appliance will flash for about 1 minute in the display. Then the temperature display will change to the current temperature in the refrigeration appliance.

Door alarm

Door alarm with manual door opening

The appliance door is left open for an extended period.

The refrigeration appliance is fitted with a door alarm to avoid increased energy consumption and food becoming warm if the door is left open.

If the appliance door is left open for an extended period,  will light up yellow in the temperature display. An alarm will also sound and the interior lighting will flash.

The time before the door alarm is triggered can be changed (see “Selecting further settings”).

The door alarm’s audible signal can be switched off (see “Selecting further settings”).

The alarm will stop and  will go out in the display as soon as the door is closed.

Switching the door alarm off early

■ Tap .

The alarm will stop,  will go out and the interior lighting will light up again constantly.

If the appliance door is not closed, the door alarm will sound again after around 1 minute.

Door alarm with automatic door opening

ActiveDoor closes after a short time.

The refrigeration appliance is fitted with a door alarm to avoid increased energy consumption and food becoming warm if the door is left open.

If the appliance door is left open for too long,  will light up yellow in the display. An alarm will also sound and the interior lighting will flash.

You **cannot** change the time until the door alarm is triggered.

The door alarm’s audible signal can be switched off (see “Selecting further settings”).

After a short time, the door will close automatically. The alarm will stop and  will disappear from the display.

Switching the ActiveDoor door alarm off early

■ Touch  in the display.

The alarm will stop, the  symbol will go out and the interior lighting will light up again constantly.

If the appliance door is not closed, the door alarm will sound again after around 1 minute.

 will light up yellow in the temperature display. An alarm will also sound and the interior lighting will flash (see “Door alarm: Appliance door is left open for an extended period”).

Freezing and storing food

Freezing fresh food

 Health risk caused by decomposing food.

If the temperature in the freezer remains above $-18\text{ }^{\circ}\text{C}$ for a long time, the frozen food can start to defrost. This will reduce the storage life of the food.

Check whether the frozen food has started to defrost. If it has, check that the food is safe to use and if it is, then use it as soon as possible or cook it before freezing it again.

Fresh food should be frozen as quickly as possible. This way the nutritional value of the food, its vitamin content, appearance and taste are not impaired.

If food is frozen quickly, the cells have less time to lose moisture, so they shrink significantly less. As there is not so much moisture loss, it is easier for the food to reabsorb it during the defrosting process, and very little water collects around the defrosted food.

Maximum freezing capacity

To ensure that fresh food placed in the freezer freezes through to the core as quickly as possible, the maximum freezing capacity must not be exceeded. The maximum freezing capacity for freezing within a 24-hour period is given on the data plate: "Freezing capacity ... kg/24 hrs".

Storing frozen food

When buying frozen food to store in your freezer, check:



- That the packaging is not damaged
- The use-by date

- That the temperature at which the frozen food is being stored in the shop is $-18\text{ }^{\circ}\text{C}$ or colder

- Where possible, transport frozen food in an insulated bag and then store it quickly in the refrigeration appliance.

Home freezing

Before placing food in the freezer

- When freezing more than 2 kg of fresh food, switch on the SuperFreeze function  for 6 hours before placing the food in the freezer.
- When freezing even larger amounts of food, switch on the SuperFreeze function  for 24 hours before placing the food in the freezer.

This helps the frozen food which is already stored in the freezer to stay frozen.

- Only freeze fresh food which is in a good condition.

Please note that some food is not suitable for freezing. These include, for example, vegetables that are usually eaten raw, such as lettuce or radishes.

Tip: To retain colour, taste, aroma and vitamin C, vegetables should be blanched before they are frozen. To do so, place vegetables portion by portion into boiling water for 2–3 minutes. Then remove and plunge the vegetables into ice-cold water to cool quickly. Leave the vegetables to drain.

Packaging food for freezing

- Freeze food in portions.

Tip: Use suitable packaging to avoid freezer burn (such as freezer containers).

Freezing and storing food

- Expel as much air as possible from the packaging and close it tightly.
- Make a note of the contents and the date of freezing on the packaging.

Placing frozen food in the freezer

 If the food is too heavy, this can cause damage.

Loading food which is too heavy can cause damage to the freezer drawers/glass shelves.

Do not exceed the relevant maximum load:

Freezer drawer = 12 kg

Glass shelf = 35 kg

Unfrozen food should not touch frozen food as this will cause the frozen food to begin to thaw.

- To prevent food sticking together when frozen, make sure that the packaging and containers are dry.

To ensure that food freezes through to the core quickly, do not exceed the following packaging and container sizes:

- Fruit and vegetables: max. 1 kg
- Meat: max. 2.5 kg

– Freezing small amounts of food

Place the food in the upper freezer drawers.

- Place the food flat in the bottom of the **upper** freezer drawers so that it freezes through to the core as quickly as possible.

– Freezing the maximum amount of food (see data plate)

If the ventilation slots are blocked, the cooling performance will decrease and energy consumption will increase.

When placing food in the freezer, make sure that the ventilation slots are not blocked.

Tip: You can expand the space available in the freezer zone. If you wish to freeze large frozen food such as a turkey or game, the glass shelves between the freezer drawers can be removed.

- Remove the upper freezer drawers.
- Place the food flat on the upper glass shelves so that it freezes through to the core as quickly as possible.

Once frozen:

- Switch the SuperFreeze function ❄ off.
- Place the frozen food in the freezer drawers and push them back in.

Cooling drinks quickly

When cooling drinks quickly in the freezer, make sure bottles are **not left in for more than one hour**; otherwise they could burst, causing injury and damage.

Making ice cubes

Check and pay attention to the following before switching the ice cube maker on:

- The ice cube maker must be clean.
- The refrigeration appliance must be switched on.
- Ice cubes can only be made when the ice cube drawer is completely closed.
- There is a clip-on container at the top of the ice cube drawer. If you ever need a larger quantity of ice cubes, you can simply remove the clip-on container. The ice cube maker then automatically produces ice cubes until the maximum fill level in the ice cube drawer is reached.



Risk to health due to contaminated water.

Bacteria can develop in water which has been sitting in the water supply lines for too long. This poses a risk to your health.

Throw away the first 3 batches of ice cubes made after the ice cube maker is started up, as the water will have been used for the initial rinsing of the water supply line.

This applies to the initial commissioning as well as when using the ice cube maker again after it has been switched off for an extended period of time (more than 5 days).

When commissioning the appliance for the first time, it can take up to 24 hours for the first ice cubes to drop out of the ice cube maker and collect in the drawer.



After the ice cube maker has been turned off and on again, this process lasts max. 6 hours.

Only make normal domestic quantities of ice cubes with the ice cube maker.

The ice cube maker can make up to approx. 0.8 kg of ice cubes in 24 hours.

The amount of ice cubes made by the appliance depends on the temperature in the freezer section. **The lower the temperature, the more ice cubes are produced in a certain period of time.**

Switching the ice cube maker on and off

- Tap .
- Swipe left or right until  is shown in the middle.
- Tap .

 will light up orange when the ice cube maker is switched on.

Once the freezer section has cooled down to its set temperature, the ice cube maker will fill with water.

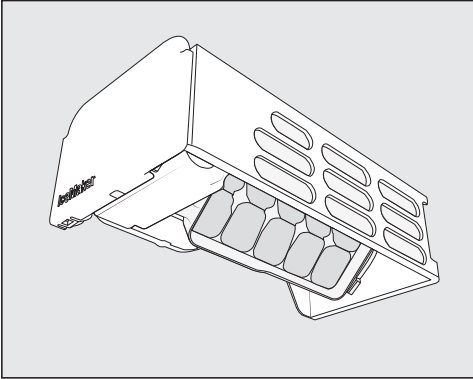

As soon as ice cubes are produced, they will empty automatically from the integrated ice cube tray and into the clip-on container. The clip-on container can be removed if required.

Ice cube production is halted automatically when the clip-on container or the ice cube drawer is full. The drawer will not fill up to the top edge.

Tip: Increase the fill volume of ice cubes by spreading the ice cubes out evenly from time to time.

Tip: Empty the clip-on container or the ice cube drawer at regular intervals, or if you have not produced any ice for more than a week. This will ensure that you always have fresh ice and the ice cubes will not form a clump.

The ice cube maker can be turned off independently of the freezer section if you do not want to make any ice cubes.

If the ice cube maker is switched off, food can be placed in the ice cube drawer and frozen.

- Push the ice cube drawer all the way back in when you stop ice cube production.

Cleaning and care

The data plate located inside the interior cabinet of the refrigeration appliance must not be removed. It contains information which is required in the event of a fault.

Do not let water get into the electronic unit or the lighting.

 Risk of damage due to moisture ingress.

The steam from a steam cleaner can damage plastic and electrical components.

Do not use a steam cleaner to clean the refrigeration appliance.

Defrosting

The appliance is equipped with a NoFrost system. The refrigeration appliance defrosts automatically.

The moisture generated in the appliance collects on the condenser and is automatically defrosted and dissipated from time to time.

This automatic defrosting system enables the refrigeration appliance to remain permanently ice-free. Food stored in the freezer will not defrost with this system.

Cleaning agents

Cleaning and conditioning agents used in the interior cabinet of the refrigeration appliance must be food safe.

To avoid damaging the surfaces of the appliance, **do not use the following:**

- Cleaning agents containing soda, ammonia, acids or chlorides
- Cleaning agents containing descaling agents
- Abrasive cleaning agents (e.g. scouring powder, scouring liquid or pumice stones)
- Cleaning agents containing solvents
- Stainless steel cleaners
- Dishwasher cleaner
- Oven sprays
- Glass cleaning agents
- Hard, abrasive sponges and brushes (e.g. pot scourers)
- Eraser stain remover blocks
- Sharp metal scrapers

We recommend using a clean sponge and lukewarm water with a little washing-up liquid to clean the surfaces of the appliance.

Preparing the refrigeration appliance for cleaning

- Switch the refrigeration appliance off.
 appears in the display and the cooling system is switched off.
- Take any food out of the refrigeration appliance and store it in a cool place.

- Take out any removable accessories for cleaning (see “Removing and dismantling accessories for cleaning”).

Cleaning the inside of the appliance

The refrigeration appliance should be cleaned regularly (at least once a month).

If soiling is left on for any length of time, it may become impossible to remove under certain circumstances. Surfaces may suffer discolouration or damage.

It is therefore best to remove any soiling immediately.

- Clean the **interior** with a clean sponge, lukewarm water and a little washing-up liquid.
- After cleaning, wipe with clean water and dry with a cloth.
- Leave the door open to air the refrigeration appliance sufficiently for a short while and to prevent odour build-up.

Cleaning accessories by hand or in the dishwasher

The following components must be cleaned **by hand** only:

- All drawers
- Pull-out shelf with Ice&PizzaBox
- Telescopic runners and protective trim (on the glass shelves)
- The clip-on container
- The ice cube scoop

The following components are **dishwasher-safe**:

 Risk of damage due to high dishwasher temperatures.

Parts of the refrigeration appliance may become unusable, e.g. deform, if they are washed in the dishwasher at more than 55 °C.

For dishwasher-safe components, always select dishwasher programmes with a maximum temperature of 55 °C.

Contact with natural dyes from carrots, tomatoes and ketchup, etc., may discolour the plastic parts in the dishwasher. This discolouration does not affect the stability of the parts.

- The glass shelves

Removing and dismantling accessories for cleaning

Removing the top drawer and glass shelf

- Pull the drawer out as far as it will go.
- Tilt the drawer slightly upwards and remove the drawer upwards at an angle.
- Pull out the glass plate together with the guide rails.
- Pull the guide rails off to the side.
- After cleaning, reattach the guide rails to the glass plate.

Replacing the top drawer

- Insert the glass plate together with the guide rails in the freezer zone.
- Place the drawer on the guide rails from an angle at the top and push the drawer all the way in.

Cleaning and care

Removing the drawers and glass shelves on telescopic runners

The magnet on the drawer is important for the proper functioning of the ice cube maker.
Do not remove the magnet.

- Pull out the drawer as far as it will go and then lift it up and out.

Push the telescopic rails back in again to avoid damaging them.

- Pull the glass shelf and telescopic runners out.

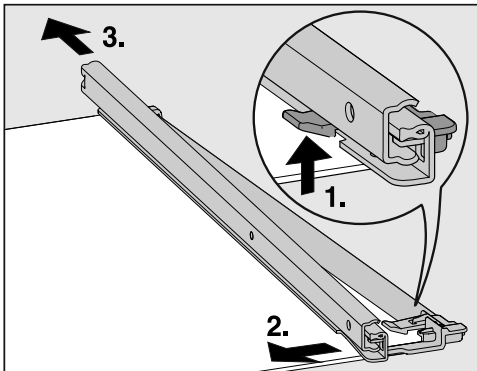

- To remove the telescopic runners:
 1. Push the catch upwards.
 2. Push the telescopic runner to the side.
 3. Then pull the telescopic runner off to the rear.
- Pull off the protective trim at the front and back of the shelf.
- After cleaning the shelf, reattach the protective trim.

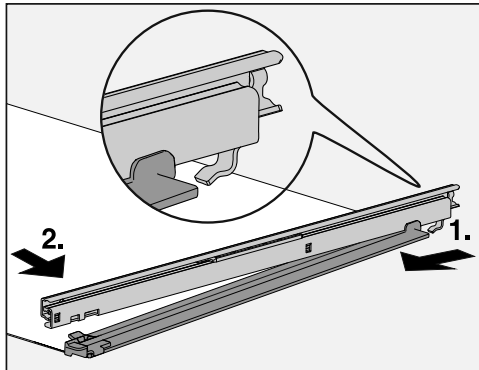

- To attach the telescopic runners to the shelf:

1. Hook the telescopic runner on at the rear.
2. Then clip the catches into position at the front.

Replacing the drawer

- Insert the glass plate together with the telescopic runners in the freezer zone.
- Slide the drawer onto the fully retracted telescopic runners.

Removing the Ice&PizzaBox with pull-out shelf

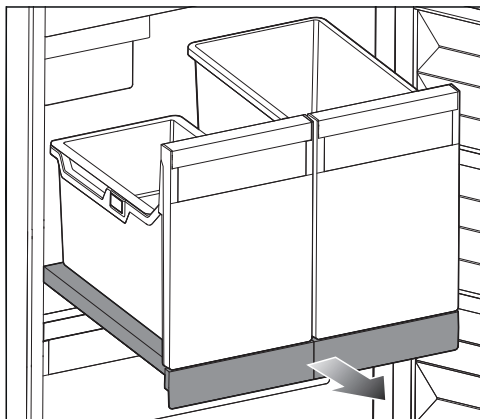

- Pull out the pull-out shelf completely.

Cleaning and care

- Remove the ice cube drawer with the clip-on container and the PizzaBox by lifting them slightly at the front.
- Empty the clip-on container, the ice cube drawer and the PizzaBox.

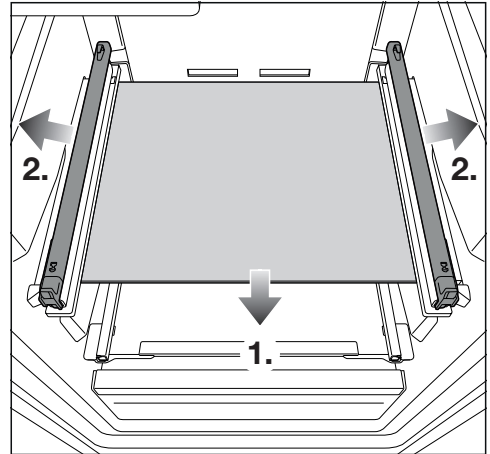
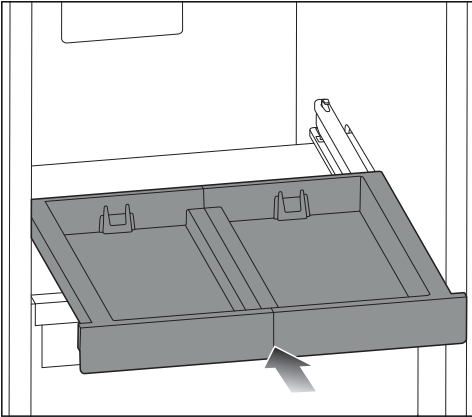

- Remove the glass shelf 1.) and then pull off the telescopic runners to the side 2.).

- Push the pull-out shelf all the way in.

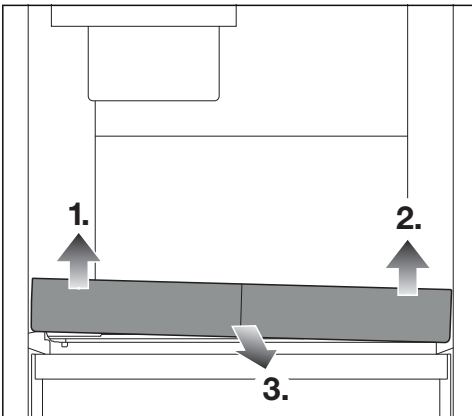

- Lift the pull-out shelf first at the front left 1.), then at the front right 2.) so that it comes loose from its fastening.

Now you can remove the pull-out shelf to the front 3.).

Cleaning and care

Refitting the pull-out shelf with Ice&PizzaBox

- Fit the telescopic runners on each side of the glass shelf.
- Insert the glass shelf into the freezer section.

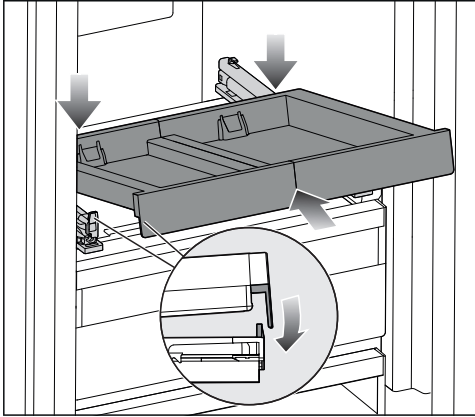

- Insert the pull-out shelf at an angle behind the front retainer.
- Push in the pull-out shelf at an angle.

The stop must be positioned behind the retainer on both sides.

- Set the pull-out shelf down at the front.

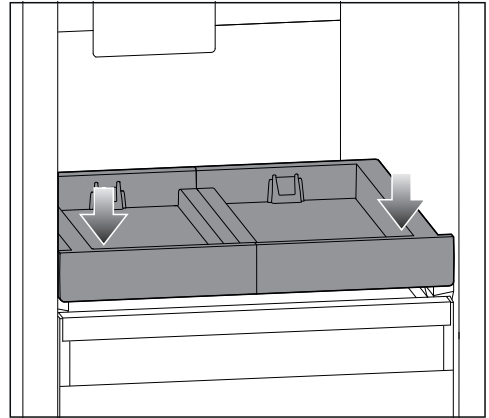

- Press the pull-out shelf down slightly at the front so that it audibly engages.
- Pull out the pull-out shelf while supporting it lightly with your hand.
- Place the ice cube drawer and the PizzaBox on the pull-out shelf.

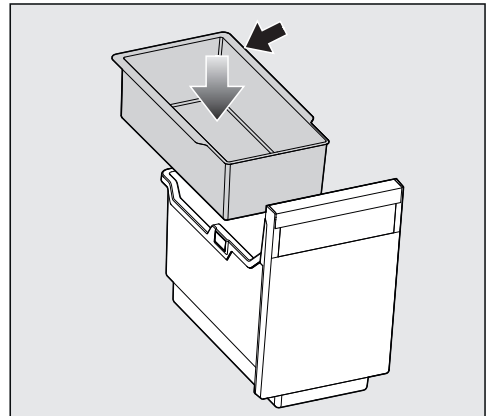

- Place the clip-on container in the ice cube drawer with the raised edge at the back.
- Push the pull-out shelf back in all the way.

Cleaning the ice cube tray

The ice cube tray **cannot be removed** and therefore has to be moved into the cleaning position.

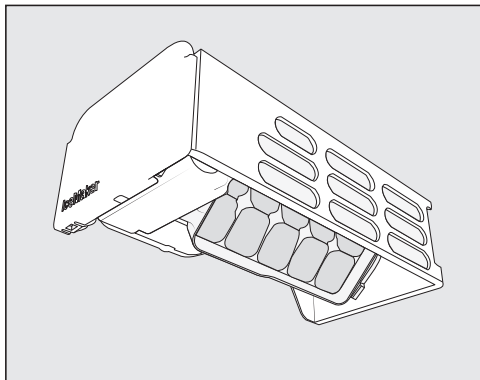

Clean the ice cube tray:

- Before switching off the ice cube maker for a long period of time.
- Regularly, to remove ice and water residues.

Selecting the cleaning position Ⓞ for the ice cube tray

Before selecting the cleaning position for the ice cube tray, check the following:

- The ice cube maker is switched on.
- The ice cube drawer is empty and in position.
- Tap ⚙️.
- Swipe left or right until Ⓞ is shown in the middle.
- Tap Ⓞ.

It will take some time to move the ice cube tray into the cleaning position.

Once the ice cube tray has stopped moving, the ✓ symbol will appear on the display.

- To leave this Settings level, tap ↩️.
- Remove the ice cube drawer.
- Clean the ice cube tray and the ice cube drawer with lukewarm water and a little washing-up liquid. Wipe thoroughly with clean water and dry with a cloth.
- Insert the ice cube drawer back into the appliance.
- After cleaning, tap ✓.

You will hear the ice cube tray return to its original position.

Cleaning the door seal

⚠️ Risk of damage as a result of incorrect cleaning.

If you treat the door seal with oils or grease, it can become porous.

Do not use any oils or grease on the door seal.

- The door seal should be cleaned regularly with clean water, and then wiped dry with a soft cloth.

Cleaning and care

Cleaning the ventilation gaps

A build-up of dust will increase the energy consumption of the appliance.

- The ventilation gaps should be cleaned on a regular basis with a brush or vacuum cleaner (you could use a Miele vacuum cleaner dusting brush, for example).

After cleaning

- Replace all shelves and accessories in the refrigeration appliance.
- Switch the refrigeration appliance back on, if necessary.

The refrigeration appliance will start cooling again.

- Switch the SuperFreeze function ❄ on for a while so that the freezer section can cool down quickly.
- Once the freezer has reached the required temperature, place the frozen food back in the freezer drawers and put them back in the freezer.
- Switch the SuperFreeze function ❄ off as soon as the temperature in the freezer is a constant -18 °C or colder.
- Close the appliance door.

Many malfunctions and faults can be easily remedied. You can save time and money in many cases, as you do not need to contact Customer Service.

More information to help you remedy faults yourself can be found at www.miele.co.uk/support/customer-assistance.



To prevent unnecessary loss of temperature it is advisable not to open the door while waiting for the appliance to be serviced.

Problem	Cause and remedy
<p>The compressor is switching on more frequently and for longer periods of time. The temperature in the refrigeration appliance is too low.</p>	<p>The ventilation gaps have been covered or become too dusty.</p> <ul style="list-style-type: none"> ■ Do not block the ventilation gaps. ■ Dust the ventilation gaps regularly.
	<p>The appliance door has been opened too frequently, or a large amount of fresh food has been placed inside or frozen at the same time.</p> <ul style="list-style-type: none"> ■ Only open the appliance door when necessary and for as short a time as possible. <p>After a while, the temperature will return to normal by itself.</p>
	<p>The appliance door is not properly closed. A thick layer of ice may have formed in the freezer section.</p> <ul style="list-style-type: none"> ■ Close the appliance door. <p>After a while, the temperature will return to normal by itself.</p> <p>If a thick layer of ice has already formed, this will affect cooling and increase energy consumption.</p> <ul style="list-style-type: none"> ■ Defrost the refrigeration appliance and clean it.
	<p>The ambient temperature is too high. The higher the ambient temperature, the longer the compressor runs.</p> <ul style="list-style-type: none"> ■ See the information in “Installation – Installation site”.
	<p>The refrigeration appliance was not properly installed in the niche.</p>



















Troubleshooting

Problem	Cause and remedy
	<ul style="list-style-type: none"> ■ Install the refrigeration appliance in the niche as described in the installation instructions supplied with it. <p>The temperature setting in the refrigeration appliance is too low.</p> <ul style="list-style-type: none"> ■ Correct the temperature setting. <p>A large amount of food is being frozen at once.</p> <ul style="list-style-type: none"> ■ See “Freezing and storing food”. <p>The SuperFreeze function ❄️ is still switched on.</p> <ul style="list-style-type: none"> ■ Switch off the SuperFreeze function ❄️ earlier to save energy.









Other problems



Problem	Cause and remedy
<p>There is no audible alarm even though the appliance door has been open for a long time.</p>	<p>This is not a fault. The alarm has been switched off in Settings mode. If you want to switch the audible alarm back on again:</p> <ul style="list-style-type: none"> ■ Tap 🗨️. ■ Swipe left or right until 🔊 is shown in the middle. ■ Tap 🔊. ■ Select the volume you want by swiping the segment bar to the right. ■ Confirm the setting you want by tapping the segment bar. <p>When the alarms and buzzers are switched on, 🔊 orange will appear.</p>

Display warnings



Message	Cause and remedy
<p> lights up on the start display, the refrigeration appliance does not get cold even though the controls and the interior lighting are working.</p>	<p>Demo mode has been activated.</p> <ul style="list-style-type: none"> ■ Tap . ■ Tap . ■ Swipe left or right until  is shown in the middle. ■ Tap . <p>After Demo mode  has been switched off, the refrigeration appliance shuts down and must be switched on again.</p>
<p>Nothing is visible in the display. The display is completely blank.</p>	<p>Sabbath mode  is switched on: the interior lighting is switched off and the refrigeration appliance is cooling.</p> <ul style="list-style-type: none"> ■ Tap the black display. <p> will appear in the display.</p> <ul style="list-style-type: none"> ■ Tap . <p> will light up orange.</p> <ul style="list-style-type: none"> ■ Tap  again. <p>When Sabbath mode is switched off,  will light up white.</p>
<p> is lit up on the display and the appliance cannot be used.</p>	<p>The lock function has been activated.</p> <ul style="list-style-type: none"> ■ Unlock the refrigeration appliance temporarily or switch the lock function off completely (see “Selecting further settings – Deactivating the lock function / temporarily/switching off completely”).
<p>Automatic door opening is activated.   will light up red in the display and an alarm will also sound.</p>	<p>The alarm has activated as the automatic door opening motor has overheated.</p> <ul style="list-style-type: none"> ■ Wait for a short while and allow the motor to cool down. ■ Move the door manually.
<p>Automatic door opening is activated.   will light up yellow in the display and an alarm will also sound.</p>	<p>An obstruction is blocking the movement of the door.</p> <ul style="list-style-type: none"> ■ Remove the obstruction. ■ Move the door manually. <p>The door hinge mechanism is blocked.</p> <ul style="list-style-type: none"> ■ Do not move the door against the motorised movement. This can damage the door hinges. ■ Contact the Miele Customer Service Department.









Troubleshooting

Message	Cause and remedy
 lights up yellow in the display and an alarm also sounds.	<p>The ice cube drawer is not in the refrigeration appliance. A buzzer sounds after closing the appliance door.</p> <ul style="list-style-type: none"> ■ Tap  on the display. <p>The alarm message is confirmed and the buzzer stops. The current temperature will appear in the display again.</p> <ul style="list-style-type: none"> ■ Replace the drawer correctly in the refrigeration appliance or switch the ice cube maker off. <hr/> <p>The mains water connection has not been installed.</p> <ul style="list-style-type: none"> ■ Make sure that the mains water connection has been installed correctly. <hr/> <p>The water supply is turned off.</p> <ul style="list-style-type: none"> ■ Open the stopcock. <hr/> <p>There is a kink in the hose.</p> <ul style="list-style-type: none"> ■ Check the hose; if it is faulty, it must only be replaced by an original Miele spare part. <hr/> <p>The water connection pressure is too low.</p> <ul style="list-style-type: none"> ■ Check that the water connection pressure is between 150 kPa and 620 kPa (1.5 bar and 6.2 bar).
 lights up yellow in the display and a buzzer sounds.	<p>The drawer for the ice cube maker is full.</p> <ul style="list-style-type: none"> ■ Remove the drawer and empty it.
  will light up yellow in the display, an alarm will also sound and the interior lighting will flash.	<p>The door alarm has been activated. ActiveDoor is not activated.</p> <ul style="list-style-type: none"> ■ Touch   in the display. <p>The alarm will stop, the   symbol will go out and the interior lighting will light up again constantly.</p> <ul style="list-style-type: none"> ■ Close the appliance door.

Message	Cause and remedy
<p> is lit up red in the temperature display and an alarm is also sounding.</p>	<p>The temperature alarm has been activated; the temperature in the freezer section has risen higher or fallen lower than the temperature set.</p> <p>Possible reasons for this include:</p> <ul style="list-style-type: none"> – The appliance door has been opened too frequently. – A large quantity of fresh food has been placed in the freezer without the SuperFreeze function being switched on. – A prolonged power cut (mains outage) has occurred. – The refrigeration appliance has a fault. <p>■ Tap .</p> <p>The alarm message is confirmed:  goes out and the alarm stops.</p> <p>The warmest temperature recorded in the refrigeration appliance will flash for about 1 minute in the display. Then the temperature display will change to the current temperature.</p> <p>You can exit from the flashing temperature display early:</p> <p>■ Touch the temperature display.</p> <p>The warmest temperature displayed will disappear. The display will then revert to showing the current temperature in the freezer.</p> <p>■ Rectify the cause of the alarm.</p> <p>■ Depending on the temperature displayed, you should check whether food in the freezer has started to thaw or has defrosted. If it has, it should be used as soon as possible. Defrosted food may only be re-frozen after it has been cooked.</p>

Troubleshooting



Message	Cause and remedy
<p> lights up red in the display and an alarm also sounds.</p>	<p>Indication of an interruption to the power supply: the temperature in the refrigeration appliance over the last few days or hours has risen too high because of a power cut or interruption to the power supply.</p> <ul style="list-style-type: none">■ Tap . <p>The fault message is confirmed:  goes out and the alarm will stop.</p> <p>The warmest temperature recorded in the refrigeration appliance will flash for about 1 minute in the display. Then the temperature display will change to the current temperature.</p> <p>You can exit from the flashing temperature display early:</p> <ul style="list-style-type: none">■ Touch the temperature display. <p>The warmest temperature displayed will disappear. The display will then revert to showing the current temperature. The refrigeration appliance will go back to the last temperature setting when the power is back on.</p> <ul style="list-style-type: none">■ Rectify the cause of the alarm.■ Depending on the temperature displayed, you should check whether food in the freezer has started to thaw or has defrosted. If it has, it should be used as soon as possible. Defrosted food may only be re-frozen after it has been cooked.

Message	Cause and remedy
 lights up red in the display and a fault code F with numbers may appear. An alarm is also sounding.	<p>There is a fault.</p> <ul style="list-style-type: none"> ■ Tap  on the display to switch the alarm off. ■ Contact the Miele Customer Service Department. <p>To report the fault, you need the fault code and also the model identifier and serial number of your refrigeration appliance. You can access this information on the display:</p> <ul style="list-style-type: none"> ■ To do this, touch  on the display. <p>The appliance data required will be shown on the display.</p> <p>Confirm with  to exit the information display and the fault code will be shown again on the display.</p> <p>The refrigeration appliance can be switched off directly from the fault message display.</p>
  lights up red in the display and an alarm also sounds.	<p>There is a fault with the ice cube maker.</p> <ul style="list-style-type: none"> ■ Tap   on the display to switch the alarm off. ■ Call the Miele Customer Service Department. <p>The ice cube maker can also be switched off in Settings mode .</p>

Problems with automatic door opening

Problem	Cause and remedy
The door is changing speed as it opens.	<p>This is not a fault. The speed of the inner door can change based on its load.</p>
 will appear in the display. The door opening angle cannot be saved.	<p>The selected door opening angle is too small.</p> <ul style="list-style-type: none"> ■ Select a door opening angle of at least 70°. A door opening angle of 90° is ideal to ensure the drawers can be pulled out without any problems.

Troubleshooting

Problem	Cause and remedy
The appliance door is not responding to the knocking signal.	Knocking is not hard enough. ■ Increase the sensitivity of the knock sensor (see “Automatic door opening (ActiveDoor)” in “Guide to the appliance”).
	Holiday mode is activated. To save energy, automatic door opening is deactivated. ■ Open the appliance door by hand. As soon as Holiday mode is deactivated, automatic door opening will be reactivated.
	The knocking function is not activated. ■ Activate automatic door opening (see “Automatic door opening (ActiveDoor)  ” in “Selecting further settings”).
The appliance door is not responding to voice commands.	The voice assistant is not set up. ■ Configure the setting in the Miele app.
	Holiday mode is activated. To save energy, automatic door opening is deactivated. ■ Open the appliance door by hand. As soon as Holiday mode is deactivated, automatic door opening will be reactivated.
	Automatic door opening is not activated. ■ Activate automatic door opening (see “Automatic door opening (ActiveDoor)  ” in “Selecting further settings”).







Interior lighting

Problem	Cause and remedy
 Risk of electric shock due to exposed, live electrical components. When removing the lighting cover, there is a risk of coming into contact with live electrical components. Do not remove the lighting cover. The LED lighting may only be repaired or replaced by the Miele Customer Service Department.	

 Risk of injury from LED lighting.

This lighting corresponds to risk group RG 2. If the cover is defective, there is a risk of eye injury.

If the lighting cover is defective, do not look from a close range directly into the lighting with optical instruments (e.g. magnifying glass or similar).

Problem	Cause and remedy
<p>The interior lighting is not working.</p>	<p>The refrigeration appliance has not been switched on.</p> <ul style="list-style-type: none"> ■ Switch the refrigeration appliance on.
	<p>Sabbath mode  is switched on: the display is dark and the refrigeration appliance is cooling.</p> <ul style="list-style-type: none"> ■ Tap on the black display. <p> will appear on the display.</p> <ul style="list-style-type: none"> ■ Tap . <p> lights up orange.</p> <ul style="list-style-type: none"> ■ Tap on the  symbol in Settings mode . <p>When Sabbath mode is switched off, the  symbol will light up white.</p>
	<p>To avoid overheating, the lighting switches itself off automatically after approx. 15 minutes if the appliance door is left open. If this is not the case, then there is a fault.</p> <ul style="list-style-type: none"> ■ Call the Miele Customer Service Department.

Service

Information to help you rectify faults yourself and about Miele spare parts can be found at www.miele.com/service.

Contact in the event of a fault

In the event of a fault which you cannot remedy yourself, please contact your Miele dealer or Miele Customer Service.

You can book a Miele Customer Service call-out online at www.miele.com/service.

Contact information for Miele Customer Service can be found at the end of this document.

Please quote the model identifier and serial number of your appliance (SN) when contacting Miele Customer Service. Both numbers can be found on the data plate inside the refrigeration appliance or, depending on the model, in Settings mode under Information **i**.

EPREL database

Since 1 March 2021, information on energy labelling and ecodesign requirements has been available in the European Product Database (EPREL). You can find the product database at the following link <https://eprel.ec.europa.eu/>. You will be asked to enter the model identifier.

The model identifier can be found on the data plate inside the refrigeration appliance or, depending on the model, in Settings mode under Information **i**.

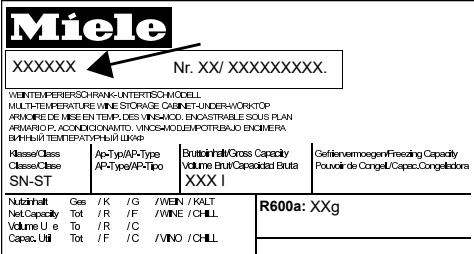

Miele

XXXXXX ← Nr. XX/XXXXXXXXXX.

WEINTEMPERIER-SCHRANK-UNTERTISCH-MODELL
 MULTI-TEMPERATURE WINE STORAGE CABINET-UNDER-VORSTOPF
 ARMOIRE DE MISE EN TEMP. DES VINS/MCCO. ENCASTRABLE SOUS PLAN
 АРМОИР ПОД ПОВЕРХНОСТЬЮ. ВИНС-МОДЕЛЬ ПОТРУБАЮЮЩИМЕРА
 ВИННЫЙ ТЕМПЕРАТУРНЫЙ ШКАФ

Klasse/Class Classe/Clase SN-ST	Ap-Typ/AP-Type AP-Tipo/AP-Tipo	Bruttinhalt/Gross Capacity Volume Brut/Capacità Bruta XXXX l	Gefriervermögen/Freezing Capacity Pouvoir de Congel/Capac. Congeladora
---------------------------------------	-----------------------------------	--	---

Netinhalt Net Capacity Volume Utile Capac. Util	Ges. / K / G Tot. / R / F To. / R / C Tot. / F / C	/ WEIN / KALT / WINE / CHILL / WINE / CHILL	R600a: XXg
--	---	---	-------------------

Warranty

For information on the appliance warranty specific to your country please contact Miele. See back cover for address.

In the UK, your appliance warranty is valid for 2 years from the date of purchase. However, you must activate your cover by calling 0330 160 6640 or registering online at www.miele.co.uk.

EU Conformity declaration

Miele hereby declares that this fridge-freezer complies with Directive 2014/53/EU. The complete text of the EU declaration of conformity is available from one of the following internet addresses:

- Products, Download from www.miele.ie
- For service, information, operating instructions etc: go to <https://miele.co.uk/> manuals and enter the name of the product or the serial number

Frequency band of the WiFi module	2.4000 GHz – 2.4835 GHz
Maximum transmitting power of the WiFi module	< 100 mW

UK Conformity declaration

Miele hereby declares that this fridge-freezer complies with UK Radio Equipment Regulations 2017, as amended.

The complete text of the UK declaration of conformity is available from one of the following internet addresses:

- Products, Download from www.miele.co.uk
- For service, information, operating instructions etc: go to <https://miele.co.uk/> manuals and enter the name of the product or the serial number

Frequency band of the WiFi module	2.4000 GHz – 2.4835 GHz
Maximum transmitting power of the WiFi module	< 100 mW

Information

This **Statement of Compliance** confirms this Miele product fully complies with the **Product Security and Telecommunications Infrastructure (Security Requirements for Relevant Connectable Products) Regulations 2023**.

- 1) Household Appliance – *Freezer - 120002, 120003, 320001, 320002*
Refrigerator - 110001, 110002, 310001, 310002, 310003
Fridge-freezer - 130001, 130002, 130003, 130004,
330001, 330002
Wine unit - 210007, 310004, 330004
- 2) Manufactured by: Miele & Cie KG,
Carl Miele Street 29, 33332 Gutersloh Germany
Imported by and contact point: Miele Company Ltd, Fairacres, Marcham Road,
Abingdon, Oxon, OX14 ITW Great Britain
- 3) The defined support period at the time of first supply is 10 years
- 4) To report vulnerabilities and cybersecurity issues please contact: psirt@miele.com
- 5) Signature 
Name: **Paul Wright**
Company Position: **Head of Technical Management**
Date of signature: **19th March 2024**
Place of signature: **Abingdon, Oxfordshire**

Copyrights and licences

For the purpose of operating and controlling the communication module, Miele uses proprietary or third-party software that is not covered by open source licensing terms. This software/these software components are protected by copyright. The copyrights held by Miele and third parties must be respected.

Furthermore, the communication module integrated in the appliance contains software components which are distributed under open source licence conditions. The open source components contained in the appliance along with the corresponding copyright notices, copies of the licensing terms valid at the time and any further information can be accessed locally by IP via a web browser ([http\[s\]://<IP address>/Licenses](http[s]://<IP address>/Licenses)). The liability and warranty arrangements for the open source licences displayed in this location only apply in relation to the respective rights holders.

United Kingdom

Miele Co. Ltd., Fairacres, Marcham Road, Abingdon, Oxon, OX14 1TW
Tel: 0330 160 6600, Internet: www.miele.co.uk, E-mail: info@miele.co.uk

Australia

Miele Australia Pty. Ltd.
ACN 005 635 398
ABN 96 005 635 398
Level 4, 141 Camberwell Road
Hawthorn East, VIC 3123
Tel: 1300 464 353
E-mail: info@miele.com.au
Internet: www.miele.com.au

China Mainland

Miele Electrical Appliances Co. Ltd.
No. 82, Shimenyi Road, JingAn District
Shanghai, China, P.R.C
Post Code: 200040
Phone: +86 21 6157 3500
Fax: +86 21 6157 3511
E-mail: info@miele.cn
Internet: www.miele.cn

Hong Kong, China

Miele (Hong Kong) Ltd.
41/F - 4101, Manhattan Place
23 Wang Tai Road
Kowloon Bay, Hong Kong
Tel: (852) 2610 1025
Fax: (852) 3579 1404
E-mail:
customerservices@miele.com.hk
Website: www.miele.hk

India

Miele India Pvt. Ltd.
1st Floor, Copia Corporate Suites,
Commercial Plot 9, Mathura Road,
Jasola, New Delhi - 110025
E-mail: customercare@miele.in
Website: www.miele.in

Ireland

Miele Ireland Ltd.
2024 Bianconi Avenue
Citywest Business Campus
Dublin 24
Tel: (01) 461 07 10
Tel: (01) 461 07 97
Fax: (01) 461 07 97
E-mail: info@miele.ie
Internet: www.miele.ie

Malaysia

Miele Sdn Bhd
Suite 12-2, Level 12
Menara Sapura Kencana
Petroleum
Solaris Dutamas No. 1
Jalan Dutamas 1
50480 Kuala Lumpur, Malaysia
Phone: +603-6209-0288
Fax: +603-6205-3768

New Zealand

Miele New Zealand Limited
IRD 98 463 631
8 College Hill
Freemans Bay, Auckland 1011
Tel: 0800 464 353
E-mail: customercare@miele.co.nz
Internet: www.miele.co.nz

Singapore

Miele Pte. Ltd.
29 Media Circle
#11-04 ALICE@Mediapolis
Singapore 138565
Tel: +65 6735 1191
Fax: +65 6735 1161
E-mail: info@miele.com.sg
Internet: www.miele.sg

South Africa

Miele (Pty) Ltd.
63 Peter Place, Bryanston 2194
P.O. Box 69434, Bryanston 2021
Tel: (011) 875 9000
Fax: (011) 875 9035
E-mail: info@miele.co.za
Internet: www.miele.co.za

Thailand

Miele Appliances Ltd.
BHIRAJ TOWER at EmQuartier
43rd Floor Unit 4301-4303
689 Sukhumvit Road
North Klongton Sub-District
Vadhana District
Bangkok 10110, Thailand

United Arab Emirates

Miele Appliances Ltd.
Showroom 1, Eiffel 1 Building
Sheikh Zayed Road, Umm Al Sheif
P.O. Box 114782 - Dubai
Tel. +971 4 3044 999
Fax. +971 4 3418 852
800-MIELE (64353)
E-mail: info@miele.ae
Website: www.miele.ae

Manufacturer: Miele & Cie. KG, Carl-Miele-Straße 29, 33332 Gütersloh, Germany

FNS 7794 ...

en-GB

M.-Nr. 12 583 980 / 04