

## Operating and installation instructions Cooker hood

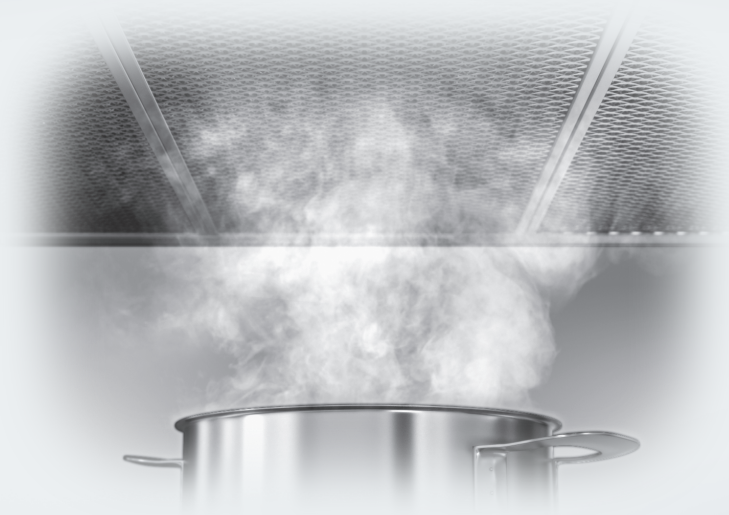

To prevent the risk of accidents or damage to the appliance, it is **essential** to read these instructions before it is installed and used for the first time.

# Contents

---

<b>Warnings and safety notes</b> .....	<b>4</b>
<b>Sustainability and environmental protection</b> .....	<b>11</b>
<b>Familiarisation</b> .....	<b>12</b>
Guide to the cooker hood .....	12
Components .....	13
Grease filters and panel .....	13
Charcoal filter .....	13
Hob lighting .....	13
Functions .....	14
Fan power levels .....	14
Run-on function .....	14
Operating hours counter .....	14
Miele@home .....	15
Con@ctivity .....	15
Power management .....	15
<b>Commissioning</b> .....	<b>16</b>
Selecting extraction mode or recirculation mode .....	16
Setting up Miele@home .....	17
Connecting via the app .....	17
Signing off WiFi and remote control .....	18
Setting up Con@ctivity .....	18
Activating Con@ctivity 3.0 via the home WiFi network .....	18
Activating Con@ctivity 3.0 via a direct WiFi connection .....	18
Reattempting the connection .....	19
Preparing the remote control .....	19
Signing on the remote control .....	19
Signing off the remote control .....	19
<b>Operation (automatic)</b> .....	<b>20</b>
Cooking with Con@ctivity over an electric hob .....	20
Cooking with Con@ctivity over a gas hob .....	20
Leaving automatic mode temporarily .....	21
<b>Operation (manual)</b> .....	<b>22</b>
Cooking without Con@ctivity (Manual mode) .....	22
Switching on the fan .....	22
Selecting the power level .....	22
Selecting the run-on time .....	22
Switching the fan off .....	22
Run-on in Plug&Play operation .....	22
Switching the hob lighting on/off .....	22

<b>Adjusting settings</b> .....	<b>23</b>
Intervals for the grease filter operating hours counter.....	23
Changing the intervals for the grease filter operating hours counter.....	23
Intervals for the charcoal filter operating hours counter .....	23
Altering or deactivating the charcoal filter operating hours counter intervals.	23
Safety switch-off.....	24
<b>Energy saving tips</b> .....	<b>25</b>
<b>Cleaning and care</b> .....	<b>26</b>
Cleaning the casing.....	26
Grease filters and panel for edge extraction .....	26
Condensation on the panel .....	27
Inserting the panel.....	29
Resetting the grease filter operating hours counter .....	29
Replacing the grease filters .....	29
Charcoal filter.....	29
Resetting the charcoal filter operating hours counter .....	30
Disposing of charcoal filters .....	30
Remote control .....	30
Inserting/replacing batteries .....	30
Cleaning the remote control .....	30
<b>Customer Service Department</b> .....	<b>31</b>
Contact in the event of a fault .....	31
Position of the data plate .....	31
Warranty .....	31
<b>Installation</b> .....	<b>32</b>
Before installation .....	32
Protective foil.....	32
Coating the panel .....	32
Installation materials.....	32
Appliance dimensions.....	33
Safety distance between hob and cooker hood (S) .....	38
Installation notes .....	39
Plug&Play mode .....	39
Connection for air extraction .....	40
Non-return flap.....	41
Condensation .....	41
Silencer .....	41
Electrical connection .....	42
<b>Technical data</b> .....	<b>43</b>
Optional accessories for recirculation mode.....	43
EU Conformity declaration.....	43
UK Conformity declaration .....	43

## Warnings and safety notes

---

This cooker hood complies with all relevant local and national safety requirements. Inappropriate use can, however, lead to personal injury and material damage.

Read the operating and installation instructions carefully before using the cooker hood. They contain important information on its safety, installation, use and maintenance. This prevents both personal injury and damage to the cooker hood.

In accordance with standard IEC 60335-1, Miele expressly and strongly advises that you read and follow the instructions in the chapter on installing the appliance as well as the safety instructions and warnings.

Miele cannot be held liable for injury or damage caused by non-compliance with these instructions.

Keep these instructions in a safe place and pass them on to any future owner.

### Correct application

- ▶ This cooker hood is intended for use in domestic households and similar working and residential environments.
- ▶ The cooker hood is not intended for outdoor use.
- ▶ It must only be used as a domestic appliance to extract vapours and remove odours from cooking.  
Any other usage is not supported by the manufacturer and could be dangerous.
- ▶ Where a recirculation cooker hood is fitted above a gas hob, please ensure that there is an adequate supply of fresh air into the room in which it is installed. Please seek the advice of a qualified gas fitter (e.g. GasSafe in the UK) for more information if necessary.
- ▶ The cooker hood can only be used by people with reduced physical, sensory or mental capabilities, or lack of experience and knowledge, if they are supervised whilst using it, or have been shown how to use it in a safe way and recognise and understand the consequences of incorrect operation.

### Safety with children

- ▶ Children under 8 years of age must be kept away from the cooker hood unless they are constantly supervised.
- ▶ Children aged 8 and older may only use the cooker hood without supervision if they have been shown how to use it and are able to do so in a safe manner. Children must be able to understand and recognise the possible dangers caused by incorrect operation.
- ▶ Children must not be allowed to clean or maintain the cooker hood unsupervised.
- ▶ Please supervise children in the vicinity of the cooker hood and do not let them play with it.
- ▶ The hob lighting is very intensive. Ensure, in particular, that babies/small children do not look at the light.
- ▶ Danger of suffocation! Whilst playing, children may become entangled in packaging material (such as plastic wrapping) or pull it over their head with the risk of suffocation. Keep packaging material away from children.
- ▶ Keep the battery for the remote control out of the reach of children.

### Technical safety

- ▶ Unauthorised installation, maintenance and repairs can cause considerable danger for the user. Installation, maintenance and repairs must only be carried out by a Miele authorised technician.
- ▶ A damaged appliance can be dangerous. Check it for visible signs of damage. Do not use a damaged appliance.
- ▶ The electrical safety of this appliance can only be guaranteed when correctly earthed. It is essential that this standard safety requirement is met. If in any doubt please have the electrical installation tested by a qualified electrician.
- ▶ Do not connect the appliance to the mains electricity supply by a multi-socket unit or an extension lead. These are a fire hazard and do not guarantee the required safety of the appliance.

## Warnings and safety notes

---

► Temporary or permanent operation on an autonomous power supply system or a power supply system that is not synchronised with the mains power supply (e.g. island networks, back-up systems) is possible. A prerequisite for operation is that the power supply system complies with the specifications of EN 50160 or an equivalent standard.

The function and operation of the protective measures provided in the domestic electrical installation and in this Miele product must also be maintained in isolated operation or in operation that is not synchronised with the mains power supply, or these measures must be replaced by equivalent measures in the installation. As described, for example, in the current version of BS OHSAS 18001–2 ISO 45001.

► The connection data (voltage and frequency) on the data plate of the cooker hood must match the mains electricity supply in order to avoid the risk of damage to the cooker hood

Compare this before connecting the appliance to the mains. Consult a qualified electrician if in any doubt.

► For safety reasons, this appliance may only be used after it has been built in.

► The cooker hood must not be used in a non-stationary location (e.g. on a ship).

► Touching electrical components and tampering with electrical and mechanical parts is highly dangerous to the user and can cause operational faults.

Only open the housing as described in the instructions given in the installation sheet and in the Cleaning and care section of this booklet. Under no circumstances should any other parts of the housing be opened.

► During installation, maintenance and repair work, the appliance must be disconnected from the mains electricity supply.

► The manufacturer's warranty will be invalidated if the appliance is not repaired by a Miele authorised technician.

► If the electrical connection cable is faulty it must only be replaced by a Miele authorised technician to protect the user from danger.

► The lamps are a built-in component of the lighting. Replacement lamps may only be fitted by a Miele authorised technician or by the Miele Customer Service Department.

## Warnings and safety notes

Using at the same time as another heating appliance that depends on the air from the room

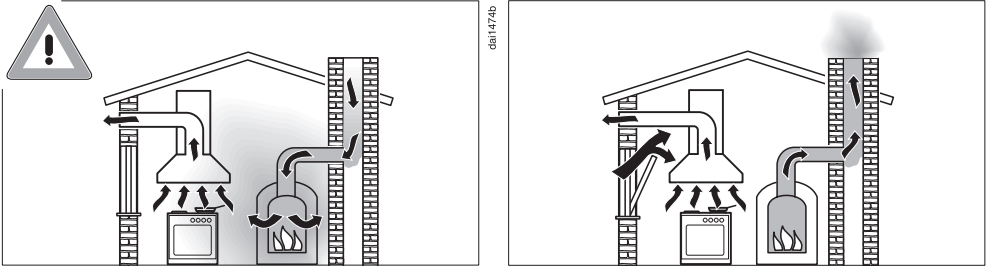

### ⚠ Danger of toxic fumes!

Great care should be taken when using the cooker hood in the same room or the same area of the house at the same time as another heating appliance that depends on the air from the room. Such heating appliances draw in air from the room and duct exhaust gases out through a chimney or extraction ducting. They include gas, oil, wood and coal-fired boilers and heaters, continuous flow or other water heaters, gas hobs and ovens.

The cooker hood draws in air from the kitchen and from neighbouring rooms. This applies to the following modes of operation:

- Extraction mode
- Recirculation mode with a recirculation box installed outside the room.

If there is insufficient air, negative pressure will occur. The heating appliance may be starved of oxygen. This impairs combustion. Harmful gases could be drawn from the chimney or extraction ducting back into the room.

Risk of death!

## Warnings and safety notes

---

In order to ensure safe operation and to prevent gases given off by the heating appliance from being drawn back into the room when the cooker hood and the heater are both operated simultaneously, an underpressure in the room of 0.04 mbar (4 Pa) is the maximum permissible.

Sufficient ventilation can be maintained by air inlets which cannot be blocked, e.g. in windows, doors and outside wall vents. The cross-section of the inlet openings must enable sufficient ventilation. A ventilation brick alone is not generally sufficient to ensure safe ventilation.

The overall ventilation condition of the dwelling must be taken into account. If in any doubt, ask a competent building regulations inspector or qualified gas fitter (if appropriate).

If the cooker hood is being operated in recirculation mode, whereby the air is redirected into the room in which it is installed, the above restrictions do not apply.

- ▶ Important information on handling the remote control battery:
  - Do not short circuit or recharge the battery, or throw it into a fire. Danger of explosion.
  - Do not throw old batteries away with your general household waste. Please dispose of them in a designated battery collection and recycling system.
  - Used batteries must be kept away from children while awaiting disposal and must be disposed of in a safe manner.

### Correct use

- ▶ Open flames are a fire hazard.

The use of an open flame under the cooker hood is not permitted. To avoid the danger of fire, do not flambé or grill over an open flame. When switched on, the cooker hood could draw flames into the filter. Fat deposits could ignite, presenting a fire hazard.
- ▶ Overheated oil and fat can ignite, causing fire damage to the cooker hood.

When cooking with oil or fat, chip pans and deep fat fryers, etc, do not leave the pans unattended. Similarly, never leave an open grill unattended when grilling.



## Warnings and safety notes

---

- ▶ The cooker hood can become damaged when exposed to excessive heat.
  - When using the cooker hood over a gas hob, ensure that any burners in use are always covered by a pan. Switch the cooking zone off when a pan is removed, even for a short time.
  - Select a pan which is suitable for the size of the burner.
  - Regulate the flame so that it does not burn up the sides of the pan.
  - Avoid overheating the pan (e.g. when cooking with a wok).
- ▶ Always switch the cooker hood on when a cooking zone is in use, otherwise condensation may collect in the hood, which could cause corrosion.
- ▶ Do not use the cooker hood without the filters in place. This way you will avoid the risk of grease and dirt getting into the appliance and hindering its smooth operation.
- ▶ There is a risk of fire if the cooker hood is not cleaned as described in these operating instructions.
- ▶ The cooker hood can get very hot during cooking due to heat rising from the hob.  
Do not touch the housing or the grease filters until the cooker hood has cooled down.

### Proper installation

- ▶ To determine whether a cooker hood may be operated above your cooking appliance, please refer to the information provided by the appliance's manufacturer.
- ▶ The information provided in "Installation" must be observed when fixing the ventilation hood.
- ▶ Safety regulations prohibit the fitting of a cooker hood over solid fuel stoves.
- ▶ An insufficient safety distance between the hob and the cooker hood can result in damage to the cooker hood.  
The minimum safety distances between the top of the hob and the bottom of the cooker hood given in the "Installation" section of this manual must be observed, unless the hob manufacturer states that a greater safety distance is required.  
If more than one cooking appliance is fitted beneath the cooker hood, and they have different minimum safety distances to the cooker hood, select the greater distance.

## Warnings and safety notes

---

- ▶ Components can have sharp edges which may cause injury. Wear gloves to protect your hands from being cut.
- ▶ Exhaust ducting must be of non-inflammable material. Suitable material is available from Miele specialist dealers or the Miele Spares Dept.
- ▶ The appliance must not be connected to a chimney or flue which is in use. Neither should it be connected to ducting which ventilates rooms with fireplaces.
- ▶ If exhaust air is to be extracted into a chimney or ventilation duct no longer used for other purposes, seek professional advice.

### Cleaning and care

- ▶ Do not use a steam cleaning appliance to clean this appliance. The steam could reach electrical components and cause a short circuit.

### Accessories and spare parts

- ▶ Only use genuine original Miele accessories and spare parts with this appliance. Using accessories or spare parts from other manufacturers will invalidate the warranty and Miele cannot accept liability.
- ▶ Miele can only guarantee the safety of the appliance when genuine original Miele replacement parts are used. Faulty components must only be replaced by Miele spare parts.
- ▶ Miele will guarantee to supply functional spare parts for a minimum of 10 years and up to 15 years following the discontinuation of your vapour extraction unit.

## Disposing of the packaging material

The packaging material is used for handling and protects the appliance from transport damage. The packaging material used is selected from materials which are environmentally friendly for disposal and can generally be recycled.

Recycling the packaging material reduces the use of raw materials. Use material-specific collection points for valuable materials and take advantage of return options. Your Miele dealer will take the packaging material away.

## Disposing of your old appliance

Electrical and electronic appliances contain many valuable materials. They also contain certain materials, compounds and components which were essential for their correct functioning and safety. These could be hazardous to human health and to the environment if disposed of with household waste or if handled incorrectly. Please do not, therefore, dispose of your old appliance with household waste.



Instead, please make use of officially designated collection and disposal points to dispose of and recycle electrical and electronic appliances in your local community, with your dealer or with Miele, free of charge. By law, you are solely responsible for deleting any personal data from the old appliance prior to disposal. You are legally obliged to remove any old batteries which are not securely enclosed by the appliance and to remove any lamps without

destroying them, where this is possible. These must be taken to a suitable collection point where they can be handed in free of charge. Please ensure that your old appliance poses no risk to children while being stored for disposal.

## Disposing of old batteries

In many cases, electrical and electronic appliances contain batteries which must not be disposed of with household waste after use. You are legally obliged to remove any old batteries which are not securely enclosed by the appliance and take them to a suitable collection point (e.g. retailer) where they can be handed in free of charge. Insulate the metal contacts with adhesive tape to prevent short circuits. Batteries may contain substances which can be hazardous to human health and the environment.

The labelling on the battery will provide further information. For example, batteries containing lithium are marked "Li-ion". The bin symbol with a cross through it means that the batteries must not be disposed of in household waste. We are also required to inform you that a bin with a cross through it which also has one or more chemical symbols on it indicates that the battery contains lead (Pb), cadmium (Cd) and/or mercury (Hg).



Old batteries contain valuable raw materials which can be recycled. Disposing of batteries separately makes them easier to handle and recycle.

# Familiarisation

## Guide to the cooker hood

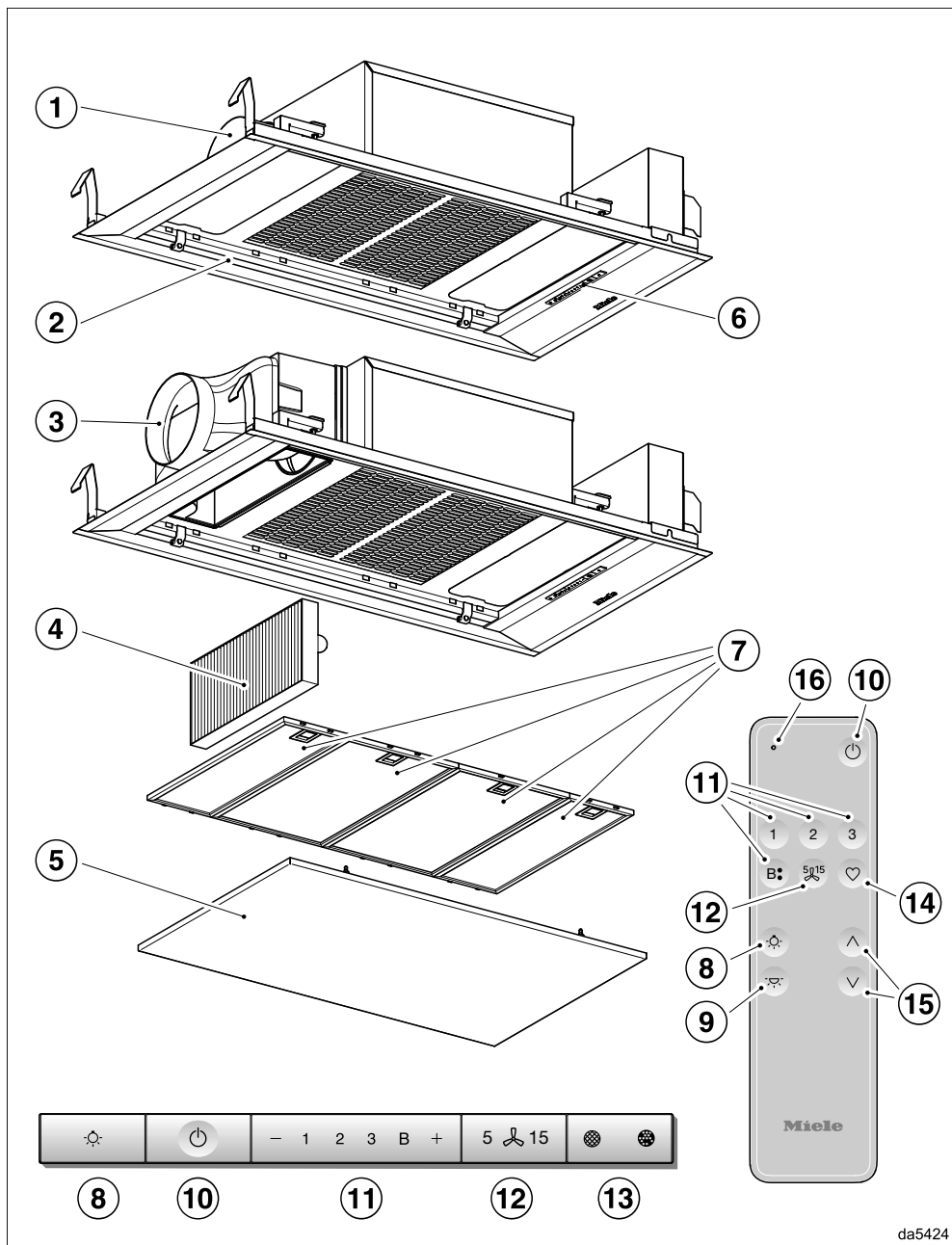

da5424

- ① Exhaust duct  
Exhaust air can be directed to the left-hand side, to the rear or to the front.
- ② Hob lighting
- ③ Ventilation grille for recirculation mode
- ④ Charcoal filter  
Disposable or reactivatable charcoal filter  
Optional accessory for recirculation mode
- ⑤ Edge extraction panel
- ⑥ Control elements
- ⑦ Grease filters
- ⑧ Control for switching the lighting on and off
- ⑨ Inoperative control
- ⑩ Control for switching the fan on and off
- ⑪ Controls for setting the fan power level
- ⑫ Control for the run-on function
- ⑬ Control for the operating hours counter
- ⑭ Inoperative control
- ⑮ Inoperative controls
- ⑯ Indicator light

## Components

### Grease filters and panel

The edge extraction panel and the reusable metal grease filters in the appliance remove solid particles (grease, dust, etc.) from the kitchen vapours, preventing soiling of the cooker hood.



Risk of fire

Oversaturated grease filters are a fire hazard.

Clean the grease filters at regular intervals.

Heavily soiled grease filters hinder the extraction power and will lead to increased levels of soiling in the cooker hood and in the kitchen.

### Charcoal filter

With recirculation mode and Plug&Play recirculation mode, a charcoal filter must be fitted in addition to the grease filters. The charcoal filter is designed to absorb cooking odours.

It is available as an optional accessory. There are charcoal filters available that need to be replaced at the end of their service life and others that can be reactivated.

### Hob lighting

The hob lighting can be switched on and off independently of the fan.

# Familiarisation

---

## Functions

### Extraction mode



The air is drawn in and cleaned by the grease filters and directed outside.

### Recirculation mode

A charcoal filter is required. Please purchase separately. See “Technical data”.



The air is drawn in and cleaned first by the grease filters and then by a charcoal filter. The cleaned air is then recirculated back into the kitchen.

### Plug&Play recirculation mode

The air is drawn in and cleaned first by the grease filters and then by a charcoal filter. Without an air duct through the ceiling, the air is then circulated back into the kitchen. Please follow the instructions in “Installation”.

### Fan power levels

Select power levels **1** to **3** for light to heavy cooking vapours, odours or heat.

Increase the power level as the level of vapours, odours or heat increases.

For short periods of cooking food with intensive vapours, odours or heat, e.g. when searing meat, select Booster level **B**. The fan will automatically switch back from the Booster level after 5 minutes.

### Run-on function

The run-on function enables the fan to continue running for a pre-determined time before switching itself off automatically.

This helps to remove any lingering vapours and odours from the air after cooking. It also reduces the risk of residues accumulating in the cooker hood and any resultant odours.

### Operating hours counter

The cooker hood registers the length of time for which it has been operated.

When the grease filter symbol  lights up, the grease filters must be cleaned.

When the charcoal filter symbol  lights up, the charcoal filter must be replaced or reactivated (if suitable for reactivating).

You can set the operating hours counter intervals to suit the type of cooking you do.

Deactivate the operating hours counter for the charcoal filter if you are operating the cooker hood in extraction mode.

dsl0094a

dsl0494b

## **Miele@home**

You can connect the cooker hood to your home WiFi network and operate it using the Miele app on your mobile device.

If your Miele hob is also connected to your WiFi network, the Con@ctivity function will be activated automatically.

## **Con@ctivity**

With the Con@ctivity function, the cooker hood is automatically controlled in conjunction with the hob. The cooker hood and Miele hob must be connected to the home WiFi network or have a direct WiFi connection.

The cooker hood can also be operated manually at any time during automatic operation.

## **Power management**

The cooker hood is fitted with a power management system. Power management helps to save energy. It ensures that the fan power level is reduced automatically and that the lighting is switched off.

- If the Booster setting has been selected, the fan will automatically switch to level 3 after 5 minutes.
- From fan power levels 3, 2 or 1, the power will be reduced by one level after 2 hours and then in 30-minute stages until the fan finally switches off.
- The hob lighting will switch off automatically after 12 hours.

# Commissioning

Settings are made via the cooker hood control panel, not via the remote control.

## Selecting extraction mode or recirculation mode

The cooker hood is suitable for both extraction mode and recirculation mode. The power of the fan is adapted to suit the selected operating mode. The cooker hood is delivered set up for recirculation mode. It has to be reset for extraction mode.

To reset it for extraction mode, the operating hours counter for the charcoal filter(s) has to be deactivated.

- Switch off the fan and the lighting.
- Press the + control and the operating hours control  at the same time.

The charcoal filter symbol  and one of the fan power levels will flash.



- Press and hold the + control until the **B** indicator starts to flash.
- Confirm your choice with the operating hours control .

All the indicator lights will go out.

Extraction mode has now been set.

If you do not confirm your selection within 4 minutes, the cooker hood will automatically revert to the original setting.

## Activating/deactivating Plug&Play

- Switch off the fan and the lighting.
- Press the run-on control <sup>5</sup> for approx. 10 seconds until **1** lights up.
- Then press in turn:
  - The — control
  - The lighting control  and
  - The lighting control  again

When Plug&Play is deactivated, **1** and **3** will flash.

When Plug&Play is activated, **1** and **3** will light up constantly.

- Press the + control to activate Power Management.
  - 1** and **3** will light up constantly.
- To deactivate it, press the — control.
  - 1** and **3** will flash.
- Confirm the setting with the run-on control <sup>5</sup>.

All the lights will go out.



## Setting up Miele@home

### Requirements:

- A WiFi network
- The Miele app
- A Miele user account You can create a user account via the Miele app.

Before installing the cooker hood in its final location, ensure that the signal of your WiFi network is strong enough.

### Miele@home availability

The ability to use the Miele app depends on the availability of the Miele@home service in your country.

The Miele@home service is not available in every country.

For information about availability, please visit [www.miele.com](http://www.miele.com).

### Miele App

The Miele App is available to download free of charge from the Apple App Store® or from the Google Play Store™.



### Connecting via the app

The Miele app can be used to connect to your network.

- Install the Miele app on your mobile device.

For the registration, you will need:

1. Your WiFi network password
2. Your cooker hood password



The password for your cooker hood consists of the last 9 digits of the serial number. This can be found on the appliance's data plate.

The data plate is visible after removing the grease filter(s).

- Follow the instructions to start registering the appliance in the app.

If requested to activate WiFi on the cooker hood, proceed as follows:

- Switch the cooker hood off.
- Press and hold the + control.
- Press the lighting control  at the same time.

**2** will light up constantly, **3** will flash.

The cooker hood will be ready for connection for the next 10 minutes.

- Follow the instructions in the app.

When successfully connected, **2** and **3** will light up constantly.

- Confirm the setting with the run-on control .

The cooker hood can now be operated via the app.

If it is not possible to connect, **2** and **3** flash or the process is cancelled.

- Repeat the process.

# Commissioning

## Signing off WiFi and remote control

To set up a new WiFi connection or a connection with a remote control, the existing connections must be disconnected first.

The sign-off process will always sign off the WiFi and a connected remote control at the same time.

- Switch the cooker hood off.
- Press and hold the — control.
- Touch the lighting control  at the same time.



If a WiFi connection exists, **2** and **3** will light up constantly.

If a remote control is signed on, **B** will also light up.

- Touch the — control.

**2** will light up constantly, **3** will flash.

After a few seconds, **2** and **3** will flash. The connection has now been disconnected.

- Quit signing-off mode on the cooker hood by pressing the run-on control <sup>5</sup>.
- Press the **B** and  controls on the remote control at the same time.

All connections have been disconnected. You can establish a new connection.

## Setting up Con@ctivity

### Activating Con@ctivity 3.0 via the home WiFi network

Requirements:

- Home WiFi network
- WiFi-enabled Miele hob

- Connect the cooker hood and hob to your home WiFi network (see “Setting up Miele@home”).

The Con@ctivity function will be activated automatically.

### Activating Con@ctivity 3.0 via a direct WiFi connection

Rather than connecting to the home network, you can establish a direct connection between the hob and the cooker hood.

Requirements:

- WiFi-enabled Miele hob

- Switch the cooker hood off.
- Press and hold the + control.
- Press the — control at the same time.

**2** will light up constantly, **3** will flash.

The cooker hood will be ready for connection for the next 2 minutes.

- Start the WiFi connection on the hob. For further details, see the hob operating instructions.

When successfully connected, **2** and **3** will light up constantly.

- Quit connection mode on the cooker hood by pressing the run-on control <sup>5</sup>.

Con@ctivity is now activated.

With a direct WiFi connection, it is not possible to connect the hob and the cooker hood to a home network. Should this be required at a later date, the WiFi connection between the hob and the cooker hood must be disconnected (see “Signing off WiFi”).

## Reattempting the connection

If it is not possible to connect, **2** and **3** flash or the cooker hood cancels the process.

- Disconnect the connection to the cooker hood (see “Signing off WiFi”) **and** to the hob.
- Attempt to make the connection again.

## Preparing the remote control

- Insert the batteries into the remote control, see “Cleaning and care – Inserting/replacing batteries”.

## Signing on the remote control

- Press and hold the **+** control on the cooker hood for approx. 10 seconds.

**2** will light up constantly, **3** will flash.

- Press the **1** and **3** controls on the remote control at the same time until the indicator starts flashing red.

The sign-on process starts.

The indicator light will briefly flash green if the sign-on process is successful.

**2** and **3** will light up constantly on the cooker hood.

- Confirm the setting on the cooker hood with the run-on control <sup>5</sup>↵<sup>15</sup>.

If the sign-on process was not successful, **2** and **3** will flash.

- In this case, repeat the process.

## Signing off the remote control

- For information about the sign-off process, see “Commissioning – Signing off WiFi and remote control”.

# Operation (automatic)

## Cooking with Con@ctivity over an electric hob

- Switch a cooking zone on at the desired power level.

The hob lighting will come on.

After a few seconds the fan will come on, first at power level **2**, then it will switch immediately to power level **1**.

The cooker hood selects the required fan power level automatically during cooking. The power level selected by the cooker hood depends on the number of cooking zones being used and their power levels.

The cooker hood responds with a delay. This takes into account the fact that changing the power level at the hob does not increase or decrease the cooking vapours straight away.

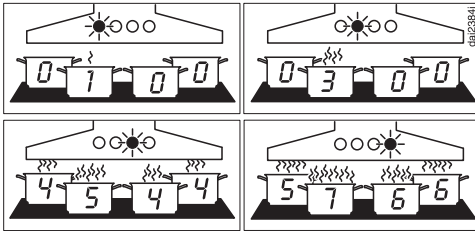

Examples for power levels **1** to **B**

- Switch off all cooking zones after cooking.

The cooker hood fan will reduce its power level in stages over the next few minutes and will then switch itself off.

This helps to neutralise any lingering vapours and odours in the air.

After another 30 seconds, the hob lighting switches off.

## Frying with Con@ctivity

- For example, you switch on a cooking zone at the highest power level to heat cookware for frying. You reduce the power level after approx. 10 seconds to 4 minutes (60 seconds to 5 minutes for a HiLight hob).

The cooker hood recognises a frying process.

The cooker hood switches itself on and when the hob power level has been reduced, the hood switches to fan power level 3 and remains at that level for approx. 5 minutes.

After that, the cooker hood power level is determined automatically by the Con@ctivity function.

You can select another power level manually before then.

## Cooking with Con@ctivity over a gas hob

- Switch a cooking zone on at the desired power level.

The hob lighting will come on.

After a few seconds, the fan will come on at power level **2**.

Regardless of the selected cooking level, the fan remains at power level **2**.

- Switch off all cooking zones after cooking.

The run-on function is activated. The **5** on the run-on control <sup>5</sup>15 will light up.

After 5 minutes, the fan and the hob lighting will switch off.

This helps to neutralise any lingering vapours and odours in the air.

## Leaving automatic mode temporarily

To leave automatic mode temporarily:

- Manually select a different fan power level, or
- Manually switch the cooker hood off, or
- Activate the run-on function <sup>5g15</sup>, or
- Operate the hob lighting (only in combination with a gas hob)

If you switch off the fan manually in Plug&Play mode, it continues to run at level 1 (see “Operation (Manual mode)” – “Switching off the fan”).

## Returning to automatic mode

In combination with an electric hob:

- If the cooker hood has not been used for approx. 5 minutes after selecting a fan power level manually, or
- If the manually selected fan power level corresponds to the automatic one again, or
- The cooker hood fan and the hob have been switched off for at least 30 seconds.  
Automatic mode will resume the next time the hob is switched on.

In combination with a gas hob:

- The cooker hood fan and the hob have been switched off for at least 30 seconds.  
Automatic mode will resume the next time the hob is switched on.

## Leaving automatic mode for the entire cooking process

- Switch the fan on **before** the hob.

Con@ctivity is deactivated until the cooker hood is switched off.

If the cooker hood fan and the hob have been switched off for at least 30 seconds after cooking, automatic mode will resume next time the hob is switched on.

# Operation (manual)

---

## Cooking without Con@ctivity (Manual mode)

The cooker hood can be operated manually if:

- The Con@ctivity function is not activated.
- You have temporarily deactivated the Con@ctivity function (see “Operation (Manual operation)” – “Leaving automatic mode temporarily”).

## Switching on the fan

- Press the On/Off switch .

The fan will come on at power level **2**.





## Selecting the power level

- Use the **-** and **+** controls on the cooker hood or the **1**, **2**, **3** and **B** controls on the remote control to select the power level required.

## Reducing power down from the Booster level

The fan automatically switches back to power level **3** after 5 minutes.

## Selecting the run-on time

- After you have finished cooking, press the run-on control  while the fan is still running:
  - Once: the fan will switch itself off after 5 minutes (.
  - Twice: the fan will switch itself off after 15 minutes (.
  - If you touch the run-on control  again, the fan will remain on ( will go out).

## Switching the fan off

- Press the On/Off control  to switch the fan off.

The  symbol will go out.

## Run-on in Plug&Play operation

If you switch off the fan in Plug&Play mode, it will run on at level **1**.

Run-on ensures that the ceiling is ventilated after cooking.

Depending on the last active fan level, run-on lasts between 2 and 30 minutes.

You can switch off the fan immediately during run-on by pressing **1** or the On/Off switch .

This function is independent of the run-on function .

## Switching the hob lighting on/off

- Press the lighting control  to switch it on or off.



Settings are made via the cooker hood control panel, not via the remote control.

## Intervals for the grease filter operating hours counter

The factory default setting is a cleaning interval of 30 hours.

- Select a shorter interval of 20 hours if you fry food regularly.
- A shorter cleaning interval is also recommended if you only cook occasionally. This is to prevent grease hardening on the filter(s) and making cleaning more difficult.
- Select a longer interval of 40 or 50 hours if you use very little fat for cooking.

## Changing the intervals for the grease filter operating hours counter

- Switch off the fan and the lighting.
- Press the run-on control  and the operating hours control  at the same time.

The grease filter symbol  and one of the fan power level indicators will flash.

Fan power level indicators **1** to **B** show the time set:

Indicator <b>1</b> .....	20 hours
Indicator <b>2</b> .....	30 hours
Indicator <b>3</b> .....	40 hours
Indicator <b>B</b> .....	50 hours

- Press the **-** control for a shorter operating time, or **+** for a longer operating time.
- Confirm your choice with the operating hours control .

All the lights will go out.

If you do not confirm your selection within 4 minutes, the cooker hood will automatically revert to the original setting.

## Intervals for the charcoal filter operating hours counter

The factory default setting is an interval of 180 hours.

- If you frequently cook dishes with strong odours, we recommend shortening the interval to 120 hours.
- If you rarely cook dishes with strong odours, you can extend the interval to 240 hours.

## Altering or deactivating the charcoal filter operating hours counter intervals

- Switch off the fan and the lighting.
- Press the **+** control and the operating hours control  at the same time.

The charcoal filter symbol  and one of the fan power levels will flash.

Fan power level indicators **1** to **B** show the time set:

Indicator <b>1</b> .....	120 hours
Indicator <b>2</b> .....	180 hours
Indicator <b>3</b> .....	240 hours
Indicator <b>B</b> .....	deactivated

- Select the duration you want with the **+** or **-** control.
- Confirm your choice with the operating hours control .

All the indicator lights will go out.



If you do not confirm your selection within 4 minutes, the cooker hood will automatically revert to the original setting.

# Adjusting settings

---

## Activating/deactivating power management

Keep in mind that deactivating this function may increase energy consumption.

- Switch off the fan and the lighting.
- Press the run-on control  for approx. 10 seconds until **1** lights up.
- Then press in turn:
  - The lighting control 
  - The — control, and then
  - The lighting control  again



When power management is activated, **1** and **B** light up constantly.

When it is deactivated, **1** and **B** flash.

- Press the — control to deactivate Power Management.  
**1** and **B** will flash.
- Press the + control to activate Power Management.  
**1** and **B** will light up constantly.
- Confirm the setting with the run-on control .

## Safety switch-off

If Power management has been deactivated, the cooker hood will switch itself off automatically after 12 hours if it has been left on (fan and hob lighting).

- To switch it on again press the On/Off  control or the lighting control .





This cooker hood operates very efficiently and economically. The following will help you to save even more energy when using it:

- Ensure that there is sufficient ventilation in the kitchen when cooking. In extraction mode, if there is insufficient air flow the cooker hood cannot operate efficiently and this causes increased operating noise levels.
- Always cook with the lowest possible setting. This produces fewer cooking vapours, so you can use a lower cooker hood power level and therefore benefit from reduced energy consumption.
- Clean or change the filters at regular intervals. Heavily soiled filters reduce performance, increase the risk of fire and are unhygienic.
- Use the Con@ctivity function. The cooker hood will switch on and off automatically at the optimum power level for the cooking you are doing, which ensures low energy consumption.
- If you are operating the cooker hood manually, please note the following:
  - Check the power level selected on the cooker hood. A low power level is usually sufficient. Only use the Booster setting when necessary.
  - When a large volume of cooking vapours are being produced, switch to a high power level in good time. This is more efficient than operating the cooker hood for longer to try to capture cooking vapours which have already been distributed throughout the kitchen.
  - Make sure that you switch the cooker hood off after use. If cooking vapours and odours still need to be removed from the kitchen air after cooking, use the run-on function. The fan will switch off automatically after the selected run-on time.

## Cleaning and care

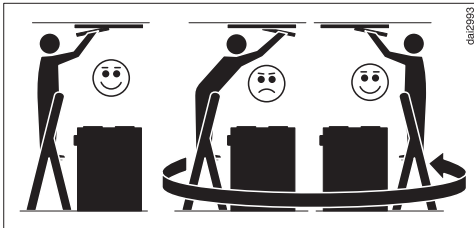
 Before proceeding with any maintenance or cleaning task, the cooker hood must be disconnected from the power supply (see “Warning and Safety instructions”).



 When cleaning the cooker hood, please note the following:  
Use a stable ladder.  
Make sure that you have a secure footing on the ladder.  
Do not lean over the hob.  
Do not stand on the worktop or the hob.

### Cleaning the casing

- Clean all surfaces and control elements with a sponge cloth and a solution of warm water and washing-up liquid.
- Remove the grease filters and clean any grease residues from the accessible parts of the casing. Doing so will prevent a fire hazard.
- After cleaning, wipe the surfaces dry using a soft cloth.
- In addition, stainless steel surfaces can be cleaned using a non-abrasive stainless steel cleaner (not suitable for the controls).  
To prevent the surfaces from quickly becoming dirty again, we recommend treating them with a stainless steel care product (available from Miele).

### Important information on cleaning the casing

Unsuitable cleaning agents can damage the surfaces.

Do not use any of the following cleaning agents:

- Cleaning agents containing soda, acids, chlorides or solvents
- Abrasive cleaning agents, e.g. powder cleaners or cream cleaners and abrasive sponges, as well as pot scourers or sponges which have been used previously with abrasive cleaning agents

Minor scratches on the surface are inevitable when cleaning coloured parts of the casing; they may be visible depending on the lighting in the kitchen.

### Grease filters and panel for edge extraction

#### Cleaning interval for grease filters and panel

After a preset operating time, the grease filter symbol  will light up to remind you to clean the grease filters and the panel.

Clean the grease filters and the panel every 3 to 4 weeks at the latest, even if the grease filter symbol  has not lit up yet. Accumulated grease solidifies over a longer period of time and makes cleaning more difficult.

## Condensation on the panel

Condensation is forming on the panel during cooking and evaporating once cooking is complete. Wait approximately 2 hours after finishing cooking before removing the panel. This will allow time for the condensation to evaporate and avoid dripping water.

## Removing the panel and grease filters

**!** If the panel or a grease filter falls down, this can result in damage. Make sure you hold the panel and filters securely at all times when handling them.

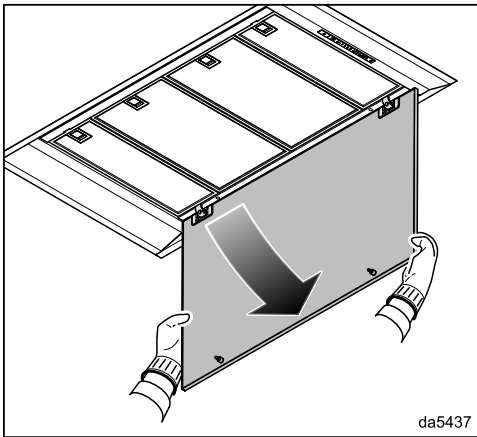

- Pull the front edge of the panel down out of the locking clips and lower it.

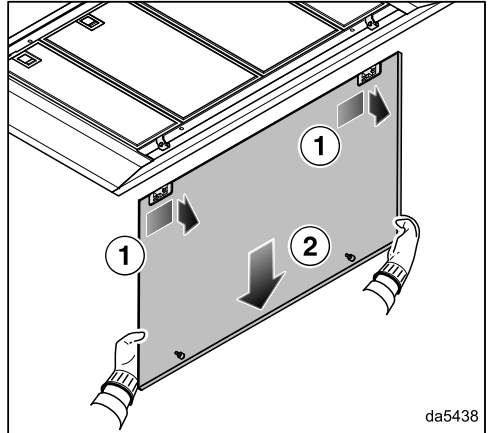

- Push the panel slightly to the right, then remove it by pulling it out to the rear.

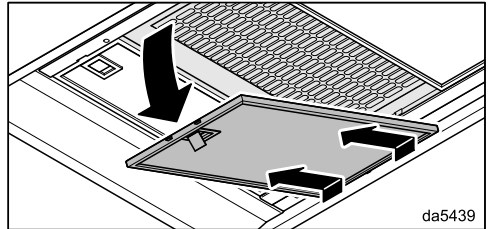

- Release the locking clip on the grease filter and lower the filter by approx. 45°. Unhook the grease filter and remove it.

## Cleaning the panel

- For cleaning purposes, follow the instructions provided under “Cleaning the casing”.

# Cleaning and care

## Cleaning the grease filters by hand

- Clean the grease filters with a soft nylon brush in a mild solution of hot water and a little washing-up liquid. Do not use concentrated washing-up liquid.
- After cleaning, leave the filters to dry on an absorbent surface before replacing them.

## Important information on cleaning by hand

Unsuitable cleaning agents may damage the filter surfaces if used regularly.

Do not use any of the following cleaning agents:

- Cleaning agents containing descaling agents
- Powder cleaners and cream cleaners
- Aggressive all-purpose cleaners and degreasing sprays
- Oven spray

## Cleaning the grease filters in the dishwasher

- Place the grease filters upright or at a slight angle in the lower basket. Ensure the spray arm is not obstructed.
- Use a standard household cleaning agent.
- Select a programme with a maximum wash temperature of 65 °C.

## Important information on cleaning in a dishwasher

Excessively high temperatures may cause the grease filters to become unusable, if they become deformed, for example. Select a programme that does not exceed the recommended temperature.

Also follow the information provided in the operating instructions for the dishwasher.

Depending on the cleaning agent used, the internal filter surfaces may become discoloured. This will not affect the functioning of the grease filters in any way.

## Fitting the grease filters

- Insert the grease filters. When inserting the grease filters, make sure that the locking clip faces outwards.

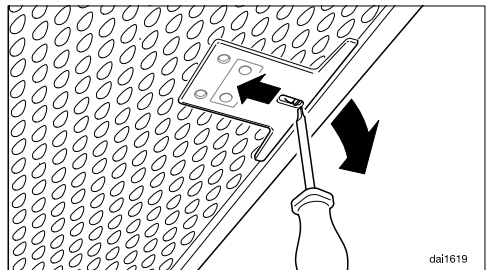

- If the grease filters were inadvertently fitted upside down, insert a small screwdriver blade into the slit to disengage the clip.

## Inserting the panel

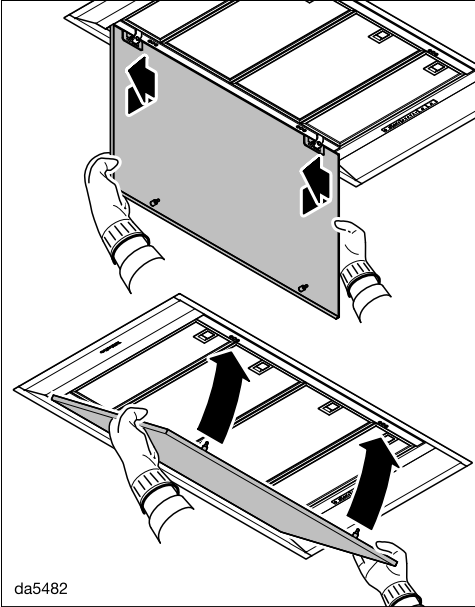

da5482

- Hook the panel into the hinges from behind and slide the panel to the left.
- Lift the panel upwards and press it into the locking clips.

## Resetting the grease filter operating hours counter

After cleaning, the operating hours counter needs to be reset via the controls on the cooker hood.

- With the fan switched on, press the operating hours control  for approximately 3 seconds until only **1** is flashing.

The grease filter symbol  goes out.

If you want to clean the grease filters before the operating hours counter has reached its maximum:

- Press the operating hours control  for approximately 6 seconds until only **1** is flashing.

## Replacing the grease filters

Regular usage and cleaning can cause the filter surfaces to become worn or brittle.

If you identify any damage, replace the grease filters.

Grease filters are available to order via the Miele Customer Service Department (see end of these operating instructions for contact details) or from your Miele dealer.

## Charcoal filter

### Replacement interval for the charcoal filter

Replace the charcoal filter when it no longer absorbs kitchen odours effectively.

After an operating time of 180 hours, the charcoal filter symbol  will light up to remind you to replace the charcoal filter.

We recommend replacing the charcoal filter after 6 months at the latest.

### Reactivation interval for the charcoal filter

If you are using a reactivatable charcoal filter (Miele DKF ...-R), the reactivation interval is the same as the replacement interval (see "Replacement interval for the charcoal filter").

Please refer to the charcoal filter operating instructions for information on reactivation.

### Fitting/replacing charcoal filters

- Remove the panel and the grease filters.
- Take the charcoal filter out of its packaging.

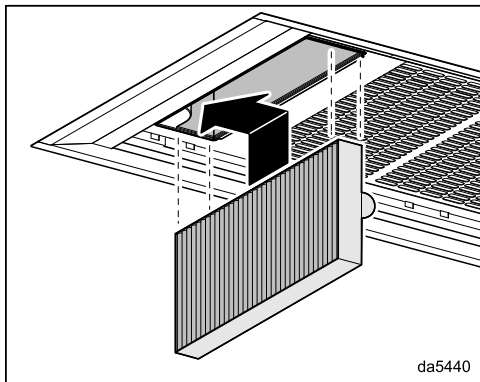

## Cleaning and care





- Insert the charcoal filter in its compartment and push it to the left into the holder.
- Refit the grease filters and the panel.

### Resetting the charcoal filter operating hours counter

After changing or reactivating the charcoal filter, the operating hours counter needs to be reset.

- To do this, with the fan switched on, press the operating hours control   twice, then hold it for approx. 3 seconds, until only **1** is flashing.

The charcoal filter symbol  will go out. If you want to replace the charcoal filter **before** the operating hours counter has reached its maximum:

- Press the operating hours control   twice and hold it for approximately 6 seconds until only **1** is flashing.

### Disposing of charcoal filters

- Used charcoal filters can be disposed of with normal household waste.

## Remote control

### Inserting/replacing batteries

The remote control requires 2 batteries, 1.5 V, type AAA. The batteries are supplied with the remote control and must be inserted before using for the first time.

The batteries must be replaced if cooker hood functions can no longer be selected using the remote control. The indicator light on the remote control no longer lights up or only lights up weakly when a button is pressed. Cooker hood functions can still be selected using the controls on the cooker hood.

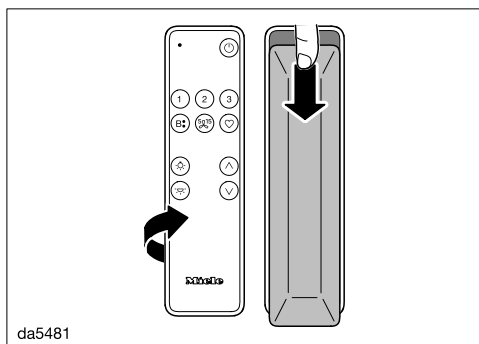

- Slide the cover on the back down slightly and remove it.
- Insert the batteries. Make sure the polarity is correct.
- Refit the cover and slide it upwards.

### Cleaning the remote control

- The surface should **only** be wiped with a damp cloth. Do not use too much water to prevent moisture getting into the housing.

# Customer Service Department

---

Information to help you rectify faults yourself and about Miele spare parts can be found at [www.miele.com/service](http://www.miele.com/service).

In the UK, your appliance warranty is valid for 2 years from the date of purchase. However, you must activate your cover by calling 0330 160 6640 or registering online at [www.miele.co.uk](http://www.miele.co.uk).

## Contact in the event of a fault

In the event of any faults which you cannot remedy yourself, please contact your Miele dealer or the Miele Customer Service Department.

You can book a Miele Customer Service Department call-out online at [www.miele.com/service](http://www.miele.com/service).

Contact information for the Miele Customer Service Department can be found at the end of this document.

Please quote the model identifier and serial number of your appliance (Fabr./SN/Nr.) when contacting the Miele Customer Service Department. This information can be found on the data plate.

Please note that telephone calls may be monitored and recorded for training purposes and that a call-out charge will be applied to service visits where the problem could have been resolved as described in this booklet.

## Position of the data plate

The data plate is visible after removing the grease filter(s).

## Warranty

For information on the appliance warranty specific to your country please contact Miele. See back cover for address.

# Installation

## Before installation

 Before installation, it is important to read the information given on the following pages as well as the “Warning and Safety instructions” at the beginning of this booklet.

## Protective foil

The housing components have protective foil around them to protect them from transport damage.

- Please remove this foil before fitting the housing components. It can be peeled off easily.

## Coating the panel

The visible surfaces of the edge extraction panel can be coated for decoration.

The surfaces can be laminated, varnished or painted.

When selecting the coating, bear in mind that the panel is exposed to heat, moisture and soiling from the rising vapours.

Coatings are not recommended when the panel is installed over a gas hob due to the high temperatures involved.

Have specialists carry out the coating process.

Clean the panel at regular intervals.

Follow the cleaning instructions provided by the manufacturer of the coating used.

Miele does not guarantee the durability of the coating.

## Installation materials

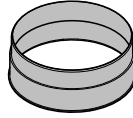

### 1 vent connection

for exhaust ducting  $\varnothing$  150 mm.

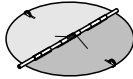

### 1 non-return flap

for fitting into the exhaust socket on the motor unit (not needed for recirculation mode).

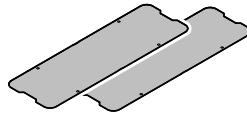

### 2 lids



### 8 rivets

for securing the lids.

08565780

08272520

12454670

12623460



## Appliance dimensions

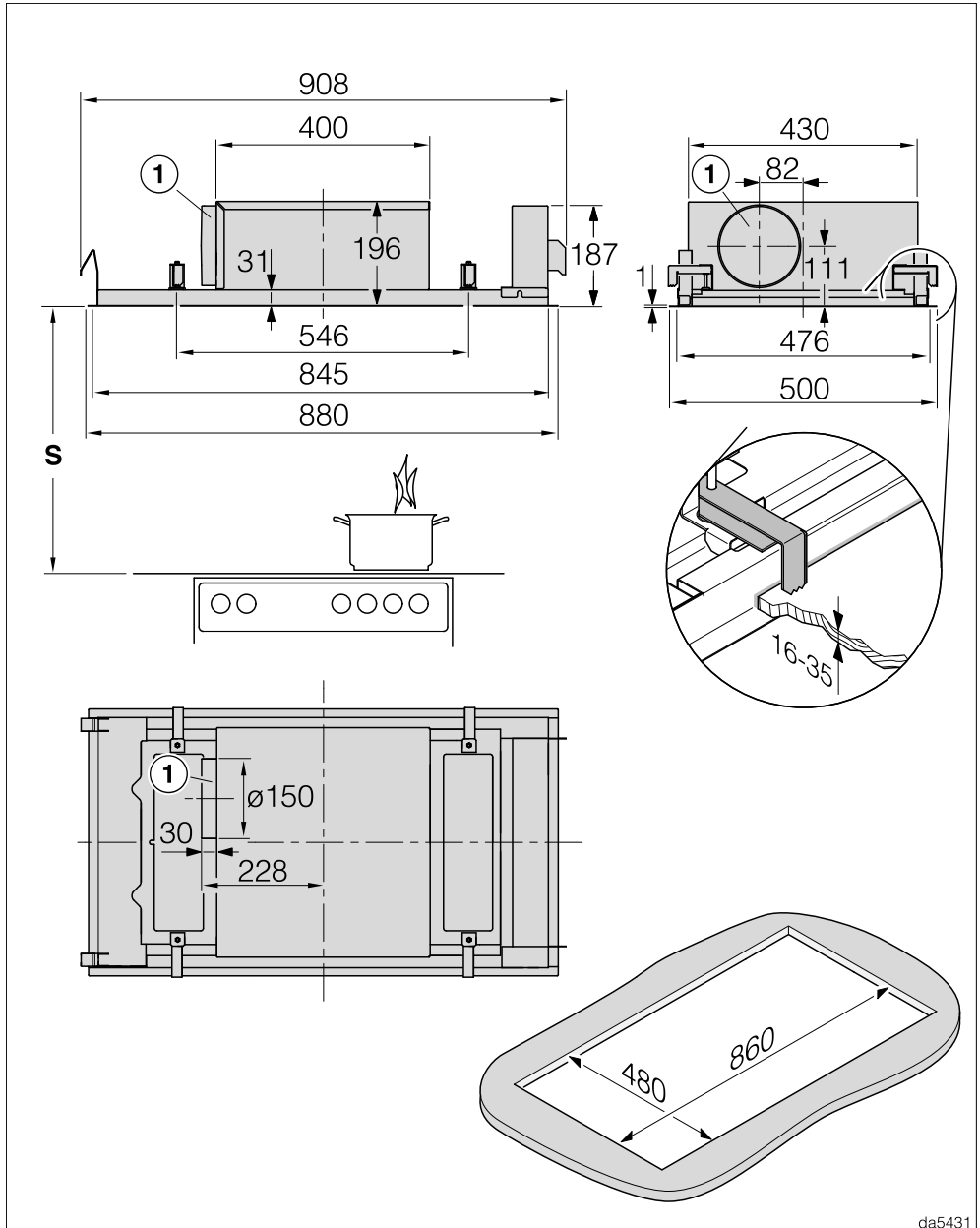

da5431

DAC 2940 in extraction mode

# Installation

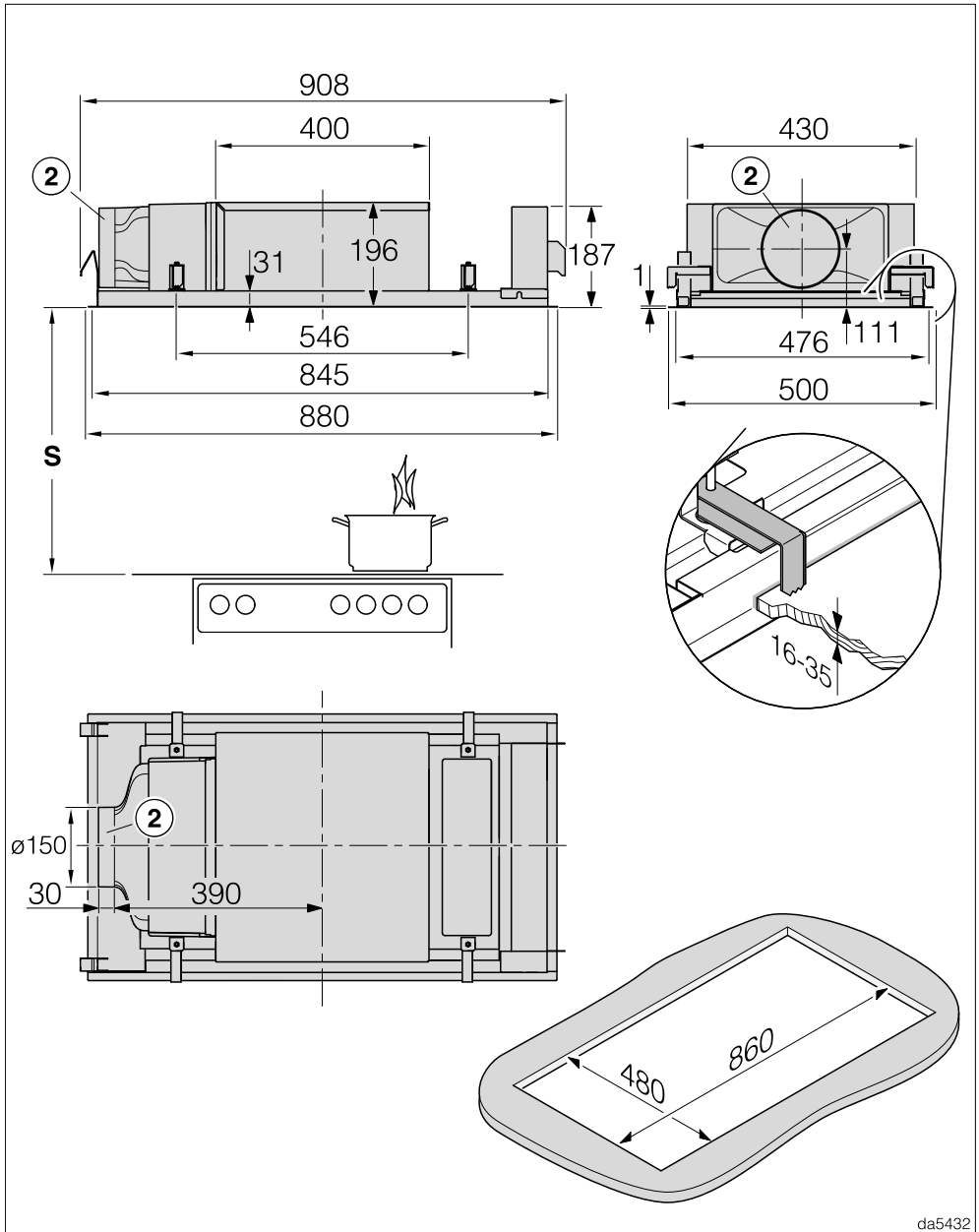

da5432

DAC 2940 in recirculation mode and Plug&Play recirculation mode

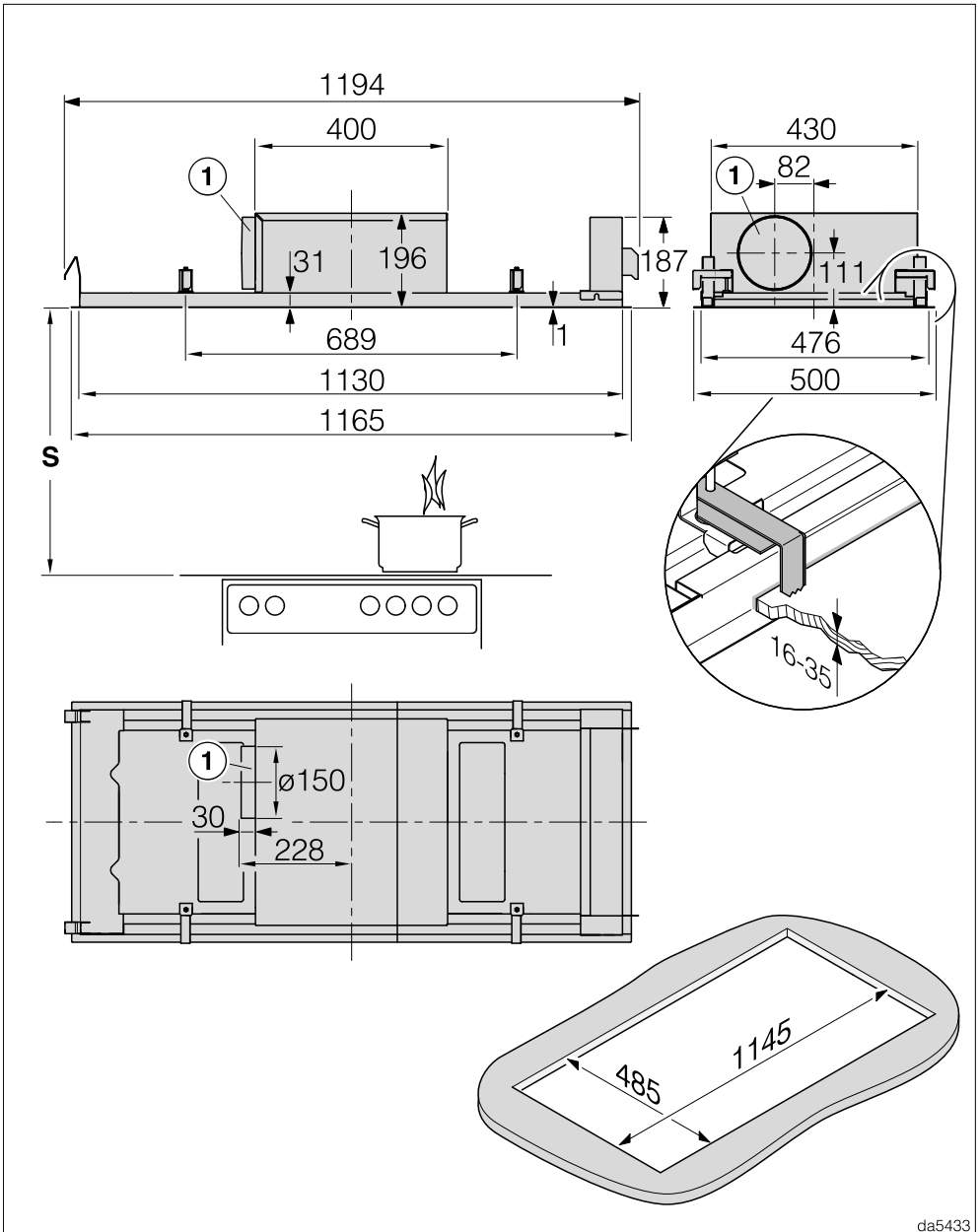

da5433

DAC 2240 in extraction mode

# Installation

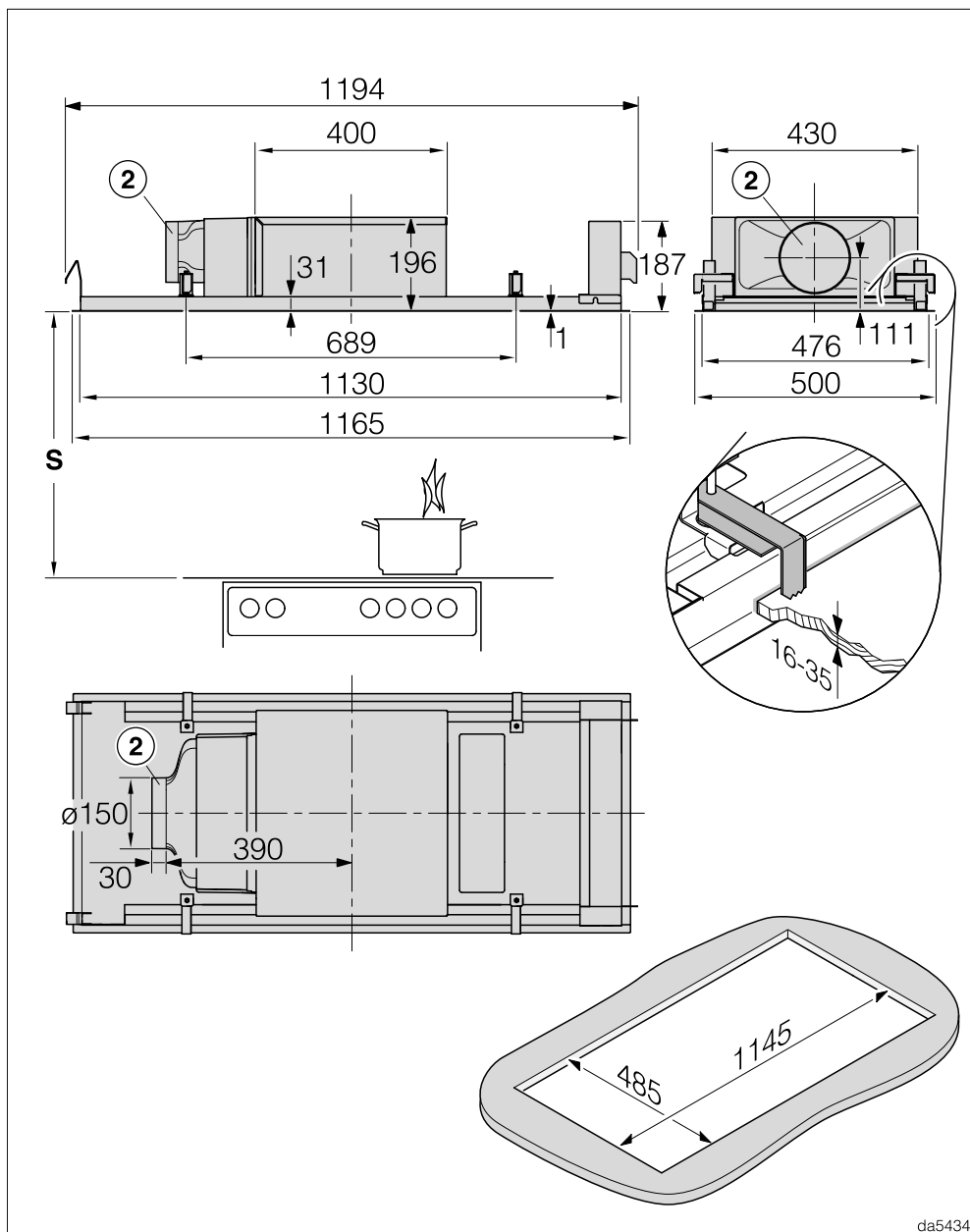

DAC 2240 in recirculation mode and Plug&Play recirculation mode

① Exhaust duct Ø 150 mm

The duct is fitted on the left-hand side at the factory.

- If you want to install the duct at the front or rear, you can rotate the fan casing by 90° during installation. To rotate the casing, there must be a clearance of 100 mm in the ceiling in front of and behind the ceiling cut-out.
- If you want to install the duct on the right-hand side, rotate the cooker hood by 180° during installation. To ensure that the panel still opens to the front, you must convert the panel hinges.

② Duct Ø 150 mm, as air vent in Plug&Play mode or for the connection of an air duct in ducted recirculation mode

The duct is fitted on the left-hand side at the factory.

- It is not possible to convert the duct to the front or rear.
- If you want to install the duct on the right-hand side, rotate the cooker hood by 180° during installation. To ensure that the panel still opens to the front, you must convert the panel hinges.

The required installation steps are described in the installation sheet.

# Installation

## Safety distance between hob and cooker hood (S)

When planning the installation height of your cooker hood, the minimum safety distance between the top of a cooker or hob and the bottom of the cooker hood is as follows, unless a greater distance is specified by the manufacturer of your cooking appliance.

See “Warning and Safety” instructions for further information.

Cooking appliance	Minimum distance S
Electric hob	450 mm
Electric grill, deep fat fryer (electric)	650 mm
Multi-burner gas hob, total output $\leq 12.6$ kW, no burner $> 4.5$ kW	650 mm
Multi-burner gas hob, total output $> 12.6$ kW and $\leq 21.6$ kW, no burner $> 4.8$ kW.	760 mm
Multi-burner gas hob, total output $> 21.6$ kW, or multi-burner gas hob where one burner $> 4.8$ kW.	Not possible
Single burner gas hob, output $\leq 6$ kW.	650 mm
Single burner gas hob, output $> 6$ kW and $\leq 8.1$ kW.	760 mm
Single burner gas hob, output $> 8.1$ kW	Not possible

## Installation notes

- We recommend a minimum distance of 700 mm and a maximum distance of 1300 mm between the hob and the cooker hood.

Please be aware that if positioned too high, vapour extraction will be inefficient.

- To achieve optimum vapour extraction, the cooker hood must be centred over the hob, not to the side or behind it.

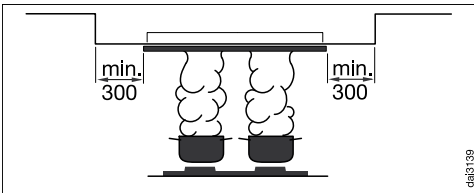

- If the cooker hood is being installed in a suspended ceiling, the installation surface all around the cooker hood must be at least 300 mm larger than the cooker hood itself.
- As far as possible, the hob should be narrower than the cooker hood. The hob should be no wider than the cooker hood.
- The cooker hood must also be freely accessible and located such that it can be dismantled in the event of future service requirements. This should be taken into consideration when planning the position of cabinets, shelves, ceilings or features in the vicinity of the cooker hood.
- The cooker hood is fastened in the cut-out using clamps. A solid installation surface, e.g. made of wood, is required. Make sure that the structure can support the load.

Around the clamps, components such as supports and ducting must be at least 25 mm from the cut-out.

- If you install the appliance in a place that is used on a daily basis, e.g. in a cabinet, the top of the appliance must not be accessible. Close the installation space in the cabinet, e.g. with additional walls and shelves.

## Plug&Play mode

- The air must be able to circulate freely into the ceiling. Components in the ceiling must be at least 30 cm away from the exhaust ducting.
- Ensure sufficient ventilation of the ceiling area, e.g. through exhaust grilles, gaps or shadow gaps. The cross-section of the openings must be at least 600 cm<sup>2</sup> in total.
- The ceiling and adjacent walls that come into contact with the exhaust air must not exceed a heat transfer coefficient of 0.5 W/(m<sup>2</sup>K).
- The electronic module for vapour extraction must be switched to Plug&Play mode, see "Commissioning", "Activating/Deactivating Plug&Play".

# Installation

## Connection for air extraction

 If the cooker hood is used at the same time as a heating appliance that relies on oxygen from the same room, there is a risk in certain circumstances of toxic fumes building up.

It is essential that the “Warning and Safety” instructions are observed. The cooker hood should be installed according to local and national building regulations. Seek approval from the building inspector where necessary.

Only use smooth pipes or flexible exhaust ducting made from approved non-flammable materials for exhaust ducting.

To achieve the most efficient air throughput with the lowest noise levels, please note the following:

- The diameter of the exhaust ducting must not be smaller than the cross-section of the exhaust duct (see “Appliance dimensions”). This applies in particular when using flat ducting.
- The exhaust ducting should be as short and straight as possible.
- Only use wide radius bends.
- The exhaust ducting must not be kinked or compressed.
- All connections must be strong and airtight.
- If the exhaust ducting has flaps, these must be opened whenever the cooker hood is switched on.

Any constriction of the air throughput will reduce extraction performance and increase operating noise.

## Flue

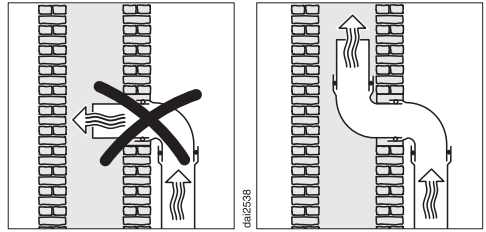

If the exhaust air is to be ducted into a flue, the ducting must be directed in the flow direction of the flue.

If the flue is used by several ventilation units, the cross-section of the flue must be large enough.



## Non-return flap

- Use a non-return flap in the exhaust system.

A non-return flap ensures that when the cooker hood is not in operation, the duct is closed to prevent unwanted exchange of room air and outside air.

If the exhaust is ducted through an outside wall, a Miele wall vent or roof vent (available as an optional accessory) is recommended. Both of these have a built-in non-return flap.

If the on-site ventilation system does not have a non-return flap, one is supplied with the cooker hood.

The non-return flap is fitted in the exhaust socket of the fan.

## Condensation

If the exhaust ducting is to run through cool rooms or ceiling space, for example, the significant variations in temperature between the different areas can cause condensation to form. Insulate the exhaust ducting to reduce temperature variations.

If the exhaust ducting is to be laid horizontally, it must be laid with a downwards sloping gradient of at least 1 cm per meter. This is to ensure that condensation cannot drain back into the cooker hood.

Miele shall not accept warranty claims for any functional defects or damage caused by inadequate exhaust ducting.

## Silencer

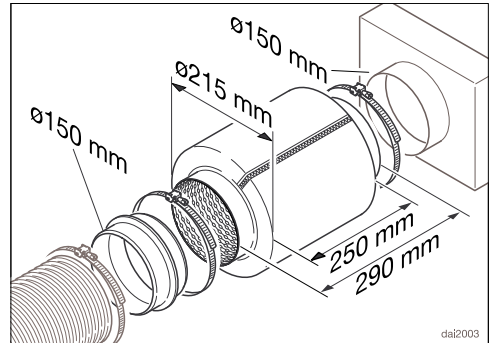

To reduce noise levels even further, a silencer (optional accessory) can be installed in the exhaust ducting.

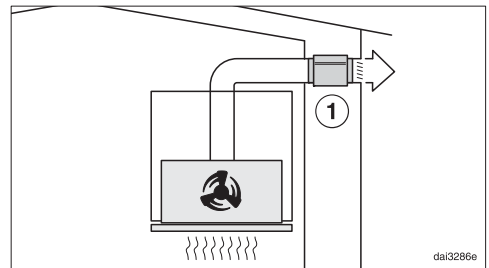

In extraction mode, the silencer not only reduces noise from the fan outside the house, but also sounds originating outside reaching the kitchen through the exhaust ducting (e.g. traffic noise). For this reason, the silencer must be positioned as close as possible to the ducting exit ①.

# Installation

---

## Electrical connection

The cooker hood is supplied with a mains cable with moulded plug ready for connection to a suitable earthed socket.

If the socket is not easily accessible or a fixed connection is envisaged, ensure that a suitable means of disconnection is provided on the installation side for each pole.

 Risk of fire from overheating. Connecting the cooker hood to multi-socket adapters or extension cables can overload the cables. For safety reasons, do not use an extension cable or multi-socket adapter.

The electrical system must comply with local and national safety regulations (BS 7671 in the UK).

For safety reasons, we recommend using a type  residual current device (RCD) in the relevant electrical installation for connecting the cooker hood.

If the mains connection cable is damaged, it must only be replaced with a specific mains connection cable of the same type (available from the Miele Customer Service Department). For safety reasons, such replacement may only be carried out by a qualified specialist or the Miele Customer Service Department.

These operating instructions and the data plate indicate the nominal power consumption and the appropriate fuse rating. Compare this information with the data of the on-site electrical connection.

If in any doubt, consult a qualified electrician.

Temporary or permanent operation on an autonomous power supply system or a power supply system that is not synchronised with the mains power supply (e.g. island networks, back-up systems) is possible. A prerequisite for operation is that the power supply system complies with the specifications of EN 50160 or an equivalent standard. The function and operation of the protective measures provided in the domestic electrical installation and in this Miele product must also be maintained in isolated operation or in operation that is not synchronised with the mains power supply, or these measures must be replaced by equivalent measures in the installation. As described, for example, in the current version of VDE-AR-E 2510-2.

## Technical data

Fan motor	160 W
Hob lighting	2 x 7.2 W
Total rated load	174.4 W
Light temperature for the hob lighting	3500 K
Mains voltage, frequency	AC 230 V, 50 Hz
Fuse rating	10 A
Length of mains connection cable	1.35 m
Weight	
DAC 2940	16.6 kg
DAC 2240	20.4 kg

### WiFi module

Frequency band	2.400–2.4835 GHz
Maximum transmission power	< 100 mW

### Optional accessories for recirculation mode

One DKF 35-P, DKF 35-S or DKF 40-R charcoal filter (reactivatable)

### EU Conformity declaration

Miele hereby declares that this cooker hood complies with Directive 2014/53/EU.

The complete text of the EU declaration of conformity is available from one of the following internet addresses:

- Products, Download from [www.miele.ie](http://www.miele.ie)
- For service, information, operating instructions etc: go to <https://miele.co.uk/> manuals and enter the name of the product or the serial number

### UK Conformity declaration

Miele hereby declares that this cooker hood complies with UK Radio Equipment Regulations 2017, as amended.

The complete text of the UK declaration of conformity is available from one of the following internet addresses:

- Products, Download from [www.miele.co.uk](http://www.miele.co.uk)
- For service, information, operating instructions etc: go to <https://miele.co.uk/> manuals and enter the name of the product or the serial number

# Technical data

---

This **Statement of Compliance** confirms this Miele product fully complies with the **Product Security and Telecommunications Infrastructure (Security Requirements for Relevant Connectable Products) Regulations 2023**.

- 1) Household Appliance – *Cooker Hood DAC 2940, DAC 4940*
- 2) Manufactured by: Miele & Cie KG,  
Carl Miele Street 29, 33332 Gutersloh Germany  
Imported by and contact point: Miele Company Ltd, Fairacres, Marcham Road,  
Abingdon, Oxon, OX14 ITW Great Britain
- 3) The defined support period at the time of first supply is 10 years
- 4) To report vulnerabilities and cybersecurity issues please contact: psirt@miele.com

- 5) Signature   
Name: **Paul Wright**  
Company Position: **Head of Technical Management**  
Date of signature: **19th March 2024**  
Place of signature: **Abingdon, Oxfordshire**

## Note for test institutes

Energy efficiency must be calculated using extraction mode. The cooker hood is set up ex-works for recirculation mode. To re-set it for extraction mode the operating hours counter for the charcoal filter(s) has to be deactivated (see “Before using for the first time”).

## Data sheet for household cooker hoods

In acc. with delegated regulation (EU) No. 65/2014 and regulation (EU) No. 66/2014

<b>MIELE</b>	
<b>Model name/identifier</b>	DAC 2940 Stella
Annual Energy Consumption ( $AEC_{hood}$ )	31,7 kWh/year
Energy efficiency class	A++
Energy efficiency index ( $EEl_{hood}$ )	36,4
Fluid Dynamic Efficiency ( $FDE_{hood}$ )	40,6
Fluid Dynamic Efficiency class	
A (most efficient) to G (least efficient)	A
Lighting Efficiency ( $LE_{hood}$ )	36,5 lx/W
Lighting Efficiency class	
A (most efficient) to G (least efficient)	A
Grease Filtering Efficiency	81,5%
Grease Filtering Efficiency class	
A (most efficient) to G (least efficient)	C
Airflow at best efficiency point	367,8 m <sup>3</sup> /h
Air flow (min. speed)	238 m <sup>3</sup> /h
Air flow (max. speed)	512 m <sup>3</sup> /h
Air flow (intensive or boost setting)	689 m <sup>3</sup> /h
Max. air flow ( $Q_{max}$ )	689,0 m <sup>3</sup> /h
Air pressure at best efficiency point	462 Pa
Airborne acoustical A-weighted sound power emissions (min. speed)	43 dB
Airborne acoustical A-weighted sound power emissions (max. speed)	61 dB
Airborne acoustical A-weighted sound power emissions (intensive or boost setting)	68 dB
Electrical power input at best efficiency point	116,2 W
Power consumption in standby mode ( $P_s$ )	0,26 W
Nominal power of lighting system	14,4 W
Average illumination of the lighting system on the cooking surface	525 lx
Time increase factor	0,5

# Technical data

## Data sheet for household cooker hoods

In acc. with delegated regulation (EU) No. 65/2014 and regulation (EU) No. 66/2014

<b>MIELE</b>	
<b>Model name/identifier</b>	DAC 2240 Stella
Annual Energy Consumption ( $AEC_{hood}$ )	31,4 kWh/year
Energy efficiency class	A++
Energy efficiency index ( $EEL_{hood}$ )	36,5
Fluid Dynamic Efficiency ( $FDE_{hood}$ )	40,6
Fluid Dynamic Efficiency class	
A (most efficient) to G (least efficient)	A
Lighting Efficiency ( $LE_{hood}$ )	31,3 lx/W
Lighting Efficiency class	
A (most efficient) to G (least efficient)	A
Grease Filtering Efficiency	80,5%
Grease Filtering Efficiency class	
A (most efficient) to G (least efficient)	C
Airflow at best efficiency point	361,8 m <sup>3</sup> /h
Air flow (min. speed)	236 m <sup>3</sup> /h
Air flow (max. speed)	508 m <sup>3</sup> /h
Air flow (intensive or boost setting)	682 m <sup>3</sup> /h
Max. air flow ( $Q_{max}$ )	682,0 m <sup>3</sup> /h
Air pressure at best efficiency point	462 Pa
Airborne acoustical A-weighted sound power emissions (min. speed)	43 dB
Airborne acoustical A-weighted sound power emissions (max. speed)	62 dB
Airborne acoustical A-weighted sound power emissions (intensive or boost setting)	68 dB
Electrical power input at best efficiency point	114,3 W
Power consumption in standby mode ( $P_s$ )	0,25 W
Nominal power of lighting system	14,4 W
Average illumination of the lighting system on the cooking surface	450 lx
Time increase factor	0,5

## United Kingdom

Miele Co. Ltd., Fairacres, Marcham Road, Abingdon, Oxon, OX14 1TW  
Tel: 0330 160 6600, Internet: [www.miele.co.uk](http://www.miele.co.uk), E-mail: [info@miele.co.uk](mailto:info@miele.co.uk)

### Australia

Miele Australia Pty. Ltd.  
ACN 005 635 398  
ABN 96 005 635 398  
Level 4, 141 Camberwell Road  
Hawthorn East, VIC 3123  
Tel: 1300 464 353  
E-mail: [info@miele.com.au](mailto:info@miele.com.au)  
Internet: [www.miele.com.au](http://www.miele.com.au)

### China Mainland

Miele Electrical Appliances Co., Ltd.  
1-3 Floor, No. 82 Shi Men Yi Road  
Jing' an District  
200040 Shanghai, PRC  
Tel: +86 21 6157 3500  
Fax: +86 21 6157 3511  
E-mail: [info@miele.cn](mailto:info@miele.cn)  
Internet: [www.miele.cn](http://www.miele.cn)

### Hong Kong, China

Miele (Hong Kong) Ltd.  
41/F - 4101, Manhattan Place  
23 Wang Tai Road  
Kowloon Bay, Hong Kong  
Tel: (852) 2610 1025  
Fax: (852) 3579 1404  
E-mail:  
[customerservices@miele.com.hk](mailto:customerservices@miele.com.hk)  
Website: [www.miele.hk](http://www.miele.hk)

### India

Miele India Pvt. Ltd.  
1st Floor, Copia Corporate Suites,  
Commercial Plot 9, Mathura Road,  
Jasola, New Delhi - 110025  
E-mail: [customercare@miele.in](mailto:customercare@miele.in)  
Website: [www.miele.in](http://www.miele.in)

### Ireland

Miele Ireland Ltd.  
2024 Bianconi Avenue  
Citywest Business Campus  
Dublin 24  
Tel: (01) 461 07 10  
Fax: (01) 461 07 97  
E-mail: [info@miele.ie](mailto:info@miele.ie)  
Internet: [www.miele.ie](http://www.miele.ie)

### Malaysia

Miele Sdn Bhd  
Suite 12-2, Level 12  
Menara Sapura Kencana  
Petroleum  
Solaris Dutamas No. 1  
Jalan Dutamas 1  
50480 Kuala Lumpur, Malaysia  
Phone: +603-6209-0288  
Fax: +603-6205-3768

### New Zealand

Miele New Zealand Limited  
IRD 98 463 631  
8 College Hill  
Freemans Bay, Auckland 1011  
Tel: 0800 464 353  
E-mail: [customercare@miele.co.nz](mailto:customercare@miele.co.nz)  
Internet: [www.miele.co.nz](http://www.miele.co.nz)

### Singapore

Miele Pte. Ltd.  
29 Media Circle  
#11-04 ALICE@Mediapolis  
Singapore 138565  
Tel: +65 6735 1191  
Fax: +65 6735 1161  
E-mail: [info@miele.com.sg](mailto:info@miele.com.sg)  
Internet: [www.miele.sg](http://www.miele.sg)

### South Africa

Miele (Pty) Ltd.  
63 Peter Place, Bryanston 2194  
P.O. Box 69434, Bryanston 2021  
Tel: (011) 875 9000  
Fax: (011) 875 9035  
E-mail: [info@miele.co.za](mailto:info@miele.co.za)  
Internet: [www.miele.co.za](http://www.miele.co.za)

### Thailand

Miele Appliances Ltd.  
BHIRAJ TOWER at EmQuartier  
43rd Floor Unit 4301-4303  
689 Sukhumvit Road  
North Klongton Sub-District  
Vadhana District  
Bangkok 10110, Thailand

### United Arab Emirates

Miele Appliances Ltd.  
Showroom 1, Eiffel 1 Building  
Sheikh Zayed Road, Umm Al Sheif  
P.O. Box 114782 - Dubai  
Tel. +971 4 3044 999  
Fax. +971 4 3418 852  
800-MIELE (64353)  
E-mail: [info@miele.ae](mailto:info@miele.ae)  
Website: [www.miele.ae](http://www.miele.ae)

**Manufacturer:** Miele & Cie. KG, Carl-Miele-Straße 29, 33332 Gütersloh, Germany

DAC 2940, DAC 2240

en-GB

M.-Nr. 12 574 471 / 01