



Operating and installation instructions with recipes Oven



To avoid the risk of accidents or damage to the appliance it is **essential** to read these instructions before it is installed and used for the first time.

Contents

Warning and Safety instructions	6
Caring for the environment	13
Guide to the appliance	14
Oven	14
Oven controls	15
Operating mode selector	16
Display	16
Rotary selector < >	16
Sensor controls	16
Symbols	17
Using the appliance	18
Selecting an operating mode	18
Entering numbers	18
Selecting a menu option from a list	18
Changing a setting in a list	18
Changing the setting with a segment bar	18
Features	19
Data plate	19
Scope of delivery	19
Accessories supplied and available to order	19
Safety features	25
PerfectClean treated surfaces	25
Before using for the first time	26
Miele@home	26
Basic settings	27
Heating up the oven for the first time	28
Settings	29
Settings overview	29
Opening the “Settings” menu	30
Language 	30
Time	30
Display	30
Volume	30
Units	31
Recommended temps.	31
Cooling fan run-on	31
Operating hours	31
Miele@home	31
Remote control	32
RemoteUpdate	32
Software version	33
Showroom programme	33
Factory default	33

Min. minder	34
Overview of functions	35
Energy saving tips	36
Operation	37
Easy to use	37
Changing values and settings for a cooking programme	37
Changing the temperature	37
Setting cooking durations.....	37
Changing the set cooking durations	38
Deleting the set cooking durations	38
Cancelling a cooking process	38
Pre-heating the oven.....	39
Automatic programmes	40
Using automatic programmes	40
Usage notes	40
Baking	41
Tips on baking.....	41
Notes on the cooking charts	41
Notes on the functions	42
Roasting	43
Tips for roasting.....	43
Notes on the cooking charts	43
Notes on the functions	44
Grilling	45
Tips for grilling.....	45
Notes on the cooking charts	45
Notes on the functions	46
AirFry	47
Accessories	47
AirFrying tips	48
Using the AirFry  operating mode.....	48
Further applications	49
Defrost	49
Low temperature cooking.....	50
Drying.....	51
Frozen food/Ready meals.....	52
Heat crockery.....	52
Cleaning and care	53
Unsuitable cleaning agents.....	53
Removing normal soiling	53
Removing stubborn soiling (excluding the FlexiClip runners).....	54
Stubborn soiling on the FlexiClip runners.....	54

Contents

Cleaning the catalytic enamelled back panel	55
Removing soiling caused by spices, sugar and similar deposits	55
Removing oil and grease.....	55
Door removal.....	56
Dismantling the door	57
Fitting the door	59
Removing the side runners with FlexiClip runners	59
Removing the back panel.....	60
Problem solving guide.....	61
Service.....	64
Contact in the event of a fault	64
Warranty	64
Installation.....	65
Installation dimensions	65
Installation in a tall or base unit.....	65
Side view H 24xx.....	66
Side view H 28xx, H 27xx.....	67
Connections and ventilation	68
Installing the oven	69
Electrical connection	70
Oven	70
Electrical connection: Other countries.....	71
Cooking charts.....	72
Creamed mixture.....	72
Shortcrust pastry.....	73
Yeast dough.....	74
Quark dough.....	75
Sponge mixture.....	75
Choux pastry, puff pastry, meringue	76
Savoury dishes.....	77
Beef	78
Veal.....	79
Pork.....	80
Lamb, game	81
Poultry, fish.....	82
Notes for test institutes.....	83
Test food according to EN 60350-1.....	83
Energy efficiency class according to EN 60350-1	84
Recipes for automatic programmes.....	85
Apple sponge	86
Sponge base	87
Layered sponge cake fillings	88
Marble cake.....	89

Contents

Fruit streusel cake	90
Biscuits	91
Drop cookies	92
Walnut muffins	93
Pizza (yeast dough)	94
Pizza (quark dough)	95
Chicken	96
Fillet of beef (roast)	97
Trout	98
Salmon fillet	99
Salmon trout	100
Potato and cheese gratin	101
Lasagne	102
AirFry recipes	103
Falafel with yoghurt dip	104
French fries and sweet potato fries	105
Sesame tofu sticks	106
Baked potatoes with cheese, spring onions and bacon	107
Baked potatoes with feta, tzatziki and Greek salad	108
Courgette fries with blue cheese dip and chilli sauce	109
Corn grilled with hoisin glaze and coleslaw	110
Chicken nuggets with coconut sesame coating	111
Cod with crust	112
Bananas with pistachio and honey topping	113
Pasteis de nata	114
Vegan pasteis de nata	115
Technical data	116
EU Conformity declaration	116
UK Conformity declaration	116
Copyrights and licences for the communication module	117

Warning and Safety instructions

This oven complies with all current local and national safety requirements. However, inappropriate use can lead to personal injury and damage to property.

Read the operating and installation instructions carefully before using the oven. They contain important information on safety, installation, use and maintenance. This prevents both personal injury and damage to the oven.

In accordance with standard IEC/EN 60335-1, Miele expressly and strongly advises that you read and follow the instructions in the chapter on installing the oven as well as the safety instructions and warnings.

Miele cannot be held liable for damage caused by non-compliance with these instructions.

Keep these instructions in a safe place and pass them on to any future owner.

Appropriate use

▶ This oven is intended for domestic use and use in other similar environments.

▶ The oven is not intended for outdoor use.

▶ The oven is intended for domestic use only to bake, roast, grill, cook, defrost and dry food.

All other types of use are not permitted.

▶ This oven may only be used by people with reduced physical, sensory or mental capabilities or lack of experience and knowledge if they are supervised whilst using it.

They may only use it unsupervised if they have been shown how to use it in a safe manner. They must be able to recognise and understand the dangers of misuse.

▶ The oven compartment is equipped with special lamps to cope with particular conditions (e.g. temperature, moisture, chemical resistance, abrasion resistance and vibration). These special lamps must only be used for the purpose for which they are intended. They are not suitable for room lighting.

▶ The oven contains 1 light source corresponding to energy efficiency class G.

Safety with children

▶ Activate the system lock to ensure that children cannot switch the oven on by mistake.

▶ Children under 8 years of age must be kept away from the oven unless they are constantly supervised.

▶ Children aged 8 and older may only use the oven without supervision if they have been shown how to use it in a safe manner. Children must be able to understand and recognise the possible dangers caused by incorrect operation.

▶ Children must not be allowed to clean or maintain the oven unsupervised.

▶ Children should be supervised in the vicinity of the oven. Never allow children to play with the oven.

▶ Risk of suffocation due to packaging material. Whilst playing, children may become entangled in packaging material (such as plastic wrapping) or pull it over their head, presenting the risk of suffocation.

Keep packaging material away from children.

▶ Risk of injury caused by hot surfaces. Children's skin is far more sensitive to high temperatures than that of adults. External parts of the oven such as the door glass, control panel and the vent become quite hot.

Do not let children touch the oven when it is in operation.

▶ Risk of injury from the open door.

The oven door can support a maximum weight of 15 kg. Children could injure themselves on an open door.

Do not let children sit on the open door, lean against it or swing on it.

Technical safety

▶ Unauthorised installation, maintenance and repairs can cause considerable danger for the user. Installation, maintenance and repairs must only be carried out by a Miele authorised technician.

▶ Damage to the oven can compromise your safety. Check the oven for visible signs of damage. Do not use a damaged oven.

Warning and Safety instructions

- ▶ Temporary or permanent operation on an autonomous power supply system or a power supply system that is not synchronised with the mains power supply (e.g. island networks, back-up systems) is possible. A prerequisite for operation is that the power supply system complies with the specifications of EN 50160 or an equivalent standard. The function and operation of the protective measures provided in the domestic electrical installation and in this Miele product must also be maintained in isolated operation or in operation that is not synchronised with the mains power supply, or these measures must be replaced by equivalent measures in the installation. As described, for example, in the current version of BS OHSAS 18001–2 ISO 45001.
- ▶ The electrical safety of this oven can only be guaranteed when correctly earthed. It is most important that this basic safety requirement is fulfilled. If in doubt, the electrical installation should be checked by a qualified electrician.
- ▶ The connection data (voltage and frequency) on the data plate of the oven must match the mains electricity supply in order to avoid the risk of damage to the oven. Compare this before connecting the appliance to the mains. If in any doubt, consult a qualified electrician.
- ▶ Multi-socket adapters and extension leads do not guarantee the required safety of the appliance. Do not use these to connect the oven to the mains electricity supply.
- ▶ For safety reasons, the oven may only be used when it has been built in and fully installed.
- ▶ The oven must not be used in a non-stationary location (e.g. on a ship).
- ▶ Risk of injury due to electric shock. Any contact with live connections or tampering with the electrical or mechanical components of the oven will endanger your safety and may lead to the oven malfunctioning.
Do not open the oven housing under any circumstances.
- ▶ While the oven is under warranty, repairs should only be undertaken by a Miele authorised service technician. Otherwise the warranty will be invalidated.
- ▶ Miele can only guarantee the safety of the oven when original Miele spare parts are used. Faulty components must only be replaced by original spare parts.
- ▶ If the oven is delivered without a power connection cable, a special cable must be installed by a Miele authorised service technician (see “Installation”, “Electrical connection”).

Warning and Safety instructions

- ▶ If the connection cable is damaged, it must be replaced with a special connection cable by a Miele authorised service technician (see “Installation”, “Electrical connection”).
- ▶ During installation, maintenance and repair work, e.g. if the oven interior lighting is faulty (see “Problem solving guide”), the oven must be completely disconnected from the household electricity supply. To ensure this, do one of the following:
 - Disconnect the mains fuse
 - Completely unscrew the screw-out fuse (in countries where this is applicable)
 - Pull out the plug (if one is present) at the wall socket To do this, pull the plug and not the mains connection cable.
- ▶ The oven requires a sufficient supply of cool air for efficient operation. Make sure that the supply of cool air is not hindered in any way (e.g. by fitting heat insulation strips in the housing unit). Furthermore, the required supply of cool air must not be excessively heated by other heat sources (e.g. solid fuel stoves).
- ▶ If the oven is built in behind a furniture front (e.g. a door), do not close the furniture door while the oven is in use. Heat and moisture can build up behind the closed furniture door. This can result in damage to the oven, housing unit and floor. Leave the furniture front/door open until the oven has cooled down completely.

Correct use



- ▶ Risk of injury caused by hot surfaces. The oven gets hot during operation. You could burn yourself on the heating elements, oven compartment, accessories or food. Wear oven gloves when placing hot food in the oven or removing it and when adjusting oven shelves, for example, in a hot oven compartment.
- ▶ To avoid fuelling any flames, do not open the oven door if smoke occurs inside the appliance. Interrupt the process by switching the appliance off and disconnect it from the mains electricity supply. Do not open the door until the smoke has dispersed.
- ▶ Due to the high temperatures radiated, objects left near the oven could catch fire. Do not use the oven to heat up the room.

Warning and Safety instructions

▶ Oils and fats can ignite if allowed to overheat. Never leave the oven unattended when cooking with oil or fats. Never attempt to put out oil or fat fires with water. Switch the oven off and extinguish the flames by leaving the door closed.

▶ Grilling food for excessively long cooking durations can cause it to dry out with the risk of catching fire. Do not exceed the recommended cooking durations.

▶ Certain foods dry out quickly and may catch fire due to high grill temperatures.

Never use grill modes to finish baking partially baked rolls or bread or to dry flowers or herbs. Instead, use the Fan plus  or Conventional heat  function.



▶ If using alcohol in your recipes, please be aware that high temperatures can cause the alcohol to evaporate. The vapour can catch fire on hot heating elements.

▶ When using residual heat to keep food warm, corrosion from high air humidity and condensation can occur in the oven. This can also cause damage to the control panel, worktop and surrounding kitchen furniture. Keep the oven on and select the lowest temperature available for the selected function. The cooling fan will then continue to run automatically.

▶ Food which is stored in the oven compartment or left in it to be kept warm can dry out and the moisture released can lead to corrosion damage in the oven. Always cover food that is left in the oven to keep warm.

▶ An accumulation of heat can cause the floor of the oven to crack or flake off.

Never line the floor of the oven compartment with aluminium foil or oven liners.

If you wish to place crockery on the oven floor during cooking, or place crockery on the oven floor to heat it up, you can do so, but only with the Fan plus  or Eco Fan heat  function.

▶ The oven compartment floor can become damaged by items being pushed around on it. When placing pots, pans or crockery on the oven compartment floor, ensure that you avoid pushing them around.

▶ Risk of injury caused by steam. Pouring a cold liquid onto a hot surface creates steam, which can cause severe scalding. The sudden temperature change can also cause damage to hot enamelled surfaces. Never pour cold liquids directly onto hot enamelled surfaces.

Warning and Safety instructions

- ▶ It is important that the temperature in the food being cooked is evenly distributed and sufficiently high. This can be achieved by stirring or turning the food.
- ▶ Plastic dishes that are not suitable for use in an oven will melt and may ignite at high temperatures, and can damage the oven. Use only plastic containers that are suitable for use in an oven. Follow the manufacturer's instructions.
- ▶ Heating up food in closed containers, such as tins or sealed jars, will result in an increase in pressure, which can cause them to explode. Do not heat up unopened tins or jars of food in the oven.
- ▶ Risk of injury from the open door. You could bang into the open door or trip over it. Avoid leaving the door open unnecessarily.
- ▶ The door can support a maximum load of 15 kg. Do not lean or sit on an open door, or place heavy items on it. Make sure that nothing gets trapped between the door and the oven compartment. This could damage the oven.

The following applies to stainless steel surfaces:

- ▶ Adhesives will damage the stainless steel surface and cause it to lose its dirt-repellent protective coating. Do not use sticky notes, adhesive tape or other types of adhesive on the stainless steel surface.
- ▶ Magnets can cause scratches. Do not use the stainless steel surface as a magnetic notice board.

Cleaning and care

- ▶ Risk of injury due to electric shock. The steam from a steam cleaning appliance could reach live electrical components and cause a short circuit. Do not use a steam cleaner to clean the appliance.
- ▶ The side runners can be removed (see "Cleaning and care" – "Removing the side runners with FlexiClip runners"). Refit the side runners correctly.
- ▶ The catalytic enamelled back panel can be removed for cleaning purposes (see "Cleaning and care – Removing the back panel"). Ensure that the back panel is replaced correctly and do not use the oven without it fitted.
- ▶ Scratches on the door glass can cause the glass to break. Do not use abrasive cleaners, hard sponges, brushes or sharp metal tools to clean the door glass.

Warning and Safety instructions

- ▶ In warm, moist environments, there is a higher probability of pest infestations (such as cockroaches). Ensure the oven and the area surrounding it are always kept clean. Damage caused by pests is not covered by the warranty.

Accessories

- ▶ Only use original Miele accessories. If other parts are used, warranty, performance and product liability claims will be invalidated.
- ▶ Miele will guarantee to supply functional spare parts for a minimum of 10 years and up to 15 years following the discontinuation of your oven.
- ▶ The Miele gourmet oven dish HUB 5000/HUB 5001 (if available) must not be inserted into shelf level 1. This will damage the floor of the oven. The lack of clearance will create an accumulation of heat which can cause the enamel to crack or flake off. Never place a Miele oven dish on the upper support of shelf level 1 either as it will not be secured by the non-tip safety notches. As a general rule, use shelf level 2.

Disposing of the packaging material

The packaging material is used for handling and protects the appliance from transport damage. The packaging material used is selected from materials which are environmentally friendly for disposal and can generally be recycled.

Recycling the packaging material reduces the use of raw materials. Use material-specific collection points for valuable materials and take advantage of return options. Your Miele dealer will take the packaging material away.

Disposing of your old appliance

Electrical and electronic appliances contain many valuable materials. They also contain certain materials, compounds and components which were essential for their correct functioning and safety. These could be hazardous to human health and to the environment if disposed of with household waste or if handled incorrectly. Please do not, therefore, dispose of your old appliance with household waste.



Instead, please make use of officially designated collection and disposal points to dispose of and recycle electrical and electronic appliances in your local community, with your dealer or with Miele, free of charge. By law, you are solely responsible for deleting any personal data from the old appliance prior to disposal. You are legally obliged to remove any old batteries which are not securely enclosed by the appliance and to remove any lamps without destroying them, where this is possible. These must be taken to a suitable collection point where they can be handed in free of charge. Please ensure that your old appliance poses no risk to children while being stored for disposal.

Guide to the appliance

Oven

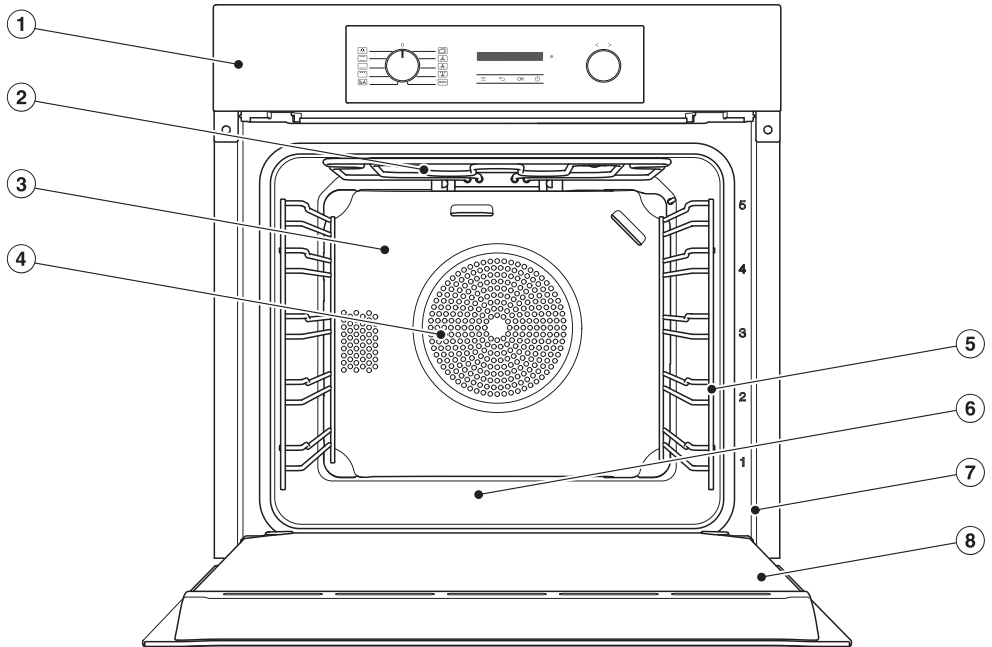

- ① Control elements
- ② Top heat/grill element
- ③ Catalytic enamelled back panel
- ④ Air inlet for the fan with ring heating element behind it
- ⑤ Side runners with 5 shelf levels
- ⑥ Oven floor with bottom heat element underneath it
- ⑦ Front frame with data plate
- ⑧ Door

Oven controls

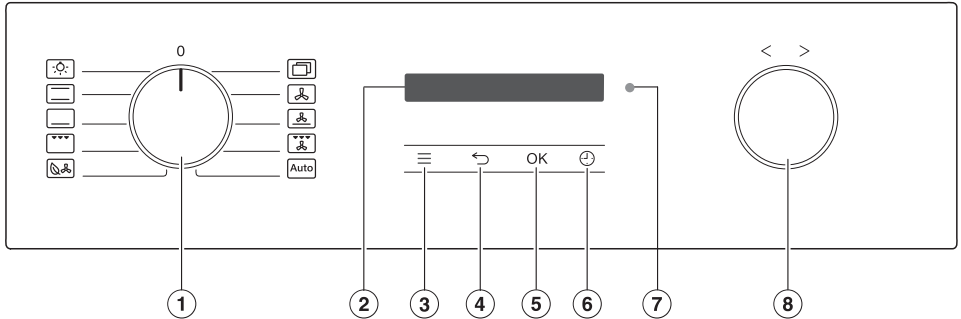

- ① Function selector
For selecting oven functions
- ② Display
For displaying the time of day and information on operation
- ③ ≡ sensor control
For accessing settings
- ④ ← sensor control
To go back a step
- ⑤ OK sensor control
For selecting functions and saving settings
- ⑥ ⌚ sensor control
For setting a minute minder, the cooking duration or the start or end time for the cooking programme
- ⑦ Optical interface
(For Miele Service only)
- ⑧ Rotary selector < >
For setting times, temperatures and for selecting menu options

Oven controls

Operating mode selector

Use the operating mode selector to select the required operating mode and switch on the oven interior lighting independently.

It can be turned clockwise or anti-clockwise.

Operating modes

-  Lighting
-  Conventional heat
-  Bottom heat
-  Full grill
-  Eco Fan heat
-  Further | Booster 
-  Further | AirFry 
-  Fan plus
-  Intensive bake
-  Fan grill
-  Automatic programmes

Display

The display is used for showing the time of day or information about operating modes, temperatures, cooking durations, automatic programmes and settings.

Rotary selector < >

The rotary selector can be turned clockwise or anti-clockwise.

You can increase values such as temperatures and times in the display by turning the rotary selector clockwise > or you can decrease the values by turning it anti-clockwise <.





In addition, you can use the rotary selector to scroll through the setting and automatic programme lists in the display.

Turn the rotary selector clockwise > to scroll down in the list and turn it anti-clockwise < to scroll up.

Sensor controls







The sensor controls react to touch. Every touch of a sensor control is confirmed with an audible keypad tone. You can turn this keypad tone off using the ≡ | Volume | Keypad tone sensor control.

Sensor controls under the display

Sensor control	Function
	Use this sensor control to access the settings when the operating mode selector is in the 0 or the Lighting  position.
	Depending on which menu you are in, this sensor control will take you back a level or back to the main menu.
<i>OK</i>	By selecting this sensor control you can access functions such as the minute minder, save changes to values or settings or confirm instructions.
	If no cooking programme is in progress, you can use this sensor control to set a minute minder (e.g. when boiling eggs) at any point. If a cooking programme is in progress at the same time, you can set a minute minder, the cooking duration and a start or end time for the programme.

Symbols

The following symbols may appear in the display:

Symbol	Meaning
	This symbol indicates that there is additional information and advice about using the appliance. Press the <i>OK</i> sensor control to confirm the information.
	Minute minder
	A tick indicates the option which is currently selected.
	Some settings, e.g. display brightness and buzzer volume are selected using a bar chart.
	The system lock prevents the oven being switched on by mistake (see “Settings – System lock  ”).
	Remote control (only appears if you are in the Miele@home system and have selected the Remote control On setting)

Using the appliance

Selecting an operating mode

- Turn the operating mode selector to the required operating mode.

The recommended temperature will appear in the display.

- Change the recommended temperature with the rotary selector < >, if necessary.
- Confirm with *OK*.

Changing the operating mode

You can change to another operating mode during a cooking process.

- Turn the operating mode selector to the new operating mode.

Any cooking durations set will be deleted.



Entering numbers

Numbers that can be changed are highlighted.

- Turn the rotary selector < > clockwise or anti-clockwise to change the number.
- Confirm with *OK*.

The changed number is now saved.

Selecting a menu option from a list

- When ,  and  are selected, the relevant menu appears.
Using the rotary selector < >, scroll through the list until the menu option you want appears.
- Confirm with *OK*.

Changing a setting in a list

A ✓ tick will appear beside the current setting.

- Turn the rotary selector < > clockwise or anti-clockwise until the required value or setting is shown.
- Confirm with *OK*.

The setting is now saved. This will take you back to the previous menu.

Changing the setting with a segment bar

Some settings are represented by a bar  with seven segments. If all of the segments are illuminated, the maximum value is selected.

If none of the segments are illuminated, or only one of them is, the minimum value is selected or the setting is switched off altogether (e.g. volume).

- Turn the rotary selector < > clockwise or anti-clockwise until the required setting is shown.
- Confirm your selection with *OK*.

The setting is now saved. This will take you back to the previous menu.

A list of the models described in these operating and installation instructions can be found on the back page of this booklet.

Data plate

The data plate is located on the front frame, visible when the door is open.

The data plate states the model number, the serial number as well as connection data (voltage, frequency and maximum rated load).

Please have this information to hand, should you need to contact Miele regarding any questions or problems.

Scope of delivery

- Operating and installation instructions for using the oven
- Screws for securing your oven in the housing unit
- Various accessories

Accessories supplied and available to order

Features will vary depending on model. Side runners, universal tray and wire rack (or “rack” for short) are supplied as standard with the oven.

Depending on the model, your oven may also come supplied with some of the accessories listed here.

All the accessories listed as well as the cleaning and care products are designed for Miele ovens.

These are available to order via the Miele Webshop, the Miele Customer Service Department or from your Miele dealer.

When ordering, please quote the model identifier of your oven and the reference number of the accessories required.

Side runners

There are runners on the left and right of the oven compartment with shelves  for inserting accessories.

The numbers for the shelf levels are marked on the front frame.

Each level consists of 2 rails, one above the other.

The accessories (e.g. the rack) are pushed into the oven between the two rails.

You can remove the side runners (see “Cleaning and care” – “Removing the side runners with FlexiClip runners”).

Baking tray, universal tray and rack with non-tip notches

Baking tray HBB 71:

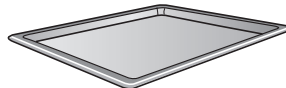

Universal tray HUBB 71:

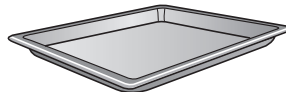

Rack HBBR 71:



These accessories are inserted into the oven between the two rails of a shelf in the side runner.

Always place the rack with the loading surface in the lower position.

These accessories have non-tip safety notches fitted in the middle of their short sides. The non-tip safety notches prevent the trays from being pulled out completely from the side runners when you only wish to pull accessories out partially.

Features



If you are using the universal tray with the rack on top, insert the tray between the rails of a shelf of the side runners and the rack will automatically slide in above them.

FlexiClip runners HFC 70-C

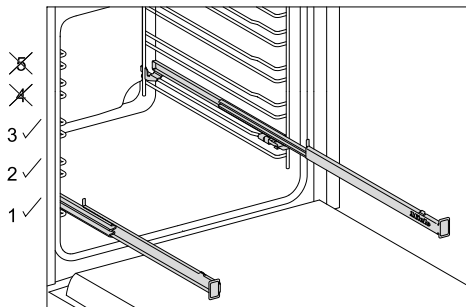

FlexiClip runners can only be fitted on levels 1, 2 and 3.

The FlexiClip runners can be drawn right out of the oven individually to give a good overview of cooking in progress.

Push the FlexiClip runners right into the oven compartment before placing accessories on them.

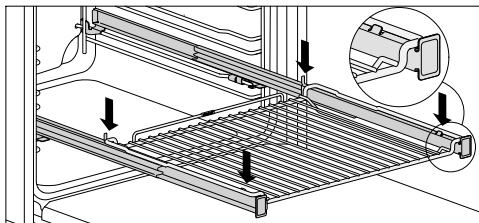
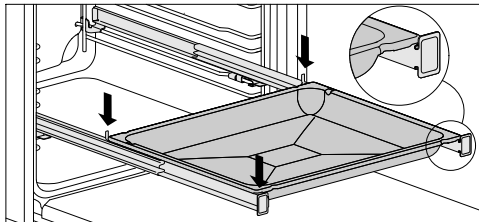

To prevent the risk of accessories sliding off the runners:

- Make sure that they are sitting securely on their runners in between the stoppers at either end of each runner.
- Always place the rack with the loading surface in the lower position on the FlexiClip runners.

The FlexiClip runners can support a maximum load of 15 kg.

Because the FlexiClip runners sit on the top rail of the side runners, the gap between the level the FlexiClip runners are on and the one above is smaller than if, for instance, racks were fitted on each level. Cooking results will be affected if the gap is too small.

You can use more than one baking tray, universal tray or rack at a time.

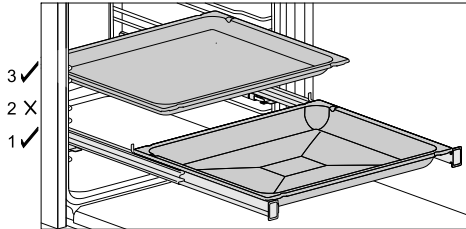

- Place the baking tray, universal tray or rack on the FlexiClip runners.
- Leave at least one shelf level free between the FlexiClip runner and any baking tray, universal tray or rack above it.

You can use the universal tray together with the rack on the FlexiClip runners.

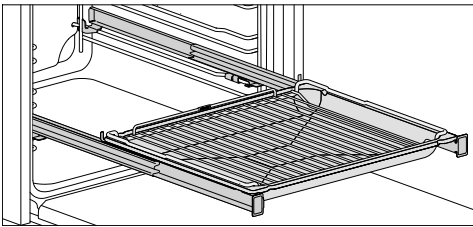

- Place the universal tray together with the rack on the FlexiClip runners. The rack will automatically slide between the rails of the shelf level above the FlexiClip runners.
- Leave at least one shelf level free between the FlexiClip runner and any baking tray, universal tray or rack above it.

Fitting the FlexiClip runners

Risk of injury caused by hot surfaces.

The oven gets hot during operation. You could burn yourself on the heating elements, oven compartment or accessories.

Allow the heating elements, oven compartment and the accessories to cool before fitting or removing the FlexiClip runners.

Preferably fit the FlexiClip runners onto level 1. You can then use them for food which should be cooked on level 2.

One level of the side runners consists of two rails. The FlexiClip runners are fitted on the upper rail of the two rails that make up a shelf level.

The FlexiClip runner with the Miele logo is fitted on the right.

When fitting or removing the FlexiClip runners, **do not** extend them.

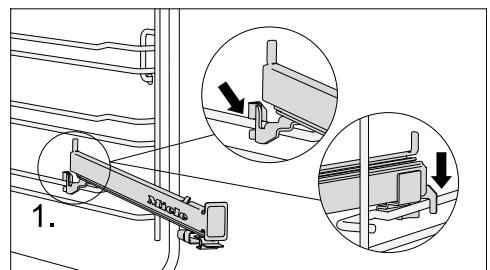

- Hook the FlexiClip runner onto the front of the top rail of a side runner (1.).

Features

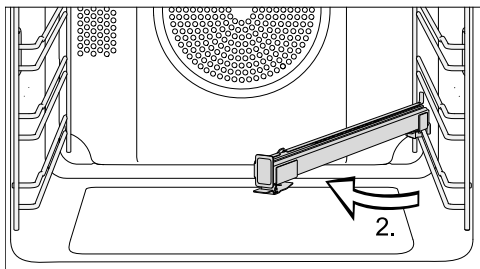

- Then hold the FlexiClip runner at an angle towards the middle of the oven compartment (2.).

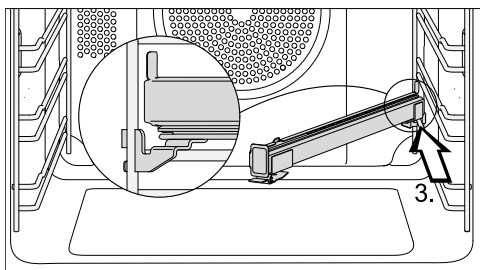

- Slide the FlexiClip runner along the top rail as far as it will go (3.).

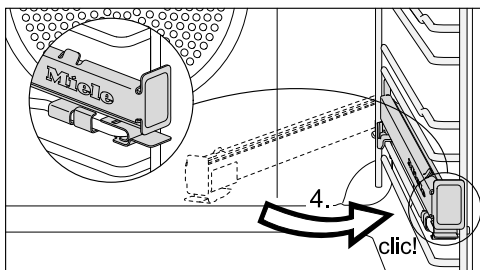

- Then swing the FlexiClip runner back to the side of the oven compartment and secure it to the top rail with an audible click (4.).

If the FlexiClip runners are difficult to pull out after fitting, you may need to pull firmly on them once to release them.

Removing the FlexiClip runners

⚠ Risk of injury caused by hot surfaces.

The oven gets hot during operation. You could burn yourself on the heating elements, oven compartment or accessories.

Allow the heating elements, oven compartment and the accessories to cool before fitting or removing the FlexiClip runners.

- Push the FlexiClip runner in all the way.

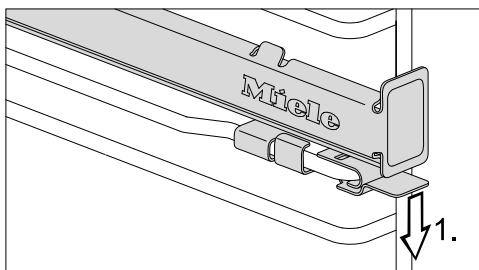

- Push down on the tab at the front of the FlexiClip runner (1.).

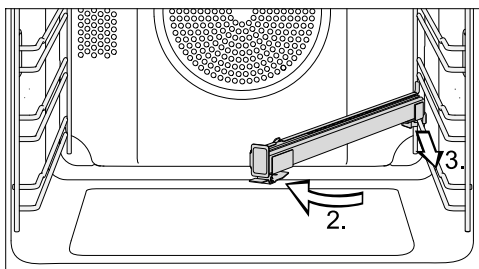

- Swing the FlexiClip runner towards the middle of the oven compartment (2.), then pull it forwards along the top rail (3.).
- Lift the FlexiClip runner off the rail and take it out of the oven.

Gourmet baking and AirFry tray, perforated HBBL 71

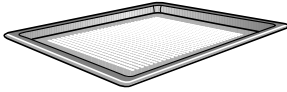

The fine perforations of the Gourmet baking and AirFry tray optimise cooking processes:

- Browning on the underside of baked goods made from fresh yeast and quark doughs as well as bread and rolls is improved.
Roll out the dough on a level surface first and then place it on the Gourmet baking and AirFry tray.
- French fries, croquettes or similar items can be fried in a hot air flow without fat (AirFrying).
- During dehydrating/drying, the air circulation around the food for drying is optimised.

The enamelled surface has been treated with PerfectClean.

The **round baking and AirFry tin, perforated HBFP 27-1** can be used for the same purposes.

Round baking trays



The **solid round baking tray HBF 27-1** is suitable for cooking pizzas, flat cakes made with yeast or creamed mixtures, sweet and savoury tarts, baked desserts, flat bread, and can also be used for frozen cakes and pizzas.

The **perforated round baking and AirFry tin HBFP 27-1** can be used for the same purposes as the **Gourmet baking and AirFry tray, perforated HBBL 71**.

The enamelled surface of both items of bakeware has been treated with PerfectClean.

- Insert the rack and place the round baking tray on the rack.

Grilling and roasting insert HGBB 71

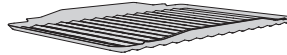

The grilling and roasting insert fits in the universal tray.

When grilling, roasting or AirFrying, the tray will collect meat juices and stop them from burning so that they can be used for making gravy and sauces.

The enamelled surface has been treated with PerfectClean.

Baking stone HBS 70



The baking stone is ideal for items which need a well baked base such as pizza, quiche, bread, bread rolls and savoury snacks.

The baking stone is made from heat-retaining fireclay and is glazed. A paddle made of untreated wood is supplied with the baking stone for placing food on it and taking it off.

- Slide the rack in and place the baking stone on it.

Features

HUB gourmet oven dishes HBD gourmet oven dish lids

Unlike other oven dishes, Miele gourmet oven dishes can be placed in the oven directly on the shelf runners. They have non-tip safety notches like the rack to prevent them from being pulled out too far.

The surface of the oven dish has a non-stick coating.

Gourmet oven dishes are available in different depths. The width and the height are the same.

Suitable lids are available separately. Please quote the model number when ordering.

Depth: 22 cm

HUB 5000-M
HUB 5001-M*

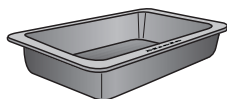

HBD 60-22

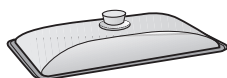

Depth: 35 cm

HUB 5001-XL*

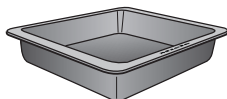

HBD 60-35

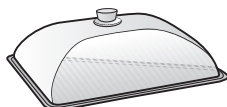

* Suitable for use on induction hobs

Handle HEG

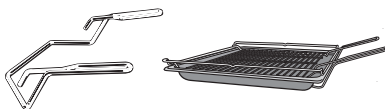

The handle makes it easier to take the universal tray, baking tray and rack out of the oven.

Catalytic enamelled liners

Catalytic enamelled surfaces are self-cleaning, which means that oil and fat are burnt off automatically when very high temperatures are reached inside the oven. See "Cleaning and care" for more information.

- Side liners

The side liners are installed behind the side runners and protect the interior walls against soiling.

- Back panel



This should be replaced if the catalytic enamel has become ineffective due to incorrect use or very heavy soiling.

When ordering, please quote the model number of your oven.

Accessories for cleaning and care

- Miele all-purpose microfibre cloth
- Miele oven cleaner

Safety features

- **System lock** 
(see “Settings – System lock 

PerfectClean treated surfaces

PerfectClean surfaces have very good non-stick properties and are exceptionally easy to clean.

Food can be easily removed from these surfaces. Soiling from baking and roasting can be easily removed from these surfaces.

Food can be sliced or cut up on PerfectClean surfaces.

However, do not use ceramic knives as these will scratch the PerfectClean surface.

Surfaces treated with PerfectClean enamel can be cleaned as you would clean glass.

Read the instructions in “Cleaning and care” so that the benefits of the non-stick properties and easy cleaning are retained.

PerfectClean treated surfaces:

- Oven compartment
- Universal tray
- Baking tray
- Gourmet baking and AirFry tray, perforated
- Grilling and roasting insert
- Round baking tray
- Round baking and AirFry tin, perforated

Before using for the first time

Miele@home

Your oven is equipped with an integrated WiFi module.

In order to use it, you will need:

- A WiFi network
- The Miele app
- A Miele user account The user account can be created via the Miele app.

The Miele app will guide you as you connect your oven to your home WiFi network.

Once your oven is connected to your WiFi network, you can use the app, for example, to carry the following activities:

- Call up information on the operating status of your oven
- Retrieve information on oven cooking programmes that are in progress
- End cooking programmes that are in progress

Connecting your oven to your WiFi network will increase energy consumption, even when the oven is switched off.

Make sure that the signal of your WiFi network is sufficiently strong in the place where your oven is installed.

Availability of the WiFi connection

The WiFi connection shares a frequency range with other appliances (including microwave ovens and remote control toys). This can give rise to sporadic or even complete connection failures. Therefore, the availability of featured functions cannot be guaranteed.

Miele@home availability

The ability to use the Miele app depends on the availability of the Miele@home service in your country.

The Miele@home service is not available in every country.

For information about availability, please visit www.miele.com.

Miele App

The Miele App is available to download free of charge from the Apple App Store® or from the Google Play Store™.



Before using for the first time

Basic settings

The following settings must be made before starting up for the first time. You can change these settings again at a later time (see “Settings”).

 Risk of injury caused by hot surfaces.

The oven gets hot during operation. For safety reasons, the oven may only be used when it has been fully installed.

The oven will switch on automatically when it is connected to the electricity supply. The display will show “Miele” followed by a prompt to set the language after a few seconds.

Setting the language

- Use the rotary selector < > to select the required language.
- Confirm with *OK*.

If you have selected the wrong language by mistake, proceed as described in “Settings – Language 

Setting the location

- Use the rotary selector < > to select the desired location.
- Confirm with *OK*.

Setting up Miele@home

Set up “Miele@home” will appear in the display.

- To set up Miele@home now, confirm by touching *OK*.
- To set it up at a later date, select *Skip* with the rotary selector < > and confirm with *OK*. See “Settings – Miele@home” for information on setting up at a later date.
- To set up Miele@home now, select the desired connection method.

You will then be guided by the display and the Miele app.

Setting the time of day

- Set the time of day in hours and minutes using the rotary selector < >.
- Confirm with *OK*.

Completing the initial commissioning process

Set up finished will appear.

- Confirm with *OK*.

Language  will appear.

- Select the  sensor control.

The time of day appears.

Initial commissioning is now complete.

Before using for the first time

Heating up the oven for the first time

When the oven is heated up for the first time it may give off a slight smell. This can be eliminated by heating the oven for at least an hour.

It is important to ensure that the kitchen is well ventilated during this operation.
Prevent the odour from escaping into other rooms.

- Remove any protective wrapping and stickers from the oven and accessories.
- Before heating the oven up, wipe the oven compartment with a damp cloth to remove any dust or bits of packaging that may have accumulated inside during storage and unpacking.
- Fit the FlexiClip runners (if present) to the side runners and insert all trays and the rack.
- Select  Further with the operating mode selector.

Booster  will appear.

- Confirm with *OK*.

The recommended temperature of 160 °C will appear.

The oven heating, oven interior lighting and cooling fan will switch on.

- Set the maximum temperature (250 °C).
- Heat the oven for at least an hour.
- After the heating-up phase, turn the operating mode selector to **O**.

Cleaning the oven compartment after heating it up for the first time

 Danger of injury caused by hot surfaces.







The oven gets hot during operation. You could burn yourself on the heating elements, oven compartment or accessories.

Allow the heating elements, oven compartment and the accessories to cool before manual cleaning.

- Take all accessories out of the oven compartment and clean them by hand (see “Cleaning and care”).
- Clean the oven compartment with a clean sponge and a solution of hot water and washing-up liquid or a clean, damp microfibre cloth.
- Dry all surfaces with a soft cloth.

Leave the oven door open until the oven compartment is completely dry.

Settings overview

Menu option	Available settings
Language 	... deutsch english ... Location
Time	Display On* Off Night dimming Clock format 12 h 24 h* Set
Display	Brightness 
Volume	Buzzer tones Melodies*  Solo tone  Keypad tone 
Units	Temperature °C* °F
Recommended temps.	
Cooling fan run-on	Temperature controlled* Time controlled
Operating hours	
System lock 	On Off*
Miele@home	Activate Deactivate Connection status Set up again Reset Set up
Remote control	On* Off
RemoteUpdate	On* Off
Software version	
Showroom programme	Demo mode On Off*
Factory default	Appliance settings Recommended temps.

* Factory default setting

Settings

Opening the “Settings” menu

Use the ≡ sensor control to access the “Settings” menu can personalise your oven by adapting the factory default settings to suit your requirements.

- Turn the operating mode selector to **0** or to the Lighting  position.
- Select the ≡ sensor control.

A list of settings will appear in the display.

- Use the rotary selector < > to select the required setting.



You can check settings or change them.

- Select the ≡ sensor control again to quit the menu.

Language

You can set your language and location.

After selecting and confirming your choice, the language you have selected will appear in the display.

Tip: If you have selected the wrong language by mistake, select the ≡ sensor control. Follow the  symbol to get back to the Language  sub-menu.

Time

Display

Select how you want the time of day to show in the display when the oven is switched off:

- On
The time always appears in the display.
- Off
To save energy, the display does not light up.
- Night dimming
To save energy, the time only shows on the display between 5:00 a.m. and 11:00 p.m. The display remains dark at all other times.

Clock format

The time of day can be displayed in the 24 or 12-hour format (24 h or 12 h).

Set



Set the hours and the minutes.

If there is a power cut, the current time of day will reappear once power has been restored. The time of day is saved for approx. 5 minutes.

Display

Brightness

The display brightness is represented by a bar with seven segments.

- 
Maximum brightness
- 
Minimum brightness

Volume



Buzzer tones

If buzzers are switched on, a buzzer will sound when the set temperature is reached and at the end of a set time.

Melodies

At the end of a process, a melody will sound several times in intervals.



The volume of the melody is represented by a bar with seven segments.

- 
Maximum volume
- 
Melody is switched off

Solo tone

At the end of a process, a continuous tone will sound for a period of time.

The pitch of this continuous tone is represented by a segment bar.

- 
Maximum pitch
- 
Minimum pitch

Keypad tone

The volume of the tone that sounds each time you touch a sensor control is represented by a bar with seven segments.

- ■■■■■■■■
Maximum volume
- □■■■■■■□
Tone is switched off

Units

Temperature

You can set the temperature in degrees Celsius (°C) or degrees Fahrenheit (°F).

Recommended temps.

If you often cook with different temperatures, it makes sense to change the recommended temperatures.

After selecting this menu option, the list of operating modes will appear in the display together with their recommended temperatures.

- Select the relevant operating mode.
- Change the recommended temperatures.
- Confirm with *OK*.

Cooling fan run-on

The cooling fan will continue to run for a while after the oven has been switched off to prevent any humidity building up in the oven compartment, on the fascia panel or on the oven housing unit.

- Temperature controlled
The cooling fan switches off when the temperature in the oven drops below 70 °C.
- Time controlled
The cooling fan switches off after a period of about 25 minutes.

Condensate can damage the oven housing unit and the worktop and lead to corrosion in the oven. If you have set the cooling fan to Time controlled and leave food in the oven compartment to keep warm, moisture levels in the oven will increase, leading to condensation forming on the fascia panel and surrounding kitchen furniture, and drops of moisture collecting under the worktop.

Do not leave food in the oven compartment to keep it warm if you have selected Time controlled.

Operating hours

Select Operating hours to query the total number of operating hours of your oven.

System lock

The system lock prevents the oven being switched on by mistake.

The minute minder can still be used when the system lock is active.

The system lock will remain activated even after a power failure outage.

- On
The system lock has been activated. Before you can use the oven, touch the *OK* sensor control for at least 6 seconds.
- Off
The system lock is deactivated. You can use the oven as normal.

Miele@home

The oven is a Miele@home-compatible appliance. Your oven is fitted ex-works with a WiFi communication module and is suitable for wireless communication.

Settings

There are a number of ways of connecting your oven to your WiFi network. We recommend connecting your oven to your WiFi network with the help of the Miele app or via WPS.

- **Activate**
This setting is only visible if Miele@home is deactivated. The WiFi function is reactivated.
- **Deactivate**
This setting is only visible if Miele@home is activated. Miele@home remains set up, the WiFi function is switched off.
- **Connection status**
This setting is only visible if Miele@home is activated. The display shows information such as the WiFi reception quality, network name and IP address.
- **Set up again**
This setting is only visible if a WiFi network has already been set up. Reset the network settings and immediately set up a new network connection.
- **Reset**
This setting is only visible if a WiFi network has already been set up. The WiFi function is deactivated and the WiFi network connection will be reset to the factory default. You must set up a new WiFi network connection to be able to use Miele@home. The network settings should be reset whenever an oven is being disposed of or sold, or if a used oven is being put into operation. This is the only way to ensure that all personal data has been removed and the previous owner will no longer be able to access the oven.
- **Set up**
This setting is only visible if no WiFi network connection has been set up yet. You must set up a new WiFi network connection to be able to use Miele@home.

Remote control

If you have installed the Miele app on your mobile device, have access to the Miele@home system and have activated the remote control function (On), you can set the temperature and cooking duration after selecting an operating mode, retrieve information on cooking processes that are in progress or end a cooking process in progress, for instance.

The oven requires max. 2 W in networked standby.

RemoteUpdate

The RemoteUpdate menu option is only displayed and can only be selected if the requirements for using Miele@home have been met (see “Before using for the first time – Miele@home”).

The RemoteUpdate function is used for updating the software in your oven. If an update is available for your oven, it will automatically download it. Updates will not be installed automatically. They must be initiated manually.

If you do not install an update, you can continue to use your oven as usual. However, Miele recommends installing updates.

Activating/deactivating

The RemoteUpdate function is activated as standard. Available updates will be downloaded automatically but will only be installed if you initiate installation manually.

Deactivate RemoteUpdate if you do not want any updates to be downloaded automatically.

Running a RemoteUpdate

Information about the content and scope of an update will be provided in the Miele app.

A message will appear in your oven display if a software update is available. You can install the update immediately or postpone this until later. When the oven is switched on again, you will be reminded about the update.

Deactivate RemoteUpdate if you do not want to install the update.

The update may take several minutes.

Please note the following information about the RemoteUpdate function:

- You will only receive a message when an update is available.
- Once an update has been installed, it cannot be undone.
- Do not switch the oven off during the update. Otherwise, the update will be aborted and will not be installed.
- Some software updates can only be carried out by the Miele Customer Service Department.

Software version

The software version is intended for the Miele Customer Service Department. You do not need this information for domestic use.

Showroom programme

This function enables the oven to be demonstrated in showrooms without heating up. This setting is not needed for domestic use.

Demo mode

If you have demo mode activated, Demo mode active. The appliance will not heat up will appear when you switch the oven on.

- On
Touch the *OK* sensor control for at least 4 seconds to activate demo mode.
- Off
Touch the *OK* sensor control for at least 4 seconds to deactivate demo mode. You can use the oven as normal.

Factory default

- Appliance settings
Any settings that have been altered will be reset to the factory default settings.
- Recommended temps.
Any recommended temperatures that have been changed will be reset to the factory default settings.

Min. minder

Using the Min. minder function

The  minute minder can be used to time other activities in the kitchen, e.g. boiling eggs.

The minute minder can also be used at the same time as a cooking process for which the cooking duration start and finish times have been set (e.g. as a reminder to stir the food or add seasoning, etc.).

The maximum time that can be set is 59:59 min.

Setting the minute minder

Example: you want to boil some eggs and set a minute minder duration of 6 minutes and 20 seconds.

- Select the  sensor control.
- Select Min. minder if a cooking process is in progress at the same time.

The prompt Set 00:00 min appears.

- Use the rotary selector < > to enter 06:20.
- Confirm with *OK*.

The minute minder duration is now saved.

When the oven is switched off, the minute minder time counts down in the display and  appears instead of the time of day.

If you are cooking at the same time **without** a set cooking duration,  and the minute minder time will appear as soon as the selected temperature is reached.

If you are cooking at the same time **with** a set cooking duration, the minute minder will count down in the background as the cooking duration appears first in the display.

If you are in a menu, the minute minder counts down in the background.

At the end of the minute minder duration,  will flash, a buzzer will sound and the time will start counting up to maximum 59:59 min.

- Select the  sensor control.

The buzzer will stop and the symbols on the display will go out.

Changing the minute minder duration

- Select the  sensor control.
- Select Min. minder if a cooking programme is in progress at the same time.
- Select Change.
- Confirm with *OK*.

The minute minder duration selected appears.

- Change the duration set for the minute minder.
- Confirm with *OK*.











The altered minute minder duration is now saved.

Deleting the minute minder duration

- Select the  sensor control.
- Select Min. minder if a cooking programme is in progress at the same time.
- Select Delete.
- Confirm with *OK*.



The minute minder duration is now deleted.

Overview of functions

Functions	Recommended value	Range
 Fan plus	160 °C	30–250 °C
 Intensive bake	170 °C	50–250 °C
 Eco Fan heat	190 °C	100–250 °C
 Further Booster 	160 °C	100–250 °C
 Further AirFry 	190 °C	30–250 °C
 Conventional heat	180 °C	30–280 °C
 Bottom heat	190 °C	100–280 °C
 Full grill	240 °C	200–300 °C
 Fan grill	200 °C	100–260 °C
 Automatic programmes		

Energy saving tips

Cooking programmes

- Remove all accessories from the oven compartment that are not required for cooking.
- In general, if a range of temperatures is given in a recipe or chart, it is best to select the lower temperature and to check the food after the shortest duration.
- Preheat the oven compartment only if instructed to do so in the recipe or the cooking chart.
- If possible, do not open the door during a programme.
- Use dark, matt bakeware and cooking containers made of non-reflective materials (enamelled steel, heat-resistant glass, coated aluminium). Shiny materials such as stainless steel or aluminium reflect the heat and therefore can give a more uneven food heating result. Do not cover the oven floor or the rack with heat-reflecting aluminium foil.
- Monitor cooking durations to avoid wasting energy when cooking. Set the cooking duration, or use a food probe if you have one.
- The Fan plus  function can be used for cooking many types of food. Because the fan distributes the heat in the oven compartment straight away, it allows you to use a lower temperature than you would with Conventional heat . It also enables you to cook on multiple shelf levels at the same time.
- Eco Fan heat  is an innovative function which is suitable for smaller foodstuffs, e.g. frozen pizzas, part-baked rolls, biscuits and for meat dishes and roasts. Energy-efficient cooking thanks to optimal utilisation of heat. When cooking on a single shelf, up to 30 % less energy is used with comparatively good cooking results. Do not open the door during the cooking programme.

- Fan grill  is the best function for grilled dishes. With this function you can use lower temperatures than in other grill functions which use the maximum temperature setting.
- Whenever possible you should cook multiple foods at the same time. Place them next to each other in the oven or on different shelf levels.
- Foods which you are unable to cook at the same time should, if possible, be cooked one after the other in order to make use of existing heat in the oven.

Residual heat utilisation

- In cooking programmes using temperatures greater than 140 °C and with cooking durations longer than 30 minutes, the temperature can be turned down to the lowest possible level about 5 minutes before the end of the cooking programme. The residual heat in the oven is sufficient for cooking the food until it is done. However, never switch the oven off (see “Warning and safety instructions”).
- If you wish to run the programme for cleaning oil and grease off the catalytic enamelled parts of the oven, it is best to do so immediately after a cooking programme. The residual heat in the oven will help reduce the amount of energy consumed.

Energy-saving mode

The oven will switch itself off automatically to save energy if a programme is not being run and controls have not been operated. The time of day will appear in the display or the display will remain dark (see “Settings”).

Easy to use

- Place the food in the oven.
- Select the required oven operating mode with the operating mode selector.

The operating mode is displayed briefly and then the recommended temperature will appear.

- Change the recommended temperature with the rotary selector < >, if necessary.

The recommended temperature will be accepted within a few seconds. You can change the temperature subsequently via the < > rotary selector.

- Confirm with *OK*.

The actual temperature will appear and the heating-up phase will commence.

You will see the temperature increasing. A buzzer will sound when the set temperature is reached for the first time.

- When the cooking process is finished, turn the operating mode selector to **O**.
- Take the food out of the oven compartment.

Changing values and settings for a cooking programme

Depending on the function, as soon as a cooking programme is in progress, you can change the values or settings for this programme.

Depending on the function, you can change the following settings:

- Temperature
- Duration
- Finish at
- Start at

Changing the temperature

You can permanently reset the recommended temperature to suit your cooking preferences by selecting the \equiv | Recommended temps. sensor control.

- Change the temperature using the rotary selector < >.

The temperature changes in 5 °C steps.

- Confirm with *OK*.

Tip: If you have programmed a cooking duration, you first have to quit the “Cooking duration” menu by touching the \leftarrow sensor control. You can then change the temperature using the rotary selector < >.

Then touch the \oplus sensor control to display the cooking duration again.

Setting cooking durations

Cooking results can be impaired if there is a long delay between the food being placed in the oven and the start of cooking. Fresh food can change colour and even deteriorate. When baking, the cake mixture or dough can dry out, and the raising agents can lose their effectiveness. Select as short as possible a time until the cooking programme starts.

You have placed the food in the oven compartment, selected an operating mode and the required settings such as the temperature.

By entering Duration, Finish at or Start at via the \oplus sensor control, you can automatically switch the cooking process off or on and off.

Operation

- Duration
Enter the required cooking duration for the food. The heating will switch off automatically once this duration has elapsed. The maximum cooking duration that can be set depends on the operating mode that you have selected.
 - Finish at
Specify when you want the cooking process to end. The oven heating will switch off automatically at the time you have set.
 - Start at
This function will only appear in the menu if you have set a Duration or Finish at time. With Start at, you have to specify when you want the cooking process to start. The oven heating will switch on automatically at the time you have set.
- Select the ⌚ sensor control.
 - Set the desired times.
 - Confirm with *OK*.
 - Touch the ↶ sensor control to return to the menu for the selected operating mode.

Changing the set cooking durations

- Select the ⌚ sensor control.
- Select the desired time.
- Confirm with *OK*.
- Select *Change*.
- Change the set time.
- Confirm with *OK*.
- Touch the ↶ sensor control to return to the menu of the selected function.

These settings will be deleted in the event of a power failure.

Deleting the set cooking durations

- Select the ⌚ sensor control.
- Select the desired time.
- Confirm with *OK*.
- Select *Delete*.
- Confirm with *OK*.
- Touch the ↶ sensor control to return to the menu of the selected function.

If you delete Duration, the set times for Finish at and Start at are also deleted.
If you delete Finish at or Start at, the cooking programme will start using the cooking duration set.



Cancelling a cooking process

- Turn the operating mode selector to another operating mode or to the **0** position.

Any cooking durations set will be deleted. If you have turned the operating mode selector to the **0** position, the oven heating and lighting will also switch off.

Pre-heating the oven

The Booster operating mode is used to quickly pre-heat the oven compartment. It is only necessary to pre-heat the oven compartment in a few instances.

- Most dishes can be placed in the cold oven to make use of the heat produced during the heating-up phase.
- Pre-heat the oven when cooking the following food with the following operating modes:
 - Dark bread dough as well as roast beef and fillet with the Fan plus  and Conventional heat  operating modes
 - Cakes and pastries with a short cooking duration (approx. 30 minutes or less) as well as delicate items (e.g. sponge) with the Conventional heat  operating mode

Rapid heat-up

The heating-up phase can be shortened with the Booster  operating mode.

Do not use the Booster  operating mode to pre-heat the oven when baking pizzas or delicate mixtures (e.g. sponges, biscuits). The food will brown too quickly on top.

- Select  Further with the operating mode selector.
- Confirm **Booster** ✓ with *OK*.
- Select a temperature.
- Change to the required operating mode after the set temperature has been reached.
- Place the food in the oven.

Automatic programmes

Using automatic programmes

The automatic programmes enable you to achieve excellent results with ease. Suitable recipes can be found at the end of the operating and installation instructions in the “Automatic programmes recipes” chapter.

- Select Automatic programmes .

A list will appear in the display.

- Select the desired automatic programme.
- Confirm with *OK*.
- Follow the instructions on the display.

Usage notes

- When using automatic programmes, the recipes provided are designed as a guide only. For optimum cooking results, we recommend using the quantities and accessories given in the recipes.
- To find the correct shelf level, please remove the FlexiClip runners HFC 70-C before starting an automatic programme.
- After a cooking process, allow the oven compartment to cool down to room temperature again before starting an automatic programme.
- Some automatic programmes require a pre-heating phase before food can be placed in the oven. This will be indicated in the display.

Handling food carefully will help protect your health.

Cakes, pizzas and french fries should be cooked until golden, not dark brown.

Tips on baking

- Set a cooking duration. If used for baking, do not delay the start for too long. Cake mixture or dough will dry out, and the raising agents will lose their effectiveness.
- Generally speaking, you can use racks, baking trays, universal trays and any type of baking tray made of heat-resistant material.
- Avoid using bright, thin-walled tins as they give an uneven or poor browning result. Under adverse circumstances, the food will not cook properly.
- Position rectangular tins with the longer side across the width of the oven compartment for optimum heat distribution and even baking results.
- Always place bakeware on the rack.
- Bake cakes with fruit toppings or deep cakes on the universal tray.

Using baking parchment

Miele accessories, e.g. the universal tray, are treated with PerfectClean enamel (see “Features”). Surfaces treated with PerfectClean enamel generally do not need to be greased or covered with baking parchment.

- Use baking parchment when baking lye mixtures because the sodium hydroxide used can damage the surface treated with PerfectClean.
- Use baking parchment when baking sponge, meringue, macaroons or similar items. Due to their high egg white content, these are more likely to stick.
- Use baking paper when cooking frozen food on the rack.

Notes on the cooking charts

You can find the cooking charts at the end of this book.

Selecting the temperature

- As a general rule, select the lower temperature given in the chart. Baking at temperatures higher than those recommended may reduce the cooking duration, but will lead to uneven browning of the food, and unsatisfactory cooking results.

Baking

Selecting the cooking duration

Unless otherwise stated, the cooking durations given in the cooking charts are for an oven compartment which has not been pre-heated. With a pre-heated oven compartment, shorten times by around 10 minutes.

- As a general rule, check the food after the shortest duration. Stick a wooden skewer into the food.

If it comes out clean without any batter/dough on it, the food is done.

Notes on the functions

You can find an overview of all the functions with their recommended values in "Overview of functions".

Using Automatic programmes

- Follow the instructions on the display.

Using Fan plus

Because the fan distributes the heat around the oven compartment straight away, it allows you to use a lower temperature than you would with the Conventional heat  function.

Use this function if you are baking on multiple shelves at the same time.

- 1 shelf: place the food in shelf level 2.
- 2 shelves: place the food on shelf levels 1+3 or 2+4.
- 3 shelves: place the food on shelf levels 1+3+5.

Tips

- If you are cooking on multiple shelves at the same time, slide the universal tray in on the lowest level.
- For moist biscuits and cakes, bake on a maximum of 2 shelf levels at once.

Using Intensive bake

Use this function for baking cakes with moist toppings.

Do **not** use this function for baking thin biscuits.

- Place cakes on shelf level 1 or 2.

Using Conventional heat

Dark metal, enamel, or aluminium bakeware with a matt finish, as well as heat-resistant glass, ceramic, and coated bakeware can be used.

Use this function for baking traditional recipes. If using an older recipe or cookbook, set the oven temperature 10 °C lower than the recommended one. This will not change the cooking duration.

- Place the food in shelf level 1 or 2.

Using Eco Fan heat

Use this function for cooking small amounts of food, e.g. frozen pizzas, part-baked rolls or biscuits, while saving energy.

- Place the food in shelf level 2.

Tips for roasting

- You can use all crockery made from temperature-resistant materials, e.g. roasting dishes, roasting pans with lid, ovenproof glass dishes, roasting bags, dishes made from earthenware or cast iron, the universal tray, rack and/or anti-splash insert (if available) on top of the universal tray.
- **Pre-heating** the oven compartment is only required when roasting beef sirloin joints and fillet. Pre-heating is generally not necessary.
- Use a **closed roasting dish** for roasting meat, such as an oven dish. The meat stays succulent. The oven compartment will also stay cleaner than when roasting on the rack. This ensures that sufficient stock remains for making gravy.
- If you are using a **roasting bag**, follow the instructions on the packaging.
- If you are using the **rack** or an **open roasting dish** for roasting, you can add a little fat or oil to very lean meat or place a few strips of streaky bacon on the top.
- **Season** the meat and place in the roasting dish. Dot with butter or margarine or brush with oil or cooking fat if necessary. For large lean cuts of meat (2–3 kg) and fatty poultry add about 1/8 litre of water to the dish.
- Do not add too much liquid during cooking as this will hinder the **browning** process. Browning only occurs towards the end of the cooking duration. Remove the lid about halfway through the cooking duration if a more intensive browning result is desired.



- At the end of the programme, take the food out of the oven compartment, cover it and leave to **stand** for about 10 minutes. This helps retain juices when the meat is carved.
- For a crisp finish, baste **poultry** 10 minutes before the end of the cooking duration with slightly salted water.

Notes on the cooking charts

You can find the cooking charts at the end of this book.

- Take note of the temperature range, the shelf levels and the timings. These also take the type of cooking container, the size of the meat and cooking practices into account.

Selecting the temperature

- As a general rule, select the lower temperature given in the chart. If higher temperatures are used than those specified, the meat will brown on the outside, but will not be properly cooked through.
- When cooking with Fan plus , select a temperature which is approx. 20 °C lower than with Conventional heat .
- For cuts which weigh more than 3 kg, select a temperature approx. 10 °C lower than that given in the cooking chart. The roasting process will take longer, but the meat will cook evenly through and the skin or crackling will not be too thick.
- When roasting on the wire rack, set a temperature approx. 10 °C lower than for roasting in a covered oven dish.

Roasting

Selecting the cooking duration

Unless otherwise stated, the durations given in the cooking chart are for an oven compartment which has not been pre-heated.

■ The traditional British method for calculating the roasting time is to allow 15 to 20 minutes per lb/ 450 grammes, according to type of meat, plus approx. 20 minutes, adjusting the length of time as roasting proceeds to obtain the required result. The roasting time can also be determined by multiplying the thickness of the roast [cm] with the time per cm [min/cm] stated below, depending on the type of meat:

- Beef/venison: 15–18 min/cm
- Pork/veal/lamb: 12–15 min/cm
- Sirloin/fillet: 8–10 min/cm

■ As a general rule, check the food after the shortest duration.

Tips

- For frozen meat, increase the cooking duration by approx. 20 minutes per kg.
- Frozen meat weighing less than approx. 1.5 kg does not need to be defrosted before roasting.

Notes on the functions

You can find an overview of all the functions with their recommended values in “Overview of functions”.

Using Automatic programmes



■ Follow the instructions on the display.

Use the Bottom heat  function towards the end of the cooking duration to brown the base of the food.

Do not use the Intensive bake  function for roasting as the juices will become too dark.

Using Fan plus

This function is suitable for roasting meat, fish and poultry that needs to be well browned as well as sirloin joints and fillet.

The Fan plus  function allows you to use a lower temperature than you would with the Conventional heat  function, because the heat is immediately distributed around the oven compartment.

■ Place the food in shelf level 2.

Using Conventional heat

Use this function for baking traditional recipes. If using an older recipe or cookbook, set the oven temperature 10 °C lower than the recommended one. This will not change the cooking duration.

■ Place the food in shelf level 2.

Using Eco Fan heat

Use this function for cooking smaller roasts or meat dishes while saving energy.

■ Place the food in shelf level 2.

 Risk of injury caused by hot surfaces.

If you grill with the door open, hot air will escape from the oven instead of being cooled by the cooling fan. The control elements will get hot. Grill with the oven door closed.

Tips for grilling

- Pre-heating is necessary when grilling. Pre-heat the top heat/grill element for approx. 5 minutes with the door closed.
- Trim the meat if necessary. Do not season the meat with salt before grilling as this draws the juices out.
- Add a little oil to lean meat if necessary. Do not use other types of fat as they can easily burn and cause smoke.
- Clean fish in the normal way. To enhance the flavour, season with a little salt. Fish can also be drizzled with lemon juice.
- Use the universal tray with the wire rack or the grilling and roasting insert (if present) in place. The juices collect under the insert. This prevents them from spitting and making the oven dirty and they can then be used for making gravy and sauces. Brush the wire rack or the grilling and roasting insert with oil and then place the food on top.

Do not use the baking tray.

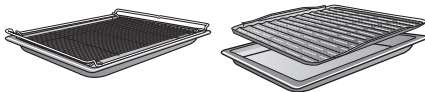

Notes on the cooking charts

You can find the cooking charts at the end of this book.

- Take note of the temperature range, the shelf levels and the durations. These take the size of the meat and cooking practices into account.
- Check the food after the shortest duration quoted.

Selecting the temperature

- As a general rule, select the lower temperature given in the chart. If higher temperatures are used than those specified, the meat will brown on the outside, but will not be properly cooked through.

Choosing a shelf level

- Select the shelf level depending on the thickness of the food to be cooked.
- Place flat food in shelf level 3 or 4.
- Place thicker food in shelf level 1 or 2.

Grilling

Selecting the cooking duration

- Grill thinner cuts of meat/slices of fish for approx. 6–8 minutes per side. It is best to grill food of a similar thickness at the same time so that the cooking durations do not vary too much.
 - As a general rule, check whether the food is cooked after the shortest duration.
 - To **test the food**, press down on the meat with a spoon. This lets you determine how well the meat has been cooked.
- **Rare/pink**
If the meat gives easily to the pressure of the spoon, it will still be red on the inside.
 - **Medium**
If there is some resistance, the inside will be pink.
 - **Well done**
If there is very little resistance, it is cooked through.

Tip: If the surface of a thicker cut of meat is browned but the centre is still raw, move the food to a lower level or reduce the temperature and continue grilling. This will stop the surface from becoming excessively charred.

Notes on the functions

You can find an overview of all the functions with their recommended values in “Overview of functions”.

Using Full grill

Use this function to grill flat thin cuts in large quantities and for browning large baked dishes.

The whole of the top heating/grill element glows red to provide the required heat.

Using Fan grill

This function is suitable for grilling thicker food, such as chicken.

A temperature setting of 220 °C is generally recommended for thinner types of food, while 180–200 °C is recommended for thicker cuts.

Handling food carefully will help protect your health.

Food such as French fries should be cooked until golden, not dark brown.

The AirFry  operating mode is used to fry food in hot air. AirFrying is a gentle method of cooking which achieves even, crispy results.

AirFrying is therefore ideal for cooking frozen food such as French fries or potato croquettes.

Further information on the many options for using AirFrying can be found in the “AirFry recipes” chapter as well as the “Savoury dishes” and “Poultry/fish” cooking charts.

Accessories

- For **foods which do not drip**, e.g. French fries, use the Gourmet baking and AirFry tray, perforated. The fine perforations of the Gourmet baking and AirFry tray ensure that the food is browned and crispy on all sides.



- For **food that drips**, e.g. chicken thighs, use the universal tray with the grilling and roasting insert (if present) placed on top. The tray under the insert will collect the meat juices and stop them from burning so that they can be used for making gravy and sauces. Brush the grilling and roasting insert with oil and then place the food on top.

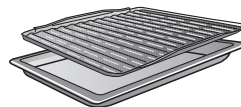

- Place food in bakeware centrally on the rack.

AirFry

AirFrying tips

- Do not defrost frozen food.
- Spread the food evenly over the perforated Gourmet baking and AirFry tray or the grilling and roasting insert in a single layer if possible.
- Place the food in the oven (without pre-heating).
If the food is not crispy enough for you, you can try pre-heating the oven next time.
- Only cook on one level.
Cooking on multiple levels will create too much moisture in the oven compartment and the food will not become crispy.
- As a general rule, food should be placed on shelf level 2.
If you would like more browning on top, you can try using a higher level next time.
- Food such as French fries should be turned halfway through the cooking duration if possible.
Set the minute minder to remind you.

Using the AirFry operating mode

- Spread the food evenly over the perforated Gourmet baking and AirFry tray or the grilling and roasting insert in a single layer if possible.
- Place the food on shelf level 2.
- Select  Further with the operating mode selector.
- Select AirFry with the rotary selector.
- Confirm with *OK*.

The recommended temperature will appear.

- Change the recommended temperature according to the information in the recipe or the cooking chart.
- At the end of the cooking duration, check whether the food is crispy and browned enough for you.

This section provides information on the following applications:

- Defrost
- Low temperature cooking
- Drying
- Frozen food/ready meals
- Heating crockery

Defrost

Gentle defrosting of frozen goods means that the vitamins and minerals are generally retained.

- Select Fan plus  and a temperature of 30–50 °C.

Air is circulated throughout the oven compartment to gently defrost the frozen goods.

 Risk of infection from bacteria.

Bacteria such as salmonella can cause life-threatening food poisoning. It is particularly important to observe food hygiene rules when defrosting fish and meat, and in particular when defrosting poultry.

Do not use the liquid produced during defrosting.

Process the food as required as soon as it has been defrosted.

Tips

- Remove the packaging and place the frozen goods on the universal tray or in a suitable bowl or dish.
- Use the universal tray with the rack placed on top of it for defrosting poultry. This way the frozen goods will not be lying in the defrosted liquid.
- Meat, poultry or fish does not need to be fully defrosted before cooking. Defrost until the food has started to thaw. The surface will then be sufficiently thawed to take herbs and seasoning.

Further applications

Low temperature cooking

Low temperature cooking is ideal for cooking delicate cuts of beef, pork, veal or lamb when a tender result is desired.

First sear the meat all over at a high temperature on the hob in order to seal it.

Then place the meat in the pre-heated oven compartment where the low temperature and long cooking duration will cook it to perfection and ensure it is very tender.

The meat will relax. The juices inside will start to circulate evenly throughout the meat to reach the outer layers.

This gives very tender and succulent results.

- Only use lean meat which has been correctly hung and trimmed. Bones must be removed before cooking.
- For searing, use a suitable cooking oil or fat that can withstand high temperatures (e.g. clarified butter, vegetable oil).
- Do not cover meat during the cooking process.

The cooking duration takes approx. 2–4 hours depending on the weight and size of the meat and how well you want it cooked.

- As soon as the cooking process is done, you can carve the meat straight from the oven. It does not need to rest.
- The meat can be left in the oven compartment to keep warm until you serve it. This will not affect results in any way.
- Serve on pre-heated plates with very hot sauce or gravy to prevent it cooling down too quickly. The meat is at the ideal temperature for eating straight away.

Using Conventional heat

Follow the information in the cooking charts at the end of this book.

Use the universal tray with the rack placed on top of it.

- Place the rack together with the universal tray on shelf level 2.
- Select the Conventional heat  function and a temperature of 120 °C.
- Pre-heat the oven together with the universal tray and rack for approx. 15 minutes.
- Whilst the oven is pre-heating, sear the meat thoroughly on all sides on the hob.

 Danger of burning due to hot surfaces.

The oven gets hot during operation. You could burn yourself on the heating elements, oven compartment or accessories.

Use oven gloves when placing hot food in the oven or removing it and when working in the hot oven compartment.

- Place the seared meat on the rack.
- Reduce the temperature to 100 °C (see “Cooking charts”).
- Continue cooking the meat until it is done.

Further applications

Drying

Dehydrating or drying is a traditional method of preserving fruit, certain vegetables and herbs.





It is important that fruit and vegetables are ripe and not bruised before they are dried.





- Peel and core the food for drying, if necessary, and cut it up.
- Depending on how big it is, distribute the food for drying evenly in a single layer (if possible) over the baking and roasting rack or the universal tray.

Tip: You can also use the perforated Gourmet baking and AirFry tray, if you have one.

- Dry on a maximum of 2 levels at the same time.
Place the food for drying on shelf levels 1+3.
If using the baking and roasting rack and universal tray, place the universal tray below the rack.
- Select Fan plus .
- Change the recommended temperature and set the drying time.
- Turn the food for drying on the universal tray at regular intervals.

The drying times are longer for whole or halved food items.

Food for drying		🌡️ [°C]	🕒 [h]
Fruit		60–70	2–8
Vegetables		55–65	4–12
Mushrooms		45–50	5–10
Herbs*		30–35	4–8

-  Operating mode, 🌡️ Temperature,
-  Drying time,  Fan plus,
-  Conventional heat

*When drying herbs, always use the universal tray on shelf level 2 and use the Conventional heat  operating mode, as the fan is switched on in the Fan plus operating mode.

- Reduce the temperature if condensation begins to form in the oven compartment.

Removing the dried food

 Risk of injury caused by hot surfaces.

The oven gets hot during operation. You could burn yourself on the heating elements, oven compartment or accessories.

Use oven gloves when removing dried food from the oven.

- Allow the dried fruit or vegetables to cool down after drying.

Dried fruit needs to be completely dry, but also soft and elastic. Juice should not escape when cut.

- Store dried food in sealed glass jars or tins.

Further applications

Frozen food/Ready meals

Tips for French fries, croquettes and similar items

Use the AirFry  operating mode to cook these frozen foods (see “AirFry”).

Tips for cakes, pizza and baguettes

- Bake cakes, pizza and baguettes on baking paper on the rack. Do not use the baking tray or the universal tray for frozen foods with a large surface area. The tray could become warped and difficult, or even impossible, to remove from the oven compartment when hot. Additional use will make the warping worse.
- Use the lowest temperature recommended on the packaging.

Preparing frozen food/ready meals

Handling food carefully will help protect your health.

Cakes, pizzas and french fries should be cooked until golden, not dark brown.

- Select the function and temperature recommended on the packaging.
- Pre-heat the oven compartment.
- Place the food in the pre-heated oven compartment on the shelf level recommended on the packaging.
- Check the food at the end of the shortest cooking duration recommended on the packaging.

Heat crockery

Use the Fan plus  operating mode for pre-heating crockery.

Only pre-heat heat-resistant crockery.

- Place the wire rack on shelf level 1 and place the crockery to be pre-heated on it. Depending on the size of the crockery, you can also place the rack on the oven floor and take the side runners out to make more room.
- Select Fan plus .
- Set the temperature to 50–80 °C.

Risk of burns!

Use oven gloves when removing the crockery from the oven. Droplets of water may have accumulated underneath the crockery.

- Remove the heated crockery from the oven.

 Danger of injury caused by hot surfaces.

The oven gets hot during operation. You could burn yourself on the heating elements, oven compartment or accessories.

Allow the heating elements, oven compartment and the accessories to cool before manual cleaning.

 Risk of injury due to electric shock.

The steam from a steam cleaning appliance could reach live electrical components and cause a short circuit. Never use a steam cleaner for cleaning.

Surfaces can discolour or alter if unsuitable cleaning agents are used. The oven front is particularly susceptible to damage from oven cleaners or descaling agents.

All surfaces are susceptible to scratching. Scratches on glass can in some circumstances lead to breakage.

Remove all cleaning agent residues immediately.

Unsuitable cleaning agents

To avoid damaging the surfaces, do not use:

- Cleaning agents containing soda, ammonia, acids or chlorides
- Cleaning agents containing descaling agents on the front
- Abrasive cleaning agents (e.g. powder cleaners, scouring milk, scouring pads)
- Solvent-based cleaning agents
- Stainless steel cleaners
- Dishwasher cleaning agents

- Glass cleaning agents
- Cleaning agents for ceramic glass hobs
- Hard, abrasive brushes or sponges (e.g. pot scourers, brushes or sponges which have been previously used with abrasive cleaning agents)
- Stain remover eraser blocks
- Sharp metal scrapers
- Steel wool
- Spot cleaning with mechanical cleaning agents
- Oven cleaners
- Stainless-steel spiral pads

If soiling is left on for any length of time, it may become impossible to remove. If items are used frequently without being cleaned, it may become very difficult to clean them. It is therefore best to remove any soiling immediately.

The accessories are not dishwasher-safe.

Tip: Soiling caused by spilt fruit juices and cake mixtures is best removed while the oven compartment is still warm.

To make it easier to clean the oven:

- Remove the door.
- Take out the side runners with FlexiClip runners (if fitted).
- Remove the catalytic enamelled back panel.

Removing normal soiling

Removing normal soiling

- Remove normal soiling immediately with warm water, washing-up liquid and a clean sponge or a clean, damp microfibre cloth.

Cleaning and care

- Remove all cleaning agent residues thoroughly with clean water. This is particularly important for any parts with a PerfectClean finish, as cleaning agent residues will impair the non-stick function.
- After cleaning, wipe the surfaces dry using a soft cloth.

Cleaning the seal

There is a seal around the oven compartment to seal it off from the inside of the door.

Grease deposits on the seal can cause it to become brittle and cracked.

- It is advisable to wipe the seal clean after each use.

Removing stubborn soiling (excluding the FlexiClip runners)

Spilt fruit and roasting juices may cause lasting discolouration or matt patches on surfaces. This discolouration will not affect the properties of the surface finish. Do not attempt to remove these stains. Only use the equipment specified.

- Baked-on deposits can be removed with a glass scraper or with a stainless-steel spiral pad (e.g. Spontex Spirinett), hot water and washing-up liquid.

Exposure to scouring agents, abrasive brushes or sponges and oven cleaner can cause catalytic enamel to lose its self-cleaning properties. Remove the catalytic enamelled panels before using an oven cleaner.

Using oven cleaners

- Very stubborn soiling on PerfectClean surfaces can be cleaned using the Miele oven cleaner, which must only be applied to cold surfaces.

If the oven spray gets into gaps and openings, a strong odour is generated during subsequent cooking programmes.

Do not spray the oven cleaner onto the roof of the oven compartment.

Do not spray the oven cleaner into the gaps and openings of the oven compartment walls and rear wall.

- Follow the instructions on the packaging.

Oven cleaners from other manufacturers must only be used in a cold oven and for no longer than a maximum of 10 minutes.

- You can then also use the scouring pad on the back of a washing-up sponge to remove the soiling.
- Remove all cleaning agent residues thoroughly with clean water.
- Dry all surfaces with a soft cloth.

Stubborn soiling on the FlexiClip runners

Cleaning FlexiClip telescopic runners in a dishwasher would remove the special grease which is essential for their smooth functioning.

Never attempt to clean FlexiClip telescopic runners in a dishwasher.

For stubborn surface soiling or if the bearings become sticky with spilled fruit juices proceed as follows:

- Soak the FlexiClip runners for approx. 10 minutes in a solution of hot water and washing-up liquid. If necessary use the back of a washing-up sponge to remove the soiling. The bearings can be carefully cleaned with a soft brush.

Cleaning may cause some discolouration or fading in places, however this will not affect the functioning of the runners in any way.

Cleaning the catalytic enamelled back panel

Catalytic enamel is self-cleaning, which means that oil and fat are burnt off automatically when very high temperatures are reached inside the oven. You do not require any additional cleaning agents. The higher the temperature, the more effective the process.

Exposure to scouring agents, abrasive brushes or sponges and oven cleaner can cause catalytic enamel to lose its self-cleaning properties.

Remove the catalytic enamelled parts before using an oven cleaner in the oven compartment.

Removing soiling caused by spices, sugar and similar deposits

- Remove the back panel (see “Cleaning and care – Removing the back panel”).
- Clean the back panel by hand with a solution of hot water and washing-up liquid applied with a soft brush.
- Rinse the back panel thoroughly.
- Let the back panel dry before placing it back in the oven.

Removing oil and grease

- Remove any accessories from the oven compartment, including the side runners.
- Before starting the cleaning process, remove any large deposits of soiling from the inside of the door and the PerfectClean surfaces to prevent them burning on.
- Select the Fan plus  function and 250 °C.
- Then heat the empty oven for at least 1 hour.

The length of time required will depend on the level of soiling.

If the catalytic coating is very heavily soiled with oil and grease, a film can form on the oven compartment surface during the cleaning process.

 Risk of injury caused by hot surfaces.

The oven gets hot during operation. You could burn yourself on the heating elements and oven compartment.

Allow the heating element and oven compartment to cool before manual cleaning.

- Clean the inside of the door and the oven compartment with a solution of hot water and washing-up liquid, applied with a clean sponge or a clean, damp microfibre cloth.

Any remaining soiling will gradually disappear with each subsequent use of the oven at high temperatures.

Cleaning and care

Door removal

The door weighs approx. 9 kg.

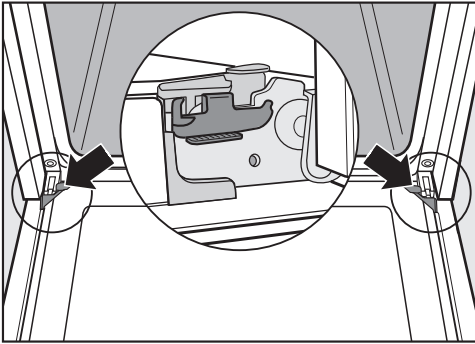

The oven door is connected to the door hinges by retainers.

Before removing the door from the retainers, the locking clamps on both door hinges have to be released.

- Open the door fully.

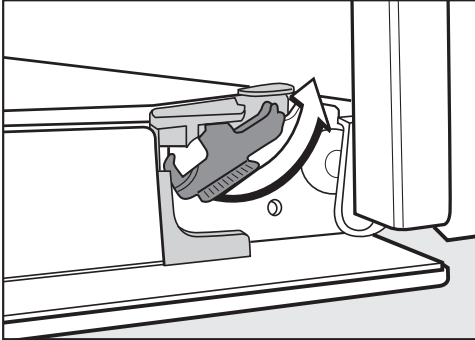

- Release the locking clamps by turning them as far as they will go.

- Raise the door up till it rests partially open.



- Hold the door on either side and pull it diagonally upwards off the retainers. Make sure that the door goes back on straight.

The oven could become damaged if you incorrectly remove the door. Never pull the door horizontally off its retainers, as they will spring back against the oven. Never pull the door off the retainers by the handle, as the handle could break off.

Dismantling the door

The oven door is an open system with 3 glass panes which have a heat-reflective coating on some of their surfaces.

When the oven is operating, air is directed through the door to keep the outer pane cool.

If soiling has worked its way in between the glass panes, the door can be dismantled in order to clean in between the panes.

Scratches on the door glass can cause the glass to break.

Do not use abrasive cleaners, hard sponges, brushes or sharp metal tools to clean the door glass.

When cleaning the door glass, you must also follow the instructions that apply to the oven front.

Oven cleaners will damage the surface of the aluminium profiles. Only clean these parts with warm water and washing-up liquid, applied with a clean sponge cloth or a clean, damp microfibre cloth.

The door glass could break if dropped.

Keep the disassembled door glass in a safe place.

 Risk of injury caused by the door slamming shut.

The door may slam shut if you attempt to disassemble it when it is fitted to the oven.

Always remove the door before disassembling it.

- Place the door with the outer glass pane on a soft surface (e.g. a tea towel) to prevent it getting scratched.

The door handle should line up with the edge of the table so that the glass lies flat and does not get broken during cleaning.

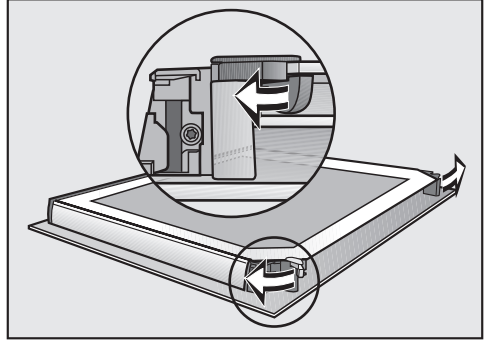

- Flip the two glass pane retainers outwards to open them.

Remove the inner pane:

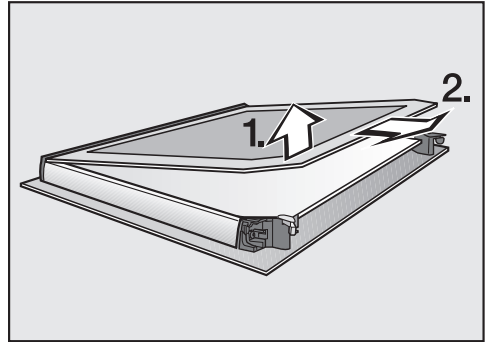

- Gently lift the inner pane up and out of the plastic strip.

Cleaning and care

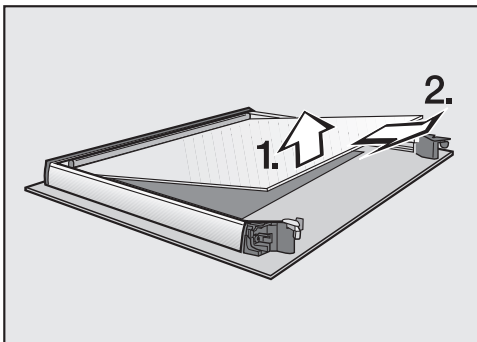

- Lift the middle pane up **gently** and pull it out.
- Clean the door panes and other parts with a clean sponge and a solution of hot water and washing-up liquid or a clean, damp microfibre cloth.
- Dry all parts with a soft cloth.

Then reassemble the door carefully:

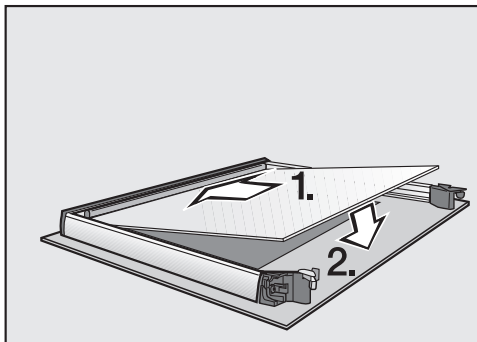

- Refit the middle pane in such a way that the material number is legible (not reversed).

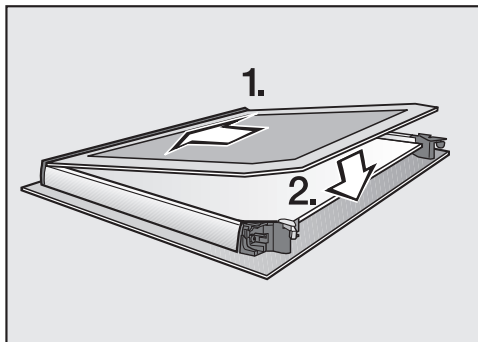

- Push the inner pane with the matt printed side facing downwards into the plastic strip and place it between the retainers.

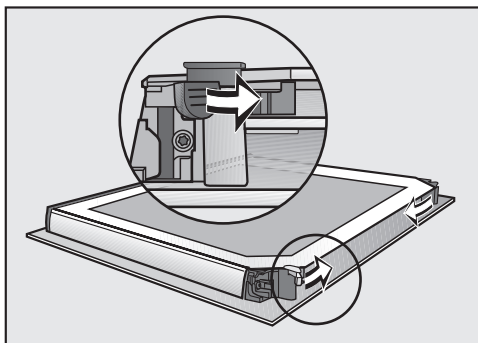

- Flip both the glass pane retainers inwards to close them.

The door is now reassembled.

Fitting the door

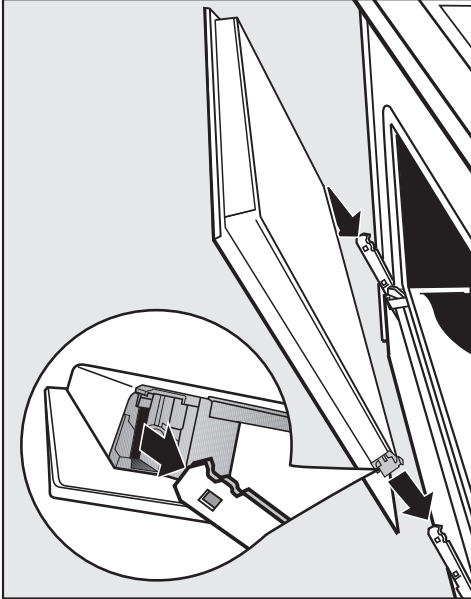

- Hold the door securely on both sides and carefully fit it back into the hinge retainers. Make sure that you fit the door straight.
- Open the door fully.

If the locking clamps are not locked, the door could become loose, resulting in damage. Always ensure that the locking clamps are locked after refitting the door.

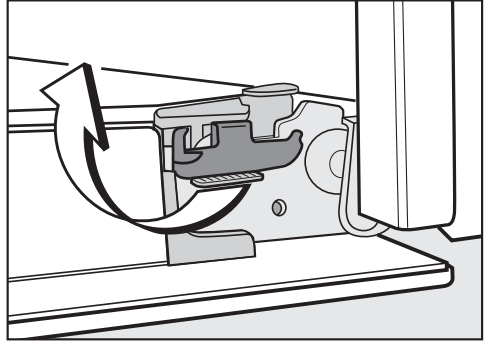

- To relock the locking clamps, turn them back up to the horizontal position as far as they will go.

Removing the side runners with FlexiClip runners

The side runners can be removed together with the FlexiClip runners (if inserted).

If you wish to remove the FlexiClip runners separately beforehand, please follow the instructions in “Features” – “Fitting and removing FlexiClip runners”.

 **Danger of injury caused by hot surfaces.**

The oven gets hot during operation. You could burn yourself on the heating elements, oven compartment or accessories.

Allow the heating elements, oven compartment and accessories to cool before removing the side runners.

Cleaning and care

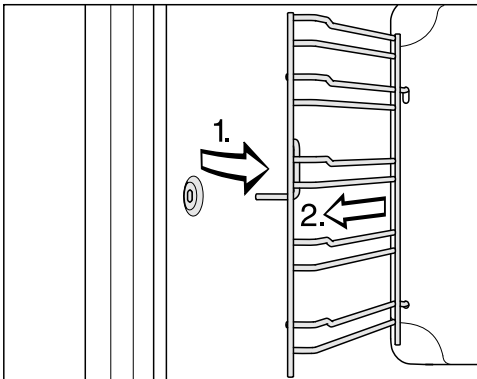

- Pull the side runners out of holder (1.) and remove them (2.).

Reassemble by following these instructions in reverse order.

- Insert the components carefully.

Removing the back panel

The back panel can be removed for cleaning purposes.

⚠ Risk of injury caused by hot surfaces.

The oven gets hot during operation. You could burn yourself on the heating elements, oven compartment or accessories.

Allow the heating element, oven compartment and the accessories to cool before removing the rear panel.

⚠ Risk of injury caused by the rotating fan impeller.

You could injure yourself on the impeller of the hot air fan.

Never put the oven into operation without the back panel in place.

- Disconnect the appliance from the mains. Switch off at the wall and withdraw the plug from the socket, or switch off at the isolator, or switch off the fuse of the electrical installation.
- Remove the side runners.
- Undo the four screws at the corners of the back panel and take it out.
- Clean the back panel (see “Cleaning and Care – Cleaning the catalytic enamelled back panel”).

Reassemble by following these instructions in reverse order.

- Refit the back panel carefully.

Make sure the openings are located as illustrated in the “Overview” section.



- Refit the side runners.
- Reconnect the appliance to the electricity supply.

Problem solving guide

Many malfunctions and faults that can occur in daily operation can be easily remedied. You can save time and money in many cases, as you do not need to call the Miele Customer Service Department.

Information to help you rectify faults yourself can be found at www.miele.com/service.



The following tables are designed to help you to find the cause of a malfunction or a fault and to resolve it.

Problem	Cause and remedy
The display is dark.	You have selected the Time Display Off setting. When the oven is switched off, the display is dark. <ul style="list-style-type: none"> ■ If you want the time of day to be displayed constantly, select the Time Display On setting.
	There is no power to the oven. <ul style="list-style-type: none"> ■ Check that the oven plug is correctly inserted into the socket and switched on. ■ Check whether the fuse has tripped. Contact a qualified electrician or the Miele Customer Service Department.
The buzzer does not sound.	The buzzers are deactivated or set at too low a volume. <ul style="list-style-type: none"> ■ Switch on the buzzers or increase the volume with the Volume Buzzer tones setting.
The oven compartment does not heat up.	Demo mode is activated. You can select operating modes and sensor controls, but the oven heating does not work. <ul style="list-style-type: none"> ■ Deactivate demo mode with the Showroom programme Demo mode Off setting.
System lock  appears in the display.	The  system lock has been activated. <ul style="list-style-type: none"> ■ Confirm with <i>OK</i>. Press "OK" for 6 secs will appear. <ul style="list-style-type: none"> ■ You can deactivate the system lock for a cooking process by touching the <i>OK</i> sensor control for at least 6 seconds. ■ If you want to permanently deactivate the system lock, select the System lock  Off setting.
12:00 appears in the display.	The power supply was interrupted for longer than 5 minutes. <ul style="list-style-type: none"> ■ Reset the time of day (see "Settings – Time of day"). Cooking process times will also need to be reset.
Power cut appears in the display.	There has been a brief power cut. This has caused the current cooking process to stop. <ul style="list-style-type: none"> ■ Turn the operating mode selector to 0. ■ Restart the cooking process.

Problem solving guide

Problem	Cause and remedy
Max. op. hours reached appears in the display.	<p>The oven has been operating for an unusually long time. This has triggered the safety switch-off function.</p> <ul style="list-style-type: none"> ■ Confirm with <i>OK</i>. <p>The oven is now ready to use.</p>
Fault and a fault code not listed here appears in the display.	<p>A fault has occurred that you cannot resolve.</p> <ul style="list-style-type: none"> ■ Call the Miele Customer Service Department.
A noise can be heard after a cooking programme.	<p>The cooling fan remains switched on after a cooking programme (see “Settings – Cooling fan run-on”).</p>
The oven has switched itself off.	<p>To save power, the oven switches off automatically if a button is not pressed after a certain amount of time or after a cooking programme has ended.</p> <ul style="list-style-type: none"> ■ Switch the oven back on.
Cakes/biscuits are not cooked properly after the duration given in the cooking chart.	<p>A different temperature from the one given in the recipe was used.</p> <ul style="list-style-type: none"> ■ Select the temperature required for the recipe.
	<p>The ingredient quantities are different from those given in the recipe.</p> <ul style="list-style-type: none"> ■ Check whether you amended the recipe. The addition of more liquid or more eggs makes a moister mix which requires a longer cooking duration.
The browning of the baked goods is uneven.	<p>The wrong temperature or shelf level was selected.</p> <ul style="list-style-type: none"> ■ There will always be a slight unevenness in browning. If browning is very uneven, check whether the correct temperature and shelf level were selected.
	<p>The material or colour of the bakeware is not suitable for the oven function selected.</p> <ul style="list-style-type: none"> ■ When using the Conventional heat  function, light coloured, shiny tins will not produce as desirable results. Dark, matt tins are best for baking.

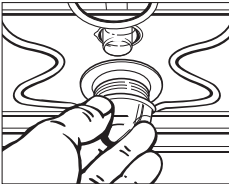
Problem solving guide

Problem	Cause and remedy
<p>Spots like rust appear on catalytic enamelled surfaces.</p>	<p>The catalytic cleaning process does not remove spices, sugar and similar deposits.</p> <ul style="list-style-type: none"> ■ Take the catalytic enamelled panels out of the oven and remove this type of deposit with a mild solution of hot water and washing-up liquid applied with a soft brush (see “Cleaning and care – Cleaning the catalytic enamelled back panel”).
<p>The FlexiClip runners do not push in or pull out smoothly.</p>	<p>The bearings in the FlexiClip runners are not sufficiently lubricated.</p> <ul style="list-style-type: none"> ■ Lubricate the bearings with the special Miele lubricant. Only the special Miele lubricant is designed for the high temperatures in the oven compartment. Other lubricants may resinify when heated and will gum up the FlexiClip runners. You can obtain the special Miele lubricant from your Miele dealer or from the Miele Customer Service Department.
<p>The oven interior lighting does not switch on.</p> 	<p>The halogen lamp is faulty.</p> <div style="border: 1px solid gray; padding: 5px; margin: 5px 0;"> <p> Risk of injury caused by hot surfaces. The oven gets hot during operation. You could burn yourself on the heating elements, oven compartment or accessories. Allow the heating elements, oven compartment and the accessories to cool before manual cleaning.</p> </div> <ul style="list-style-type: none"> ■ Disconnect the appliance from the mains. Switch off at the wall and withdraw the plug from the socket or switch off the fuse of the electrical installation. ■ Turn the lamp cover a quarter turn anti-clockwise to release it and then pull it together with its seal downwards to take it out. ■ Replace the halogen lamp (Osram 66725 AM/A, 230 V, 25 W, G9). ■ Refit the lamp cover together with its seal and turn clockwise to secure. ■ Reconnect the appliance to the electricity supply.

Service

Information to help you rectify faults yourself and about Miele spare parts can be found at www.miele.com/service.

Contact in the event of a fault

In the event of any faults which you cannot remedy yourself, please contact your Miele dealer or the Miele Customer Service Department.

You can book a Miele Customer Service Department call-out online at www.miele.com/service.

Contact information for the Miele Customer Service Department can be found at the end of this document.

Please quote the model identifier and serial number of your appliance (Fabr./SN/Nr.) when contacting the Miele Customer Service Department. This information can be found on the data plate.

Please note that telephone calls may be monitored and recorded for training purposes and that a call-out charge will be applied to service visits where the problem could have been resolved as described in this booklet.

This information is given on the data plate, which is visible on the front frame of the oven when the door is fully open.

Warranty

For information on the appliance warranty specific to your country please contact Miele. See back cover for address.

In the UK, your appliance warranty is valid for 2 years from the date of purchase. However, you must activate your cover by calling 0330 160 6640 or registering online at www.miele.co.uk.

Installation dimensions

Dimensions are given in mm.

Installation in a tall or base unit

When building the oven into a base unit underneath a hob, please also observe the installation instructions for the hob as well as the building-in depth required for the hob.

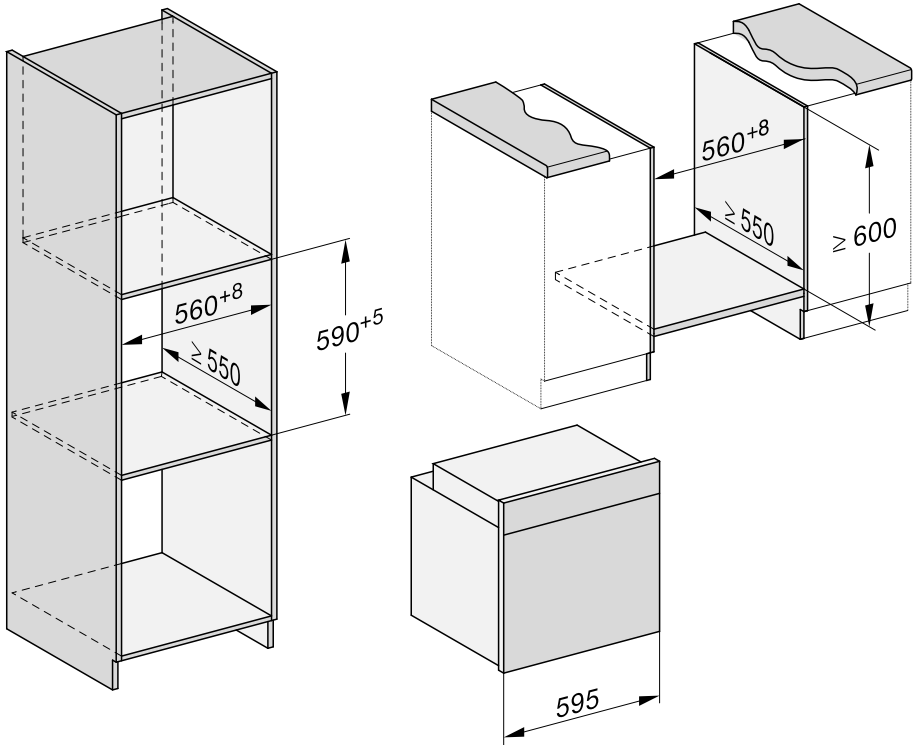

Installation

Side view H 24xx

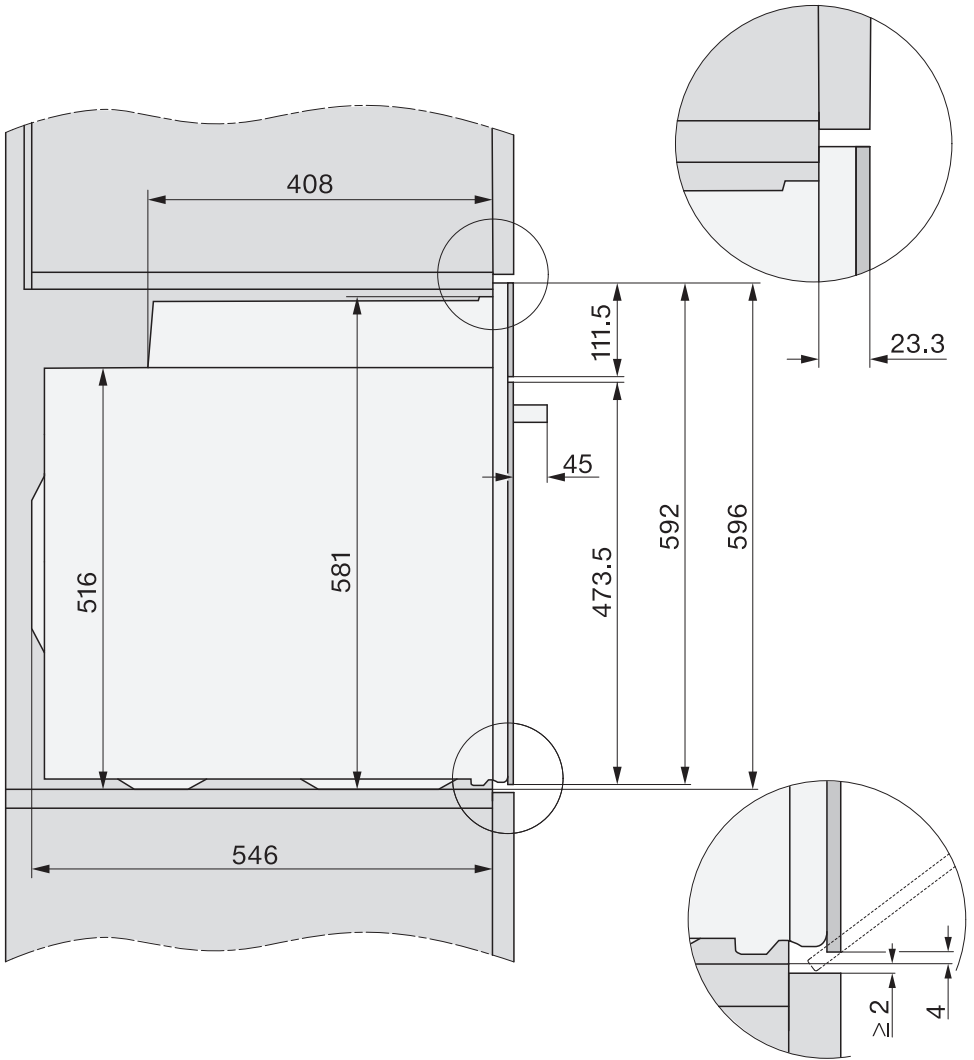

Side view H 28xx, H 27xx

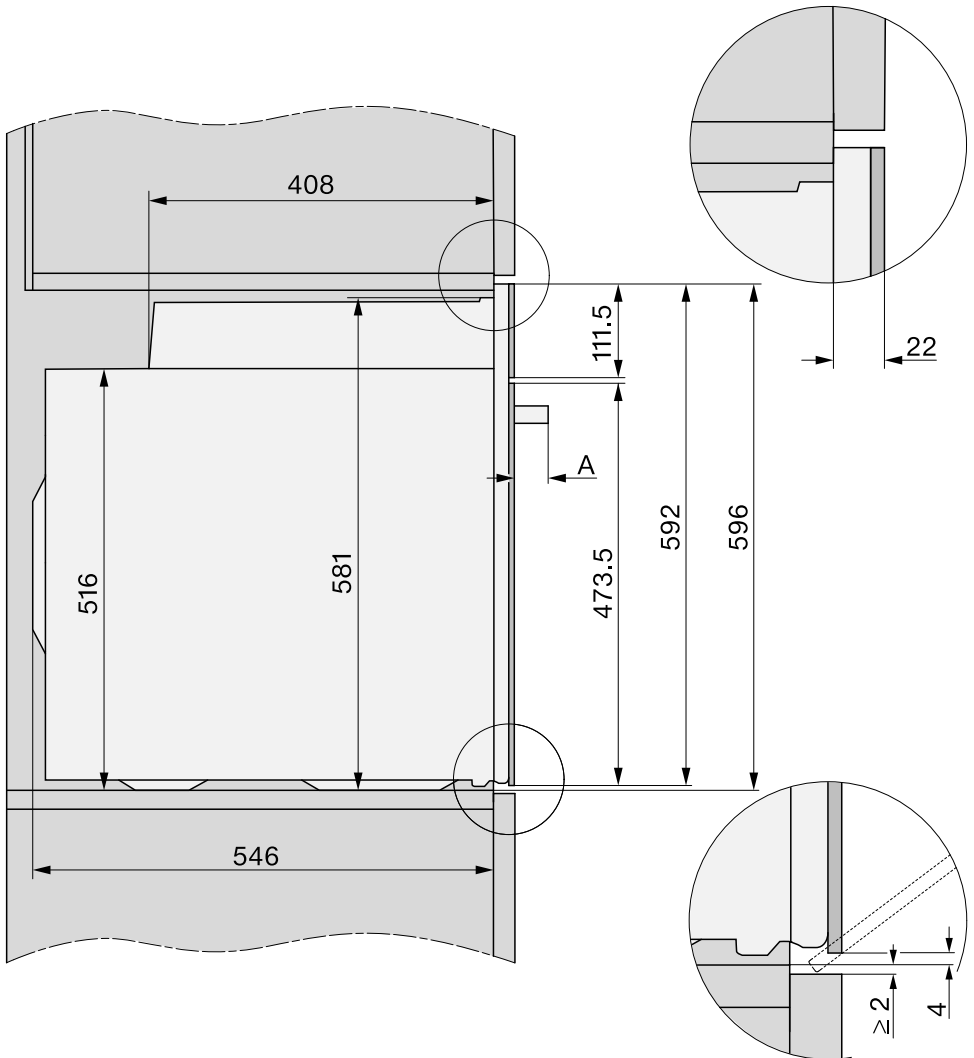

A H 27xx: 43 mm

H 28xx: 47 mm

Installation

Connections and ventilation

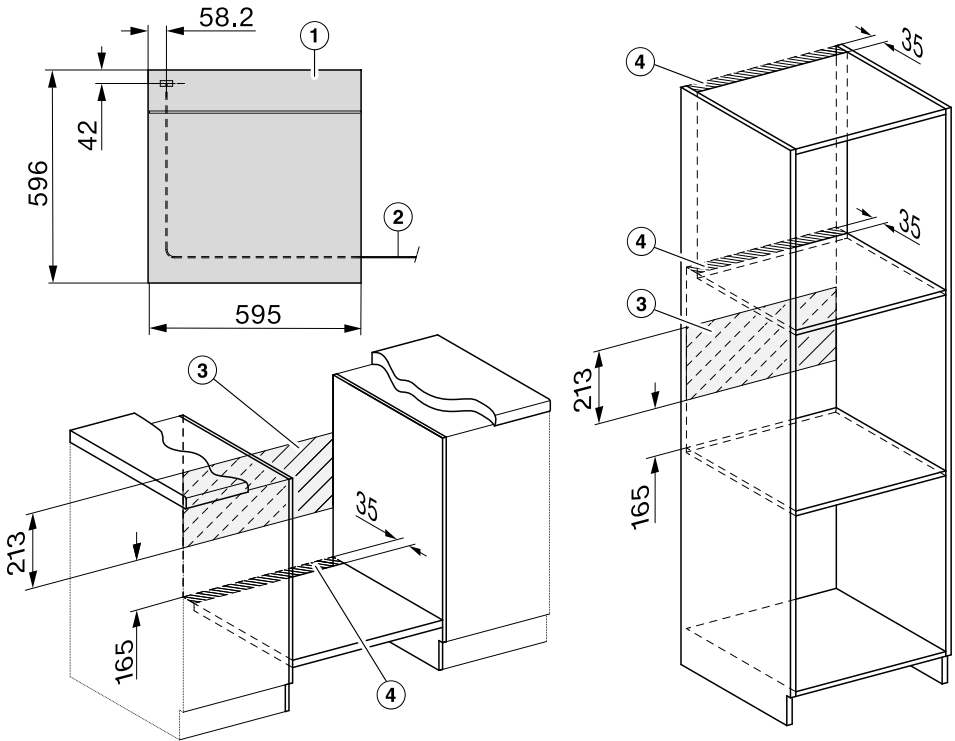

- ① Front view
- ② Mains connection cable, length = 1500 mm
- ③ No connections permitted in this area
- ④ Ventilation cut-out, min. 150 cm²

Installing the oven

For safety reasons, the oven may only be used when it has been fully installed.

The oven requires a sufficient supply of cool air for efficient operation. The required supply of cool air must not be excessively heated by other heat sources (e.g. solid fuel stoves).

The following must be observed when installing the appliance:
Make sure that the shelf that the oven sits on does not touch the wall.
Do not fit heat insulation strips to the side walls of the housing unit.

- Connect the oven to the electrical supply.

Carrying the oven by the door handle could damage the door.

Use the recessed grips on the side of the housing to carry the appliance.

It is a good idea to remove the door (see “Cleaning and care” – “Removing the door”) and the accessories before installing the appliance. This makes the oven lighter when you push it into the housing unit and you do not run the risk of lifting it by the door handle by mistake.

- Push the oven into the housing unit and align it.
- Open the door, if you have not removed it.

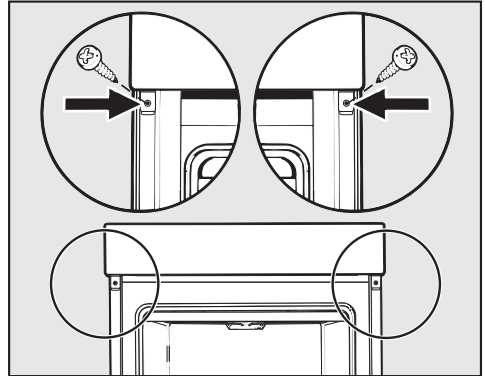

- Use the screws supplied to secure the oven to the side walls of the housing unit.
- Refit the door if necessary (see “Cleaning and care” – “Fitting the door”).

Installation

Electrical connection



Danger of injury!
Installation, repairs and other maintenance work by unqualified persons could be dangerous. Miele cannot be held liable for unauthorised work.

The appliance may only be connected to the mains electricity supply by a qualified electrician who is familiar with and complies with the national regulations and any additional regulations of the local electricity provider.

The appliance must be connected to an electrical system designed in accordance with VDE 0100.

Connection to a switched socket (in accordance with VDE 0701) is recommended as this provides easier access in the case of a service call.

If the appliance is **hardwired** or if the plug is not accessible, an additional means of disconnection must be provided for all poles.

Suitable means of disconnection include switches with an all-pole contact gap of at least 3 mm. These include circuit breakers, fuses and contactors (EN 60335).

Connection data is given on the data plate situated at the front of the oven compartment. Please ensure the connection data matches the household supply.

When contacting Miele, please quote the following:

- Model identifier
- Serial number
- Connection data (mains voltage/frequency/maximum rated load)

When replacing the cable supplied with another cable or changing the connection, only cable type H 05 VV-F with a suitable cross-sectional area (CSA) may be used.

Temporary or permanent operation on an autonomous power supply system or a power supply system that is not synchronised with the mains power supply (e.g. island networks, back-up systems) is possible. A prerequisite for operation is that the power supply system complies with the specifications of EN 50160 or an equivalent standard. The function and operation of the protective measures provided in the domestic electrical installation and in this Miele product must also be maintained in isolated operation or in operation that is not synchronised with the mains power supply, or these measures must be replaced by equivalent measures in the installation. As described, for example, in the current version of VDE-AR-E 2510-2.

Oven

The wires in the mains lead are coloured as follows:

Green/yellow = earth

Blue = neutral

Brown = live



WARNING - THIS APPLIANCE MUST BE EARTHED

For extra safety it is advisable to protect the appliance with a suitable residual current device (RCD).

Maximum connected load: see data plate.

Electrical connection: Other countries

All electrical work should be carried out by a suitably qualified and competent Miele approved service technician in strict accordance with local and national safety regulations.

Connection should be made via a fused connection unit or a suitable isolator, which complies with national and local safety regulations, and the on/off switch should be easily accessible after the appliance has been installed.

If the switch is not accessible after installation (depending on country) an additional means of disconnection must be provided for all poles.

Switches with a minimum all-pole contact gap of 3 mm are suitable for isolating the appliance. These include circuit breakers, fuses and protective devices.

The voltage and rated load are given on the data plate situated at the front of the oven interior. Please ensure that these match the household mains supply.

For extra safety it is advisable to install a suitable residual current device (RCD) / ground fault interrupter (GFI). Contact a qualified electrician for advice.





















If the cord is damaged a new cord must be fitted by a Miele approved service technician.







**WARNING - THIS APPLIANCE
MUST BE EARTHED**

Cooking charts

Creamed mixture

Cakes/biscuits (accessories)		🌡️ [°C]	 ⁵ 1		🕒 [min]
			+HFC	-HFC	
Muffins (1 tray)		150–160	1	2	25–35
Muffins (2 trays)		150–160	1+3 ³	1+3	30–40 ⁴
Small cakes* (1 tray)		150	1	2	30–40
		160 ²	2	3	20–30
Small cakes* (2 trays)		150 ²	1+3 ³	1+3	30–40
		155–165 ²	1	2	60–70
Madeira cake (baking and roasting rack, loaf tin, 30 cm) ¹		150–160	1	2	60–70
		155–165 ²	1	2	60–70
Marble, nut cake (baking and roasting rack, loaf tin, 30 cm) ¹		150–160	1	2	55–65
		150–160	1	2	60–70
Marble, nut cake (baking and roasting rack, ring tin/Bundt cake tin, Ø 26 cm) ¹		150–160	1	2	55–65
		150–160	1	2	60–70
Fresh fruit cake (1 tray)		160–170	1	2	40–50
		160–170	1	1	55–65
Fresh fruit cake (baking and roasting rack, springform cake tin, Ø 26 cm) ¹		150–160	1	2	55–65
		165–175 ²	1	2	50–60
Flan base (baking and roasting rack, flan base tin, Ø 28 cm) ¹		150–160	1	2	25–35
		170–180 ²	1	2	15–25

 Operating mode, 🌡️ Temperature, ⁵ Shelf level (+HFC: with FlexiClip runners HFC 70-C / -HFC: without FlexiClip runners HFC 70-C), 🕒 Cooking duration,  Fan plus,  Conventional heat

* The settings also apply to testing in accordance with EN 60350-1.























¹ Use a dark coloured, matt bakeware and place it centrally on the baking and roasting rack.







² Pre-heat the oven before putting food inside. Do not use the Booster  operating mode for this purpose.

³ Fit the FlexiClip runners HFC 70-C (if available) onto the bottom shelf level.

⁴ Take the trays out of the oven early if the food is sufficiently browned before the specified cooking duration has elapsed.

Shortcrust pastry

Cakes/biscuits (accessories)		🌡️ [°C]	 ⁵ ₁		🕒 [min]
			+HFC	-HFC	
Biscuits (1 tray)		140–150	1	2	25–35
		150–160	1	2	25–35
Biscuits (2 trays)		140–150	1+3 ³	1+3	25–35 ⁴
Drop cookies* (1 tray)		140	1	2	35–45
		160 ²	2	3	25–35
Drop cookies* (2 trays)		140	1+3 ³	1+3	40–50 ⁴
Flan base (baking and roasting rack, flan base tin, Ø 28 cm) ¹		150–160	1	2	35–45
		170–180 ²	1	2	20–30
Cheesecake (baking and roasting rack, springform cake tin, Ø 26 cm) ¹		170–180	1	2	80–90
		150–160	1	2	80–90
Apple pie* (baking and roasting rack, springform cake tin, Ø 20 cm) ¹		160	1	2	80–100
		180	–	1	75–85
Apple pie, double crust (baking and roasting rack, springform cake tin, Ø 26 cm) ¹		180–190 ²	1	2	60–70
		160–170	1	2	60–70
Fresh fruit cake, glazed (baking and roasting rack, springform cake tin, Ø 26 cm) ¹		170–180	1	2	60–70
		150–160	1	2	55–65
Fresh fruit cake, glazed (1 tray)		170–180	1	2	50–60
		160–170	1	2	45–55
Fruit flan (1 tray)		210–220 ²	–	1	55–65
		180–190	–	1	35–45

 Operating mode, 🌡️ Temperature, ⁵₁ Shelf level (+HFC: with FlexiClip runners HFC 70-C / -HFC: without FlexiClip runners HFC 70-C), 🕒 Cooking duration,  Fan plus,  Eco Fan heat,  Conventional heat,  Intensive bake

* The settings also apply to testing in accordance with EN 60350-1.

¹ Use a dark coloured, matt bakeware and place it centrally on the baking and roasting rack.



















² Pre-heat the oven before putting food inside. Do not use the Booster  operating mode for this purpose.







³ Fit the FlexiClip runners HFC 70-C (if available) onto the bottom shelf level.

⁴ Take the trays out of the oven early if the food is sufficiently browned before the specified cooking duration has elapsed.

Cooking charts







Yeast dough





Cakes/biscuits (accessories)		Temperature [°C]	Shelf level ⁵		Cooking duration [min]
			+HFC	-HFC	
Bundt cake (baking and roasting rack, Bundt cake tin, Ø 24 cm) ¹		150–160	1	2	50–60
		160–170	1	2	50–60
Stollen (1 tray)		150–160	1	2	55–65
		160–170	1	2	55–65
Streusel cake with/without fruit (1 tray)		160–170	1	2	40–50
		170–180	2	3	45–55
Fresh fruit cake (1 tray)		160–170	1	2	45–55
		170–180	2	3	45–55
Apple turnovers/raisin whirls (1 tray)		160–170	1	2	25–35
Apple turnovers/raisin whirls (2 trays)		160–170	1+3 ³	1+3	30–40 ⁵
White bread, free-form (1 tray)		180–190	1	2	35–45
		190–200	1	2	30–40
White bread (baking and roasting rack, loaf tin, 30 cm) ¹		180–190	1	2	35–45
		190–200 ²	1	2	30–40
Wholegrain bread (baking and roasting rack, loaf tin, 30 cm) ¹		180–190	1	2	55–65
		210–220 ²	1	2	45–55
Proving yeast dough (baking and roasting rack)		30–35	– ⁴	– ⁴	–

 Operating mode,  Temperature, ⁵ Shelf level (+HFC: with FlexiClip runners HFC 70-C / -HFC: without FlexiClip runners HFC 70-C),  Cooking duration,  Fan plus,  Conventional heat

- ¹ Use a dark coloured, matt bakeware and place it centrally on the baking and roasting rack.
- ² Pre-heat the oven before putting food inside. Do not use the Booster  operating mode for this purpose.
- ³ Fit the FlexiClip runners HFC 70-C (if available) onto the bottom shelf level.
- ⁴ Place the baking and roasting rack on the floor of the oven and stand the bowl containing the dough on the rack. Depending on the size of the bowl, you may need to remove the side runners.
- ⁵ Take the trays out of the oven early if the food is sufficiently browned before the specified cooking duration has elapsed.

Quark dough







Cakes/biscuits (accessories)		🌡️ [°C]	 ⁵ ₁		🕒 [min]
			+HFC	-HFC	
Fresh fruit cake (1 tray)		160–170	1	2	40–50
		170–180	2	3	50–60
Apple turnovers/raisin whirls (1 tray)		160–170	2	3	25–35
Apple turnovers/raisin whirls (2 trays)		150–160	1+3 ¹	1+3	25–35 ²





 Operating mode, 🌡️ Temperature, ⁵₁ Shelf level (+HFC: with FlexiClip runners HFC 70-C / -HFC: without FlexiClip runners HFC 70-C), 🕒 Cooking duration,  Fan plus,  Conventional heat

¹ Fit the FlexiClip runners HFC 70-C (if available) onto the bottom shelf level.

² Take the trays out of the oven early if the food is sufficiently browned before the specified cooking duration has elapsed.

Sponge mixture

Cakes/biscuits (accessories)		🌡️ [°C]	 ⁵ ₁		🕒 [min]
			+HFC	-HFC	
Sponge cake base (2 eggs) (baking and roasting rack, springform cake tin, Ø 26 cm) ¹		160–170 ²	1	2	15–25
Sponge cake base (4–6 eggs) (baking and roasting rack, springform cake tin, Ø 26 cm) ¹		150–160 ²	1	2	30–40
Whisked sponge* (baking and roasting rack, springform cake tin, Ø 26 cm) ¹		180	1	2	30–40
		150–170 ²	1	2	25–45
Swiss roll sponge (1 tray)		180–190 ²	1	2	10–20

 Operating mode, 🌡️ Temperature, ⁵₁ Shelf level (+HFC: with FlexiClip runners HFC 70-C / -HFC: without FlexiClip runners HFC 70-C), 🕒 Cooking duration,  Fan plus,  Conventional heat









* The settings also apply to testing in accordance with EN 60350-1.
Fit the FlexiClip runners HFC 70-C (if available).





¹ Use a dark coloured, matt bakeware and place it centrally on the baking and roasting rack.

² Pre-heat the oven before putting food inside. Do not use the Booster  operating mode for this purpose.

Cooking charts

Choux pastry, puff pastry, meringue

















Cakes/biscuits (accessories)		Temperature [°C]	Shelf level 		Cooking duration [min]
			+HFC	-HFC	
Choux buns (1 tray)		160–170	1	2	30–40
Pastry puffs (1 tray)		180–190	1	2	20–30
Pastry puffs (2 trays)		180–190	1+3 ¹	1+3	20–30 ²
Macaroons (1 tray)		120–130	1	2	25–50
Macaroons (2 trays)		120–130	1+3 ¹	1+3	25–50 ²
Meringues/pavlovas (1 tray of 6, each Ø 6 cm)		80–100	1	2	120–150
Meringues/pavlovas (2 trays of 6, each Ø 6 cm)		80–100	1+3 ¹	1+3	150–180











 Operating mode,  Temperature,  Shelf level (+HFC: with FlexiClip runners HFC 70-C / -HFC: without FlexiClip runners HFC 70-C),  Cooking duration,  Fan plus

¹ Fit the FlexiClip runners HFC 70-C (if available) onto the bottom shelf level.



² Take the trays out of the oven early if the food is sufficiently browned before the specified cooking duration has elapsed.

Savoury dishes

Food (accessories)		Temperature [°C]	Shelf level ⁵		Cooking duration [min]
			+HFC	-HFC	
Savoury flan (1 tray)		220–230 ²	–	1	35–45
		180–190	–	1	30–40
Onion tart (1 tray)		180–190 ²	1	2	25–35
		170–180	1	2	30–40
Pizza, yeast dough (1 tray)		170–180	1	2	25–35
		210–220 ²	1	2	20–30
Pizza, quark dough (1 tray)		170–180	1	2	25–35
		190–200 ²	1	2	25–35
Frozen pizza, pre-cooked (baking and roasting rack)		200–210	1	2	20–25
Toast* (baking and roasting rack)		300	–	3	6–9
Baked dishes/gratins, e.g. toast (baking and roasting rack on universal tray)		275 ³	2	3	3–6
Grilled vegetables (baking and roasting rack on universal tray)		275 ³	3	4	5–10 ⁴
		250 ³	3	3	5–10 ⁴
Ratatouille (1 universal tray)		180–190	1	2	40–60
French fries, frozen ¹ (Gourmet baking and AirFry tray, perforated)		180–190	2	3	30–35 ⁴
Potato croquettes, frozen ¹ (Gourmet baking and AirFry tray, perforated)		180–190	2	3	23–25 ⁴

















 Operating mode,  Temperature,  Shelf level (+HFC: with FlexiClip runners HFC 70-C / -HFC: without FlexiClip runners HFC 70-C),  Cooking duration,  Conventional heat,  Intensive bake,  Fan plus,  Eco Fan heat,  Full grill,  Fan grill,  Further | AirFry









* The settings also apply to testing in accordance with EN 60350-1.

- Follow the manufacturer's instructions on the packaging.
- Pre-heat the oven before putting food inside. Do not use the Booster  operating mode for this purpose.
- Pre-heat the oven for 5 minutes before putting food inside. Do not use the Booster  operating mode for this purpose.
- If possible, turn the food halfway through the cooking duration.



Cooking charts

Beef















Food (accessories)		 [°C]	 ⁵ ₁	 [min]	 ¹⁰ [°C]
Braised beef, approx. 1 kg (oven dish with lid)	 ²	150–160 ³	2 ⁶	120–130 ⁷	–
	 ²	170–180 ³	2 ⁶	120–130 ⁷	–
	 ²	180–190	2 ⁶	160–180 ⁸	–
Fillet of beef, approx. 1 kg (universal tray)	 ²	180–190 ³	2 ⁶	25–60	45–75
Fillet of beef (rare), approx. 1 kg ¹	 ²	80–85 ⁴	2 ⁶	70–80	45–48
Fillet of beef (medium), approx. 1 kg ¹	 ²	90–95 ⁴	2 ⁶	80–90	54–57
Fillet of beef (well done), approx. 1 kg ¹	 ²	95–100 ⁴	2 ⁶	110–130	63–66
Roast beef, approx. 1 kg (universal tray)	 ²	180–190 ³	2 ⁶	35–65	45–75
Roast beef (rare), approx. 1 kg ¹	 ²	80–85 ⁴	2 ⁶	80–90	45–48
Roast beef (medium), approx. 1 kg ¹	 ²	90–95 ⁴	2 ⁶	110–120	54–57
Roast beef (well done), approx. 1 kg ¹	 ²	95–100 ⁴	2 ⁶	130–140	63–66
Burger, meat patties* (baking and roasting rack on shelf level 4 and universal tray on shelf level 1)		300 ⁵	4	15–25 ⁹	–







 Operating mode,  Temperature,  ⁵₁ Shelf level,  Cooking duration,  ¹⁰ Core temperature,  Fan plus,  Conventional heat,  Eco Fan heat,  Full grill

* The settings also apply to testing in accordance with EN 60350-1.

- ¹ Use the baking and roasting rack and universal tray.
- ² Sear the meat on the hob first.
- ³ Pre-heat the oven before putting food inside. Do not use the Booster  operating mode for this purpose.
- ⁴ Pre-heat the oven at 120 °C for 15 minutes. Reduce the temperature when you place the food in the oven.
- ⁵ Pre-heat the oven for 5 minutes before putting food inside. Do not use the Booster  operating mode for this purpose.
- ⁶ Fit the FlexiClip runners HFC 70-C (if available).
- ⁷ Roast with the lid on to start with. Remove the lid 90 minutes into the cooking duration and add approx. 0.5 litres of liquid.
- ⁸ Roast with the lid on to start with. Remove the lid 100 minutes into the cooking duration and add approx. 0.5 litres of liquid.
- ⁹ Turn the food halfway through cooking.
- ¹⁰ If you are using a food probe, you can use the core temperature shown.

Veal

















Food (accessories)		 Temperature [°C]	 Shelf level ⁵	 Cooking duration [min]	 Core temperature ⁷ [°C]
Braised veal, approx. 1.5 kg (oven dish with lid)	 ²	160–170 ³	2 ⁵	120–130 ⁶	–
	 ²	170–180 ³	2 ⁵	120–130 ⁶	–
Fillet of veal, approx. 1 kg (universal tray)	 ²	160–170 ³	2 ⁵	30–60	45–75
Fillet of veal (pink), approx. 1 kg ¹	 ²	80–85 ⁴	2 ⁵	50–60	45–48
Fillet of veal (medium), approx. 1 kg ¹	 ²	90–95 ⁴	2 ⁵	80–90	54–57
Fillet of veal (well done), approx. 1 kg ¹	 ²	95–100 ⁴	2 ⁵	90–100	63–66
Saddle of veal (pink), approx. 1 kg ¹	 ²	80–85 ⁴	2 ⁵	80–90	45–48
Saddle of veal (medium), approx. 1 kg ¹	 ²	90–95 ⁴	2 ⁵	100–130	54–57
Saddle of veal (well done), approx. 1 kg ¹	 ²	95–100 ⁴	2 ⁵	130–140	63–66









 Operating mode,  Temperature,  Shelf level⁵,  Cooking duration,  Core temperature,  Fan plus,  Conventional heat

- ¹ Use the baking and roasting rack and universal tray.
- ² Sear the meat on the hob first.
- ³ Pre-heat the oven before putting food inside. Do not use the Booster  operating mode for this purpose.
- ⁴ Pre-heat the oven at 120 °C for 15 minutes. Reduce the temperature when you place the food in the oven.
- ⁵ Fit the FlexiClip runners HFC 70-C (if available).
- ⁶ Roast with the lid on to start with. Remove the lid 90 minutes into the cooking duration and add approx. 0.5 litres of liquid.
- ⁷ If you are using a food probe, you can use the core temperature shown.

Cooking charts











Pork







Food (accessories)		 [°C]	 ⁵ ₁	 [min]	 ¹⁰ [°C]
Pork joint/pork neck roast, approx. 1 kg (oven dish with lid)		160–170	2 ⁵	130–140 ⁶	80–90
		180–190	2 ⁵	130–140 ⁶	80–90
Pork joint with crackling, approx. 2 kg (oven dish)		180–190	2 ⁵	130–150 ⁷	80–90
		190–200	2 ⁵	130–150 ⁷	80–90
Pork tenderloin, approx. 350 g ¹	 ²	90–100 ³	2 ⁵	70–90	60–69
Ham roast, approx. 1.5 kg (oven dish with lid)		160–170	2 ⁵	130–160 ⁸	80–90
Gammon joint, approx. 1 kg (universal tray)		150–160	2 ⁵	50–60	63–68
Gammon joint, approx. 1 kg ¹	 ²	95–105 ³	2 ⁵	140–160	63–66
Meat loaf, approx. 1 kg (universal tray)		170–180	2 ⁵	60–70 ⁷	80–85
		190–200	2 ⁵	70–80 ⁷	80–85
Bacon ¹		300 ⁴	4	3–5	–
Sausages ¹		220 ⁴	3 ⁵	8–15 ⁹	–

 Operating mode,  Temperature,  ⁵₁ Shelf level,  Cooking duration,  ¹⁰ Core temperature,  Fan plus,  Conventional heat,  Eco Fan heat,  Full grill

- ¹ Use the baking and roasting rack and universal tray.
- ² Sear the meat on the hob first.
- ³ Pre-heat the oven at 120 °C for 15 minutes. Reduce the temperature when you place the food in the oven.
- ⁴ Pre-heat the oven for 5 minutes before putting food inside. Do not use the Booster  operating mode for this purpose.
- ⁵ Fit the FlexiClip runners HFC 70-C (if available).
- ⁶ Roast with the lid on to start with. Remove the lid 60 minutes into the cooking duration and add approx. 0.5 litres of liquid.
- ⁷ Add approx. 0.5 litres of liquid halfway through the cooking duration.
- ⁸ Roast with the lid on to start with. Remove the lid 100 minutes into the cooking duration and add approx. 0.5 litres of liquid.
- ⁹ Turn the food halfway through cooking.
- ¹⁰ If you are using a food probe, you can use the core temperature shown.

Lamb, game

















Food (accessories)		 [°C]	 ⁵	 [min]	 ⁶ [°C]
Leg of lamb on the bone, approx. 1.5 kg (oven dish with lid)		170–180	2 ⁴	100–120 ⁵	64–82
Saddle of lamb, off the bone (universal tray)	 ¹	180–190 ²	2 ⁴	10–20	53–80
Saddle of lamb, off the bone (baking and roasting rack and universal tray)	 ¹	95–105 ³	2 ⁴	40–60	54–66
Saddle of venison, off the bone (universal tray)	 ¹	160–170 ²	2 ⁴	70–90	60–81
Roebuck saddle, off the bone (universal tray)	 ¹	140–150 ²	2 ⁴	25–35	60–81
Leg of wild boar, off the bone, approx. 1 kg (oven dish with lid)	 ¹	170–180	2 ⁴	100–120 ⁵	80–90











 Operating mode,  Temperature, ⁵ Shelf level,  Cooking duration, ⁶ Core temperature,  Conventional heat



- ¹ Sear the meat on the hob first.
- ² Pre-heat the oven before putting food inside. Do not use the Booster  operating mode for this purpose.
- ³ Pre-heat the oven at 120 °C for 15 minutes. Reduce the temperature when you place the food in the oven.
- ⁴ Fit the FlexiClip runners HFC 70-C (if available).
- ⁵ Roast with the lid on to start with. Remove the lid 50 minutes into the cooking duration and add approx. 0.5 litres of liquid.
- ⁶ If you are using a food probe, you can use the core temperature shown.

Cooking charts













Poultry, fish







Food (accessories)		 [°C]	 5 1	 [min]	 8 [°C]
Poultry, 0.8–1.5 kg (universal tray)		170–180	2 ⁴	55–65	85–90
Chicken, approx. 1.2 kg (baking and roasting rack on universal tray)		180–190 ²	2 ⁴	55–65 ⁵	85–90
Poultry, approx. 2 kg (oven dish)		180–190	2 ⁴	100–120 ⁶	85–90
		190–200	2 ⁴	110–130 ⁶	85–90
Poultry, approx. 4 kg (oven dish)		160–170	2 ⁴	180–200 ⁷	90–95
		180–190	2 ⁴	180–200 ⁷	90–95
Chicken thighs (grilling and roasting insert on universal tray)		190–200	2 ⁴	30–35	–
Fish, 200–300 g, e.g. trout (universal tray)		210–220 ³	2 ⁴	15–25	75–80
Fish, 1–1.5 kg, e.g. salmon trout (universal tray)		210–220 ³	2 ⁴	30–40	75–80
Fish fillet in foil, 200–300 g (universal tray)		200–210	2 ⁴	25–30	75–80
Fish fingers, frozen ¹ (Gourmet baking and AirFry tray, perforated)		220–230	2 ⁴	13–15 ⁵	–



 Operating mode,  Temperature,  5
1 Shelf level,  Cooking duration,  Core temperature,  Fan plus,  Fan grill,  Conventional heat,  Eco Fan heat,  |  Further | AirFry

- ¹ Follow the manufacturer's instructions on the packaging.
- ² Pre-heat the oven for 5 minutes before putting food inside. Do not use the Booster  operating mode for this purpose.
- ³ Pre-heat the oven before putting food inside. Do not use the Booster  operating mode for this purpose.
- ⁴ Fit the FlexiClip runners HFC 70-C (if available).
- ⁵ If possible, turn the food halfway through the cooking duration.
- ⁶ Add approx. 0.25 litres of liquid at the start of the cooking process.
- ⁷ Add approx. 0.5 litres of liquid after 30 minutes.
- ⁸ If you are using a food probe, you can use the core temperature shown.

Test food according to EN 60350-1

Test food (accessories)		Temperature [°C]	Shelf level ^{5,6}		Cooking duration [min]
			+HFC	-HFC	
Small cakes (1 baking tray ¹)		150	1	2	30–40
		160 ⁴	2	3	20–30
Small cakes (2 baking trays ¹)		150 ⁴	1+3 ⁷	1+3	30–40
Drop cookies (1 baking tray ¹)		140	1	2	35–45
		160 ⁴	2	3	25–35
Drop cookies (2 baking trays ¹)		140	1+3 ⁷	1+3	40–50 ⁸
Apple pie (baking and roasting rack ¹ , springform cake tin ² , Ø 20 cm)		160	1	2	80–100
		180	–	1	75–85
Whisked sponge (baking and roasting rack ¹ , springform cake tin ² , Ø 26 cm)		180	1	2	30–40
		150–170 ⁴	1	2	25–45
Toast (baking and roasting rack ¹)		300	–	3	6–9
Burger (baking and roasting rack ¹ on shelf level 4 and universal tray ¹ on shelf level 1)		300 ⁵	–	4	15–25 ⁹

 Operating mode,  Temperature, ⁵ Shelf level (+HFC: with FlexiClip runners HFC 70-C / -HFC: without FlexiClip runners HFC 70-C),  Cooking duration,  Fan plus,  Conventional heat,  Full grill

- ¹ Only use original Miele accessories.
- ² Use a dark-coloured, matt springform cake tin.
Place the springform cake tin centrally on the baking and roasting rack.
- ³ In general, if a range of temperatures is given, it is best to select the lower temperature and to check the food after the shortest cooking duration.
- ⁴ Pre-heat the oven before putting food inside. Do not use the Booster  operating mode for this purpose.
- ⁵ Pre-heat the oven for 5 minutes before putting food inside. Do not use the Booster  operating mode for this purpose.
- ⁶ Fit the FlexiClip runners HFC 70-C (if available).
- ⁷ Fit the FlexiClip runners HFC 70-C (if available) onto the bottom shelf level. If you have several pairs of FlexiClip runners, fit only one pair.
- ⁸ Take the trays out of the oven early if the food is sufficiently browned before the specified cooking duration has elapsed.
- ⁹ Turn the food halfway through cooking.

Notes for test institutes

Energy efficiency class according to EN 60350-1

The energy efficiency rating is determined in accordance with EN 60350-1.

Energy efficiency rating: A+

Please observe the following when conducting testing:

- Testing is undertaken using the Eco Fan heat  function.
- Only accessories that are required for testing should be in the oven compartment during tests.
Do not use other accessories that might be available such as FlexiClip runners or catalytic enamelled panels such as side panels or roof liners.
- An important pre-condition for determining the energy efficiency rating is that the door is tightly shut during testing.
Depending on measurement devices used, the functioning of the door seal can be affected to a greater or lesser extent. This has a negative impact on the test results.
Pushing against the door will compensate for this. In certain unfavourable circumstances, suitable technical aids may also be necessary for this. This does not occur in normal use.

Data sheet for household ovens

In acc. with delegated regulation (EU) No. 65/2014 and regulation (EU) No. 66/2014

MIELE	
Model name/identifier	H 2465 B, H 2761 B, H 2766 B, H 2851 B
Energy efficiency index/cavity (EEI _{cavity})	81,7
Energy efficiency class/cavity	
A+++ (most efficient) to D (least efficient)	A+
Energy consumption per cycle for each cavity in conventional mode	1,05 kWh
Energy consumption per cycle for each cavity in fan-forced convection mode	0,71 kWh
Number of cavities	1
Heat source(s) per cavity	electric
Volume of cavity	76 l
Mass of the appliance	42,0 kg

Recipes for automatic programmes

Below are the recipes to use with the automatic programmes.

For optimum cooking results, we recommend using the quantities and accessories given in the recipes.

To find the correct shelf level, please remove the FlexiClip runners HFC 70-C before starting an automatic programme.

Recipes for automatic programmes

Apple sponge

Total time required: 95 minutes

Serves 12

For the topping

500 g apples, tart

2 tbsp lemon juice

For the dough

150 g butter | softened

150 g caster sugar

8 g vanilla paste

3 medium eggs

150 g plain white flour

½ tsp baking powder

For the tin

1 tsp butter

For dusting

1 tbsp icing sugar

Accessories

Baking and roasting rack

Springform tin, Ø 26 cm

Sieve, fine

Preparation

Peel and quarter the apples. Cut into the outside of each apple quarter (opposite side to the core), making cuts approximately 1 cm apart. Mix with the lemon juice and put to one side.

Grease the springform tin.

Cream together the butter, sugar and vanilla paste for approximately 2 minutes. Stir in the eggs one at a time (½ minute each).

Sift together the flour and baking powder and mix with the other ingredients.

Pour the mixture into the springform tin, spreading it evenly. Press the apples gently into the mixture with the core side down.

Place the springform tin on the baking and roasting rack inside the oven and bake.

Leave the cake in the tin for 10 minutes. Then release the sides of the tin and leave to cool on the baking and roasting rack. Dust with icing sugar.

Settings

Automatic programme

 | Apple sponge

Programme running time: 55 minutes

Manual

Operating mode: 

Temperature: 165–175 °C

Pre-heating: no

Duration: 45–55 minutes

Shelf level: +HFC 70-C: 1 | -HFC 70-C: 2

Tip

As an alternative to dusting the cake with icing sugar, try an apricot glaze instead. To create the glaze, gently heat some apricot jam and stir it until smooth.

Sponge base

Total time required: 75 minutes

Serves 12

For the dough

4 medium eggs

4 tbsp water | hot

175 g caster sugar

200 g plain white flour

1 tsp baking powder

For the tin

1 tsp butter

Accessories

Baking and roasting rack

Sieve, fine

Springform tin, Ø 26 cm

Baking parchment

Preparation

Separate the egg whites from the yolks. Beat the egg whites with the water until stiff. Slowly add the sugar, beating after each addition. Then fold in the beaten egg yolk.

Place the baking and roasting rack in the oven. Start the automatic programme or pre-heat the oven.

Mix the flour and baking powder, sieve into the egg mixture and fold in with a large whisk.

Grease the base of the springform tin and line with baking parchment. Pour the mixture into the tin and spread it out evenly.

Place the sponge base in the oven and bake until golden.

After baking, allow to cool in the tin for 10 minutes. Then, remove from the tin and allow to cool on the baking and

roasting rack. Slice the sponge base twice horizontally to make three separate layers.

Spread with the prepared filling.

Settings

Automatic programme

 | Sponge base

Programme running time: 36 minutes

Manual

Operating mode: 

Temperature: 160–170 °C

Pre-heating: yes

Duration: 30–40 minutes

Shelf level: +HFC 70-C: 1 | -HFC 70-C: 2

Tip

To make a chocolate sponge, add 2–3 teaspoons of cocoa powder to the flour mixture.

Recipes for automatic programmes

Layered sponge cake fillings

Total time required: 30 minutes

For the quark and double cream filling

500 g quark, 20 % fat in dry matter
100 g caster sugar
100 ml milk, whole
8 g vanilla paste
1 lemon | juice only
6 sheets of gelatine, white
500 ml double cream

For dusting

1 tbsp icing sugar

For the cappuccino filling

100 g chocolate, dark
500 ml double cream
6 sheets of gelatine, white
80 ml espresso
80 ml coffee liqueur
16 g vanilla paste
1 tbsp cocoa powder

For dusting

1 tbsp cocoa powder

Accessories

Cake platter
Sieve, fine

Method for the quark and double cream filling

To make the quark and double cream filling, stir together the quark, sugar, milk, vanilla paste and lemon juice. Soak the gelatine in cold water, then squeeze the water out and dissolve it in the microwave or on the cooking zone on low.

Stir a little of the quark mixture into the gelatine.

Stir this mixture into the remaining quark mixture and chill. Whip the double cream until stiff and stir it into the quark mixture.

Place the first layer of sponge on a cake platter and cover it with the quark mixture. Place the second layer on top and cover with the quark mixture too. Then place the third layer on top of that. Cool the cake thoroughly. Dust with icing sugar before serving.

Method for the cappuccino filling

To make the cappuccino filling, start by melting the chocolate. Whip the cream until stiff and set a small portion aside to spread on the top layer. Soak the gelatine in cold water, then squeeze the water out and dissolve it in the microwave or on the cooking zone on low. Then leave it to cool slightly.

Stir half of the espresso and coffee liqueur into the gelatine. Then fold this mixture into the whipped cream.

Divide the coffee and cream mixture in half. Stir the vanilla paste into one half and the chocolate and cocoa powder into the other half.

Place the first layer of sponge on a cake platter, drizzle some of the coffee liqueur and espresso over the top and then coat with the dark cream mixture. Place the second sponge layer on top of the first, drizzle the remaining liquid over it and then coat with the light cream mixture. Place the third layer on top, coat it with the cream you set aside and dust with cocoa powder.

Tip

For a fruity variation, add some grated lemon zest and 300 g tinned apricots or mandarin segments (drained) to the quark and cream filling.

Marble cake

Total time required: 80 minutes

Serves 18

For the dough

250 g butter | softened

200 g caster sugar

8 g vanilla paste

4 medium eggs

200 ml soured cream

400 g plain white flour

16 g baking powder

1 pinch of salt

3 tbsp cocoa powder

For the tin

1 tsp butter

Accessories

Ring tin, Ø 26 cm

Baking and roasting rack

Preparation

Cream together the butter, sugar and vanilla paste. Add the eggs one by one, stirring for ½ minute each time. Add the soured cream. Mix together the flour, baking powder and salt. Then stir into the other ingredients.

Grease the ring tin and place half of the mixture into it.

Stir the cocoa powder into the other half of the mixture. Pour the dark mixture over the light mixture. Swirl a fork through the mixture to give a marbled effect.

Place the ring tin on the baking and roasting rack in the oven and bake.

Leave the cake in the tin for 10 minutes. Then, remove from the tin and allow to cool on the baking and roasting rack.

Settings

Automatic programme

 | Marble cake

Programme running time: 55 minutes

Manual

Operating mode: 

Temperature: 150–160 °C

Pre-heating: no

Duration: 50–60 minutes

Shelf level: +HFC 70-C: 1 | -HFC 70-C: 2

Recipes for automatic programmes

Fruit streusel cake

Total time required: 150 minutes

Serves 20

For the dough

42 g fresh yeast
150 ml milk, whole | lukewarm
450 g plain white flour
50 g caster sugar
90 g butter | softened
1 egg, medium

For the topping

1.25 kg apples

For the streusel crumble

240 g plain white flour
150 g caster sugar
16 g vanilla paste
1 tsp cinnamon
150 g butter | softened

Accessories

Baking tray or universal tray

Preparation

Stir the yeast into the milk to dissolve it. Add to the flour, sugar, butter and the egg, and knead to form a smooth dough.

Shape the dough into a ball, place it in a bowl, cover it with a damp cloth and place it in the oven compartment. Prove the dough using the settings indicated for proving phase 1.

Peel and core the apples and slice them into wedges.

Lightly knead the dough and then roll it out on a baking tray or the universal tray. Arrange the apples evenly across the dough. Mix together the flour, sugar, vanilla paste and cinnamon. Then knead in the butter to create a crumble mix. Scatter over the apples.

Place the cake in the oven and prove the dough using the settings indicated for proving phase 2.

Bake the cake until golden brown.

Settings

Prove dough

Proving phase 1

Operating mode: 

Temperature: 30 °C

Proving time: 30–45 minutes

Proving phase 2

Operating mode: 

Temperature: 30 °C

Proving time: 30 minutes

Baking

Automatic programme

 | Fruit streusel cake

Programme running time: 44 minutes

Manual

Operating mode: 

Temperature: 180–190 °C

Pre-heating: no

Duration: 40–50 minutes

Shelf level: +HFC 70-C: 2 | -HFC 70-C: 3

Tip

Instead of the apples, try using 1 kg stoned plums or cherries.

Recipes for automatic programmes

Biscuits

Total time required: 135 minutes

Makes 70 (2 trays)

Ingredients

250 g plain white flour

½ tsp baking powder

80 g caster sugar

8 g vanilla paste

1 tsp rum essence

3 tbsp water

120 g butter | softened

Accessories

Rolling pin

Biscuit cutters

2 baking trays or universal trays

Preparation

Mix together the flour, baking powder, sugar and vanilla paste. Add the rest of the ingredients and quickly knead to form a smooth dough. Chill for at least 60 minutes.

Roll out the dough to a thickness of approx. 3 mm, cut out the biscuits and place them on the baking or universal trays.

Place the biscuits in the oven compartment and bake.

Settings

Automatic programme

 | Biscuits |

1 tray / 2 trays

Programme running time for 1 tray:

25 minutes

Programme running time for 2 trays:

26 minutes

Manual

Operating mode: 

Temperature: 140–150 °C

Pre-heating: no

Duration: 25–35 minutes

Shelf level, 1 tray:

+HFC 70-C: 1 | -HFC 70-C: 2

Shelf level, 2 trays:

+HFC 70-C: 1+3 | -HFC 70-C: 1+3

Tip

The quantities for the ingredients are for 2 trays. For 1 tray, halve the quantities or bake the biscuits one batch after the other.

Recipes for automatic programmes

Drop cookies

Total time required: 50 minutes

Makes 50 (2 trays)

Ingredients

160 g butter | softened

50 g sugar, brown

50 g icing sugar

8 g vanilla paste

1 pinch of salt

200 g plain white flour

1 egg, medium | white only

Accessories

Piping bag

Star nozzle, 9 mm

2 baking trays or universal trays

Preparation

Beat the butter until creamy. Add the sugar, icing sugar, vanilla paste and salt and beat until soft. Then fold in the flour followed by the egg white.

Put the dough in a piping bag and pipe it onto the baking tray or universal tray in strips measuring approx. 5–6 cm in length.

Place the shortbread biscuits in the oven compartment and bake until golden.

Settings

Automatic programme

 | Drop cookies | 1 tray / 2 trays

Programme running time for 1 tray:

24 minutes

Programme running time for 2 trays:

31 minutes

Manual

For 1 tray

Operating mode: 

Temperature: 150–160 °C

Pre-heating: no

Duration: 20–30 minutes

Shelf level: +HFC 70-C: 1 | -HFC 70-C: 2

For 2 trays

Operating mode: 

Temperature: 140–150 °C

Pre-heating: no

Duration: 25–35 minutes

Shelf level: +HFC 70-C: 1+3 | -HFC 70-C: 1+3

Tip

The quantities for the ingredients are for 2 trays. For 1 tray, halve the quantities or bake the biscuits one batch after the other.

Walnut muffins

Total time required: 95 minutes

Makes 12

Ingredients

80 g raisins

40 ml rum

120 g butter | softened

120 g caster sugar

8 g vanilla paste

2 medium eggs

140 g plain white flour

1 tsp baking powder

120 g walnuts | roughly chopped

Accessories

Muffin tin for 12 muffins, Ø 5 cm each

Paper cases, Ø 5 cm

Baking and roasting rack

Preparation

Drizzle the rum over the raisins and leave to soak for approximately 30 minutes.

Beat the butter until creamy. Gradually mix in the sugar, vanilla paste and eggs. Sift together the flour and baking powder and mix in. Stir in the walnuts. Finally, add the rum and raisins.

Line the muffin tin with the paper cases. Using 2 tablespoons, distribute the mixture evenly between the muffin cups.

Place the muffin tin on the baking and roasting rack in the oven and bake.

Settings

Automatic programme

 | Walnut muffins

Programme running time: 37 minutes

Manual

Operating mode: 

Temperature: 150–160 °C

Pre-heating: no

Duration: 30–40 minutes

Shelf level: +HFC 70-C: 1 | -HFC 70-C: 2

Recipes for automatic programmes

Pizza (yeast dough)

Total time required: 90 minutes

Serves 4

For the dough

30 g fresh yeast
170 ml water | lukewarm
300 g plain white flour
1 tsp caster sugar
1 tsp salt
½ tsp thyme, dried rubbed
1 tsp oregano, dried rubbed
1 tbsp oil

For the topping

2 onions
1 clove of garlic
400 g tomatoes, tinned, peeled and chopped
2 tbsp tomato purée
1 tsp caster sugar
1 tsp oregano, dried rubbed
1 bay leaf
1 tsp salt
Pepper
125 g mozzarella
125 g Gouda, grated

For frying

1 tbsp olive oil

Accessories

Baking tray or universal tray

Preparation

Stir the yeast into the water to dissolve it. Add to the flour, sugar, salt, thyme, oregano and oil and knead for 6–7 minutes until you have a smooth dough.

Shape the dough into a ball, place it in a bowl and cover with a damp cloth. Leave to prove at room temperature for 20 minutes.

To make the topping, finely dice the onions and garlic. Heat the oil in a pan. Sauté the onions and garlic until translucent. Add the tomatoes, tomato purée, sugar, oregano, bay leaf and salt.

Allow the sauce to simmer for 5 minutes.

Remove the bay leaf, then season with salt and pepper to taste. Slice the mozzarella.

Roll the dough out onto the baking tray or universal tray. Leave to prove at room temperature for 10 minutes.

Start the automatic programme or pre-heat the oven.

Spread the sauce over the dough. Leave a gap of approximately 1 cm all the way round the edge. Top with the mozzarella and sprinkle on the Gouda.

Place the pizza in the oven compartment and bake.

Settings

Automatic programme

 Pizza | Yeast dough

Programme running time: 32 minutes

Manual

Operating mode: 

Temperature: 200–210 °C

Pre-heating: yes

Duration: 20–30 minutes

Shelf level: +HFC 70-C: 1 | -HFC 70-C: 2

Tip

As an alternative, try topping the pizza with ham, salami, mushrooms, onions or tuna.

Pizza (quark dough)

Total time required: 60 minutes

Serves 4

For the dough

120 g quark, 20 % fat in dry matter

4 tbsp milk, whole

4 tbsp oil

2 eggs, medium | yolks only

1 tsp salt

1½ tsp baking powder

250 g plain white flour

For the topping

2 onions

1 clove of garlic

400 g tomatoes, tinned, peeled and chopped

2 tbsp tomato purée

1 tsp caster sugar

1 tsp oregano

1 bay leaf

1 tsp salt

Pepper

125 g mozzarella

125 g Gouda, grated

For frying

1 tbsp olive oil

Accessories

Baking tray or universal tray

Preparation

To make the topping, finely dice the onions and garlic. Heat the oil in a pan. Sauté the onions and garlic until translucent. Add the tomatoes, tomato purée, sugar, oregano, bay leaf and salt.

Allow the sauce to simmer for 5 minutes.

Remove the bay leaf. Season with salt and pepper to taste. Slice the mozzarella.

To make the dough, start by mixing together the quark, milk, oil, egg yolk and salt. Sift together the flour and baking powder. Mix half the amount into the dough. Then knead in the rest.

Roll the dough out onto the baking tray or universal tray.

Start the automatic programme or pre-heat the oven.

Spread the sauce over the dough. Leave a gap of approximately 1 cm all the way round the edge. Top with the mozzarella and sprinkle on the Gouda.

Place the pizza in the oven compartment and bake.

Settings

Automatic programme

 | Pizza | Quark dough

Programme running time: 33 minutes

Manual

Operating mode: 

Temperature: 180–190 °C

Pre-heating: yes

Duration: 25–35 minutes

Shelf level: +HFC 70-C: 2 | -HFC 70-C: 3

Tip

As an alternative, try topping the pizza with ham, salami, mushrooms, onions or tuna.

Recipes for automatic programmes

Chicken

Total time required: 95 minutes

Serves 2

Ingredients

1 chicken, ready to cook (1.2 kg)

2 tbsp oil

1½ tsp salt

2 tsp paprika, sweet

1 tsp curry powder

Accessories

Baking and roasting rack

Ovenproof dish, 22 cm x 29 cm

Kitchen string

Preparation

Mix the oil with the salt, paprika and curry powder, then coat the chicken with it.

Tie the legs together with kitchen string and put the chicken breast side up in the ovenproof dish.

Place the ovenproof dish on the baking and roasting rack and slide it into the oven compartment with the legs of the bird pointing towards the door. Roast the chicken.

Settings

Automatic programme

 | Chicken

Programme running time: 80 minutes

Manual

Operating mode: 

Temperature: 180–190 °C

Pre-heating: no

Duration: 75–85 minutes

Shelf level: +HFC 70-C: 1 | -HFC 70-C: 2

Fillet of beef (roast)

Total time required: 65 minutes

Serves 4

For the fillet of beef

1 kg fillet of beef, ready to cook

2 tbsp oil

1 tsp salt

Pepper

For frying

2 tbsp oil

Accessories

Universal tray

Preparation

Start the automatic programme or pre-heat the oven.

Heat the oil in a pan and sear the fillet of beef all over (approximately 1 minute per side).

Remove the fillet of beef. Mix together the oil, salt and pepper, then coat the fillet of beef with it.

Place the fillet of beef onto the universal tray and slide into the oven compartment. Cook the fillet of beef.

Settings

Automatic programme

 | Fillet of beef

Programme running time:

Rare: 36 minutes

Medium: 43 minutes

Well-done: 59 minutes

Manual

Operating mode: 

Temperature: 180–190 °C

Pre-heating: yes

Duration: 20–30 minutes (Rare),

35–45 minutes (Medium),

50–60 minutes (Well-done)

Shelf level: +HFC 70-C: 1 | -HFC 70-C: 2

Recipes for automatic programmes

Trout

Total time required: 65 minutes

Serves 4

For the trout

4 trout (250 g each), ready to cook

2 tbsp lemon juice

Salt

Pepper

For the stuffing

200 g fresh mushrooms

½ onion

1 clove of garlic

25 g parsley

Salt

Pepper

For dotting

3 tbsp butter

Accessories

Universal tray

Preparation

Drizzle the lemon juice over the trout. Season with salt and pepper inside and out.

To make the stuffing, clean the mushrooms. Finely chop the onion, garlic, mushrooms and parsley, and mix well. Season the mixture with salt and pepper.

Start the automatic programme or pre-heat the oven.

Stuff the trout with the filling and place side by side on the universal tray. Dot with small chunks of butter.

Place the universal tray in the oven compartment. Cook the trout.

Settings

Automatic programme

 | Trout

Programme running time: 36 minutes

Manual

Operating mode: 

Temperature: 210–220 °C

Pre-heating: yes

Duration: 20–30 minutes

Shelf level: +HFC 70-C: 1 | -HFC 70-C: 2

Tip

Serve with slices of lemon and browned butter.

Recipes for automatic programmes

Salmon fillet

Total time required: 40 minutes

Serves 4

For the salmon fillet

4 salmon fillets (200 g each), ready to cook

2 tbsp lemon juice

Salt

Pepper

For dotting

3 tbsp butter

For sprinkling

1 tsp dill, chopped

Accessories

Universal tray

Preparation

Start the automatic programme or pre-heat the oven.

Place the salmon fillets on the universal tray. Drizzle with lemon juice. Season with salt and pepper. Dot the salmon fillets with small chunks of butter and sprinkle with dill.

Place the universal tray in the oven compartment and cook the salmon fillets.

Settings

Automatic programme

 | Salmon fillet

Programme running time: 27 minutes

Manual

Operating mode: 

Temperature: 200–210 °C

Pre-heating: yes

Duration: 10–20 minutes

Shelf level: +HFC 70-C: 1 | -HFC 70-C: 2

Recipes for automatic programmes

Salmon trout

Total time required: 65 minutes

Serves 4

For the salmon trout

1 salmon trout (1 kg), whole, ready to cook

1 lemon | juice only

Salt

For the stuffing

2 shallots

2 cloves of garlic

2 slices of white bread

50 g small capers

1 egg, medium | yolk only

2 tbsp olive oil

Salt

Pepper

Chilli powder

Accessories

Wooden skewers

Universal tray

Preparation

Drizzle the lemon juice over the salmon trout. Season with salt inside and out.

To make the stuffing, finely dice the shallots, garlic and bread. Mix together the capers, egg yolk, olive oil, shallots, garlic and bread. Season with salt, pepper and chilli powder.

Start the automatic programme or pre-heat the oven.

Stuff the salmon trout with the mixture. Seal the opening with small wooden skewers.

Place the salmon trout onto the universal tray and slide into the oven compartment. Cook the salmon trout.

Settings

Automatic programme

 | Salmon trout

Programme running time: 46 minutes

Manual

Operating mode: 

Temperature: 210–220 °C

Pre-heating: yes

Duration: 30–40 minutes

Shelf level: +HFC 70-C: 1 | -HFC 70-C: 2

Potato and cheese gratin

Total time required: 90 minutes

Serves 4

For the gratin

600 g potatoes, floury

75 g Gouda, grated

For the tin

1 clove of garlic

For the topping

250 ml double cream

1 tsp salt

Pepper

Nutmeg

For sprinkling

75 g Gouda, grated

Accessories

Ovenproof dish, Ø 26 cm

Baking and roasting rack

Preparation

Rub the ovenproof dish with the garlic clove.

To make the topping, mix together the cream, salt, pepper and nutmeg.

Peel the potatoes and cut them into slices 3–4 mm thick. Mix the potatoes with the Gouda and the cream topping, and transfer to the ovenproof dish.

Sprinkle with the Gouda.

Place the potato and cheese gratin on the baking and roasting rack in the oven and cook until golden brown.

Settings

Automatic programme

 | Potato gratin

Programme running time: 50 minutes

Manual

Operating mode: 

Temperature: 180–190 °C

Pre-heating: no

Duration: 55–65 minutes

Shelf level: +HFC 70-C: 1 | -HFC 70-C: 2

Recipes for automatic programmes

Lasagne

Total time required: 125 minutes

Serves 4

For the lasagne

8 lasagne sheets (not pre-cooked)

For the bolognese sauce

50 g bacon, streaky, smoked | finely diced

375 g mince, half beef and half pork

2 onions | diced

800 g tinned tomatoes, skinned

30 g tomato purée

125 ml stock

1 tsp thyme, fresh | chopped

1 tsp oregano, fresh | chopped

1 tsp basil, fresh | chopped

Salt

Pepper

For the mushroom sauce

20 g butter

1 onion | diced

100 g fresh mushrooms | sliced

2 tbsp plain white flour

250 ml double cream

250 ml milk, whole

Salt

Pepper

Nutmeg

2 tbsp parsley, fresh | chopped

For sprinkling

200 g Gouda, grated

Accessories

Ovenproof dish, 32 cm x 22 cm

Baking and roasting rack

Preparation

To make the bolognese sauce, start by heating a non-stick pan. Fry the bacon lardons, add the minced meat and continue to fry, stirring constantly. Add the

onions and sauté them. Chop the tomatoes. Add the tomatoes, tomato juice, tomato purée and stock. Season with herbs, salt and pepper. Allow to simmer for approx. 5 minutes.

To make the mushroom sauce, sauté the onions in butter. Add the mushrooms and sauté briefly. Sprinkle with flour and stir. Deglaze with the cream and milk. Season with salt, pepper and nutmeg. Allow the sauce to simmer for approximately 5 minutes. Finally, add the parsley.

To make the lasagne, layer up the ingredients in the ovenproof dish in the order listed below:

- One third of the bolognese sauce
- 4 lasagne sheets
- One third of the bolognese sauce
- Half of the mushroom sauce
- 4 lasagne sheets
- One third of the bolognese sauce
- Half of the mushroom sauce

Sprinkle the lasagne with the Gouda, place it on the baking and roasting rack in the oven and cook until golden brown.

Settings

Automatic programme

 | Lasagne

Programme running time: 55 minutes

Manual

Operating mode: 

Temperature: 185–195 °C

Pre-heating: no

Duration: 55–65 minutes

Shelf level: +HFC 70-C: 1 | -HFC 70-C: 1

Below are the recipes to use with the AirFry operating mode.

For optimum cooking results, we recommend using the quantities and accessories given in the recipes.

AirFry recipes

Falafel with yoghurt dip

Total time required: 60 minutes + 12 hours of soaking time

Serves 4

For the falafel

250 g chickpeas, dried
2 l water
2 onions | finely diced
2 cloves of garlic | finely chopped
30 g parsley | chopped
2 tbsp lemon juice
1 tbsp olive oil
50 g tahini (sesame paste)
1 tsp coriander, ground
1 tsp oregano
½ tsp ras el hanout
1 tsp cumin
1½ tsp salt
1 pinch of pepper
1 pinch of chilli powder
60 g plain white flour
1 tsp baking powder

For the yoghurt dip

500 g yoghurt, 3.5 % fat
100 g cream cheese
1 tbsp tahini (sesame paste)
3 tbsp lemon juice
20 g parsley | chopped
1 tsp salt
1 pinch of pepper

Accessories

Sieve
Mixer with cutting blade
Mixer with dough hook
Gourmet baking and AirFry tray, perforated

Method

Soak the chickpeas in water for at least 12 hours.

To make the yoghurt dip, mix together all of the ingredients and chill.

Drain the chickpeas in a sieve.

Place the parsley, onions, garlic, lemon juice, oil, tahini and spices in the mixer. Gradually add the chickpeas. Stir the mixture with a tablespoon in between adding the chickpeas.

Put the mixture in a bowl. Mix the flour and baking powder and knead into the mixture. Shape the mixture into 24 balls. Flatten the balls slightly in your hands and place them on the Gourmet baking and AirFry tray. Place in the oven and bake until golden brown.

Settings

Operating mode:  | AirFry
Temperature: 210 °C
Cooking duration: 18 minutes
Shelf level: 2

French fries and sweet potato fries

Total time required: 50 minutes

Serves 4

For the fries

500 g potatoes, waxy | in batons (approx. 0.5 x 0.5 x 6 cm)

500 g sweet potatoes | in batons (approx. 0.5 x 0.5 x 6 cm)

30 ml sunflower oil

For the dip

150 g Greek yoghurt

150 g buttermilk

¼ lemon | juice and zest

½ bunch of dill

¼ tsp rosemary, dried

¼ tsp oregano, dried

½ tsp onion, dried

¼ tsp garlic, dried

1 pinch of salt

1 pinch of pepper

For the seasoned salt

2 tbsp salt

1 tsp paprika, smoked

½ tsp onion, dried

½ tsp garlic, dried

Accessories

Pan

Kitchen towels

Gourmet baking and AirFry tray, perforated

Method

Bring the water to the boil on the hob. Blanch the potato batons in boiling water for 3 minutes. Then drop them into cold water and pat dry on a kitchen towel.

Marinate the potato batons with the sunflower oil. Then place on the Gourmet baking and AirFry tray and cook according to the settings. Turn after 15 minutes and cook for a further 10 minutes.

To make the dip, mix all the ingredients together and season with salt and pepper to taste. Chill the dip until ready to serve.

To make the seasoned salt, mix all the spices together and set aside.

At the end of the cooking duration, season the fries generously and serve with the dip.

Settings

Operating mode:  | AirFry

Temperature: 220 °C

Cooking duration: 25 minutes

Shelf level: 2

AirFry recipes

Sesame tofu sticks

Total time required: 35 minutes

Serves 3

Ingredients

400 g tofu
3 tbsp teriyaki sauce
4 tbsp tahini (sesame paste)
2 tbsp vegetable oil
2 tbsp agave syrup
1 tbsp sesame seeds, white
1 tbsp sesame seeds, black
1 tbsp cornflour
3 tbsp breadcrumbs

Accessories

Kitchen roll
Grilling and roasting insert
Universal tray

Method

Cut the tofu into 1 cm thick slices and press firmly between pieces of kitchen roll. Then cut the tofu slices into sticks 1 cm wide and 3 cm long. Press the sticks between pieces of kitchen roll again in order to remove as much moisture as possible from the tofu. Leave the sticks on the kitchen roll for 15 minutes.

Mix together the teriyaki sauce, tahini, oil and agave syrup. Mix this sauce with the sesame seeds.

Place the tofu sticks in a bowl and add the cornflour. Toss the tofu sticks in the bowl until they are evenly coated with the cornflour. Pre-heat the oven using the indicated settings.

Add the sauce to the bowl containing the tofu sticks and mix everything together. Then sprinkle over the breadcrumbs and mix everything together again. Place the grilling and roasting in-

sert on the universal tray and place the tofu sticks on the insert so they are not touching each other. Place the tofu sticks in the pre-heated oven and bake.

Settings: pre-heating

Operating mode:  | Booster
Temperature: 190 °C

Settings: baking the sesame tofu sticks

Operating mode:  | AirFry
Temperature: 190 °C
Cooking duration: 7 minutes
Shelf level: 2

Baked potatoes with cheese, spring onions and bacon

Total time required: 70 minutes

Serves 4

For the potatoes

4 baking potatoes (200 g each)
2 tbsp oil
2 tsp salt

For the dip

150 ml soured cream
30 g chives | finely chopped
1 pinch of salt
1 pinch of pepper
1 pinch of ground nutmeg

For the topping

100 g bacon | diced
½ bunch of spring onions | sliced into thin rings
200 g cheese, mature (e.g. Gruyère, Sbrinz and Emmental) | grated

Accessories

Grilling and roasting insert
Universal tray

Method

Wash the potatoes thoroughly and dry them. Prick the potatoes all over with a fork. Then rub with a generous amount of oil and salt. Place the grilling and roasting insert on the universal tray, place the potatoes on top and bake according to cooking stages 1 and 2.

In the meantime, mix the soured cream with the chives to make the dip. Season with salt, pepper and nutmeg to taste.

For the topping, fry the bacon on medium heat until crisp. Get the spring onions ready.

After cooking stage 2, take the potatoes out of the oven. Carefully cut them in half and place them back on the grilling and roasting insert with the cut side facing up. Sprinkle with cheese and bake until golden brown using the settings indicated for cooking stage 3.

Serve the baked potatoes with the spring onions, bacon and dip.

Settings

Cooking stage 1

Operating mode:  | AirFry

Temperature: 200 °C

Cooking duration: 20 minutes

Shelf level: 2

Cooking stage 2

Operating mode:  | AirFry

Temperature: 180 °C

Cooking duration: 30 minutes

Cooking stage 3

Operating mode: 

Temperature: 180 °C

Cooking duration: 10 minutes

Shelf level: 3

AirFry recipes

Baked potatoes with feta, tzatziki and Greek salad

Total time required: 70 minutes

Serves 4

For the potatoes

4 baking potatoes (200 g each)
2 tbsp oil
2 tsp salt

For the tzatziki

½ cucumber
¼ tsp salt
200 g Greek yoghurt
1 clove of garlic | finely chopped
¼ tsp salt
1 pinch of pepper
½ lemon | juice and zest

For the salad

½ cucumber | diced
3 tomatoes | diced
1 yellow pepper | finely diced
1 red pepper | finely diced
1 red onion | finely diced

For the dressing

½ tsp salt
1 pinch of pepper
½ lemon | juice only
1 tsp dill | chopped

For the topping

200 g feta | crumbled

Accessories

Grilling and roasting insert
Universal tray

Method

Wash the potatoes thoroughly and dry them. Prick the potatoes all over with a fork. Then rub with a generous amount of oil and salt. Place the grilling and roasting insert on the universal tray, place the potatoes on top and bake according to cooking stages 1 and 2.

In the meantime, grate and salt the cucumber for the tzatziki and leave for 10 minutes.

Squeeze the liquid out of the cucumber. Mix the squeezed cucumber with the yoghurt and garlic. Then add salt, pepper, lemon juice and lemon zest to taste.

For the salad, put the vegetables in a bowl.

For the dressing, mix together the salt, pepper, dill, lemon juice and olive oil. Pour the dressing over the salad. Set aside until ready to serve.

After cooking stage 2, take the potatoes out of the oven. Carefully cut them in half and place them back on the grilling and roasting insert with the cut side facing up. Sprinkle with feta and bake until golden brown using the settings indicated for cooking stage 3.

Serve the baked potatoes with the tzatziki and salad.

Settings

Cooking stage 1
Operating mode:  | AirFry
Temperature: 200 °C
Cooking duration: 20 minutes
Shelf level: 2

Cooking stage 2
Operating mode:  | AirFry
Temperature: 180 °C
Cooking duration: 30 minutes

Cooking stage 3
Operating mode:  | AirFry
Temperature: 180 °C
Cooking duration: 10 minutes
Shelf level: 3

Courgette fries with blue cheese dip and chilli sauce

Total time required: 55 minutes

Serves 2

For the vegetables

2 courgettes
3 eggs, medium
50 ml milk, whole
2 tbsp sunflower oil
200 g panko breadcrumbs
2 tsp salt
½ tsp garlic powder
½ tsp onion, granulated
¼ tsp black pepper | coarsely ground
100 g mature Alpine cheese | grated
100 g plain white flour

For the blue cheese dip

150 g blue cheese, strong
2 tbsp mayonnaise
80 g yoghurt, 3.5 % fat
1 pinch of salt
1 pinch of pepper
¼ tsp paprika, smoked

To serve

1 tsp sriracha sauce

Accessories

Grilling and roasting insert
Hand blender
Universal tray

Method

Halve the courgettes crosswise and cut each half into 8 equal pieces.

Whisk the eggs, milk and oil together in a shallow bowl.

In another bowl, mix together the panko breadcrumbs, spices and Alpine cheese. Place the flour in a third bowl. Now coat the courgette pieces with the breadcrumbs.

To do this, first turn the courgette pieces in the flour, then in the egg mixture. Then coat them evenly with the panko mixture. For a particularly even and crispy coating, turn the pieces in the egg and panko mixtures a second time.

Place the grilling and roasting insert on the universal tray, place the courgette pieces on top and bake according to the settings. Turn after 15 minutes and bake for a further 10 minutes.

To make the dip, blend all the ingredients for around 1 minute. Blending for too long may cause the dip to separate. Chill the dip until ready to serve.

Serve the courgette fries with the dip and drizzle with the sriracha sauce.

Settings

Operating mode:  | AirFry

Temperature: 205 °C

Cooking duration: 25 minutes

Shelf level: 2

AirFry recipes

Corn grilled with hoisin glaze and coleslaw

Total time required: 40 minutes

Serves 4

For the dressing

100 g mayonnaise
1 tbsp cider vinegar
1 tbsp mustard
½ tsp caster sugar
1 pinch of salt
1 pinch of pepper

For the salad

¼ white cabbage | cut into thin strips
¼ red cabbage | thinly sliced
2 carrots | thinly sliced

For the corn with hoisin glaze

4 cobs, pre-cooked | quartered
50 g hoisin sauce
50 g mayonnaise

To serve

2 tbsp sesame seeds, white

Accessories

Grilling and roasting insert
Universal tray

Method

For the dressing, mix together the mayonnaise, cider vinegar, mustard and sugar. Season with salt and pepper to taste. For the salad, mix together the white cabbage, red cabbage and carrots in a bowl. Pour the dressing over the salad and fold in. Set the salad aside until ready to serve.

Place the grilling and roasting insert on the universal tray, place the corn cobs on top and cook according to the settings.

For the glaze, mix together the hoisin sauce and mayonnaise. After 15 minutes, brush the corn with the hoisin mixture and cook for a further 10 minutes.

Sprinkle the cobs with the sesame seeds to taste. Serve with coleslaw.

Setting

Operating mode:  | AirFry
Temperature: 210 °C
Cooking duration: 25 minutes
Shelf level: 2

Chicken nuggets with coconut sesame coating

Total time required: 25 minutes

Serves 2

For the coating

100 g breadcrumbs
50 g sesame seeds, white
50 g desiccated coconut
2 tsp salt
1 tsp paprika, smoked
1 tsp garlic powder
1 tsp onion powder
100 g plain white flour
3 eggs, medium
1 tbsp vegetable oil
3 tbsp milk, whole

For the chicken nuggets

2 chicken breast fillets, ready to cook |
in finger-width strips

To serve

2 tsp sweet chilli sauce

Accessories

Gourmet baking and AirFry tray, perforated

Method

For the coating, mix together the breadcrumbs, sesame seeds, desiccated coconut, salt, paprika, onion powder and garlic powder in a bowl. Place the flour in another bowl. Whisk the eggs, oil and milk together in a third bowl.

Now coat the chicken strips with the breadcrumbs.

To do this, first turn the chicken strips in the flour, then in the egg/oil mixture. Then coat them with the breadcrumb/spice mixture. Place the coated nuggets directly on the Gourmet baking and AirFry tray and cook according to the settings. Turn after 10 minutes.

Serve the cooked chicken nuggets with the sweet chilli sauce.

Setting

Operating mode:  | AirFry

Temperature: 210 °C

Cooking duration: 15 minutes

Shelf level: 2

AirFry recipes

Cod with crust

Total time required: 70 minutes

Serves 4

For the cod with crust

60 g butter | softened
1 tbsp mustard
50 g tomatoes, sundried, in oil
½ bunch of parsley, flat leaf
½ bunch of chives
1 tbsp lemon thyme
60 g panko breadcrumbs
4 cod fillets (150 g each), ready to cook
4 pinches of salt

For the pepper and potato salad

2 peppers, red | roughly chopped
2 peppers, yellow | roughly chopped
200 g potatoes, waxy | cut into thin wedges
1 onion, red | cut into thin wedges
1 clove of garlic | crushed
1 tbsp olive oil
½ tsp salt
¼ tsp paprika, smoked

For the dressing

30 ml balsamic vinegar
1 tbsp mustard
2 tbsp honey
1 pinch of salt
1 pinch of pepper
60 ml olive oil

To serve

125 g rocket | washed

Accessories

Hand blender
Grilling and roasting insert
Universal tray
Screw-top jar

Method

For the crust, blend together the butter, mustard, sundried tomatoes, parsley, lemon thyme and chives. Fold in the panko breadcrumbs and season with salt to taste. Pat the fish fillets dry and salt them. Shape the crust into 4 pieces corresponding to the size of the fish fillets and place them on the fish. Place the grilling and roasting insert on the universal tray. Place the fish on the left side of the grilling and roasting insert.

For the vegetables, place the two types of pepper, potato wedges, onions and garlic in a bowl, drizzle with oil and season. Then spread out the vegetables on the right side of the grilling and roasting insert. Place the tray in the oven and roast the cod and vegetables using the indicated settings.

For the dressing, mix together the balsamic vinegar, mustard, honey, salt and pepper in a screw-top jar. Add the olive oil, seal the jar and shake vigorously for approx. 1 minute.

Before serving, mix the rocket with the warm vegetables and marinate the salad with the dressing. Serve the fish on the salad.

Settings

Operating mode:  | AirFry
Temperature: 210 °C
Cooking duration: 20 minutes
Shelf level: 2

Bananas with pistachio and honey topping

Total time required: 25 minutes

Serves 4

Ingredients

50 g pistachio nuts | shelled

1 pinch of salt

4 bananas

2 tbsp wild honey

Settings

Operating mode:  | AirFry

Temperature: 200 °C

Cooking duration: 8 minutes

Shelf level: 2

Accessories

Frying pan

Grilling and roasting insert

Universal tray

Method

Roughly chop the pistachios and toast lightly in the pan. Add the salt. Remove the pan from the hob and leave to cool slightly.

Place the grilling and roasting insert on the universal tray. Cut the bananas in half lengthways (still in the skin) and place them on the grilling and roasting insert with the cut side facing up. Mix the honey with the pistachios. Spread the pistachio/honey mixture over the banana halves. Place the bananas in the oven and cook.

AirFry recipes

Pasteis de nata

Total time required: 60 minutes

Serves 12

For the pasteis

2 eggs, medium
37 g vanilla custard powder for cooking
200 ml milk, whole
250 ml double cream
70 g caster sugar
1 pinch of salt
Approx. 275 g puff pastry

For dusting

1 tsp icing sugar
1 pinch of cinnamon

For the tin

1 tsp butter

Accessories

Sieve
Muffin tin for 12 muffins
Whisk
Rolling pin
Baking and roasting rack

Method

Whisk the eggs and press through a sieve. Mix 5 tbsp of the milk with the custard powder and the eggs until smooth. Bring the rest of the milk, the cream, sugar and salt to a boil while stirring. Remove the pan from the hob and add the custard mixture while stirring. Bring everything to the boil while stirring. Pour the mixture into a bowl, cover and chill.

Grease the muffin tin. Roll out the puff pastry and cut out 12 circles with a diameter of 10 cm. Place the circles in the recesses of the muffin tin and press in

firmly so there are no bubbles in the base and the dough does not protrude out of the recesses.

Divide the custard mixture between the 12 recesses. Place the muffin tin in the oven on the baking and roasting rack. Bake the pasteis until brown spots appear on the custard mixture.

Mix together the icing sugar and cinnamon and sprinkle it over the pasteis while still warm. Remove the pasteis from the tin while still warm and leave to cool on the baking and roasting rack.

Settings

Operating mode:  | AirFry
Temperature: 200 °C
Cooking duration: 18 minutes
Shelf level: 2

Vegan pasteis de nata

Total time required: 60 minutes

Serves 12

For the pasteis

500 ml oat milk

40 g potato starch

40 g caster sugar

1 vanilla pod

Approx. 275 g puff pastry

¼ tsp cinnamon, ground

To serve

¼ tsp cinnamon, ground

Accessories

Muffin tin for 12 muffins

Whisk

Pan

Rolling pin

Baking and roasting rack

Method

Mix 4 tbsps of oat milk with the potato starch and set aside. Bring the rest of the oat milk to the boil with the sugar, vanilla seeds and vanilla pod. Stir the oat milk that was mixed with the potato starch into the boiling oat milk. Bring the thickened mixture to the boil for approx. 1 minute while stirring, then pour into a bowl, cover and leave to cool.

Roll the puff pastry into a tight roll, cut into 12 pieces and chill. Take out one pastry piece at a time and roll out into a circle with a diameter of approx. 10 cm. Place the circle into a recess of the muffin tin and press in firmly so there are no bubbles in the base and the dough does not protrude out of the recess. Repeat the process with the remaining 11 pastry pieces.

Fill the recesses max. $\frac{3}{4}$ with the custard mixture. Place the muffin tin in the oven on the baking and roasting rack and bake the pasteis immediately using the indicated settings. To achieve the typical flavour, the pasteis de nata should have a few very dark spots on top. Dust with cinnamon before serving.

Settings

Cooking stage 1

Operating mode:  | AirFry

Temperature: 210 °C

Cooking duration: 25 minutes

Shelf level: 2

Cooking stage 2

Operating mode:  | AirFry

Temperature: 245 °C

Cooking duration: 10 minutes

Shelf level: 2

Technical data

Frequency range of the WiFi module	2.4000–2.4835 GHz
Maximum transmission power of the WiFi module	< 100 mW

EU Conformity declaration

Miele hereby declares that this oven complies with Directive 2014/53/EU.

The complete text of the EU declaration of conformity is available from one of the following internet addresses:

- Products, Download from www.miele.ie
- For service, information, operating instructions etc: go to <https://miele.co.uk/> manuals and enter the name of the product or the serial number

UK Conformity declaration

Miele hereby declares that this oven complies with UK Radio Equipment Regulations 2017, as amended.

The complete text of the UK declaration of conformity is available from one of the following internet addresses:

- Products, Download from www.miele.co.uk
- For service, information, operating instructions etc: go to <https://miele.co.uk/> manuals and enter the name of the product or the serial number

This **Statement of Compliance** confirms this Miele product fully complies with the **Product Security and Telecommunications Infrastructure (Security Requirements for Relevant Connectable Products) Regulations 2023**.

- 1) Household Appliance – *Oven for building-in; B60D1-01W, BP60D1-01W, B60D2-01W, BP60D2-01W*
- 2) Manufactured by: Miele & Cie KG,
Carl Miele Street 29, 33332 Gutersloh Germany
Imported by and contact point: Miele Company Ltd, Fairacres, Marcham Road, Abingdon, Oxon, OX14 ITW Great Britain
- 3) The defined support period at the time of first supply is 10 years
- 4) To report vulnerabilities and cybersecurity issues please contact: psirt@miele.com
- 5) Signature 
Name: **Paul Wright**
Company Position: **Head of Technical Management**
Date of signature: **19th March 2024**
Place of signature: **Abingdon, Oxfordshire**

Copyrights and licences for the communication module

For the purpose of operating and controlling the communication module, Miele uses proprietary or third-party software that is not covered by open source licensing terms. These items of software/software components are protected by copyright. The copyrights held by Miele and third parties must be respected.

Furthermore, this communication module contains software components which are distributed under open source licence conditions. The open source components contained in the appliance along with the corresponding copyright notices, copies of the licensing terms valid at the time, and any further information can be accessed locally via IP using a web browser (*http://<IP address>/Licenses*). The liability and warranty arrangements for the open source licences displayed in this location only apply in relation to the respective rights holders.

United Kingdom

Miele Co. Ltd., Fairacres, Marcham Road, Abingdon, Oxon, OX14 1TW
Tel: 0330 160 6600, Internet: www.miele.co.uk, E-mail: info@miele.co.uk

Australia

Miele Australia Pty. Ltd.
ACN 005 635 398
ABN 96 005 635 398
Level 4, 141 Camberwell Road
Hawthorn East, VIC 3123
Tel: 1300 464 353
E-mail: info@miele.com.au
Internet: www.miele.com.au

China Mainland

Miele Electrical Appliances Co., Ltd.
1-3 Floor, No. 82 Shi Men Yi Road
Jing' an District
200040 Shanghai, PRC
Tel: +86 21 6157 3500
Fax: +86 21 6157 3511
E-mail: info@miele.cn
Internet: www.miele.cn

Hong Kong, China

Miele (Hong Kong) Ltd.
41/F - 4101, Manhattan Place
23 Wang Tai Road
Kowloon Bay, Hong Kong
Tel: (852) 2610 1025
Fax: (852) 3579 1404
E-mail:
customerservices@miele.com.hk
Website: www.miele.hk

India

Miele India Pvt. Ltd.
1st Floor, Copia Corporate Suites,
Commercial Plot 9, Mathura Road,
Jasola, New Delhi - 110025
E-mail: customercare@miele.in
Website: www.miele.in

Ireland

Miele Ireland Ltd.
2024 Bianconi Avenue
Citywest Business Campus
Dublin 24
Tel: (01) 461 07 10
Fax: (01) 461 07 97
E-mail: info@miele.ie
Internet: www.miele.ie

Malaysia

Miele Sdn Bhd
Suite 12-2, Level 12
Menara Sapura Kencana
Petroleum
Solaris Dutamas No. 1
Jalan Dutamas 1
50480 Kuala Lumpur, Malaysia
Phone: +603-6209-0288
Fax: +603-6205-3768

New Zealand

Miele New Zealand Limited
IRD 98 463 631
8 College Hill
Freemans Bay, Auckland 1011
Tel: 0800 464 353
E-mail: customercare@miele.co.nz
Internet: www.miele.co.nz

Singapore

Miele Pte. Ltd.
29 Media Circle
#11-04 ALICE@Mediapolis
Singapore 138565
Tel: +65 6735 1191
Fax: +65 6735 1161
E-mail: info@miele.com.sg
Internet: www.miele.sg

South Africa

Miele (Pty) Ltd.
63 Peter Place, Bryanston 2194
P.O. Box 69434, Bryanston 2021
Tel: (011) 875 9000
Fax: (011) 875 9035
E-mail: info@miele.co.za
Internet: www.miele.co.za

Thailand

Miele Appliances Ltd.
BHIRAJ TOWER at EmQuartier
43rd Floor Unit 4301-4303
689 Sukhumvit Road
North Klongton Sub-District
Vadhana District
Bangkok 10110, Thailand

United Arab Emirates

Miele Appliances Ltd.
Showroom 1, Eiffel 1 Building
Sheikh Zayed Road, Umm Al Sheif
P.O. Box 114782 - Dubai
Tel. +971 4 3044 999
Fax. +971 4 3418 852
800-MIELE (64353)
E-mail: info@miele.ae
Website: www.miele.ae

Manufacturer: Miele & Cie. KG, Carl-Miele-Straße 29, 33332 Gütersloh, Germany

H 2465 B, H 2761 B, H 2766 B, H 2851 B